

KHX0752
INDOOR UNIT

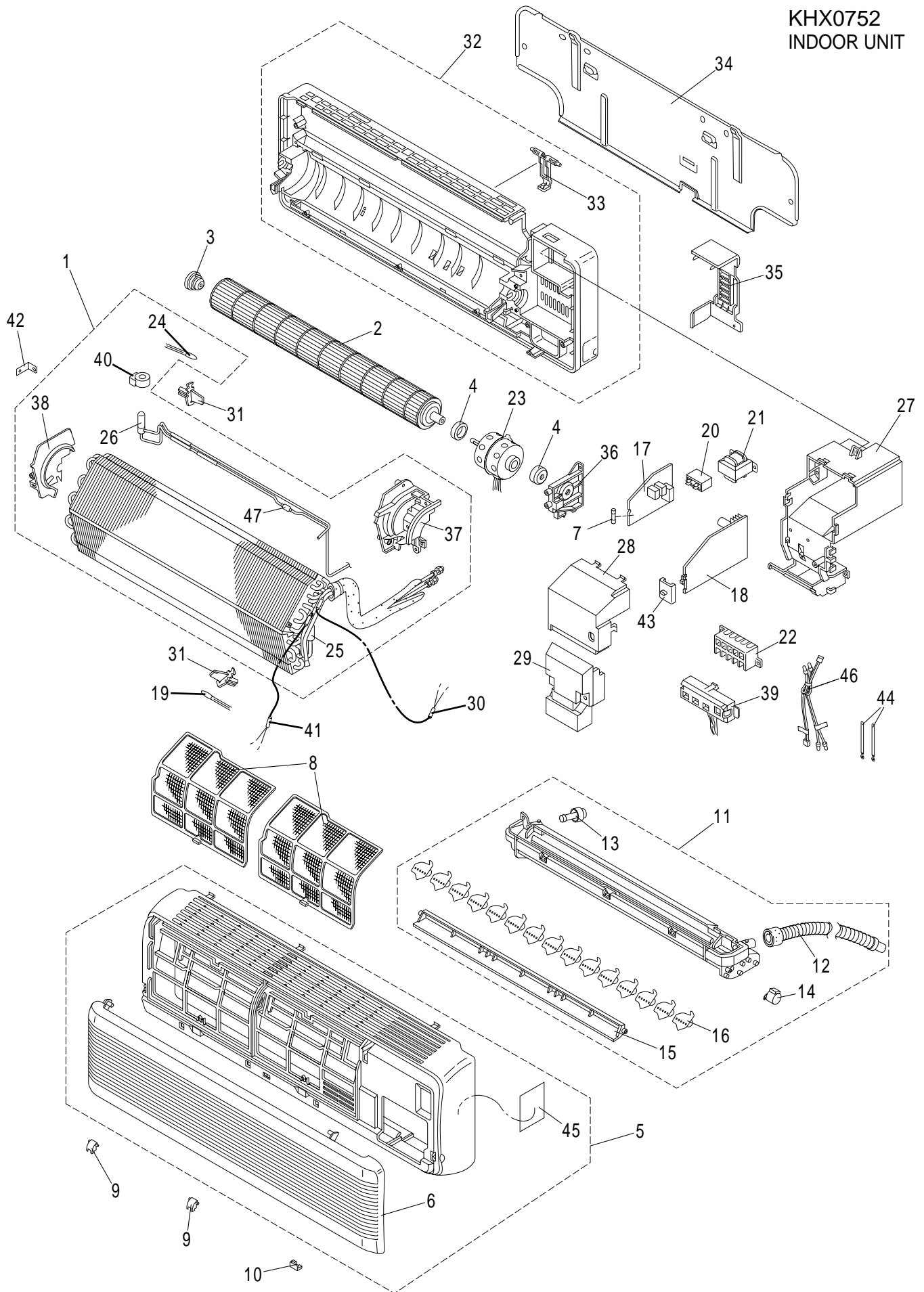

ATTENTION !

To ensure correct parts supply, please let us know followings,
when you make service parts order:

1.Part No. 2.Description 3.Q'ty 4.Volts-Hz-Ph 5.Product Model No.

KHX0752
INDOOR UNIT

KeyNo.	Part No.	Description	Q'ty	Reference No.
* 1	623 201 0978	Heat Exch Ass'y	1	854-0-4124-62600
* 2	623 184 7148	Cross-Flow Fan Ass'y	1	852-0-2509-28700
* 3	623 094 4466	Bearing Housing Ass'y	1	852-0-2510-12800
4	623 118 2515	Cushion Rubber	2	852-2-2511-15801
5	623 201 0961	Air Intake Grille Ass'y	1	854-0-1110-209H1
6	623 201 0954	Ornamental Sash Ass'y	1	854-0-1301-17600
* 7	623 179 0444	Fuse BET5A	1	1FJ-4-S3A0-00500
8	623 154 7413	Air Filter Ass'y	2	852-0-2307-27311
9	623 155 6101	Cap	2	852-2-2350-17411
10	623 155 6095	Cap	1	852-2-2350-17311
11	623 201 0985	Blade Louver Ass'y	1	854-0-1505-40000
12	623 151 2848	Drain Hose Ass'y	1	852-0-1303-23600
13	623 143 3082	Cap, Drain Pan	1	852-2-2348-11401
* 14	623 188 6031	Step Motor MP24Z8-12V	1	1FA-4-M3A0-01600
15	623 154 7475	Flap	1	852-2-1523-22411
16	623 154 7468	Blade	15	852-2-1519-27411
* 17	623 179 3940	P.C.B. Ass'y POW-KR74GXH56	1	8FA-0-5178-19000
* 18	623 188 6024	Circuit Board Ass'y CB-KR74GXH56A	1	854-9-9536-05232
* 19	623 172 5774	Thermistor Ass'y(TA) KTEC-35-S98-2	1	854-0-5259-67900
* 20	623 001 0864	Fixed Capacitor CMPS UP44B105JMF	1	4-2239-51127
* 21	623 201 1012	Transformer Ass'y ATR-IIK244E-T-R	1	8FA-0-5263-06300
* 22	623 201 1005	Terminal Base HP-T3054-1-5P	1	1FA-4-J3A0-29300
* 23	623 201 0992	Fan Motor UF4Q-31G6P	1	1FA-4-M1A0-18806
* 24	623 179 1885	Thermistor Ass'y(BL) KTEC-35-S85	1	8FA-0-5259-06200
25	623 176 0492	Strainer Ass'y	1	854-0-4522-28500
* 26	623 175 2336	Solenoid Control Valve UKV-25D32	1	854-2-4548-20300
27	623 154 7567	Elec.Component Box	1	852-2-5307-58611
28	623 154 7550	Cover,Elec.Component Box	1	852-2-5315-36211
29	623 201 1036	Cover,Elec.Component Box	1	854-0-5304-68700
* 30	623 179 1892	Thermistor Ass'y(E3) PBC-41E-S42-1	1	8FA-0-5259-06400
31	623 172 5507	Mounting Thermostat	2	852-2-5303-25101
32	623 201 1029	Frame Ass'y	1	854-0-2206-34900
33	623 154 7604	Mounting, Tube	1	852-2-2362-22411
34	623 153 1498	Rear Panel	1	852-2-2230-16400
35	623 154 7598	Mounting, Tube	1	852-2-2362-23411
36	623 154 7581	Mounting Plate, Fan Motor	1	852-2-2520-23611
37	623 155 6125	Mounting Plate	1	852-2-2309-80711
38	623 201 1043	Cover Ass'y	1	854-0-2325-48900
* 39	623 172 5743	Indicator Lamp Ass'y IND-KRP50A	1	854-0-5161-01900
* 40	623 175 3968	Magnetic Coil(PMV) UKV-U023E	1	1FA-4-L8A0-27700

NOTE: Metal and plastic parts will be supplied basically
with necessary heat insulation pads or packing.
Each key number with an asterisk (*) means the
recommended service parts.

ATTENTION !

To ensure correct parts supply, please let us know followings,
when you make service parts order:

1.Part No. 2.Description 3.Q'ty 4.Volts-Hz-Ph 5.Product Model No.

KHX0752
INDOOR UNIT

KeyNo.	Part No.	Description	Q'ty	Reference No.
* 41	623 172 5873	Thermistor Ass'y(E1) PBC-41E-AS7-2	1	854-0-5259-68000
42	623 179 1847	Mounting Plate	1	854-2-2361-95500
43	623 151 6853	Knob	1	852-2-5323-10911
44	628 033 3456	Fixture Cord	2	731-2-5323-12200
45	623 201 1067	Elec. Wiring Diagram	1	8FA-2-5250-06200
* 46	623 179 3971	Wire Ass'y	1	8FA-0-5285-15700
47	623 043 4202	Strainer Ass'y	1	852-0-4506-15900
	623 201 1050	Operation Manual	1	854-6-4189-83700

NOTE: Metal and plastic parts will be supplied basically with necessary heat insulation pads or packing.
Each key number with an asterisk (*) means the recommended service parts.

For Parts or Service Assistance please contact your local Sanyo HVAC Contractor or Distributor

United States: SCS, HVAC Solutions
Web: www.SanyoHVAC.com
Parts: hvac.parts@sss.sanyo.com
Service: hvac.service@sss.sanyo.com

Canada: Sanyo Canada Inc.
Web: www.SanyoHVAC.com
Parts/Service: hvac@sci.sanyo.com

5/09 Printed in Japan