



Vacuum Packaging Machine
Model VP-NL-0050-LS
Item 45310
Instruction Manual



Revised - 02/28/2023

Toll Free: 1-800-465-0234
Fax: 905-607-0234
Email: service@omcan.com
www.omcan.com



Table of Contents

Model VP-NL-0050-LS

Section	Page
General Information -----	3 - 4
Safety and Warranty -----	4 - 5
Technical Specifications -----	6
Installation -----	6 - 7
Operation -----	7 - 11
Maintenance -----	11 - 15
Troubleshooting -----	15 - 16
Parts Breakdown -----	17 - 27
Electrical Schematics -----	28
Notes -----	29 - 30
Warranty Registration -----	31



General Information

Omcan Manufacturing and Distributing Company Inc., Food Machinery of America, Inc. dba Omcan and Omcan Inc. are not responsible for any harm or injury caused due to any person's improper or negligent use of this equipment. The product shall only be operated by someone over the age of 18, of sound mind, and not under the influence of any drugs or alcohol, who has been trained in the correct operation of this machine, and is wearing authorized, proper safety clothing. Any modification to the machine voids any warranty, and may cause harm to individuals using the machine or in the vicinity of the machine while in operation.

CHECK PACKAGE UPON ARRIVAL

Upon receipt of an Omcan shipment please inspect for external damage. If no damage is evident on the external packaging, open carton to ensure all ordered items are within the box, and there is no concealed damage to the machine. If the package has suffered rough handling, bumps or damage (visible or concealed), please note it on the bill of lading before accepting the delivery and contact Omcan within 24 hours, so we may initiate a claim with the carrier. A detailed report on the extent of the damage caused to the machine must be filled out within three days, from the delivery date shown in the shipping documents. Omcan has no recourse for damaged products that were shipped collect or third party.

Before operating any equipment, always read and familiarize yourself with all operation and safety instructions.

Omcan would like to thank you for purchasing this machine. It's of the utmost importance to save these instructions for future reference. Also save the original box and packaging for shipping the equipment if servicing or returning of the machine is required.

Omcan Fabrication et distribution Compañie Limité et Food Machinery d'Amérique, dba Omcan et Omcan Inc. ne sont pas responsables de tout dommage ou blessure causé du fait que toute personne ait utilisé cet équipement de façon irrégulière. Le produit ne doit être exploité que par quelqu'un de plus de 18 ans, saine d'esprit, et pas sous l'influence d'une drogue ou d'alcool, qui a été formé pour utiliser cette machine correctement, et est vêtu de vêtements de sécurité approprié. Toute modification de la machine annule toute garantie, et peut causer un préjudice à des personnes utilisant la machine ou des personnes à proximité de la machine pendant son fonctionnement.

VÉRIFIEZ LE COLIS DÈS RÉCEPTION

Dès réception d'une expédition d'Omcan veuillez inspecter pour dommages externes. Si aucun dommage n'est visible sur l'emballage externe, ouvrez le carton afin de s'assurer que tous les éléments commandés sont dans la boîte, et il n'y a aucun dommage dissimulé à la machine. Si le colis n'a subi aucune mauvaises manipulations, de bosses ou de dommages (visible ou cachée), notez-le sur le bond de livraison avant d'accepter la livraison et contactez Omcan dans les 24 heures qui suivent, pour que nous puissions engager une réclamation auprès du transporteur. Un rapport détaillé sur l'étendue des dommages causés à la machine doit être rempli dans un délai de trois jours, à compter de la date de livraison indiquée dans les documents d'expédition. Omcan n'a aucun droit de recours pour les produits endommagés qui ont été expédiés ou cueilli par un tiers transporteur.

General Information

Avant d'utiliser n'importe quel équipement, toujours lire et vous familiariser avec toutes les opérations et les consignes de sécurité.

Omcan voudrais vous remercier d'avoir choisi cette machine. Il est primordial de conserver ces instructions pour une référence ultérieure. Également conservez la boîte originale et l'emballage pour l'expédition de l'équipement si l'entretien ou le retour de la machine est nécessaire.

Omcan Empresa De Fabricacion Y Distribucion Inc. Y Maquinaria De Alimentos De America, Inc. dba Omcan y Omcan Inc. no son responsables de ningun daño o perjuicio causado por cualquier persona inadecuada o el uso descuidado de este equipo. El producto solo podra ser operado por una persona mayor de 18 años, en su sano juicio y no bajo alguna influencia de droga o alcohol, y que este ha sido entrenado en el correcto funcionamiento de esta máquina, y ésta usando ropa apropiada y autorizada. Cualquier modificación a la máquina **anúla** la garantía y puede causar daños a las personas usando la máquina mientras esta en el funcionamiento.

REVISE EL PAQUETE A SU LLEGADA

Tras la recepcion de un envío Omcan favor inspeccionar daños externos. Si no hay daños evidentes en el empaque exterior, Habra el carton para asegurarse que todos los articulos solicitados estén dentro de la caja y no encuentre daños ocultos en la máquina. Si el paquete ha sufrido un manejo de poco cuidado, golpes o daños (visible o oculto) por favor anote en la factura antes de aceptar la entrega y contacte Omcan dentro de las 24 horas, de modo que podamos iniciar una reclamación con la compañía. Un informe detallado sobre los daños causados a la máquina debe ser llenado en el plazo de tres días, desde la fecha de entrega que se muestra en los documentos de envío. Omcan no tiene ningun recurso por productos dañados que se enviaron a recoger por terceros.

Antes de utilizar cualquier equipo, siempre lea y familiarizarse con todas las instrucciones de funcionamiento y seguridad.

Omcan le gustaría darle las gracias por la compra de esta máquina. Es de la mayor importancia para salvar estas instrucciones para futuras consultas. Además, guarda la caja original y el embalaje para el envío del equipo si servicio técnico o devolución de la máquina que se requiere.

Safety and Warranty

The manufacturer of this equipment accepts no liability whatsoever for damage or injury caused by failing to adhere to the directions and instructions in this manual, or through carelessness during the installation, use, maintenance and repair of the machine identified on the front of this document, or any of its accompanying options or components.

The owner of the machine is fully responsible at all times for the adherence to the locally applicable safety regulations and guidelines. Obey all safety instructions and guidelines as provided in this manual.



Safety and Warranty

INTENDED USE OF THE MACHINE

The machine is designed for vacuum packaging of food or other products for 8 hours a day, 5 days a week. Any other or extended use is not in accordance with this purpose and the manufacturer accepts no liability for any resulting damage or injury. Only use this machine while in perfect technical condition in accordance with the above mentioned purpose.

Safety Measures

The machine is equipped with the following standard safety devices:

- Short-circuit and overload safety.
- Pump fan guards.

All safety devices must be correctly installed and may only be removed to accommodate maintenance and repair activities by trained and authorized service personnel. The machine may never be operated while safety measures are incomplete, deactivated or absent. The safety devices may never be by-passed.

RESIDENTIAL USERS: Vendor assumes no liability for parts or labor coverage for component failure or other damages resulting from installation in non-commercial or residential applications. The right is reserved to deny shipment for residential usage; if this occurs, you will be notified as soon as possible.

1 YEAR PARTS AND LABOR WARRANTY

Within the warranty period, contact Omcan Inc. at 1-800-465-0234 to schedule an Omcan authorized service technician to repair the equipment locally.

Unauthorized maintenance will void the warranty. Warranty covers electrical and part failures, not improper use.

Please see <https://omcan.com/disclaimer> for complete info.

WARNING:

The packaging components are classified as normal solid urban waste and can therefore be disposed of without difficulty.

In any case, for suitable recycling, we suggest disposing of the products separately (differentiated waste) according to the current norms.

DO NOT DISCARD ANY PACKAGING MATERIALS IN THE ENVIRONMENT!

Technical Specifications

Model	VP-NL-0050-LS
Seal	Double
Seal Length	29.3" 31.7" 32.3" 745mm 805mm 820mm
Description	Stainless Steel Cover - Flat Working Surface
Electrical	220V / 50Hz / 3
Digital Time Control	10 Programs
Pump Capacity	63 m3/h
Dimensions	37" x 34.2" x 44.9" / 940 x 870 x 1140mm
Weight	679 lbs. / 308 kgs.
Item Number	45310

Installation

GENERAL

- Level the machine on a flat firm surface.
- Position the machine in such a manner that the pump is unobstructed and properly ventilated.
- Engage the locks on the wheels, if so equipped.
- Check the oil level in the pump; add oil if necessary.

Never operate the machine when the oil level is low. It is recommended to change the oil at least every 2 months.

TURNING ON MACHINE

- If so equipped, like some mobile and double-chamber models, turn on the main power switch on the back of the machine.
- Push the on/off button on the control panel of the machine.

GAS CONNECTION FOR MAP APPLICATIONS (MODIFIED ATMOSPHERIC PACKAGING)

- Connect the gas supply line to the inlet on the back of the machine.
- Maximum pressure: 1 bar.
- Anchor the gas cylinders securely to prevent them from falling over.
- Make sure that the work area is well-ventilated.
- To assure that you use the appropriate gas for your application, consult your dealer or gas supplier.
- Assure a good connection and use high-quality materials.

Installation

COMPRESSED AIR CONNECTION FOR ADDITIONAL SEALING PRESSURE







- Additional sealing pressure is usually recommended for MAP applications only.
- The M40-M80 models with the option Gas/MAP are standard equipped with a compressed air inlet.
- Consult your dealer for installation details.
- Maximum pressure: 1 bar.
- Assure a good connection and use high-quality connector.

Operation













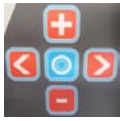





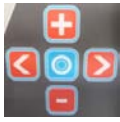



DIGITAL CONTROL WITH LCD DISPLAY







Some Henkovac vacuum machines have a control system with just one Program (P1). Other machines have an optional expanded control system, which can accommodate up to 9 custom programs (P1-9).

OPERATING THE MACHINE WITH TEN-PROGRAM CONTROL SYSTEM

	<p>On: Turns the machine on:</p> <ul style="list-style-type: none"> • The machine will start up in the most-recently used program. • The pump of a machine with a transparent cover will start when the cover is closed. <p>Off: Turns the machine off:</p> <ul style="list-style-type: none"> • When pressing the  button once, the  symbol will start blinking and the pump will stop after about 4 seconds. • When pressing the  button a second time, the pump will stop immediately. • Closing the cover will initiate the cool-down phase. • The machine will complete a number of vacuum cycles before turning off automatically.
	<p>Stop-function:</p> <ul style="list-style-type: none"> • Stops the machine at any point in the cycle and aerates the chamber. <p>Reset-function:</p> <ul style="list-style-type: none"> • While programming, resets the program value to its original setting. • Press the menu button  to return to the Home menu. <p>Back function:</p> <ul style="list-style-type: none"> • While reviewing programmed values, returns to the previous selection.
	<p>Stops the active function and initiates the next step in the cycle:</p> <ul style="list-style-type: none"> • While the machine is running, exits the active function and jumps to the next step in the cycle. • While packing sauce or soup, the package may be sealed as soon as product boiling is detected.

Operation

	<p>Menu Button:</p> <ul style="list-style-type: none"> • Toggles between Home menu  and Settings menu . • Save Function: During programming, confirms and saves the entered program values and returns to the Home menu. • Return Function: Returns to the Home menu.
	<p>Review program values:</p> <ul style="list-style-type: none"> •   Cycles through programs P1 to P9, as well as PA and P H₂O. •  Displays the programmed value for each function; the function being reviewed will be blinking. •   Displays the value for the next function. •  Returns to the Home menu.
	<p>Adjust program values and turn functions ON/OFF:</p> <ul style="list-style-type: none"> •   Forward or back; adjusted values are saved right away. •   Increases or decreases function values. •  Turns functions ON/OFF; specific functions, like soft-air, clean cut seal, etc., are turned either on or off. • If the function is turned on, the value may be adjusted by pressing the  and  buttons. •  Resets the original value. •  Saves changes and returns to the Home menu.
	<p>Multi-Functional button: Performs various functions, depending on the active menu:</p> <p>Home menu  :</p> <ul style="list-style-type: none"> • No effect while in the PA program. • For programs P1-9, displays the entered values. <p>Settings menu  :</p> <ul style="list-style-type: none"> • For specific functions, like soft-air, clean cut seal etc., the  button is used to turn the function ON/OFF.
<p>P1 – P9</p>	<p>Programs 1 through 9:</p> <ul style="list-style-type: none"> • Each program may be customized by turning certain functions on or off and by adjusting the function values.
<p>PA AUTOMATIC</p>	<p>PA - Automatic:</p> <ul style="list-style-type: none"> • Program with factory settings for vacuum and sealing functions, which is activated when turning on the machine for the first time.
<p>P H₂O</p>	<p>P H₂O – Program:</p> <ul style="list-style-type: none"> • To be used when packing liquids or semi-liquids, like sauces and soups. • Program jumps to the sealing function as soon as product boiling is detected; this prevents product loss through spillage and evaporation.

	<p>When turning off the machine with the  button, the  symbol will start blinking on the LCD display:</p> <ul style="list-style-type: none"> • The pump will stop after about 4 seconds. • Press the  button for a second time and the pump will stop immediately. • Close the lid; the machine will initiate the cool-down phase and perform a number of vacuum cycles before turning off automatically. • These additional cycles allow any moisture in the oil of the pump to evaporate. This increases the longevity of the machine and minimizes the need for oil changes and pump maintenance.
	<p>Service Symbol:</p> <ul style="list-style-type: none"> • After reaching a certain number of operating hours or packing cycles, the service symbol will briefly appear on the display when turning on the machine. In addition, the display indicates how many hours or cycles remain before an oil change is required. • Except for regularly changing the oil in the pump, the machine requires little other routine maintenance. • After reaching the service limit, the display will indicate the negative number of exceeded operating hours or cycles. • To reset the service interval counters after the oil change: Start machine  and while the display shows the hours or cycles, press and hold the  button to reset.







PROGRAMMING THE MACHINE

TEN-PROGRAM CONTROL SYSTEM

- The Ten-Program control system is standard time-based on the M20, M40-M80, L01-L60.
 - Sensor-based operation is **an** option, which can be installed at a later date.
- The Ten-Program control system provides:
 - 9 customizable programs (P1-P9).
 - Program PA; this is **an** - Automatic Program – Pre-set at the factory at a vacuum time of 30-40 seconds (or 5 mbar for a sensor-based program) and a sealing time of 2 seconds.
- Program P H2O for liquid products.
 - When turning on the machine, the pump will start. After about 15 minutes of inactivity, the pump will stop automatically.







PROGRAMMABLE FUNCTIONS

The following functions may be customized for each program P1-P9:









-  **Vacuum time:** in seconds or mbar (only with sensor).
-  **Sealing time:** in seconds.
-  **Vacuum Plus:** on/off, in seconds.
-  **Gassing:** on/off, in seconds or mbar (only with sensor).
-  **Clean Cut Controlled (CCC) Seal:** on/off, in seconds.
-  **Soft-Air:** on/off, in seconds or mbar (only with sensor).
-  **Multi-cycle:** on/off, in number of cycles.

Operation

REVIEWING FUNCTION VALUES FOR P1-P9





1. Turn the machine on by pushing the  button.
2. The most-recently used program will be indicated.
3. All selected functions for this program are indicated at the bottom of the display.
4. To review the values for these functions, push the  button; use the    button to display each function value.
5. The values cannot be changed; this can only be done in the Settings menu.
6. Push the  button to return to the Home menu.

PROGRAMMING AND ADJUSTING VALUES FOR P1-P9











1. Select the program to be set up or adjusted.
2. Push the menu button to access the Settings menu.
3. All functions for the selected program are indicated at the bottom of the display.
4. Push the    button to select the blinking function to be adjusted.
5. Adjust the value of the selected function with the    button.
6. Press the  button to reset all functions to their original values.
7. Select the next function with the    button.
8. Press the menu button to save the entered values and to return to the Home menu.

TURNING PROGRAM FUNCTIONS ON/OFF



The following functions can be turned ON/OFF for each program P1-P9:

-  **Vacuum Plus:** on/off, in seconds.
-  **Gassing:** on/off, in seconds or in mbar (only with sensor).
-  **Clean Cut Controlled (CCC) Seal:** on/off, in seconds.
-  **Soft-Air:** on/off, in seconds or in mbar (only with sensor).
-  **Multi-cycle:** on/off, in number of cycles.

ADJUSTING ON/OFF FUNCTION VALUES

1. Press the menu button to select the Settings menu.
2. Use the    button to select the blinking function to be adjusted.
3. Press the    button to select the desired value.
4. Press the  button to reset all functions to their original values.
5. Select the next function with the    button.
6. Push the menu button to store all selected values and to return to the Home menu.

TURNING OFF MACHINE

1. Turn the machine off by pressing the  button.
2. The  symbol on the display will start blinking.
3. Push the  button a second time and the pump will stop immediately.
4. If no action is taken the pump turns off after 4 seconds.

Operation

5. Close the cover and the machine will initiate the cool-down phase and perform a number of vacuum cycles while the cover stays closed and the machine will turn off automatically after about 15 minutes.
 - These cycles are necessary to cool down the machine and to allow any moisture in the oil of the pump to evaporate.

Maintenance

GENERAL

Regular maintenance prevents equipment malfunctions and prolongs the life of the machine. In addition, it optimizes sanitary conditions.

- Always have a certified Henkovac dealer carry out repair and maintenance activities.

WARNING

- During maintenance activities, always turn the machine off at the main switch and/or unplug it from the electrical outlet.



ATTENTION

Observe the recommended service intervals. Overdue maintenance may lead to costly repairs and overhauls, and may void the equipment warranty.



- After reaching a programmed number of operating hours or packing cycles, the service symbol  will briefly appear on the display when the machine is started up. In addition, the display will indicate how many hours or cycles remain before an oil change is required.
- After passing the service limit, the display will indicate the negative number of excess operating hours or cycles.

VACUUM PUMP

To protect the vacuum pump, proper maintenance is important. Carry out the following tasks carefully:

- Check the vents and clean as necessary before turning on the machine to assure proper cooling of the pump.
- When the air filter is saturated with oil, an oil mist may be expelled; replacement of the filter is required.
- Use the cool-down/dehumidification feature. When turning off the machine  and closing the cover , the pump continues to run for some time. Any moisture in the oil of the pump will evaporate during this phase. This increases the longevity of the machine and minimizes the need for oil changes and pump maintenance.
- Check the oil level regularly and add as needed.
- Change the oil when the service symbol  appears on the display.

NOTE

To reset the service interval counters after the oil change: Start machine  and while the display shows the hours or cycles, press and hold the  button.

Maintenance

ADDING AND CHANGING THE PUMP OIL

WARNING

The operating temperature of the pump is 70° C / 158° F or higher. Wear gloves when servicing the pump or let it cool off sufficiently to prevent injuries.

ADDING OIL

1. Remove the oil filler cap
2. Add oil up to the maximum-level mark; use oil according to DIN 51506, lubrication oil group VC. When in doubt, consult your dealer.
3. Replace the oil filler cap.
4. After several packing cycles, check the oil level and add as needed.

CHANGING OIL

1. Remove the oil drain plug and drain the oil.
2. Replace the drain plug.
3. Remove the oil filler cap.
4. Add the correct oil up to the maximum-level mark.
5. Replace the oil filler cap.
6. To reset the service interval counters after the oil change: Start machine and while the display shows the hours or cycles, press and hold the  button.

NOTE

Collect the oil to have it processed and recycled according to the locally applicable regulations.

SEAL BEAMS AND COUNTER BEAMS

To achieve a quality seal, it is necessary that the seal beam and counter beam are in good condition.

1. Clean the seal and counter beams daily with a dry cloth.
2. Replace the Teflon tape on the seal beam if damaged and replace the sealing wire if kinked.
3. Replace the silicone rubber seal if it is burned in.

Depending on the type of machine, there are three seal beam versions:

1. Single-seal beam (T2).
2. Stainless steel seal beam.
3. Aluminum seal beam.

SINGLE-SEAL BEAM

REMOVE THE SEALING WIRE AND TEFLON TAPE AS FOLLOWS:

1. Grab the seal beam in the middle and pull it straight up and out of the machine.
2. The beam is held in place by 2 pins; some force may be necessary to loosen the beam.
3. Remove the brown Teflon tape that is applied to the seal beam.
4. Remove the two screws on the underside of the seal beam; this releases the sealing wire.
5. Clean the seal beam thoroughly and remove any glue residue off the Teflon tape.

NOTES

- Check the condition of the tensioning springs at both ends of the seal beam; replace if necessary.
- These springs maintain tension on the sealing wire.
- Using the seal beam without the springs may cause sealing wires to break.

INSTALL THE SEALING WIRE AND TEFLON TAPE AS FOLLOWS:

1. Position the sealing wire across the beam and fasten it on one side with a small bolt.
2. Apply tension on the wire by pulling it with a pair of pliers.
3. Fasten the wire on the opposite end of the beam with the second bolt and cut the wire to length; the ends of the sealing wire must be long enough to make electrical contact with the pins in the vacuum chamber.
4. Apply the Teflon tape smooth and tight over the seal beam; make sure that the beam is clean and free of grease.
5. Re-install the beam in the vacuum chamber; check to make sure that the ends of the sealing wire make contact with the steel pins.

ALUMINUM/STAINLESS STEEL SEAL BEAM

REMOVE THE SEALING AND CUTTING WIRES AS FOLLOWS:

1. Remove the old wires by pulling them loose from the seal beam contacts.
2. Loosen the clamp screws and remove the seal beam from the U-profile.
3. Remove the Teflon tape from the seal beam.
4. Remove the mounting plates on both ends of the seal beam by loosening the screws; this releases the sealing wires and/or sealing and cutting wires.
5. Clean the seal beam thoroughly.

NOTES

- After removal of the wires, check the strips of fiber glass for damage; replace if necessary.
- Check the condition of the tensioning springs at both ends of the seal beam; replace if necessary.
- Using the seal beam without the springs may cause the sealing wires to break.
- Check contact plate for damage; replace if necessary.

INSTALL THE SEALING AND CUTTING WIRES AS FOLLOWS:

1. If necessary, install new strips of fiber glass on the seal beam.
2. Insert the new wires behind one of the mounting plates and tighten the screws; make sure that the end of the wires line up with the bottom edge of the mounting plate.
3. Position the wires across the seal beam and loosely install the second mounting plate.
4. Carefully clamp the seal beam upside down in a bench vice.
5. Pull the wires as tightly as possible with a pair of pliers and secure the second mounting plate by tightening the screws.

NOTE

1. The wires can be further tightened by slightly loosening the screws of one of the mounting plates.
2. Pull the wires one-by-one tighter with a pair of pliers.
3. Re-tighten the screws after the correct tension has been achieved.
4. Cut the end of the wires flush with the bottom edge of the mounting plate.

Maintenance

5. Apply the Teflon tape smooth and tight over the seal beam without creases. Make sure that the beam is clean and free of grease.
6. Re-install the seal beam in the vacuum chamber and re-connect the wires.

ALUMINUM T-SHAPED SEAL BEAM

REMOVE THE SEALING WIRES AS FOLLOWS:

1. Remove the seal beam from the machine.
2. Remove the Teflon tape.
3. Loosen the screws on both sides of the beam; this will release the sealing wires.
4. Clean the seal beam thoroughly.

INSTALL THE SEALING WIRES AS FOLLOWS:

1. Apply new fiber glass to the beam if necessary.
2. Place new wires on the beam and fasten them on one side with mounting plates; tighten the screws.
3. Position the wires across the beam.
4. Fasten mounting plates; tighten screws.
5. Carefully clamp the beam in a bench vice.
6. Pull the wires as tightly as possible with a pair of pliers.
7. Secure the mounting plates with the screws.

NOTES

- Check the strip of fiber glass for damage and replace if necessary.
- Check the springs and replace if necessary.
- Using the seal beam without the springs may cause the sealing wires to break.

APPLYING TEFLON TAPE TO SEAL BEAM

1. Position the new Teflon tape on the seal beam and cut out the corners.
2. Remove the protective backing from the Teflon tape.
3. Apply the new tape to the seal beam; the tape has [an](#) adhesive strip on both sides.
4. Slide the seal beam onto the pins in the vacuum chamber (machines with transparent cover).
5. Slide the seal beam in the holder of the cover, tighten the mounting screws, and re-connect the wires (machines with metal cover).

NOTE

- The Teflon tape must not adhere to the tension blocks.

REPLACING SILICONE RUBBER SEAL OF COUNTER BEAM

The rubber seal is clamped in the counter beam. Replace the counter beam seal as follows:

1. Pull the old rubber seal from the groove in the counter beam.
2. Clean the groove.
3. Evenly press the new rubber seal into the groove and make sure that it does not stick out at either end of the counter beam.

Maintenance

RUBBER SEAL OF VACUUM CHAMBER COVER

To assure that the vacuum chamber is properly sealed, it is important that the rubber seal is in good condition and is not damaged. Replace the cover seal as follows:

1. Copy the length of the original rubber seal.
2. Pull the original rubber seal from the groove.
3. Clean the groove.
4. Evenly press the rubber seal into the groove; position the ends of the seal tightly against each other to prevent leakage.

STRUTS, DAMPERS AND SPRINGS

- Machines with transparent covers are equipped with gas struts to open the cover.
- Machines with metal covers are equipped with oil dampers and springs to open the cover.
- Have the struts, dampers and springs checked by your dealer once every 5 years and have them replaced as necessary.
- Have the gas struts replaced if the lid no longer opens properly.

VACUUM HOSES AND TUBES

- Check the vacuum hoses and tubes for kinks, tears and porosity; replace if necessary.

Troubleshooting

Fault/Symptom	Possible Cause	Remedy
Machine does not work.	The machine is not plugged in.	Plug the machine into the electrical outlet.
	The ground fault safety in the electrical panel has tripped.	Check the electrical panel.
	A fuse in the electrical panel is faulty.	Check the electrical panel.
	A fuse in the machine is faulty.	Consult your dealer.
	The motor protection of the machine is switched off.	Consult your dealer.
The vacuum pump does not run at full speed.	The oil is too thick or contaminated.	Change the oil.
	The pump motor runs on two phases.	Check the voltage; if correct, consult your dealer.

Troubleshooting

The vacuum in the package is insufficient.	The programmed vacuum value is too high.	Lower the vacuum value in the program.
	The packaging material is of poor quality.	Select a better-quality packaging material.
	The product damages the bag.	Program a higher value for Soft-Air.
	The machine gasses the package.	Turn off the gassing function.
The seal is leaking.	The package seam is poorly formed.	Increase the sealing time and/or reduce the MAP gas pressure.
	The package seam is burnt.	Decrease the sealing time.
	The opening of the vacuum bag is contaminated.	Try again and make sure that the opening of the bag stays clean.
	The sealing beam is dirty.	Clean the sealing beam.
	The Teflon lining of the sealing beam is damaged.	Replace the Teflon lining.
	The silicon rubber seal in the counter beam is damaged.	Replace the silicon rubber seal.
There is not enough gas in the bag.	The bag is too small.	Select a bigger bag.
	The programmed gas level is too low.	Increase the gas level value.
	The bag is not correctly positioned over the gas outlets.	Adjust the bag position.
The machine does not seal.	The bag is not correctly positioned over the sealing beam.	Adjust the bag position.
	The sealing wire is broken.	Replace the sealing wire.
	The thermal safety of the power supply was tripped.	Wait until the safety resets, which can take half an hour. Decrease the sealing time.
	The electrical contacts of the seal beam have fouled.	Remove the seal beam and clean the pins and contacts with sand paper.
The service symbol appears when turning on the machine, indicating the remaining production hours or cycles.	The service interval counters have reached their maximum programmed values.	To reset the service interval counters after the oil change: Start the machine and while the display shows the hours or cycles, press and hold the "X" button.

Parts Breakdown

Model VP-NL-0050-LS 45310

Vacuum Pump

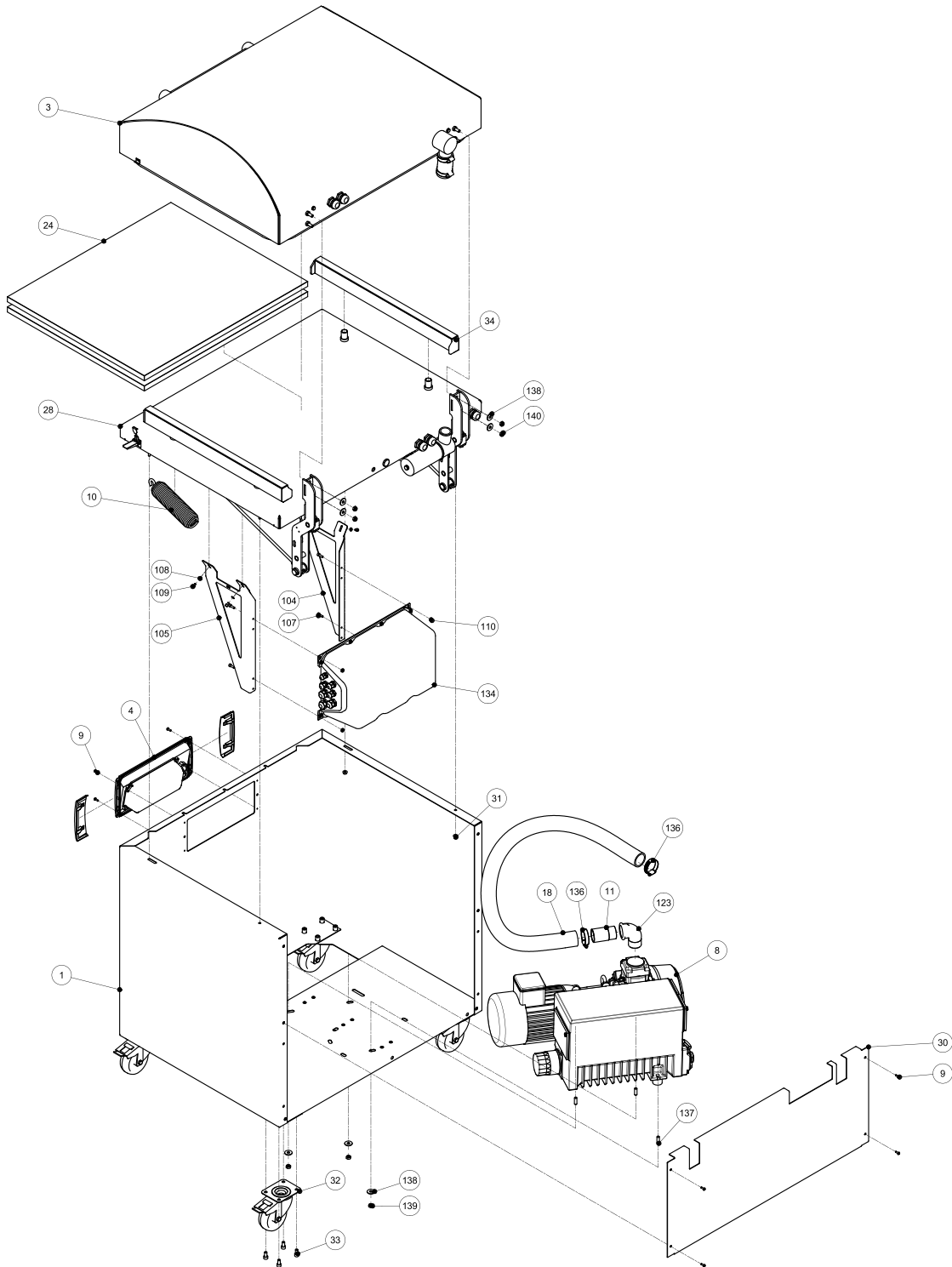

Parts Breakdown

Model VP-NL-0050-LS 45310

Worktable

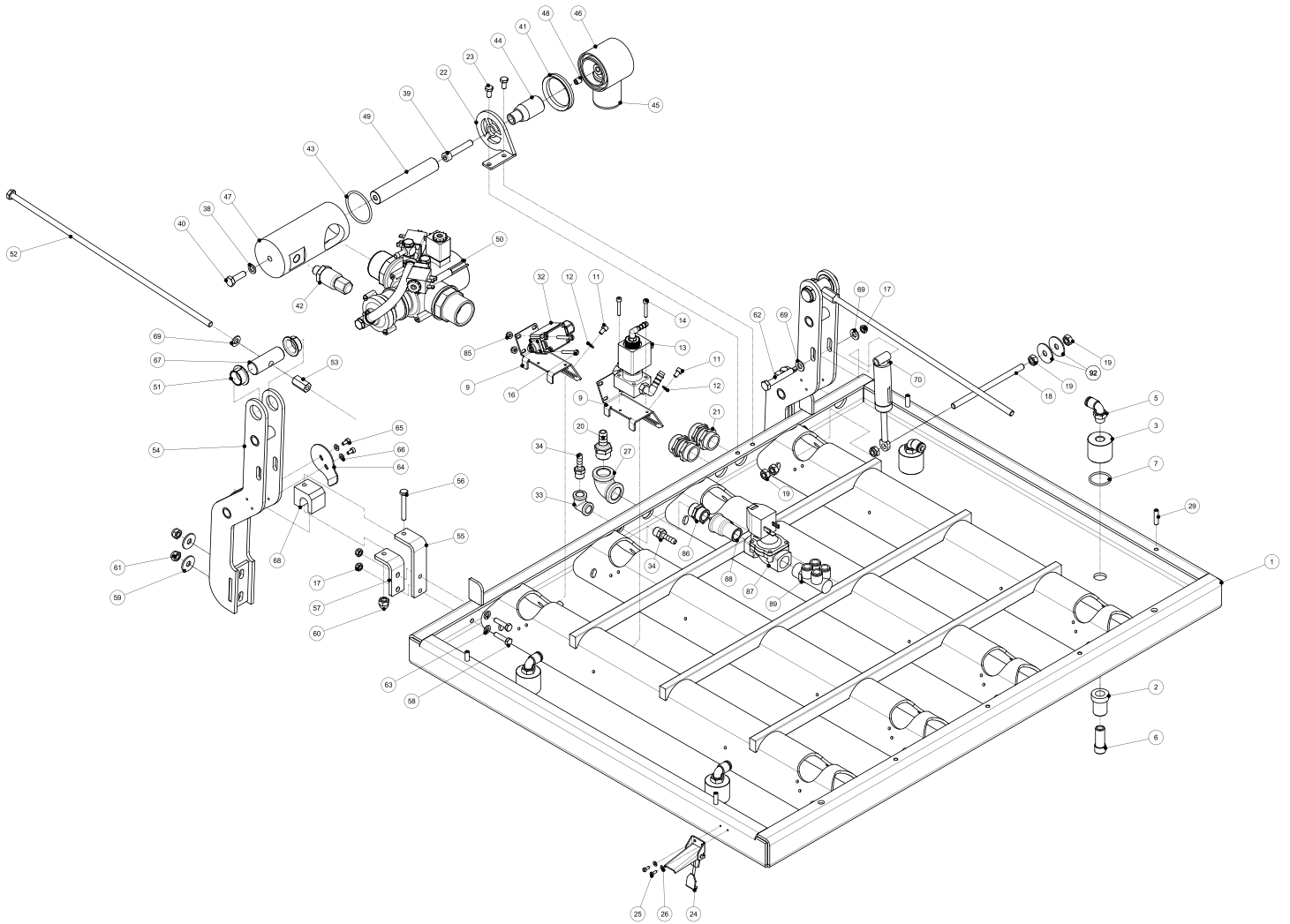

Parts Breakdown

Model VP-NL-0050-LS 45310

Lid

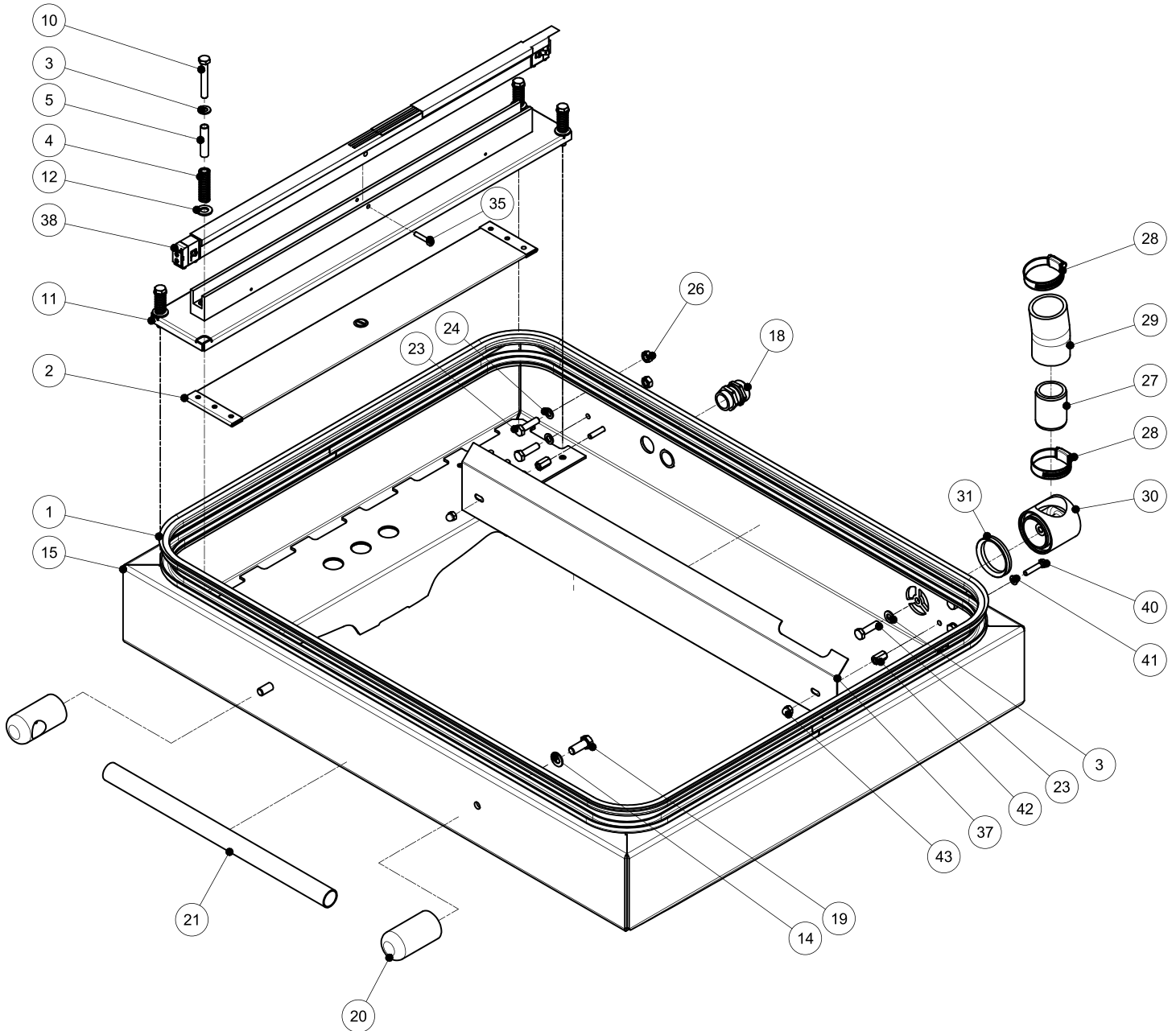

Parts Breakdown

Model *VP-NL-0050-LS* 45310

Seal Bar

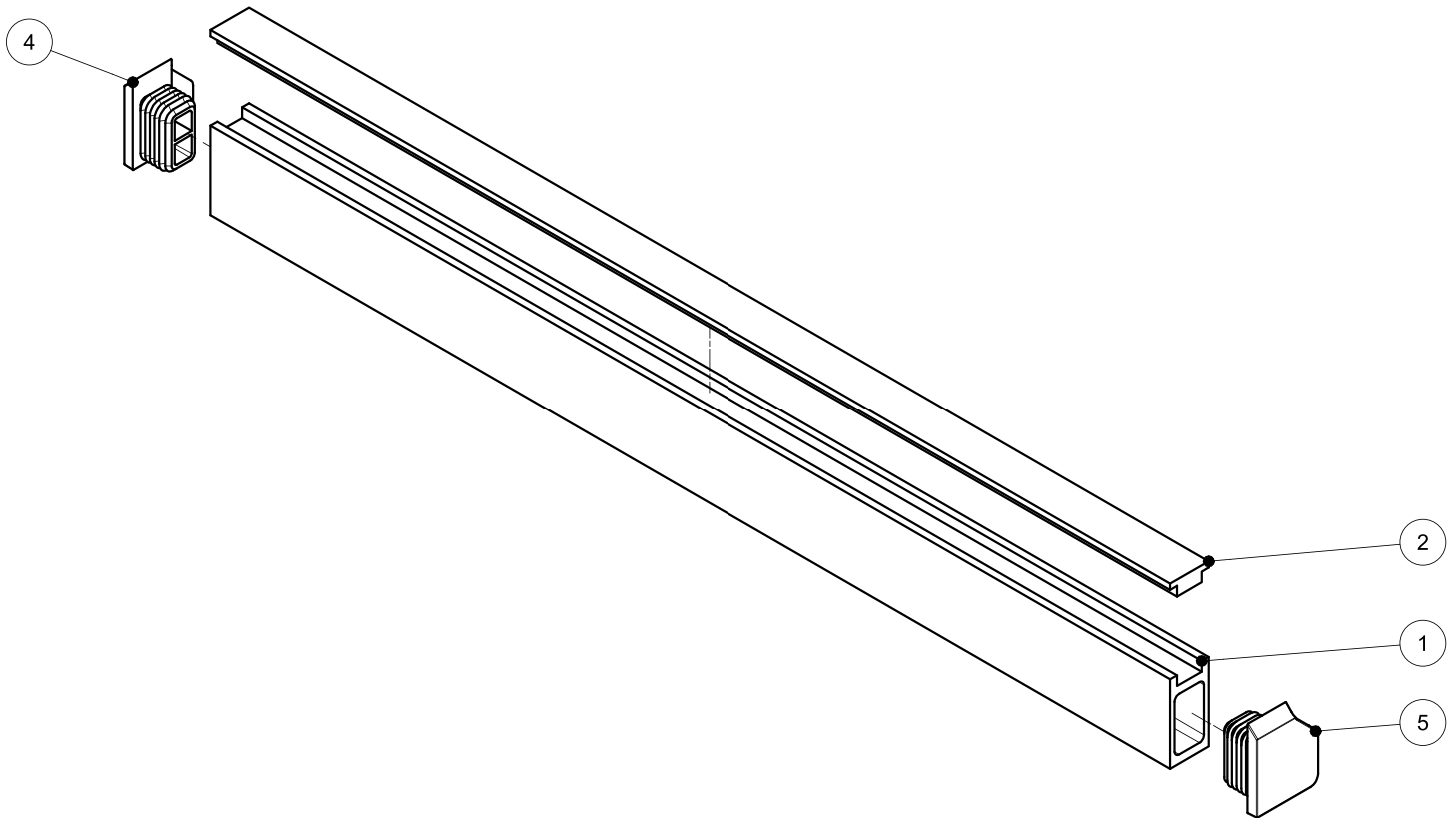

Parts Breakdown

Model VP-NL-0050-LS 45310

Vacuum Valve

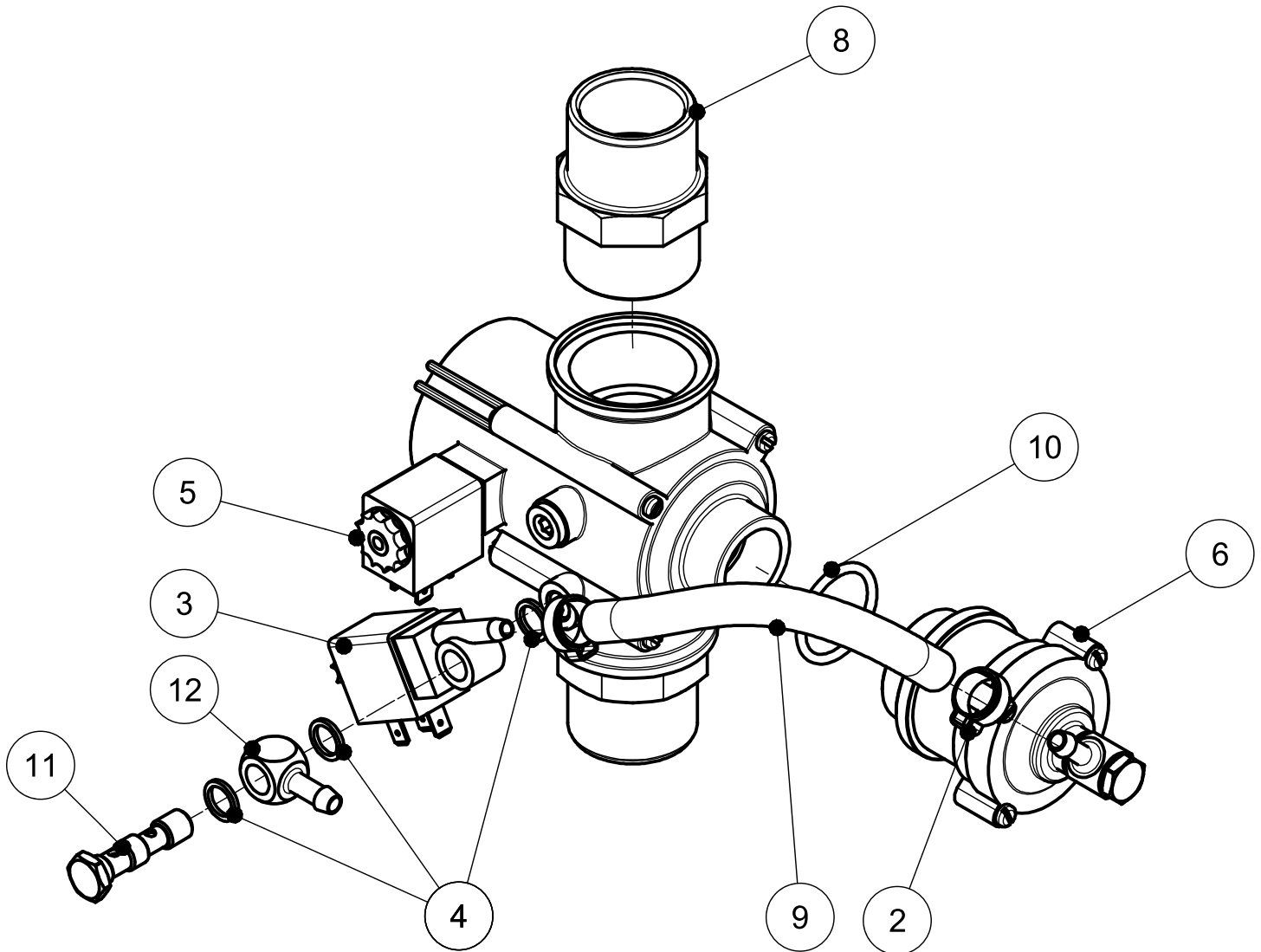

Parts Breakdown

Model VP-NL-0050-LS 45310

Switch Box

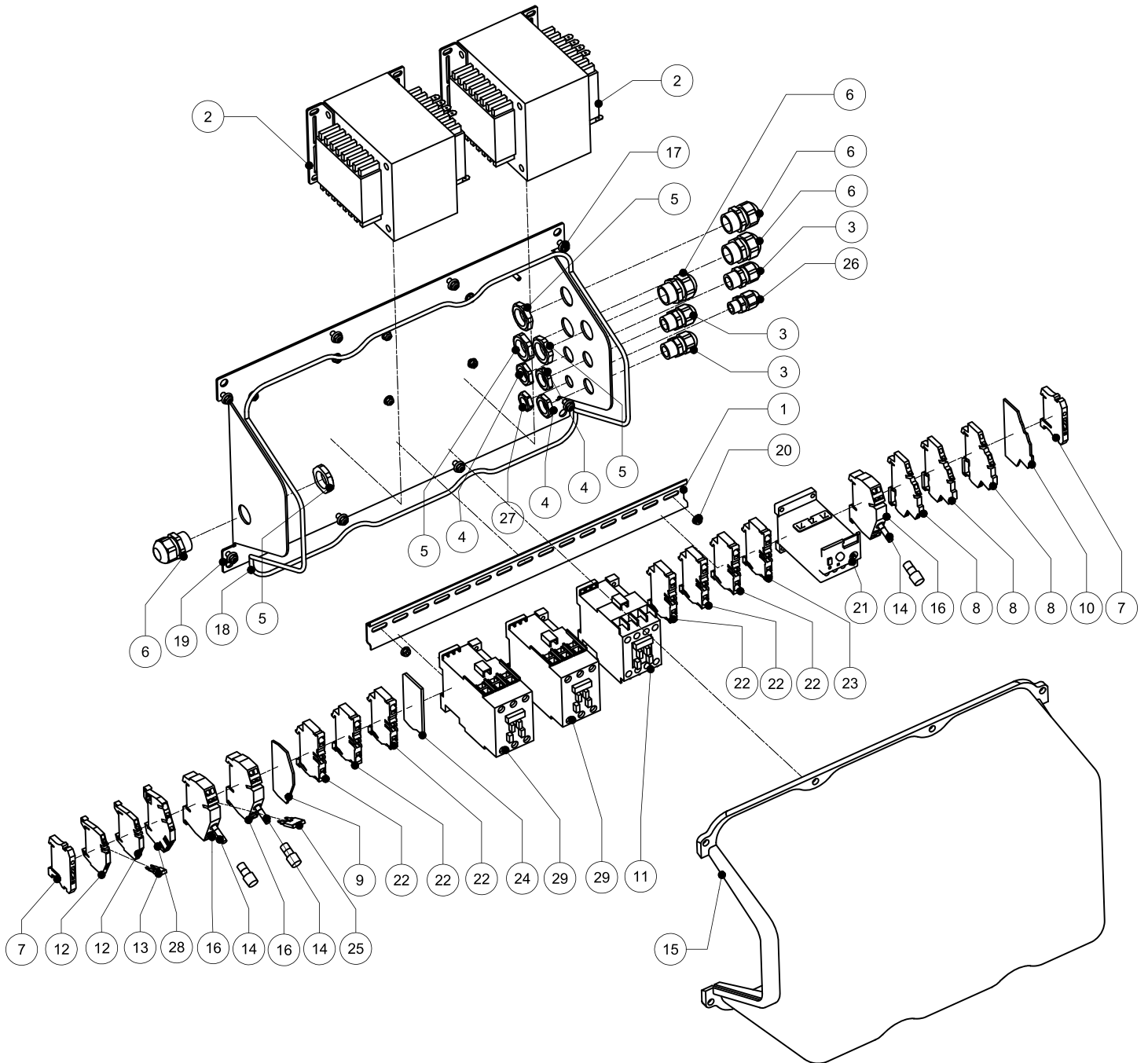

Parts Breakdown

Model VP-NL-0050-LS 45310

Control Panel

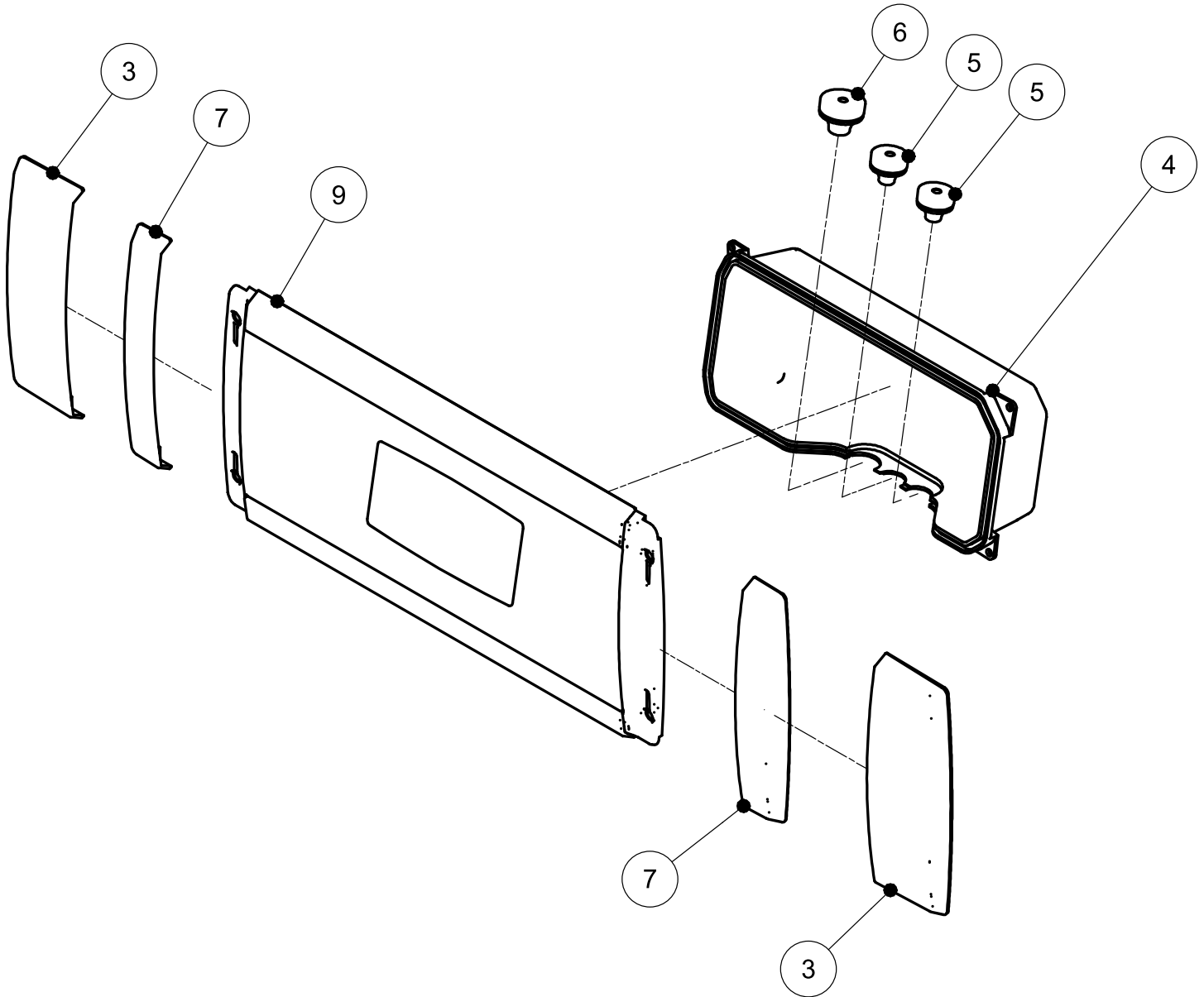

Parts Breakdown

Model VP-NL-0050-LS 45310

Vacuum Pump

Item No.	Description	Position	Item No.	Description	Position	Item No.	Description	Position
AM518	Chassis M5 for 45310	1	AM522	Cover Backside M5 for 45310	30	27782	Hexagon Flangenut M5 Din6923 A2 for 45310	110
65822	Lid M5-S&S for 45310	3	27781	Hexagon Flangenut M6 DIN6923 A2 for 45310	31	65737	Elbow 1 1/4 Int/Ext NR92 for 45310	123
AM519	Pump Busch R5-100M3/H for 45310	8B	35369	Swivel Castor Black ST.ST. 100mm for 45310	32	65779	Switchbox Model-I SC-DC for 45310	134
30026	Slott.Rais.Counter.Head Screw M4x12 DIN7985 A2 for 45310	9	65829	Hexagon Socket Head Cap Screw M8x16 for 45310	33	35889	Hose Clip ABA 44-56mm for 45310	136
35532	Tension Spring 880-STE for 45310	10	AM523	Mounting Bracket Switch Box Pos1 for 45310	104	35391	Adj.Screw/Soc.Head M8x25 DIN916 A2 for 45310	137
35879	Pipe Nipple Half 1.1/4x75 Compl for 45310	11	AM524	Mounting Bracket Switch Box Pos2 for 45310	105	35219	Flat Washer M8 D9021 A2 for 45310	138
AM520	Pumphose 40mm L=1200mm for 45310	18	35481	Hex.Socket Head Cap Screw M5x16 Din912 A2 for 45310	107	27814	Hexagon Nut M8 DIN934 A2 for 45310	139
65826	Locating Plate M5-S&S for 45310	24	35214	Castle Washer M5 for 45310	108	35537	Selflocking Hexagon Nut M8 DIN985 A2 for 45310	140
AM521	Worktable M5-SS for 45310	28	35272	Hex.Socket Head Cap Screw M5x8 Din912 A2 for 45310	109			

Parts Breakdown

Model VP-NL-0050-LS 45310

Worktable

Item No.	Description	Position	Item No.	Description	Position	Item No.	Description	Position
AM525	Worktable M5-KK for 45310	1	AM529	Knee 1/2 90 F-F AISI 316 for 45310	27	AM539	Support Hinge Block MB for 45310	55
35821	Spacer Sil.Holder Gas 6mm for 45310	2	27788	Adj.Screw/Soc.Head M6x25 DIN916 A2 for 45310	29	65808	DIN EN ISO 24017 - M6x45 for 45310	56
35507	Holing Block Silicon Holder HD-03 for 45310	3	35468	Limit Switch with Cable for 45310	32	AM540	Locking Plate Hinge MB for 45310	57
62717	Elbow Screw Coupling G 1/4x8 for 45310	5	AM530	Knee 1/4" F-F 90 AISI316 for 45310	33	35244	Hexagon Screw M6x25 DIN933 A2 for 45310	58
AM526	Mounting Screw Holing Block HD-03 R2 for 45310	6	29997	Brass Hose Coupling 1/4x6 Ext. for 45310	34	35219	Flat Washer M8 D9021 A2 for 45310	59
35364	O-Ring 27x2.5 for 45310	7	35301	Castle Washer Red Copper M8	38	65809	Hexagon Domed Cap Nuts DIN 1587 - M8 for 45310	60
AM527	Universal Bracket DA for 45310	9	65813	Hexagon Socket Head Cap Screw M8x45 for 45310	39	35537	Selflocking Hexagon Nut M8 DIN985 for 45310	61
35272	Hex.Socket Head Cap Screw M5x8 DIN912 A2 for 45310	11	62736	ISO 4017 - M8x25 for 45310	40	35922	Hexagon Screw M8x50 DIN933 A2 for 45310	62
35214	Castle Washer M5 for 45310	12	AM531	V-Ring Type V-050-A for 45310	41	35760	Spring Ring M6 DIN127 A2 for 45310	63
62722	3-2 Valve DC-XL Assembly for 45310	13	65687	Vacuum Transmittor 0-1050MBAR for 45310	42	AM541	Actuator Switch MB for 45310	64
62726	ISO 4762 - M4x25 Hexagon Socket Head Cap Screw for 45310	14	AM532	O-Ring 45x3mm for 45310	43	35320	Hex.Socket Head Cap Screw M4x8 DIN912 A2 for 45310	65
62727	M4x30 Slotted Cheese Head Screw for 45310	16	AM533	Bearing Busch Manifold MB for 45310	44	35433	Castle Washer M4 for 45310	66
65749	M6 Hex Nut DIN 985 for 45310	17	AM534	PVC Tube 40x3 L=50 ST.ST-LINE for 45310	45	35534	Spring Axle Double Chamber for 45310	67
35530	Stud M8x160 DK for 45310	18	AM535	Adapter Vacuum Connection for 45310	46	AM542	Hinge Block MB for 45310	68
27814	Hexagon Nut M8 DIN934 A2 for 45310	19	AM536	Adapter Vacuum Valve MB for 45310	47	35372	Castle Washer M8 for 45310	69
35248	Hose Coupling 1/2x10 Ext. for 45310	20	65817	M8x10 Hexagon Socket Set Screw DIN 916 for 45310	48	65811	Damper 2600N for 45310	70
35831	Cable Gland M25x1.5 Brass for 45310	21	AM537	Mounting Pin Adapter Manifold DA for 45310	49	35041	Hose Clip Klemfa 12.8x14.8mm for 45310	85
AM528	Mounting Bracket Adapter DA for 45310	22	65686	Vacuum Valve MB for 45310	50	35958	Brass Double Nipple 1/2 for 45310	86
30005	Hexagon Screw M6x12 DIN933 A2 for 45310	23	35449	Bearing Ring PAF-20115-P10 for 45310	51	35252	Gas Valve for Gas Distribution for 45310	87
35377	Lid Locker for 45310	24	35533	Hexagon Screw M8x400 A2 for 45310	52	27840	Exten.Sock.Bead.Reduc.1/2 Ext/Int for 45310	88
35293	Slotted Cheese Head Screw M3x5 A2 DIN84 for 45310	25	65818	M8x24 Connecting Nut for 45310	53	AM543	Double Branch Universal Male Elbow 4x10mm x 1/2" for 45310	89
27822	Castle Washer M3 for 45310	26	AM538	Hinge Part Lid MB for 45310	54	AM544	Washer M8x30x1,5 for 45310	92

Parts Breakdown

Model VP-NL-0050-LS 45310

Lid

Item No.	Description	Position	Item No.	Description	Position	Item No.	Description	Position
AM545	Seal for Lid HD for 45310	1	35941	Hexagon Screw M10x25 DIN933 A2 for 45310	19	AM548	V-Ring Type V-050-A for 45310	31
15938	Sealbag 4002 L=550mm for 45310	2	AM546	Mounting Busch for Handle MB for 45310	20	35469	Hex. Socket Head Cap Screw M5x25 DIN912 A2 for 45310	35
35372	Castle Washer M8 for 45310	3	AM547	Handle M/D1 for 45310	21	AM549	Cover Lid M5 for 45310	37
35919	Compression Spring Seal Mechanism for 45310	4	35604	Hexagon Screw M8x30 DIN933 A2 for 45310	23	65683	Sealbalk A1015 Double Seal for 45310	38
35940	Tube STST 10x1x45mm for 45310	5	35301	Castle Washer Red Copper M8 for 45310	24	AM550	M6x30 Hex-Head Bolt DIN 933 for 45310	40
62745	ISO 4017 - M8x55 for 45310	10	27814	Hexagon Nut M8 DIN934 A2 for 45310	26	AM551	Ring Copper 6x12 for 45310	41
65681	Seal Mechanism Assembly D1/M4-L for 45310	11	AM534	PVC Tube 40x3 L=50 ST.ST-Line for 45310	27	AM552	Nut M6x18 for 45310	42
35447	Castle Washer M10 for 45310	12	35889	Hose Clip ABA 44-56mm for 45310	28	35916	Capnut High M6 D1587 A2 for 45310	43
35948	Castle Washer Red Copper M10 for 45310	14	65798	Hose Ø40mm for 45310	29			
65822	Lid M5-S&S for 45310	15	AM535	Adapter Vacuum Connection for 45310	30			

Seal Bar

Item No.	Description	Position	Item No.	Description	Position
65697	Silicone Holder D1/M4-L for 45310	1	AM553	Plug Silicon- / Insertplate Holder Left for 45310	4
15842	Silicone T-Profile 40 Shore One Meter for 45310	2	AM554	Plug Silicon- / Insertplate Holder Right for 45310	5

Vacuum Valve

Item No.	Description	Position	Item No.	Description	Position	Item No.	Description	Position
30019	Hose Clip Klemfa 12.8x14.8mm for 45310	2	AI932	Decompression Valve NW20 3 4" (NC) for 45310	6	62754	Dubbelhoschroef 1/8 for 45310	11
35488	3-Way Valve Soft-Air New for 45310	3	35855	PVC Nipple 219105 11/4x40 for 45310	8	62752	Swenkringstuk 1/8-6mm for 45310	12
35431	Sealing Washer 0251796/0251797 for 45310	4	27837	Hose (O2) Drago 6x13 for 45310	9			
35850	Vacuumvalve 2x1-1/4 TV for 45310	5	35852	O-Ring 28x3 for 45310	10			

Parts Breakdown

Model VP-NL-0050-LS 45310

Switch Box

Item No.	Description	Position	Item No.	Description	Position	Item No.	Description	Position
65704	Din-Rail 380mm for 45310	1	15771	Closed Contactor 24VAC for 45310	11	65710	EMBR AB193-ED1*P for 45310	21
15792	Combi-Trafo P200/460V-S24/32V for 45310	2	35687	Wire Clamp 2.5-2/2 AN for 45310	12	35318	Wireclamp 6-2/2 AN for 45310	22
65705	Wartel M16x1.5 KS for 45310	3	35688	Clamp Connector 2.5/2 for 45310	13	35317	Earth Terminal PE 6-10 for 45310	23
65706	Moer M16x1.5 KS for 45310	4	35307	Zekering Keram.5x20 2.5A Traag for 45310	14	65711	Sluitplaat PAP PDU 6/10 for 45310	24
65707	Moer M20x1.5 KS for 45310	5	35555	Cover Switchbox for 45310	15	65712	Doorverbinder ZQV 6/2 for 45310	25
35376	Cable Gland M20x1.5 Plastic for 45310	6	35306	Fuse Clamp 2.5-2/ZSI for 45310	16	65713	Wartel M12x1.5 KS for 45310	26
35305	End Fent for 45310	7	27782	Hexagon Flangenut M5 DIN6923 A2 for 45310	17	65714	Moer M12x1.5 KS for 45310	27
35315	Double Clamp 2.5-2 for 45310	8	35559	Micro Cellular Rubber 4mm Black for 45310	18	35304	Earth Terminal PE 4-2/3 for 45310	28
65708	Sluitplatt Zap ZDU 6-2 for 45310	9	AM555	Montageplaat 2.5mm2 04-Serie for 45310	19	15772	Contactor 24VAC for 45310	29
35323	Endplate Wireconnector for 45310	10	35141	Hexagon Flangenut M4 DIN6923-A2 for 45310	20			

Control Panel

Item No.	Description	Position	Item No.	Description	Position	Item No.	Description	Position
65753	Cap Wide Holder 04-Control for 45310	3	65755	Grommet 16mm (283 1600 599 99) for 45310	5	65740	Cap Small Holder 04-Control for 45310	7
65754	Cover Protection 04-Control for 45310	4	65756	Grommet 20mm (283 1600 599 99) for 45310	6	A1920	Houder Groot- PCB-HV Sensor for 45310	9



Warranty Registration

Thank you for purchasing an Omcan product. To register your warranty for this product, complete the information below, tear off the card at the perforation and then send to the address specified below. You can also register online by visiting:

Merci d'avoir acheté un produit Omcan. Pour enregistrer votre garantie pour ce produit, complétez les informations ci-dessous, détachez la carte au niveau de la perforation, puis l'envoyer à l'adresse spécifiée ci-dessous. Vous pouvez également vous inscrire en ligne en visitant:

Gracias por comprar un producto Omcan usted. Para registrar su garantía para este producto, complete la información a continuación, cortar la tarjeta en la perforación y luego enviarlo a la dirección indicada a continuación. También puede registrarse en línea en:

<https://omcan.com/warranty-registration/>

For mailing in Canada

Pour postale au Canada

Por correo en Canadá

OMCAN

PRODUCT WARRANTY REGISTRATION

3115 Pepper Mill Court,

Mississauga, Ontario

Canada, L5L 4X5

For mailing in the US

Pour diffusion aux États-Unis

Por correo en los EE.UU.

OMCAN

PRODUCT WARRANTY REGISTRATION

4450 Witmer Industrial Estates, Unit 4,

Niagara Falls, New York

USA, 14305

or email to: service@omcan.com



Purchaser's Information

Name: _____

Address: _____

City: _____ Province or State: _____ Postal or Zip: _____

Country: _____

Dealer from which Purchased: _____

Dealer City: _____ Dealer Province or State: _____

Invoice: _____

Model Name: _____ Model Number: _____

Machine Description: _____

Date of Purchase (MM/DD/YYYY): _____

Would you like to extend the warranty? Yes No

Company Name: _____

Telephone: _____

Email Address: _____

Type of Company:

Restaurant Bakery Deli

Butcher Supermarket Caterer

Institution (specify): _____

Other (specify): _____

Serial Number: _____

Date of Installation (MM/DD/YYYY): _____

Thank you for choosing Omcan | Merci d'avoir choisi Omcan | Gracias por elegir Omcan



Since 1951 Omcan has grown to become a leading distributor of equipment and supplies to the North American food service industry. Our success over these many years can be attributed to our commitment to strengthen and develop new and existing relationships with our valued customers and manufacturers. Today with partners in North America, Europe, Asia and South America, we continually work to improve and grow the company. We strive to offer customers exceptional value through our qualified local sales and service representatives who provide convenient access to over 6,500 globally sourced products.

Depuis 1951 Omcan a grandi pour devenir un des “leaders” de la distribution des équipements et matériel pour l’industrie des services alimentaires en Amérique du Nord. Notre succès au cours de ces nombreuses années peut être attribué à notre engagement à renforcer et à développer de nouvelles et existantes relations avec nos clients et les fabricants de valeur. Aujourd’hui avec des partenaires en Amérique du Nord, Europe, Asie et Amérique du Sud, nous travaillons continuellement à améliorer et développer l’entreprise. Nous nous efforçons d’offrir à nos clients une valeur exceptionnelle grâce à nos ventes locales qualifiées et des représentants de service qui offrent un accès facile à plus de 6500 produits provenant du monde entier.

Desde 1951 Omcan ha crecido hasta convertirse en un líder en la distribución de equipos y suministros de alimentos en América del Norte industria de servicios. Nuestro éxito en estos años se puede atribuir a nuestro compromiso de fortalecer y desarrollar nuevas relaciones existentes con nuestros valiosos clientes y fabricantes. Hoy con socios de América del Norte, Europa, Asia y América del Sur, que trabajan continuamente para mejorar y crecer la empresa. Nos esforzamos por ofrecer a nuestros clientes valor excepcional a través de nuestro local de ventas y representantes de los servicios que proporcionan un fácil acceso a más de 6,500 productos con origen a nivel mundial.

