

## Outdoor Heat Pump

# User's Information/Installation Instructions

## Two Stage R-410A Split System

These units have been designed and tested for capacity and efficiency in accordance with A.R.I. Standards. Split System Heat Pump units are designed for use with a wide variety of fossil fuel furnaces, electric furnaces, air handlers, and evaporator coil combinations.

These instructions are primarily intended to assist qualified individuals experienced in the proper installation of heating and/or air conditioning appliances. Some local codes require licensed installation/service personnel for this type of equipment. Read all instructions carefully before starting the installation.

## USER'S INFORMATION

### IMPORTANT

Read this owner information to become familiar with the capabilities and use of your appliance. Keep this with literature on other appliances where you have easy access to it in the future. If a problem occurs, check the instructions and follow recommendations given. If these suggestions don't eliminate your problem, call your servicing contractor.

### Heat Pump Principle of Operation

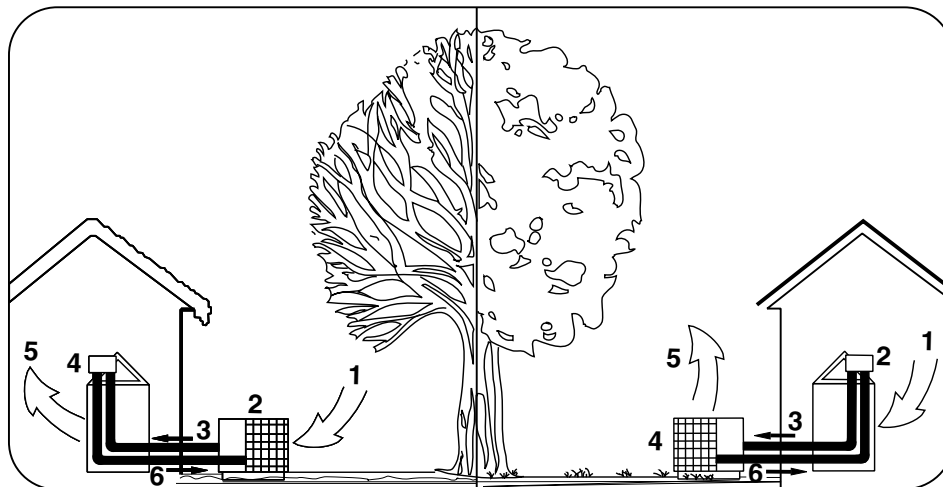

#### WINTER HEATING

1. Outdoor air enters heat pump.
2. Cold, heat-transfer section (outdoor coil) extracts heat from outdoor air as refrigerant evaporates from a liquid to a gas.
3. Refrigerant, compressed to a hot gas by heat pump, carries the heat to the hot heat-transfer section (indoor coil).
4. Hot, heat-transfer section (indoor coil) releases the heat to indoor air as refrigerant condenses from a gas to a liquid.
5. Air handler circulates the heat throughout the home.
6. Refrigerant returns to outdoor coil and evaporates once again to absorb more heat.

#### SUMMER COOLING

1. Indoor air enters the air handler section.
2. Cold, heat-transfer section (indoor coil) extracts heat from indoor air as refrigerant evaporates from a liquid to a cold gas.
3. Refrigerant, drawn to heat pump and compressed to a hot gas by heat pump, carries the heat outdoors.
4. Hot, heat-transfer section (outdoor coil) releases the heat as refrigerant condenses from a gas to a liquid.
5. Heat pump (outdoor fan) discharges the heat to outside air.
6. Refrigerant returns to indoor coil and evaporates once again to absorb more heat.

## OPERATING INSTRUCTIONS

### TO OPERATE YOUR HEAT PUMP FOR COOLING —

1. Set the thermostat system switch to COOL and the thermostat fan switch to AUTO. (See Figure 1)
2. Set the thermostat temperature to the desired temperature level using the temperature selector. Please refer to the separate detailed thermostat user's manual for complete instructions regarding thermostat programming. The outdoor unit and indoor blower will both cycle on and off to maintain the indoor temperature at the desired cooling level.

**NOTE:** If the thermostat temperature level is re-adjusted, or the thermostat system switch is repositioned, the outdoor unit may not start immediately. The outdoor unit contains a protective timer circuit which holds the unit off for approximately five minutes following a previous operation, or the interruption of the main electrical power.

### TO OPERATE YOUR HEAT PUMP FOR HEATING —

1. Set the thermostat system switch to HEAT and the thermostat fan switch to AUTO. (See Figure 1)

2. Set the thermostat temperature to the desired temperature level using the temperature selector. Please refer to the separate detailed thermostat user's manual for complete instructions regarding thermostat programming. The outdoor unit and indoor blower will both cycle on and off to maintain the indoor temperature at the desired heating level.

**NOTE:** If the thermostat temperature level is re-adjusted, or the thermostat system switch is repositioned, the outdoor unit may not start immediately. The outdoor unit contains a protective timer circuit which holds the unit off for approximately five minutes following a previous operation, or the interruption of the main electrical power.

#### Emergency Heat:

The thermostat includes a system switch position termed EM. HT. This is a back-up heating mode to be used only if there is a suspected problem with the outdoor unit. With the system switch set to EM. HT. the outdoor unit will be locked off, and supplemental heat (typically electric resistance heating) will be used as a source of heat. Sustained use of electric resistance heat in place of the heat pump will result in an increase in electric utility costs.

#### Defrost:

During cold weather heating operation, the outdoor unit will develop a coating

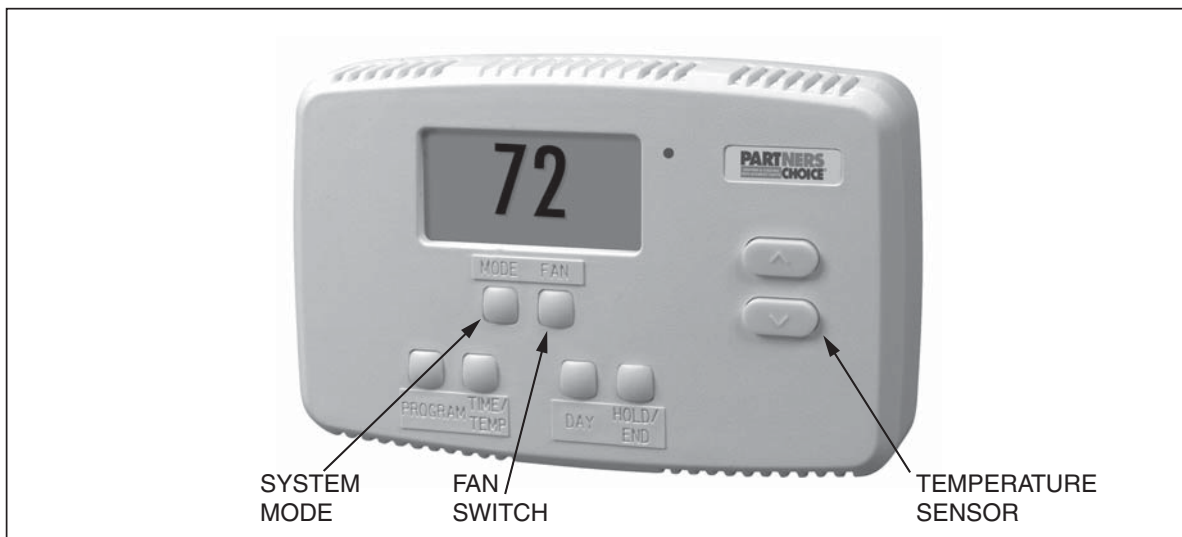

Figure 1. Typical Thermostat

of snow and ice on the heat transfer coil. This is normal, and the unit will periodically defrost itself. At the beginning of the defrost cycle, both the outdoor condenser fan and compressor will de-energize. After approximately 30 seconds, the compressor will energize and begin to heat the outdoor coil causing the ice and snow to melt. After the ice and snow have melted, some steam may rise from the outdoor unit as the warm coil causes some melted frost to evaporate. Once the defrost cycle is completed, the outdoor fan motor will start, and the compressor will de-energize again for approximately 30 seconds. Then, the compressor will energize and continue normal operation.

## TO OPERATE YOUR HEAT PUMP FOR AUTOMATIC COOLING AND HEATING —

1. Set the thermostat system switch to AUTO and the thermostat fan switch to AUTO. (See **Figure 1**)

Note: Thermostats will vary. Some models will not include the AUTO mode, and others will have the AUTO in place of the HEAT and COOL, and some will include all three.

2. Set the thermostat temperature to the desired heating and cooling temperature level(s). The outdoor unit and the indoor blower will then cycle on and off in either the heating or cooling mode of operation as required to automatically maintain the indoor temperature within the desired limits.

## TO SHUT OFF YOUR HEAT PUMP —

Set the thermostat system switch to OFF and the thermostat fan switch to AUTO. (See **Figure 1**) The system will not operate, regardless of the thermostat temperature selector(s) setting.

## TO OPERATE THE INDOOR BLOWER CONTINUOUSLY —

Set the thermostat fan switch to ON (See **Figure 1**). The indoor blower will start and will run continually until the fan switch is reset to AUTO.

The continuous indoor blower operation can be obtained with the thermostat system switch set in any position, including OFF.

The continuous indoor blower operation is typically used to circulate the indoor air to equalize a temperature unbalance due to a sun load, cooking, or fireplace operation.

## TO MAINTAIN YOUR HEAT PUMP —

---

**CAUTION:**

---

**Be certain the electrical power to the outdoor unit and the furnace/air handler is disconnected before doing the following recommended maintenance.**

---

1. Regularly:
  - a. Clean or replace the indoor air filter at the start of each heating and cooling season, and when an accumulation of dust and dirt is visible on the air filter. Inspect the filter monthly.
  - b. Remove any leaves and grass clippings from the coil in the outdoor unit, being careful not to damage the aluminum fins.
  - c. Check for any obstruction such as twigs, sticks, etc.

---

**CAUTION:**

---

**Do not over-oil, or oil motors not factory-equipped with oil tubes. The compressor is hermetically “sealed” and does not require lubrication.**

---

2. Before Calling a Service Technician, Be Certain:
  - a. The unit thermostat is properly set, see “To Operate Your Heat Pump for Cooling” and “To Operate Your Heat Pump for Heating.”
  - b. The unit disconnect fuses are in good condition, and the electrical power to the unit is turned on.

## Read Your Warranty

Please read the separate warranty document completely. It contains valuable information about your system.

## GENERAL INFORMATION

---

### **CAUTION:**

---

**This unit uses R-410A. DO NOT under any circumstance use any other refrigerant besides R-410A in this unit. Use of another refrigerant will damage this unit.**

---

Read the following instructions completely before performing the installation.

**Outdoor Unit Section** — Each outdoor unit is shipped with a refrigerant charge adequate to operate the outdoor section with an indoor matching coil or air handler. These units include the proper amount of refrigerant for an additional 15 ft. of refrigerant lines the same size as the valve fittings.

**NOTE:** DO NOT USE ANY PORTION OF THE CHARGE FOR PURGING OR LEAK TESTING.

Matching coils and air handlers may be shipped with a small holding charge to pressurize them to keep out contaminants. To release the pressure, read the indoor section installation instructions carefully.

**Liquid and Suction Lines** — Fully annealed, refrigerant grade copper tubing should be used when installing the system. Refrigerant suction line tubing should be fully insulated.

**Field Connections for Electrical Power Supply** — All wiring must comply with current provisions of the “National Electrical Code” (ANSI/NFPA 70) and with applicable local codes having jurisdiction. The minimum size of electrical conductors and circuit protection must be in compliance with information listed on the outdoor unit data label.

## SAFETY CONSIDERATIONS

**Pressures within the System** — Split system heat pump equipment contains liquid

and gaseous refrigerant under pressure. Installation and servicing of this equipment should be accomplished by qualified, trained personnel thoroughly familiar with this type of equipment. Under no circumstances should the Homeowner attempt to install and/or service the equipment.

**Labels, Tags, Precautions** — When working with this equipment, follow all precautions in the literature, on tags, and on labels provided with the equipment. Read and thoroughly understand the instructions provided with the equipment prior to performing the installation and operational checkout of the equipment.

**Brazing Operations** — Installation of equipment may require brazing operations. Safety codes must be complied with. Safety equipment (e.g.; safety glasses, work gloves, fire extinguisher, etc.) must be used when performing brazing operations.

---

### **WARNING:**

---

**Ensure all electrical power to the unit is off prior to installing or servicing the equipment. Failure to do so may cause personal injury or death.**

---

## SITE PREPARATION

**Unpacking Equipment** — Remove the cardboard carton and User’s Manual from the equipment. Take care to not damage tubing connections when removing from the carton.

**Inspect for Damage** — Inspect the equipment for damage prior to installing the equipment at the job site. Ensure coil fins are straight and, if necessary, comb fins to remove flattened and bent fins.

**Preferred Location of the Outdoor Unit at the Job Site** — Conduct a survey of the job site to determine the optimum location for mounting the outdoor unit. Overhead obstructions, poorly ventilated areas, and areas subject to accumulation of debris should be avoided. The outdoor unit should be installed no closer than 18 inches from the outside walls of the facility and in an area free from overhead obstructions to ensure unrestricted airflow through the outdoor unit.

**Facility Prerequisites** — Electrical power supplied must be adequate for proper operation of the equipment. The system must be wired and provided with circuit protection in accordance with local building codes and the National Electrical Code.

## INSTALLING THE OUTDOOR UNIT

**Slab Mount** — The site selected for a slab mount installation requires a stable foundation and one not subject to erosion. The slab should be level and anchored (if necessary) prior to placing the equipment on the slab.

**Cantilever Mount** — The cantilever mount should be designed with adequate safety factor to support the weight of the equipment, and for loads subjected to the mount during operation. Installed equipment should be adequately secured to the cantilever mount and levelled prior to operation of the equipment.

**Roof Mount** — The method of mounting should be designed so as not to overload roof structures nor transmit noise to the interior of the structure. Refrigerant and electrical line should be routed through suitably waterproofed openings to prevent water leaking into the structure.

## INSTALLING THE INDOOR UNIT

The indoor section should be installed before proceeding with routing of refrigerant piping. Consult the Installation Instructions of the indoor unit (i.e.: air handler, furnace, etc.) for details regarding installation.

## CONNECTING REFRIGERANT TUBING BETWEEN THE INDOOR AND OUTDOOR UNIT

---

 **CAUTION:**

---

This system utilizes R-410A refrigerant with POE oil. When servicing, cover or seal openings to minimize the exposure of the refrigerant system to air to prevent accumulation of moisture and other contaminants.

---

**General** — Once outdoor and indoor unit placement has been determined, route refrigerant tubing between the equipment in accordance with sound installation practices. Refrigerant tubing should be routed in a manner that minimizes the length of tubing and the number of bends in the tubing. Refrigerant tubing should be supported in a manner that the tubing will not vibrate or abrade during system operation. Tubing should be kept clean of foreign debris during installation. Every effort should be made by the installer to ensure that the field installed, refrigerant containing components of the system have been installed in accordance with these instructions and sound installation practices so as to insure reliable system operation and longevity.

The maximum recommended interconnecting refrigerant line length is 75 feet, and the vertical elevation difference between the indoor and outdoor sections should not exceed 20 feet. Consult long line application guide for installations in excess of these limits.

**Filter Dryer Installation** — A filter dryer is provided with the unit and must be installed in the liquid line of the system. If the installation replaces a system with a filter dryer already present in the liquid line, the filter dryer must be replaced with the one supplied with the unit. The filter dryer must be installed in strict accordance with the manufacturer's installation instructions.

**Optional Equipment** — Optional equipment (e.g.: low ambient control, etc.) should be installed in strict accordance with the manufacturer's installation instructions.

## ELECTRICAL CONNECTIONS

---

 **WARNING:**

---

Turn off all electrical power at the main circuit box before wiring electrical power to the outdoor unit. Failure to comply may cause severe personnel injury or death.

---

**Wiring Diagram/Schematic** — A wiring diagram/schematic is located on the inside cover of the electrical box of the outdoor unit. The installer should become familiar with the wiring diagram/schematic before making any electrical connections to the outdoor unit.

**Outdoor Unit Connections** — The outdoor unit requires both power and control circuit electrical connections. Refer to the unit wiring diagram/schematic for identification and location of outdoor unit field wiring interfaces.

**Control Circuit Wiring** — The outdoor unit is designed to operate from a 24 VAC Class II control circuit. Control circuit wiring must comply with the current provisions of the “National Electrical Code” (ANSI/NFPA 70) and with applicable local codes having jurisdiction.

Thermostat connections should be made in accordance with the instructions supplied with the thermostat, and with the instructions supplied with the indoor equipment. A typical residential installation with a heat pump thermostat and air handler are shown below.

**Electrical Power Wiring** — Electrical power wiring must comply with the current provisions of the “National Electrical Code” (ANSI/NFPA 70) and with applicable local codes having jurisdiction. Use of rain tight conduit is recommended. Electrical conductors shall have minimum circuit ampacity in compliance with the outdoor unit rating label. The facility shall employ electrical circuit protection at a current rating no

greater than that indicated on the outdoor unit rating label. Refer to the unit wiring diagram for connection details.

**Minimum Circuit Ampacity** — Electrical wiring to the equipment must be compatible and in compliance with the minimum circuit ampacity listed on the outdoor unit data label.

**Maximum Fuse/Circuit Breaker Size** — Circuit protection for the outdoor unit must be compatible with the maximum fuse/circuit breaker size listed on the outdoor unit data label.

**Disconnect Switch** — An electrically compatible disconnect switch must be within line of sight of the outdoor unit. This switch shall be capable of electrically de-energizing the outdoor unit.

**Optional Equipment** — Optional equipment requiring connection to the power or control circuits must be wired in strict accordance with current provisions of the National Electrical Code (ANSI/NFPA 70), with applicable local codes having jurisdiction, and the installation instructions provided with the equipment. Optional Equipment (e.g.: low ambient control, hard start kits, etc.) should be installed in strict accordance with the manufacturer’s installation instructions.

## STARTUP AND CHECKOUT

### **WARNING:**

**Ensure electrical power to the unit is off prior to performing the following steps. Failure to do so may cause personal injury or death.**

**Air Filters** — Ensure air filters are clean and in place prior to operating the equipment.

**Thermostat** — Set the room thermostat function switch to OFF, fan switch to AUTO, and adjust the temperature setpoint to its highest setting.

Prior to applying electrical power to the outdoor unit, ensure that the unit has been properly and securely grounded, and that power supply connections have been made at both the facility power interface and outdoor unit.

COPPER WIRE SIZE — AWG (1% Voltage Drop)				
Supply Wire Length-Feet				Supply Circuit Ampacity
200	150	100	50	
6	8	10	14	15
4	6	8	12	20
4	6	8	10	25
4	4	6	10	30
3	4	6	8	35
3	4	6	8	40
2	3	4	6	45
2	3	4	6	50
2	3	4	6	55
1	2	3	4	60

Wire Size based on N.E.C. for 60° type copper conductors.

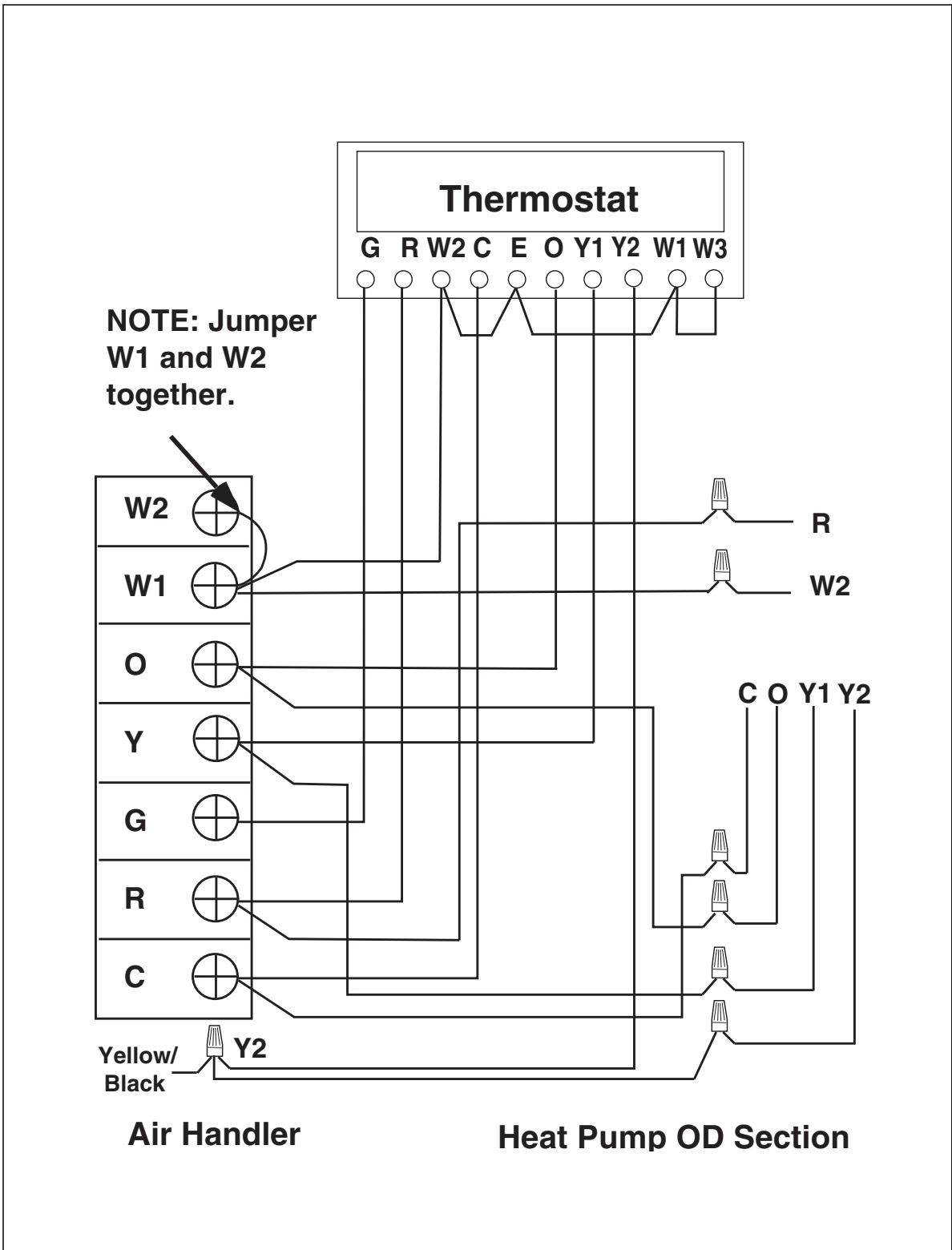

Typical 2-Stage Cooling Heat Pump with  
Optional Indoor Thermostat and  
Variable Speed Air Handler

**Outdoor Unit** — Ensure the outdoor coil and top of the unit are free from obstructions and debris, and all equipment access/control panels are in place.

Using extreme caution, apply power to the unit and inspect the wiring for evidence of open, shorted, and/or improperly wired circuits.

## Functional Checkout:

---



## CAUTION:

---

**These units have a crankcase heater factory installed. Wait 24 hours prior to performing a function checkout to allow for heating of the compressor crankcase. Failure to comply may result in damage and could cause premature failure of the system.**

---

**Indoor Blower** — Turn the fan switch to ON. Verify that the indoor blower is operating and that airflow is not restricted. Set the fan switch back to AUTO. Blower will operate at a decreased speed on continuous fan.

**2-Speed Outdoor Fan Motor (Select Models)** — If unit utilizes a 2-speed condenser fan motor, this motor will operate on low speed when in low cooling, and on high speed when in high cooling. A relay within the control area switches the fan motor from low to high speed using the call for high cooling as the trigger.

**Low-Pressure Switch** — A low-pressure switch is factory-installed and located in the suction line internal to the outdoor unit. The switch is designed to protect the compressor from a loss of charge. Under normal conditions, the switch is closed. If the suction pressure falls below 5 psig, then the switch will open and de-energize the outdoor unit. The switch will close again once the suction pressure increases above 20 psig. Please note that the switch interrupts the thermostat inputs to the unit. Thus, when the switch opens and then closes, there will be a 5 minute short cycling delay before the outdoor unit will energize.

**Discharge Temperature Limit** — A discharge temperature limit is factory installed and located on the compressor discharge line internal to the outdoor unit within 5 inches of the compressor discharge. The limit is designed to protect the

compressor from abnormal temperatures that may occur if there is a loss of charge. Under normal conditions, the switch is closed. If the discharge temperature rises above 270 °F, then the switch will open and de-energize the outdoor unit. The switch will close again once the temperature decreases below 190 °F. Please note that the switch interrupts the thermostat inputs to the unit. Thus, when the switch opens and then closes, there will be a 5 minute short cycling delay before the outdoor unit will energize.

**High-Pressure Switch** — A high-pressure switch is factory-installed and located in the compressor discharge line internal to the outdoor unit. The switch is designed to de-energize the system when very high pressures occur during abnormal conditions. Under normal conditions, the switch is closed. If the discharge pressure rises above 575 psig, then the switch will open and de-energize the outdoor unit. The switch will close again once the discharge pressure decreases to 460 psig. Please note that the switch interrupts the thermostat inputs to the unit. Thus, when the switch opens and then closes, there will be a 5 minute short cycling delay before the outdoor unit will energize.

**Short Cycle Protection** — With the system operating in COOLING mode, note the setpoint temperature setting of the thermostat, and gradually raise the setpoint temperature until the outdoor unit and indoor blower de-energize. Immediately lower the setpoint temperature of the thermostat to its original setting and verify that the indoor blower is energized and that the outdoor unit remains de-energized. Verify that, after approximately 5 minutes, the outdoor unit energizes and that the temperature of the air supplied to the facility is cooler than ambient temperature.

**Comfort Alert™ Diagnostics** — The Comfort Alert™ diagnostics module is a breakthrough innovation for troubleshooting heat pump and air conditioning system failures. The module installs easily in the electrical box of the outdoor unit near the compressor contactor. By monitoring and analyzing data from the Copeland scroll compressor and the thermostat demand, the module can accurately detect the cause of electrical and system related failures without any sensors. A flashing LED indicator communicates the ALERT code and guides the service technician more quickly and accurately to the root cause of a problem.

**NOTE:** This module does not provide safety protection! The Comfort Alert™ module is a monitoring device and cannot control or shut down other devices.

**LED Description (See Figure 1)**

**POWERLED (Green):** indicates voltage is present at the power connection of the module.

**ALERT LED (Yellow):** communicates an abnormal system condition through a unique flash code. The ALERT LED will flash a number of times consecutively, pause and then repeat the process. The number of consecutive flashes, defined as the Flash Code, correlates to a particular abnormal condition. Detailed descriptions of specific ALERT Flash Codes are shown in Table 1 of this manual.

**TRIP LED (Red):** indicates there is a demand signal from the thermostat but no current to the compressor is detected by the module. The TRIP LED typically indicates the compressor protector is open or may indicate missing supply power to the compressor.

The scroll compressor's run (R), common (C) and start (S) wires are routed through the holes in the Comfort Alert™ module marked "R," "C" and "S." The common (C) need not be routed through the module for it to operate properly.

**24 VAC Power Wiring** — The Comfort Alert™ module requires a constant nominal 24 VAC power supply. The wiring to the module's R and C terminals must be directly from the indoor unit or thermostat. The module cannot be powered by the C terminal on a defrost board or other control board without experiencing nuisance alerts.

When constant 24 VAC (R wire) is not present in the outdoor unit, use one of the spare wires in the thermostat cable to bring power to the module. Connect the other end of the spare wire to R at the indoor unit or thermostat.

**Thermostat Demand Wiring** — The Comfort Alert™ module requires a thermostat demand signal to operate properly. The thermostat demand signal input, labeled Y on the module, should always be connected to the compressor contactor coil so that when the coil is energized, the demand signal input is 24 VAC when the coil is not energized, the demand signal input should be less than 0.5 VAC.

**NOTE:** Factory installed modules have different thermostat demand signal wiring. Follow manufacturer's wiring instructions when replacing module.

**NOTE:** After the thermostat demand signal is connected, verify that 24 VAC across Y and C when demand is present.

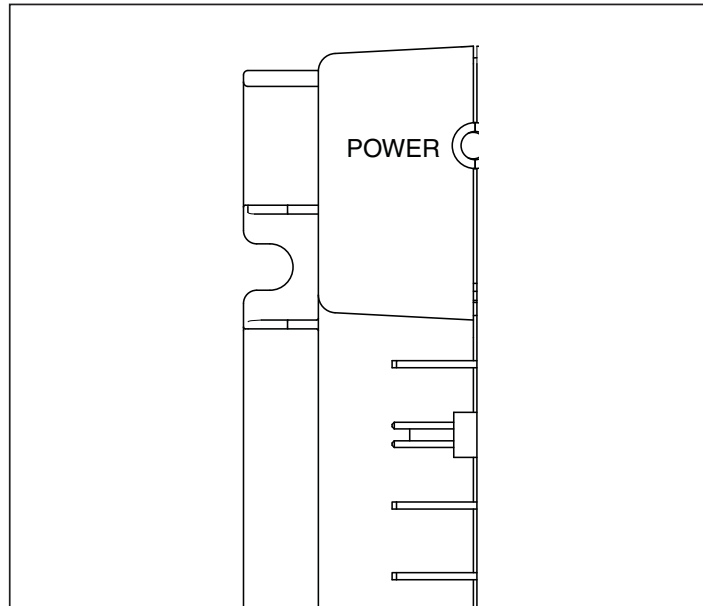

**Figure 2. Comfort Alert™ Diagnostics Module**

Status LED	Status LED Description	Status LED Troubleshooting Information
<b>Green "POWER"</b>	Module has power	Supply voltage is present at module terminals
<b>Red "TRIP"</b>	Thermostat demand signal Y is present, but the compressor is not running	<ol style="list-style-type: none"> <li>Compressor protector is open <ul style="list-style-type: none"> <li>Check for high head pressure</li> <li>Check compressor supply voltage</li> </ul> </li> <li>Outdoor unit power disconnect is open</li> <li>Compressor circuit breaker or fuse(s) is open</li> <li>Broken wire or connector is not making contact</li> <li>Low pressure switch open if present in system</li> <li>Compressor contactor has failed open</li> </ol>
<b>Yellow "ALERT" Flash Code 1</b>	<b>Long Run Time</b> Compressor is running extremely long run cycles	<ol style="list-style-type: none"> <li>Low refrigerant charge</li> <li>Evaporator blower is not running <ul style="list-style-type: none"> <li>Check blower relay coil and contacts</li> <li>Check blower motor capacitor</li> <li>Check blower motor for failure or blockage</li> <li>Check evaporator blower wiring and connectors</li> <li>Check indoor blower control board</li> <li>Check thermostat wiring for open circuit</li> </ul> </li> <li>Evaporator coil is frozen <ul style="list-style-type: none"> <li>Check for low suction pressure</li> <li>Check for excessively low thermostat setting</li> <li>Check evaporator airflow (coil blockages or return airfilter)</li> <li>Check ductwork or registers for blockage</li> </ul> </li> <li>Faulty metering device <ul style="list-style-type: none"> <li>Check TXV bulb installation (size, location and contact)</li> <li>Check if TXV/fixed orifice is stuck closed or defective</li> </ul> </li> <li>Condenser coil is dirty</li> <li>Liquid line restriction (filter drier blocked if present in system)</li> <li>Thermostat is malfunctioning <ul style="list-style-type: none"> <li>Solenoid plug not connected</li> <li>Y2 not wired at Comfort Alert</li> </ul> </li> <li>Thermostat is malfunctioning <ul style="list-style-type: none"> <li>Check thermostat sub-base or wiring for short circuit</li> <li>Check thermostat installation (location, level)</li> </ul> </li> <li>Comfort Alert failure</li> </ol>
<b>Yellow "ALERT" Flash Code 2</b>	<b>System Pressure Trip</b> Discharge or suction pressure out of limits or compressor overloaded	<ol style="list-style-type: none"> <li>High head pressure <ul style="list-style-type: none"> <li>Check high pressure switch if present in system</li> <li>Check if system is overcharged with refrigerant</li> <li>Check for non-condensable in system</li> </ul> </li> <li>Condenser coil poor air circulation (dirty, blocked, damaged)</li> <li>Condenser fan is not running <ul style="list-style-type: none"> <li>Check fan capacitor</li> <li>Check fan wiring and connectors</li> <li>Check fan motor for failure or blockage</li> </ul> </li> <li>Return air duct has substantial leakage</li> <li>If low pressure switch present in system, check Flash Code 1 information</li> </ol>
<b>Yellow "ALERT" Flash Code 3</b>	<b>Short Cycling</b> Compressor is running only briefly	<ol style="list-style-type: none"> <li>Thermostat demand signal is intermittent</li> <li>Time delay relay or control board defective</li> <li>If high pressure switch present go to Flash Code 2 information</li> <li>If low pressure switch present go to Flash Code 1 information</li> </ol>
<b>Yellow "ALERT" Flash Code 4</b>	<b>Locked Rotor</b>	<ol style="list-style-type: none"> <li>Run capacitor has failed</li> <li>Low line voltage (contact utility if voltage at disconnect is low) <ul style="list-style-type: none"> <li>Check wiring connections</li> </ul> </li> <li>Excessive liquid refrigerant in compressor</li> <li>Compressor bearings are seized <ul style="list-style-type: none"> <li>Measure compressor oil level</li> </ul> </li> </ol>

**Table 1. Interpreting the Diagnostic LEDs**

Status LED	Status LED Description	Status LED Troubleshooting Information
<b>Yellow “ALERT” Flash Code 5</b>	<b>Open Circuit</b>	<ol style="list-style-type: none"> <li>Outdoor unit power disconnect is open</li> <li>Compressor circuit breaker or fuse(s) is open</li> <li>Compressor contactor has failed open <ul style="list-style-type: none"> <li>Check compressor contactor wiring and connectors</li> <li>Check for compressor contactor failure (burned, pitted or open)</li> <li>Check wiring and connectors between supply and compressor</li> <li>Check for low pilot voltage at compressor contactor coil</li> </ul> </li> <li>High pressure switch is open and requires manual reset</li> <li>Open circuit in compressor supply wiring or connections</li> <li>Unusually long compressor protector reset time due to extreme ambient temperature</li> <li>Compressor windings are damaged <ul style="list-style-type: none"> <li>Check compressor motor winding resistance</li> </ul> </li> </ol>
<b>Yellow “ALERT” Flash Code 6</b>	<b>Open Start Circuit</b> Current only in run circuit	<ol style="list-style-type: none"> <li>Run capacitor has failed</li> <li>Open circuit in compressor start wiring or connections <ul style="list-style-type: none"> <li>Check wiring and connectors between supply and the compressor “S” terminal</li> </ul> </li> <li>Compressor start winding is damaged <ul style="list-style-type: none"> <li>Check compressor motor winding resistance</li> </ul> </li> </ol>
<b>Yellow “ALERT” Flash Code 7</b>	<b>Open Run Circuit</b> Current only in start circuit	<ol style="list-style-type: none"> <li>Open circuit in compressor run wiring or connections <ul style="list-style-type: none"> <li>Check wiring and connectors between supply and the compressor “R” terminal</li> </ul> </li> <li>Compressor run winding is damaged <ul style="list-style-type: none"> <li>Check compressor motor winding resistance</li> </ul> </li> </ol>
<b>Yellow “ALERT” Flash Code 8</b>	<b>Welded Contactor</b> Compressor always runs	<ol style="list-style-type: none"> <li>Compressor contactor has failed closed</li> <li>Thermostat demand signal not connected to module</li> </ol>
<b>Yellow “ALERT” Flash Code 9</b>	<b>Low Voltage</b> Control circuit < 17VAC	<ol style="list-style-type: none"> <li>Control circuit transformer is overloaded</li> <li>Low line voltage (contact utility if voltage at disconnect is low) <ul style="list-style-type: none"> <li>Check wiring connections</li> </ul> </li> </ol>

- Flash Code number corresponds to a number of LED flashes, followed by a pause and then repeated.
- TRIP and ALERT LEDs flashing at same time means control circuit voltage is too low for operation.

**Table 1. Interpreting the Diagnostic LEDS (Cont.)**

**Cooling** — Gradually lower the thermostat temperature setpoint below the actual room temperature and observe that the outdoor unit and indoor blower energize. Feel the air being circulated by the indoor blower and verify that it is cooler than ambient temperature. Listen for any unusual noises. If present, locate and determine the source of the noise and correct as necessary.

**Heating** — If provided with heating equipment, lower the thermostat setpoint temperature to the lowest obtainable setting and set the thermostat function switch to HEATING. The outdoor unit should stop running. The indoor blower will go off after the preprogrammed delay. Increase the setpoint temperature of the thermostat to

the maximum setting. Verify that the heating equipment has been energized (i.e., fossil fuel burner operating, etc.) and that the indoor blower energizes after a short period of time. Feel the air being circulated by the indoor blower and verify that it is warmer than ambient temperature. Listen for any unusual noises. If present, locate and determine the source of the noise and correct as necessary.

**NOTE:** Other sources for heating (i.e.: electric furnace, fossil fuel furnace, air handler with electric heat options, etc.) that interface with the heat pump should be functionally checked to verify system operation and compatibility with the heat pump. Refer to the installation instructions for this equipment and perform a functional

Miswired Module Indication	Recommended Troubleshooting Action
Green LED is not on, module does not power up	Determine if both R and C module terminals are connected. Verify voltage is present at module's R and C terminals. Review <b>24VAC Power Wiring</b> (page 4) for R and C wiring.
Green LED intermittent, module powers up only when compressor runs	Determine if R and Y terminals are wired in reverse. Verify module's R and C terminals have a constant source. Review <b>24VAC Power Wiring</b> (page 4) for R and C wiring.
TRIP LED is on but system and compressor check OK	Verify Y terminal is connected to 24VAC at contactor coil. Verify voltage at contactor coil falls below 0.5VAC when off. Verify 24 VAC is present across Y and C when thermostat demand signal is present. If not, R and C are reverse wired.
TRIP LED and ALERT LED flashing together	Verify R and C terminals are supplied with 19-28VAC.
ALERT Flash Code 3 (Compressor Short Cycling) displayed incorrectly	Verify Y terminal is connected to 24VAC at contactor coil. Verify voltage at contactor coil falls below 0.5VAC when off.
ALERT Flash Code 5, 6 or 7 (Open Circuit, Open Start Circuit or Open Run Circuit) displayed incorrectly	Check that compressor run and start wires are through module's current sensing holes. Verify Y terminal is connected to 24VAC at contactor coil. Verify voltage at contactor coil falls below 0.5VAC when off.
ALERT Flash Code 6 (Open Start Circuit) displayed for Code 7 (Open Run Circuit) or vice versa	Check that compressor run and start wires are routed through the correct module sensing holes.
ALERT Flash Code 8 (Welded Contactor) displayed incorrectly	Determine if module's Y terminal is connected. Verify Y terminal is connected to 24VAC at contactor coil. Verify 24VAC is present across Y and C when thermostat demand signal is present. If not, R and C are reverse wired. Verify voltage at contactor coil falls below 0.5VAC when off. Review <b>Thermostat Demand Wiring</b> (page 4) for Y and C wiring.

**Table 2. Module Wiring Troubleshooting**

checkout in accordance with the manufacturer's instructions.

**Optional Equipment** — A functional checkout should be performed in accordance with the checkout procedures supplied with the equipment.

**Defrost Cycle Timer** — The defrost cycle timer controls the time interval of the hot gas defrost after the defrost sensor closes. It is located in the lower left corner of the defrost control board. Three interval settings are available: 30 minutes, 60 minutes, and 90 minutes. Time setting selection is dependent on the climate where the unit is being installed.

Example 1. Dry climate of Southern Arizona. A 90 minute setting is recommended.

Example 2. Moist climate of Seattle, Washington. A 30 minute setting is recommended.

To set the cycle timer, place the timing pin on the defrost control board to the desired time interval post.

Please note that when the defrost cycle initiates via the sensor, there will be a 30 second compressor delay going into and out of the defrost cycle. Please note that when initializing defrost

through the test function, this delay is cancelled and the compressor will not de-energize. This 2-stage unit will defrost in whichever stage is called for by the thermostat. If only Y1 is energized, then the unit will defrost in low stage. If Y1 and Y2 are energized, the unit will defrost in high stage.

**Note:** All units are shipped from the factory with the default time setting of 30 minutes. Maximum heating performance can be achieved by setting the time to 90 minutes.

## DEFROST CONTROL BOARD OPERATION AND TESTING

1. Terminals “R”-“C” must have 24±V present between them in order for the time delay and defrost sequences to be operational.
2. Jumper the “T2”-“DFT” test pins. This will indicate to the board that the defrost T-stat is closed (if the compressor is running). Defrost T-stat is closed at 32° or below and is open at 68° or above. But its state is unknown if the temperature is between 32°F and 68°F. The defrost thermostat tells the board whether a defrost cycle needs to be started or terminated. With the DFT closed the unit will run for 30/60/90 minutes in heat mode and then defrost the outdoor coil. The defrost will turn off the outdoor fan, turn on the compressor and raise the coil temperature to 68°F. This will open the DFT and terminate the defrost. If the DFT does not open the defrost will end after 10 minutes.
3. Defrost board speed-up. With compressor running in heat mode, next jump the “Test” pin to “C” on terminal strip. This will initiate a defrost test in 5, 10 or 15 seconds (This is determined by the 30, 60 or 90 minute defrost pin settings. The factory setting will be 30 minutes). Note that this will bypass the compressor off delay when the unit goes into defrost test and if left in defrost test, the delay will be bypassed when the test is terminated by the processor. If the jumper is removed before the test is over the processor will perform the remainder of a normal defrost. See step 2 above.

4. Remove the jumpers.

**Note:** The delay/no-delay pin concerns compressor operation during defrosts. The default setting is delay. Reciprocating compressors should only use this setting in conjunction with an approved hard start kit. Scroll compressors that have noise issues while going into or coming out of defrost should use this 30 second delay to reduce the defrost noise. To switch from no-delay to delay remove the pin from the “no-delay” pin location and shift it to the “delay” pin location.

Speed up changes:

Manually initiating a defrost will cause the compressor to run continually when entering defrost.

Normal defrost operation:

To test normal defrost operation when the temperature is above 35°F, jumper “R” to “DFT” on the 624656 board and allow the unit to run for 30 minutes. Defrost will continue until the “R” to “DFT” jumper is removed or for 10 minutes. Remove the jumper.

The 5 minute time delay feature can be shortened 1 time to 1 second by jumping the “Test” to “C” terminal. Remove the jumper and repeat as desired.

Note: If jumper is left on the “Test” to “common” pins permanently, the defrost cycle will become inoperable.

### Defrost Test Procedure for 624656

1. Jumper “T2” to “DFT” at the test terminals.
2. With unit running in heat mode, short the “TEST” terminal to the common terminal near it. This will speed up the board and cause it to enter defrost mode in 5/10/15 seconds depending on the defrost time selection. Compressor delay will not function during speed-up.
3. This test will end in 5 seconds if the “TEST”-common short is not removed.
4. Remove both the short and the “T2” to “DFT” jumper to terminate the defrost cycle. The 30 second compressor delay should operate normally.
5. Test is complete, reset thermostat to home owner preference.

## Adjustment of Refrigerant Charge:

### **CAUTION:**

**Split system heat pump equipment contains liquid and gaseous refrigerant under pressure. Adjustment of refrigerant charge should only be attempted by qualified, trained personnel thoroughly familiar with the equipment. Under no circumstances should the homeowner attempt to install and/or service this equipment. Failure to comply with this warning could result in equipment damage, personal injury, or death.**

**NOTE:** The unit must be charged while both first and second stages are operating.

**NOTE:** To achieve rated capacity and efficiency the compressor must be exposed to refrigerant for at least 24 hours prior to running and then must be run for a minimum of 12 hours.

**NOTE:** The following Refrigerant Charging Charts are applicable to listed assemblies of equipment and at listed airflows for the indoor coil. Assemblies of indoor coils and outdoor units not listed are not recommended.

<b>Tonnage</b>	<b>System Charge R-410A oz.</b>
2 Ton	208
3 Ton	272
4 Ton	272
5 Ton	272

**Table 3. Split System  
Heat Pump Charge**

## Procedure for charging an R-410A unit in AC mode at outdoor temperatures above 65F.

1. With the system operating at steady-state, measure the liquid refrigerant pressure in psig at the service valve.
2. Measure the liquid refrigerant temperature in Fahrenheit at the service valve.
3. For the temperature measured, determine the required liquid refrigerant pressure from the appropriate charging chart below.
4. If the pressure measured in step 1 is greater than the required liquid refrigerant pressure determined in step 4, then there is too much charge in the system. Remove refrigerant and repeat steps 1 through 3 until the system is correctly charged.
5. If the pressure measured in step 1 is less than the required liquid refrigerant pressure determined in step 4, then there is too little charge in the system. Add refrigerant and repeat steps 1 through 3 until the system is correctly charged.

## Procedure for charging an R-410A unit in heating mode.

1. Evacuate the refrigerant system.
2. Weigh in the proper charge per Table 3 of these installation instructions.
3. Ensure that the unit is operating properly per the heating functional checkout in these installation instructions.

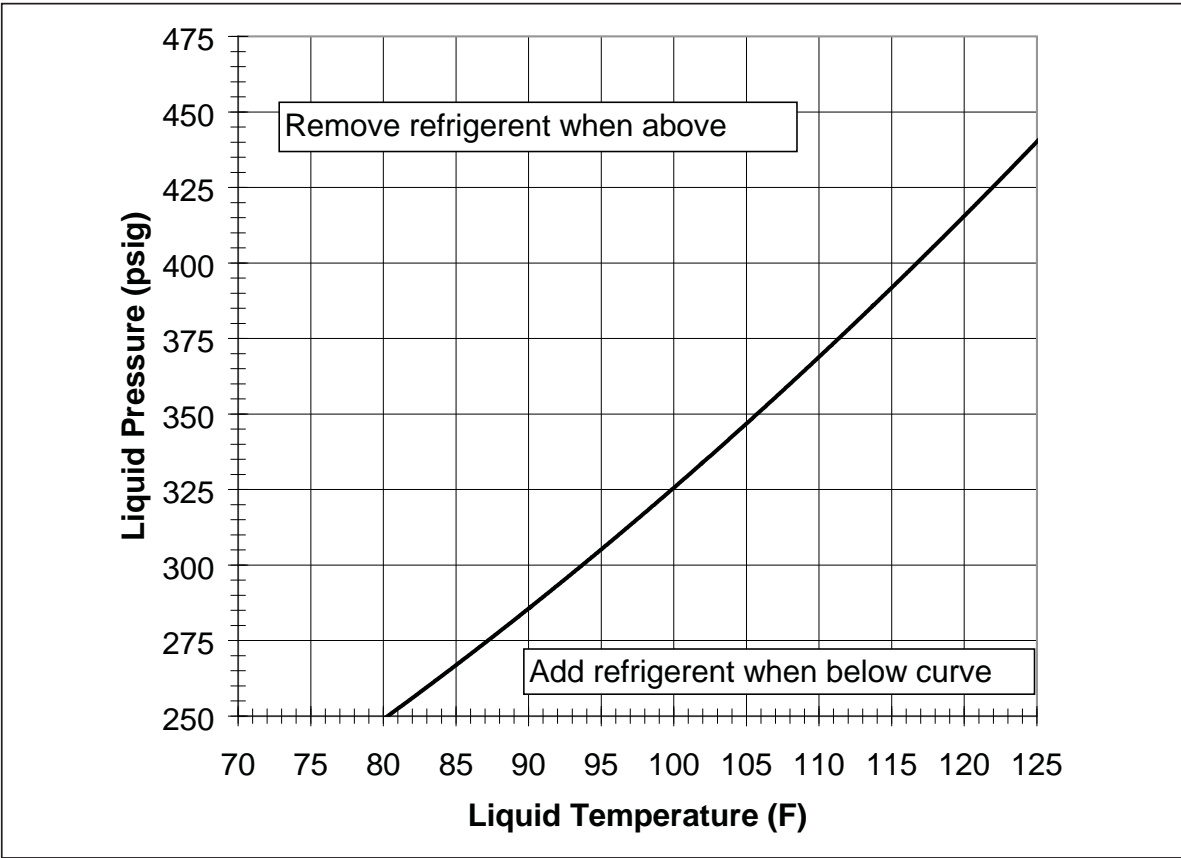

Figure 3. Charging Chart for 2 ton R-410A HP unit in cooling mode with TXV

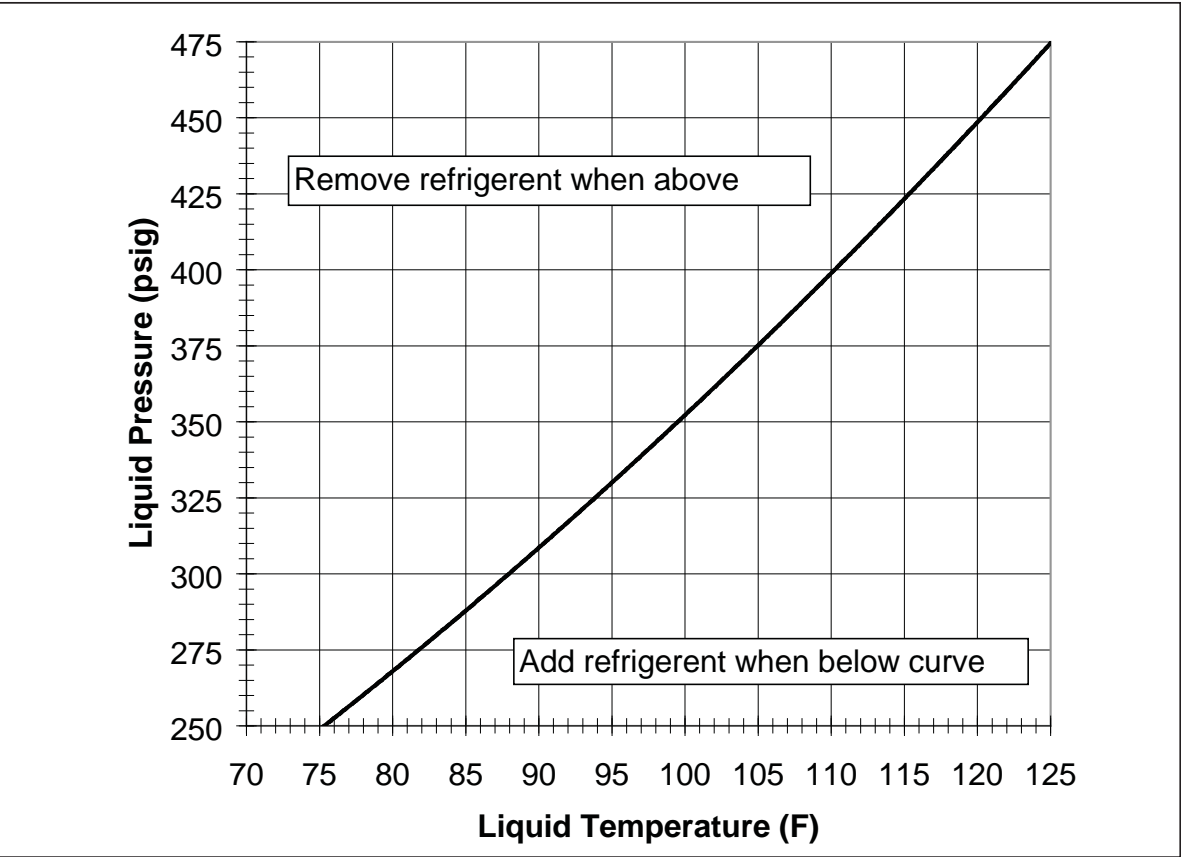

Figure 4. Charging Chart for 3 ton R-410A HP unit in cooling mode with TXV

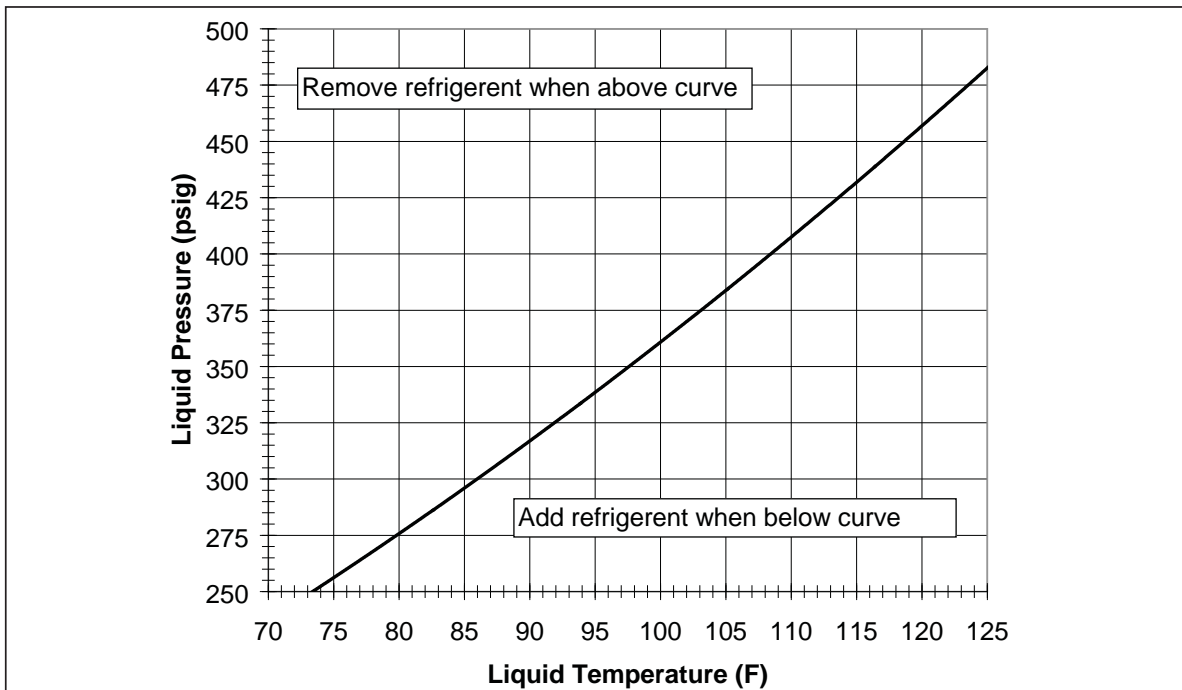

Figure 5. Charging Chart for 4 ton R-410A HP unit in cooling mode with TXV

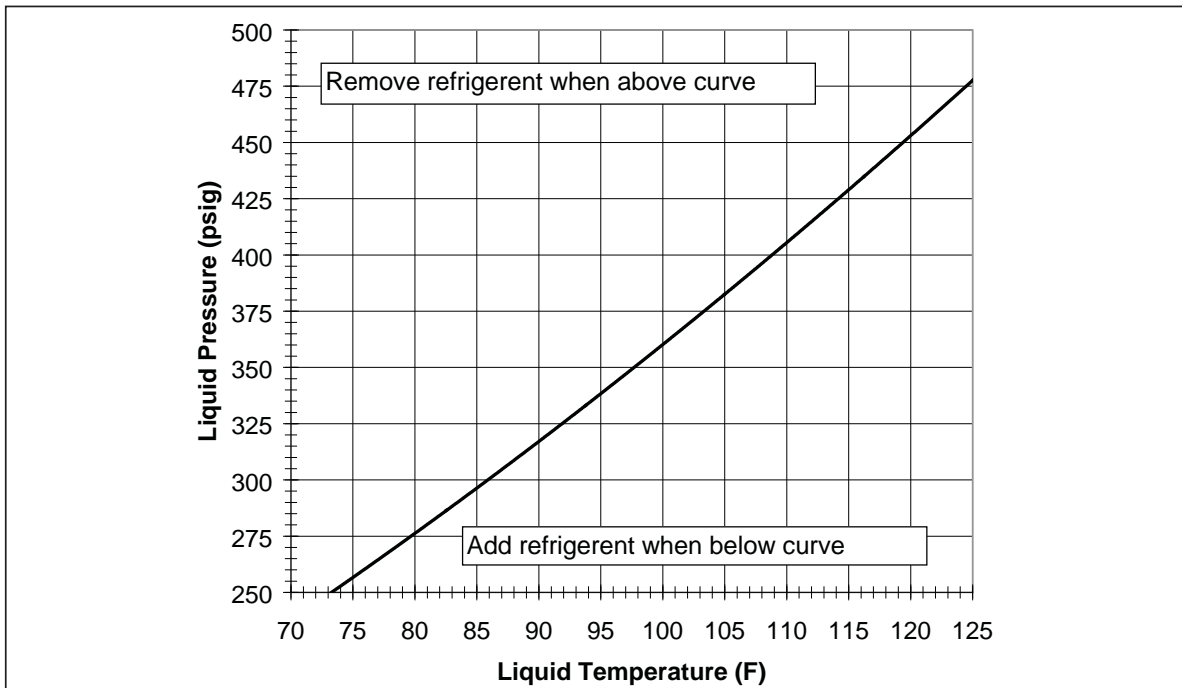

Figure 6. Charging Chart for 5 ton R-410A HP unit in cooling mode with TXV

**INSTALLER: PLEASE LEAVE THESE  
INSTALLATION INSTRUCTIONS  
WITH THE HOMEOWNER.**



**708367B**



**708367B** (Replaces 708367A)

Specifications and illustrations subject to change without notice and without incurring obligations.

Printed in U.S.A. (08/05)