

B4VM-E

INSTALLATION INSTRUCTIONS

AIR HANDLER

iQDrive Series



IMPORTANT

Please read all information in this manual thoroughly and become familiar with the capabilities and use of your appliance before attempting to operate or maintain this unit. These instructions are primarily intended to assist qualified individuals experienced in the proper installation of this appliance. Installer should be specifically trained to install and setup an iQ system. Some local codes require licensed installation / service personnel for this type of equipment. Improper installation, service, adjustment, or maintenance may cause explosion, fire, electrical shock or other hazardous conditions which may result in personal injury or property damage.

Unless otherwise noted in these instructions, only factory authorized kits or accessories may be used with this product. Keep this manual where you have easy access to it in the future. If a problem occurs, check the instructions and follow recommendations given. If these suggestions don't eliminate your problem, call your servicing contractor.

**DO NOT DESTROY. PLEASE READ CAREFULLY AND
KEEP IN A SAFE PLACE FOR FUTURE REFERENCE.**

TABLE OF CONTENTS

Important Safety Information	2
Requirements & Codes	3
General Information	4
Before You Install this Unit	4
Locating the Air Handler	4
Minimum Clearances	4
Operation of Air Handler During Construction	4
Installation in a Garage	5
Plenums & Air Ducts	5
Unconditioned Spaces	5
Air Filters	5
Acoustical Duct Work	5
Air Handler Installation	6
Packaging Removal	6
Mounting Applications	6
Upflow Installations	6
Downflow Installations	6
Horizontal Installations	7
Horizontal Left Installations	7
Horizontal Right Installations	7
Refrigerant Line Connections	8
Connecting the Linesets	9
Condensate Drainage	9
Electrical Connections	9
Pre-Electrical Checklist	10
Line Voltage	10
Grounding	10
Thermostat Connections	10
Control Board	10
Twinning	10
Heater Kits	10
Electronic Air Cleaner	10
Startup & Adjustments	12
Before You Start the Unit	12
Refrigerant Charging	12
Air Circulation	12
Running the Blower Continuously	12
Turning the Blower Off	12
System Cooling	12
System Heating	12
Blower Settings	13
Dehumidification	13
Unit Maintenance	13
Troubleshooting	13
Figures & Tables	14
Table 3. B4BM Physical Dimensions	14
Figure 9. Air Handler Components	15
Figure 10. X13 Motor Control Board	16
Figure 11. EXV Control Board	16
Figure 12. B4VM-E Wiring Diagram	17
Installation / Performance Checklist	20

IMPORTANT SAFETY INFORMATION

INSTALLER: Please read all instructions before servicing this equipment. Pay attention to all safety warnings and any other special notes highlighted in the manual. Safety markings are used frequently throughout this manual to designate a degree or level of seriousness and should not be ignored. **WARNING** indicates a potentially hazardous situation that if not avoided, could result in personal injury or death. **CAUTION** indicates a potentially hazardous situation that if not avoided, may result in minor or moderate injury or property damage.

WARNING:

ELECTRICAL SHOCK, FIRE OR EXPLOSION HAZARD

Failure to follow safety warnings exactly could result in serious injury or property damage.

Improper servicing could result in dangerous operation, serious injury, death or property damage.

- Before servicing, disconnect all electrical power to air handler.
- When servicing controls, label all wires prior to disconnecting. Reconnect wires correctly.
- Verify proper operation after servicing.

WARNING:

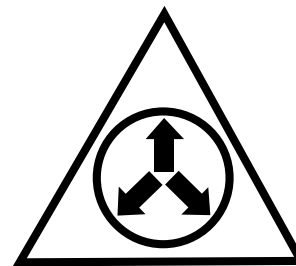

NITROGEN	
HEALTH	1
FLAMMABILITY	0
REACTIVITY	0
0 Minimal Hazard 1 Slight Hazard	

B4VM-E Series Air Handlers leave the factory with a nitrogen holding charge. Use caution when preparing coils for field connections. If repairs make it necessary for evacuation and charging, it should only be attempted by qualified, trained personnel thoroughly familiar with this equipment. Some local codes require licensed installation service personnel to service this type of equipment. Under no circumstances should the equipment owner attempt to install and/or service this equipment. Failure to comply with this warning could result in equipment damage, personal injury, or death.

REQUIREMENTS & CODES

WARNING:

This unit must be installed in accordance with instructions outlined in this manual during the installation, service, and operation of this unit. Unqualified individuals should not attempt to interpret these instructions or install this equipment. Failure to follow safety recommendations could result in possible damage to the equipment, serious personal injury or death.

- The installer must comply with all local codes and regulations which govern the installation of this type of equipment. Local codes and regulations take precedence over any recommendations contained in these instructions. Consult local building codes for special installation requirements.
- This equipment contains nitrogen gas. Installation or servicing should only be performed by qualified trained personnel thoroughly familiar with this type equipment.
- All electrical wiring must be completed in accordance with local, state and national codes and regulations and with the National Electric Code (ANSI/NFPA 70) or in Canada the Canadian Electric Code Part 1 CSA C.22.1.
- Installation of equipment may require brazing operations. Installer must comply with safety codes and wear appropriate safety equipment (safety glasses, work gloves, fire extinguisher, etc.) when performing brazing operations.
- Install this unit only in a location and position as specified on pages 4 & 5. This unit is designed only for Indoor installations and should be located with consideration of minimizing the length of the supply and return ducts.
- Follow all precautions in the literature, on tags, and on labels provided with the equipment. Read and thoroughly understand the instructions provided with the equipment prior to performing the installation and operational checkout of the equipment.
- This air handler may be used for temporary heating of buildings or structures under construction. See the guidelines listed on page 4.
- Air handler installations in a residential garage must be installed as specified on page 5.

The information listed below is for reference purposes only and does not necessarily have jurisdiction over local or state codes. Always consult with local authorities before installing any gas appliance.

Duct Systems

- US and CANADA: Air Conditioning Contractors Association (ACCA) Manual D, Sheet Metal and Air Conditioning Contractors National Association (SMACNA), or American Society of Heating, Refrigeration, and Air Conditioning Engineers (ASHRAE) Fundamentals Handbook

Electrical Connections

- US: National Electrical Code (NEC) ANSI/NFPA 70
- CANADA: Canadian Electrical Code CSA C22.1

Safety

- US: (NFGC) NFPA 54–1999/ANSI Z223.1 and the Installation Standards, Warm Air Heating and Air Conditioning Systems ANSI/NFPA 90B.
- CANADA: CAN/CGA-B149.1 and .2–M00 National Standard of Canada. (NSCNGPIC)

GENERAL INFORMATION

This appliance has been tested for capacity and efficiency in accordance with AHRI Standards and will provide many years of safe and dependable comfort, providing it is properly installed and maintained. Abuse, improper use, and/or improper maintenance can shorten the life of the appliance and create unsafe hazards. Please read all instructions before installing the unit.

Before You Install this Unit

- √ This equipment is securely packaged at the time of shipment and upon arrival should be carefully inspected for damage prior to installing the equipment at the job site. Claims for damage (apparent or concealed) should be filed immediately with the carrier.
- √ The cooling load of the area to be conditioned must be calculated and a system of the proper capacity selected. It is recommended that the area to be conditioned be completely insulated and vapor sealed.
- √ Check the electrical supply and verify the power supply is adequate for unit operation. The system must be wired and provided with circuit protection in accordance with local building codes. If there is any question concerning the power supply, contact the local power company.
- √ Verify the static pressure drop of the coil, filter, and duct work do not exceed the air delivery specs of the air handler.

Locating the Air Handler

- Survey the job site to determine the best location for mounting the unit. Consideration should be given to availability of electric power, service access, and noise.
- The dimensions of the room or alcove must be able to accommodate the overall size of the unit and the installation clearances listed in Figure 1. Physical dimensions for this air handler are also shown in Table 3 (page 14).
- The air handler should be installed before routing the refrigerant tubing.

Minimum Clearances

- This appliance must be installed in accordance with clearances listed in Figure 1. The air handler must be installed with ample clearance for easy access to the air filter, blower assembly, heater assembly, controls, and vent connections.
- Sufficient clearance for unobstructed airflow through a louvered door must be maintained in order to achieve rated performance.

Operation of Air Handler During Construction

⚠ CAUTION:

Failure to follow these instructions will void the factory warranty and may significantly reduce the life or the performance of the air handler, and/or result in other unsafe conditions. It is the responsibility of the installing contractor to insure these provisions are met.

Operating an air handler in a construction environment can cause the appliance a variety of problems. Proper use of commercial portable space heating equipment during construction is recommended. This air handler may be used during construction if it is not in violation of any applicable codes and the following criteria are met:

- The installation must meet all applicable codes and be permanently installed according to the instructions supplied with the air handler. This includes electrical supply, gas supply, and duct work.
- The air handler must be controlled by a properly installed thermostat that complies with the current provisions of the NEC (ANSI/NFPA 70) and all applicable codes having jurisdiction. Thermostat connections must be made in accordance with instructions supplied with the air handler and thermostat. See page 10.
- The installation must include a properly installed filter in the return air system with no by-pass air. The filter must be inspected frequently and replaced when necessary.
- Return air must be supplied unrestricted and located such that dust and gases from construction activity are not introduced into the circulating air system.
- Before occupying the structure: The filter must be replaced or cleaned, the duct work must be inspected and cleaned of any construction debris, and the air

INSTALLATION CLEARANCES	
Left Side..... 0 Inches	Right Side 0 Inches
Back..... 0 Inches	Front..... †See Notes
	
<p style="text-align: center;">†NOTES:</p> <p><u>Alcove Installations</u> - Allow 24 in. minimum clearance from front of unit to nearest wall or partition for servicing. Recommended clearance is 36 in.</p> <p><u>Closet installations</u> - require a return air grill installed in the door or a partially louvered door across the opening for proper air circulation. For clearances 6" or greater, the closet must have an open free area of 235 in² minimum. For special clearances between 1" - 5", requirements are a louvered door with a minimum of 250 in² (1613 cm²) free area. A fully louvered closet door is strongly recommended for both installation types.</p>	

Figure 1. Minimum Unit Clearances

handler must be cleaned and/or repaired if found to be dirty, damaged, or malfunctioning in any way by a qualified HVAC technician. The air handler shall be inspected and approved by applicable local authority even if this requires redundant inspections.

- The serial number for the air handler used during construction must be submitted in writing (fax and email also acceptable). This information will be used to track the long-term affects of air handler usage during construction. Proof of this submittal shall be available for the final inspection of the air handler prior to occupancy.

Installation in a Garage

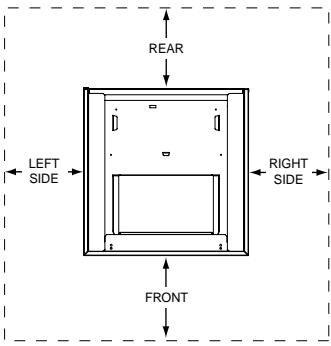
WARNING:

Do not place combustible materials on or against the cabinet. Do not place flammable materials, (gasoline, paint thinners, etc.) or any other flammable vapors and liquids, in the vicinity of the air handler.

The B4VM-E Series air handler may be installed in a residential garage with the provision that the unit must be located or protected to prevent physical damage by vehicles.

Plenums & Air Ducts

- Plenums and air ducts should be installed in accordance with the standards of the National Fire Protection Association Standard for Installation of Air Conditioning Systems (NFPA 90A), Standard for Installation of Residence Type Warm Air Heating and Air Conditioning Systems (NFPA 90B), and all applicable local codes.
- NFPA publications are available by writing to: National Fire Protection Association, Batterymarch Park, Quincy, ME 02269 or visit www.NFPA.org online.

WARNING:

All return ducts must be secured to the air handler using appropriate methods. All return ducts must be adequately sealed. When return air is provided through the bottom of the unit, the joint between the air handler and the return air plenum must be air tight.

Return air and circulating air ducts must not be connected to any other heat producing device such as a fireplace insert, stove, etc. This may result in fire, explosion, carbon monoxide poisoning, personal injury, or property damage.

- Design the duct work according to methods described by the Air Conditioning Contractors of America (ACCA).
- This unit is designed only for use with a return and supply duct. The return air duct must have the same free area as the opening provided on the blower coil unit. The

ducts should be appropriately sized to the capacity of the air handler to ensure its proper airflow rating.

- Use transition fittings if the supply and/or return air openings of the unit do not match the duct openings. These transitions should be dimensioned in accordance with standard practice as specified in the ASHRAE recommendations for duct transitions.
- Flexible connectors should be used between the unit and the ductwork to prevent transmission of vibration from the unit to the structure. If electric heater kits are installed, heat resistant material must be used for the flexible connector at the supply air end of the unit.
- It is good practice to seal all connections and joints with industrial grade sealing tape or liquid sealant. Requirements for sealing ducts vary from region to region. Consult with local codes for requirements specific to your area.

Unconditioned Spaces

All duct work passing through unconditioned space must be properly insulated to minimize duct losses and prevent condensation. Use insulation with an outer vapor barrier. Refer to local codes for insulation material requirements.

Air Filters

B4VM-E Series Air Handlers are not supplied with an air filter when shipped from the factory. The installer must provide a high velocity filter that is appropriately sized to the return air duct opening or filter rack located in the bottom of the unit. Accessing the filter does not require tools and can be removed from the front of the unit by removing the filter door. See Unit Maintenance (page 13) for filter sizes and installation information.

WARNING:

Never operate the air handler without a filter or with doors removed. Dust and lint can build up on internal components, resulting in loss of efficiency, equipment damage, and possible fire.

Acoustical Duct Work

- Certain installations may require the use of acoustical lining inside the supply duct work. Acoustical insulation must be in accordance with the current revision of the Sheet Metal and Air Conditioning Contractors National Association (SMACNA) application standard for duct liners. Duct lining must be UL classified batts or blankets with a fire hazard classification of FHC-25/50 or less.
- Fiber duct work may be used in place of internal duct liners if the fiber duct work is in accordance with the current revision of the SMACNA construction standard on fibrous glass ducts. Fibrous duct work and internal acoustical lining must be NFPA Class 1 air ducts when tested per UL Standard 181 for Class 1 ducts.
- Damping ducts, flexible vibration isolators, or pleated media-style filters on the return air inlet of the air handler may be used to reduce the transmission of equipment

noise emanating from the air handler. These treatments can produce a quieter installation, particularly in the heated space. However, they can increase the pressure drop in the duct system. Care must be taken to maintain the proper maximum pressure differential across the air handler, temperature rise and flow rate. This may mean increasing the duct size and/or reducing the blower speed. These treatments must be constructed and installed in accordance with NFPA and SMACNA construction standards. Consult with local codes for special requirements. For best sound performance, be sure to install all the needed gaskets and grommets around penetrations into the air handler, such as for electrical wiring.

AIR HANDLER INSTALLATION

The B4VM-E Series Air Handler is shipped ready for vertical upflow installation and is approved for attic, basement, alcove/closet or crawlspace installation with zero clearance to combustibles. See Figure 1 (page 4) for required installation clearances. **This appliance is only for indoor use.**

- The unit must be leveled at installation and attached to a properly installed duct system.
- The surface that the air handler is mounted on must provide sound physical support of the unit.
- The air handler must be installed so that all electrical components are protected from water.
- If a louvered door is installed across the front of this unit, the appliance must be mounted flush or behind front edge of finished wall.

Packaging Removal

Remove the shipping crate and User's Manual from the equipment. When removing the crate, use extra care so tubing connectios are not damaged.

Mounting Applications

Vertical only air handlers are factory ready for upflow applications. These units may be applied in downflow or horizontal left and right discharge applications when applied with the appropriate field kit.

Factory ready horizontal air handlers may be applied in upflow or horizontal-left and -right discharge applications. These units may also be applied in downflow discharge when applied with the appropriate field kit as specified in the units Technical Specifications.

Through-the-floor installations require a 1/4" thick noncombustible resilient gasket to be used whenever the supply or return air ducts pass through the floor. The gasket should be positioned between the duct, unit, and floor.

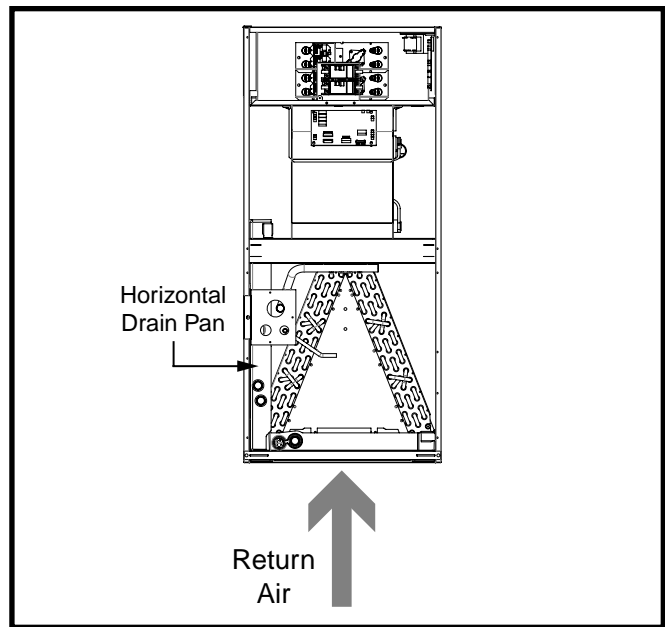

Figure 2. Upflow Installation

Upflow Installations

All air handlers are factory shipped, ready for upflow installation. The horizontal drain pan should be removed from the air handler when installing the unit in an upflow configuration. All return air must enter from the bottom of the unit. A typical upflow unit is shown in Figure 2.

Downflow Installations

The downflow accessory kit (See Technical Specifications) is required for downflow applications. Instructions for installing the downflow accessory kit are included with the kit. It is recommended that the accessory be installed prior to installing the unit. All return air in downflow applications must enter through the top of the unit. A typical installation of the unit in a downflow application is shown in Figure 3.

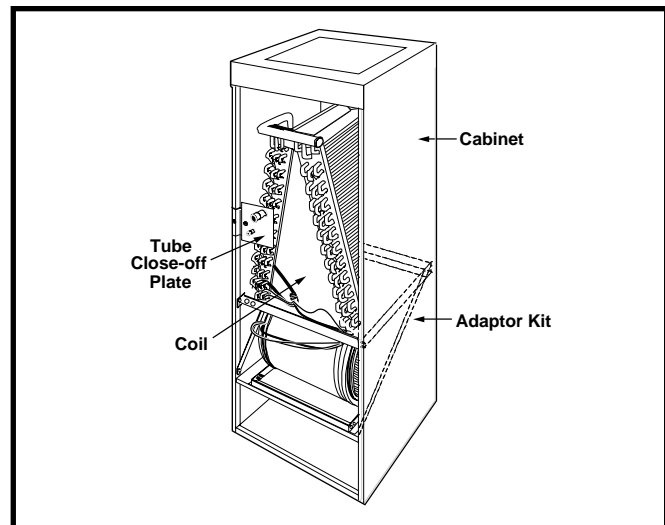

Figure 3. Downflow Installation

Horizontal Installations

The B4VM-E Series air handler can be installed horizontally in an attic, basement, crawl space or alcove. It can also be suspended from a ceiling in a basement or utility room in either a right to left airflow or left to right airflow as shown in Figure 4. Air handlers may or may not be shipped from the factory with all the parts required for horizontal left applications and horizontal right applications. If your unit does not have parts for a horizontal application, a kit is available.

NOTE: In all horizontal applications in which the unit is installed above a finished ceiling and/or living space, a secondary drain pan must be installed under the entire unit to avoid damage to the ceiling in the event of condensate overflow. Additionally, it is recommended that an approved water level indicator or float switch device be used to shut down the unit in the event water is detected in the auxiliary drain pan.

If suspending the air handler from the ceiling, assemble a support frame (Figure 5) using slotted iron channel and full threaded rod. Fasten the frame together with nuts, washers, and lockwashers. Secure the support frame to the rafters with lag bolts. The air handler can also be suspended using steel straps around each end of the unit. The straps should be attached to the air handler with sheet metal screws and to the rafters with bolts.

Horizontal Left Installations:

1. Remove the coil access door.
2. Remove the plug from one of the threaded holes in the horizontal drain pan. Completely remove the webbing located in the threaded holes of the horizontal drain pan. **IMPORTANT:** If the webbing is not removed, the condensate will not drain properly and ceiling damage may occur.
3. Insert the plug (from horizontal drain pan) into the open and unused drain hole in the drain pan at the bottom of the unit to block bypass air.

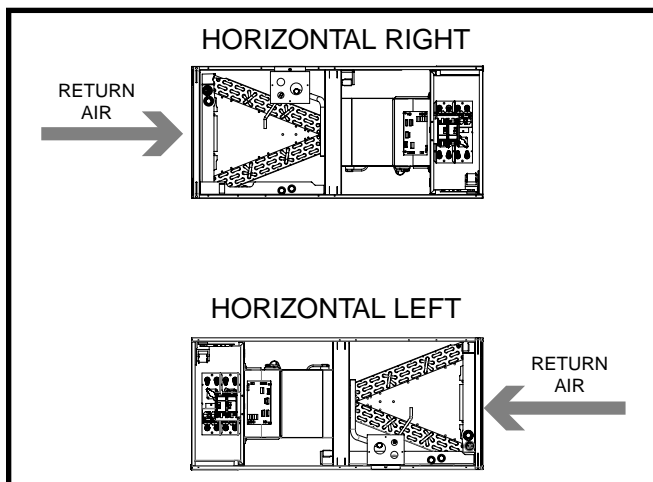

Figure 4. Horizontal Configurations

4. Remove the corresponding drain line knockout from the coil access door to allow access to the horizontal drain.
5. Replace the door and attach the drain line.

Horizontal Right Installations:

The unit may also be installed in a horizontal application with the unit suspended from the ceiling. A typical installation of the unit in a suspended horizontal application is shown in Figure 5.

1. Remove the coil access door. Unscrew the line-set tube close-off plate from the front left cabinet rail.
2. Slide the coil and drain pan assembly out of the unit.
3. Remove the sheet metal hairpin covers (if supplied) from the back of the coil and discard.
4. Place the horizontal drain pan on the opposite side of the coil. On units with 2 sets of knockouts, remove the other set of knockouts in the coil spacing plates and insert support rod.
5. Slide the coil and the horizontal drain pan assembly back into the unit. Re-attach the tube close off plate.
6. Remove the plug from one of the threaded holes in the horizontal drain pan. Completely remove the webbing located in the threaded holes of the drain pan. **IMPORTANT:** If the webbing is not removed, the condensate will not drain properly and ceiling damage may occur.
7. Insert the plug (from horizontal drain pan) into the open and unused drain hole in the drain pan at the bottom of the unit to block bypass air.
8. Remove the corresponding drain line knockout from the coil access door to allow access to the horizontal drain.
9. Replace the door and attach the drain line.

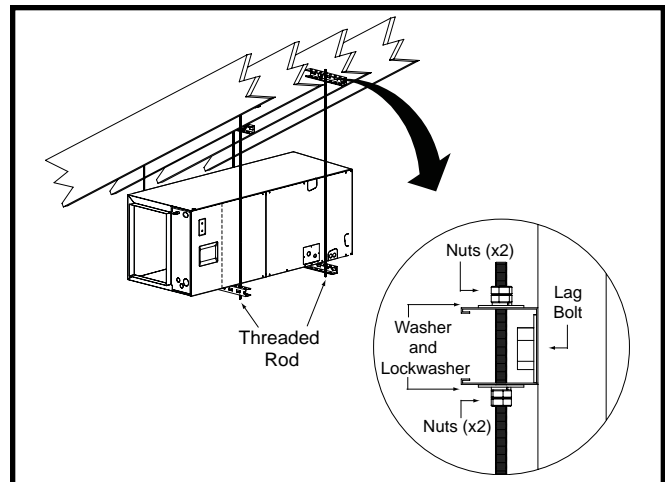
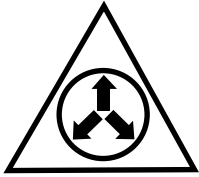

Figure 5. Unit Horizontally Suspended

⚠ WARNING:



NITROGEN	
HEALTH	1
FLAMMABILITY	0
REACTIVITY	0
0 Minimal Hazard 1 Slight Hazard	

The coil in the air handler is factory shipped with a nitrogen charge. Avoid direct face exposure or contact with valve when gas is escaping. Always ensure adequate ventilation is present during the depressurization process. Address any uncertainties before proceeding. Failure to comply with this warning could result in equipment damage, personal injury, or death.

⚠ CAUTION:

This unit uses refrigerant R-410A. DO NOT use any other refrigerant in this unit. Use of another refrigerant will damage the unit.

- The installer should make every effort to ensure the field installed refrigerant containing components of the system have been installed in accordance with these instructions and sound installation practices for reliable system operation and longevity.
- The air handler coil does not contain a refrigerant charge. Refer to the installation instructions supplied with the outdoor unit for refrigerant charge information.
- Always refer to the installation instructions supplied with the outdoor unit for piping requirements. The suction and liquid lines must be sized in accordance with the condensing unit specifications. See Table 3 (page 14) for liquid and suction line locations.
- When connecting refrigerant linesets together, it is recommended that dry nitrogen be flowing through the joints during brazing. This will prevent internal oxidation and scaling from occurring.
- Refrigerant tubing should be routed in a manner that minimizes the length of tubing and the number of bends in the tubing. It should be supported in a manner that prevents it from vibrating or abrading during system operation. Tubing should be kept clean of foreign debris during installation.
- If precise forming of refrigerant lines is required, a copper tubing bender is recommended. Avoid sharp bends and contact of the refrigerant lines with metal surfaces.
- Refrigerant lines should be wrapped with pressure sensitive neoprene or other suitable material where they pass against sharp sheet metal edges.

⚠ CAUTION:

Before brazing the air handler, remove the core from the service port. Failure to comply may result in leakage at the service valve. Replace the core and cap once brazing is complete.

- B4VM-E Series air handlers are charged through service valves on the end of the liquid tube for each circuit. These must be removed before brazing the line sets.

Connecting the Linesets

1. Remove grommets from line set holes.
-

⚠ CAUTION:

To protect the Thermistor and EXV, it is recommended that a wet rag be wrapped around the suction line in front of the close off plate before applying heat. Failure to keep components cool during brazing may result in structural damage, premature equipment failure, or possible personal injury.

2. Unbrazed and remove the cap on the suction line.
 3. Route and cut both lineset tubes to proper length in accordance with the outdoor unit specifications. Verify the ends are round, clean, and free of any burrs.
 4. Position grommet on line set with sufficient distance away from brazing area. Brazing processes can permanently damage grommets.
 5. Connect the suction and liquid lineset tubes.
-

⚠ CAUTION:

To protect the Thermistor and EXV, it is recommended that a wet rag be wrapped around the suction line in front of the close off plate before applying heat. Failure to keep components cool during brazing may result in structural damage, premature equipment failure, or possible personal injury.

6. Braze the individual connections with dry nitrogen flowing through the joints. **NOTE:** This will prevent internal oxidation and scaling from occurring.
7. Wrap the refrigerant lines with pressure sensitive neoprene or other suitable material especially where the lines enter the opening in the sheet metal.
8. Evacuate the system of moisture and non-condensables to prevent low efficiency operation or damage to the unit. The suggested range of evacuation is 250 - 500 microns.

9. Charge the system with refrigerant. Refer to the outdoor unit installation manual for additional charging instructions.
10. Check the system for leaks, including the lineset and the brazed joints. **NOTE:** Apply a soap and water solution on each joint or union with a small paintbrush. If bubbling is observed, the connection is not adequately sealed.
11. Replace all grommets and properly dispose of all removed parts.

Condensate Drainage

CAUTION:

The air handler must be level to ensure proper condensate drainage. An unlevel installation may result in structural damage, premature equipment failure, or possible personal injury.

- Methods for disposing of condensate vary according to local codes. Refer to local codes or authority having jurisdiction for restrictions and proper condensate disposal requirements.
- The drain pan that is supplied with this air handler contains a primary and secondary drain fitting. The condensate is drained from the unit through two 3/4" female pipe fittings located on the front side of the unit as shown in Figure 6.
- The drain pan **MUST** be drained with field supplied tubing and looped to form a trap. Both drain tubes must have

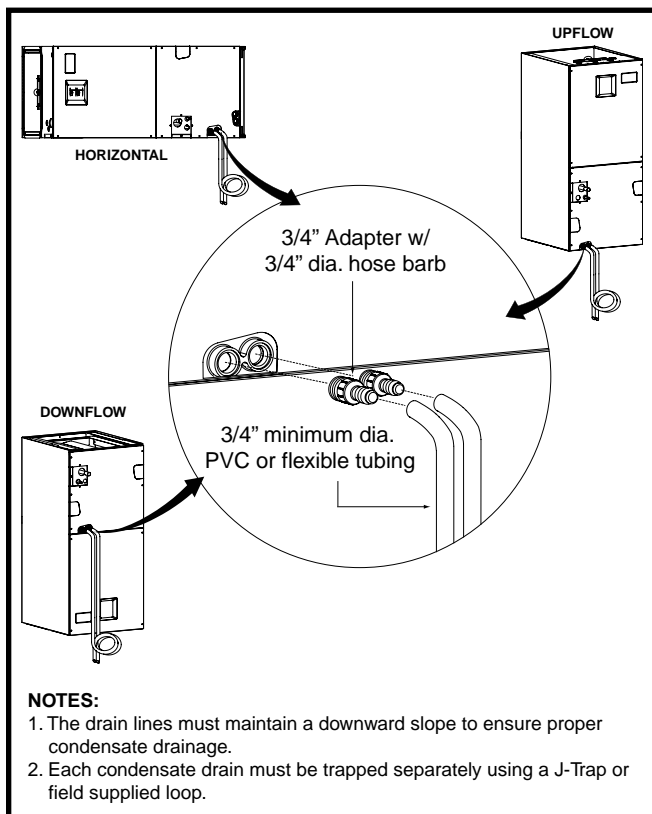

Figure 6. Condensate Drainage

a minimum diameter of 3/4" and be trapped separately. **IMPORTANT:** Failure to install a trap may result in condensation overflowing the drain pan, resulting in substantial water damage to surrounding area.

- Route both lines to a suitable drain, avoiding sharp bends and pinching of the lines. The drain should maintain a minimum horizontal slope in the direction of discharge of not less than 1" vertical for every 10 ft of horizontal run.
- If the air handler is located in or above a living space where damage may result from condensate overflow, an auxiliary drain pan shall be installed under the unit. A separate drain line should extend from the pan to a conspicuous point and serve as an alarm indicating that the primary drain is restricted. As an alternative to a separate drain line, an approved water level indicator or float switch device should be used to shut down the unit in the event water is detected in the auxiliary pan.
- Install a single 5 inch trap in the condensate drain line as close to the coil as possible. Make sure that the top of the trap is below the bottom of the drain pan to prevent the condensate from overflowing the drain pan. **NOTE:** There must be only one trap in the drain line. Using more than one trap may prevent drainage.
- Prime the trap with water. Insulate the drain if it is located in an unconditioned space, and test the condensate line for leaks. Consult local codes for additional restrictions or precautions.
- During system checkout, inspect the drain line and connections to verify proper condensate drainage.

ELECTRICAL CONNECTIONS

WARNING:

ELECTRICAL SHOCK, FIRE OR EXPLOSION HAZARD

Failure to follow safety warnings exactly could result in serious injury or property damage.

Improper servicing could result in dangerous operation, serious injury, death or property damage.

- **Before servicing, disconnect all electrical power to the air handler.**
- **When servicing controls, label all wires prior to disconnecting. Reconnect wires correctly.**
- **Verify proper operation after servicing.**

- Electrical connections must be in compliance with all applicable local codes and ordinances, and with the current revision of the National Electric Code (ANSI/NFPA 70).
- For Canadian installations, the electrical connections and grounding shall comply with the current Canadian Electrical Code (CSA C22.1 and/or local codes).

Pre-Electrical Checklist

- ✓ Verify the voltage, frequency, and phase of the supply source match the specifications on the unit rating plate.
- ✓ Verify that the service provided by the utility is sufficient to handle the additional load imposed by this equipment.
- ✓ Verify factory wiring is in accordance with the unit wiring diagram (Figure 12, page 17). Verify none of the connections loosened during shipping or installation.

Line Voltage

- **An electrical disconnect must be located within sight of and readily accessible to the unit.** This switch shall be capable of electrically de-energizing the unit. See unit data label for proper incoming field wiring. Any other wiring methods must be acceptable to authority having jurisdiction.
- It is recommended that the line voltage to the unit be supplied from a dedicated branch circuit containing the correct fuse or circuit breaker for the unit.
- Overcurrent protection must be provided at the branch circuit distribution panel and sized as shown on the unit rating label and according to applicable local codes. See the unit rating plate and Table 1 (page 11) for maximum circuit ampacity & maximum overcurrent protection limits.
- The installer should become familiar with the wiring diagram/schematic before making any electrical connections to the unit. See the unit wiring label or Figure 12.
- Use only copper wire for the line voltage power supply to this unit. Use proper code agency listed conduit and a conduit connector for connecting the supply wires to the unit. Aluminum supply wire may be used if a heater kit is installed.
- If replacing any of the original wires supplied with the unit, the replacement wire must be copper wire consisting of the same gauge and temperature rating.
- Provide power supply for the unit in accordance with the unit wiring diagram, and the unit rating plate. Use UL listed conduit and conduit connectors for connecting the supply wires to the unit and for proper grounding. Field supplied bushings for the power supply cables must be added to support and protect the power supply cables.
- All 208/230 Volt units are shipped from the factory wired for 240 volt operation. For 208V operation, remove the lead from the transformer terminal marked 240V and connect it to the terminal marked 208V.

Grounding

 **WARNING:**

The unit cabinet must have an uninterrupted or unbroken electrical ground to minimize personal injury if an electrical fault should occur. Do not use gas piping as an electrical ground!

This unit must be electrically grounded in accordance with local codes or, in the absence of local codes, with

the National Electrical Code (ANSI/NFPA 70) or the CSA C22.1 Electrical Code. Use the grounding lug provided in the control box for grounding the unit.

Thermostat Connections

- Thermostat connections shall be in accordance with the instructions supplied with the thermostat and the iQ Drive system field wiring instructions. See Figure 7 (page 11)
- The thermostat should be mounted about 5 feet above the floor on an inside wall. **DO NOT** install the thermostat on an outside wall or any other location where its operation may be adversely affected by radiant heat from fireplaces, sunlight, or lighting fixtures, and convective heat from warm air registers or electrical appliances. Refer to the thermostat manufacturer's instruction sheet for detailed mounting and installation information.
- Install the grommet, which is packed with the unit, in the hole for low-voltage wires. **NOTE:** When the low voltage wires are positioned in this grommet, the grommet will prevent chafing and/or shorting of the low voltage leads.

Control Board

The control board in the air handler controls the timing sequence of the elements. See Figures 10 & 11 (page 16). **NOTE:** Variable speed air handlers cannot be twinned.

Heater Kits

When electric heat packages with circuit breakers are field-installed, the circuit breaker may be used as a disconnecting means in most applications. Reference the NEC and local codes for disconnect requirements.

If a heater kit is installed:

The B4 air handler is shipped from the factory without an electric heater kit installed. If electric heat is desired, the H6HK heater kit may be purchased separately and field installed. Determine the correct size heater kit for your unit by referring to the list below or the units rating label.

B Cabinet..... 20Kw max
C Cabinet..... 30Kw max

1. Connect the 2 wire plug of the air handler to the mating 2 wire plug of the heater kit.
2. Connect the line voltage leads to the circuit breaker or terminal block provided.
3. Connect the heater kit plug with the mating receptacle on the air handler control board.

If a heater kit is not installed:

1. Remove the 2 wire plug of the air handler by cutting the wires and discarding the plug.
2. Strip the ends of the 2 air handler wires and connect to the line-voltage leads with the 2 wire nuts provided.

Electronic Air Cleaner (EAC)

The unit has an output to power an electronic air cleaner when the blower is running. This output is rated to 1.0 amp at 208/240V.

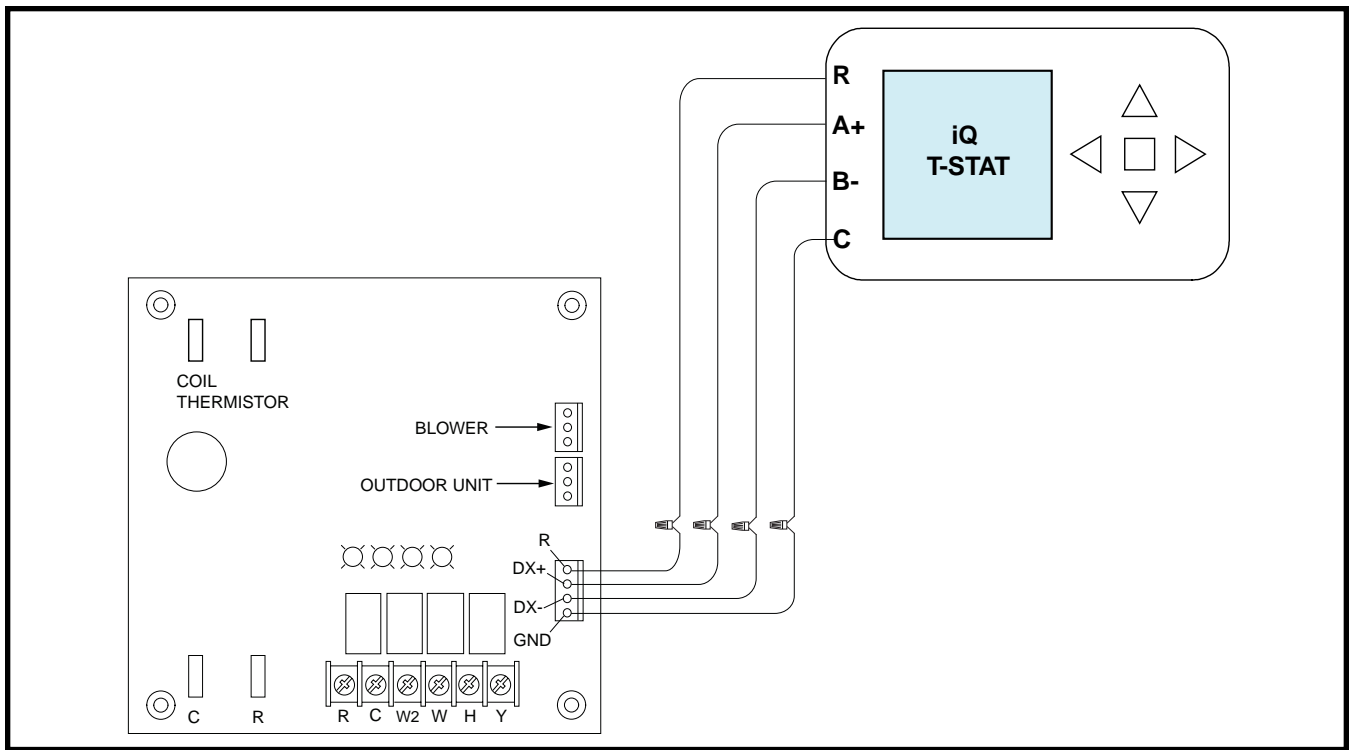

Figure 7. B4VM-E Thermostat Connection

Voltage	Aux. Heat Installed (Nom. KW)	Single Circuit		Multiple Circuit					
		MCA	MOP	MCA	MOP	MCA	MOP	MCA	MOP
				Circuit A		Circuit B		Circuit C	
240	NONE	5.8	15	5.8	15	—	—	—	—
	005H	30.8	40	30.8	40	—	—	—	—
	008H	44.8	50	44.8	50	—	—	—	—
	010H	55.8	60	55.8	60	—	—	—	—
	015H	80.8	90	55.8	60	25.0	30	—	—
	020H	105.8	125	55.8	60	50.0	60	—	—
	025H	130.8	150	55.8	60	50.0	60	25.0	30
	030H	155.8	175	55.8	60	50.0	60	50.0	60
208	NONE	5.8	15	5.8	15	—	—	—	—
	005H	27.4	30	27.4	30	—	—	—	—
	008H	39.4	40	39.4	40	—	—	—	—
	010H	49.0	50	49.0	50	—	—	—	—
	015H	70.7	80	49.0	50	21.6	25	—	—
	020H	92.3	100	49.0	50	43.3	50	—	—
	025H	113.9	125	49.0	50	43.3	50	21.6	25
	030H	135.6	150	49.0	50	43.3	50	43.3	50

Table 1. Minimum Circuit Ampacity & Maximum Overcurrent Protection

STARTUP & ADJUSTMENTS

WARNING:

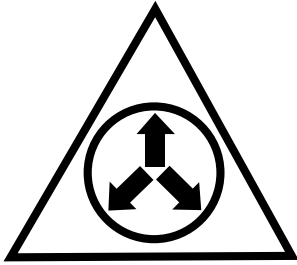

NITROGEN	
HEALTH	1
FLAMMABILITY	0
REACTIVITY	0
0 Minimal Hazard 1 Slight Hazard	

The evaporator coil is shipped from the factory with a nitrogen charge. Use caution when preparing coils for field connections. If repairs make it necessary for evacuation and charging, it should only be attempted by qualified, trained personnel thoroughly familiar with this equipment. Some local codes require licensed installation service personnel to service this type of equipment. Under no circumstances should the equipment owner attempt to install and/or service this equipment. Failure to comply with this warning could result in equipment damage, personal injury, or death.

Before You Start the Unit

Prior to start-up, complete the following inspections:

- √ Verify the unit is level and properly located with adequate clearances for servicing the unit. See Figure 1 (pg. 4).
- √ Check condensate drain line(s) for proper drainage.
- √ Verify the surrounding area and top of the unit is free from obstructions and debris.
- √ Check all duct connections. Make sure the duct work is adequately sealed to prevent air leakage.
- √ Check all coil connections for leaks.
- √ Verify that the line voltage power leads are securely connected and the unit is properly grounded. Make sure all doors are installed before restoring power to the unit
- √ Verify the thermostat is wired correctly. Make sure all low voltage wires are securely connected to the correct leads of the low voltage terminal strip.
- √ Verify the power supply branch circuit overcurrent protection is sized properly.
- √ Verify filter is properly and securely installed.

IMPORTANT: Before starting the unit, install the initial charge on units that are factory shipped with a nitrogen holding charge:

1. Read all installation instructions first.
2. Purge the nitrogen holding charge.
3. Evacuate the unit to 250 - 500 microns.
4. Allow the unit to remain under vacuum for at least 30 minutes.
5. Inspect the unit rating plate for the proper type of refrigerant and quantity.

6. Weigh in the proper amount of new (or reclaimed) refrigerant.

Refrigerant Charging

The system refrigerant charge can be checked and adjusted through the service ports provided at the front panel of the outdoor unit. Use only gauge lines which have a Schrader depression device present to actuate the valve.

Air Circulation

Running the Blower Continuously

Set the thermostat's system mode to **OFF** and the thermostat's fan mode to any speed level. The blower motor should run continuously. Check for air delivery at the register(s). Ensure that there are no obstructions at the registers or in the ducts.

NOTE: If blower is turning opposite of arrow direction, shut off main power to the unit and switch any two field wires at the disconnect. **DO NOT** alter unit wiring.

Turning the Blower Off

Set thermostat's fan mode to **AUTO**, the blower will shut down immediately.

System Cooling

1. Set the thermostat's system mode to **COOL** and fan mode to **AUTO**. Lower the thermostat's temperature mode below room temperature and observe that the blower energizes. Check the air being discharged at the register is cooler than room temperature. Verify unit refrigerant pressures are in order. Blower should be turning in direction indicated by arrow.

NOTE: DO NOT alter unit wiring. Listen for any unusual noises. Locate the source and correct as needed.

2. Allow the unit to run for several minutes and then set the thermostat's temperature above room temperature. Verify the blower cycles off with the thermostat.

System Heating

1. Set the thermostat's system mode to **HEAT** and the fan mode to **AUTO**. Increase the thermostat's temperature above room temperature and observe that the blower energizes. Check the air being discharged at the register is warmer than room temperature.
2. Allow the unit to run for several minutes and then set the thermostat's temperature below room temperature. Verify the blower cycles off with the thermostat.

Blower Settings

The iQ Drive thermostat controls the blower speed and timing to satisfy set temperatures. See iQ Drive thermostat user manual.

Dehumidification

The iQ Drive system may provide some dehumidification by lowering the airflow to increase the amount of humidity that is removed from the circulating air during cooling. See iQ Drive thermostat user manual.

UNIT MAINTENANCE

Proper maintenance is most important to achieve the best performance from a air handler. Some of the components and their locations are shown in Figure 9 (page 15). If any component of the air handler must be replaced, use only factory authorized replacement parts specified in the Replacement Parts List provided online.

WARNING:

ELECTRICAL SHOCK, FIRE OR EXPLOSION HAZARD

Failure to follow safety warnings exactly could result in serious injury or property damage.

Improper servicing could result in dangerous operation, serious injury, death or property damage.

- **Before servicing, disconnect all electrical power to air handler.**
- **When servicing controls, label all wires prior to disconnecting. Reconnect wires correctly.**
- **Verify proper operation after servicing.**

- These maintenance instructions are primarily intended to assist qualified technicians experienced in the proper maintenance and operation of this appliance.
- Always reinstall the doors on the air handler after servicing or cleaning/changing the filters. Do not operate the air handler without all doors and covers in place.
- Verify that the thermostat is properly installed and is not being affected by drafts or heat from lamps or other appliances.
- To achieve the best performance and minimize equipment failure, it is recommended that a yearly maintenance checkup be performed. At a minimum, this check should include the following items:

Air Filter(s): B4VM-E Series Air Handlers are not supplied with a single air filter when shipped from the factory. It is recommended that the filter be cleaned or replaced monthly. Newly built or recently renovated homes may require more frequent changing until the construction dust has minimized. Filter sizes shown in Table 2 are available at most local retailers.

WARNING:

Never operate the air handler without a filter in place. Dust and lint in the return air can build up on internal components, resulting in loss of efficiency, equipment damage, and possible fire.

Filters designed to remove smaller particles such as pollen, may require additional maintenance.

Blower Compartment: Dirt and lint can create excessive loads on the motor resulting in higher than normal operating temperatures and shortened service life. It is recommended that the blower compartment be cleaned of dirt or lint that may have accumulated in the compartment or on the blower and motor as part of the annual inspection.

Blower Fan Wheel: Inspect the blower wheel blades for accumulations of dirt and clean if necessary. Inspect mounting nut for tightness when done.

Blower Motor & Assembly: Inspect the blower assembly and motor mounting brackets for tightness and corrosion. Correct deficiencies if necessary. The blower motor contains sealed bearings and under normal operating conditions, no maintenance is necessary for the life of the equipment.

CABINET SIZE	FILTER SIZE
B	18 x 20 x 1
C	20 x 20 x 1

Table 2. Filter Sizes

TROUBLESHOOTING

If the air handler fails to operate, check the following:

- Is the electric turned on?
- Is the thermostat operating properly?
- Are the blower compartment door(s) in place?
- Is the air handler disconnect closed?
- Has the circuit breaker tripped or the control board fuse burned open?
- Are any manual reset switches open?
- Is the filter dirty or plugged?

FIGURES & TABLES

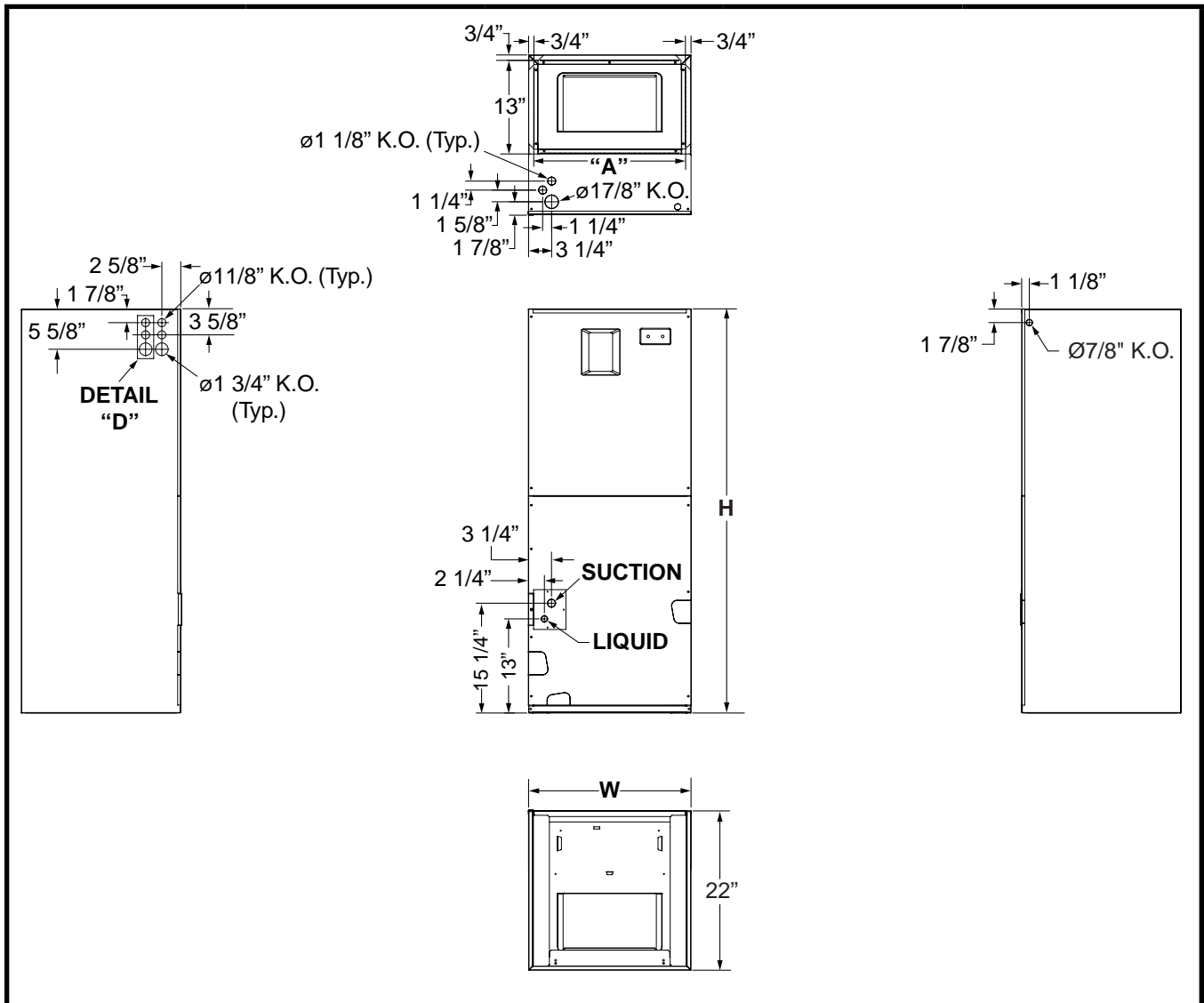

Cabinet Size	H	W	A	Detail D
B	43-5/16	19-11/16	18-1/4	No
Tall B	49-5/16	19-11/16	18-1/4	No
C	55-15/16	22-7/16	21	Yes

Table 3. B4VM-E Series Physical Dimensions

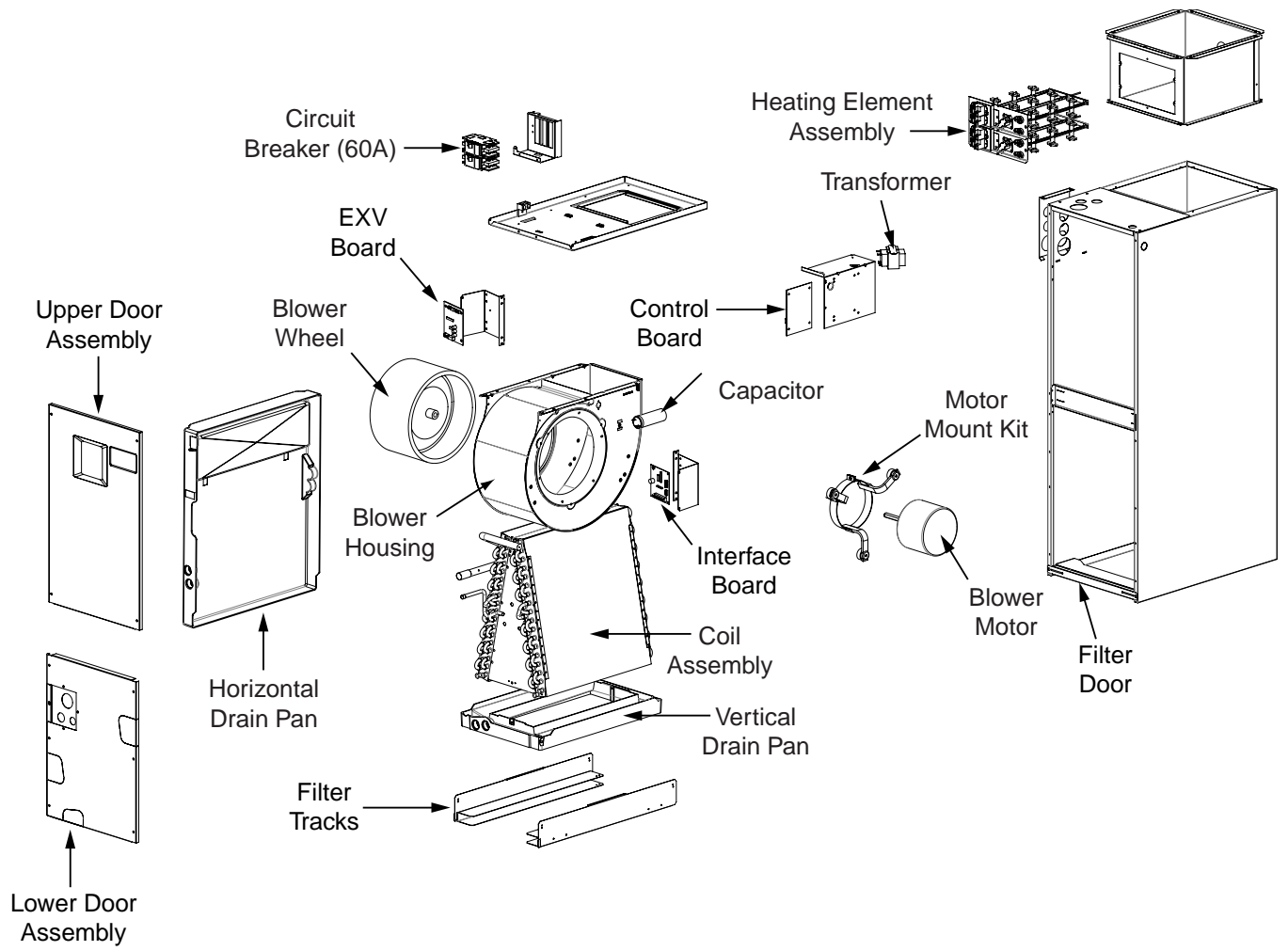

Figure 9. Air Handler Components

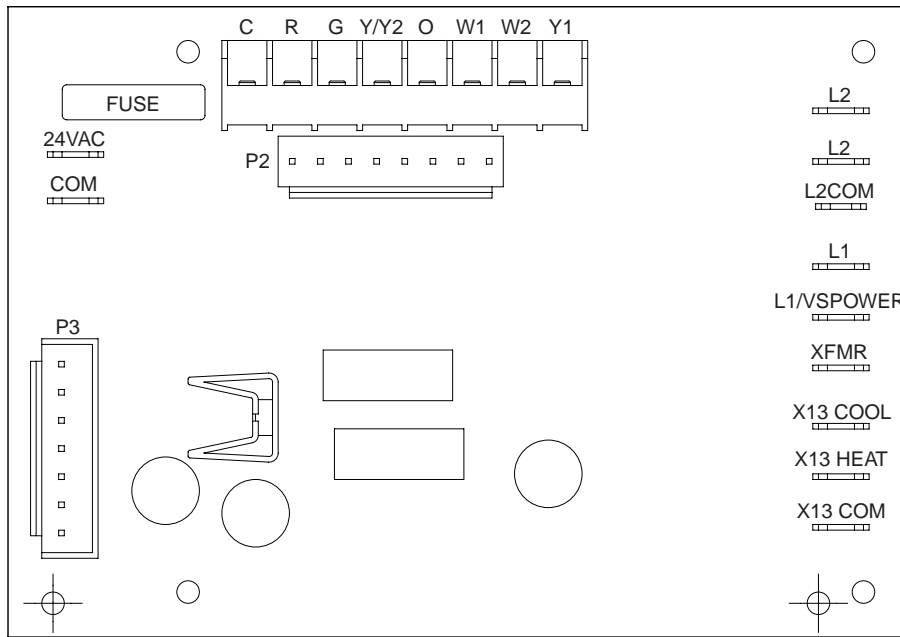

Figure 10. X13 Motor Control Board

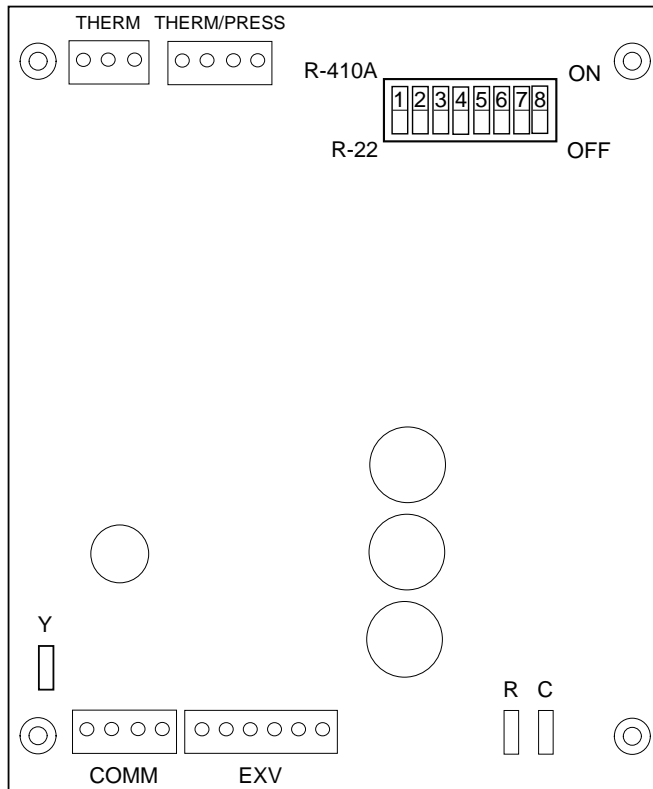
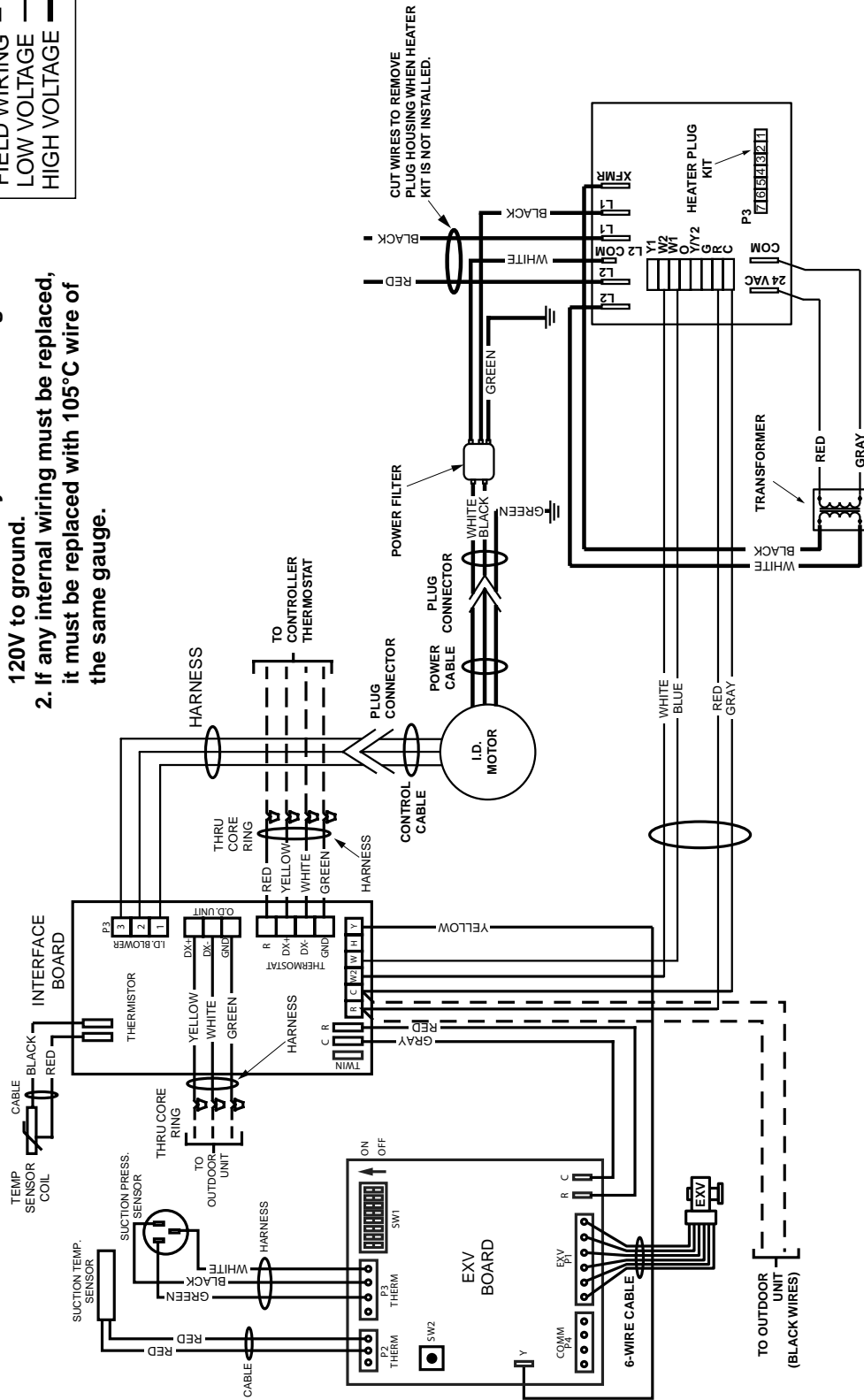
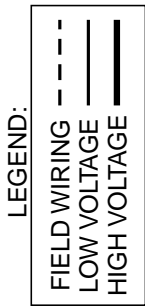

Figure 11. B4VM-E EXV Control Board

WIRING DIAGRAM

Air Handler for IQ Drive System

- NOTES:**
1. Not suitable for systems exceeding 120V to ground.
 2. If any internal wiring must be replaced, it must be replaced with 105°C wire of the same gauge.



710872A
(Replaces 7108720)

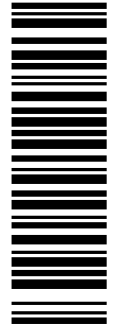

Figure 12. Wiring Diagram for B4VM-E Series Air Handler with IQ Drive

INSTALLATION / PERFORMANCE CHECK LIST

ATTENTION INSTALLERS:

It is your responsibility to know this product better than your customer. This includes being able to install the product according to strict safety guidelines and instructing the customer on how to operate and maintain the equipment for the life of the product. Safety should always be the deciding factor when installing this product and using common sense plays an important role as well. Pay attention to all safety warnings and any other special notes highlighted in the manual. Improper installation of the air handler or failure to follow safety warnings could result in serious injury, death, or property damage.

These instructions are primarily intended to assist qualified individuals experienced in the proper installation of this appliance. Some local codes require licensed installation/service personnel for this type of equipment. Please read all instructions carefully before starting the installation. Return these instructions to the customer's package for future reference.

INSTALLER NAME:		
CITY:	STATE:	
INSTALLATION ADDRESS:		
CITY:	STATE:	
UNIT MODEL #		
UNIT SERIAL #		
Minimum clearances per page 4?	YES	NO
Is the unit properly installed and leveled?	YES	NO
Does condensate drain properly in both drain tubes?	YES	NO
Has the owner's information been reviewed with the home-owner?	YES	NO
Has the literature package been left near the appliance?	YES	NO

ELECTRICAL SYSTEM:

Electrical connections tight?	YES	NO
Line voltage polarity correct?	YES	NO
Supply Voltage: _____(V)		
Has the thermostat been calibrated?	YES	NO
Is the thermostat level?	YES	NO
Is the heat anticipator setting correct?	YES	NO

VENTING SYSTEM:

Is there adequate fresh air supply for ventilation?	YES	NO
Vent free from restrictions?	YES	NO
Filter properly installed?	YES	NO
Filter clean?	YES	NO
Flue connections tight?	YES	NO
Is there proper draft?	YES	NO
Return Air Temp: _____(° F)		
Supply Air Temp: _____(° F)		
Temperature Rise: _____(° F)		

⚠ WARNING:

PROPOSITION 65 WARNING: This product contains chemicals known to the state of California to cause cancer, birth defects or other reproductive harm.



NORDYNE
COMPLETE COMFORT. GENUINE VALUE.



Specifications & illustrations subject to change without notice or incurring obligations.
O' Fallon, MO | Printed in U.S.A. (08/11)

708710C (Replaces 708710B)