

BroilVection™

Model JF62 Electric

Owner's Manual



APPROVALS:



FOR YOUR SAFETY:

Do not store or use gasoline or other flammable vapors or liquids in the vicinity of this or any other appliance.

WARNING:

Improper installation, adjustment, alteration, maintenance can cause property damage, injury, or death. Read the installation, operating and maintenance instructions thoroughly before installing or servicing this equipment.

Broiler area must be kept free of combustible materials, and the flow of combustion and ventilation air must not be obstructed. Operating personnel must not perform any maintenance or repair functions. Contact your Nieco Authorized Dealer.

IMPORTANT: RETAIN THIS MANUAL IN A SAFE PLACE FOR FUTURE REFERENCE

This page intentionally left blank.



TABLE OF CONTENTS

A. General Information	4
A.1 Description	4
A.2 Warranty Information	4
A.3 Service/Technical Assistance	5
A.4 Safety Information	5
B. Machine Installation	7
B.1 Pre-Installation	7
B.2 Mounting	7
B.3 Leveling	7
B.4 Hood Requirements	7
B.5 Clearance	7
B.6 Electrical Connection	7
B.7 Pre-Operation Check	7
C. Operation	8
C.1 Controls and Indicators	8
C.2 Step-by-Step Lighting Procedure	10
C.3 Shutdown Procedure	10
C.4 Control Operation	11
D. Assembly/Disassembly and Cleaning	13
E. Troubleshooting Guide	25
F. Specifications	27

A. GENERAL INFORMATION

A.1 Description

The Nieco® Model JF62 automatic broiler features patent pending BroilVection™ air system that uses recycled heat to greatly reduce energy needs, easy cleaning and a simple and intuitive control package to help eliminate broiling problems and provide the operator with even greater control over the broiling environment.

This manual provides the safety, installation and operating procedures for the Nieco Automatic Broiler Model JF62. We recommend that all information contained in this manual be read prior to installing and operating the broiler.

A.2 Warranty Information

Please read the full text of the limited Warranty in this manual.

If the unit arrives damaged, contact the carrier immediately and file a damage claim with them. Save all packing materials when filing a claim. Freight damage claims are the responsibility of the purchaser and **ARE NOT** covered under warranty.

The warranty **does not** extend to:

- Damages caused in shipment or damage as a result of improper use.
- Installation of electrical service.
- Normal maintenance as outlined in this manual.
- Malfunction resulting from improper maintenance not in accordance with the steps contained in this manual and any applicable training.
- Damage caused by abuse or careless handling outside of the normal operating procedures contained in this manual.
- Damage from moisture into electrical components.
- Damage from tampering with or removal of any safety device.

IMPORTANT!

Keep these instructions for future reference. If the unit changes ownership, be sure this manual accompanies the equipment.

IMPORTANT

The Nieco Corporation reserves the right to change specifications and product design. Such revisions do not entitle the buyer to corresponding changes, improvements, additions or replacements for previously purchased equipment.

A.3 Service/Technical Assistance

If you experience any problems with the installation or operation of your broiler, contact your local Authorized Nieco Distributor.

Fill in the information bellow and have it handy when calling your authorized service agency for assistance. The serial number is on the broiler rating plate on the side of the unit.

Purchased from: _____

Date of Purchase: _____

Model No.: _____

Serial No.: _____



For the name of your local Authorized Nieco Distributor, please call (800) 821-2141.



Use only genuine Nieco replacement parts in your broiler. Use of replacement parts other than those supplied by Authorized Nieco Distributors and Service Agencies will void the warranty and may significantly alter the performance of your broiler. The use of non-Nieco parts is capable of affecting these criteria, and may affect broiler performance, parts longevity and food safety. Your local Authorized Nieco Distributor and Service Agent has been factory trained and has a complete supply of parts for your Nieco Automatic Broiler.



You may contact the factory direct at +1-707-284-7100 if you have trouble locating your local Nieco Distributor.



A.4 Important Safety Information

Throughout this manual, you will find the following safety words and symbols that signify important safety issues with regards to operating or maintaining the equipment:

 WARNING 
GENERAL WARNING. Indicates information important to the proper operation of the equipment. Failure to observe may result in damage to the equipment and/or severe bodily injury or death.

 WARNING 
ELECTRICAL WARNING. Indicates information relating to possible shock hazard. Failure to observe may result in damage to the equipment and/or severe bodily injury or death.

 CAUTION 
GENERAL CAUTION. Indicates information important to the proper operation of the equipment. Failure to observe may result in damage to the equipment.

 WARNING 
HOT SURFACE WARNING. Indicates information important to the handling of equipment and parts. Failure to observe caution could result in personal injury.



A.4 Important Safety Information (Continued.)

In addition to the warnings and cautions in this manual, use the following guidelines for safe operation of your Nieco Automatic Broiler:

- Read and follow all instructions before using this equipment.
- Install or locate broiler only for its intended use as described in this manual.
- Do not operate this equipment if it has a damaged cord or plug, if it is not working properly or if it has been otherwise damaged.
- This equipment should only be serviced by authorized personnel. Contact your local Nieco Distributor for adjustment or repair.
- Use only genuine Nieco replacement parts for your broiler. Failure to do so will void the warranty and may significantly alter the performance of your broiler. The use of non-Nieco parts is capable of affecting these criteria, and may affect broiler performance, parts longevity and food safety.

The following warnings and cautions appear throughout the manual and should be carefully observed:

- **Turn the broiler off, and disconnect the plug before performing any service, maintenance or cleaning on the broiler.**
- **Always allow the broiler to fully cool before performing any service, maintenance or cleaning. Failure to wait for the broiler to cool fully may result in personal injury.**
- **The procedures in this manual may include reference to the use of chemical products. The Nieco Corporation does not endorse the use of any particular cleaning/degreasing agent. Use only those chemicals that are approved for use in your kitchen.**
- **The broiler should be grounded according to local electrical codes to prevent the possibility of electrical shock. It requires a grounded receptacle with separate electrical lines, protected by fuses or circuit breakers of the proper rating.**
- **All electrical connections must be in accordance with local electrical codes and any other applicable codes.**
- **The use of adequate ventilation (as rated in this manual) with this broiler is mandatory. Failure to adequately ventilate this unit and provide safe operating distances (as specified in this manual) is a fire safety hazard. Follow the instructions for emergency broiler shutdown in the event of an emergency.**
- **No attempt should be made to operate this appliance in the event of a power failure.**

WARNING ELECTRICAL SHOCK HAZARD. FAILURE TO FOLLOW THESE INSTRUCTIONS COULD RESULT IN SERIOUS INJURY OR DEATH:

- **Electrical ground is required on this appliance.**
- **Check with a qualified electrician if you are in doubt as to whether the appliance is properly grounded.**
- **Do not use water on or near the control box for risk of serious injury or death due to electrical shock.**

WARNING, HIGH TEMPERATURES WITH HOT SURFACES. FAILURE TO FOLLOW THESE PROCEDURES COULD RESULT IN SERIOUS INJURY:

- **Do not attempt to clean, disassemble or perform maintenance on this broiler until it is fully cooled as per the instructions contained in this manual.**

B. INSTALLATION

B.1 Pre-Installation

Uncrate the broiler and inspect for shipping damage. Remove the tape securing the machine parts, and install the parts in their proper location. If there are obvious or concealed damages to any part of the broiler, please contact your freight carrier. The factory warranty does not cover freight damage.

B.2 Mounting

Follow the mounting instructions if this function is not performed by the installer.

B.3 Leveling

The grease drain system is based on a gravity-flow design. Therefore, it is extremely important that the broiler be placed on a level surface.

B.4 Hood Requirements

This appliance must be installed under a ventilation hood of adequate size. Do not obstruct the flow of combustion and ventilation air. An adequate air supply must be available for safe and proper operation.

For installations in the Commonwealth of Massachusetts the following shall apply: Venting shall be in compliance with NFPA Section 10.3.5.2 for the Model JF93.

B.5 Clearance

Keep appliance area free from combustibles.

To facilitate disassembly and service of the unit a minimum of 24" (610 mm) should be allowed on the control panel (feed end) of the broiler.

REQUIRED AND RECOMMENDED CLEARANCES

	REQUIRED for installation near combustible walls and construction	REQUIRED for installation near non-combustible walls and construction	RECOMMENDED by Nieco for proper disassembly and service
Back of broiler	12" (305 mm)	0" (0 mm)	0" (0 mm)
Sides of broiler	12" (305 mm)	0" (0 mm)	0" (0 mm)
Front of broiler (Feed end)	12" (305 mm)	0" (0 mm)	24" (610 mm)

B.6 Electrical Connection

Power requirements are stated on the unit nameplate and must be connected accordingly. This appliance, when installed must be electrically grounded in accordance with local codes, or in the absence of local codes, with the National Electrical Code, ANSI/NFPA 70, or the Canadian Electrical Code, CSA C22.2, as applicable. Before starting broiler, tighten all electrical connections in control box. An electrical wiring diagram can be found inside the control box.

Note: Disconnect power before servicing.

B.7 Pre-Operation Check

Be sure that all parts are installed in the proper location:

Ventilation is turned on
Broiler is plugged in

C. OPERATION

C.1 Controls and Indicators

LEFT SIDE CONTROL BOX

1. Belt Speed Control - Used to set the broil time for the left side meat belt.
2. Load Sensing Control - Used to help stabilize the broiler under load.



RIGHT SIDE CONTROL BOX

3. Multi-Product Control (If equipped) - Can be programmed with a variety of menu item recipes for flexible broiling.



4. Main On/Off Switch - Turns the broiler on and off.



ON THE BACK OF THE BROILER

- a. Belt Reverse Buttons - In the event the broiler gets jammed, use these buttons to reverse the direction of the meat belt to help clear the jam.
- b. Shaft scraper tool - Use to clean the drive and idler shafts by scraping them of any debris or build-up.



C.1 Controls and Indicators (Continued.)

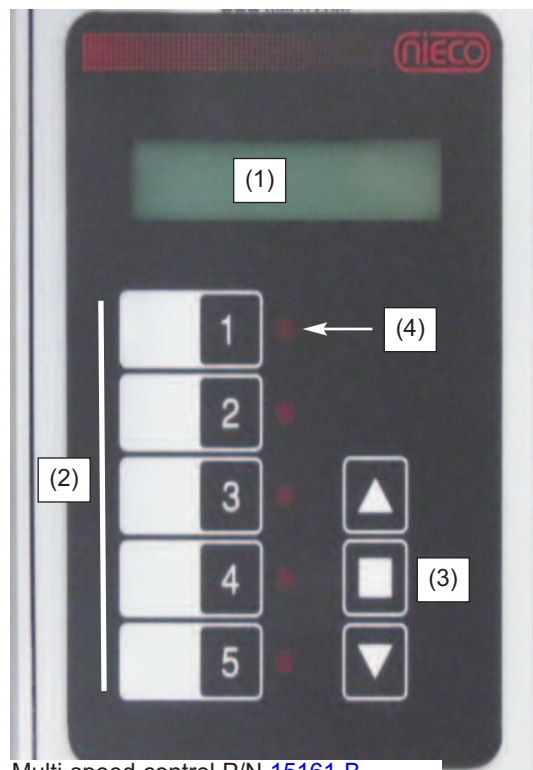

Multi-speed control P/N [15161-B](#)

(1) LED DISPLAY - Shows current product selection and cook time.

(2) PRODUCT SELECTION BUTTONS - Press to select different presets for different products.

(3) ADJUSTMENT BUTTONS - Use to adjust product cook times, element settings and product names.

(4) SELECTION INDICATOR LIGHT - Lights up to show which button is selected.

C.2 Lighting Procedures

PRE-LIGHTING PREPARATION

1. Broiler is centered under hood and plugged in
2. Turn ventilation system on

⚠ WARNING ⚠

THE VENTILATION SYSTEM MUST BE ON AT ALL TIMES DURING BROILER OPERATION. OPERATING BROILER WITHOUT PROPER VENTILATION IS A SEVERE FIRE HAZARD.

NORMAL IGNITION

1. Turn the **MAIN POWER SWITCH** on.



2. Check the elements to verify they are on and glowing.

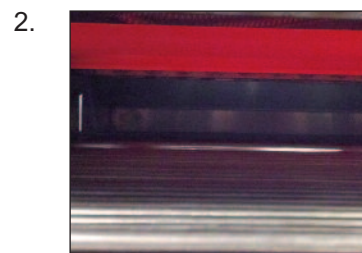

C.3 Shutdown Procedures

SHUTDOWN

1. Allow the broiler to run free of any product for 10 minutes. This will burn the chain clean.
2. Turn off the **Main Power Switch**.



3. Wait for 30 minutes for the broiler to cool.

⚠ CAUTION ⚠

FOR YOUR SAFETY: Do not store or use gasoline or other flammable vapors or liquids in the vicinity of this or any other appliance.

⚠ CAUTION ⚠

FOR YOUR SAFETY: In the event of a prolonged power failure, no attempt should be made to operate this appliance.

C.4 Control Operation

IMPORTANT: THIS BROILER IS SHIPPED WITH FACTORY PRESETS THAT MUST BE CHANGED

If this is the initial start-up for your broiler, ALL controls must be adjusted to properly broil your product. Follow the steps outlined for calibration and changing preset times to properly set up this broiler.

CONTROL OPERATION

1. SETTING BELT SPEEDS

Press up arrow to increase broil time; press the down arrow to decrease broil time. After you have set the control the display will be flashing. Press the center square to save your changes. NOTE: After making changes to the broil time, if you do not press the center square button, your changes will not be saved.

Use the up and down arrows to set the time. Press the center square button to save your changes.



2. BROIL TEMPERATURE STABILIZER CONTROL

Electric broilers are equipped with a Broil Temperature Stabilizer Control that senses when the broiler is being used, and adjusts the temperature to keep the broiler hot during heavy use. The control consists of two parts - a temperature probe to sense the internal temperature of the broiler, and the control itself.

a



3. CALIBRATING THE BROIL STABILIZER CONTROL

In order to assure proper operation, the Broil Stabilizer Control must be calibrated for operation in the restaurant. Every broiler will calibrate slightly differently, depending on supply voltage, ventilation, etc. Follow these step by step instructions when the broiler is new, and once per month after.

Step 1: Be sure all pieces of the broiler are in place. Make sure the broiler is plugged in and the exhaust hood is turned on. Turn the broiler on by turning the main power switch to the right.

Step 2: Set the temperature (bottom number) to 1000° F. Use the up or down arrows on the control to set the temperature. The bottom number is the set temperature and the top number is the actual temperature.

Step 3: Allow the broiler to heat up for 1 hour. During this time, the actual temperature will climb. Wait until the actual temperature stabilizes before proceeding.

Step 4: After 1 hour, set the set point temperature to match the stabilized temperature. Your broiler is now calibrated.

WARNING

The broiler can be damaged if this control is not set according to instructions.

C.4.5 FLEX SIDE CONTROLS

1. Multi-Product Control

How it works: The multi-product control is designed to let you broil different products on the flex side of the broiler. The control allows you to have different broiler settings for each product selection button. Use a grease pen to mark the white area with the product name.

2. Normal Operation

Press the product selection button (number) for the product you wish to cook. The display will show the product name and cook time and the light next to the product selection button will be lit.

NOTE: Be sure the belt is clear of any products before pressing a new product selection button.

3. Changing Belt Speeds

Push the product selection button you want to adjust then push the up and down arrows to make changes, then press the center square button to save them.

4. Changing Upper Heat Element Settings

To adjust element settings press the product selection button you wish to change, then press the product selection button one more time. The screen will read Duty Cycle and show a percentage. Press the up and down buttons to adjust the element power up or down (0 = off; 100% = Full on). Press the center square button after you are done adjusting the duty cycle to save your changes.

5. Changing Product Names

Push the product selection button which you want to assign a name to. Press and hold the center square button for 15 seconds. The control will enter the edit name screen for that button. Use the up and down buttons to change the characters. Press the center square button once to move to the next character until you are finished editing the product name for that button (10 character limit). Press and hold the PRODUCT SELECTION BUTTON for 5 seconds to save the changes and return to normal operation.

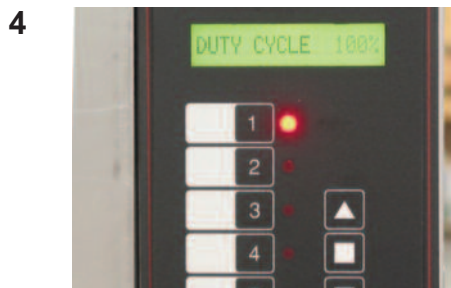

D. CLEANING AND DISASSEMBLY

Turn broiler off. Disconnect the power supply to the broiler before cleaning or servicing. If this broiler is connected using a restraint, and disconnection of the restraint is necessary for cleaning or moving the broiler, the restraint must be reconnected after the broiler has been returned to its originally installed position. Allow to cool for 30 minutes prior to cleaning/disassembly. Leave the ventilation system on during cooling. Use only approved cleaning, degreasing and sanitizing solutions.

⚠ WARNING ⚠

LEAVE THE VENTILATION HOOD ON DURING COOLING. FAILURE TO DO SO COULD POSE A FIRE SAFETY HAZARD.

⚠ CAUTION ⚠

Follow the Disassembly and Reassembly steps to ensure proper operation of the broiler. Failure to do so may result in operational problems.

⚠ WARNING ⚠

BROILER PARTS ARE HOT. DO NOT ATTEMPT TO DISASSEMBLE THE BROILER UNTIL IT IS FULLY COOL. FAILURE TO FOLLOW THIS INSTRUCTION MAY RESULT IN SEVERE INJURY.

ALL PARTS ARE CLEANED ON A DAILY BASIS UNLESS OTHERWISE NOTED

Follow the steps for proper disassembly. Reverse the order for reassembly.

How to read the cleaning section

The name of the part to be cleaned. The location of the part. When to clean the part.

The tools needed to clean the part

How to remove and clean the parts.

Picture of the part to be removed and cleaned.

The diagram shows a cleaning instruction card for 'Meat Guides'. The card is divided into several sections:

- Meat Guides**: The title of the part to be cleaned, circled in red.
- Tools**: A section listing the tools needed, including a '3-Compartment Sink' and a 'Scrub Pad', also circled in red.
- Instructions**: A section with two numbered steps: '1. Pull each meat guide out slightly from the bottom, then lift off.' and '2. Wash, rinse, and sanitize in the 3-compartment sink.' This section is circled in red.
- Feed End**: A label indicating the location of the part on the broiler, circled in red.
- Clean: Every 4 hours**: A label indicating the frequency of cleaning, circled in red.
- Image**: A photograph showing a hand pulling a meat guide out of the broiler, with a red arrow pointing to it from the text 'Picture of the part to be removed and cleaned.'

Cleaning the Broiler



Tools Needed

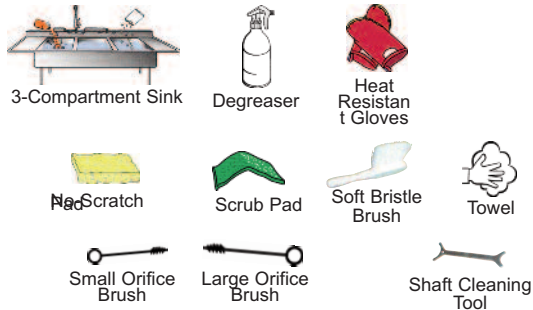

Instructions

1. Allow the broiler to run free of product for 10 minutes before turning it off. This allows any residue to burn off the chains.
2. Shut the broiler off and let it cool for 30 minutes before disassembly and cleaning.
3. Unplug the broiler before cleaning.
4. Always leave the ventilation hood on during the 30 minute cool down period.
5. Use only approved cleaning solutions.
6. Allow parts to air dry after cleaning.

STOP

Important Symbols



This "Stop" sign shows a step in the procedure that must be followed exactly or personal safety could be affected.



This warning symbol shows a step in the procedure that must be followed exactly or broiler performance could be affected.



This "puzzle" symbol shows a step in the reassembly procedure that must be followed.

Meat Guides (If equipped)

Clean: Every 4 hours



Tools



Instructions

1. Lift the meat guides up and off the feeder.
2. Wash, rinse, and sanitize in the 3-compartment sink.

Feed End



Feeder Cover

Clean: Every 4 hours



Tools

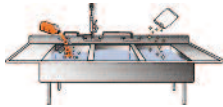

3-Compartment Sink



Scrub Pad



Instructions

1. Slide the feeder cover towards you until it comes off.
2. Wash, rinse, and sanitize in the 3-compartment sink.

Feed End



Push Bar Feeder Base (If equipped)

Clean: Every 4 hours



Tools

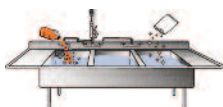

3-Compartment Sink



Scrub Pad



Instructions

1. Pull the release pin.
2. Lift push bar and wire belt feeder bases up and off.
3. Wash, rinse, and sanitize in the 3-compartment sink.



DO NOT lift the feeder base by the feeder bar or the chains. This will damage the feeder base.



REASSEMBLY: Pull the release pin and place feeder base in position.

Feed End

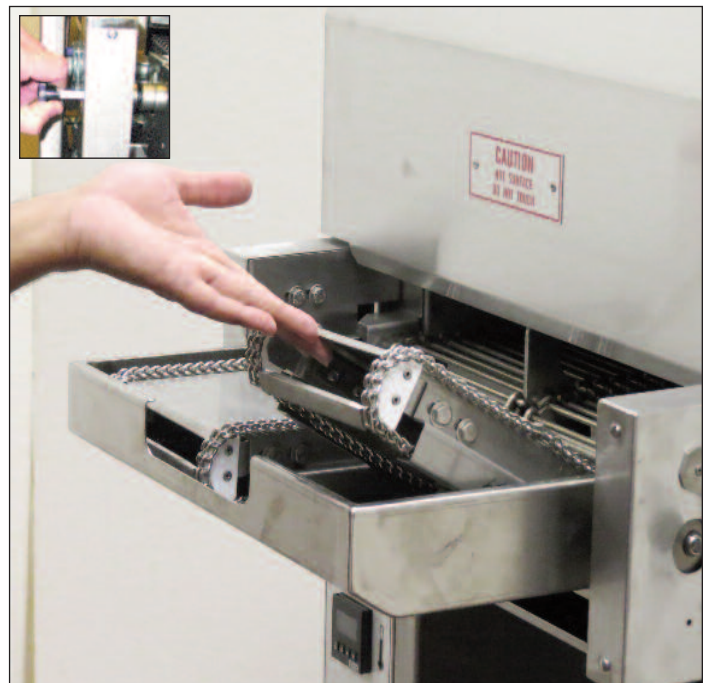

Wire Belt Feeder Base (If equipped)

Clean: Every 4 hours



Tools

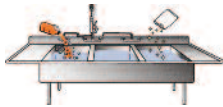

3-Compartment Sink



Scrub Pad



Instructions

1. Pull the release pin.
2. Lift wire belt feeder base up and off.
3. Wash, rinse, and sanitize in the 3-compartment sink.



DO NOT lift the feeder base by the wire belt. This will damage the feeder base.



REASSEMBLY: Pull the release pin and place feeder base in position.

Feed End

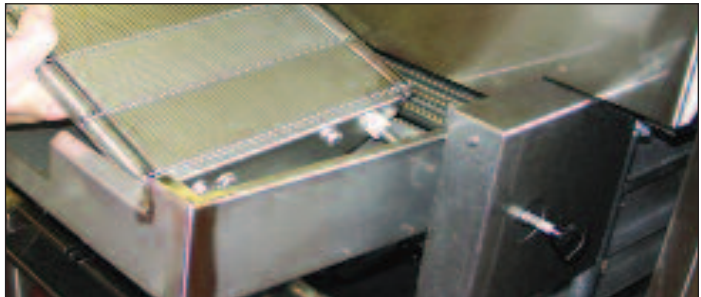

Feeder Housing

Clean: Daily



Tools

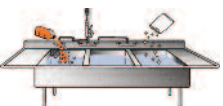

3-Compartment Sink



Scrub Pad



Instructions

1. Lift and remove.
2. Wash, rinse, and sanitize in the 3-compartment sink.



REASSEMBLY: Hang feeder housing on brackets.

Feed End

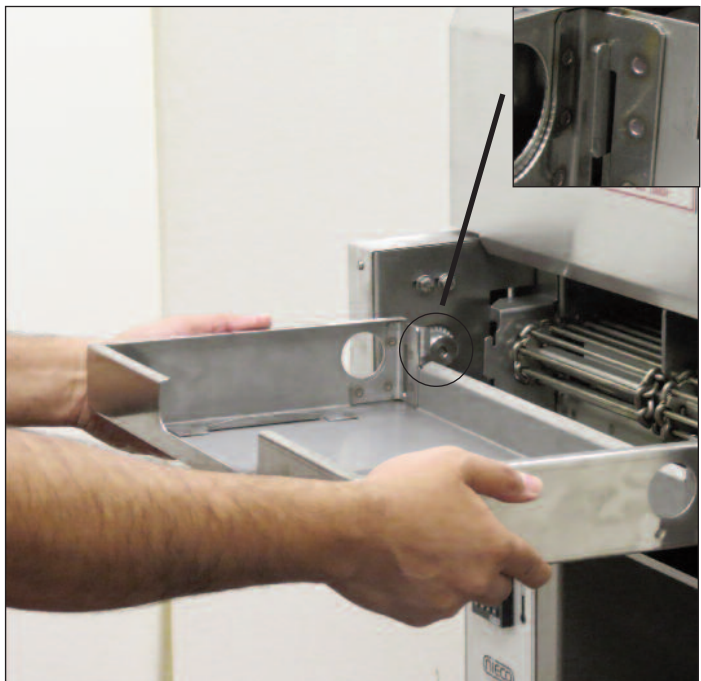

Grease Pan

Clean: Daily



Tools



Heat Resistant Gloves



Scrub Pad



Degreaser

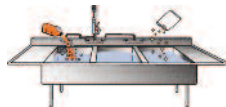

3-Compartment Sink



Instructions

1. Slide grease pan out.

! Make sure grease pan is cool before putting in water or it may warp the pans.

2. Take to sink area and spray with degreaser.

3. Wash with a scrub pad, rinse, and sanitize in the 3-compartment sink.

Feed End



Lower Heat Reflector

Clean: Daily



Tools



Heat Resistant Gloves



Scrub Pad



Degreaser

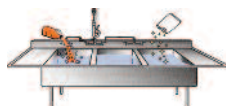

3-Compartment Sink



Instructions

1. Slide reflectors out.

2. Take to sink area and spray with degreaser.

3. Wash with a scrub pad, rinse, and sanitize in the 3-compartment sink.

Feed End



PHU Pan Shield

Clean: Daily



Tools



Heat Resistant Gloves



Scrub Pad



Degreaser

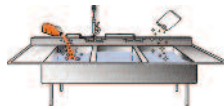

3-Compartment Sink



Instructions

1. Slide reflectors out.
2. Take to sink area and spray with degreaser.
3. Wash with a scrub pad, rinse, and sanitize in the 3-compartment sink.

Feed End



Holding Pan Bracket

Clean: Daily



Tools



Heat Resistant Gloves



Scrub Pad



Degreaser

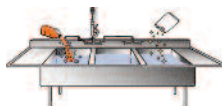

3-Compartment Sink



Instructions

1. Lift and slide bracket out.
2. Take to sink area and spray with degreaser.
3. Wash with a scrub pad, rinse, and sanitize in the 3-compartment sink.

Feed End



Crumb Tray

Clean: Daily



Tools



Heat Resistant Gloves



Scrub Pad



Degreaser

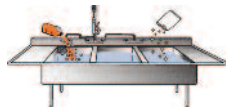

3-Compartment Sink



Instructions

1. Slide crumb tray out.
2. Take to sink area and spray with degreaser.
3. Wash with a scrub pad, rinse, and sanitize in the 3-compartment sink.

Feed End



Product Holding Area

Clean: Daily



Tools



Soapy Towel



Sanitized Towel



Instructions

1. Clean product holding area while still warm.
2. Wring out a soapy towel and wash product holding area.
3. Wring out a sanitized towel and wipe product holding area.

Feed End



Discharge Heat Shield

Clean: Daily



Tools



Heat Resistant Gloves



Scrub Pad



Degreaser

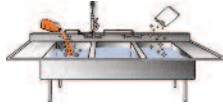

3-Compartment Sink



Instructions

1. Lift up and off.
2. Take to sink area and spray with degreaser.
3. Wash, rinse, and sanitize in the 3-compartment sink.

Discharge End



Product Slide

Clean: Daily



Tools



Heat Resistant Gloves



Scrub Pad



Degreaser

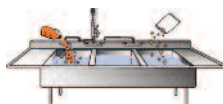

3-Compartment Sink



Instructions

1. Tilt and lift pins off hooks; lift off.
2. Take to sink area and spray with degreaser.
3. Wash, rinse, and sanitize in the 3-compartment sink.

Discharge End

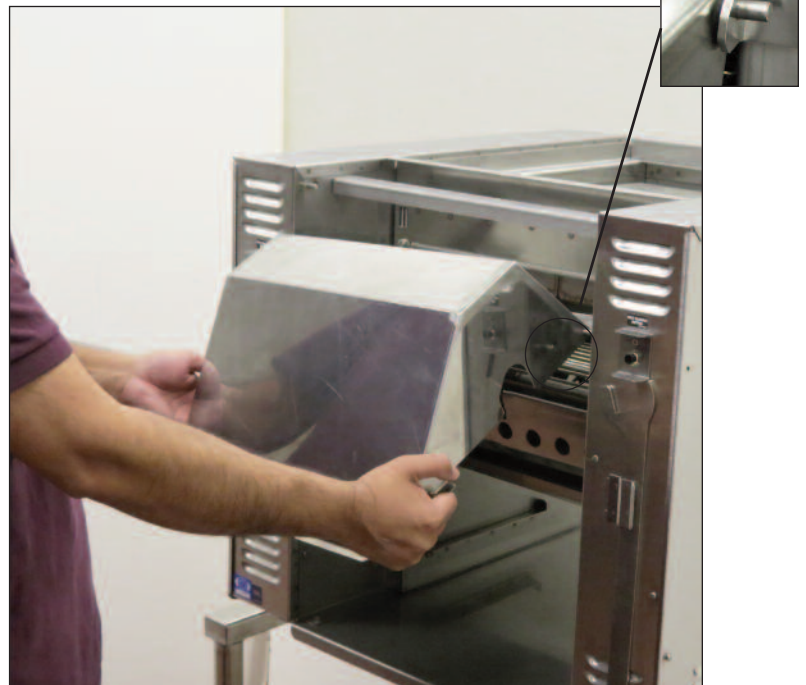

REASSEMBLY: Make sure pan inserts are on and return pan hangs on brackets.

Stripper Blade

Clean: Daily



Tools



Heat Resistant Gloves



Scrub Pad



Degreaser

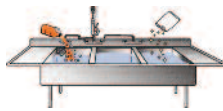

3-Compartment Sink



Instructions

1. Tilt stripper blade away from chain; lift off brackets.

 **Make sure stripper blade is cool before putting in water or it may warp.**

2. Take to sink area and spray with degreaser.

3. Wash with a scrub pad, rinse, and sanitize in the 3-compartment sink.

 **REASSEMBLY: Hang stripper blade on brackets.**

Discharge End



Grease Box

Clean: Daily



Tools



Heat Resistant Gloves



Scrub Pad



Degreaser

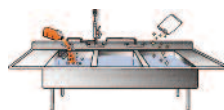

3-Compartment Sink



Instructions

1. Lift and remove the grease box.

2. Take to sink area and spray with degreaser.

3. Wash with a scrub pad, rinse, and sanitize in the 3-compartment sink.

Side



Grease Trough

Clean: Daily



Tools



Heat Resistant Gloves



Scrub Pad



Degreaser

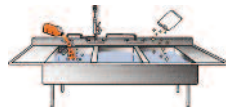

3-Compartment Sink



Instructions

1. Lift and slide the grease trough out of the broiler.
2. Take to sink area and spray with degreaser.
3. Wash with a scrub pad, rinse, and sanitize in the 3-compartment sink.



REASSEMBLY: Be sure grease trough is pushed all the way into the broiler.

Side



Incendalyst™

Clean: Daily



Tools



Heat Resistant Gloves



Instructions



EXTREMELY HOT! Be careful not to burn yourself.

1. Grasp handle and lift Catalyst off to remove from Shroud.
2. SOAK IN WARM WATER FOR 1 HOUR. RINSE WITH WATER ONLY. NEVER USE ANY CHEMICALS ON THE CATALYST.
3. Lay flat to drain water and let air dry overnight.
4. Make sure catalyst is dry before putting back on broiler.

Top



CAUTION: Extremely Hot 



Tools



Heat Resistant Gloves



Scrub Pad



Degreaser

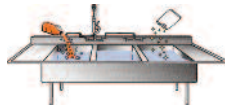

3-Compartment Sink



Instructions



EXTREMELY HOT! Be careful not to burn yourself.

1. Lift chimney from top of broiler.
2. Take to sink area and spray with degreaser.
3. Wash with a scrub pad, rinse, and sanitize in the 3-compartment sink.

Top



CAUTION: Extremely Hot

Air Boxes



Tools



Heat Resistant Gloves



Soft Bristle Brush



Instructions

1. Unscrew the hose connected to the side plate of the broiler.
2. Lift both air boxes and use a nylon brush to brush the air vents on the bottom of the boxes.

Be sure that both air box assemblies are installed and sit flush on their brackets. Reattach the hose to the frame of the broiler.

Top



CAUTION: Extremely Hot

Upper Heat Shield

Clean: Daily



Tools



Heat Resistant Gloves



Degreaser

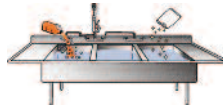

3-Compartment Sink



Scrub Pad



Instructions

EXTREMELY HOT! Be careful not to burn yourself.

1. Lift upper heat shield up and off.
2. Take to sink area and spray with degreaser.
3. Wash with a scrub pad, rinse, and sanitize in the 3-compartment sink.

Top



Chain Shafts

Clean: Daily



Tools



Shaft Cleaning Tool



Instructions

1. Scrape each shaft of both belts on the discharge end with the wide end of the shaft cleaning tool. The tool is located on the clip on the discharge end of the broiler.
2. Wipe shaft cleaning tool with a towel.

Discharge End

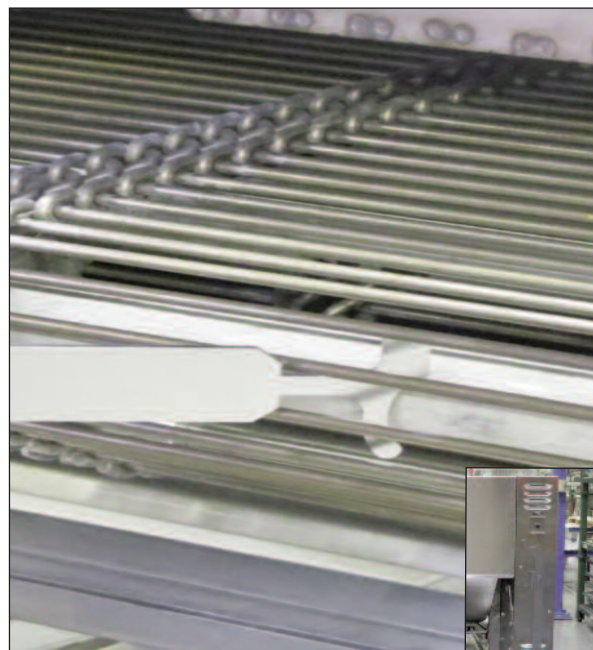

E. TROUBLESHOOTING

Always verify that the broiler is properly assembled, the hood is on, and the broiler is plugged in.

No power to broiler when the switch is turned on.	Check: Broiler is plugged in. Ventilation hood is on. Circuit Breaker on wall panel is on.
Power is on, but the conveyor belts are not turning.	Check for a jam in the conveyor belt. Check the stripper blade to make sure they are installed properly.
Feeder belt not moving.	Make sure the feeder is assembled properly. Check for jam. Make sure the drive pin is engaged.
Feeder jams.	Make sure the burgers are not frozen together.
Burgers sticking to slide or stripper blade.	Clean the slide and stripper blade very thoroughly. Check cookout temperature (undercooking).
COOKING PROBLEMS Burgers under or over cooked.	Adjust conveyor belt speed.
Excessive flaming in broiler.	Clean the catalyst if equipped. Check the hood for proper operation. Check product for overcooking.

G. PARTS

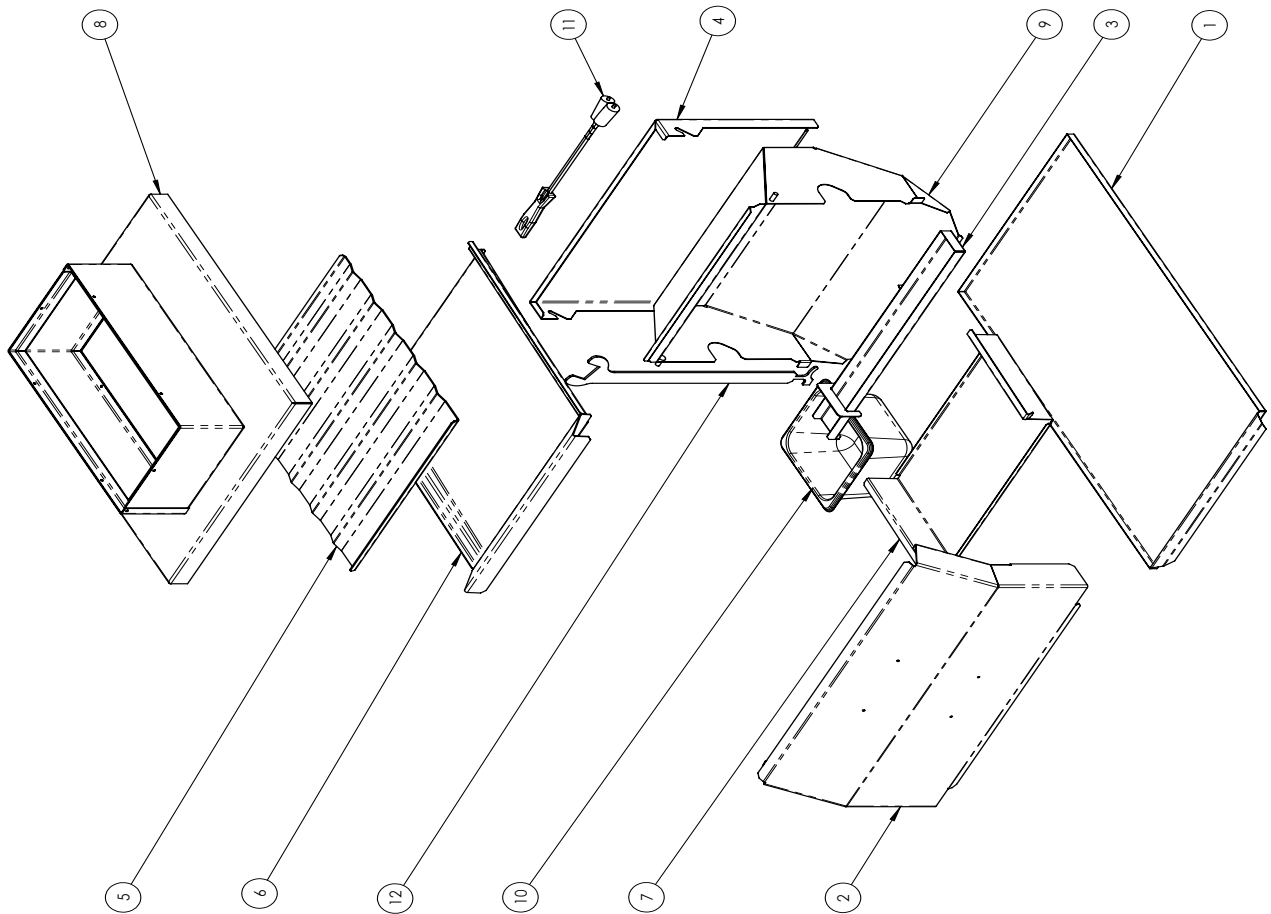

1	23265	TOOL COMBINATION, CLEANING, JF-E
1	23307	BRUSH, CLEANING, JF
1	22898	PAN, HOTEL, 1/6 X 4" DEEP
1	22888	SLIDE, SHORT, 15" FRAME, 30° JF - WIDMT
1	22866	HOOD, INCIDENTAL, ST. JF, HC, JF62 - WIDMT
1	22864	HEAT SHIELD, HOLDING PAN, 15" FRAME
1	22863	GREASE PAN, 15" WIDE FRAME, JF
1	20977	REFLECTOR, ELEMENT LOWER, 15" FRAME
1	20829	HEAT SHIELD, 15" FRAME, REAR, JF
1	20769	TRAY, SLUDGE, GREASE, 15" FRAME - WIDMT
1	20763	HEAT SHIELD, FEEDER/FRAME, 15" FRAME, JF
1	19685	TRAY, GREASE DRIP - 15" FRAME
QTY.	PART NO.	DESCRIPTION

G. SPECIFICATIONS

AUTOMATIC BROILER

Model JF93

DIMENSIONS	INCH	MM
Length	39.34	999
Height	30.24	768
Width	28.67	728

ENERGY

208-220V 3Ø 20A
380-400V 12A 3Ø

WEIGHT

Broiler 350

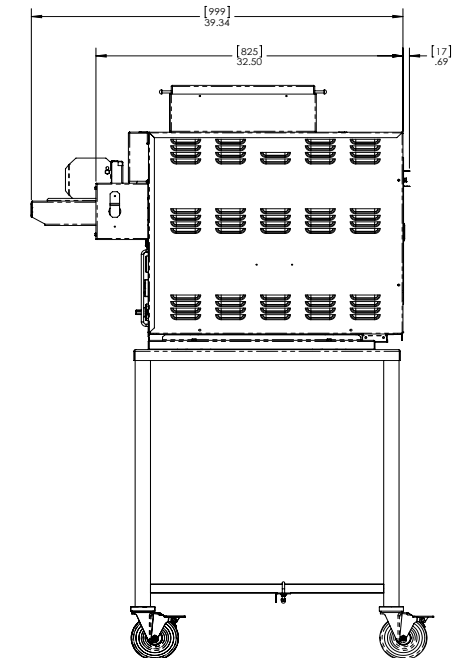
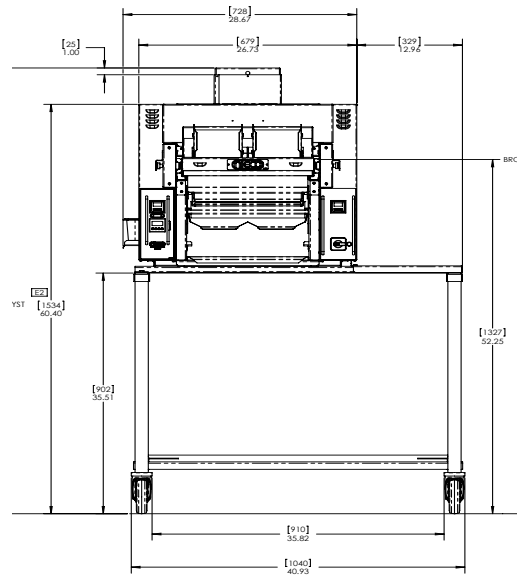

⚠ CAUTION ⚠

All electrical connections must be in accordance with local electrical codes and any other applicable codes.

⚠ CAUTION ⚠

Do not operate the broiler at gas pressures other than those stated here. Doing so will affect the operation of your broiler.

Revision History:

Date	Notes	REV
3-8-2011	Released	A
3-6-2012	Updated Wiring Diagram	B
4-10-2012	Updated Wiring Diagram	C
7-8-2014	General Update, Photos	D
12-15-2015	Update Cleaning Intervals, add new logos	E

Nieco Corporation

7950 Cameron Drive

Windsor, CA 95492

(707) 284-7100 Office • (707) 284-7430 Fax

www.nieco.com • e-mail: service@nieco.com

Printed in the USA © 2011 Nieco Corporation

All Rights Reserved P/N 99004

