



AUTOMATIC
FOOD SERVICE
EQUIPMENT

AUTOMATIC GAS BROILER
MODEL N1535 (FOR REVISION 4)

OWNERS MANUAL

IMPORTANT: RETAIN THIS MANUAL IN A SAFE PLACE
FOR FUTURE REFERENCE.

FOR YOUR SAFETY:

Do not store or use gasoline or other flammable vapors or liquids in the vicinity of this or any other appliance.

WARNING: Improper installation, adjustment, alteration, maintenance can cause property damage, injury, or death. Read the installation, operating and maintenance instructions thoroughly before installing or servicing this equipment.

Broiler area must be kept free of combustible materials, and the flow of combustion and ventilation air must not be obstructed. Operating personnel must not perform any maintenance or repair functions. Contact your Nieco Authorized Dealer.

In a prominent location, post instructions to be followed in the event the user smells gas. This information shall be obtained by consulting your local gas supplier.

TABLE OF CONTENTS

A. General Information	3
A.1 Description	3
A.2 Warranty Information	3
A.3 Service/Technical Assistance	4
A.4 Safety Information	4
B. Machine Installation	6
B.1 Pre-Installation	6
B.2 Mounting	6
B.3 Leveling	6
B.4 Hood Requirements	6
B.5 Clearance	6
B.6 Gas Connection	7
B.7 Flexible Gas Line Installation	7
B.8 Restraining Device	8
B.9 Electrical Connection	8
B.10 Pre-Operation Check	8
C. Troubleshooting Guide	9
D. Operation	11
D.1 Controls and Indicators	11
D.2 Step-by-Step Lighting Procedure	12
D.3 Shutdown Procedure	13
D.4 Control Operation	14
E. Cleaning and Disassembly	15
F. Broil Chain Tension & Link Removal	28
G. Parts Location Drawings	29
H. Specifications	32
I. Wiring Diagram	33
J. Warranty Information	34

A. GENERAL INFORMATION

A.1 Description

The Nieco® Model N1535 automatic broiler, utilizes dual broil chambers, high release convection burners, a new, simplified ignition system, easy cleaning and a state-of-the-art computer control to help eliminate broiling problems and provide the operator with even greater control over the broiling environment. The N1535 is return-flow, with an automatic product return system, allowing for space savings, while delivering product to the feed end of the broiler. The N1535 is also equipped with a heated product holding unit which allows for limited product holding.

This manual provides the safety, installation and operating procedures for the Nieco Automatic Broiler Model N1535. We recommend that all information contained in this manual be read prior to installing and operating the broiler.



A.2 Warranty Information

Please read the full text of the limited Warranty in this manual.

If the unit arrives damaged, contact the carrier immediately and file a damage claim with them. Save all packing materials when filing a claim. Freight damage claims are the responsibility of the purchaser and **ARE NOT** covered under warranty.

The warranty **does not** extend to:

- Damages caused in shipment or damage as a result of improper use.
- Installation of electrical service.
- Normal maintenance as outlined in this manual.
- Malfunction resulting from improper maintenance not in accordance with the steps contained in this manual and any applicable training.
- Damage caused by abuse or careless handling outside of the normal operating procedures contained in this manual.
- Damage from moisture into electrical components.
- Damage from tampering with or removal of any safety device.

IMPORTANT!

Keep these instructions for future reference. If the unit changes ownership, be sure this manual accompanies the equipment.

IMPORTANT

The Nieco Corporation reserves the right to change specifications and product design without notice. Such revisions do not entitle the buyer to corresponding changes, improvements, additions or replacements for previously purchased equipment.

A.3 Service/Technical Assistance

If you experience any problems with the installation or operation of your broiler, contact your local Authorized Nieco Distributor.

Fill in the information bellow and have it handy when calling your authorized service agency for assistance. The serial number is on the broiler rating plate on the side of the unit.

Nieco Distributor _____ Phone _____

Service Center _____ Phone _____

Model # _____ Serial # _____ Start-up Date _____



For the name of your local Authorized Nieco Distributor, please call (800) 821-2141.



Use only genuine Nieco replacement parts in your broiler. Use of replacement parts other than those supplied by Authorized Nieco Distributors and Service Agencies will void the warranty and may significantly alter the performance of your broiler. Your local Authorized Nieco Distributor and Service Agent has been factory trained and has a complete supply of parts for your Nieco Automatic Broiler.



You may contact the factory direct at (707) 284-7100 if you have trouble locating your local Nieco Distributor.



A.4 Important Safety Information

Throughout this manual, you will find the following safety words and symbols that signify important safety issues with regards to operating or maintaining the equipment:

 WARNING 
GENERAL WARNING. Indicates information important to the proper operation of the equipment. Failure to observe may result in damage to the equipment and/or severe bodily injury or death.

 WARNING 
ELECTRICAL WARNING. Indicates information relating to possible shock hazard. Failure to observe may result in damage to the equipment and/or severe bodily injury or death.

 CAUTION 
GENERAL CAUTION. Indicates information important to the proper operation of the equipment. Failure to observe may result in damage to the equipment.

 WARNING 
HOT SURFACE WARNING. Indicates information important to the handling of equipment and parts. Failure to observe caution could result in personal injury.

A.4 Important Safety Information (Cont.)

In addition to the warnings and cautions in this manual, use the following guidelines for safe operation of your Nieco Automatic Broiler:

- Read and follow all instructions before using this equipment.
- Install or locate broiler only for its intended use as described in this manual.
- Do not operate this equipment if it has a damaged cord or plug, if it is not working properly or if it has been otherwise damaged.
- This equipment should only be serviced by authorized personnel. Contact your local Nieco Distributor for adjustment or repair.
- Use only genuine Nieco replacement parts for your broiler. Failure to do so will void the warranty and may significantly alter the performance of your broiler.

The following warnings and cautions appear throughout the manual and should be carefully observed:

- **Turn the broiler off, close the main gas valve, and disconnect the plug before performing any service, maintenance or cleaning on the broiler.**
- **Always allow the broiler to fully cool before performing any service, maintenance or cleaning. Failure to wait for the broiler to cool fully may result in personal injury.**
- **The procedures in this manual may include reference to the use of chemical products. The Nieco Corporation does not endorse the use of any particular cleaning/degreasing agent. Use only those chemicals that are approved for use in your kitchen.**
- **The broiler should be grounded according to local electrical codes to prevent the possibility of electrical shock. It requires a grounded receptacle with separate electrical lines, protected by fuses or circuit breakers of the proper rating.**
- **All electrical connections must be in accordance with local electrical codes and any other applicable codes.**
- **The use of adequate ventilation (as rated in this manual) with this broiler is mandatory. Failure to adequately ventilate this unit and provide safe operating distances (as specified in this manual) is a fire safety hazard. Follow the instructions for emergency broiler shutdown in the event of an emergency.**
- **No attempt should be made to operate this appliance in the event of a power failure.**

WARNING ELECTRICAL SHOCK HAZARD. FAILURE TO FOLLOW THESE INSTRUCTIONS COULD RESULT IN SERIOUS INJURY OR DEATH:

- **Electrical ground is required on this appliance.**
- **Check with a qualified electrician if you are in doubt as to whether the appliance is properly grounded.**
- **Do not use water on or near the control box located on the underside of the broiler for risk of serious injury or death due to electrical shock.**

WARNING, HIGH TEMPERATURES WITH HOT SURFACES. FAILURE TO FOLLOW THESE PROCEDURES COULD RESULT IN SERIOUS INJURY:

- **Do not attempt to clean, disassemble or perform maintenance on this broiler until it is fully cooled as per the instructions contained in this manual.**

B. INSTALLATION

B.1 Pre-Installation

Uncrate the broiler and inspect for shipping damage. Remove the tape securing the machine parts, and install the parts in their proper location. If there are obvious or concealed damages to any part of the broiler, please contact your freight carrier. The factory warranty does not cover freight damage.

B.2 Mounting

- B.2.1 Remove all parts from the broiler.
- B.2.2 Lift broiler onto stand. NOTE: The cross bar on the base of the stand should be on the discharge (back side) end of the broiler.
- B.2.3 Use the supplied nuts and bolts to bolt the frame of the broiler to the stand.
- B.2.4 Follow the steps outlined in the manual to reassemble the broiler.

B.3 Leveling

The grease drain system is based on a gravity-flow design. Therefore, it is extremely important to level the broiler during installation.

B.4 Hood Requirements

This appliance must be installed under a ventilation hood of adequate size and the following minimum capacity:

Model	SCFM
N1535	600

Do not obstruct the flow of combustion and ventilation air. An adequate air supply must be available for safe and proper operation.

B.5 Clearance

For proper installation the minimum required clearance from combustible construction and walls is 12" (305 mm) from all sides of the broilers. The minimum required clearance from non-combustible construction and walls is 0" (0 mm) from all sides of the broiler. Keep appliance area free from combustibles. Check with local authorities (building and fire) for standards and requirements for wall and floor construction to comply with your local codes.

REQUIRED AND RECOMMENDED CLEARANCES

	REQUIRED for installation near combustible walls and construction	REQUIRED for installation near non-combustible walls and construction	RECOMMENDED by Nieco for proper disassembly and service
Back of broiler	12" (305 mm)	0" (0 mm)	12" (305 mm)
Sides of broiler	12" (305 mm)	0" (0 mm)	12" (305 mm)
Front of broiler (Feed end)	12" (305 mm)	0" (0 mm)	24" (610 mm)

CAUTION

SEVERE FIRE HAZARD. Follow local fire and building codes for non-combustible construction. Failure to do so could result in a fire hazard. If unsure of your construction, follow minimum clearances for combustible construction.



B.6 Gas Connection- 3/4" N.P.T.

At rated input the gas supply should deliver a minimum pressure of at least 15 mbar (5" water column) at the broiler connection for natural gas. Incoming gas supply pressure must not exceed 50 mbar (14" water column).

Note: The installation of this appliance must conform with local codes, or in the absence of local codes, with the National Fuel Gas Code, ANSI Z223.1, Natural Gas Installation Code, CAN/CGA-B149.1 including:

1. The appliance and its individual shutoff valve must be disconnected from the gas supply piping system during any pressure testing of that system at test pressures in excess of 1/2 psi (3.45 kPa).
2. The appliance must be isolated from the gas supply piping system by closing its individual manual shutoff valve during any pressure testing of the gas supply piping system at test pressures equal to or less than 1/2 psi (3.45 kPa).

By public initiative, the State of California has adopted legislation (Proposition 65) which requires manufacturers of many types of products, including gas appliances, to warn consumers of their products that contain chemicals or produce substances listed by the State of California to either cause cancer, birth defects or other reproductive harm.

	WARNING	
If not installed, operated and maintained in accordance with the manufacturers instructions, this product could expose you to substances in fuel or from fuel combustion which can cause cancer, birth defects or other reproductive harm.		

B.7 Installing Gas Appliance Connectors and Flexible Gas Lines Correctly

For safety in the kitchen area, and to insure maximum service life, it is vitally important to correctly install connectors. The connector shall comply with the Standard for Connectors for Moveable Gas Appliances, ANSI Z21.69 or CAN/CGA-6.16 and a quick disconnect device that complies with the Standard for Quick-Disconnect Devices for use with gas fuel, ANSI Z21.41 or CAN1-6.9

In order to avoid sharp kinks or excessive bends that could have a damaging effect on the connector, it may be necessary to attach pipe elbows in order to bring the connector into its proper plane. For easy movement of the appliance, the connector should be installed with a "lazy" loop for minimum tension.

Note: Gas appliances should be disconnected prior to maximum movement. (Minimal movement is possible to connect hose.)

**N1535 Manual
Gas Valve**



**N1535 Equipment Side Gas
Connection**



B.8 Restraining Device Installation and Use

This high strength restrainer is to be used with all moveable (castered) appliances. It fully complies with American Gas Association requirements. References: Z21.69, Z83.11, and Z21.41 with current revisions. Installation is quick and positive. In Canada, device is in accordance with CAN 1-6.9-M70 Quick Disconnect Devices for use with gas fuel, and CAN 1-6.10-88 metal connectors for gas appliances. Correct length for any appliance is simply a matter of loosening two adjuster clips (1) and re-tightening. (3" to 6" shorter than appliance connector is desired length.)

Restrainer is made of heavy duty steel cable, with a strong scissor hood (2) at one end, and an equally strong spring hook (3) at the other. Cotter pin (4) is supplied to secure the installation. For proper attachment to the broiler, use the supplied hardware to attach the device to the holes in the shear plate of the broiler stand.

NOTE: If disconnection of the restraint is necessary, reconnect the restraint after the appliance has been returned to its originally installed position.

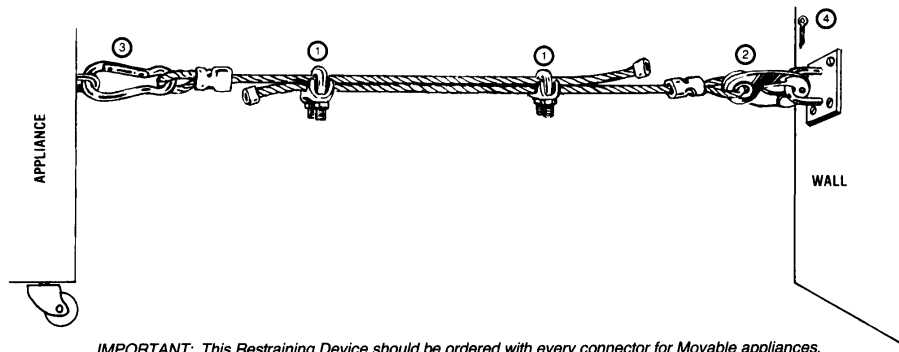

B.9 Electrical Connection

Power requirements are stated on the unit nameplate and must be connected accordingly. This appliance, when installed must be electrically grounded in accordance with local codes, or in the absence of local codes, with the National Electrical Code, ANSI/NFPA 70, or the Canadian Electrical Code, CSA C22.2, as applicable. Before starting broiler, tighten all electrical connections in control box. An electrical wiring diagram can be found inside the control box.

Note: Disconnect power before servicing.

B.10 Pre-Operation Check

Be sure that all parts are installed in the proper location:

- Ventilation is turned on
- Broiler is plugged in
- Gas line is connected

C. TROUBLESHOOTING

Always verify that the broiler is properly assembled, the hood is on, gas valve open and broiler is plugged in.

Problem	Solution
Pilots not lighting	<ul style="list-style-type: none"> <input type="checkbox"/> Check that broiler is plugged in, gas valve is open and broiler is turned on <input type="checkbox"/> Manually light <input type="checkbox"/> Check for ignition <input type="checkbox"/> Check for clogged pilot
Burners not lighting	<ul style="list-style-type: none"> <input type="checkbox"/> Check for gas pressure, if there is pressure, use the manual lighting procedure <input type="checkbox"/> If no gas pressure, call for service <input type="checkbox"/> Check for proper burner installation <input type="checkbox"/> Check for plugged burner orifices <input type="checkbox"/> Check for plugged pilot burner
Pilot not staying lit	<ul style="list-style-type: none"> <input type="checkbox"/> Call for service as thermocouple may need replacing
Broil chain jams	<ul style="list-style-type: none"> <input type="checkbox"/> Check: <ul style="list-style-type: none"> ___ For sag in the chain (Chain may need a link removed) ___ For an obstruction
Product not cooking to proper temperature in cookouts	<ul style="list-style-type: none"> <input type="checkbox"/> Adjust cook time <input type="checkbox"/> Check that broiler is calibrated properly <input type="checkbox"/> Check that all burners are lit <input type="checkbox"/> Check that all parts are installed correctly, and that lower burner holes are facing up <input type="checkbox"/> Check that broiler is properly cleaned and assembled <input type="checkbox"/> Check ventilation <ul style="list-style-type: none"> ___ Make sure there isn't excessive exhaust or an air vent blowing on the broiler

Problem	Solution
Meat patties not returning	<ul style="list-style-type: none"> <input type="checkbox"/> Check that patties have not gotten stuck on the return slide <ul style="list-style-type: none"> ___ Remove awnings to check ___ Remove product from return slide if necessary ___ Proper cleaning of return slide is needed daily to remove buildup which can cause patties to stick
Too much smoke/heat in the kitchen	<ul style="list-style-type: none"> <input type="checkbox"/> Check that hood and fan are working correctly <input type="checkbox"/> Check that broiler is properly positioned under the hood; check all sides of broiler <input type="checkbox"/> Check condition of catalyst (after broiler is turned off and cooled at end of night) clean if necessary <input type="checkbox"/> Check condition and placement of grease extractors; clean daily and position properly
Grease on floor from discharge end	<ul style="list-style-type: none"> <input type="checkbox"/> Check that grease box is installed

D. OPERATION

D.1 Controls and Indicators

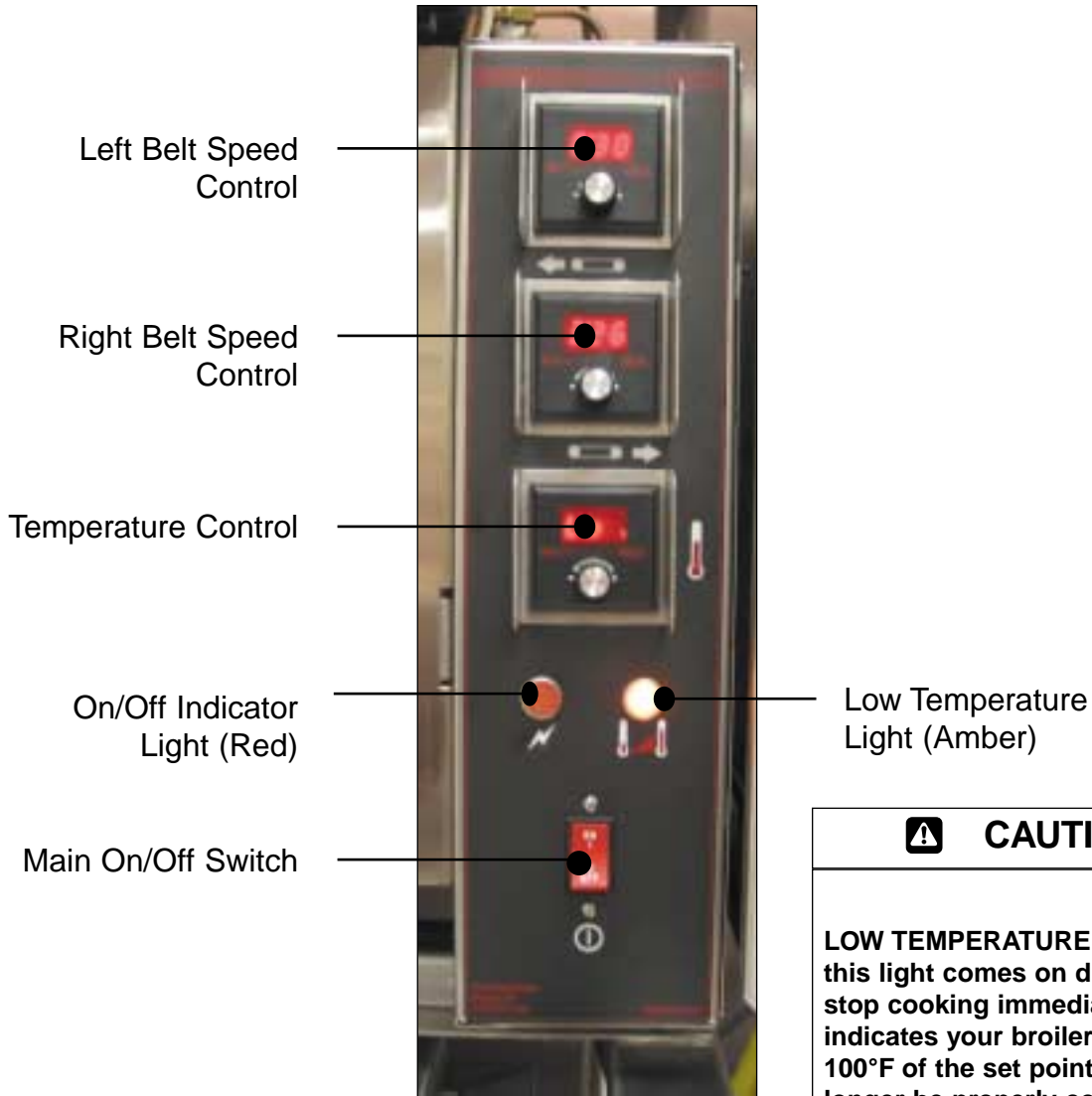

⚠ CAUTION ⚠

LOW TEMPERATURE WARNING: If this light comes on during operation, stop cooking immediately. This light indicates your broiler has gone below 100°F of the set point and may no longer be properly cooking the product.

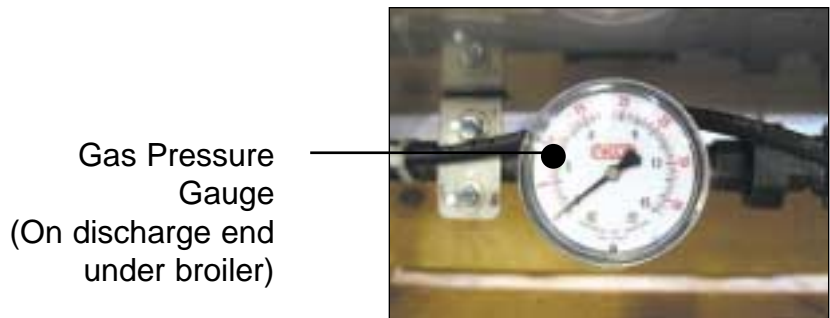

D.2 Lighting Procedures

PRE-LIGHTING PREPARATION

1. Broiler is centered under hood and plugged in
2. Gas valve is open when handle is in line (parallel to) the pipe
3. Turn ventilation system on

⚠ WARNING ⚠

THE VENTILATION SYSTEM MUST BE ON AT ALL TIMES DURING BROILER OPERATION. OPERATING BROILER WITHOUT PROPER VENTILATION IS A SEVERE FIRE HAZARD.

AUTOMATIC IGNITION

1

Turn the **MAIN POWER SWITCH (a)** on. The N1535 is equipped with automatic ignition.

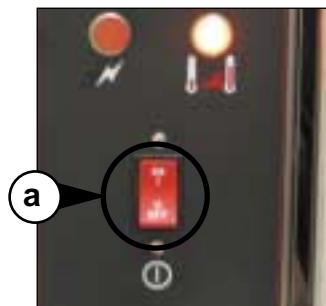

2

After ignition; check **GAS PRESSURE GAUGE (a)** reading. Gauge should read 5". If not, follow ignition troubleshooting tips of this manual. Verify that all burners - upper and lower - have lit.



D.3 Shutdown Procedures

PLANNED SHUTDOWN

1. Allow the broiler to run free of any product for 10 minutes. This will burn the chain clean.
2. Turn off the **Main Power Switch (a)**.
3. Wait for 30 minutes for the broiler to cool.

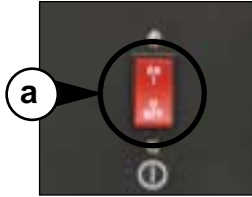

⚠ WARNING ⚠

Always leave the ventilation hood on while the broiler is cooling. Failure to do so is both a fire risk and could result in damage to the broiler.

⚠ CAUTION ⚠

Allow the broiler to fully cool **BEFORE** beginning disassembly and cleaning. Failure to do so could result in serious injury.

EMERGENCY SHUTDOWN

1. Turn off the **MAIN POWER SWITCH (a)**.
2. Close the **MAIN GAS VALVE (b)**. Valve is closed when it is perpendicular to pipe.

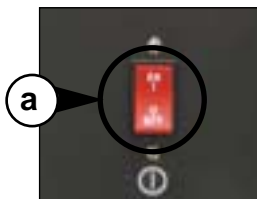

Your Nieco Automatic Broiler is designed to automatically stop gas flow to the broiler in the event of power failure, gas pressure loss or any other related incident. No attempt to operate this appliance should be made in the event of a power failure.

⚠ CAUTION ⚠

In a prominent location, post instructions to be followed in the event the user smells gas. This information shall be obtained by consulting your local gas supplier.

⚠ CAUTION ⚠

FOR YOUR SAFETY: Do not store or use gasoline or other flammable vapors or liquids in the vicinity of this or any other appliance.

⚠ CAUTION ⚠

FOR YOUR SAFETY: In the event of a prolonged power failure, no attempt should be made to operate this appliance.

D.4 Control Operation

IMPORTANT: THIS BROILER IS SHIPPED WITH FACTORY PRESETS THAT MUST BE CHANGED.

If this is the initial start-up for your broiler, ALL control settings must be made according to your restaurant operating guidelines. Follow the steps outlined for calibration, changing preset times and setting the flex chamber element heat settings to properly set up this broiler.

WARMING UP

1

Turn Main Power Switch on. Light the broiler following the lighting procedures. Allow the broiler 60 minutes to get to proper cooking temperature.

DO NOT COOK DURING WARM-UP!

SET BELT SPEEDS

2

Turn the UPPER BELT SPEED CONTROL knob to set the LEFT BELT speed to the desired setting. Turn the LOWER SPEED CONTROL knob to set the RIGHT BELT SPEED to the desired setting.



MANUAL CALIBRATION

3

After the 60 minute warm up period, the TEMPERATURE CONTROL will display the actual temperature. Push the knob in and the set point temperature will be displayed. Adjust the set point temperature by pressing the knob and turning until it reads the same as the actual temperature.



AUTO CALIBRATION

4

Push and hold in the temperature adjustment knob. Turn the main power switch ON. Hold the knob in for 5 seconds, then release. The display will show a 45 minute countdown. After the countdown, the broiler will be calibrated and ready for cooking. **DO NOT COOK DURING CALIBRATION**

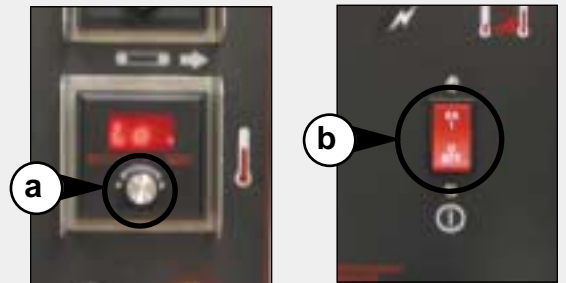

NOTE: Calibration should be performed on a monthly basis.

E. CLEANING AND DISASSEMBLY

Turn broiler off and close the main gas valve. Disconnect the power supply to the broiler before cleaning or servicing. If this broiler is connected using a restraint, and disconnection of the restraint is necessary for cleaning or moving the broiler, the restraint must be reconnected after the broiler has been returned to its originally installed position. Allow to cool for 30 minutes prior to cleaning/disassembly. Leave the ventilation system on during cooling. Use only approved cleaning, degreasing and sanitizing solutions.

⚠ WARNING ⚠

LEAVE THE VENTILATION HOOD ON DURING COOLING. FAILURE TO DO SO COULD POSE A FIRE SAFETY HAZARD.

⚠ CAUTION ⚠

Follow the Disassembly and Reassembly steps to ensure proper operation of the broiler. Failure to do so may result in operational problems.

⚠ WARNING ⚠

BROILER PARTS ARE HOT. DO NOT ATTEMPT TO DISASSEMBLE THE BROILER UNTIL IT IS FULLY COOL. FAILURE TO FOLLOW THIS INSTRUCTION MAY RESULT IN SEVERE INJURY.

ALL PARTS ARE CLEANED ON A DAILY BASIS UNLESS OTHERWISE NOTED

Follow the steps for proper disassembly. Reverse the order for reassembly.

How to Use the Cleaning Section

	The name of the part to be cleaned.	The location of the part.	When to clean the part.
	Grease Pans	Feed End	Clean: Daily
The tools needed to clean the part	Tools 		<p>Picture of the part to be removed and cleaned.</p>
How to remove and clean the parts.	Instructions 1. Slide grease pans out. ⚠ Make sure grease pans are cool before putting in water or it may warp the pans. 2. Take to sink area and spray with degreaser. 3. Wash with a scrub pad, rinse, and sanitize in the 3-compartment sink.		
	Cleaning Aid		6

Cleaning the Broiler



Tools Needed



Instructions

1. Allow the broiler to run free of product for 10 minutes before turning it off. This allows any residue to burn off the chains.
2. Shut the broiler off and let it cool for 30 minutes before disassembly and cleaning.
3. Close the main gas valve and unplug the broiler before cleaning.
4. Always leave the ventilation hood on during the 30 minute cool down period.
5. Use only approved cleaning solutions.
6. Allow parts to air dry after cleaning.



Important Symbols



This "Stop" sign shows a step in the procedure that must be followed exactly or personal safety could be affected.



This warning symbol shows a step in the procedure that must be followed exactly or broiler performance could be affected.



This "puzzle" symbol shows a step in the reassembly procedure that must be followed.

Meat Guides

Clean: 3:00 p.m.; 7:00 p.m.; 11:00 p.m.; 2:00 a.m.



Tools

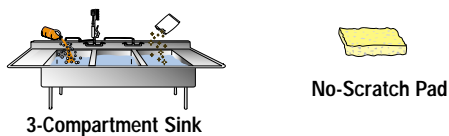

Instructions

1. Pull each meat guide out slightly from the bottom, then lift off.
2. Wash, rinse, and sanitize in the 3-compartment sink.

Feed End



Feeder Cover

Clean: 3:00 p.m.; 7:00 p.m.; 11:00 p.m.; 2:00 a.m.



Tools

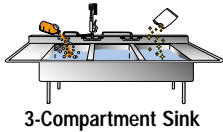

3-Compartment Sink



No-Scratch Pad



Instructions

1. Slide the feeder cover towards you until it comes off.
2. Wash, rinse, and sanitize in the 3-compartment sink.

Feed End



Feeder Base

Clean: 3:00 p.m.; 7:00 p.m.; 11:00 p.m.; 2:00 a.m.



Tools

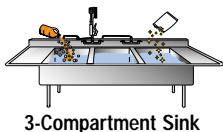

3-Compartment Sink



No-Scratch Pad



Instructions

1. Pull the release pin.
2. Lift feeder base up and off.
3. Wash, rinse, and sanitize in the 3-compartment sink.

! DO NOT lift the feeder base by the feeder bar or the chains. This will damage the feeder base.

+ REASSEMBLY: Pull the release pin and place feeder base in position.

Feed End



Feeder Housing

Clean: Daily



Tools

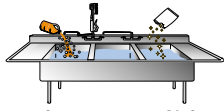

3-Compartment Sink



No-Scratch Pad



Instructions

1. Lift and remove.
2. Wash, rinse, and sanitize in the 3-compartment sink.

REASSEMBLY: Hang feeder housing on brackets.

Feed End



Grease Pan

Clean: Daily



Tools



Heat Resistant Gloves



Scrub Pad



Degreaser

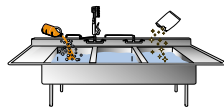

3-Compartment Sink



Instructions

1. Slide grease pan out.
- !** Make sure grease pan is cool before putting in water or it may warp the pans.
2. Take to sink area and spray with degreaser.
 3. Wash with a scrub pad, rinse, and sanitize in the 3-compartment sink.

Feed End



Flame Sensor

Daily



Tools



Towel



Instructions

1. Wipe the flame sensor with a dry towel.

 Do NOT use water on the flame sensor.

Feed End

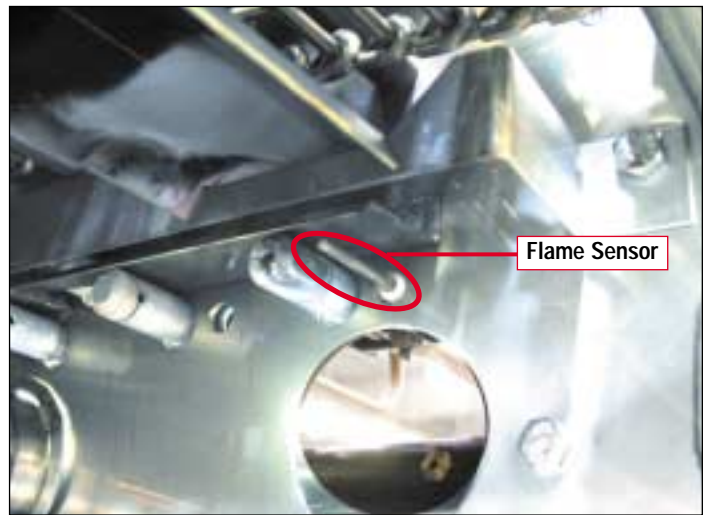

No spray



No water

Warming Heater Shield

Clean: Daily



Tools



Soapy Towel



Sanitized Towel



Instructions

1. Clean warming heater shield while still warm.
2. Wring out a soapy towel and wash warming heater shield.
3. Wring out a sanitized towel and wipe warming heater shield.

Feed End



Product Holding Area

Clean: Daily



Tools



Soapy Towel



Sanitized Towel



Instructions

1. Clean product holding area while still warm.
2. Wring out a soapy towel and wash product holding area.
3. Wring out a sanitized towel and wipe product holding area.

Feed End



Grease Box

Clean: Daily



Tools

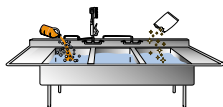

3-Compartment Sink



Scrub Pad



Instructions

1. Lift grease box up and off.
2. Wash with a scrub pad, rinse, and sanitize in the 3-compartment sink.

Feed End



Awning

Clean: Daily



Tools

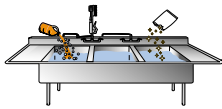

3-Compartment Sink



No-Scratch Pad



Heat Resistant Gloves



Instructions

1. Tilt and lift pins off hooks; pull out.
2. Wash, rinse, and sanitize in the 3-compartment sink.

Discharge End



Return Slide with Dividers

Clean: Daily



Tools



Heat Resistant Gloves



Scrub Pad

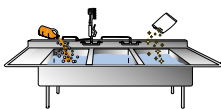

3-Compartment Sink



Instructions

1. Lift return slide up and off.
2. Lift dividers off.
3. Wash, rinse, and sanitize in the 3-compartment sink.

REASSEMBLY: Be sure to replace all 3 dividers back on the return slide.

Discharge End



Stripper Blade

Clean: Daily



Tools



Heat Resistant Gloves



Scrub Pad



Degreaser

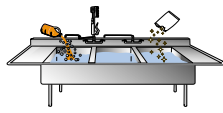

3-Compartment Sink



Instructions

1. Tilt stripper blade away from chain; lift off brackets.
2. Take to sink area and spray with degreaser.
3. Wash with a scrub pad, rinse, and sanitize in the 3-compartment sink.

REASSEMBLY: Hang stripper blade on brackets.

Discharge End



Side Panels and Chain Shafts

Clean: Daily



Tools



No-Scratch Pad



Towel



Degreaser



Shaft Cleaning Tool



Instructions

1. Lift Side Panels up and off.
2. Take to sink area and spray with degreaser. Wipe clean with a no-scratch pad.
3. Scrape each shaft of both belts on the discharge end with the wide end of the shaft cleaning tool. The tool is located on the clip on the discharge end of the broiler.
4. Wipe shaft cleaning tool with a towel.

Sides & Discharge End

1



2





Tools



No-Scratch Pad



Towel



Degreaser



Instructions

1. Use a no-scratch pad and degreaser to wipe the frame clean.

Inside



Lower Burners (2)



Tools



Heat Resistant Gloves



Soft Bristle Brush



Small Orifice Brush



Instructions

1. Open the side access door.
2. Slide burner out.
3. Brush with a dry brush.
4. If necessary, use the small orifice brush to clean any clogged burner holes.
5. Repeat steps for all burners.

! DO NOT use water or get the burners wet.

+ REASSEMBLY: Be sure the holes on the burner are facing up.

Side



No water

Lower Burner Shields (2)

Clean: Monthly



Tools



Heat Resistant Gloves

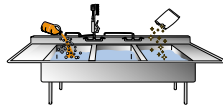

3-Compartment Sink



Scrub Pad



Instructions

1. Lift up and pull towards you.
2. Let shield drop down to clear brackets.
3. Slide shield out through opening.
4. Wash with a scrub pad, rinse, and sanitize in the 3-compartment sink.

REASSEMBLY: Make sure shields are seated properly on brackets.

Side

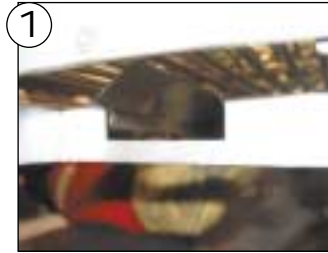

Perforated Cap - If no catalyst

Clean: Monthly



Tools



Heat Resistant Gloves



Scrub Pad



Degreaser

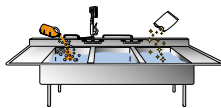

3-Compartment Sink



Instructions



EXTREMELY HOT! Be careful not to burn yourself.

1. Lift cap from shroud collar.
2. Take to sink area and spray with degreaser.
3. Wash with a scrub pad, rinse, and sanitize in the 3-compartment sink.

Top



CAUTION:
Extremely Hot 

Catalyst - If no perforated cap

Clean: Monthly



Tools



Heat Resistant Gloves



Instructions



EXTREMELY HOT! Be careful not to burn yourself.

1. Grasp handle and lift Catalyst off to remove from Shroud.
2. RINSE WITH WATER ONLY. NEVER USE ANY CHEMICALS ON THE CATALYST.
3. Lay flat to drain water and let air dry overnight.
4. Make sure catalyst is dry before putting back on broiler.

Top



CAUTION:
Extremely Hot 

Shroud

Clean: Monthly



Tools



Heat Resistant Gloves



No-Scratch Pad



Degreaser

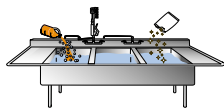

3-Compartment Sink



Instructions

1. Lift shroud from top of broiler.
2. Take to sink area and spray with degreaser.
3. Wash, rinse, and sanitize in the 3-compartment sink.

Top



Upper Burners (2)

Clean: Monthly



Tools



Heat Resistant Gloves



Soft Bristle Brush



Instructions

1. Lift each burner up and out of broiler.
2. Use a soft bristle brush to brush burner.

 **DO NOT use water on burners.**



No water

Top



Orifices

Clean: Monthly



Tools



Small Orifice Brush



Instructions

1. Clean orifices using the small orifice brush.

NOTE: There are 2 upper burner orifices and 2 lower burner orifices on the left side of the broiler.

Inside

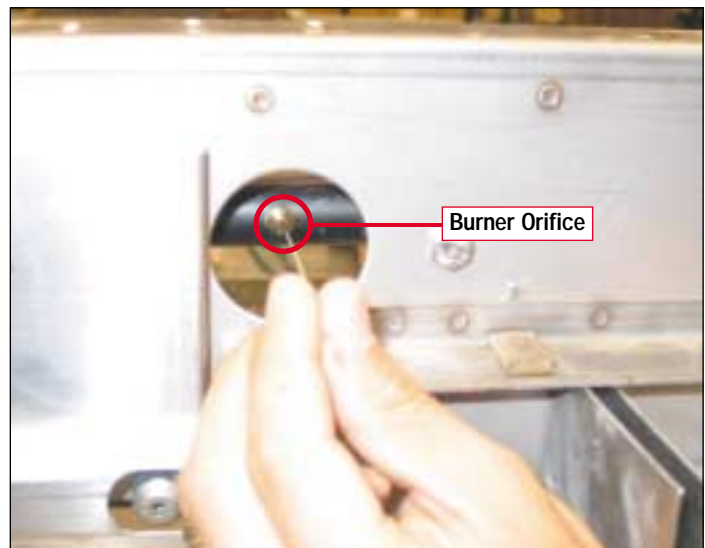



Tools



Large Orifice Brush



Lizard Safety
Utility Knife



Instructions

1. Clean the slots on the pilot burners with a lizard knife.



Be careful not to cut yourself!

2. Clean the pilot orifices using the large orifice brush.

Inside



F. BROIL CHAIN REMOVAL

Maintain proper tension on the conveyor chains to prevent jamming. Major tension adjustments are made by removing a link or links from the chain. Broil belt tension should be checked monthly. To do this, allow the machine to cool, then grip the idler shaft at each end and pull on it. If the shaft and bearings move 1/2" or more, remove a link from the conveyor belt. Before beginning, notice the way the broil chain runs through the broiler. Also, notice the direction the chain knuckles face. Be sure to reassemble the same way.

1

Run chain until the master link is near the front idler shaft.

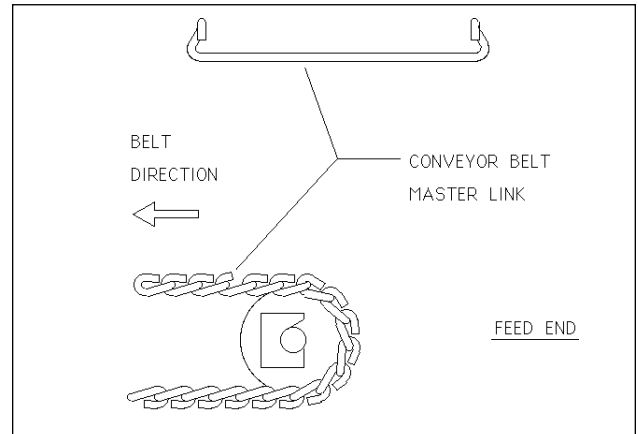

2

Remove the loader bracket and lift shaft and teflon bearings up, and slide the bearings out.



3

Unhook the master link.



⚠ CAUTION ⚠

To ensure proper broiler operation be sure to reassemble the chain with the knuckle opening facing away from the direction of travel.

G. PARTS LOCATION DRAWINGS

G.1 N1535 Removable Parts

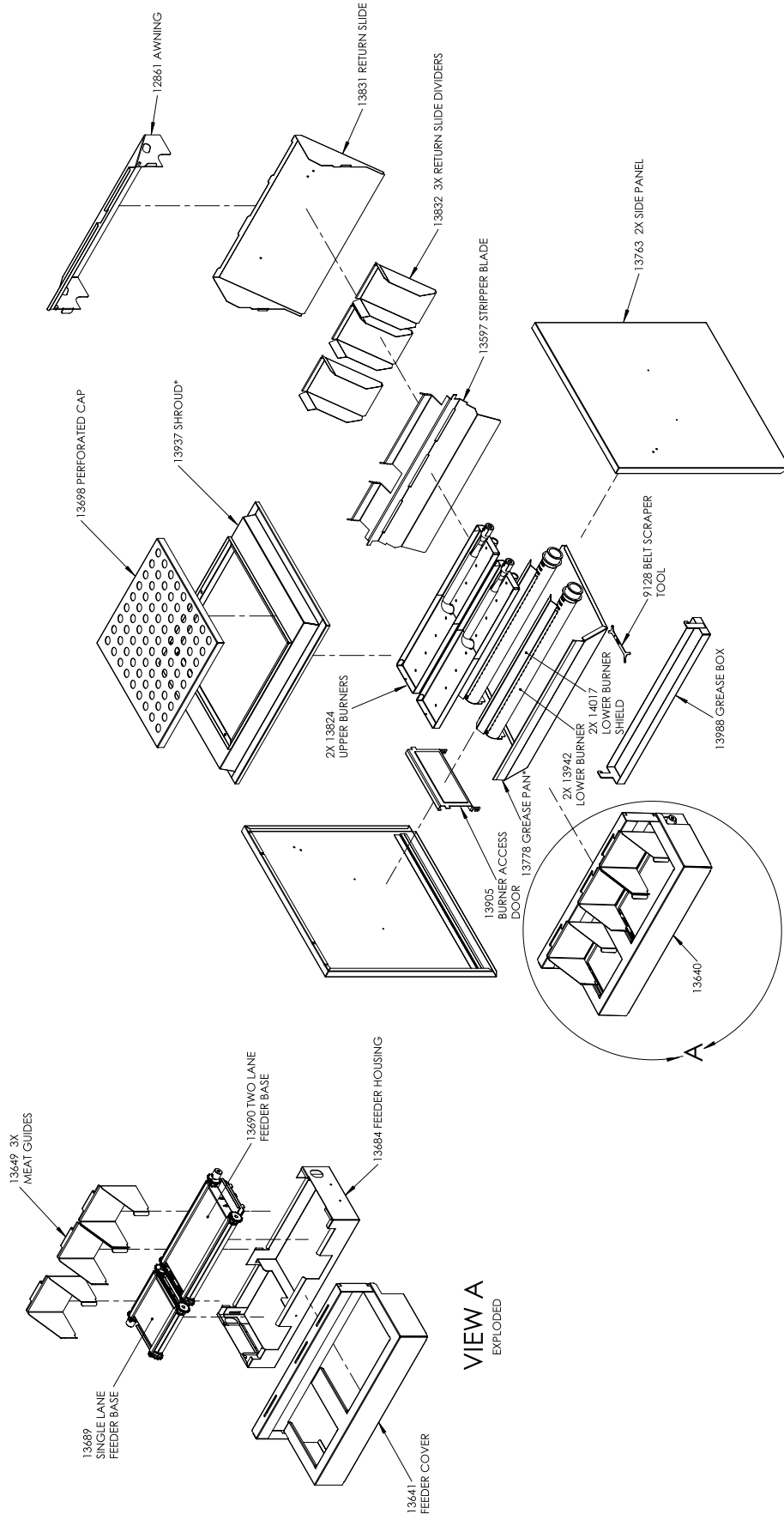

*IF EQUIPPED WITH A CATALYST, USE:
 P/N 14393 18" X 24" SHRULD
 P/N 14686 LOUVERED GREASE PAN

VIEW A
 EXPLODED

G. PARTS LOCATION DRAWINGS

G.2 N1535 Feed/Discharge End Views

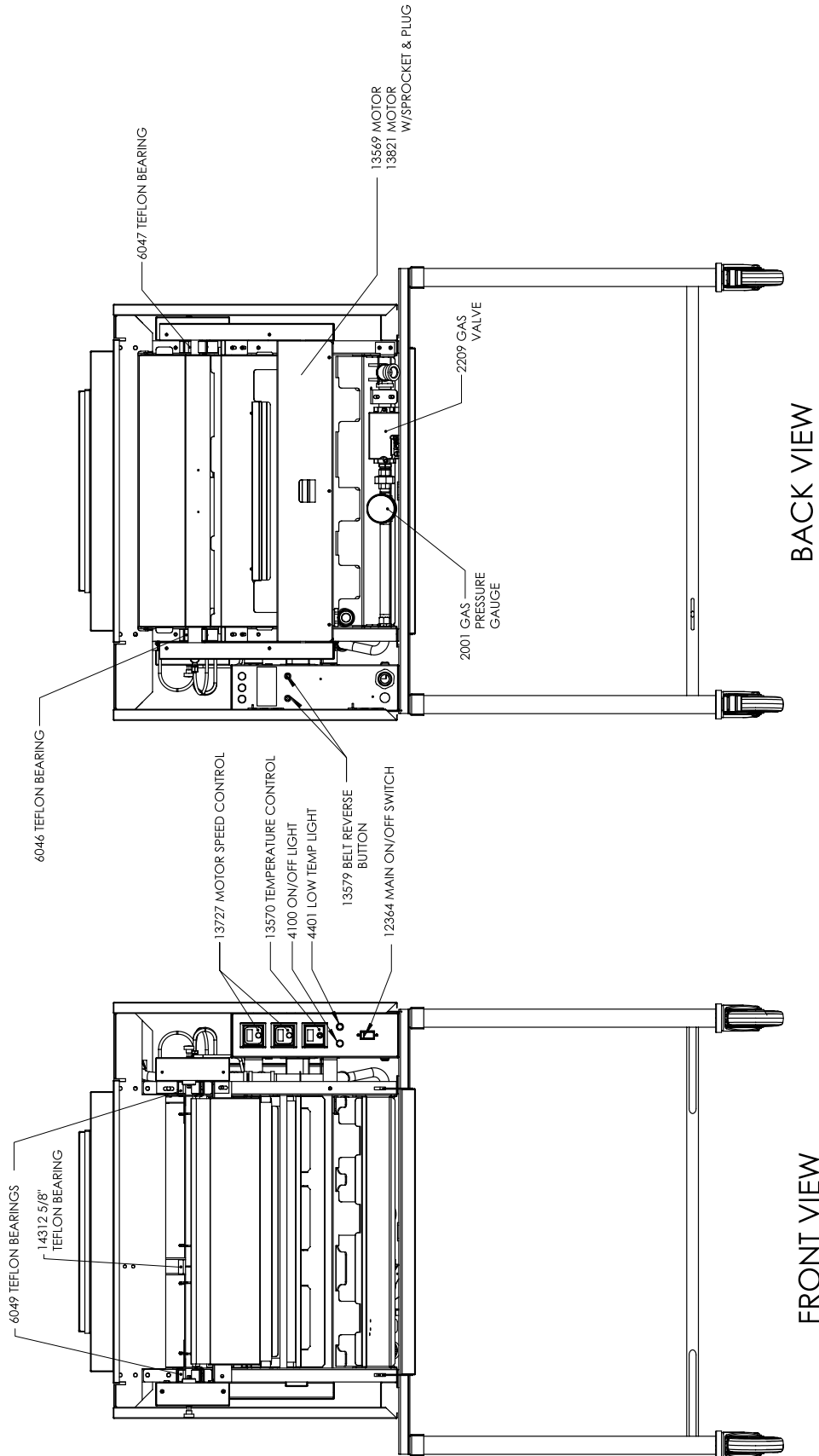

G. PARTS LOCATION DRAWINGS

G.3 N1535 Right Side View

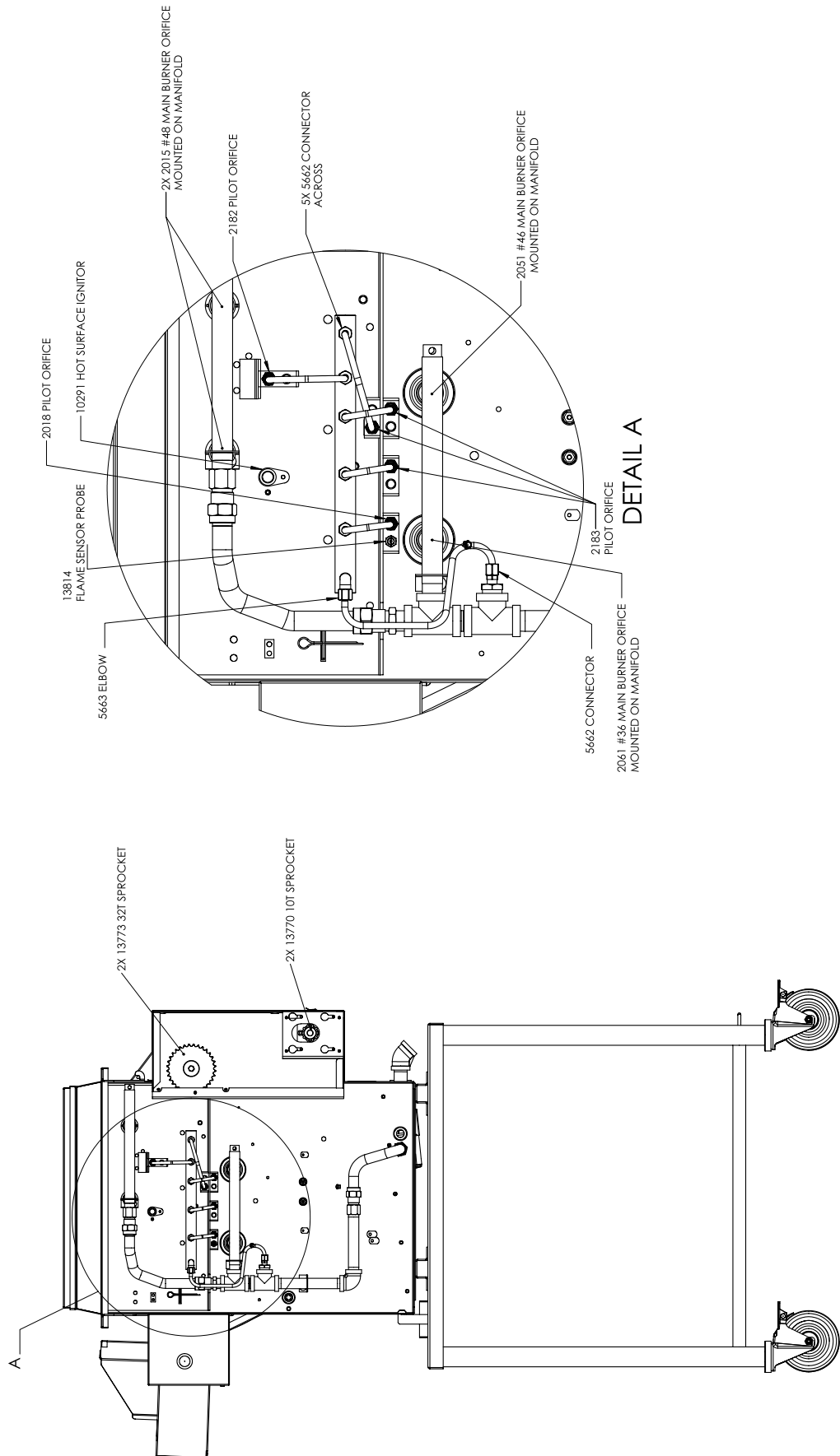

H. SPECIFICATIONS



AUTOMATIC BROILER Model N1535 G

DIMENSIONS	INCH	MM
Length	36.58	929
Height	63.36*	1609
Width	37.38	950

* The N1535 comes with a stand included. Broiler must be mounted on provided stand.

ENERGY - GAS MODELS

Gas connection 3/4" N.P.T.

Electrical connection (specify exact voltage)

Domestic 115V IØ 50/60Hz 7A

Natural Gas	3" W.C.	5" W.C.
BTU/hr	71,200	86,600

WEIGHT	LB	KG
Shipping	440	200

EXHAUST	CFM	CMH
Typical	600	1020

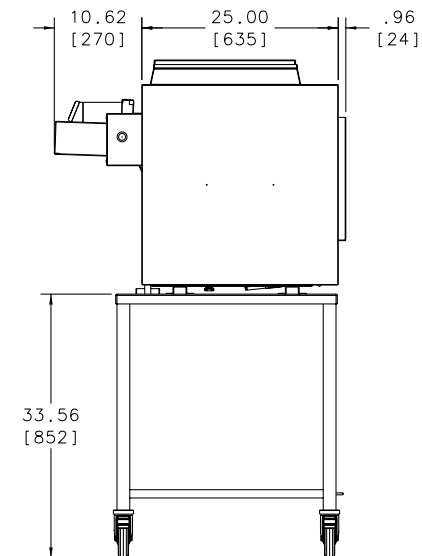
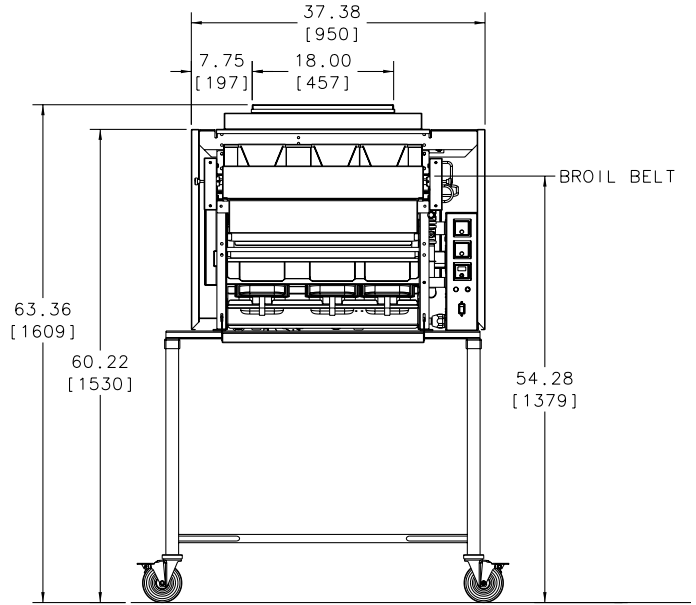

⚠ CAUTION ⚠

All electrical connections must be in accordance with local electrical codes and any other applicable codes.

⚠ CAUTION ⚠

Do not operate the broiler at gas pressures other than those stated here. Doing so will affect the operation of your broiler.

J. WARRANTY INFORMATION

February, 2003

Nieco Automatic Broiler Warranty for Yum! Broilers

This warranty is effective for all broilers listed in Appendix A, shipped after the test period. This warranty is valid for Nieco Broilers in the US and worldwide, to the extent possible due to specific warranty laws, requirements, commercial practices or customs in various countries.

Your new Nieco Automatic Broiler is guaranteed against original defects in manufacture of machines and component parts for one year. This one-year guarantee is subject to certain conditions and limitations as listed below.

Generally, your guarantee provides replacement of all parts which fail due to defects in manufacture for one year after startup of the machine. Parts purchased, not manufactured, by Nieco, are covered by the original manufacturer's warranty. Parts which fail will be replaced by the Nieco distributor or Service Center in your area who did the startup service. If the part is a customer installed component, the part will be sent to you to replace the defective part on your machine, yourself. If the part is one listed in Appendix A, your Service Center will provide the labor to replace it, subject to certain conditions noted below. The parts which will be replaced for you are generally parts which require a certain or higher service level for installation, calibration or adjustment. The parts that will be installed/replaced for you are listed in Appendix A. They are listed by broiler model.

If your broiler has a manufacturing defect which requires service labor to repair, those repairs will be performed by your startup Nieco Service Center or Distributor. Those repairs will be performed subject to certain conditions as mentioned below.

Nieco guarantees the correct mechanical operation of the equipment at the time of startup of the machine by an authorized Nieco servicer. Nieco makes no warranty, expressed or implied, of broiling effect or of exact capacity as subjective judgment, product variations and/or customer-caused machine conditions beyond Nieco's ability to predict or control may alter the broiling performance of the machine. Both Yum! and Nieco have extensively tested Nieco broilers prior to Yum!'s approval of Nieco broilers for Yum! system products and restaurants.

Nieco specifically does not warrant or guarantee or provide compensation for any lost production, lost product, lost labor or lost sales or other consequential damages that may occur as a result of equipment malfunction or failure. This disclaimer of liability for consequential damages applies whether the cause of malfunction or failure is otherwise covered by our warranty or not. In any event, Nieco's liability shall be limited to replacement of the equipment or return of the equipment and refund of the original purchase price.

When you purchased your Nieco broiler, startup service was included in the purchase price if you are located in a territory covered by a Nieco Distributor or Service Center. This startup service is not delivery or installation or hookup. The startup service is to verify the correct mechanical operation and broiling performance of the machine, make any necessary adjustments and calibrations and provide answers to any machine questions about operations, cleaning, assembly or re-assembly. The startup service is not a training service; however, your servicer will provide all information they can about the machine. The servicing Nieco Distributor or Service Center will provide all warranty and after-sales service and parts to you.

Startup of your machine by an authorized Nieco Service Center or Distributor is required to validate your warranty. This validation may be done directly with the factory if the startup is done by the customer or by a non-Nieco servicer. Nieco does not provide startup compensation to non-Nieco servicers. Nieco does validation automatically upon receipt of the startup report from your servicer. We strongly recommend you assure validation by returning the warranty card shipped with the machine. If an authorized Nieco servicer did not perform a startup, warranty will be validated upon receipt of your warranty card. If a startup is not performed and submitted to the factory, the warranty period starts on the date the machine was shipped from the factory, since no other dates are confirmed by a Nieco authorized servicer.

The Nieco parts and labor warranty does not cover the following:

- **Ordinary wear and tear, deterioration or damage and consumable parts**
- **Deterioration will be accelerated due to the use of some additives on or in the product prior to cooking. Specifically, deterioration of the broiling chains due to the use of salt is expected and chains are considered consumable parts.**
- **All burning components are considered consumable parts, and will require periodic replacement. Burning component parts and labor are covered from manufacturers defects for their initial six months of service, only (NOT one year). These burning components include gas burners of all types, protective shields, reverberators, electric elements, pilot lights, thermocouples, or gas orifices of any type.**
- **Defects in parts or performance caused by improper or non-cleaning, maintenance or adjustment.**
- **Adjustments and re-calibrations are not covered by warranty except when a part needing such is replaced under warranty by a Nieco servicer.**
- **Misuse or improper cleaning, handling or assembly of the broiler, feeder and other components.**
- **Specifically, feeder pusher bars are susceptible to mishandling and improper assembly due to the frequency required of cleaning the feeder**
- **External causes of defective performance. This includes gas and electrical supply and hookup parts and all exhaust components and exhaust adjustment.**
- **Machines that have been improperly repaired by non-Nieco servicers.**
- **Machines with parts installed which are not approved by Nieco. Approved parts are available from your Nieco Service Center, Distributor or other Yum! authorized sources. No other parts have been tested or approved by Nieco and no other parts have been approved as a component of the broiler by approval agencies including NSF, CSA, CE and AGA.**

Warranty items, labor or parts are available only from your Nieco Service Center, Distributor or other Yum! authorized source who started up your machine unless other arrangements, as described below, are made with Nieco.

Labor warranty is additionally subject to these limitations:

Labor warranty work is to be performed during regular working hours. Off-hour labor will be subject to additional charges by the servicer, which are not covered by warranty. One-hour travel in each direction to the restaurant from the servicer's place of business is included. Restaurants in more distant or remote locations may be charged additional travel time or overnight accommodation, if necessary.

Your Nieco Service Center or Distributor will make warranty decisions. Nieco has provided our servicers with guidelines for warranty work and standards for repair time. If your warranty claim is rejected by your Nieco servicer, you are required to pay the servicer even though you dispute the charge. To dispute any warranty decision, first contact the Service Center or Distributor principals. If you are not satisfied, contact your Nieco Regional Manager or the Nieco Technical Services Manager. Nieco will immediately investigate your claim and make a warranty decision. If you have paid your servicer and your claim is honored, your money will be refunded. You are responsible for paying the servicer when due, however, regardless of the status of any claim.

If you are supplied warranty parts without warranty labor, Nieco or your warranty parts supplier may require the parts to be returned to the factory as a condition of receiving the warranty parts. This is particularly true of high value important components as motors and controls, computer boards, or any parts showing a pattern of failure. If a return is required, Nieco will pay the return freight cost and give instructions via your servicer on how you should return the parts.

Warranty parts will be shipped by your Distributor or Service Center from their parts center by the least expensive means; if they do not have the part in stock, Nieco will pay first destination freight using UPS ground or other similar service. If you require more immediate shipment, you will be charged the additional cost for this expedited freight service.

If you have qualified maintenance employees or wish to use a qualified non-Nieco agency for warranty labor service otherwise covered under this Nieco warranty, your or your servicer may apply to your Nieco Regional Manager for certification as an alternate Nieco servicer. Such servicer shall be solely responsible to the using-customer for all actions and liabilities. If the Nieco Regional Manager qualifies such servicer, Nieco will pay scheduled warranty allowances to the customer for warranty work performed by these alternative servicers. Nieco will provide this schedule and limitations when the servicer is qualified and accepted.

Appendix A

This schedule lists parts for the Yum! approved Nieco broilers as of the date shown below. Nieco may, from time to time, add, alter, or delete specific parts as the machine specifications or parts availability changes. A current schedule can be obtained from Nieco. You may also access this information on the Nieco website, www.nieco.com, using your user access password. This password is available from Nieco or your Nieco servicer.

YUM! MODEL N1535
LABOR WARRANTY REPLACEMENT PARTS
February 20, 2003

The below listed parts qualify for field labor replacement by your local Authorized Nieco Servicer for a period of 12 months from date of startup as outlined in the above warranty policy:

Ignition and Gas System

Solenoid Valves (all)
Regulator
Gas Gauge
Combination Gas Valve
Thermocouples/temperature probes (all)
Hot Surface Ignitor (Glow Plug), control module and flame sensors

Electric Elements

Metal-sheathed Electric Elements (all)

Drive Motor and Electrical Components

Motor
Main Switch
Transformer
Motor Reset Switch
Circuit Breaker
Power Supply

Stack Feeder

Engagement Pin Assembly
Clutch

IMPORTANT

The Nieco Corporation reserves the right to change specifications and product design without notice. Such revisions do not entitle the buyer to corresponding changes, improvements, additions or replacements for previously purchased equipment.



Nieco Corporation • 7950 Cameron Drive • Windsor, CA 95492 • (707) 284-7100 Office • (707) 284-7430 Fax
10/03 www.nieco.com • e-mail:service@nieco.com Printed in the USA © 2002 Nieco Corporation All Rights Reserved
Reorder P/N 9999-99151 FOR REVISION 4