

## SERVICE MANUAL R410A

**No. OCH577**  
**REVISED EDITION-A**

### Outdoor unit

#### [Model Name]

PUZ-A18NHA6  
PUZ-A24NHA6  
PUZ-A30NHA6  
PUZ-A36NHA6  
PUZ-A42NHA6  
PUZ-A18NHA6-BS  
PUZ-A24NHA6-BS  
PUZ-A30NHA6-BS  
PUZ-A36NHA6-BS  
PUZ-A42NHA6-BS  
  
PUY-A12NHA6  
PUY-A18NHA6  
PUY-A24NHA6  
PUY-A30NHA6  
PUY-A36NHA6  
PUY-A42NHA6  
PUY-A12NHA6-BS  
PUY-A18NHA6-BS  
PUY-A24NHA6-BS  
PUY-A30NHA6-BS  
PUY-A36NHA6-BS  
PUY-A42NHA6-BS

#### [Service Ref.]

PUZ-A18NHA6  
PUZ-A24NHA6  
PUZ-A30NHA6  
PUZ-A36NHA6  
PUZ-A42NHA6  
PUZ-A18NHA6-BS  
PUZ-A24NHA6-BS  
PUZ-A30NHA6-BS  
PUZ-A36NHA6-BS  
PUZ-A42NHA6-BS  
  
PUY-A12NHA6  
PUY-A18NHA6  
PUY-A24NHA6  
PUY-A30NHA6  
PUY-A36NHA6  
PUY-A42NHA6  
PUY-A12NHA6-BS  
PUY-A18NHA6-BS  
PUY-A24NHA6-BS  
PUY-A30NHA6-BS  
PUY-A36NHA6-BS  
PUY-A42NHA6-BS

#### Revision:

- Updated the table in "1. REFERENCE MANUAL" in REVISED EDITION-A.
- Some descriptions have been modified.

- Please void OCH577.

#### Notes:

- This manual describes service data of the outdoor units only.
- RoHS compliant products have <G> mark on the spec name plate.

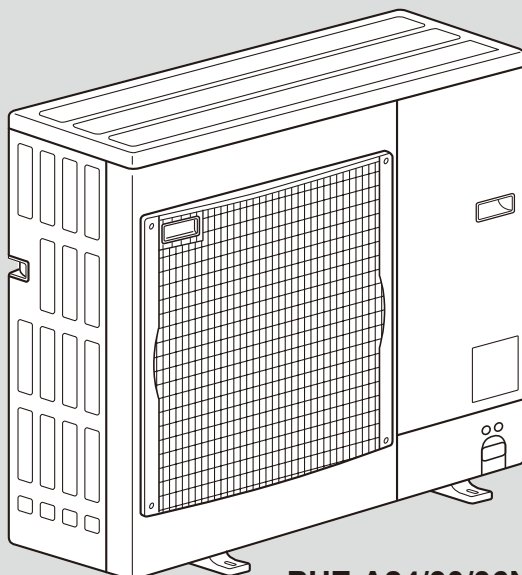

PUZ-A24/30/36NHA6  
PUY-A24/30/36NHA6

## CONTENTS

|  |     |
|--|-----|
| 1. REFERENCE MANUAL .....  | 2   |
| 2. SAFETY PRECAUTION .....                                       | 2   |
| 3. FEATURES .....  | 6   |
| 4. SPECIFICATIONS .....  | 7   |
| 5. DATA .....  | 9   |
| 6. OUTLINES AND DIMENSIONS .....                                 | 13  |
| 7. WIRING DIAGRAM .....  | 16  |
| 8. WIRING SPECIFICATIONS .....                                   | 20  |
| 9. REFRIGERANT SYSTEM DIAGRAM .....                              | 23  |
| 10. TROUBLESHOOTING .....  | 26  |
| 11. EASY MAINTENANCE FUNCTION .....                              | 91  |
| 12. FUNCTION SETTING .....                                       | 95  |
| 13. MONITORING THE OPERATION DATA BY THE REMOTE CONTROLLER ..... | 105 |
| 14. DISASSEMBLY PROCEDURE .....                                  | 114 |

**PARTS CATALOG (OCB577)**



# 1

# REFERENCE MANUAL

## INDOOR UNIT

| Model name                     | Service Ref.                         | Service manual No. |
|--------------------------------|--------------------------------------|--------------------|
| PLA-A12/18/24/30/36/42BA6      | PLA-A12/18/24/30/36/42BA6            | OCH581<br>OCB581   |
| PCA-A24/30/36/42KA6            | PCA-A24/30/36/42KA6.TH               | OCH585<br>OCB585   |
| PCA-A24/30/36KA4<br>PCA-A42KA5 | PCA-A24/30/36KA4.TH<br>PCA-A42KA5.TH | OCH501<br>OCB501   |
| PKA-A12/18HA6                  | PKA-A12/18HA6                        | OCH580<br>OCB580   |
| PKA-A24/30/36KA6               | PKA-A24/30/36KA6.TH                  | OCH584<br>OCB584   |
| PEA-A12/18AA6                  | PEA-A12/18AA6                        | HWE0807            |
| PEAD-A24/30/36/42AA5           | PEAD-A24/30/36/42AA5                 | HWE14030           |

# 2

# SAFETY PRECAUTION

## 2-1. ALWAYS OBSERVE FOR SAFETY

**Before obtaining access to terminal, all supply circuits must be disconnected.**

### Preparation before the repair service.

- Prepare the proper tools.
- Prepare the proper protectors.
- Provide adequate ventilation.
- After stopping the operation of the air conditioner, turn off the power-supply breaker.
- Discharge the condenser before the work involving the electric parts.

### Precautions during the repair service.

- Do not perform the work involving the electric parts with wet hands.
- Do not pour water into the electric parts.
- Do not touch the refrigerant.
- Do not touch the hot or cold areas in the refrigerating cycle.
- When the repair or the inspection of the circuit needs to be done without turning off the power, exercise great caution not to touch the live parts.

## 2-2. CAUTIONS RELATED TO NEW REFRIGERANT

### Cautions for units utilizing refrigerant R410A

#### Use new refrigerant pipes.

In case of using the existing pipes for R22, be careful with the following:

- Be sure to clean the pipes and make sure that the insides of the pipes are clean.
- Change flare nut to the one provided with this product. Use a newly flared pipe.
- Avoid using thin pipes.

**Make sure that the inside and outside of refrigerant piping is clean and it has no contaminants such as sulfur, oxides, dirt, shaving particles, etc, which are hazard to refrigerant cycle. In addition, use pipes with specified thickness.**

Contamination inside refrigerant piping can cause deterioration of refrigerant oil, etc.

**Store the piping to be used indoors during installation and both ends of the piping sealed until just before brazing. (Leave elbow joints, etc. in their packaging.)**

If dirt, dust or moisture enters into refrigerant cycle, that can cause deterioration of refrigerant oil or malfunction of compressor.

**The refrigerant oil applied to flare and flange connections must be ester oil, ether oil or alkylbenzene oil in a small amount.**

If large amount of mineral oil enters, that can cause deterioration of refrigerant oil, etc.

**Charge refrigerant from liquid phase of gas cylinder.**

If the refrigerant is charged from gas phase, composition change may occur in refrigerant and the efficiency will be lowered.

**Do not use refrigerant other than R410A.**

If other refrigerant (R22, etc.) is used, chlorine in refrigerant can cause deterioration of refrigerant oil, etc.

**Use a vacuum pump with a reverse flow check valve.**

Vacuum pump oil may flow back into refrigerant cycle and that can cause deterioration of refrigerant oil, etc.

**Use the following tools specifically designed for use with R410A refrigerant.**

The following tools are necessary to use R410A refrigerant.

| Tools for R410A   |                                       |
|-------------------|---------------------------------------|
| Gauge manifold    | Flare tool                            |
| Charge hose       | Size adjustment gauge                 |
| Gas leak detector | Vacuum pump adaptor                   |
| Torque wrench     | Electronic refrigerant charging scale |

**Handle tools with care.**

If dirt, dust or moisture enters into refrigerant cycle, that can cause deterioration of refrigerant oil or malfunction of compressor.

**Do not use a charging cylinder.**

If a charging cylinder is used, the composition of refrigerant will change and the efficiency will be lowered.

**Ventilate the room if refrigerant leaks during operation. If refrigerant comes into contact with a flame, poisonous gases will be released.**

**Use the specified refrigerant only.**

**Never use any refrigerant other than that specified.** Doing so may cause a burst, an explosion, or fire when the unit is being used, serviced, or disposed of. Correct refrigerant is specified in the manuals and on the spec labels provided with our products. We will not be held responsible for mechanical failure, system malfunction, unit breakdown or accidents caused by failure to follow the instructions.

## [1] Cautions for service

- (1) Perform service after recovering the refrigerant left in unit completely.
- (2) Do not release refrigerant in the air.
- (3) After completing service, charge the cycle with specified amount of refrigerant.
- (4) When performing service, install a filter drier simultaneously.  
Be sure to use a filter drier for new refrigerant.

## [2] Additional refrigerant charge

### When charging directly from cylinder

- Check that cylinder for R410A on the market is a syphon type.
- Charging should be performed with the cylinder of syphon stood vertically. (Refrigerant is charged from liquid phase.)

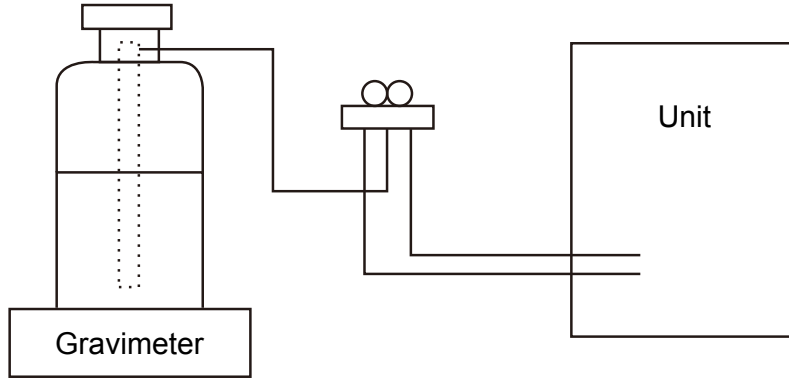

## [3] Service tools

Use the below service tools as exclusive tools for R410A refrigerant.

| No. | Tool name                      | Specifications  |
|-----|--------------------------------|---|
| ①   | Gauge manifold                 | · Only for R410A                                      |
|     |                                | · Use the existing fitting specifications.            |
|     |                                | · Use high-tension side pressure of 5.3MPa-G or over. |
| ②   | Charge hose                    | · Only for R410A                                      |
|     |                                | · Use pressure performance of 5.09MPa-G or over.      |
| ③   | Electronic scale               | —   |
| ④   | Gas leak detector              | · Use the detector for R134a, R407C or R410A          |
| ⑤   | Adaptor for reverse flow check | · Attach on vacuum pump.                              |
| ⑥   | Refrigerant charge base        | —   |
| ⑦   | Refrigerant cylinder           | · Only for R410A      · Top of cylinder (Pink)        |
|     |                                | · Cylinder with syphon                                |
| ⑧   | Refrigerant recovery equipment | —   |

## 2-3. CAUTIONS FOR REFRIGERANT PIPING WORK

New refrigerant R410A is adopted for replacement inverter series. Although the refrigerant piping work for R410A is same as for R22, exclusive tools are necessary so as not to mix with different kind of refrigerant. Furthermore as the working pressure of R410A is 1.6 times higher than that of R22, their sizes of flared sections and flare nuts are different.

### ① Thickness of pipes

Since the working pressure of R410A is higher compared to R22, be sure to use refrigerant piping with thickness shown below. (Never use pipes of 7/256 in [0.7 mm] or below.)

Diagram below: Piping diameter and thickness

| Nominal dimensions (in) | Outside diameter (mm) | Thickness : in [mm] |             |
|-------------------------|-----------------------|---------------------|-------------|
|                         |                       | R410A               | R22         |
| 1/4                     | 6.35                  | 1/32 [0.8]          | 1/32 [0.8]  |
| 3/8                     | 9.52                  | 1/32 [0.8]          | 1/32 [0.8]  |
| 1/2                     | 12.70                 | 1/32 [0.8]          | 1/32 [0.8]  |
| 5/8                     | 15.88                 | 5/128 [1.0]         | 5/128 [1.0] |
| 3/4                     | 19.05                 | —                   | 5/128 [1.0] |

② Dimensions of flare cutting and flare nut

The component molecules in HFC refrigerant are smaller compared to conventional refrigerants. In addition to that, R410A is a refrigerant, which has higher risk of leakage because its working pressure is higher than that of other refrigerants. Therefore, to enhance air tightness and strength, flare cutting dimension of copper pipe for R410A has been specified separately from the dimensions for other refrigerants as shown below. The dimension B of flare nut for R410A also has partly been changed to increase strength as shown below. Set copper pipe correctly referring to copper pipe flaring dimensions for R410A below. For 1/2 and 5/8 inch pipes, the dimension B changes. Use torque wrench corresponding to each dimension.

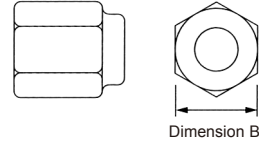
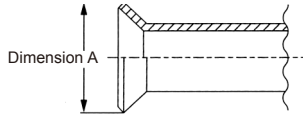

Flare cutting dimensions

| Nominal dimensions (in) | Outside diameter (mm) | Dimension A ( $^{+0}_{-0.4}$ ) |          |
|-------------------------|-----------------------|--------------------------------|----------|
|                         |                       | R410A (in [mm])                | R22 (mm) |
| 1/4                     | 6.35                  | 11/32-23/64 [9.1]              | 9.0      |
| 3/8                     | 9.52                  | 1/2-33/64 [13.2]               | 13.0     |
| 1/2                     | 12.70                 | 41/64-21/32 [16.6]             | 16.2     |
| 5/8                     | 15.88                 | 49/64-25/32 [19.7]             | 19.4     |
| 3/4                     | 19.05                 | —                              | 23.3     |

Flare nut dimensions

| Nominal dimensions (in) | Outside diameter (mm) | Dimension B     |          |
|-------------------------|-----------------------|-----------------|----------|
|                         |                       | R410A (in [mm]) | R22 (mm) |
| 1/4                     | 6.35                  | 43/64 [17.0]    | 17.0     |
| 3/8                     | 9.52                  | 7/8 [22.0]      | 22.0     |
| 1/2                     | 12.70                 | 1-3/64 [26.0]   | 24.0     |
| 5/8                     | 15.88                 | 1-9/64 [29.0]   | 27.0     |
| 3/4                     | 19.05                 | —               | 36.0     |

③ Tools for R410A (The following table shows whether conventional tools can be used or not.)

| Tools and materials                                      | Use   | R410A tools  | Can R22 tools be used?                               |
|--|---|--|--|
| Gauge manifold   | Air purge, refrigerant charge and operation check   | Tool exclusive for R410A   | ×  |
| Charge hose  | Gas leak check  | Tool exclusive for R410A   | ×  |
| Gas leak detector  | Collection of refrigerant   | Tool for HFC refrigerant   | ×  |
| Refrigerant recovery equipment                           | Refrigerant charge  | Tool exclusive for R410A   | ×  |
| Refrigerant cylinder                                     | Apply to flared section   | Ester oil, ether oil and alkylbenzene oil (minimum amount)                               | ×  |
| Applied oil  | Prevent compressor malfunction when charging refrigerant by spraying liquid refrigerant                         | Tool exclusive for R410A   | ×  |
| Safety charger   | Prevent gas from blowing out when detaching charge hose   | Tool exclusive for R410A   | ×  |
| Charge valve   | Vacuum drying and air purge   | Tools for other refrigerants can be used if equipped with adapter for reverse flow check | △ (Usable if equipped with adapter for reverse flow) |
| Vacuum pump  | Flaring work of piping  | Tools for other refrigerants can be used by adjusting flaring dimension                  | △ (Usable by adjusting flaring dimension)            |
| Flare tool   | Bend the pipes  | Tools can be used for other refrigerants   | ○  |
| Bender   | Cut the pipes   | Tools can be used for other refrigerants   | ○  |
| Pipe cutter  | Weld the pipes  | Tools can be used for other refrigerants   | ○  |
| Welder and nitrogen gas cylinder                         | Refrigerant charge  | Tools can be used for other refrigerants   | ○  |
| Refrigerant charging scale                               | Check the degree of vacuum. (Vacuum valve prevents back flow of oil and refrigerant to thermistor vacuum gauge) | Tools can be used for other refrigerants   | ○  |
| Vacuum gauge or thermistor vacuum gauge and vacuum valve | Refrigerant charge  | Tool exclusive for R410A   | ×  |
| Charging cylinder  |   |  |  |

× : Prepare a new tool. (Use the new tool as the tool exclusive for R410A.)

△ : Tools for other refrigerants can be used under certain conditions.

○ : Tools for other refrigerants can be used.

## 2-4. LOW AMBIENT COOLING

### Precautions for low ambient cooling

- If the outdoor temperature is 23°F or lower during cooling operation, install an optional air guide to prevent wind from blowing into the outdoor unit.
- Install the outdoor unit in a location where wind will not blow onto the back of the unit.
- To prevent damage to the parts, be sure to install the unit, turn on the main power, and perform service in an environment where the ambient temperature is 0 °F or higher.
- In order to protect the compressor and electrical components, do not turn off the circuit breaker if the unit is installed in an environment where the ambient temperature is 0°F or lower.
- It needs at least 4hr standby to operation in order to warm the electrical parts.

Note: During cooling operation under low ambient temperature, the bottom fan motor of A42N stops occasionally. This is an intended feature, not a malfunction.

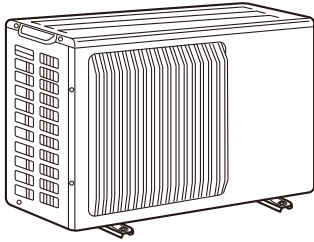

**PUZ-A18NHA6**  
**PUZ-A18NHA6-BS**  
**PUY-A12/18NHA6**  
**PUY-A12/18NHA6-BS**

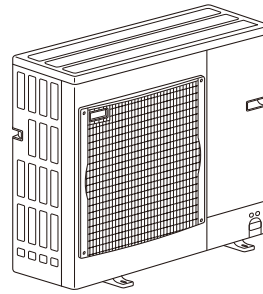

**PUZ-A24/30/36NHA6**  
**PUZ-A24/30/36NHA6-BS**  
**PUY-A24/30/36NHA6**  
**PUY-A24/30/36NHA6-BS**

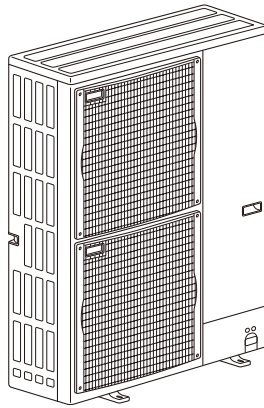

**PUZ-A42NHA6**  
**PUZ-A42NHA6-BS**  
**PUY-A42NHA6**  
**PUY-A42NHA6-BS**

### CHARGELESS SYSTEM

**PRE-CHARGED REFRIGERANT IS SUPPLIED FOR PIPING LENGTH AT SHIPMENT.**

**(Maximum 100 ft [30 m] (A42)/ Maximum 70 ft [21 m] (A12–36))**

The refrigerant circuit with LEV(Linear Expansion Valve) and accumulator always control the optimal refrigerant level regardless of the length (A42: 100 ft [30 m] maximum/ A12–36: 70 ft [20 m] maximum and 16 ft [5 m] minimum) of piping. The additional refrigerant charging work during installation often causes problems.

It is completely eliminated by chargeless system. This unique system improves the quality and reliability of the work done. It also helps to speed up the installation time.

# 4

# SPECIFICATIONS

| Service Ref.              |                  |                     | PUZ-A18NHA6<br>PUZ-A18NHA6-BS  | PUZ-A24NHA6<br>PUZ-A24NHA6-BS  | PUZ-A30NHA6<br>PUZ-A30NHA6-BS  | PUZ-A36NHA6<br>PUZ-A36NHA6-BS  | PUZ-A42NHA6<br>PUZ-A42NHA6-BS  |
|---------------------------|------------------|---------------------|--------------------------------|--------------------------------|--------------------------------|--------------------------------|--------------------------------|
| Power supply              | Phase            |                     | Single                         |                                |                                |                                |                                |
|                           | Cycle Voltage    |                     | 60 Hz<br>208/230 V             |                                |                                |                                |                                |
| MCA                       | A                |                     | 13                             | 18                             | 25                             | 25                             | 26                             |
| MOCP                      | A                |                     | 20                             | 30                             | 40                             | 40                             | 40                             |
| Breaker size              | A                |                     | 15                             | 25                             | 30                             | 30                             | 30                             |
| External finish           |                  |                     | Munsell 3Y 7.8/1.1             |                                |                                |                                |                                |
| Heat exchanger            |                  |                     | Plate fin coil                 |                                |                                |                                |                                |
| Defrost method            |                  |                     | Reverse cycle                  |                                |                                |                                |                                |
| Crankcase heater          | kW               |                     | -                              |                                |                                |                                |                                |
| Compressor                |                  |                     | Hermetic                       |                                |                                |                                |                                |
|                           | Model            |                     | SNB130FQCM1                    | TNB220FLHM                     | TNB220FLHM                     | TNB220FLHM                     | ANB33FCTMT                     |
|                           | Motor output     | kW                  | 0.9                            | 1.3                            | 1.3                            | 1.3                            | 2.5                            |
|                           | R.L.A.           |                     | 12                             | 12                             | 12                             | 12                             | 20                             |
|                           | L.R.A.           |                     | 14                             | 14                             | 17.5                           | 17.5                           | 27.5                           |
|                           | Starter type     |                     | Inverter                       |                                |                                |                                |                                |
| Fan                       | Fan(drive) × No. |                     | Propeller fan × 1              | Propeller fan × 1              | Propeller fan × 1              | Propeller fan × 1              | Propeller fan × 2              |
|                           | Fan motor output | kW                  | 0.040                          | 0.075                          | 0.075                          | 0.075                          | 0.086 + 0.086                  |
|                           | Fan motor        | F.L.A.              | 0.35                           | 0.75                           | 0.75                           | 0.75                           | 0.40 + 0.40                    |
|                           | Airflow          | m <sup>3</sup> /min | 34                             | 55                             | 55                             | 55                             | 100                            |
|                           |                  | CFM                 | 1200                           | 1940                           | 1940                           | 1940                           | 3530                           |
| Sound level               | Cooling          | dB                  | 48                             | 48                             | 48                             | 48                             | 51                             |
|                           | Heating          | dB                  | 47                             | 50                             | 50                             | 50                             | 55                             |
| Protection devices        |                  |                     | HP switch<br>Comp.shell thermo | HP switch<br>Comp.shell thermo | HP switch<br>Comp.shell thermo | HP switch<br>Comp.shell thermo | HP switch<br>Comp.shell thermo |
| Dimension                 | W                | mm                  | 800                            | 950                            | 950                            | 950                            | 950                            |
|                           | D                | mm                  | 300+23                         | 330+30                         | 330+30                         | 330+30                         | 330+30                         |
|                           | H                | mm                  | 600                            | 943                            | 943                            | 943                            | 1350                           |
|                           | W                | in                  | 31-1/2                         | 37-12/32                       | 37-12/32                       | 37-12/32                       | 37-12/32                       |
|                           | D                | in                  | 11-13/16 + 7/8                 | 13 + 1-3/16                    | 13 + 1-3/16                    | 13 + 1-3/16                    | 13 + 1-3/16                    |
|                           | H                | in                  | 23-5/8                         | 37-1/8                         | 37-1/8                         | 37-1/8                         | 53-5/32                        |
| Weight                    |                  | kg                  | 41                             | 75                             | 75                             | 75                             | 114                            |
|                           |                  | lb                  | 91                             | 165                            | 165                            | 165                            | 251                            |
| Refrigerant               |                  |                     | R410A                          |                                |                                |                                |                                |
| Charged                   |                  | kg                  | 1.7                            | 3.0                            | 3.0                            | 3.0                            | 4.5                            |
|                           |                  | lb                  | 3 + 12/16                      | 6 + 10/16                      | 6 + 10/16                      | 6 + 10/16                      | 10                             |
| Control                   |                  |                     | Linear expansion valve         |                                |                                |                                |                                |
| Oil Charged               |                  | Model               | Ether (FV50S)                  |                                |                                |                                |                                |
|                           | L                |                     | 0.65                           | 0.87                           | 0.87                           | 0.87                           | 1.4                            |
|                           | oz               |                     | 20                             | 28                             | 28                             | 28                             | 45                             |
| Refrigerant piping        | Pipe size OD     | mm                  | 6.35                           | 9.52                           | 9.52                           | 9.52                           | 9.52                           |
|                           | Liquid           | in                  | 1/4                            | 3/8                            | 3/8                            | 3/8                            | 3/8                            |
|                           | Pipe size OD     | mm                  | 12.7                           | 15.88                          | 15.88                          | 15.88                          | 15.88                          |
|                           | Gas              | in                  | 1/2                            | 5/8                            | 5/8                            | 5/8                            | 5/8                            |
| Connection method Indoor  |                  |                     | Flared                         |                                |                                |                                |                                |
| Connection method Outdoor |                  |                     | Flared                         |                                |                                |                                |                                |
| Height difference IU - OU |                  | m                   | Maximum 30                     |                                |                                |                                |                                |
|                           |                  | ft                  | Maximum 100                    |                                |                                |                                |                                |
| Piping length             |                  | m                   | Maximum 30                     | Maximum 50                     | Maximum 50                     | Maximum 50                     | Maximum 50                     |
|                           |                  | ft                  | Maximum 100                    | Maximum 165                    | Maximum 165                    | Maximum 165                    | Maximum 165                    |

| Service Ref.                 |                   | PUY-A12NHA6<br>PUY-A12NHA6-BS  | PUY-A18NHA6<br>PUY-A18NHA6-BS  | PUY-A24NHA6<br>PUY-A24NHA6-BS  | PUY-A30NHA6<br>PUY-A30NHA6-BS  | PUY-A36NHA6<br>PUY-A36NHA6-BS  | PUY-A42NHA6<br>PUY-A42NHA6-BS  |               |
|------------------------------|-------------------|--------------------------------|--------------------------------|--------------------------------|--------------------------------|--------------------------------|--------------------------------|---------------|
| Power supply                 | Phase             | Single                         |                                |                                |                                |                                |                                |               |
|                              | Cycle<br>Voltage  | 60 Hz<br>208/230 V             |                                |                                |                                |                                |                                |               |
| MCA                          | A                 | 13                             | 13                             | 18                             | 25                             | 25                             | 26                             |               |
| MOCP                         | A                 | 15                             | 20                             | 30                             | 40                             | 40                             | 40                             |               |
| Breaker size                 | A                 | 15                             | 15                             | 25                             | 30                             | 30                             | 30                             |               |
| External finish              |                   | Munsell 3Y 7.8/1.1             |                                |                                |                                |                                |                                |               |
| Heat exchanger               |                   | Plate fin coil                 |                                |                                |                                |                                |                                |               |
| Defrost method               |                   | -                              |                                |                                |                                |                                |                                |               |
| Crankcase heater             | kW                | -                              |                                |                                |                                |                                |                                |               |
| Compressor                   |                   | Hermetic                       |                                |                                |                                |                                |                                |               |
|                              | Model             | SNB130FQCM1                    | SNB130FQCM1                    | TNB220FLHM                     | TNB220FLHM                     | TNB220FLHM                     | ANB33FCTMT                     |               |
|                              | Motor output      | kW                             | 0.9                            | 0.9                            | 1.3                            | 1.3                            | 1.3                            | 2.5           |
|                              | R.L.A.            |                                | 12                             | 12                             | 12                             | 12                             | 12                             | 20            |
|                              | L.R.A.            |                                | 14                             | 14                             | 14                             | 17.5                           | 17.5                           | 27.5          |
|                              | Starter type      |                                | Inverter                       |                                |                                |                                |                                |               |
| Fan                          | Fan (drive) × No. | Propeller fan × 1              | Propeller fan × 1              | Propeller fan × 1              | Propeller fan × 1              | Propeller fan × 1              | Propeller fan × 2              |               |
|                              | Fan motor output  | kW                             | 0.040                          | 0.040                          | 0.075                          | 0.075                          | 0.075                          | 0.086 + 0.086 |
|                              | Fan motor         | F.L.A.                         | 0.35                           | 0.35                           | 0.75                           | 0.75                           | 0.75                           | 0.40 + 0.40   |
|                              | Airflow           | m <sup>3</sup> /min            | 34                             | 34                             | 55                             | 55                             | 55                             | 100           |
| Sound level                  | Cooling           | CFM                            | 1200                           | 1200                           | 1940                           | 1940                           | 1940                           | 3530          |
|                              | Heating           | dB                             | 46                             | 48                             | 48                             | 48                             | 48                             | 51            |
| Protection devices           |                   | HP switch<br>Comp.shell thermo | HP switch<br>Comp.shell thermo | HP switch<br>Comp.shell thermo | HP switch<br>Comp.shell thermo | HP switch<br>Comp.shell thermo | HP switch<br>Comp.shell thermo |               |
| Dimension                    | W                 | mm                             | 800                            | 800                            | 950                            | 950                            | 950                            | 950           |
|                              | D                 | mm                             | 300+23                         | 300+23                         | 330+30                         | 330+30                         | 330+30                         | 330+30        |
|                              | H                 | mm                             | 600                            | 600                            | 943                            | 943                            | 943                            | 1350          |
|                              | W                 | in                             | 31-1/2                         | 31-1/2                         | 37-12/32                       | 37-12/32                       | 37-12/32                       | 37-12/32      |
|                              | D                 | in                             | 11-13/16 + 7/8                 | 11-13/16 + 7/8                 | 13 + 1-3/16                    | 13 + 1-3/16                    | 13 + 1-3/16                    | 13 + 1-3/16   |
|                              | H                 | in                             | 23-5/8                         | 23-5/8                         | 37-1/8                         | 37-1/8                         | 37-1/8                         | 53-5/32       |
| Weight                       |                   | kg                             | 37                             | 40                             | 74                             | 74                             | 74                             | 112           |
|                              |                   | lb                             | 82                             | 89                             | 163                            | 163                            | 163                            | 247           |
| Refrigerant                  |                   |                                | R410A                          |                                |                                |                                |                                |               |
|                              | Charged           | kg                             | 1.3                            | 1.7                            | 3.0                            | 3.0                            | 3.0                            | 4.5           |
|                              |                   | lb                             | 2 + 14/16                      | 3 + 12/16                      | 6 + 10/16                      | 6 + 10/16                      | 6 + 10/16                      | 10            |
|                              | Control           |                                | Linear expansion valve         |                                |                                |                                |                                |               |
|                              | Oil               |                                | Ether (FV50S)                  |                                |                                |                                |                                |               |
| Charged                      | L                 | 0.65                           | 0.65                           | 0.87                           | 0.87                           | 0.87                           | 1.4                            |               |
|                              | oz                | 20                             | 20                             | 28                             | 28                             | 28                             | 45                             |               |
| Refrigerant piping           | Pipe size OD      | mm                             | 6.35                           | 6.35                           | 9.52                           | 9.52                           | 9.52                           | 9.52          |
|                              | Liquid            | in                             | 1/4                            | 1/4                            | 3/8                            | 3/8                            | 3/8                            | 3/8           |
|                              | Pipe size OD      | mm                             | 12.7                           | 12.7                           | 15.88                          | 15.88                          | 15.88                          | 15.88         |
|                              | Gas               | in                             | 1/2                            | 1/2                            | 5/8                            | 5/8                            | 5/8                            | 5/8           |
| Connection method Indoor     |                   | Flared                         |                                |                                |                                |                                |                                |               |
| Connection method Outdoor    |                   | Flared                         |                                |                                |                                |                                |                                |               |
| Height difference<br>IU - OU | m                 | Maximum 30                     | Maximum 30                     | Maximum 30                     | Maximum 30                     | Maximum 30                     | Maximum 30                     |               |
|                              | ft                | Maximum 100                    | Maximum 100                    | Maximum 100                    | Maximum 100                    | Maximum 100                    | Maximum 100                    |               |
| Piping length                | m                 | Maximum 50                     | Maximum 50                     | Maximum 69                     | Maximum 69                     | Maximum 69                     | Maximum 69                     |               |
|                              | ft                | Maximum 165                    | Maximum 165                    | Maximum 225                    | Maximum 225                    | Maximum 225                    | Maximum 225                    |               |

**5-1. REFILLING REFRIGERANT CHARGE (R410A: oz, kg)**

| Service Ref.                  | Piping length (one way) |                  |                  |                  |                  |                  |                  |                  |                  |                  |                  |                  |                    |                  |                  |                  |                  |                  |                  |                  | Factory charged  |
|-------------------------------|-------------------------|------------------|------------------|------------------|------------------|------------------|------------------|------------------|------------------|------------------|------------------|------------------|--------------------|------------------|------------------|------------------|------------------|------------------|------------------|------------------|------------------|
|                               | 50 ft                   | 60 ft            | 70 ft            | 80 ft            | 90 ft            | 100 ft           | 110 ft           | 120 ft           | 130 ft           | 140 ft           | 150 ft           | 160 ft           | 165 ft             | 170 ft           | 180 ft           | 190 ft           | 200 ft           | 210 ft           | 220 ft           | 225 ft           |                  |
|                               | 15 m                    | 18 m             | 21 m             | 24 m             | 27 m             | 30 m             | 33 m             | 37 m             | 40 m             | 43 m             | 46 m             | 49 m             | 50 m               | 52 m             | 55 m             | 58 m             | 61 m             | 64 m             | 67 m             | 69 m             |                  |
| PUY-A12NHA6<br>PUY-A12NHA6-BS | 42 oz<br>1.2 kg         | 44 oz<br>1.2 kg  | 46 oz<br>1.3 kg  | 47 oz<br>1.3 kg  | 48 oz<br>1.4 kg  | 49 oz<br>1.4 kg  | 50 oz<br>1.4 kg  | 51 oz<br>1.4 kg  | 52 oz<br>1.5 kg  | 53 oz<br>1.5 kg  | 54 oz<br>1.5 kg  | 55 oz<br>1.6 kg  | 56 oz<br>1.6 kg    | -                | -                | -                | -                | -                | -                | -                | 46 oz<br>1.3 kg  |
| PUY-A18NHA6<br>PUY-A18NHA6-BS | 56 oz<br>1.6 kg         | 58 oz<br>1.6 kg  | 60 oz<br>1.7 kg  | 61 oz<br>1.7 kg  | 62 oz<br>1.8 kg  | 63 oz<br>1.8 kg  | 64 oz<br>1.8 kg  | 65 oz<br>1.8 kg  | 66 oz<br>1.9 kg  | 67 oz<br>1.9 kg  | 68 oz<br>1.9 kg  | 69 oz<br>2.0 kg  | 70 oz<br>2.0 kg    | -                | -                | -                | -                | -                | -                | -                | 60 oz<br>1.7 kg  |
| PUY-A24NHA6<br>PUY-A24NHA6-BS | 94 oz<br>2.7 kg         | 100 oz<br>2.8 kg | 106 oz<br>3.0 kg | 109 oz<br>3.1 kg | 112 oz<br>3.2 kg | 115 oz<br>3.3 kg | 118 oz<br>3.3 kg | 121 oz<br>3.4 kg | 124 oz<br>3.5 kg | 127 oz<br>3.6 kg | 130 oz<br>3.7 kg | 133 oz<br>3.8 kg | 134.5 oz<br>3.8 kg | 136 oz<br>3.9 kg | 139 oz<br>3.9 kg | 142 oz<br>4.0 kg | 145 oz<br>4.1 kg | 148 oz<br>4.2 kg | 151 oz<br>4.3 kg | 154 oz<br>4.4 kg | 106 oz<br>3.0 kg |
| PUY-A30NHA6<br>PUY-A30NHA6-BS | 94 oz<br>2.7 kg         | 100 oz<br>2.8 kg | 106 oz<br>3.0 kg | 109 oz<br>3.1 kg | 112 oz<br>3.2 kg | 115 oz<br>3.3 kg | 118 oz<br>3.3 kg | 121 oz<br>3.4 kg | 124 oz<br>3.5 kg | 127 oz<br>3.6 kg | 130 oz<br>3.7 kg | 133 oz<br>3.8 kg | 134.5 oz<br>3.8 kg | 136 oz<br>3.9 kg | 139 oz<br>3.9 kg | 142 oz<br>4.0 kg | 145 oz<br>4.1 kg | 148 oz<br>4.2 kg | 151 oz<br>4.3 kg | 154 oz<br>4.4 kg | 106 oz<br>3.0 kg |
| PUY-A36NHA6<br>PUY-A36NHA6-BS | 94 oz<br>2.7 kg         | 100 oz<br>2.8 kg | 106 oz<br>3.0 kg | 109 oz<br>3.1 kg | 112 oz<br>3.2 kg | 115 oz<br>3.3 kg | 118 oz<br>3.3 kg | 121 oz<br>3.4 kg | 124 oz<br>3.5 kg | 127 oz<br>3.6 kg | 130 oz<br>3.7 kg | 133 oz<br>3.8 kg | 134.5 oz<br>3.8 kg | 136 oz<br>3.9 kg | 139 oz<br>3.9 kg | 142 oz<br>4.0 kg | 145 oz<br>4.1 kg | 148 oz<br>4.2 kg | 151 oz<br>4.3 kg | 154 oz<br>4.4 kg | 106 oz<br>3.0 kg |
| PUY-A42NHA6<br>PUY-A42NHA6-BS | 132 oz<br>3.7 kg        | 136 oz<br>3.9 kg | 142 oz<br>4.0 kg | 148 oz<br>4.2 kg | 154 oz<br>4.4 kg | 160 oz<br>4.5 kg | 163 oz<br>4.6 kg | 166 oz<br>4.7 kg | 169 oz<br>4.8 kg | 172 oz<br>4.8 kg | 175 oz<br>4.9 kg | 178 oz<br>5.0 kg | 179.5 oz<br>5.1 kg | 181 oz<br>5.1 kg | 184 oz<br>5.2 kg | 187 oz<br>5.3 kg | 190 oz<br>5.4 kg | 193 oz<br>5.4 kg | 196 oz<br>5.5 kg | 199 oz<br>5.6 kg | 160 oz<br>4.5 kg |
| PUZ-A18NHA6<br>PUZ-A18NHA6-BS | 56 oz<br>1.6 kg         | 58 oz<br>1.6 kg  | 60 oz<br>1.7 kg  | 62 oz<br>1.8 kg  | 64 oz<br>1.8 kg  | 66 oz<br>1.9 kg  | -                | -                | -                | -                | -                | -                | -                  | -                | -                | -                | -                | -                | -                | -                | 60 oz<br>1.7 kg  |
| PUZ-A24NHA6<br>PUZ-A24NHA6-BS | 94 oz<br>2.7 kg         | 100 oz<br>2.8 kg | 106 oz<br>3.0 kg | 112 oz<br>3.2 kg | 118 oz<br>3.3 kg | 124 oz<br>3.5 kg | 130 oz<br>3.7 kg | 136 oz<br>3.9 kg | 142 oz<br>4.0 kg | 148 oz<br>4.2 kg | 154 oz<br>4.4 kg | 160 oz<br>4.5 kg | 166 oz<br>4.7 kg   | -                | -                | -                | -                | -                | -                | -                | 106 oz<br>3.0 kg |
| PUZ-A30NHA6<br>PUZ-A30NHA6-BS | 94 oz<br>2.7 kg         | 100 oz<br>2.8 kg | 106 oz<br>3.0 kg | 112 oz<br>3.2 kg | 118 oz<br>3.3 kg | 124 oz<br>3.5 kg | 130 oz<br>3.7 kg | 136 oz<br>3.9 kg | 142 oz<br>4.0 kg | 148 oz<br>4.2 kg | 154 oz<br>4.4 kg | 160 oz<br>4.5 kg | 166 oz<br>4.7 kg   | -                | -                | -                | -                | -                | -                | -                | 106 oz<br>3.0 kg |
| PUZ-A36NHA6<br>PUZ-A36NHA6-BS | 94 oz<br>2.7 kg         | 100 oz<br>2.8 kg | 106 oz<br>3.0 kg | 112 oz<br>3.2 kg | 118 oz<br>3.3 kg | 124 oz<br>3.5 kg | 130 oz<br>3.7 kg | 136 oz<br>3.9 kg | 142 oz<br>4.0 kg | 148 oz<br>4.2 kg | 154 oz<br>4.4 kg | 160 oz<br>4.5 kg | 166 oz<br>4.7 kg   | -                | -                | -                | -                | -                | -                | -                | 106 oz<br>3.0 kg |
| PUZ-A42NHA6<br>PUZ-A42NHA6-BS | 132 oz<br>3.7 kg        | 136 oz<br>3.9 kg | 142 oz<br>4.0 kg | 148 oz<br>4.2 kg | 154 oz<br>4.4 kg | 160 oz<br>4.5 kg | 166 oz<br>4.7 kg | 172 oz<br>4.9 kg | 178 oz<br>5.0 kg | 184 oz<br>5.2 kg | 190 oz<br>5.4 kg | 196 oz<br>5.6 kg | 202 oz<br>5.7 kg   | -                | -                | -                | -                | -                | -                | -                | 160 oz<br>4.5 kg |

For pipes longer than 70 or 100 ft, additional charge is required.

**5-2. COMPRESSOR TECHNICAL DATA**

(at 68°F [20°C] )

| Service Ref.           | PUZ-A18NHA6<br>PUZ-A18NHA6-BS<br>PUY-A12/18NHA6<br>PUY-A12/18NHA6-BS | PUZ-A24/30/36NHA6<br>PUZ-A24/30/36NHA6-BS<br>PUY-A24/30/36NHA6<br>PUY-A24/30/36NHA6-BS | PUZ-A42NHA6<br>PUZ-A42NHA6-BS<br>PUY-A42NHA6<br>PUY-A42NHA6-BS |
|------------------------|--|--|--|
| Compressor model       | SNB130FQCM1  | TNB220FLHM   | ANB33FCTMT   |
| Winding Resistance (Ω) | U-V  | 0.640  | 0.302  |
|                        | U-W  | 0.640  | 0.302  |
|                        | W-V  | 0.640  | 0.302  |

### 5-3. NOISE CRITERION CURVES

**PUY-A12NHA6**  
**PUY-A12NHA6-BS**

| MODE    | SPL(dB) | LINE |
|---------|---------|------|
| COOLING | 46      | ○—○  |

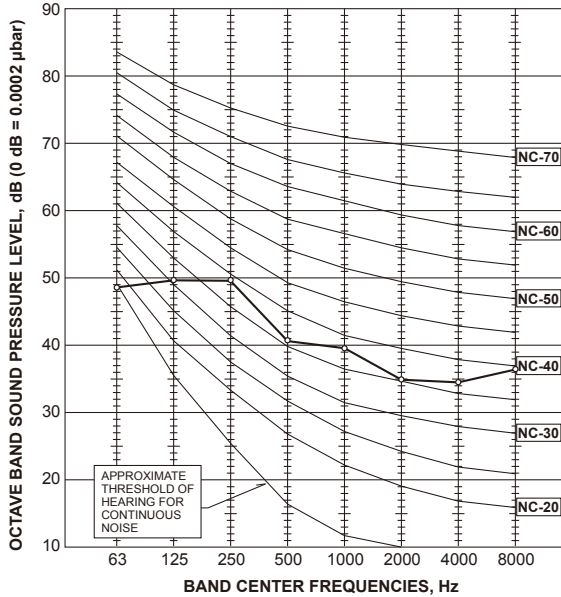

**PUY-A18NHA6**  
**PUY-A18NHA6-BS**  
**PUZ-A18NHA6**  
**PUZ-A18NHA6-BS**

| MODE    | SPL(dB) | LINE |
|---------|---------|------|
| COOLING | 48      | ○—○  |
| HEATING | 47      | ●—●  |

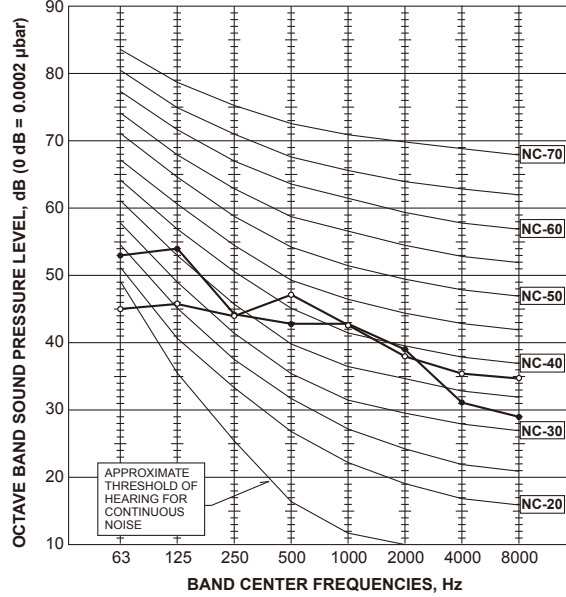

**PUY-A24/30/36NHA6**  
**PUY-A24/30/36NHA6-BS**  
**PUZ-A24/30/36NHA6**  
**PUZ-A24/30/36NHA6-BS**

| MODE    | SPL(dB) | LINE |
|---------|---------|------|
| COOLING | 48      | ○—○  |
| HEATING | 50      | ●—●  |

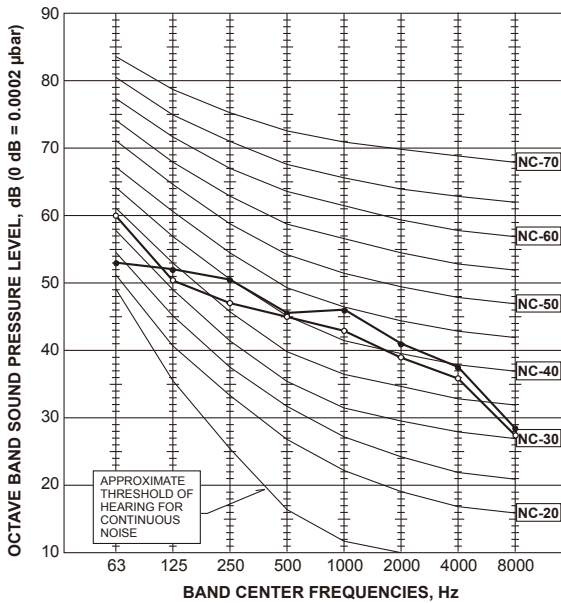

**PUY-A42NHA6**  
**PUY-A42NHA6-BS**  
**PUZ-A42NHA6**  
**PUZ-A42NHA6-BS**

| MODE    | SPL(dB) | LINE |
|---------|---------|------|
| COOLING | 51      | ○—○  |
| HEATING | 55      | ●—●  |

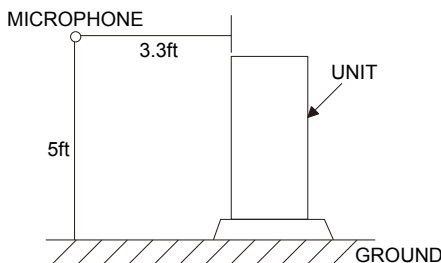
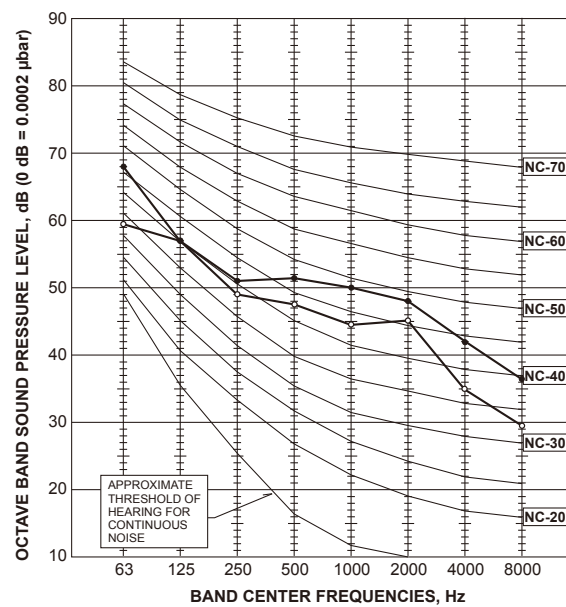

## 5-4. STANDARD OPERATION DATA

### 5-4-1. Heat pump

| Representative matching      |                              |                           | PKA-A18HA6  |         | PKA-A24KA6  |         | PKA-A30KA6  |         | PKA-A36KA6  |         | PLA-A42BA6  |         |
|------------------------------|------------------------------|---------------------------|-------------|---------|-------------|---------|-------------|---------|-------------|---------|-------------|---------|
| Mode                         |                              |                           | COOLING     | HEATING | COOLING     | HEATING | COOLING     | HEATING | COOLING     | HEATING | COOLING     | HEATING |
| Total                        | Capacity                     | BTU/h                     | 18,000      | 19,000  | 24,000      | 26,000  | 30,000      | 32,000  | 34,200      | 37,000  | 42,000      | 45,000  |
|                              | Input                        | W                         | 2,240       | 1,970   | 2,270       | 2,330   | 4,130       | 3,150   | 5,030       | 3,610   | 4,600       | 4,450   |
| Electrical circuit           | Indoor unit model            |                           | PKA-A18HA6  |         | PKA-A24KA6  |         | PKA-A30KA6  |         | PKA-A36KA6  |         | PLA-A42BA6  |         |
|                              | Phase                        |                           | Single      |         | Single      |         | Single      |         | Single      |         | Single      |         |
|                              | Cycle                        |                           | 60 Hz       |         | 60 Hz       |         | 60 Hz       |         | 60 Hz       |         | 60 Hz       |         |
|                              | Voltage                      |                           | 230 V       |         | 230 V       |         | 230 V       |         | 230 V       |         | 230 V       |         |
|                              | Current                      |                           | 0.33 A      |         | 0.36 A      |         | 0.36 A      |         | 0.57 A      |         | 1.00 A      | 0.94 A  |
|                              | Outdoor unit model           |                           | PUZ-A18NHA6 |         | PUZ-A24NHA6 |         | PUZ-A30NHA6 |         | PUZ-A36NHA6 |         | PUZ-A42NHA6 |         |
|                              | Phase                        |                           | Single      |         | Single      |         | Single      |         | Single      |         | Single      |         |
|                              | Cycle                        |                           | 60 Hz       |         | 60 Hz       |         | 60 Hz       |         | 60 Hz       |         | 60 Hz       |         |
|                              | Voltage                      |                           | 230 V       |         | 230 V       |         | 230 V       |         | 230 V       |         | 230 V       |         |
|                              | Current                      |                           | 9.8 A       | 8.8 A   | 9.4 A       | 10.4 A  | 18.1 A      | 14.0 A  | 21.7 A      | 15.6 A  | 20.4 A      | 21.5 A  |
| Refrigerant circuit          | Discharge pressure           | MPa                       | 3.01        | 3.03    | 2.78        | 2.89    | 3.08        | 3.04    | 3.23        | 2.95    | 2.83        | 2.93    |
|                              | Suction pressure             | MPa                       | 0.77        | 0.64    | 0.92        | 0.68    | 0.77        | 0.64    | 0.74        | 0.63    | 0.82        | 0.69    |
|                              | Discharge temperature        | °C                        | 80.1        | 83.7    | 73.9        | 77.9    | 81.2        | 81.4    | 88.1        | 80.7    | 73.4        | 80.3    |
|                              | Condensing temperature       | °C                        | 49.9        | 50.8    | 46.9        | 48.5    | 50.8        | 50.8    | 52.8        | 49.3    | 47.5        | 47.5    |
|                              | Suction temperature          | °C                        | 3.8         | -1.1    | 12.1        | 0.4     | 3.3         | -1.5    | 2.3         | -2.0    | 4.9         | 0.3     |
|                              | Ref. Pipe length             | m                         | 7.6         | 7.6     | 7.6         | 7.6     | 7.6         | 7.6     | 7.6         | 7.6     | 7.6         | 7.6     |
|                              | Discharge pressure           | PSIG                      | 437         | 439     | 403         | 419     | 447         | 441     | 468         | 428     | 410         | 425     |
|                              | Suction pressure             | PSIG                      | 112         | 93      | 133         | 99      | 117         | 93      | 107         | 91      | 120         | 100     |
|                              | Discharge temperature        | °F                        | 176         | 183     | 165         | 172     | 178         | 179     | 191         | 177     | 164         | 177     |
|                              | Condensing temperature       | °F                        | 122         | 123     | 116         | 119     | 123         | 123     | 127         | 121     | 118         | 118     |
|                              | Suction temperature          | °F                        | 39          | 34      | 54          | 33      | 38          | 29      | 36          | 28      | 40          | 33      |
|                              | Ref. Pipe length             | ft                        | 25          | 25      | 25          | 25      | 25          | 25      | 25          | 25      | 25          | 25      |
|                              | Indoor side                  | Intake air temperature DB | °C          | 26.7    | 21.1        | 26.7    | 21.1        | 26.7    | 21.1        | 26.7    | 21.1        | 26.7    |
| Intake air temperature WB    |                              | °C                        | 19.4        | 15.6    | 19.4        | 15.6    | 19.4        | 15.6    | 19.4        | 15.6    | 19.4        | 15.6    |
| Discharge air temperature DB |                              | °C                        | 11.3        | 45.4    | 14.1        | 39.2    | 12.3        | 43.4    | 12.3        | 42.9    | 12.9        | 41.9    |
| Outdoor side                 | Intake air temperature DB    | °C                        | 35          | 8.3     | 35          | 8.3     | 35          | 8.3     | 35          | 8.3     | 35          | 8.3     |
|                              | Intake air temperature WB    | °C                        | 23.9        | 6.1     | 23.9        | 6.1     | 23.9        | 6.1     | 23.9        | 6.1     | 23.9        | 6.1     |
| Indoor side                  | Intake air temperature DB    | °F                        | 80          | 70      | 80          | 70      | 80          | 70      | 80          | 70      | 80          | 70      |
|                              | Intake air temperature WB    | °F                        | 67          | 60      | 67          | 60      | 67          | 60      | 67          | 60      | 67          | 60      |
|                              | Discharge air temperature DB | °F                        | 52          | 114     | 57          | 103     | 54          | 110     | 54          | 109     | 55          | 107     |
| Outdoor side                 | Intake air temperature DB    | °F                        | 95          | 47      | 95          | 47      | 95          | 47      | 95          | 47      | 95          | 47      |
|                              | Intake air temperature WB    | °F                        | 75          | 43      | 75          | 43      | 75          | 43      | 75          | 43      | 75          | 43      |
| SHF                          |                              |                           | 0.68        | –       | 0.77        | –       | 0.70        | –       | 0.70        | –       | 0.71        | –       |
| BF                           |                              |                           | 0.08        | –       | 0.09        | –       | 0.09        | –       | 0.09        | –       | 0.15        | –       |

### 5-4-2. Cooling only

| Representative matching |                              |       | PKA-A12HA6  | PKA-A18HA6  | PKA-A24KA6  | PKA-A30KA6  | PKA-A36KA6  | PLA-A42BA6  |
|-------------------------|------------------------------|-------|-------------|-------------|-------------|-------------|-------------|-------------|
| Mode                    |                              |       | COOLING     | COOLING     | COOLING     | COOLING     | COOLING     | COOLING     |
| Total                   | Capacity                     | BTU/h | 12,000      | 18,000      | 24,000      | 30,000      | 34,200      | 42,000      |
|                         | Input                        | W     | 1,190       | 2,240       | 2,270       | 4,130       | 5,030       | 4,600       |
| Electrical circuit      | Indoor unit model            |       | PKA-A12HA6  | PKA-A18HA6  | PKA-A24KA6  | PKA-A30KA6  | PKA-A36KA6  | PLA-A42BA6  |
|                         | Phase                        |       | Single      | Single      | Single      | Single      | Single      | Single      |
|                         | Cycle                        |       | 60 Hz       | 60 Hz       | 60 Hz       | 60 Hz       | 60 Hz       | 60 Hz       |
|                         | Voltage                      |       | 230 V       | 230 V       | 230 V       | 230 V       | 230 V       | 230 V       |
|                         | Current                      |       | 0.33 A      | 0.33 A      | 0.36 A      | 0.36 A      | 0.57 A      | 1.00 A      |
|                         | Outdoor unit model           |       | PUY-A12NHA6 | PUY-A18NHA6 | PUY-A24NHA6 | PUY-A30NHA6 | PUY-A36NHA6 | PUY-A42NHA6 |
|                         | Phase                        |       | Single      | Single      | Single      | Single      | Single      | Single      |
|                         | Cycle                        |       | 60 Hz       | 60 Hz       | 60 Hz       | 60 Hz       | 60 Hz       | 60 Hz       |
|                         | Voltage                      |       | 230 V       | 230 V       | 230 V       | 230 V       | 230 V       | 230 V       |
|                         | Current                      |       | 5.3 A       | 9.8 A       | 9.4 A       | 18.1 A      | 21.7 A      | 20.4 A      |
| Refrigerant circuit     | Discharge pressure           | MPa   | 2.87        | 3.01        | 2.78        | 3.08        | 3.23        | 2.83        |
|                         | Suction pressure             | MPa   | 1.00        | 0.77        | 0.92        | 0.77        | 0.74        | 0.82        |
|                         | Discharge temperature        | °C    | 69.0        | 80.1        | 73.9        | 81.2        | 88.1        | 73.4        |
|                         | Condensing temperature       | °C    | 48.6        | 49.9        | 46.9        | 50.8        | 52.8        | 47.5        |
|                         | Suction temperature          | °C    | 12.5        | 3.8         | 12.1        | 3.3         | 2.3         | 4.9         |
|                         | Ref. Pipe length             | m     | 7.6         | 7.6         | 7.6         | 7.6         | 7.6         | 7.6         |
|                         | Discharge pressure           | PSIG  | 416         | 437         | 403         | 447         | 468         | 410         |
|                         | Suction pressure             | PSIG  | 145         | 112         | 133         | 117         | 107         | 120         |
|                         | Discharge temperature        | °F    | 156         | 176         | 165         | 178         | 191         | 164         |
|                         | Condensing temperature       | °F    | 119         | 122         | 116         | 123         | 127         | 118         |
|                         | Suction temperature          | °F    | 55          | 39          | 54          | 38          | 36          | 40          |
|                         | Ref. Pipe length             | ft    | 25          | 25          | 25          | 25          | 25          | 25          |
| Indoor side             | Intake air temperature DB    | °C    | 26.7        | 26.7        | 26.7        | 26.7        | 26.7        | 26.7        |
|                         | Intake air temperature WB    | °C    | 19.4        | 19.4        | 19.4        | 19.4        | 19.4        | 19.4        |
|                         | Discharge air temperature DB | °C    | 14.6        | 11.3        | 14.1        | 12.3        | 12.3        | 12.9        |
| Outdoor side            | Intake air temperature DB    | °C    | 35          | 35          | 35          | 35          | 35          | 35          |
|                         | Intake air temperature WB    | °C    | 23.9        | 23.9        | 23.9        | 23.9        | 23.9        | 23.9        |
| Indoor side             | Intake air temperature DB    | °F    | 80          | 80          | 80          | 80          | 80          | 80          |
|                         | Intake air temperature WB    | °F    | 67          | 67          | 67          | 67          | 67          | 67          |
|                         | Discharge air temperature DB | °F    | 58          | 52          | 57          | 54          | 54          | 55          |
| Outdoor side            | Intake air temperature DB    | °F    | 95          | 95          | 95          | 95          | 95          | 95          |
|                         | Intake air temperature WB    | °F    | 75          | 75          | 75          | 75          | 75          | 75          |
| SHF                     |                              |       | 0.81        | 0.68        | 0.77        | 0.70        | 0.70        | 0.71        |
| BF                      |                              |       | 0.08        | 0.08        | 0.09        | 0.09        | 0.09        | 0.15        |

# 6

# OUTLINES AND DIMENSIONS

PUZ-A18NHA6

PUZ-A18NHA6-BS

PUY-A12/18NHA6

PUY-A12/18NHA6-BS

Unit: mm<in>

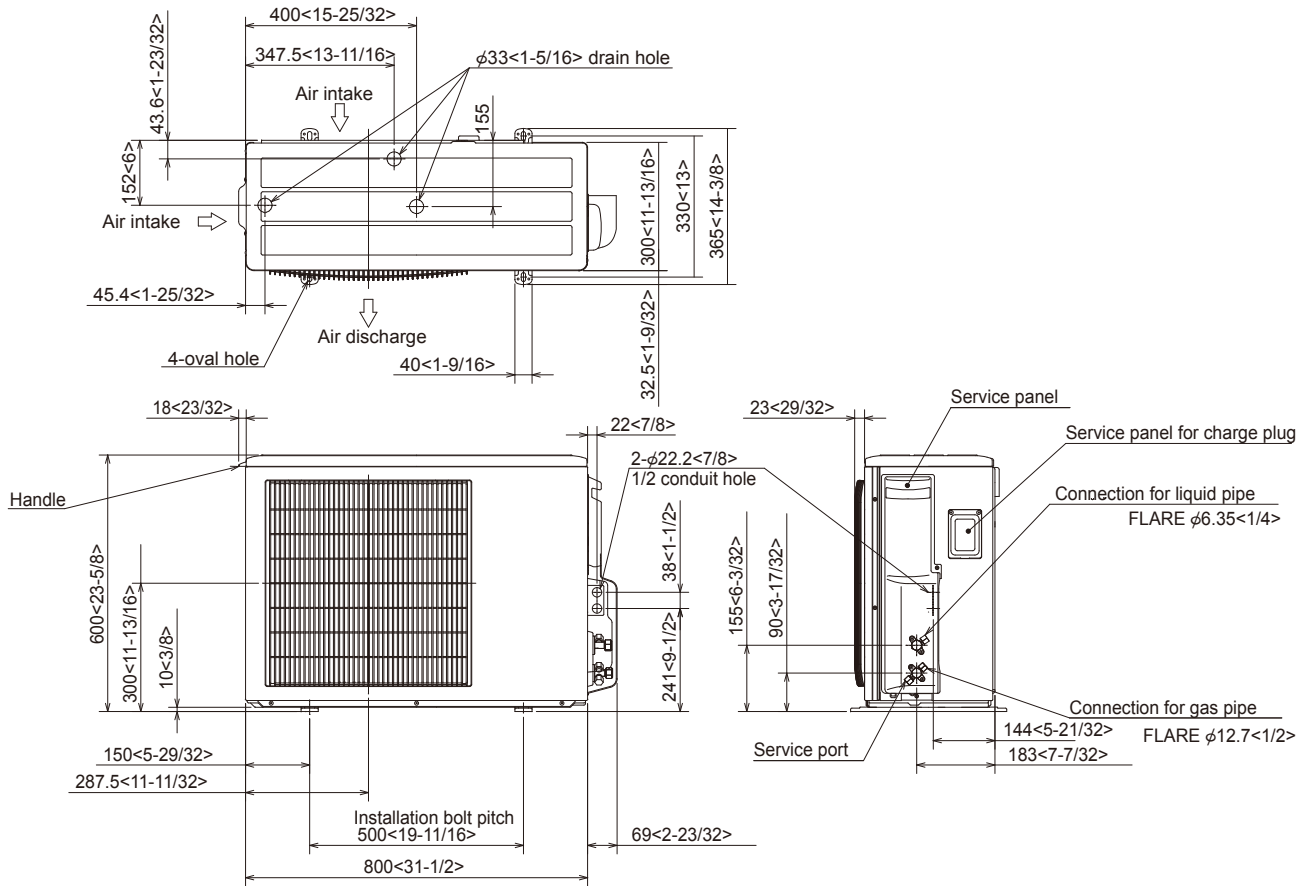

## Free space around the outdoor unit (basic example)

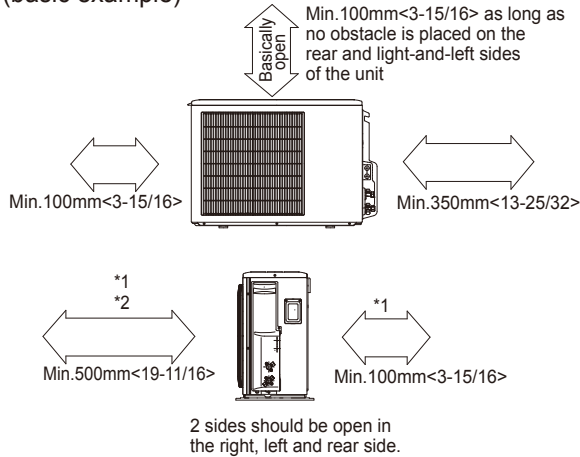

## FOUNDATION BOLTS

Please secure the unit firmly with 4 foundation M10<W3/8> bolts. (Bolts, washers and nut must be purchased locally.)

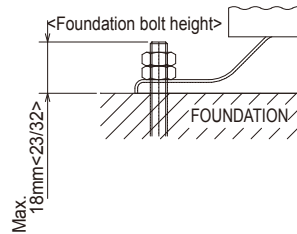

## PIPING-WIRING DIRECTION

Piping and wiring connection can be made from the rear direction only.

## Minimum installation space for outdoor unit

- \*1 In the place where short cycle tends to occur, cooling and heating capacity and power consumption might get lowered 10%. Air outlet guide (optional PAC-SG58SG-E) will help them improve.
- \*2 If air discharges to the wall, the surface might get stained.



**PUZ-A42NHA6**  
**PUY-A42NHA6**

**PUZ-A42NHA6-BS**  
**PUY-A42NHA6-BS**

Unit: mm<in>

**3 FOUNDATION BOLTS 4 PIPING-WIRING DIRECTIONS**

Please secure the unit firmly with 4 foundation (M10×W3/8) bolts. (Bolts and washers must be purchased locally.)

**2 SERVICE SPACE**

The diagram below shows a basic example. Explanation of particular details are given in the installation manuals etc.

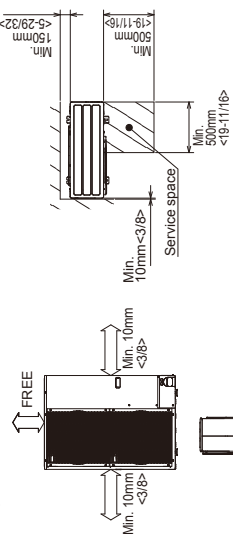

**1 FREE SPACE (Around the unit)**

The diagram below shows a basic example. Explanation of particular details are given in the installation manuals etc.

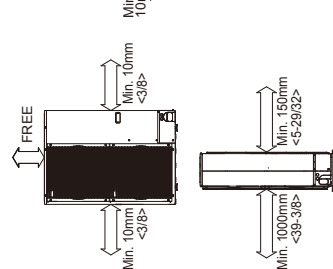

**Example of Notes**

- ① .....Refrigerant GAS pipe connection (FLARE)φ15.88×5/8>
- ② .....Refrigerant LIQUID pipe connection (FLARE)φ9.52×3/8>
- \*1 .....Indication of STOP VALVE connection location.

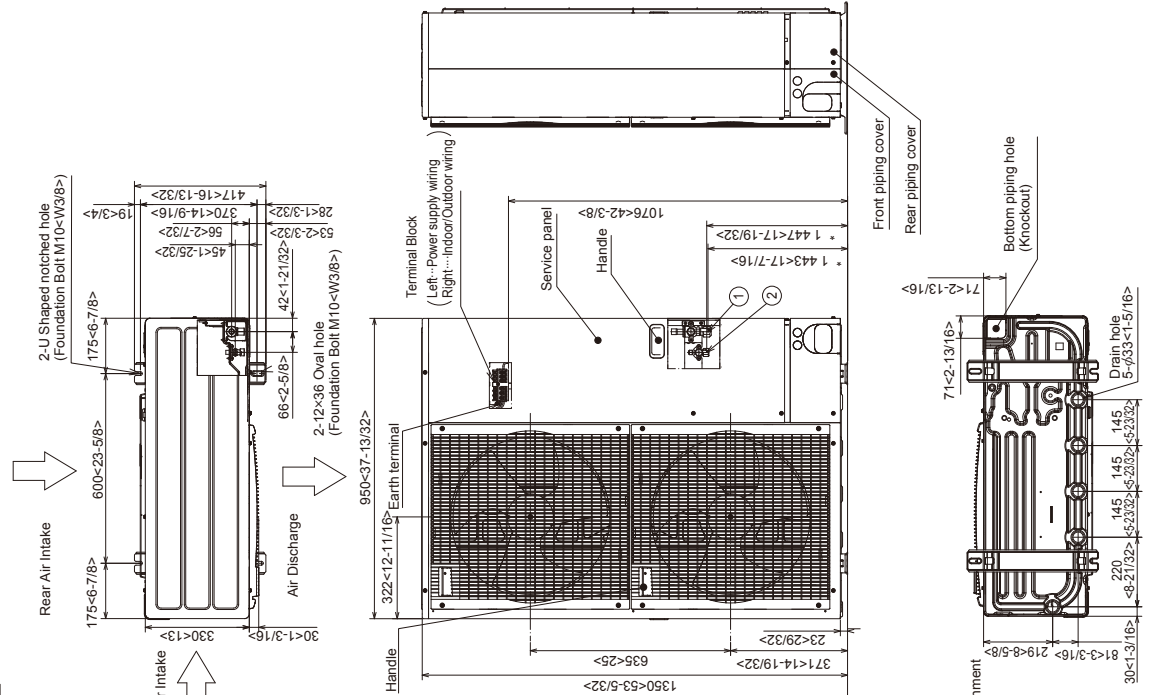

**Piping Knockout Hole Details**

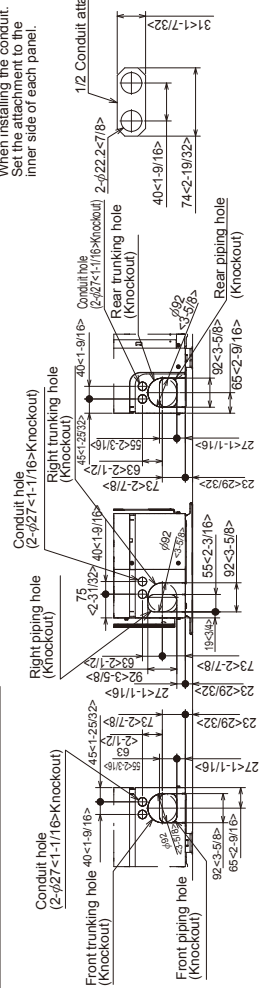

PUZ-A18NHA6

PUZ-A18NHA6-BS

PUY-A12/18NHA6

PUY-A12/18NHA6-BS

[LEGEND]

| SYMBOL  | NAME   | SYMBOL      | NAME  | SYMBOL      | NAME   |
|---------|--|-------------|---|-------------|--|
| TB1     | Terminal Block<Power Supply, Indoor/Outdoor> | PFC         | Converter   | LED1,LED2   | LED<Operation Inspection Indicators>                 |
| MC      | Motor for Compressor                         | IPM         | Power Module  | F1,F2,F3,F4 | Fuse<T6.3AL250V>                                     |
| MF1     | Fan Motor                                    | CB1,CB2,CB3 | Main Smoothing Capacitor  | SWP         | Switch<Pump Down>                                    |
| 21S4    | Solenoid Valve (Four-Way Valve)              | N.F.        | Noise Filter Circuit Board  | CN31        | Connector<Emergency Operation>                       |
| 63H     | High Pressure Switch                         | LI/LO       | Connection Terminal<L1-Phase>   | SS          | Connector<Connection for Option>                     |
| TH3     | Thermistor<Liquid>                           | NI/NO       | Connection Terminal<L2-Phase>   | CNM         | Connector<Connection for Option>                     |
| TH6     | Thermistor<2-Phase Pipe>                     | E1,E2,E3    | Connection Terminal<Ground>   | CNMNT       | Connector<Connected to Optional M-NET Adapter Board> |
| TH7     | Thermistor<Ambient>                          | 52C         | 52C Relay   | CNV         | Connector<Connected to Optional M-NET Adapter Board> |
| TH8     | Thermistor<Heat Sink>                        | C.B.        | Controller Circuit Board  | CNDM        | Connector<Connection for Option>                     |
| TH32    | Thermistor<Comp. Surface>                    | SW1         | Switch<Manual Defrost, Defect History, Record Reset, Refrigerant Address> | CN51        | Connector<Connection for Option>                     |
| TH33    | Thermistor<Suction>                          | SW4         | Switch<Test Operation>  | X51,X52,X55 | Relay  |
| LEV-A   | Linear Expansion Valve                       | SW5         | Switch<Model Select, Function Switch>                                     |             |  |
| ACL     | Reactor                                      | SW6         | Switch<Model Select>  |             |  |
| CY1,CY2 | Capacitor                                    | SW7         | Switch<Function Switch>   |             |  |
| P.B.    | Power Circuit Board                          | SW8         | Switch<Function Switch>   |             |  |
| TABR/S  | Connection Terminal<L1/L2-Phase>             | SW9         | Switch<Function Switch>   |             |  |
| TABU/VW | Connection Terminal<U/V/W-Phase>             |             |   |             |  |

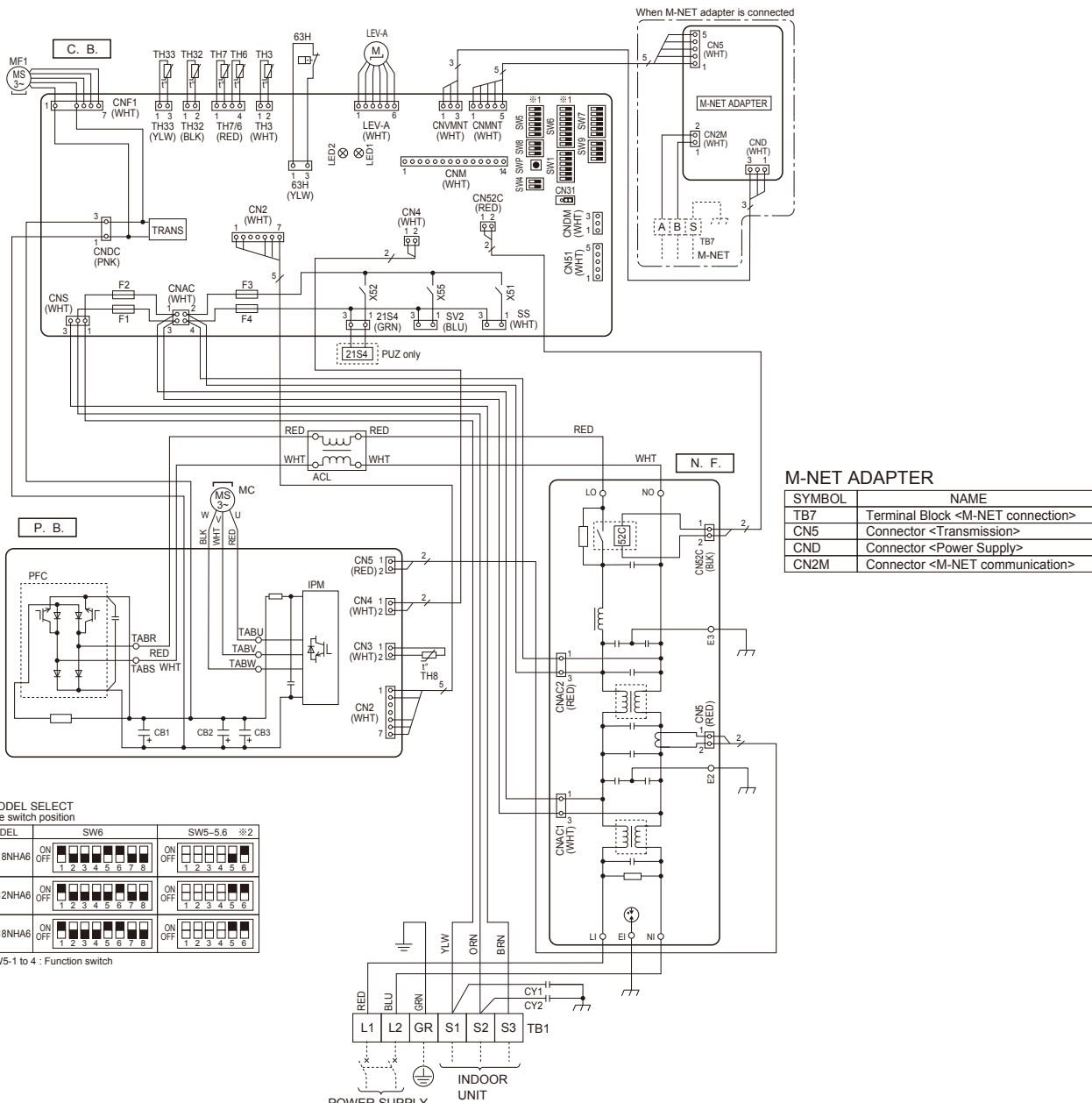

**M-NET ADAPTER**

| SYMBOL | NAME                              |
|--------|-----------------------------------|
| TB7    | Terminal Block <M-NET connection> |
| CN5    | Connector <Transmission>          |
| CND    | Connector <Power Supply>          |
| CN2M   | Connector <M-NET communication>   |

※1 MODEL SELECT  
■ is the switch position

| MODEL       | SW6                       | SW5-5.6 ※2            |
|-------------|---------------------------|-----------------------|
| PUZ-A18NHA6 | ON OFF<br>1 2 3 4 5 6 7 8 | ON OFF<br>1 2 3 4 5 6 |
| PUY-A12NHA6 | ON OFF<br>1 2 3 4 5 6 7 8 | ON OFF<br>1 2 3 4 5 6 |
| PUY-A18NHA6 | ON OFF<br>1 2 3 4 5 6 7 8 | ON OFF<br>1 2 3 4 5 6 |

※2. SW5-1 to 4 : Function switch

POWER SUPPLY  
208 / 230V 60Hz  
※Use copper supply wires.  
Utilisez des fils d'alimentation en cuivre.

**PUZ-A24NHA6    PUZ-A24NHA6-BS    PUY-A24NHA6    PUY-A24NHA6-BS**

**[LEGEND]**

| SYMBOL  | NAME   | SYMBOL      | NAME  | SYMBOL      | NAME  |
|---------|--|-------------|---|-------------|---|
| TB1     | Terminal Block<Power Supply, Indoor/Outdoor> | TABU/V/W    | Connection Terminal<U/V/W-Phase>  | SW9         | Switch<Function Switch>                     |
| MC      | Motor for Compressor                         | PFC         | Converter   | LED1,LED2   | LED<Operation Inspection Indicators>        |
| MF1     | Fan Motor                                    | IPM         | Power Module  | F1,F2,F3,F4 | Fuse<T6.3AL250V>                            |
| 21S4    | Solenoid Valve (Four-Way Valve)              | CB1,CB2,CB3 | Main Smoothing Capacitor  | SWP         | Switch<Pump Down>                           |
| 63H     | High Pressure Switch                         | N.F.        | Noise Filter Circuit Board  | CN31        | Connector<Emergency Operation>              |
| SV      | Solenoid Valve (Bypass Valve)                | L/L/O       | Connection Terminal<L1-Phase>   | SS          | Connector<Connection for Option>            |
| TH3     | Thermistor<Liquid>                           | N/I/O       | Connection Terminal<L2-Phase>   | CNM         | Connector<Connection for Option>            |
| TH6     | Thermistor<2-Phase Pipe>                     | E1,E2,E3    | Connection Terminal<Ground>   | CNMNT       | Connector                                   |
| TH7     | Thermistor<Ambient>                          | 52C         | 52C Relay   |             | <Connected to Optional M-NET Adapter Board> |
| TH8     | Thermistor<Heat sink>                        | C.B.        | Controller Circuit Board  | CNMVMT      | Connector                                   |
| TH32    | Thermistor<Comp. Surface>                    | SW1         | Switch<Manual Defrost, Defect History, Record Reset, Refrigerant Address> |             | <Connected to Optional M-NET Adapter Board> |
| TH33    | Thermistor<Suction>                          | SW4         | Switch<Test Operation>  | CNDM        | Connector<Connection for Option>            |
| LEV-A   | Linear Expansion Valve                       | SW5         | Switch<Model Select, Function Switch>                                     | CN51        | Connector<Connection for Option>            |
| ACL     | Reactor                                      | SW6         | Switch<Model Select>  |             | Relay                                       |
| CY1,CY2 | Capacitor                                    | SW7         | Switch<Function Switch>   |             |   |
| P.B.    | Power Circuit Board                          | SW8         | Switch<Function Switch>   |             |   |
| TABR/S  | Connection Terminal<L1/L2-Phase>             |             |   |             |   |

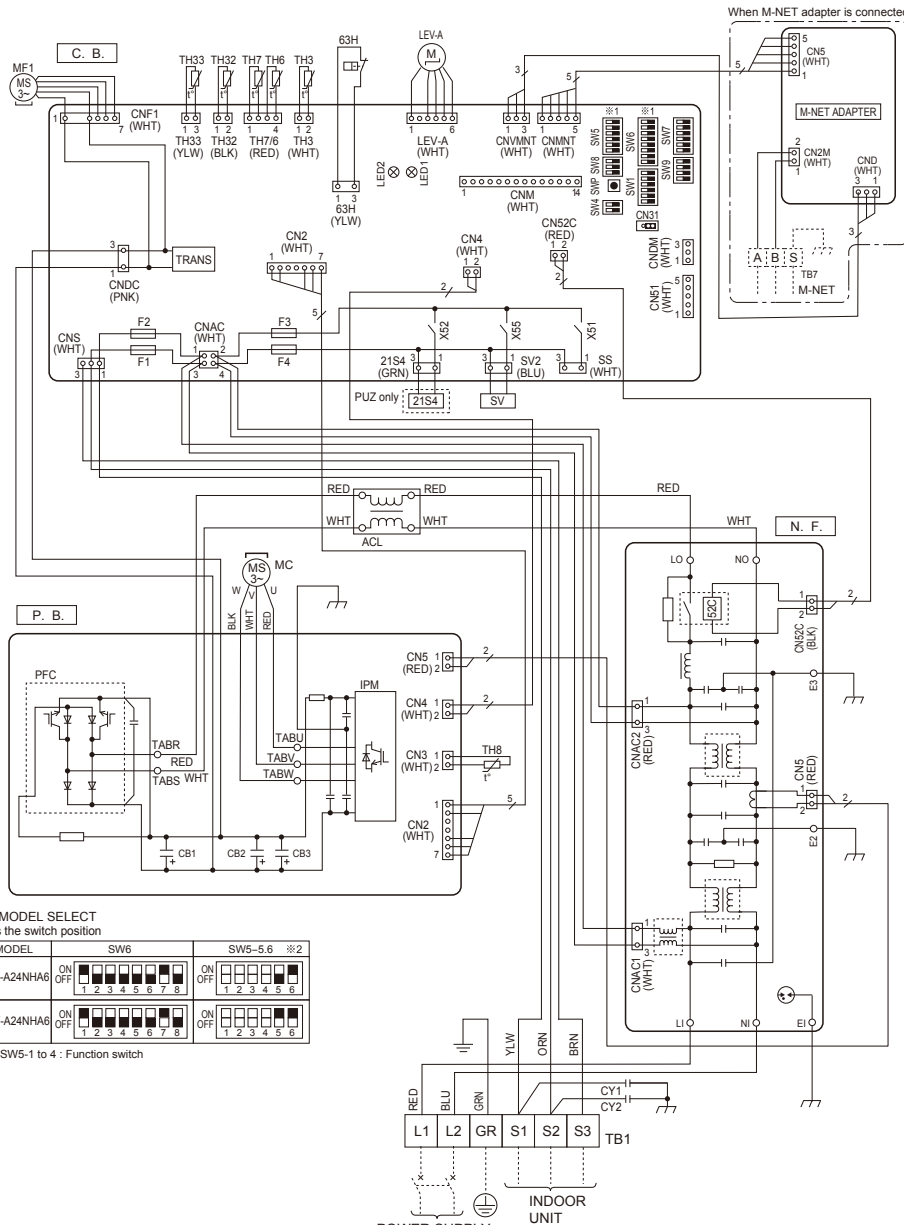

When M-NET adapter is connected

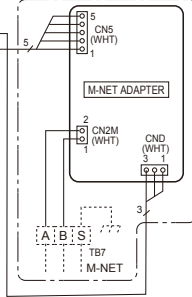

**M-NET ADAPTER**

| SYMBOL | NAME                             |
|--------|----------------------------------|
| TB7    | Terminal Block<M-NET connection> |
| CN5    | Connector<Transmission>          |
| CND    | Connector<Power Supply>          |
| CN2M   | Connector<M-NET communication>   |

※1 MODEL SELECT  
■ is the switch position

| MODEL       | SW6                       | SW5-5.6 ※2            |
|-------------|---------------------------|-----------------------|
| PUZ-A24NHA6 | ON OFF<br>1 2 3 4 5 6 7 3 | ON OFF<br>1 2 3 4 5 6 |
| PUY-A24NHA6 | ON OFF<br>1 2 3 4 5 6 7 8 | ON OFF<br>1 2 3 4 5 6 |

※2. SW5-1 to 4 : Function switch

POWER SUPPLY  
208 / 230V 60Hz  
※Use copper supply wires.  
Utilisez des fils d'alimentation en cuivre.



**PUZ-A42NHA6    PUZ-A42NHA6-BS    PUY-A42NHA6    PUY-A42NHA6-BS**

**[LEGEND]**

| SYMBOL   | NAME  | SYMBOL      | NAME  | SYMBOL    | NAME   |
|----------|---|-------------|---|-----------|--|
| TB1      | Terminal Block<Power Supply, Indoor/Outdoor > | P.B.        | Power Circuit Board   | SW4       | Switch<Test Operation>                               |
| MC       | Motor for Compressor                          | TABU/V/W    | Connection Terminal<U/V/W-Phase>  | SW5       | Switch<Model Select, Function Switch>                |
| MF1,MF2  | Fan Motor                                     | TABS/T      | Connection Terminal<L1/L2-Phase>  | SW6       | Switch<Model Select>                                 |
| 21S4     | Solenoid Valve (Four-Way Valve)               | TABP1/P2/P  | Connection Terminal<DC Voltage>   | SW7       | Switch<Function Switch>                              |
| 63H      | High Pressure Switch                          | TABN1/N2/N  | Connection Terminal<DC Voltage>   | SW8       | Switch<Function Switch>                              |
| TH3      | Thermistor<Liquid>                            | DS2, DS3    | Diode Bridge  | SW9       | Switch<Function Switch>                              |
| TH6      | Thermistor<2-Phase Pipe>                      | IPM         | Power Module  | SWP       | Switch<Pump Down>                                    |
| TH7      | Thermistor<Ambient>                           | N.F.        | Noise Filter Circuit Board  | CN31      | Connector<Emergency Operation>                       |
| TH8      | Thermistor<Heat Sink>                         | LI/L0       | Connection Lead<L1-Phase>   | LED1,LED2 | LED<Operation Inspection Indicators>                 |
| TH32     | Thermistor<Comp. Surface>                     | NI/NO       | Connection Lead<L2-Phase>   | SS        | Connector<Connection for Option>                     |
| TH33     | Thermistor<Suction>                           | E1, E2      | Connection Terminal<Ground>   | CNM       | Connector<Connection for Option>                     |
| LEV-A    | Linear Expansion Valve                        | 52C         | 52C Relay   | CNMNT     | Connector<Connected to Optional M-NET Adapter Board> |
| DCL      | Reactor                                       | C.B.        | Controller Circuit Board  | CNVMNT    | Connector<Connected to Optional M-NET Adapter Board> |
| CY1, CY2 | Capacitor                                     | F1,F2,F3,F4 | Fuse<T6.3AL250V>  | CNDM      | Connector<Connection for Option>                     |
| ACTM     | Active Filter Module                          | SW1         | Switch<Manual Defrost, Defect History, Record Reset, Refrigerant Address> | CN51      | Connector<Connection for Option>                     |
| CB       | Main Smoothing Capacitor                      |             |   | X51,X52   | Relay  |

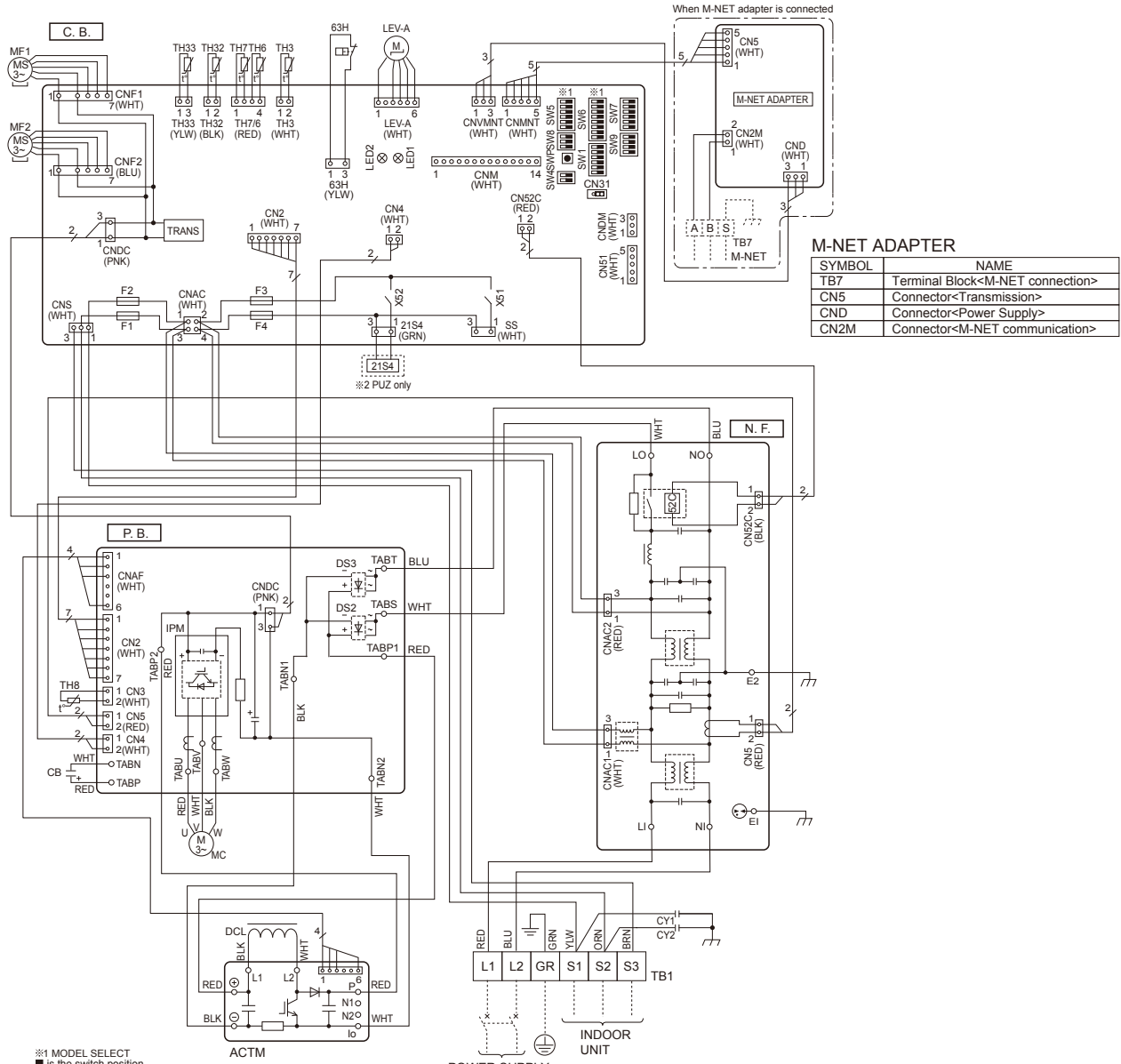

**M-NET ADAPTER**

| SYMBOL | NAME                             |
|--------|----------------------------------|
| TB7    | Terminal Block<M-NET connection> |
| CN5    | Connector<Transmission>          |
| CND    | Connector<Power Supply>          |
| CN2M   | Connector<M-NET communication>   |

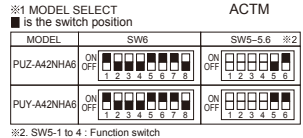

POWER SUPPLY  
208 / 230V 60Hz  
※Use copper supply wires.  
Utilisez des fils d'alimentation en cuivre.

## 8-1. INDOOR UNIT POWER SUPPLIED FROM OUTDOOR UNIT (A-control application)

The following connection patterns are available.  
The outdoor unit power supply patterns vary on models.

### 1:1 System

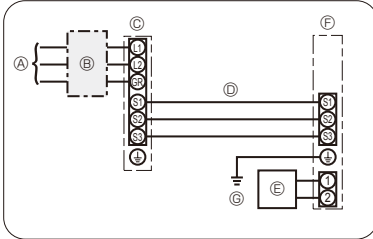

### Simultaneous twin system

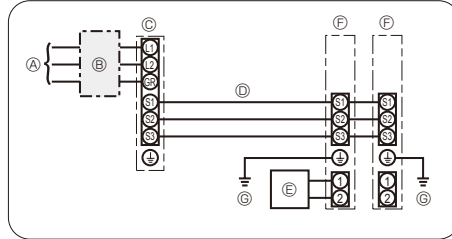

- Ⓐ Outdoor unit power supply
- Ⓑ Wiring circuit breaker or isolating switch
- Ⓒ Outdoor unit
- Ⓓ Indoor unit/outdoor unit connecting cords
- Ⓔ Remote controller
- Ⓕ Indoor unit
- Ⓖ Indoor unit earth

Note: Affix a label A that is included with the manuals near each wiring diagram for the indoor and outdoor units.

| Indoor unit model                               | PLA-A12, 18, 24, 30<br>PCA-A24, 30, PKA | PLA-A36, 42<br>PCA-A36, 42 | PEAD-A24, 30, 36, 42     | PEA-A12, 18 |
|---|---|----------------------------|--------------------------|-------------|
| Indoor unit power supply                        | -                                       | -                          | -                        | -           |
| Minimum circuit ampacity                        | 1 A                                     | 2 A                        | 2.63, 2.73, 3.30, 3.50 A | 1 A         |
| Maximum rating of overcurrent protective device | 15 A                                    | 15 A                       | 15 A                     | 15 A        |

| Outdoor unit model                              | A12                               | A18                      | A24                      | A30                      | A36                      | A42                      |
|---|-----------------------------------|--------------------------|--------------------------|--------------------------|--------------------------|--------------------------|
| Outdoor unit power supply                       | Single, 208/230 V, 60 Hz          | Single, 208/230 V, 60 Hz | Single, 208/230 V, 60 Hz | Single, 208/230 V, 60 Hz | Single, 208/230 V, 60 Hz | Single, 208/230 V, 60 Hz |
| Breaker size *1                                 | 15 A                              | 15 A                     | 25 A                     | 30 A                     | 30 A                     | 30 A                     |
| Minimum circuit ampacity                        | 13 A                              | 13 A                     | 18 A                     | 25 A                     | 25 A                     | 26 A                     |
| Maximum rating of overcurrent protective device | 15 A                              | 20 A                     | 30 A                     | 40 A                     | 40 A                     | 40 A                     |
| Wiring Wire No. x size                          | Outdoor unit power supply         | 2 × Min. AWG 14          | 2 × Min. AWG 14          | 2 × Min. AWG 12          | 2 × Min. AWG 10          | 2 × Min. AWG 10          |
|   | Outdoor unit power supply earth   | 1 × Min. AWG 14          | 1 × Min. AWG 14          | 1 × Min. AWG 12          | 1 × Min. AWG 10          | 1 × Min. AWG 10          |
|   | Indoor unit-Outdoor unit *2       | 3 × AWG 16 (polar)       | 3 × AWG 16 (polar)       | 3 × AWG 16 (polar)       | 3 × AWG 16 (polar)       | 3 × AWG 16 (polar)       |
|   | Indoor unit earth *2              | 1 × Min. AWG 16          | 1 × Min. AWG 16          | 1 × Min. AWG 16          | 1 × Min. AWG 16          | 1 × Min. AWG 16          |
| Remote controller-Indoor unit *3                | 2 × AWG 22 (Non-polar)            | 2 × AWG 22 (Non-polar)   | 2 × AWG 22 (Non-polar)   | 2 × AWG 22 (Non-polar)   | 2 × AWG 22 (Non-polar)   | 2 × AWG 22 (Non-polar)   |
| Circuit rating                                  | Outdoor unit L1-L2 *4             | 208/230 V AC             | 208/230 V AC             | 208/230 V AC             | 208/230 V AC             | 208/230 V AC             |
|   | Indoor unit-Outdoor unit S1-S2 *4 | 208/230 V AC             | 208/230 V AC             | 208/230 V AC             | 208/230 V AC             | 208/230 V AC             |
|   | Indoor unit-Outdoor unit S2-S3 *4 | 24 V DC                  | 24 V DC                  | 24 V DC                  | 24 V DC                  | 24 V DC                  |
|   | Remote controller-Indoor unit *4  | 12 V DC                  | 12 V DC                  | 12 V DC                  | 12 V DC                  | 12 V DC                  |

\*1. A breaker with at least 3 mm contact separation in each pole shall be provided. Use earth leakage breaker (NV).

The breaker shall be provided to ensure disconnection of all active phase conductor of the supply.

Make sure that the current leakage breaker is one compatible with higher harmonics.

Always use a current leakage breaker that is compatible with higher harmonics as this unit is equipped with an inverter.

The use of an inadequate breaker can cause the incorrect operation of inverter.

\*2. Maximum 147 ft [45 m]

If AWG13 is used, maximum 164 ft [50 m].

If AWG13 is used and S3 is separated, maximum 262 ft [80 m].

\*3. The 30 ft [10 m] wire is attached in the remote controller accessory. Maximum 1500 ft

\*4. The figures are NOT always against the ground.

S3 terminal has 24 V DC against S2 terminal. However between S3 and S1, these terminals are NOT electrically insulated by the transformer or other device.



**⚠ Caution: Be sure to install N-Line. Without N-Line, it could cause damage to the unit.**

- Notes:
1. Wiring size must comply with the applicable local and national code.
  2. Use copper supply wires.
  3. Use wires rated 600 V or more for the power supply cables and the indoor/outdoor unit connecting cables.
  4. Install an earth longer than other cables.

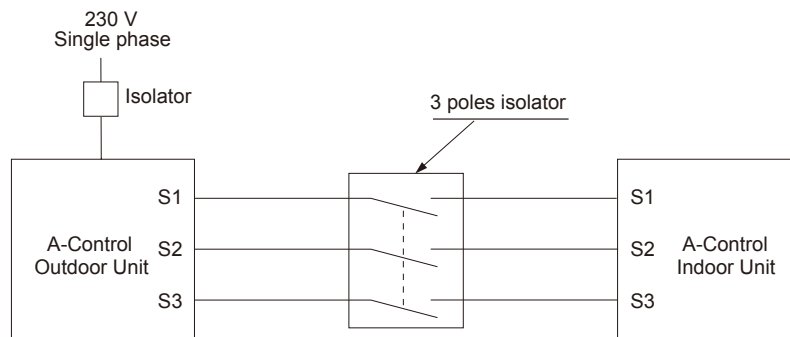

In case of A-control wiring, there is high voltage potential on the S3 terminal caused by electrical circuit design that has no electrical insulation between power line and communication signal line. Therefore, please turn off the main power supply when servicing. And do not touch the S1, S2, S3 terminals when the power is energized. If isolator should be used between indoor unit and outdoor unit, please use 3-pole type.

## 8-2. SEPARATE INDOOR UNIT/OUTDOOR UNIT POWER SUPPLIES

The following illustrations show available connection patterns.  
The outdoor unit power supply patterns vary on models.

### 1:1 System

The optional indoor power supply terminal kit is required.

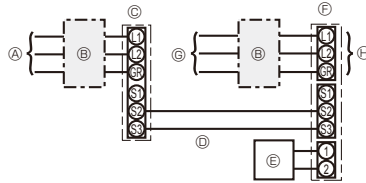

- A Outdoor unit power supply
- B Wiring circuit breaker or isolating switch
- C Outdoor unit
- D Indoor unit/outdoor unit connecting cords
- E Remote controller
- F Indoor unit
- G Indoor unit power supply
- H Option

Affix a label B that is included with the manuals near each wiring diagram for the indoor and outdoor units.

### Simultaneous twin system

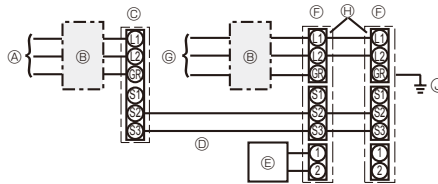

- A Outdoor unit power supply
- B Wiring circuit breaker or isolating switch
- C Outdoor unit
- D Indoor unit/outdoor unit connecting cords
- E Remote controller
- F Indoor unit
- G Indoor unit power supply
- H Option
- J Indoor unit earth

Affix a label B that is included with the manuals near each wiring diagram for the indoor and outdoor units.

If the indoor and outdoor units have separate power supplies, refer to the table below.  
Change the indoor unit electrical box wiring referring to the figure in the right and the DIP switch settings of the outdoor unit control board.

|   | Indoor unit specifications   |    |   |  |   |     |   |   |  |
|---|--|----|---|--|---|-----|---|---|--|
| Indoor unit electrical box connector connection change  | Required   |    |   |  |   |     |   |   |  |
| Label affixed near each wiring diagram for the indoor and outdoor units                             | Required   |    |   |  |   |     |   |   |  |
| Outdoor unit DIP switch settings (when using separate indoor unit/outdoor unit power supplies only) | <table border="1" style="display: inline-table;"> <tr> <td>ON</td> <td></td> <td></td> <td>3</td> </tr> <tr> <td>OFF</td> <td>1</td> <td>2</td> <td></td> </tr> </table> (SW8) | ON |   |  | 3 | OFF | 1 | 2 |  |
| ON  |  |    | 3 |  |   |     |   |   |  |
| OFF   | 1  | 2  |   |  |   |     |   |   |  |

Note:

There are three types of label; A, B and C.

Affix the appropriate label to the units according to the wiring method.

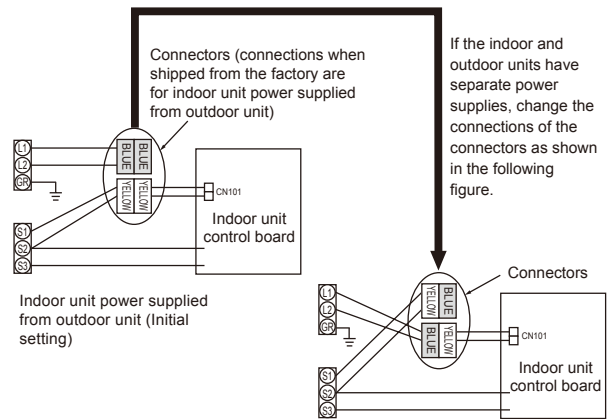

Separate indoor unit/outdoor unit power supplies

| Indoor unit model                               | PLA-A12, 18, 24, 30<br>PKA, PCA-A24, 30 | PLA-A36, 42<br>PCA-A36, 42 | PEAD-A24, 30, 36, 42     | PEA-A12, 18             |                     |
|---|---|----------------------------|--------------------------|-------------------------|---------------------|
| Indoor unit power supply                        | Single 208/230 V, 60 Hz                 | Single 208/230 V, 60 Hz    | Single 208/230 V, 60 Hz  | Single 208/230 V, 60 Hz |                     |
| Minimum circuit ampacity                        | 1 A                                     | 2 A                        | 2.63, 2.73, 3.30, 3.50 A | 1 A                     |                     |
| Maximum rating of overcurrent protective device | 15 A                                    | 15 A                       | 15 A                     | 15 A                    |                     |
| Wiring<br>Wire No. × size                       | Indoor unit power supply                | 2 × Min. AWG16             | 2 × Min. AWG16           | —                       |                     |
|   | Indoor unit power supply earth          | 1 × Min. AWG16             | 1 × Min. AWG16           | —                       |                     |
|   | Indoor unit-Outdoor unit                | *1 2 × AWG22 (polar)       | 2 × AWG22 (polar)        | 3 × 1.5 (polar)         | 3 × 1.5 (polar)     |
|   | Indoor unit earth                       | —                          | —                        | 1 × Min. 1.5            | 1 × Min. 1.5        |
|   | Remote controller-Indoor unit           | *2 2 × AWG22 (Non-polar)   | 2 × AWG22 (Non-polar)    | 2 × 0.3 (Non-polar)     | 2 × 0.3 (Non-polar) |
| Circuit<br>rating                               | Indoor unit L1-L2                       | *3 208/230 V AC            | 208/230 V AC             | 208/230 V AC            |                     |
|   | Indoor unit-Outdoor unit S1-S2          | *3 —                       | —                        | —                       |                     |
|   | Indoor unit-Outdoor unit S2-S3          | *3 24 V DC                 | 24 V DC                  | 24 V DC                 | 24 V DC             |
|   | Remote controller-Indoor unit           | *3 12 V DC                 | 12 V DC                  | 14 V DC                 | 12 V DC             |

\*1. Maximum 393 ft [120 m]

\*2. The 30 ft [10 m] wire is attached in the remote controller accessory. Maximum 1,500 ft [500 m]

\*3. The figures are NOT always against the ground.

- Notes:**
1. Wiring size must comply with the applicable local and national code.
  2. Use copper supply wires.
  3. Use wires rated 300 V or more for the power supply cables.
  4. Install an earth longer than other cables.



### 8-3. INDOOR - OUTDOOR CONNECTING CABLE

| Outdoor power supply     | Wire No. × Size    |                    |                                   |
|--------------------------|--------------------|--------------------|-----------------------------------|
|                          | Max. 147 ft [45 m] | Max. 164 ft [50 m] | Max. 262 ft [80 m]                |
| Indoor unit-Outdoor unit | 3 × AWG16(polar)   | 3 × AWG13(polar)   | 3 × AWG13(polar) and S3 separated |

Note: The maximum cable length may vary depending on the condition of installation, humidity or materials, etc.

| Indoor/Outdoor separate power supply | Wire No. × Size     |
|--------------------------------------|---------------------|
|                                      | Max. 393 ft [120 m] |
| Indoor unit-Outdoor unit             | 2 × Min. AWG22      |

Note: The optional indoor power supply terminal kit is necessary.

Be sure to connect the indoor-outdoor connecting cables directly to the units (no intermediate connections). Intermediate connections can lead to communication errors if water enters the cables and causes insufficient insulation to ground or a poor electrical contact at the intermediate connection point.

PUZ-A18NHA6

PUZ-A18NHA6-BS

Unit: mm (in)

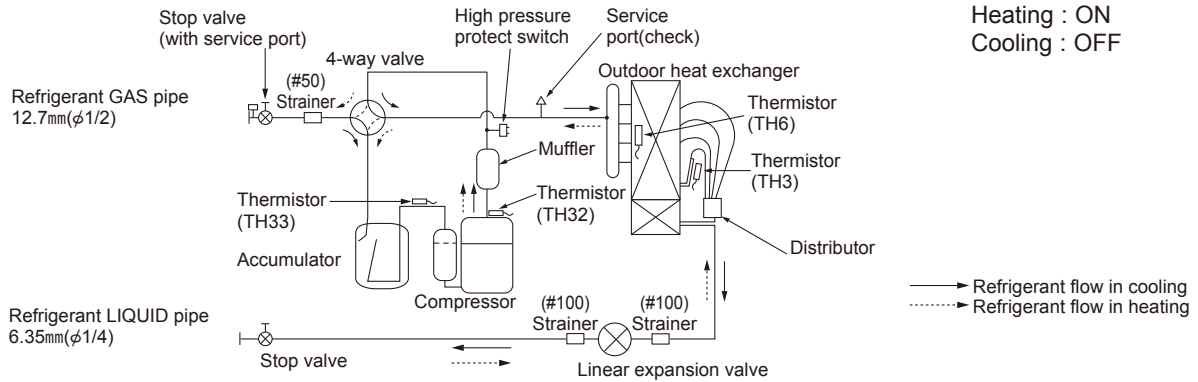

<4-way valve solenoid coil>  
 Heating : ON  
 Cooling : OFF

PUZ-A24NHA6  
 PUZ-A30NHA6  
 PUZ-A36NHA6

PUZ-A24NHA6-BS  
 PUZ-A30NHA6-BS  
 PUZ-A36NHA6-BS

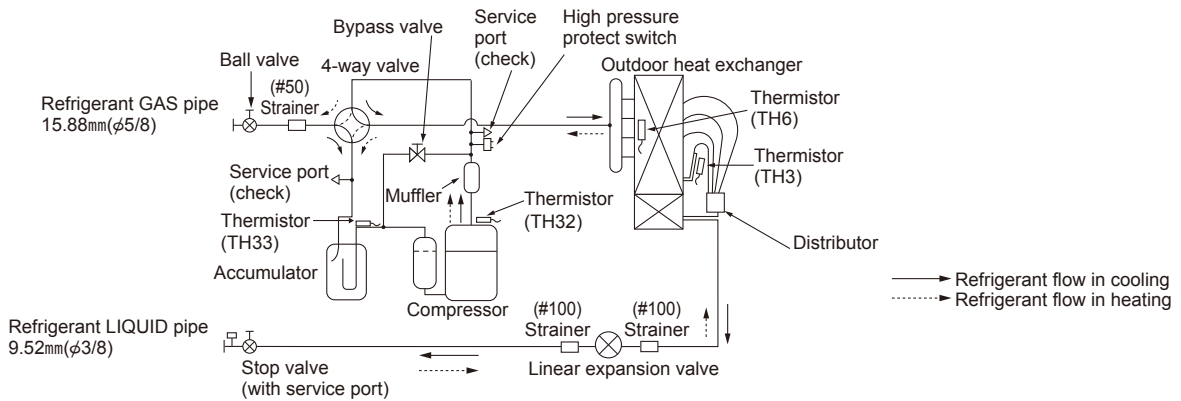

PUZ-A42NHA6

PUZ-A42NHA6-BS

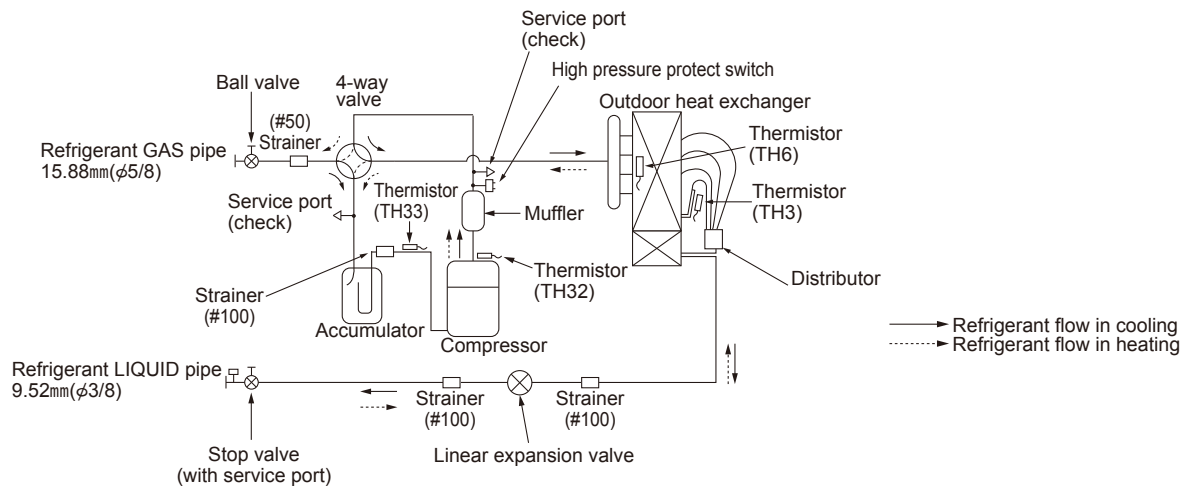

**PUY-A12NHA6**  
**PUY-A18NHA6**

**PUY-A12NHA6-BS**  
**PUY-A18NHA6-BS**

Unit: mm (in)

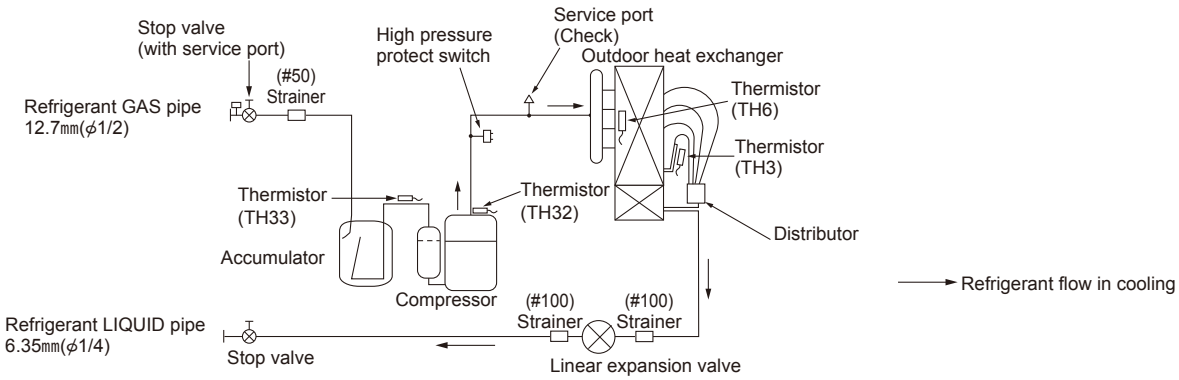

**PUY-A24NHA6**  
**PUY-A30NHA6**  
**PUY-A36NHA6**

**PUY-A24NHA6-BS**  
**PUY-A30NHA6-BS**  
**PUY-A36NHA6-BS**

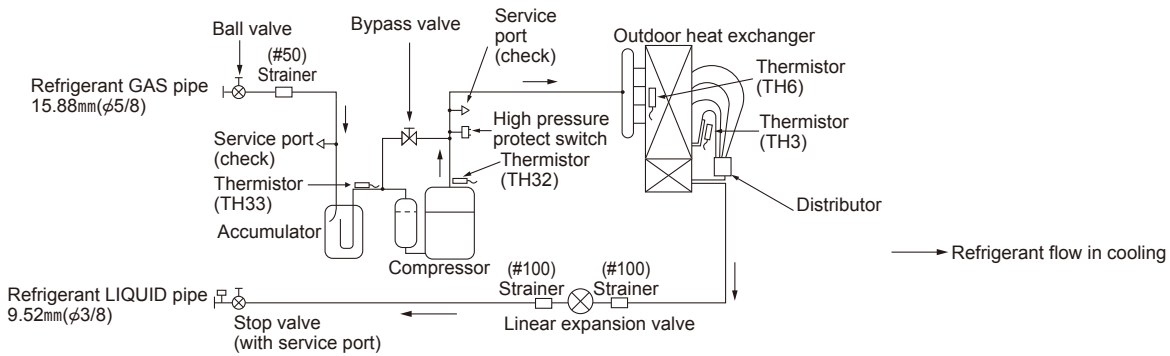

**PUY-A42NHA6**

**PUY-A42NHA6-BS**

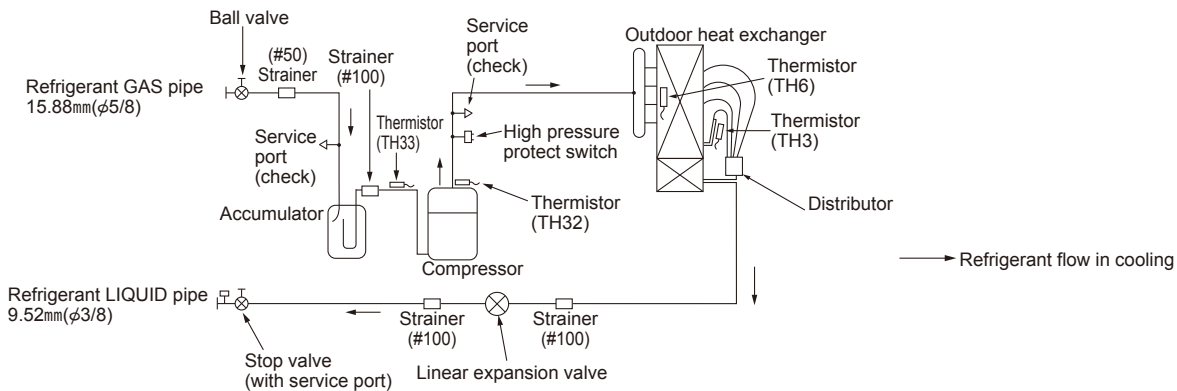

## 1. Refrigerant collecting (pump down)

Perform the following procedures to collect the refrigerant when moving the indoor unit or the outdoor unit.

- ① Supply power (circuit breaker).
  - When power is supplied, make sure that “CENTRALLY CONTROLLED” is not displayed on the remote controller. If “CENTRALLY CONTROLLED” is displayed, the refrigerant collecting (pump down) cannot be completed normally.
  - Start-up of the indoor-outdoor communication takes about 3 minutes after the power (circuit breaker) is turned on. Start the pump-down operation 3 to 4 minutes after the power (circuit breaker) is turned ON.
- ② After the liquid stop valve is closed, set SW1-1 on the control board of the outdoor unit to ON. The compressor (outdoor unit) and ventilators (indoor and outdoor units) start operating and refrigerant collecting operation begins. LED1 and LED2 on the control board of the outdoor unit are lit.
  - Only set SW1-1 to ON if the unit is stopped. However, even if the unit is stopped and SW1-1 is set to ON less than three minutes after the compressor stops, the refrigerant collecting operation cannot be performed. Wait until compressor has been stopped for three minutes and then set SW1-1 to ON again.
- ③ Because the unit automatically stops in about two to three minutes when the refrigerant collecting operation is completed (LED1 off, LED2 lit), be sure to quickly close the gas stop valve. If LED1 is lit and LED2 is off and the outdoor unit is stopped, refrigerant collection is not properly performed. Open the liquid stop valve completely, and then repeat step ② after three minutes have passed.
  - If the refrigerant collecting operation has been completed normally (LED1 off, LED2 lit), the unit will remain stopped until the power supply is turned off.
- ④ Turn off the power supply (circuit breaker).
  - Note that when the extension piping is very long with large refrigerant amount, it may not be possible to perform a pump-down operation.

### ⚠ Warning:

**When pumping down the refrigerant, stop the compressor before disconnecting the refrigerant pipes. The compressor may burst if air etc. get into it.**

## 2. Refrigerant pipe airtight testing method

- (1) Connect the testing tools.
  - Make sure the stop valves (A) (B) are closed and do not open them.
  - Add pressure to the refrigerant lines through the service port (C) of the liquid stop valve (D).
- (2) Do not add pressure to the specified pressure all at once; add pressure little by little.
  - ① Pressurize to 0.5 MPa (5 kgf/cm<sup>2</sup>G), wait 5 minutes, and make sure the pressure does not decrease.
  - ② Pressurize to 1.5 MPa (15 kgf/cm<sup>2</sup>G), wait 5 minutes, and make sure the pressure does not decrease.
  - ③ Pressurize to 4.15 MPa (41.5 kgf/cm<sup>2</sup>G) and measure the surrounding temperature and refrigerant pressure.
- (3) If the specified pressure holds for about one day and does not decrease, the pipes have passed the test and there are no leaks.
  - If the surrounding temperature changes by 1°C, the pressure will change by about 0.03 MPa (0.3 kgf/cm<sup>2</sup>G). Make the necessary corrections.
- (4) If the pressure decreases in steps (2) or (3), there is a gas leak. Look for the source of the gas leak.

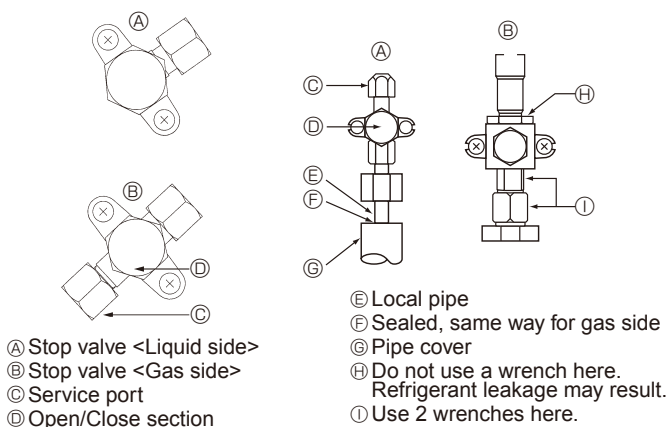

## 3. Start and finish of test run

- Operation from the indoor unit  
Execute the test run using the installation manual for the indoor unit.
- Operation from the outdoor unit  
By using the DIP switch SW4 on the control board of outdoor unit, test run can be started and finished, and its operation mode (cooling/heating) can be set up.
  - ① Set the operation mode (cooling/heating) using SW4-2.
  - ② Turn on SW4-1 to start test run with the operation mode set by SW4-2.
  - ③ Turn off SW4-1 to finish the test run.

- There may be a faint knocking sound around the machine room after power is supplied, but this is not a problem with the product because the linear expansion valve is just moving to adjust opening pulse.
- There may be a knocking sound around the machine room for several seconds after compressor starts operating. But this is not a problem with product because the check valve itself generates the sound because pressure difference is small in the refrigerant circuit.

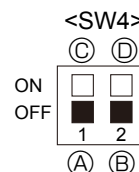

- (A) Stop (C) Operation  
 (B) Cooling (D) Heating  
 (PUZ only)

### Note:

**The operation mode cannot be changed by SW4-2 during test run. (To change test run mode, stop the unit by SW4-1, change the operation mode and restart the test run by SW4-1.)**

### 10-1. TROUBLESHOOTING

#### <Check code displayed by self-diagnosis and actions to be taken for service (summary)>

Present and past check codes are logged, and they can be displayed on the wired remote controller and control board of outdoor unit. Actions to be taken for service, which depends on whether or not the trouble is reoccurring in the field, are summarized in the table below. Check the contents below before investigating details.

| Unit conditions at service      | Check code    | Actions to be taken for service (summary)  |
|---------------------------------|---------------|--|
| The trouble is reoccurring.     | Displayed     | Judge what is wrong and take a corrective action according to "10-4. SELF-DIAGNOSIS ACTION TABLE".   |
|                                 | Not displayed | Conduct trouble shooting and ascertain the cause of the trouble according to "10-5. TROUBLESHOOTING OF PROBLEMS".  |
| The trouble is not reoccurring. | Logged        | ①Consider the temporary defects such as the work of protection devices in the refrigerant circuit including compressor, poor connection of wiring, noise , etc. Re-check the symptom, and check the installation environment, refrigerant amount, weather when the trouble occurred, matters related to wiring, etc.<br>②Reset check code logs and restart the unit after finishing service.<br>③There is no abnormality concerning of parts such as electrical component, controller board, remote controller, etc. |
|                                 | Not logged    | ①Re-check the abnormal symptom.<br>②Conduct troubleshooting and ascertain the cause of the trouble according to "10-5. TROUBLESHOOTING OF PROBLEMS".<br>③Continue to operate unit for the time being if the cause is not ascertained.<br>④There is no abnormality concerning of parts such as electrical component, controller board, remote controller, etc.  |

### 10-2. CHECK POINT UNDER TEST RUN

#### (1) Before test run

- After installation of indoor and outdoor units, piping work and electric wiring work, re-check that there is no refrigerant leakage, loosened connections and incorrect polarity.
- Measure impedance between the ground and the power supply terminal block (L1, L2) on the outdoor unit by 500V Megger and check that it is 1.0MΩ or over.

Note: Do not use 500V Megger to indoor/outdoor connecting wire terminal block (S1, S2, S3) and remote controller terminal block (1, 2). This may cause malfunction.

- Make sure that test run switch (SW4) is set to OFF before turning on power supply.
- Turn on power supply 12 hours before test run in order to protect compressor.
- For specific models which requires higher ceiling settings or auto-recovery feature from power failure, make proper changes of settings referring to the description of "12. FUNCTION SETTING".

Make sure to read operation manual before test run. (Especially items to secure safety.)

10-2-1. Test run for wired remote controller <PAR-30MAA> <PAR-31MAA>

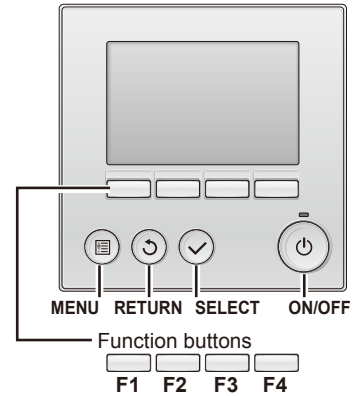

① Select "Service" from the Main menu, and press the button.



Select "Test run" with the **F1** or **F2** button, and press the button.

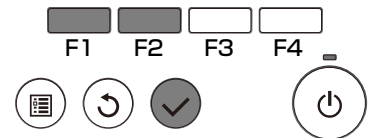
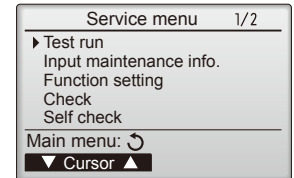

② Select "Test run" with the **F1** or **F2** button, and press the button.

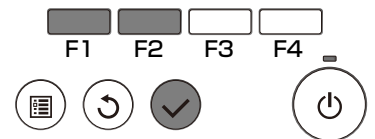
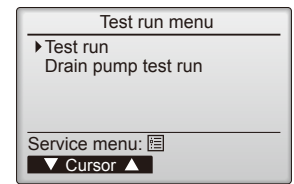

**Test run operation**

Press the **F1** button to go through the operation modes in the order of "Cool and Heat".

Cool mode: Check the cold air blows out.  
 Heat mode: Check the heat blows out.

Check the operation of the outdoor unit fan.



Press the button and open the Vane setting screen.

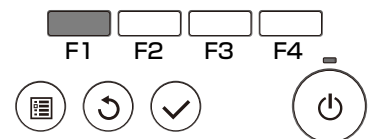
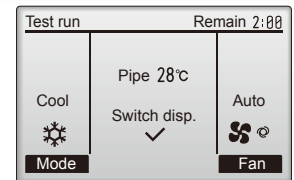

**Auto vane check**

Check the auto vane with the **F1** **F2** buttons.

Press the button to return to "Test run operation".

Press the button.

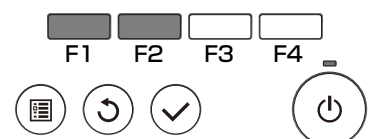
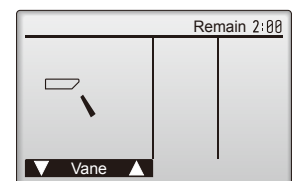

When the test run is completed, the "Test run menu" screen will appear. The test run will automatically stop after 2 hours.

## <Error information>

When an error occurs, the following screen will appear.  
Check the error status, stop the operation, and consult your dealer.

- ① Check code, error unit, refrigerant address, unit model name, and serial number will appear.  
The model name and serial number will appear only if the information has been registered.

Press the **F1** or **F2** button to go to the next page.

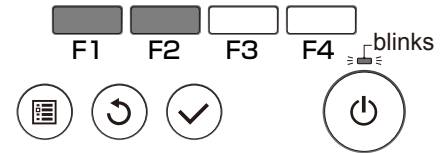
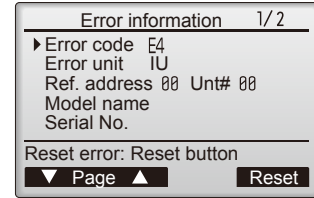

Contact information (dealer's phone number) will appear if the information has been registered.

- ② Press the **F4** button or the  button to reset the error that is occurring.

Errors cannot be reset while the ON/OFF operation is prohibited.

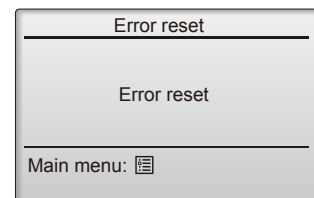
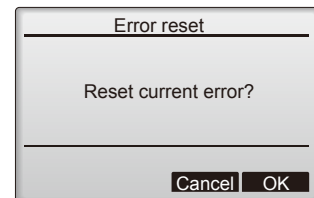
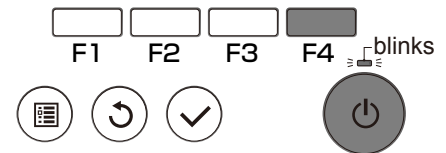
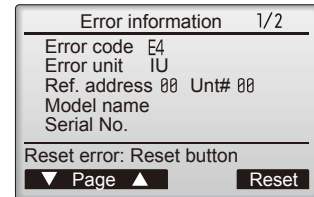

Select "OK" with the **F4** button.

### Navigating through the screens

- To go back to the Main menu .....  button

## <Checking the error information>

While no errors are occurring, page 2/2 of the error information can be viewed by selecting "Error information" from the Main menu. Errors cannot be reset from this screen.

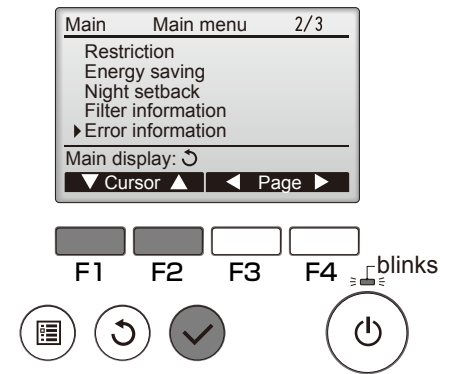

## <Error history>

- ① Select "Service" from the Main menu, and press the button.



Select "Check" with the **F1** or **F2** button, and press the button.

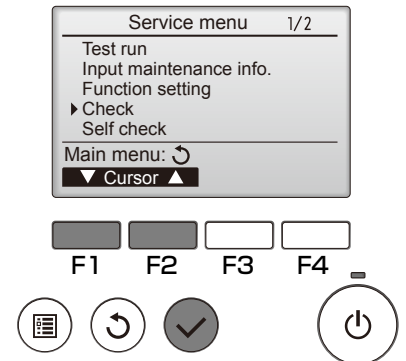

- ② Select "Error history" with the **F1** or **F2** button, and press the button.

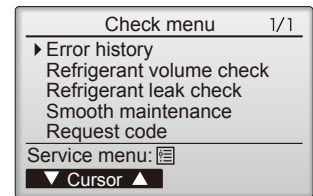

### Error history

- ③ Select "Error history" from the Check menu, and press the button to view up to 16 error history records.

4 records are shown per page, and the top record on the first page indicates the latest error record.

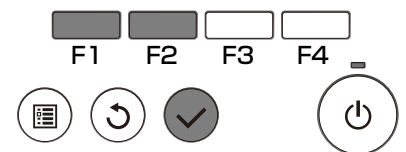
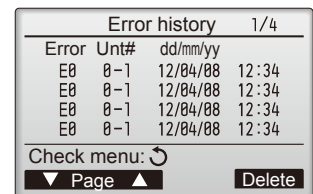

### Deleting the error history

- ④ To delete the error history, press the **F4** button (Delete) on the screen that shows error history.

A confirmation screen will appear asking if you want to delete the error history.



Press the **F4** button (OK) to delete the history.



"Error history deleted" will appear on the screen.



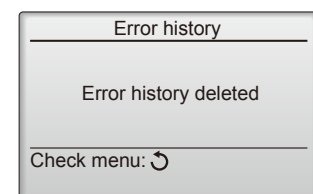
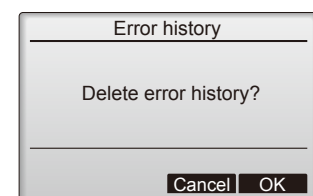

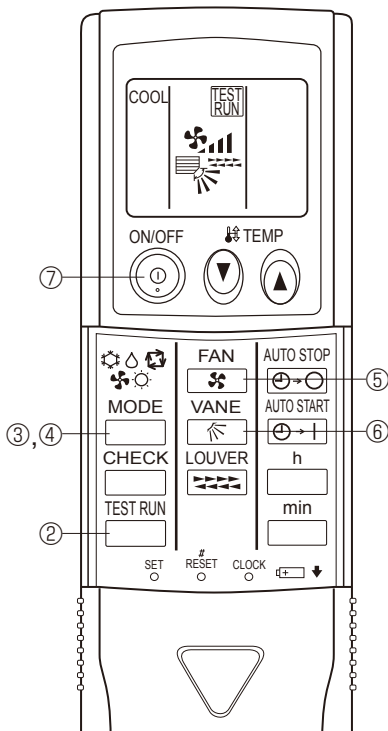









Press the button to go back to the Check menu screen.





### Test run [for IR wireless remote controller]

Measure an impedance between the power supply terminal block on the outdoor unit and ground with a 500 V Megger and check that it is equal to or greater than 1.0 MΩ.

- ① Turn on the main power to the unit.
- ② Press the  button twice continuously.  
(Start this operation from the turned off status of remote controller display.)
- ③ Press the  (     ) button to activate  mode, then check whether cool air blows out from the unit.
- ④ Press the  (     ) button to activate  mode, then check whether warm air blows out from the unit.
- ⑤ Press the  button and check whether strong air blows out from the unit.
- ⑥ Press the  button and check whether the auto vane operates properly.
- ⑦ Press the ON/OFF button to stop the test run.

#### Note:

- Point the remote controller towards the indoor unit receiver while following steps ② to ⑦.
- It is not possible to run in FAN, DRY or AUTO mode.

## 10-3. HOW TO PROCEED "SELF-DIAGNOSIS"

### 10-3-1. Self-diagnosis <PAR-30MAA> <PAR-31MAA>

① Select "Service" from the Main menu, and press the  button.



Select "Self check" with the **[F1]** or **[F2]** button, and press the  button.

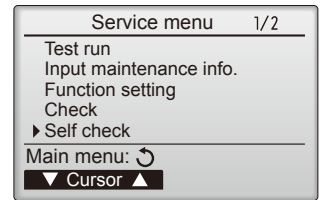

② With the **[F1]** or **[F2]** button, enter the refrigerant address, and press the  button.

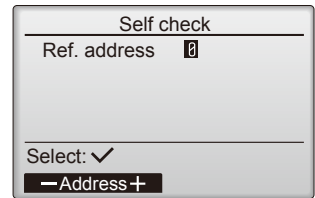

③ Check code, unit number, attribute will appear.  
"-" will appear if no error history is available.

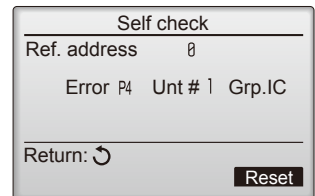

#### When there is no error history

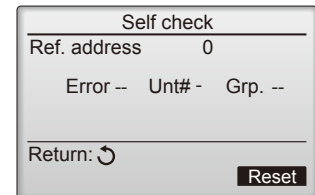

④ Resetting the error history.

Press the **[F4]** button (Reset) on the screen that shows the error history.



A confirmation screen will appear asking if you want to delete the error history.



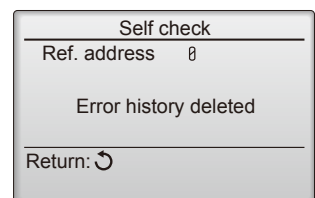
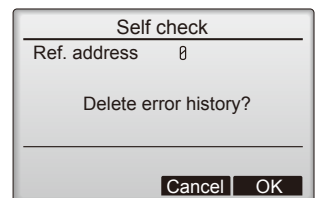

Press the **[F4]** button (OK) to delete the error history.

If deletion fails, "Request rejected" will appear.  
"Unit not exist" will appear if no indoor units that are correspond to the entered address are found.





#### Navigating through the screens

- To go back to the Main menu .....  button
- To return to the previous screen .....  button

### 10-3-2. Remote controller check <PAR-30MAA> <PAR-31MAA>



If operations cannot be completed with the remote controller, diagnose the remote controller with this function.

- ① Select "Service" from the Main menu, and press the  button.

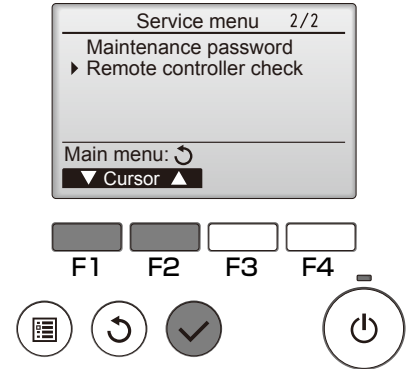
Select "Remote controller check" with the **F1** or **F2** button, and press the  button.



- ② Select "Remote controller check" from the Service menu, and press the  button to start the remote controller check and see the check results.

To cancel the remote controller check and exit the "Remote controller check" menu screen, press the  or the  button.

The remote controller will not reboot itself.

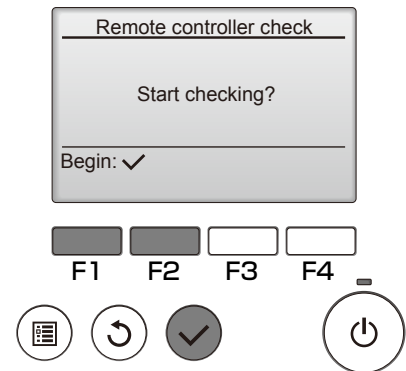

- ③
- OK: No problems are found with the remote controller. Check other parts for problems.
  - E3, 6832: There is noise on the transmission line, or the indoor unit or another remote controller is faulty. Check the transmission line and the other remote controllers.
  - NG (ALLO, ALL1): Send-receive circuit fault. The remote controller needs replacing.
  - ERC: The number of data errors is the discrepancy between the number of bits in the data transmitted from the remote controller and that of the data that was actually transmitted over the transmission line. If data errors are found, check the transmission line for external noise interference.

If the  button is pressed after the remote controller check results are displayed, remote controller check will end, and the remote controller will automatically reboot itself.

#### Remote controller check results screen

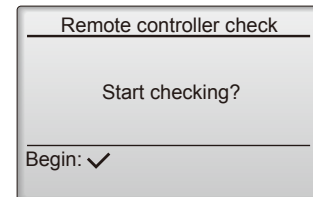

**Check the remote controller display and see if anything is displayed (including lines). Nothing will appear on the remote controller display if the correct voltage (8.5–12 V DC) is not supplied to the remote controller. If this is the case, check the remote controller wiring and indoor units.**

## 10-4. SELF-DIAGNOSIS ACTION TABLE

<Abnormalities detected when the power is turned on>

Note: Refer to indoor unit section for code P and code E.

| Check code | Abnormal point and detection method | Case  | Judgment and action  |
|------------|-------------------------------------|---|--|
| None       | —                                   | <p>① No voltage is supplied to terminal block (TB1) of outdoor unit.<br/>a) Power supply breaker is turned off.<br/>b) Contact failure or disconnection of power supply terminal<br/>c) Open phase (L1 or L2 phase)</p> <p>② Electric power is not charged to power supply terminal of outdoor power circuit board.<br/>a) Contact failure of power supply terminal<br/>b) Open phase on the outdoor power circuit board<br/>A12–A24N: Disconnection of connector R or S<br/>A30–A42N: Disconnection of connector TABT or TABS</p> <p>③ Electric power is not supplied to outdoor controller circuit board.<br/>a) Disconnection of connector (CNDC)</p> <p>④ Disconnection of reactor (DCL or ACL)</p> <p>⑤ Disconnection of outdoor noise filter circuit board or parts failure in outdoor noise filter circuit board<br/>As for A30–A42N type, it is especially needed to check the resistance RS1 on the noise filter circuit board.</p> <p>⑥ Defective outdoor power circuit board</p> <p>⑦ Defective outdoor controller circuit board</p> | <p>① Check following items.<br/>a) Power supply breaker<br/>b) Connection of power supply terminal block (TB1)<br/>c) Connection of power supply terminal block (TB1)</p> <p>② Check following items.<br/>a) Connection of power supply terminal block (TB1)<br/>b) Connection of terminal on outdoor power circuit board<br/>A12–A24N: Disconnection of connector R or S<br/>Refer to "10-9. TEST POINT DIAGRAM".<br/>A30–A42N: Disconnection of connector TABT or TABS<br/>Refer to "10-9. TEST POINT DIAGRAM".</p> <p>③ Check connection of the connector (CNDC) on the outdoor controller circuit board.<br/>Check connection of the connector, LD1 and LD2 for A12–A24N and CNDC for A30–A36N, on the outdoor power circuit board.<br/>Refer to "10-9. TEST POINT DIAGRAM".</p> <p>④ Check connection of reactor. (DCL or ACL)<br/>A12–A24N: Check connection of "LO" and "NO" on the outdoor noise filter circuit board.<br/>Check connection of "R" and "S" on the outdoor power circuit board.<br/>A30–A42N: Check connection of "L1" and "L2" on the active filter module. (ACTM)<br/>Refer to "10-9. TEST POINT DIAGRAM".</p> <p>⑤ a) Check connection of outdoor noise filter circuit board.<br/>b) Replace outdoor noise filter circuit board.<br/>Refer to "10-9. TEST POINT DIAGRAM".</p> <p>⑥ Replace outdoor power circuit board.</p> <p>⑦ Replace controller board (When items above are checked but the units cannot be repaired).</p> |

| Check code   | Abnormal point and detection method   | Case  | Judgment and action   |
|--------------|---|---|---|
| F5<br>(5201) | <b>63H connector open</b><br>Abnormal if 63H connector circuit is open for 3 minutes continuously after power supply.<br>63H: High-pressure switch  | <ul style="list-style-type: none"> <li>① Disconnection or contact failure of 63H connector on outdoor controller circuit board</li> <li>② Disconnection or contact failure of 63H</li> <li>③ 63H is working due to defective parts.</li> <li>④ Defective outdoor controller circuit board</li> </ul>  | <ul style="list-style-type: none"> <li>① Check connection of 63H connector on outdoor controller circuit board. Refer to "10-9. TEST POINT DIAGRAM".</li> <li>② Check the 63H side of connecting wire.</li> <li>③ Check continuity by tester. Replace the parts if the parts are defective.</li> <li>④ Replace outdoor controller circuit board.</li> </ul>   |
| EA<br>(6844) | <b>Miswiring of indoor/outdoor unit connecting wire</b><br>1. Outdoor controller circuit board can automatically check the number of connected indoor units. Abnormal if the number cannot be checked automatically due to miswiring of indoor/outdoor unit connecting wire, etc. after power is turned on for 4 minutes.<br>2. Abnormal if outdoor controller circuit board recognizes excessive number of indoor units. | <ul style="list-style-type: none"> <li>① Contact failure or miswiring of indoor/outdoor unit connecting wire</li> <li>② Diameter or length of indoor/outdoor unit connecting wire is out of specified capacity.</li> <li>③ Excessive number of indoor units are connected to 1 indoor unit. (4 units or more)</li> <li>④ Defective transmitting receiving circuit of outdoor controller circuit board</li> <li>⑤ Defective transmitting receiving circuit of indoor controller board</li> <li>⑥ Defective indoor power board</li> <li>⑦ 2 or more outdoor units have refrigerant address "0" . (In case of group control)</li> <li>⑧ Noise has entered into power supply or indoor / outdoor unit connecting wire.</li> </ul> | <ul style="list-style-type: none"> <li>① Check disconnection or looseness or polarity of indoor/outdoor unit connecting wire of indoor and outdoor units.</li> <li>② Check diameter and length of indoor/outdoor unit connecting wire. Total wiring length: 262 ft [80 m] (including wiring connecting each indoor unit and between indoor and outdoor unit) Also check if the connection order of flat cable is S1, S2, S3.</li> <li>③ Check the number of indoor units that are connected to one outdoor unit. (If EA is detected)</li> <li>④–⑥ Turn the power off once, and on again to check. Replace outdoor controller circuit board, indoor controller board or indoor power board if abnormality occurs again.</li> </ul> |
| Eb<br>(6845) | <b>Miswiring of indoor/outdoor unit connecting wire (converse wiring or disconnection)</b><br>Outdoor controller circuit board can automatically set the unit number of indoor units.<br>Abnormal if the indoor unit number cannot be set within 4 minutes after power on because of miswiring (converse wiring or disconnection) of indoor/outdoor unit connecting wire.   | <ul style="list-style-type: none"> <li>① Contact failure or miswiring of indoor/outdoor unit connecting wire</li> <li>② Diameter or length of indoor/outdoor unit connecting wire is out of specified capacity.</li> <li>④ Defective transmitting receiving circuit of outdoor controller circuit board</li> <li>⑤ Defective transmitting receiving circuit of indoor controller board</li> <li>⑥ Defective indoor power board</li> <li>⑦ 2 or more outdoor units have refrigerant address "0" . (In case of group control)</li> <li>⑧ Noise has entered into power supply or indoor/outdoor unit connecting wire.</li> </ul>   | <ul style="list-style-type: none"> <li>⑦ Check if refrigerant addresses (SW1-3 to SW1-6 on outdoor controller circuit board) are overlapping in case of group control system.</li> <li>⑧ Check transmission path, and remove the cause.</li> </ul> <p>Note: The descriptions above, ①–⑧, are for EA, Eb and EC.</p>   |
| EC<br>(6846) | <b>Start-up time over</b><br>The unit cannot finish start-up process within 4 minutes after power on.   | <ul style="list-style-type: none"> <li>① Contact failure of indoor/outdoor unit connecting wire</li> <li>② Diameter or length of indoor/outdoor unit connecting wire is out of specified capacity.</li> <li>⑦ 2 or more outdoor units have refrigerant address "0" . (In case of group control)</li> <li>⑧ Noise has entered into power supply or indoor/outdoor unit connecting wire.</li> </ul>   |   |

<Abnormalities detected while unit is operating>

| Check code                 | Abnormal point and detection method   | Case  | Judgment and action   |
|----------------------------|---|---|---|
| <p>U1<br/>(1302)</p>       | <p><b>High pressure (High-pressure switch 63H operated)</b><br/>Abnormal if high-pressure switch 63H worked (*) during compressor operation.<br/>*602 PSIG [4.15 MPa]</p> <p>63H: High-pressure switch</p>  | <p>① Short cycle of indoor unit<br/>② Clogged filter of indoor unit<br/>③ Decreased airflow caused by dirt of indoor fan<br/>④ Dirt of indoor heat exchanger<br/>⑤ Locked indoor fan motor<br/>⑥ Malfunction of indoor fan motor<br/>⑦ Defective operation of stop valve (Not full open)<br/>⑧ Clogged or broken pipe<br/>⑨ Locked outdoor fan motor<br/>⑩ Malfunction of outdoor fan motor<br/>⑪ Short cycle of outdoor unit<br/>⑫ Dirt of outdoor heat exchanger<br/>⑬ Decreased airflow caused by defective inspection of outside temperature thermistor (It detects lower temperature than actual temperature.)<br/>⑭ Disconnection or contact failure of connector (63H) on outdoor controller board<br/>⑮ Disconnection or contact failure of 63H connection<br/>⑯ Defective outdoor controller board<br/>⑰ Defective action of linear expansion valve<br/>⑱ Malfunction of fan driving circuit</p> | <p>①–⑥ Check indoor unit and repair the defect.</p> <p>⑦ Check if stop valve is fully open.</p> <p>⑧ Check piping and repair the defect.<br/>⑨–⑫ Check outdoor unit and repair the defect.</p> <p>⑬ Check the inspected temperature of outside temperature thermistor on LED display. (SW2 on A-Control Service Tool : Refer to "10-10. FUNCTION OF SWITCHES, CONNECTORS AND JUMPERS".)</p> <p>⑭–⑯ Turn the power off and check F5 is displayed when the power is on again. When F5 is displayed, refer to "Judgment and action" for F5.</p> <p>⑰ Check linear expansion valve. Refer to "10-6. HOW TO CHECK THE PARTS" and "10-7. HOW TO CHECK THE COMPONENTS".</p> <p>⑱ Replace outdoor controller board.</p> |
| <p>U2<br/>(TH32: 1132)</p> | <p><b>High discharge temperature</b><br/><b>High comp. surface temperature</b><br/>(1) Abnormal if discharge temperature thermistor (TH32) exceeds 257°F [125°C] or 230°F [110°C] continuously for 5 minutes.<br/>Abnormal if condenser/evaporator temperature thermistor (TH5) exceeds 104°F [40°C] during defrosting and discharge temperature thermistor (TH32) exceeds 230°F [110°C].<br/>(2) Abnormal if discharge superheat (Cooling: TH32–TH5 Heating: TH32–TH6) increases.<br/>All the conditions in A or B are detected simultaneously for 10 minutes continuously after 6 minutes past from compressor start-up (including the thermostat indication or recovery from defrosting).<br/>&lt;Condition A&gt;<br/>• Heating mode<br/>• When discharge superheat is less than 126°F [70°C].<br/>• When the TH6 temp is more than the value obtained by TH7–9°F [5°C].<br/>• When the condensing temp of TH5 is less than 95°F [35°C].<br/>&lt;Condition B&gt;<br/>• During comp. operation (Cooling and Heating)<br/>• When discharge superheat is less than 144°F [80°C] in cooling.<br/>• When discharge super heat is less than 162°F [90°C] in heating.<br/>• When condensing temp of TH6 is more than –40°F [–40°C] (In cooling only).</p> | <p>① Overheated compressor operation caused by shortage of refrigerant<br/>② Defective operation of stop valve<br/>③ Defective thermistor<br/>④ Defective outdoor controller board<br/>⑤ Defective action of linear expansion valve</p>   | <p>① Check intake superheat. Check leakage of refrigerant. Charge additional refrigerant.<br/>② Check if stop valve is fully open.</p> <p>③④ Turn the power off and check if U3 is displayed when the power is on again. When U3 is displayed, refer to "Judgment and action" for U3.</p> <p>⑤ Check linear expansion valve. Refer to "10-6. HOW TO CHECK THE PARTS" and "10-7. HOW TO CHECK THE COMPONENTS".</p>   |

| Check code   | Abnormal point and detection method   | Case   | Judgment and action   |             |  |                |                 |        |      |  |  |     |                     |                        |                       |     |                           |                        |                       |     |                      |                        |                       |     |                        |                        |                        |      |                      |                        |                       |
|--|---|--|---|-------------|--|----------------|-----------------|--------|------|--|--|-----|---------------------|------------------------|-----------------------|-----|---------------------------|------------------------|-----------------------|-----|----------------------|------------------------|-----------------------|-----|------------------------|------------------------|------------------------|------|----------------------|------------------------|-----------------------|
| U3<br>(5104)   | <b>Open/short circuit of outdoor unit temperature thermistor (TH32)</b><br>Abnormal if open (37°F [3°C] or less) or short (422°F [217°C] or more) is detected during compressor operation.<br>(Detection is inoperative for 10 minutes of compressor starting process and for 10 minutes after and during defrosting.)<br>TH32: Thermistor <Comp. surface>  | ① Disconnection or contact failure of connectors (TH32) on the outdoor controller circuit board<br>② Defective thermistor<br>③ Defective outdoor controller circuit board  | ① Check connection of connector (TH32) on the outdoor controller circuit board. Check breaking of the lead wire for TH32. Refer to "10-9. TEST POINT DIAGRAM".<br>② Check resistance value of TH32 or temperature by microprocessor. (Thermistor/TH32: Refer to "10-6. HOW TO CHECK THE PARTS".) (SW2 on A-Control Service Tool: Refer to "10-10. FUNCTION OF SWITCHES, CONNECTORS AND JUMPERS".)<br>③ Replace outdoor controller board.  |             |  |                |                 |        |      |  |  |     |                     |                        |                       |     |                           |                        |                       |     |                      |                        |                       |     |                        |                        |                        |      |                      |                        |                       |
| U4<br>(TH3:5105)<br>(TH6:5107)<br>(TH7:5106)<br>(TH8:5110)<br>(TH33:5133)  | <b>Open/short of outdoor unit thermistors (TH3, TH6, TH7, TH8 and TH33)</b><br>Abnormal if open or short is detected during compressor operation.<br>Open detection of thermistors TH3 and TH6 is inoperative for 10 seconds to 10 minutes after compressor starting and 10 minutes after and during defrosting.<br>Note: Check which unit has abnormality in its thermistor by switching the mode of SW2. (PAC-SK52ST) (Refer to "10-10. FUNCTION OF SWITCHES, CONNECTORS AND JUMPERS".) | ① Disconnection or contact failure of connectors<br>( Outdoor controller circuit board: TH3, TH6/TH7, TH33<br>Outdoor power circuit board: CN3 )<br>② Defective thermistor<br>③ Defective outdoor controller circuit board   | ① Check connection of connector (TH3, TH6/TH7, TH33) on the outdoor controller circuit board. Check connection of connector (CN3) on the outdoor power circuit board. Check breaking of the lead wire for thermistor (TH3, TH6, TH7, TH8, TH33). Refer to "10-9. TEST POINT DIAGRAM".<br>② Check resistance value of thermistor (TH3, TH6, TH7, TH8, TH33) or check temperature by microprocessor. (Thermistor / TH3, TH6, TH7, TH8, TH33 : Refer to "10-6. HOW TO CHECK THE PARTS".) (SW2 on A-Control Service Tool: Refer to "10-10. FUNCTION OF SWITCHES, CONNECTORS AND JUMPERS".)<br>③ Replace outdoor controller circuit board.<br>Note: Emergency operation is available in case of abnormalities of TH3, TH6, TH7 and TH33. Refer to "10-8. EMERGENCY OPERATION". |             |  |                |                 |        |      |  |  |     |                     |                        |                       |     |                           |                        |                       |     |                      |                        |                       |     |                        |                        |                        |      |                      |                        |                       |
| <table border="1"> <thead> <tr> <th colspan="2">Thermistors</th> <th>Open detection</th> <th>Short detection</th> </tr> <tr> <th>Symbol</th> <th>Name</th> <td></td> <td></td> </tr> </thead> <tbody> <tr> <td>TH3</td> <td>Thermistor &lt;Liquid&gt;</td> <td>-58°F [-50°C] or below</td> <td>194°F [90°C] or above</td> </tr> <tr> <td>TH6</td> <td>Thermistor &lt;2-phase pipe&gt;</td> <td>-58°F [-50°C] or below</td> <td>194°F [90°C] or above</td> </tr> <tr> <td>TH7</td> <td>Thermistor &lt;Ambient&gt;</td> <td>-58°F [-50°C] or below</td> <td>194°F [90°C] or above</td> </tr> <tr> <td>TH8</td> <td>Thermistor &lt;Heat sink&gt;</td> <td>-54°F [-48°C] or below</td> <td>216°F [102°C] or above</td> </tr> <tr> <td>TH33</td> <td>Thermistor &lt;Suction&gt;</td> <td>-58°F [-50°C] or below</td> <td>194°F [90°C] or above</td> </tr> </tbody> </table> |   |  |   | Thermistors |  | Open detection | Short detection | Symbol | Name |  |  | TH3 | Thermistor <Liquid> | -58°F [-50°C] or below | 194°F [90°C] or above | TH6 | Thermistor <2-phase pipe> | -58°F [-50°C] or below | 194°F [90°C] or above | TH7 | Thermistor <Ambient> | -58°F [-50°C] or below | 194°F [90°C] or above | TH8 | Thermistor <Heat sink> | -54°F [-48°C] or below | 216°F [102°C] or above | TH33 | Thermistor <Suction> | -58°F [-50°C] or below | 194°F [90°C] or above |
| Thermistors  |   | Open detection   | Short detection   |             |  |                |                 |        |      |  |  |     |                     |                        |                       |     |                           |                        |                       |     |                      |                        |                       |     |                        |                        |                        |      |                      |                        |                       |
| Symbol   | Name  |  |   |             |  |                |                 |        |      |  |  |     |                     |                        |                       |     |                           |                        |                       |     |                      |                        |                       |     |                        |                        |                        |      |                      |                        |                       |
| TH3  | Thermistor <Liquid>   | -58°F [-50°C] or below   | 194°F [90°C] or above   |             |  |                |                 |        |      |  |  |     |                     |                        |                       |     |                           |                        |                       |     |                      |                        |                       |     |                        |                        |                        |      |                      |                        |                       |
| TH6  | Thermistor <2-phase pipe>   | -58°F [-50°C] or below   | 194°F [90°C] or above   |             |  |                |                 |        |      |  |  |     |                     |                        |                       |     |                           |                        |                       |     |                      |                        |                       |     |                        |                        |                        |      |                      |                        |                       |
| TH7  | Thermistor <Ambient>  | -58°F [-50°C] or below   | 194°F [90°C] or above   |             |  |                |                 |        |      |  |  |     |                     |                        |                       |     |                           |                        |                       |     |                      |                        |                       |     |                        |                        |                        |      |                      |                        |                       |
| TH8  | Thermistor <Heat sink>  | -54°F [-48°C] or below   | 216°F [102°C] or above  |             |  |                |                 |        |      |  |  |     |                     |                        |                       |     |                           |                        |                       |     |                      |                        |                       |     |                        |                        |                        |      |                      |                        |                       |
| TH33   | Thermistor <Suction>  | -58°F [-50°C] or below   | 194°F [90°C] or above   |             |  |                |                 |        |      |  |  |     |                     |                        |                       |     |                           |                        |                       |     |                      |                        |                       |     |                        |                        |                        |      |                      |                        |                       |
| U5<br>(4230)   | <b>Temperature of heat sink</b><br>Abnormal if heat sink thermistor (TH8) detects temperature indicated below.<br>A12, 18, 42N .....183°F [84°C]<br>A24, 30, 36N .....177°F [81°C]  | ① The outdoor fan motor is locked.<br>② Failure of outdoor fan motor<br>③ Air flow path is clogged.<br>④ Rise of ambient temperature<br>⑤ Defective thermistor<br>⑥ Defective input circuit of outdoor power circuit board<br>⑦ Failure of outdoor fan drive circuit | ①② Check outdoor fan.<br>③ Check airflow path for cooling.<br>④ Check if there is something which causes temperature rise around outdoor unit. (Upper limit of ambient temperature is 114°F [46°C].)<br>Turn off power, and on again to check if U5 is displayed within 30 minutes.<br>If U4 is displayed instead of U5, follow the action to be taken for U4.<br>⑤ Check resistance value of thermistor (TH8) or temperature by microprocessor. (Thermistor/TH8: Refer to "10-6. HOW TO CHECK THE PARTS".) (SW2 on A-Control Service Tool: Refer to "10-10. FUNCTION OF SWITCHES, CONNECTORS AND JUMPERS".)<br>⑥ Replace outdoor power circuit board.<br>⑦ Replace outdoor controller circuit board.   |             |  |                |                 |        |      |  |  |     |                     |                        |                       |     |                           |                        |                       |     |                      |                        |                       |     |                        |                        |                        |      |                      |                        |                       |
| U6<br>(4250)   | <b>Power module</b><br>Check abnormality by driving power module in case overcurrent is detected. (UF or UP error condition)  | ① Outdoor stop valve is closed.<br>② Decrease of power supply voltage<br>③ Looseness, disconnection or converse of compressor wiring connection<br>④ Defective compressor<br>⑤ Defective outdoor power circuit board   | ① Open stop valve.<br>② Check facility of power supply.<br>③ Correct the wiring (U-V-W phase) to compressor. Refer to "10-9. TEST POINT DIAGRAM" (Outdoor power circuit board).<br>④ Check compressor referring to "10-6. HOW TO CHECK THE PARTS".<br>⑤ Replace outdoor power circuit board.  |             |  |                |                 |        |      |  |  |     |                     |                        |                       |     |                           |                        |                       |     |                      |                        |                       |     |                        |                        |                        |      |                      |                        |                       |

| Check code   | Abnormal point and detection method   | Case   | Judgment and action   |   |
|--------------|---|--|---|---|
| U8<br>(4400) | <b>Outdoor fan motor</b><br>Abnormal if the rotational frequency of fan motor is not detected during DC fan motor operation.<br>Fan motor rotational frequency is abnormal if; <ul style="list-style-type: none"> <li>• 100 rpm or below detected continuously for 15 seconds at 68°F [20°C] or more outside air temperature.</li> <li>• 50 rpm or below or 1500 rpm or more detected continuously for 1 minute.</li> </ul> | ① Failure in the operation of the DC fan motor<br>② Failure in the outdoor circuit controller board  | ① Check or replace DC fan motor.<br>② Check the voltage of the outdoor circuit controller board during operation.<br>③ Replace outdoor controller circuit board. (when the failure is still indicated even after performing the action ① above.)  |   |
| U9<br>(4220) | Detailed codes<br>To find out the detail history (latest) about U9 error, turn ON SW2-1, 2-2 and 2-6. Refer to "10-10. FUNCTION OF SWITCHES, CONNECTORS AND JUMPERS".   |  |   |   |
|              | 01  | <b>Overvoltage error</b> <ul style="list-style-type: none"> <li>• Increase in DC bus voltage to A12, 18, 24N: 420 V<br/>A30, 36, 42N: 400 V</li> </ul>   | ① Abnormal increase in power source voltage<br>② Disconnection of compressor wiring<br>③ Defective outdoor power circuit board<br>④ Compressor has a ground fault.  | ① Check the field facility for the power supply.<br>② Correct the wiring (U-V-W phase) to compressor. Refer to "10-9. TEST POINT DIAGRAM" (Outdoor power circuit board).<br>③ Replace outdoor power circuit board.<br>④ Check compressor for electrical insulation. Replace compressor. |
|              | 02  | <b>Undervoltage error</b> <ul style="list-style-type: none"> <li>• Instantaneous decrease in DC bus voltage to 200 V</li> </ul>  | ① Decrease in power source voltage, instantaneous stop.<br>② Disconnection or loose connection of CN52C on the outdoor power circuit board/ controller circuit board<br>③ Defective converter drive circuit in outdoor power circuit board<br>④ Defective 52C drive circuit in outdoor power circuit board<br>⑤ Disconnection or loose connection of CN2 on the outdoor power circuit board / controller circuit board<br>⑥ Power circuit failure on DC supply for 18 V DC output on outdoor controller circuit board | ① Check the field facility for the power supply.<br>② Check CN52C wiring.<br>③ Replace outdoor power circuit board.<br>④ Replace outdoor power circuit board.<br>⑤ Check CN2 wiring.<br>⑥ Replace outdoor controller circuit board.   |
|              | 04  | <b>Input current sensor error/ L1-phase open error</b> <ul style="list-style-type: none"> <li>• Decrease in input current through outdoor unit to 0.1 A only if operation frequency is more than or equal to 40 Hz or compressor current is more than or equal to 6 A.</li> </ul>  | ① Defective input current detection circuit in outdoor power circuit board<br>② Defective outdoor controller circuit board  | ① Replace outdoor power circuit board.<br>② Replace outdoor controller circuit board.   |
|              | 08  | <b>Abnormal power synchronous signal</b> <ul style="list-style-type: none"> <li>• No input of power synchronous signal to power circuit board</li> <li>• Power synchronous signal of 44 Hz or less, or 65 Hz or more is detected on power circuit board.</li> </ul>  | ① Disconnection or loose connection of earth wiring<br>② Defective power synchronous signal circuit in outdoor controller circuit board<br>③ Defective power synchronous signal circuit in outdoor power circuit board  | ① Check earth wiring.<br>② Replace outdoor controller circuit board.<br>③ Replace outdoor power circuit board.  |
|              | 10  | <b>PFC error (Overvoltage/ Undervoltage/Overcurrent) (A12-24N only)</b> <ul style="list-style-type: none"> <li>• PFC detected any of the following:               <ol style="list-style-type: none"> <li>a) Increase of DC bus voltage to 420 V.</li> <li>b) Decrease in PFC control voltage to 12 V DC or lower.</li> <li>c) Increase in input current to 47 A peak.</li> </ol> </li> </ul> | ① Distortion of power source voltage, noise superimposition<br>② Disconnection or loose connection of CN2 on the outdoor power circuit board/controller circuit board<br>③ Defective PFC module of outdoor power circuit board  | ① Check the field facility for the power supply.<br>② Check CN2 wiring.<br>③ Replace outdoor power circuit board.   |

| Check Code   | Abnormal point and detection method   |   | Case   | Judgment and action   |
|--------------|---|---|--|---|
| U9<br>(4220) | Detailed codes  | <b>PFC/IGBT error (Undervoltage)</b><br>• When compressor is running, DC bus voltage stays at 310 V or lower for consecutive 10 seconds   | ① Incorrect switch settings on the outdoor controller circuit board for model select<br>② Defective outdoor power circuit board<br>③ Defective outdoor controller circuit board  | ① Correction of a model select<br><br>② Replace outdoor power circuit board.<br><br>③ Replace outdoor controller circuit board.   |
|              | 20  |   |  |   |
| UF<br>(4100) | <b>Compressor overcurrent interruption (When compressor locked)</b><br>Abnormal if overcurrent of DC bus or compressor is detected within 30 seconds after compressor starts operating. |   | ① Stop valve is closed.<br>② Decrease of power supply voltage<br>③ Looseness, disconnection or converse of compressor wiring connection<br>④ Defective compressor<br>⑤ Defective outdoor power board<br>⑥ DIP Switch setting for selecting model is incorrect on the outdoor power circuit board.                              | ① Open stop valve.<br>② Check facility of power supply.<br>③ Correct the wiring (U·V·W phase) to compressor. Refer to "10-9. TEST POINT DIAGRAM", (Outdoor power circuit board).<br>④ Check compressor. Refer to "10-6. HOW TO CHECK THE PARTS".<br>⑤ Replace outdoor power circuit board.<br>⑥ Check that the DIP Switch setting is correct on the outdoor power circuit board by referring to "Model Select" in "1) Function of switches" in "10-10. FUNCTION OF SWITCHES, CONNECTORS AND JUMPERS".   |
| UH<br>(5300) | <b>Current sensor error</b><br>• It is abnormal for 38A the input current or 10 seconds continuous 34A or more.   |   | ① Defective circuit of current sensor on outdoor power circuit board<br>② Decrease of power supply voltage   | ① Replace outdoor power circuit board.<br><br>② Check the facility of power supply.   |
| UL<br>(1300) | <b>Abnormal low pressure (63L worked)</b><br>Abnormal if 63L is worked (under -4 PSIG [-0.03 MPa]) during compressor operation.<br>63L: Low-pressure switch<br><br>(A42N only)          | ① Stop valve of outdoor unit is closed during operation.<br>② Disconnection or loose connection of connector (63L) on outdoor controller board<br>③ Disconnection or loose connection of 63L<br>④ Defective outdoor controller board<br>⑤ Leakage or shortage of refrigerant<br>⑥ Malfunction of linear expansion valve | ① Check stop valve.<br><br>②-④ Turn the power off and on again to check if F3 is displayed on restarting.<br>If F3 is displayed, follow the F3 processing direction.<br><br>⑤ Correct to proper amount of refrigerant.<br>⑥ Check linear expansion valve.<br>Refer to "10-6. HOW TO CHECK THE PARTS".                          |   |
| UP<br>(4210) | <b>Compressor overcurrent interruption</b><br>Abnormal if overcurrent DC bus or compressor is detected after compressor starts operating for 30 seconds.                                |   | ① Stop valve of outdoor unit is closed.<br>② Decrease of power supply voltage<br>③ Looseness, disconnection or converse of compressor wiring connection<br>④ Defective fan of indoor/outdoor units<br>⑤ Short cycle of indoor/outdoor units<br>⑥ Defective input circuit of outdoor controller board<br>⑦ Defective compressor | ① Open stop valve.<br>② Check facility of power supply.<br>③ Correct the wiring (U·V·W phase) to compressor. Refer to "10-9. TEST POINT DIAGRAM" (Outdoor power circuit board).<br>④ Check indoor/outdoor fan.<br>⑤ Solve short cycle.<br>⑥ Replace outdoor controller circuit board.<br>⑦ Check compressor.<br>Refer to "10-6. HOW TO CHECK THE PARTS".<br><br>Note: Before the replacement of the outdoor controller circuit board, disconnect the wiring to compressor from the outdoor power circuit board and check the output voltage among phases, U, V, W, during test run. No defect on board if voltage among phases (U-V, V-W and W-U) is same. Make sure to perform the voltage check with same performing frequency. |

| Check code                            | Abnormal point and detection method   | Case   | Judgment and action  |
|---------------------------------------|---|--|--|
| E0<br>or<br>E4<br><br>(6831,<br>6834) | <b>Remote controller transmission error (E0)/signal receiving error (E4)</b><br>① Abnormal if main or sub remote controller cannot receive normally any transmission from indoor unit of refrigerant address "0" for 3 minutes. (Check code : E0)<br>② Abnormal if sub-remote controller could not receive for any signal for 2 minutes. (Check code: E0)<br><br>① Abnormal if indoor controller board cannot receive any data normally from remote controller board or from other indoor controller board for 3 minutes. (Check code: E4)<br>② Indoor controller board cannot receive any signal from remote controller for 2 minutes. (Check code: E4)  | ① Contact failure at transmission wire of remote controller<br>② All remote controllers are set as "sub" remote controller. In this case, E0 is displayed on remote controller, and E4 is displayed at LED (LED1, LED2) on the outdoor controller circuit board.<br>③ Miswiring of remote controller<br>④ Defective transmitting receiving circuit of remote controller<br>⑤ Defective transmitting receiving circuit of indoor controller board of refrigerant address "0".<br>⑥ Noise has entered into the transmission wire of remote controller. | ① Check disconnection or looseness of indoor unit or transmission wire of remote controller.<br>② Set one of the remote controllers "main". If there is no problem with the action above.<br>③ Check wiring of remote controller.<br>• Total wiring length: max. 500 m [1640ft]<br>(Do not use cable × 3 or more.)<br>• The number of connecting indoor units: max. 16 units<br>• The number of connecting remote controller: max. 2 units<br><br>If the cause of trouble is not in above ①–③,<br>④ Diagnose remote controllers.<br>a) When "RC OK" is displayed, remote controllers have no problem. Turn the power off, and on again to check. If abnormality generates again, replace indoor controller board.<br>b) When "RC NG" is displayed, replace remote controller.<br>c) When "RC E3" or "ERC 00-66" is displayed, noise may be causing abnormality.<br>Note: If the unit is not normal after replacing indoor controller board in group control, indoor controller board of address "0" may be abnormal. |
| E1<br>or<br>E2<br><br>(6832,<br>6833) | <b>Remote controller control board</b><br>① Abnormal if data cannot be normally read from the nonvolatile memory of the remote controller control board. (Check code: E1)<br>② Abnormal if the clock function of remote controller cannot be normally operated. (Check code: E2)  | ① Defective remote controller  | ① Replace remote controller.   |
| E3<br>or<br>E5<br><br>(6201,<br>6203) | <b>Remote controller transmission error (E3)/signal receiving error (E5)</b><br>① Abnormal if remote controller could not find blank of transmission path for 6 seconds and could not transmit. (Check code: E3)<br>② Remote controller receives transmitted data at the same time, compares the data, and when detecting it, judges different data to be abnormal 30 continuous times. (Check code: E3)<br><br>① Abnormal if indoor controller board could not find blank of transmission path. (Check code: E5)<br>② Indoor controller board receives transmitted data at the same time, compares the data, and when detecting it, judges different data to be abnormal 30 continuous times. (Check code: E5) | ① 2 remote controller are set as "main."<br>(In case of 2 remote controllers)<br><br>② Remote controller is connected with 2 indoor units or more.<br>③ Repetition of refrigerant address<br>④ Defective transmitting receiving circuit of remote controller<br>⑤ Defective transmitting receiving circuit of indoor controller board<br>⑥ Noise has entered into transmission wire of remote controller.  | ① Set a remote controller to main, and the other to sub.<br><br>② Remote controller is connected with only one indoor unit.<br>③ The address changes to a separate setting.<br>④–⑥ Diagnose remote controller.<br>a) When "RC OK" is displayed, remote controllers have no problem. Turn the power off, and on again to check. When becoming abnormal again, replace indoor controller board.<br>b) When "RC NG" is displayed, replace remote controller.<br>c) When "RC E3" or "ERC 00-66" is displayed, noise may be causing abnormality.  |
| E6<br><br>(6840)                      | <b>Indoor/outdoor unit communication error (Signal receiving error)</b><br>① Abnormal if indoor controller board could not receive any signal normally for 6 minutes after turning the power on.<br>② Abnormal if indoor controller board could not receive any signal normally for 3 minutes.<br>③ Consider the unit as abnormal under the following condition; When 2 or more indoor units are connected to an outdoor unit, indoor controller board could not receive a signal for 3 minutes from outdoor controller circuit board, a signal which allows outdoor controller circuit board to transmit signals.  | ① Contact failure, short circuit or miswiring (converse wiring) of indoor/outdoor unit connecting wire<br>② Defective transmitting receiving circuit of outdoor controller circuit board<br>③ Defective transmitting receiving circuit of indoor controller board<br>④ Noise has entered into indoor/outdoor unit connecting wire.<br>⑤ Defective fan motor<br>⑥ Defective rush current resistor   | Note: Check LED display on outdoor controller circuit board. (Connect A-Control service tool (PAC-SG50ST))<br>Refer to EA–EC item if LED displays EA–AC.<br>① Check disconnecting or looseness of indoor/outdoor unit connecting wire of indoor unit or outdoor unit.<br>Check all the units in case of twin indoor unit system.<br>②–④ Turn the power off, and on again to check. If abnormality generates again, replace indoor controller board or outdoor controller circuit board.<br>⑤ Turn the power off, and detach fan motor from connector (CNF1,2). Then turn the power on again. If abnormality is not displayed, replace fan motor. If abnormality is displayed, replace outdoor controller circuit board.<br>⑥ Check RS1 on outdoor noise filter board with tester. If open is detected, replace the board.<br>Note: Other indoor controller board may have defect in case of twin indoor unit system.   |

| Check code                 | Abnormal point and detection method   | Case  | Judgment and action   |
|----------------------------|---|---|---|
| E8<br>(6840)               | <b>Indoor/outdoor unit communication error (Signal receiving error) (Outdoor unit)</b><br>(1) Abnormal if outdoor controller circuit board could not receive anything normally for 3 minutes.   | ① Contact failure of indoor/outdoor unit connecting wire<br>② Defective communication circuit of outdoor controller circuit board<br>③ Defective communication circuit of indoor controller board<br>④ Noise has entered into indoor/outdoor unit connecting wire.  | ① Check disconnection or looseness of indoor/outdoor unit connecting wire of indoor or outdoor units.<br>②-④ Turn the power off, and on again to check. Replace indoor controller board or outdoor controller circuit board if abnormality is displayed again.  |
| E9<br>(6841)               | <b>Indoor/outdoor unit communication error (Transmitting error) (Outdoor unit)</b><br>(1) Abnormal if "0" receiving is detected 30 times continuously though outdoor controller circuit board has transmitted "1".<br>(2) Abnormal if outdoor controller circuit board could not find blank of transmission path for 3 minutes. | ① Indoor/outdoor unit connecting wire has contact failure.<br>② Defective communication circuit of outdoor controller circuit board<br>③ Noise has entered power supply.<br>④ Noise has entered indoor/outdoor unit connecting wire.  | ① Check disconnection or looseness of indoor/outdoor unit connecting wire.<br>②-④ Turn the power off, and on again to check. Replace outdoor controller circuit board if abnormality is displayed again.  |
| EF<br>(6607<br>or<br>6608) | <b>Non defined check code</b><br>This code is displayed when non defined check code is received.  | ① Noise has entered transmission wire of remote controller.<br>② Noise has entered indoor/outdoor unit connecting wire.<br>③ Outdoor unit is not a power-inverter models.   | ①② Turn the power off, and on again to check. Replace indoor controller board or outdoor controller circuit board if abnormality is displayed again.<br>③ Replace outdoor unit with power-inverter type outdoor unit.   |
| Ed<br>(0403)               | <b>Serial communication error</b><br>1. Abnormal if serial communication between outdoor controller circuit board and outdoor power circuit board is defective.   | ① Breaking of wire or contact failure of connector CN2 between the outdoor controller circuit board and the outdoor power circuit board<br>② Breaking of wire or contact failure of connector CN4 between the outdoor controller circuit board and the outdoor power circuit board<br>③ Defective communication circuit of outdoor power circuit board<br>④ Defective communication circuit of outdoor controller circuit board for outdoor power circuit board | ①② Check connection of each connector CN2 and CN4 between the outdoor controller circuit board and the outdoor power circuit board.<br><br>③ Replace outdoor power circuit board.<br>④ Replace outdoor controller circuit board.  |
|                            | 2. Abnormal if communication between outdoor controller circuit board and M-NET board is not available.   | ① Breaking of wire or contact failure of connector between outdoor controller circuit board and M-NET board<br><br>② Contact failure of M-NET board power supply line<br><br>③ Noise has entered into M-NET transmission wire.  | ① Check disconnection, looseness, or breaking of connection wire between outdoor controller circuit board (CNMNT) and M-NET board (CN5).<br><br>② Check disconnection, looseness, or breaking of connection wire between outdoor controller circuit board (CNMNT) and M-NET board (CND).<br>③ Check M-NET transmission wiring method. |

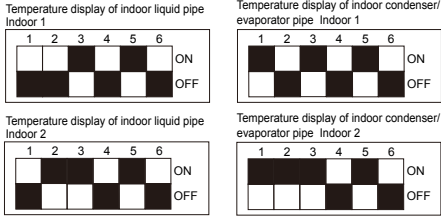
| Check code | Abnormal point and detection method   | Case  | Judgment and action  |
|------------|---|---|--|
| P8         | <p><b>Pipe temperature</b><br/>&lt;Cooling mode&gt;<br/>Detected as abnormal when the pipe temperature is not in the cooling range 3 minutes after compressor start and 6 minutes after the liquid or condenser/evaporator pipe is out of cooling range.<br/>Note 1: It takes at least 9 minutes to detect.<br/>Note 2: Abnormality P8 is not detected in drying mode.<br/>Cooling range: Indoor pipe temperature (TH2 or TH5) – intake temperature (TH1) <math>\leq -5.4^{\circ}\text{F}</math> [<math>-3^{\circ}\text{C}</math>]<br/>TH: Lower temperature between liquid pipe temperature and condenser/evaporator temperature</p> <p>&lt;Heating mode&gt;<br/>When 10 seconds have passed after the compressor starts operation and the hot adjustment mode has finished, the unit is detected as abnormal when condenser/evaporator pipe temperature is not in heating range within 20 minutes.</p> <p>Note 3: It takes at least 27 minutes to detect abnormality.<br/>Note 4: It excludes the period of defrosting (Detection restarts when defrosting mode is over)<br/>Heating range: <math>5.4^{\circ}\text{F}</math> [<math>3^{\circ}\text{C}</math>] <math>\leq</math> (Condenser/evaporator temperature (TH5) – intake temperature (TH1))</p> | <p>① Slight temperature difference between indoor room temperature and pipe &lt;liquid or condenser/evaporator&gt; temperature thermistor</p> <ul style="list-style-type: none"> <li>• Shortage of refrigerant</li> <li>• Disconnected holder of pipe &lt;liquid or condenser/evaporator&gt; thermistor</li> <li>• Defective refrigerant circuit</li> </ul> <p>② Converse connection of extension pipe (on plural units connection)</p> <p>③ Converse wiring of indoor/outdoor unit connecting wire (on plural units connection)</p> <p>④ Defective detection of indoor room temperature and pipe &lt;condenser/evaporator&gt; temperature thermistor</p> <p>⑤ Stop valve is not opened completely.</p> | <p>①–④ Check pipe &lt;liquid or condenser/evaporator&gt; temperature with room temperature display on remote controller and outdoor controller circuit board.<br/>Pipe &lt;liquid or condenser/evaporator&gt; temperature display is indicated by setting SW2 of outdoor controller circuit board as follows.</p> <p>(Conduct temperature check with outdoor controller circuit board after connecting 'A-Control Service Tool (PAC-SK52ST)'. )</p>  <p>②③ Check converse connection of extension pipe or converse wiring of indoor/outdoor unit connecting wire.</p> |

### <M-NET communication error>

Note: "Indoor unit" in the text indicates M-NET board in outdoor unit.

| Check Code   | Abnormal point and detection method   | Case   | Judgment and action  |
|--------------|---|--|--|
| A0<br>(6600) | <p><b>Address duplicate definition</b><br/>This error is displayed when transmission from the units of same address is detected.<br/>Note: The address and attribute displayed at remote controller indicate the controller that detected abnormality.</p>  | <p>① There are 2 or more same address of controller of outdoor unit, indoor unit, FRESH MASTER, or LOSSNAY.</p> <p>② Noise has entered into transmission signal and signal was transformed.</p>  | <p>Search the unit with same address as abnormality occurred. If the same address is found, turn off the power supply of outdoor unit and indoor unit and FRESH MASTER or LOSSNAY at the same time for 2 minutes or more after the address is corrected, and turn the power on again.<br/>Check transmission waveform or noise on transmission wire.</p>   |
| A2<br>(6602) | <p><b>Hardware error of transmission processor</b><br/>Transmission processor intended to transmit "0", but "1" appeared on transmission wire.<br/>Note: The address and attribute display at remote controller indicate the controller that detected abnormality.</p>  | <p>① Error is detected if waveform is transformed when wiring works of transmission wire of outdoor unit, indoor unit, FRESH MASTER or LOSSNAY are done, or polarity is changed with the power on and transmission data collide each other.</p> <p>② Defective transmitting receiving circuit of transmission processor</p> <p>③ Transmission data is changed by the noise on transmission.</p>  | <p>① If the works of transmission wire is done with the power on, turn off the power supply of outdoor unit and indoor unit and FRESH MASTER or LOSSNAY at the same time for 2 minutes or more, and turn the power on again.</p> <p>② Check transmission waveform or noise on transmission wire.</p>   |
| A3<br>(6603) | <p><b>BUS BUSY</b><br/>1. Overtime error by collision damage<br/>Abnormal if transmitting signal is not possible for 8–10 minutes continuously because of collision of transmission.<br/>2. Data could not reach transmission wire for 8–10 minutes continuously because of noise, etc.<br/>Note: The address and attribute displayed at remote controller indicate the controller that detected abnormality.</p> | <p>① Transmission processor could not transmit signal because short cycle voltage of noise and the like have entered into transmission wire continuously.</p> <p>② Transmission quantity has increased and transmission is not possible because there was wiring mistake of terminal block for transmission wire (TB3) and terminal block for central control (TB7) in outdoor unit.</p> <p>③ Transmission are mixed with others and occupation rate on transmission wire rose because of defective repeater (a function to connector or disconnect transmission of control and central control system) of outdoor unit, then abnormality is detected.</p> | <p>① Check if transmission wire of indoor unit, FRESH MASTER, LOSSNAY, or remote controller is not connected to terminal block for central control (TB7) of outdoor unit.</p> <p>② Check if transmission wire of indoor unit, FRESH MASTER or LOSSNAY is not connected to terminal block for transmission wire of outdoor unit.</p> <p>③ Check if terminal block for transmission wire (TB3) and terminal block for central control (TB7) are not connected.</p> <p>④ Check transmission waveform or noise on transmission wire.</p> |

| Check code   | Abnormal point and detection method  | Case   | Judgment and action  |
|--------------|--|--|--|
| A6<br>(6606) | <p><b>Communication error with communication processor</b><br/>Defective communication between unit processor and transmission processor<br/>Note: The address and attribute display at remote controller indicate the controller that detected abnormality.</p>   | <p>① Data of transmission processor or unit processor is not transmitted normally because of accidental trouble such as noise or lightning surge.<br/>② Address forwarding from unit processor is not transmitted normally because of defective transmission processor hardware.</p>   | <p>Turn off the power supply of outdoor unit and indoor unit and FRESH MASTER or LOSSNAY at the same time for 2 minutes or more, and turn the power on again. System returns to normal if abnormality was accidental malfunction. If the same abnormality generates again, abnormality-generated controller may be defective.</p>  |
| A7<br>(6607) | <p><b>NO ACK signal</b><br/>1. Transmitting side controller detects abnormal if a message was transmitted but there is no reply (ACK) that a message was received. Transmitting side detects abnormality every 30 seconds, 6 times continuously.<br/>Note: The address and attribute displayed at remote controller is indicate the controller that did not reply (ACK).</p> <p>2. If displayed address or attribute is outdoor unit, Indoor unit detects abnormality when indoor unit transmitted to outdoor unit and there was no reply (ACK).</p> <p>3. If displayed address or attribute is indoor unit, remote controller detects abnormality when remote controller transmitted to indoor unit and there was no reply (ACK).</p> | <p>Common factor that has no relation with abnormality source.<br/>① The unit of former address does not exist as address switch has changed while the unit was energized.<br/>② Extinction of transmission wire voltage and signal is caused by over-range transmission wire.<br/>• Maximum distance…… 656 ft [200 m]<br/>• Remote controller line… (39ft [12 m])<br/>③ Extinction of transmission wire voltage and signal is caused by type-unmatched transmission wire.<br/>Type……<br/>With shield wire-<br/>CVVS, CPEVS<br/>With normal wire (no shield)-<br/>VCTF, VCTFK, CVV<br/>CVS, VVR, VVF, VCT<br/>Diameter……1.25 mm<sup>2</sup> [AWG16] or more<br/>④ Extinction of transmission wire voltage and signal is caused by over-numbered units.<br/>⑤ Accidental malfunction of abnormality-detected controller (noise, lightning surge)<br/>⑥ Defective of abnormality generated controller</p> <p>① Contact failure of transmission wire of outdoor unit or indoor unit<br/>② Disconnection of transmission connector (CN2M) of outdoor unit<br/>③ Defective transmitting receiving circuit of outdoor unit or indoor unit</p> <p>① During group operation with indoor unit of multi- refrigerant system, if remote controller transmit to indoor unit while outdoor unit power supply of one refrigerant system is turned off or within 2 minutes of restart, abnormality is detected.<br/>② Contact failure of transmission wire of remote controller or indoor unit<br/>③ Disconnection of transmission connector (CN2M) of indoor unit<br/>④ Defective transmitting receiving circuit of indoor unit or remote controller</p> | <p><b>Always try the followings when the error “A7” occurs.</b></p> <p>① Turn off the power supply of outdoor unit and indoor unit and FRESH MASTER or LOSSNAY at the same time for 2 minutes or more, and turn the power on again. If malfunction was accidental, the unit returns to normal.<br/>② Check address switch of abnormality generated address.<br/>③ Check disconnection or looseness of abnormality generated or abnormality detected transmission wire (terminal block and connector)<br/>④ Check if tolerance range of transmission wire is not exceeded.<br/>⑤ Check if type of transmission wire is correct or not.</p> <p>If the cause of trouble is in ①–⑤ above, repair the defective, then turn off the power supply of outdoor unit and indoor unit and FRESH MASTER or LOSSNAY at the same time for 2 minutes or more, and turn the power on again.<br/>• If the cause of trouble is not in ①–⑤ above in single refrigerant system (one outdoor unit), controller of displayed address or attribute is defective.<br/>• If the cause of trouble is not in ①–⑤ above in different refrigerant system (2 or more outdoor units), judge with ⑥.</p> <p>⑥ If address of abnormality source is the address that should not exist, there is the unit that memorizes nonexistent address information. Delete useless address information with manual setting function of remote controller.<br/>Only the system FRESH MASTER or LOSSNAY are connected to, or the system that is equipped with group setting of different refrigerant system.</p> <p>If the cause of trouble is not any of ①–⑥ above, replace the controller board of displayed address or attribute.<br/>If the unit does not return to normal, multi-controller board of outdoor unit may be defective (repeater circuit).<br/>Replace multi-controller board one by one to check if the unit returns to normal.</p> |

Continued to the next page.

From the previous page.

| Check code  | Abnormal point and detection method  | Case   | Judgment and action                             |
|---|--|--|---|
| A7<br>(6607)  | 4. If displayed address or attribute is remote controller, Indoor unit detects abnormality when indoor unit transmitted to remote controller and there was no reply (ACK).   | <ul style="list-style-type: none"> <li>① During group operation with indoor unit of multi- refrigerant system, if indoor unit transmit to remote controller while outdoor unit power supply of one refrigerant system is turned off or within 2 minutes of restart, abnormality is detected.</li> <li>② Contact failure of transmission wire of remote controller or indoor unit</li> <li>③ Disconnection of transmission connector (CN2M) of indoor unit</li> <li>④ Defective transmitting receiving circuit of indoor unit or remote controller</li> </ul>   | Same as mentioned in “A7” of the previous page. |
|   | 5. If displayed address or attribute is FRESH MASTER, Indoor unit detects abnormality when indoor unit transmitted to FRESH MASTER and there was no reply (ACK).   | <ul style="list-style-type: none"> <li>① During sequential operation of indoor unit and FRESH MASTER of other refrigerant system, if indoor unit transmits to FRESH MASTER while outdoor unit power supply of same refrigerant system with FRESH MASTER is turned off or within 2 minutes of restart, abnormality is detected.</li> <li>② Contact failure of transmission wire of indoor unit or FRESH MASTER</li> <li>③ Disconnection of transmission connector (CN2M) of indoor unit or FRESH MASTER</li> <li>④ Defective transmitting receiving circuit of indoor unit or FRESH MASTER</li> </ul>   |   |
|   | 6. If displayed address or attribute is LOSSNAY, Indoor unit detects abnormality when indoor unit transmitted to LOSSNAY and there was no reply (ACK).   | <ul style="list-style-type: none"> <li>① If the power supply of LOSSNAY is turned off, indoor unit detects abnormality when it transmits to LOSSNAY.</li> <li>② During sequential operation of indoor unit and LOSSNAY of other refrigerant system, if indoor unit transmits to LOSSNAY while outdoor unit power supply of same refrigerant system with LOSSNAY is turned off or within 2 minutes of restart, abnormality is detected.</li> <li>③ Contact failure of transmission wire of indoor unit of LOSSNAY</li> <li>④ Disconnection of transmission connector (CN2M) of indoor unit</li> <li>⑤ Defective transmitting receiving circuit of indoor unit or LOSSNAY</li> </ul> |   |
| 7. If displayed address or attribute is non-existent, | <ul style="list-style-type: none"> <li>① The unit of former address does not exist as address switch has changed while the unit was energized.</li> <li>② Abnormality is detected when indoor unit transmitted because the address of FRESH MASTER and LOSSNAY are changed after sequential operation of FRESH MASTER and LOSSNAY by remote controller.</li> </ul> |  |   |

| Check code   | Abnormal point and detection method  | Case  | Judgment and action   |
|--------------|--|---|---|
| A8<br>(6608) | <p><b>M-NET NO RESPONSE</b></p> <p>Abnormal if a message was transmitted and there were reply (ACK) that message was received, but response command does not return. Transmitting side detects abnormality every 30 seconds, 6 times continuously.</p> <p>Note: The address and attribute displayed at remote controller indicate the controller that did not reply (ACK).</p> | <p>① Transmitting condition is repeated fault because of noise and the like.</p> <p>② Extension of transmission wire voltage and signal is caused by over-range transmission wire.</p> <ul style="list-style-type: none"> <li>• Maximum distance ..... 656 ft [200 m]</li> <li>• Remote controller line ....(39 ft [12 m])</li> </ul> <p>③ Extension of transmission wire voltage and signal is caused by type-unmatched transmission wire.</p> <p>Type.....</p> <ul style="list-style-type: none"> <li>With shield wire-<br/>CVVS, CPEVS</li> <li>With normal wire (no shield)-<br/>VCTF, VCTFK, CVV<br/>CVS, VVR, VVF, VCT</li> </ul> <p>Diameter.....1.25 mm<sup>2</sup> [AWG16] or more</p> <p>④ Accidental malfunction of abnormality-generated controller</p> | <p>① Check transmission waveform or noise on transmission wire.</p> <p>② Turn off the power supply of outdoor unit and indoor unit and FRESH MASTER or LOSSNAY at the same time for 2 minutes or more, and turn the power on again. If malfunction was accidental, the unit returns to normal. If the same abnormality generates again, controller of displayed address and attribute may be defective.</p> |

## 10-5. TROUBLESHOOTING OF PROBLEMS

| Phenomena   | Factor  | Countermeasure   |
|---|---|--|
| 1. Remote controller display does not work.   | <p>① 12 V DC is not supplied to remote controller. (Power supply display ● is not indicated on LCD.)</p> <p>② 12–15 V DC is supplied to remote controller, however, no display is indicated.</p> <ul style="list-style-type: none"> <li>• "PLEASE WAIT" is not displayed.</li> <li>• "PLEASE WAIT" is displayed.</li> </ul> | <p>① Check LED2 on indoor controller board.</p> <p>(1) When LED2 is lit.<br/>Check the remote controller wiring for breaking or contact failure.</p> <p>(2) When LED2 is blinking.<br/>Check short circuit of remote controller wiring.</p> <p>(3) When LED2 is not lit.<br/>Refer to phenomena No.3 below.</p> <p>② Check the following.</p> <ul style="list-style-type: none"> <li>• Failure of remote controller if "PLEASE WAIT" is not displayed</li> <li>• Refer to phenomena No.2 below if "PLEASE WAIT" is displayed.</li> </ul>   |
| 2. "PLEASE WAIT" display is remained on the remote controller.  | <p>① At longest 2 minutes after the power supply "PLEASE WAIT" is displayed to start up.</p> <p>② Communication error between the remote controller and indoor unit</p> <p>③ Communication error between the indoor and outdoor unit</p> <p>④ Outdoor unit protection device connector is open.</p>                         | <p>① Normal operation</p> <p>② Self-diagnosis of remote controller</p> <p>③ "PLEASE WAIT" is displayed for 6 minutes at most in case of indoor/outdoor unit communication error. Check LED3 on indoor controller board.</p> <p>(1) When LED3 is not blinking.<br/>Check indoor/outdoor connecting wire for miswiring.<br/>(Converse wiring of S1 and S2, or break of S3 wiring.)</p> <p>(2) When LED3 is blinking.<br/>Indoor/outdoor connecting wire is normal.</p> <p>④ Check LED display on outdoor controller circuit board. Refer to "10-10. FUNCTION OF SWITCHES, CONNECTORS AND JUMPERS".<br/>Check protection device connector (63L and 63H) for contact failure.<br/>Refer to "10-9. TEST POINT DIAGRAM".</p> |
| 3. When pressing the remote controller operation switch the OPERATION display is appeared but it will be turned off soon. | <p>① After cancelling to select function from the remote controller, the remote controller operation switch will not be accepted for approx. 30 seconds.</p>  | <p>① Normal operation</p>  |

| Phenomena  | Factor   | Countermeasure  |
|--|--|---|
| 4. Even controlling by the IR wireless remote controller no beep is heard and the unit does not start operating. Operation display is indicated on IR wireless remote controller.  | ① The pair number settings of the IR wireless remote controller and indoor controller board are mismatched.  | ① Check the pair number settings.   |
| 5. When operating by the IR wireless remote controller, beep sound is heard, however, unit does not start operating.   | ① No operation for 2 minutes at most after the power supply ON.<br>② Hand-held remote controller operation is prohibited.<br>• Remote controlling adaptor is connected to CN32 on the indoor controller board.<br>• Hand-held remote controller operation is prohibited by centralized controller etc. since it is connected to MELANS.<br>③ Refer to factor of phenomena No.2 on previous page. | ① Normal operation<br>② Normal operation<br>③ Check the details of phenomena No.2 on previous page.   |
| 6. Remote controller display works normally and the unit performs cooling operation, however, the capacity cannot be fully obtained. (The air does not cool well.)   | ① Refrigerant shortage<br><br>② Filter clogging<br><br>③ Heat exchanger clogging<br><br>④ Air duct short cycle   | ① If refrigerant leaks, discharging temperature rises and LEV opening increases.<br>Inspect leakage by checking the temperature and opening.<br>Check pipe connections for gas leakage.<br>② Open intake grille and check the filter.<br>Clean the filter by removing dirt or dust on it.<br>③ If the filter is clogged, indoor pipe temperature rises and discharging pressure increases. Check if heat exchanger is clogged by inspecting discharging pressure.<br>Clean the heat exchanger.<br>④ Remove the blockage.  |
| 7. Remote controller display works normally and the unit performs heating operation, however, the capacity cannot be fully obtained.   | ① Linear expansion valve fault<br>Opening cannot be adjusted well due to linear expansion valve fault.<br>② Refrigerant shortage<br><br>③ Lack of insulation for refrigerant piping<br>④ Filter clogging<br><br>⑤ Heat exchanger clogging<br><br>⑥ Air duct short cycle<br>⑦ Bypass circuit of outdoor unit fault  | ① Discharging temperature and indoor heat exchanger temperature does not rise.<br>Inspect the failure by checking discharging pressure.<br>Replace linear expansion valve.<br>② If refrigerant leaks, discharging temperature rises and LEV opening increases.<br>Inspect leakage by checking the temperature and opening.<br>Check pipe connections for gas leakage.<br>③ Check the insulation.<br>④ Open intake grill and check the filter. Clean the filter by removing dirt or dust on it.<br>⑤ If the filter is clogged, indoor pipe temperature rises and discharging pressure increases. Check if heat exchanger is clogged by inspecting discharging pressure.<br>Clean the heat exchanger.<br>⑥ Remove the blockage.<br>⑦ Check refrigerant system during operation. |
| 8. ① For 3 minutes after temperature adjuster turns off, the compressor will not start operating even if temperature adjuster is turned on.<br>② For 3 minutes after temperature adjuster turns on, the compressor will not stop operating even if temperature adjuster is turned off. (Compressor stops operating immediately when turning off by the remote controller.) | ①② Normal operation<br>(For protection of compressor)  | ①② Normal operation   |

**Symptoms: "PLEASE WAIT" is kept being displayed on the remote controller.**





| Diagnosis flow   | Cause   | Inspection method and troubleshooting  |
|--|---|--|
| <pre> graph TD     Start[ ] --&gt; Step1[Check the display time of "PLEASE WAIT" after turning on the main power.]     Step1 --&gt; D1{How long is "PLEASE WAIT" kept being displayed on the remote controller?}     D1 -- "6 minutes or more" --&gt; Step2[Check the LED display of the outdoor controller circuit board.]     D1 -- "2 to 6 minutes" --&gt; D2{Are any check codes displayed on the remote controller?}     D1 -- "2 minutes or less" --&gt; Cause1["• "PLEASE WAIT" will be displayed during the start-up diagnosis after turning on the main power."]     D2 -- NO --&gt; Cause1     D2 -- YES --&gt; Cause2["• Miswiring of indoor/outdoor connecting wire<br/>• Breaking of indoor/outdoor connecting wire (S3)<br/>• Defective indoor controller board<br/>• Defective outdoor controller circuit board"]     Step2 --&gt; D3{Are any check codes displayed on the LED?}     D3 -- NO --&gt; Cause3["• Defective indoor controller board<br/>• Defective remote controller"]     D3 -- YES --&gt; Cause2     </pre> | <ul style="list-style-type: none"> <li>• "PLEASE WAIT" will be displayed during the start-up diagnosis after turning on the main power.</li> <li>• Miswiring of indoor/outdoor connecting wire</li> <li>• Breaking of indoor/outdoor connecting wire (S3)</li> <li>• Defective indoor controller board</li> <li>• Defective outdoor controller circuit board</li> <li>• Defective indoor controller board</li> <li>• Defective remote controller</li> </ul> | <ul style="list-style-type: none"> <li>• Normal<br/>The start-up diagnosis will be over in around 2 minutes.</li> <li>• Refer to "Self-diagnosis action table" in order to solve the trouble.</li> <li>• In case of communication errors, the display of remote controller may not match the LED display of the outdoor unit.</li> </ul> |

**Symptoms: Nothing is displayed on the remote controller. ①**

LED display of the indoor controller board  
 LED1 : ○  
 LED2 : ○  
 LED3 : ○





| Diagnosis flow   | Cause   | Inspection method and troubleshooting   |
|--|---|---|
| <pre>                     graph TD                         Start[ ] --&gt; Step1[Check the voltage between S1 and S2 on the terminal block (TB4) of the indoor unit.]                         Step1 --&gt; Dec1{198 to 253 V AC?}                         Dec1 -- NO --&gt; Step2[Check the voltage among L1 and L2 on the terminal block (TB1) of the outdoor power circuit board.]                         Dec1 -- YES --&gt; Dec2{198 to 253 V AC?}                         Step2 --&gt; Dec2                         Dec2 -- NO --&gt; Cause1[• Troubles concerning power supply]                         Dec2 -- YES --&gt; Step3[Check the voltage between S1 and S2 on the terminal block (TB1) of the outdoor unit which is used to connect the indoor unit and the outdoor unit.]                         Step3 --&gt; Dec3{198 to 253 V AC?}                         Dec3 -- NO --&gt; Cause2[• Bad wiring of the outdoor controller board<br/>• The fuses on the outdoor controller circuit board are blown.]                         Dec3 -- YES --&gt; Step4[Check the voltage of indoor controller board (CN2D).]                         Step4 --&gt; Dec4{12 to 16 V DC?}                         Dec4 -- YES --&gt; Cause3[• Bad wiring of the outdoor controller board<br/>• The fuses on the outdoor controller circuit board are blown.]                         Dec4 -- NO --&gt; Step5[Check the voltage of the unit after removing the indoor power board (CN2S).]                         Step5 --&gt; Dec5{12 to 16 V DC ?}                         Dec5 -- YES --&gt; Cause4[• Defective indoor controller board]                         Dec5 -- NO --&gt; Cause5[• Miswiring, breaking or poor connection of indoor/outdoor connecting wire<br/>• Defective indoor power board]                     </pre> | <p>• Troubles concerning power supply</p> <p>• Bad wiring of the outdoor controller board<br/>• The fuses on the outdoor controller circuit board are blown.</p> <p>• Bad wiring of the outdoor controller board<br/>• The fuses on the outdoor controller circuit board are blown.</p> <p>• Defective indoor controller board</p> <p>• Miswiring, breaking or poor connection of indoor/outdoor connecting wire<br/>• Defective indoor power board</p> | <p>• Check the power wiring to the outdoor unit.<br/>• Check the breaker.</p> <p>• Check the wiring of the outdoor unit.<br/>• Check if the wiring is bad. Check if the fuses are blown. The fuses on the outdoor controller circuit board will be blown when the indoor /outdoor connecting wire short-circuits.</p> <p>• Check if miswiring, breaking or poor contact is causing this problem. Indoor/outdoor connecting wire is polarized 3-core type. Connect the indoor unit and the outdoor unit by wiring each pair of S1, S2 and S3 on the both side of indoor/outdoor terminal blocks.</p> <p>• Replace the indoor controller board.</p> <p>• Check if there is miswiring or breaking of wire.<br/>• Replace the indoor power board.</p> |

# Symptoms: Nothing is displayed on the remote controller. ②

LED display of the indoor controller board  
 LED1 :   
 LED2 :   
 LED3 :  or 

| Diagnosis flow  | Cause   | Inspection method and troubleshooting  |
|---|---|--|
| <p>Check the voltage between S1 and S2 on the terminal block (TB4) of the indoor unit.</p> <p>198 to 253 V AC?</p> <p>NO → Check the looseness or disconnection of the indoor/outdoor connecting wire.</p> <p>YES → Check the status of the indoor controller board LED3 display.</p> <p>Not lighting → Check the looseness or disconnection of the indoor/outdoor connecting wire.</p> <p>Blinking → Are there looseness or disconnection of the indoor/outdoor connecting wire?</p> <p>NO → Check the refrigerant address of the outdoor unit. (SW1-3 to 1-6)</p> <p>YES → Is the refrigerant address "0"?</p> <p>NO → Is anything displayed?</p> <p>YES → Check the LED display of the outdoor unit after turning on the main power again.</p> <p>Not displayed → Is "EA" or "Eb" displayed?</p> <p>NO → Is "E8" displayed?</p> <p>YES → Can the unit be restarted?</p> <p>NO → Can all the indoor unit be operated?</p> <p>YES → Check the voltage between S2 and S3 on the terminal block of the outdoor unit.</p> <p>NO → 17 to 28 V DC?</p> <p>YES →</p> | <ul style="list-style-type: none"> <li>• Breaking or poor contact of the indoor/outdoor connecting wire</li> <li>• Normal Only the unit which has the refrigerant address "0" supplies power to the remote controller.</li> <li>• Defective outdoor controller circuit board</li> <li>• Defective outdoor controller circuit board</li> <li>• Defective indoor controller board</li> <li>• Influence of electromagnetic noise</li> <li>• Defective outdoor power circuit board</li> <li>• Defective indoor power board</li> </ul> | <ul style="list-style-type: none"> <li>• Fix the breaking or poor contact of the indoor/outdoor connecting wire.</li> <li>• Set the refrigerant address to "0". In case of the multiple grouping system, recheck the refrigerant address again.</li> <li>• Replace the outdoor controller circuit board.</li> <li>• Replace the outdoor controller circuit board.</li> <li>• Replace the indoor controller board of the indoor unit which does not operate.</li> <li>• Not abnormal. There may be the influence of electromagnetic noise. Check the transmission wire and get rid of the causes.</li> <li>• Replace the outdoor power circuit board.</li> <li>• Replace the indoor power board.</li> </ul> |

**Symptoms: Nothing is displayed on the remote controller. ③**

LED display of the indoor controller board  
 LED1 :   
 LED2 :  or   
 LED3 : 

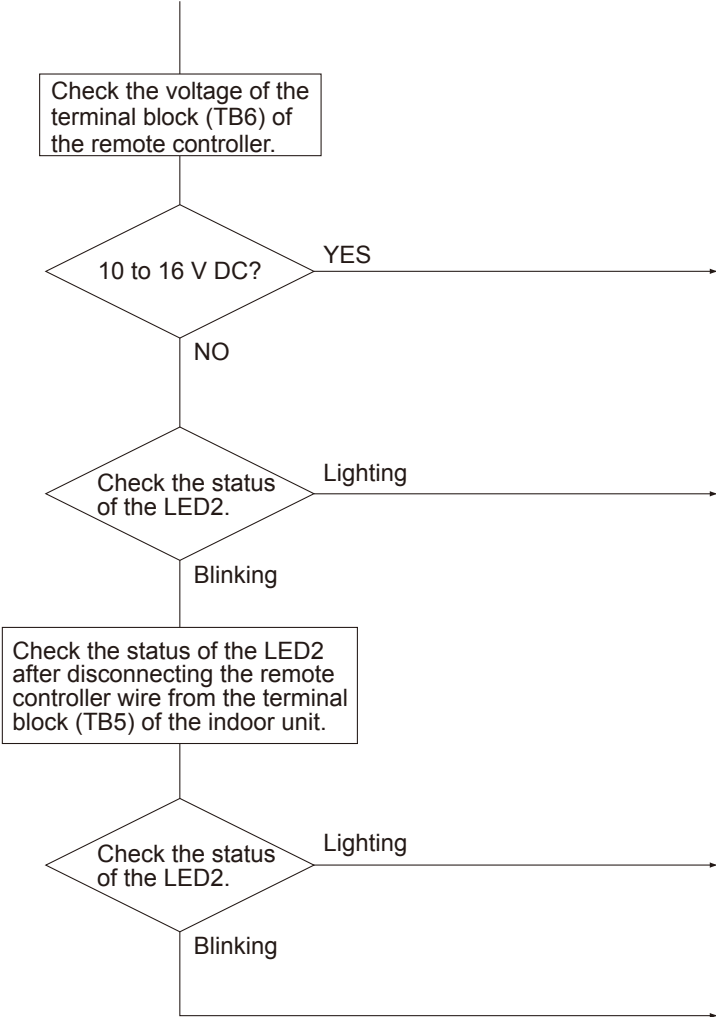
| Diagnosis flow  | Cause   | Inspection method and troubleshooting   |
|---|---|---|
|  <pre> graph TD     Start(( )) --&gt; Step1[Check the voltage of the terminal block (TB6) of the remote controller.]     Step1 --&gt; Dec1{10 to 16 V DC?}     Dec1 -- YES --&gt; Cause1[Defective remote controller]     Dec1 -- NO --&gt; Step2[Check the status of the LED2.]     Step2 -- Lighting --&gt; Cause2[Breaking or poor contact of the remote controller wire]     Step2 -- Blinking --&gt; Step3[Check the status of the LED2 after disconnecting the remote controller wire from the terminal block (TB5) of the indoor unit.]     Step3 -- Lighting --&gt; Cause3[The remote controller wire short-circuits]     Step3 -- Blinking --&gt; Cause4[Defective indoor controller board]                     </pre> | <ul style="list-style-type: none"> <li>• Defective remote controller</li> <li>• Breaking or poor contact of the remote controller wire</li> <li>• The remote controller wire short-circuits</li> <li>• Defective indoor controller board</li> </ul> | <ul style="list-style-type: none"> <li>• Replace the remote controller.</li> <li>• Check if there is breaking or poor contact of the remote controller wire. Check the voltage of the terminal block (TB5) connecting the remote controller wire. If it is not between 10 and 16 V DC, the indoor controller board must be defective.</li> <li>• Check if the remote controller wire is short-circuited.</li> <li>• Replace the indoor controller board.</li> </ul> |

• Before repair

Frequent calling from customers

| Phone Calls From Customers    |   | How to Respond   | Note   |
|-------------------------------|---|--|--|
| Unit does not operate at all. | ① The operating display of remote controller does not come on.          | ① Check if power is supplied to air conditioner. Nothing appears on the display unless power is supplied.  |  |
|                               | ② Unit cannot be restarted for a while after it's stopped.              | ② Wait around 3 minutes to restart unit.<br>The air conditioner is in a state of being protected by the microprocessor's directive. Once the compressor is stopped, the unit cannot be restarted for 3 minutes. This control is also applied when the unit is turned on and off by remote controller or thermostat.  |  |
|                               | ③ Check code appears and blinks on the display of remote controller.    | ③ Check code will be displayed if any protection devices of the air conditioner are actuated.<br>What is check code? -----   | Refer to "SELF-DIAGNOSIS ACTION TABLE".<br>▶ Check if servicing is required for the error.                 |
| Remote controller             | ① "PLEASE WAIT" is displayed on the screen.                             | ① Wait around 2 minutes.<br>An automatic startup test will be conducted for 2 minutes when power is supplied to the air conditioner. "PLEASE WAIT" will be kept being displayed while that time.   |  |
|                               | ② "FILTER" is displayed on the screen.                                  | ② This indicates that it is time to clean the air filters. Clean the air filters. Press the FILTER button on the remote controller twice to clear "FILTER" from the display.<br>See the operation manual that came with the product for how to clean the filters.  | Display time of "FILTER" depends on the model.<br>Long life filter: 2500 hrs.<br>Standard filter: 100 hrs. |
|                               | ③ "STANDBY" is displayed on the screen.                                 | ③ This is displayed when the unit starts HEAT operation, when the thermostat puts the compressor in operation mode, or when the outdoor unit ends DEFROST operation and returns to HEAT operation.<br>The display will automatically disappear around 10 minutes later.<br>While "STANDBY" is displayed on the remote controller, the airflow amount will be restricted because the indoor unit's heat exchanger is not fully heated up. In addition to that, the up/down vane will be automatically set to horizontal blow in order to prevent cold air from directly blowing out to human body. The up/down vane will return to the setting specified by the remote controller when "STANDBY" is released. |  |
|                               | ④ "DEFROST" is displayed on the screen. (No air comes out of the unit.) | ④ The outdoor unit gets frosted when the outside temperature is low and the humidity is high. "DEFROST" indicates the DEFROST operation is being performed to melt this frost. The DEFROST operation ends in around 10 minutes (at most 15 minutes).<br>During the DEFROST operation, the indoor unit's heat exchanger becomes cold, so the blower is stopped. The up/down vane will be automatically set to horizontal blow in order to prevent cold air from directly blowing out to human body. The display will turn into "STANDBY" when DEFROST operation ends.   |  |

| Phone Calls From Customers                        | How to Respond  | Note   |  |
|---|---|--|--|
| The room cannot be cooled or heated sufficiently. | ① Check the set temperature of remote controller.<br>The outdoor unit cannot be operated if the set temperature is not appropriate.<br>The outdoor unit operates in the following modes.<br>COOL: When the set temperature is lower than the room temperature.<br>HEAT: When the set temperature is higher than the room temperature. |  |  |
|   | ② Check if filters are not dirty and clogged. If filters are clogged, the airflow amount will be reduced and the unit capacity will be lowered. See the instruction manual that came with the product for how to clean the filters.   |  |  |
|   | ③ Check there is enough space around the air conditioner.<br>If there are any obstacles in the air intake or air outlet of indoor/outdoor units, they block the airflow direction so that the unit capacity will be lowered.  |  |  |
| Sound comes out from the air conditioner.         | ① A gas escaping sound is heard sometimes.  | ① This is not a malfunction.<br>This is the sound which is heard when the flow of refrigerant in the air conditioner is switched.  |  |
|   | ② A cracking sound is heard sometimes.  | ② This is not a malfunction.<br>This is the sound which is heard when internal parts of units expand or contract when the temperature changes.   |  |
|   | ③ A buzzing sound is heard sometimes.   | ③ This is not a malfunction.<br>This is the sound which is heard when the outdoor unit starts operating.   |  |
|   | ④ A ticking sound is heard from the outdoor unit sometimes.   | ④ This is not a malfunction.<br>This is the sound which is heard when the fan of the outdoor unit is controlling the airflow amount in order to keep the optimum operating condition.  |  |
|   | ⑤ A sound, similar to water flowing, is heard from the unit.  | ⑤ This is not a malfunction.<br>This is the sound which is heard when the refrigerant is flowing inside the indoor unit.   |  |
| Something is wrong with the blower.....           | ① The fan speed does not match the setting of the remote controller during DRY operation.(No air comes out sometimes during DRY operation.)   | ① This is not a malfunction. During the DRY operation, the blower's ON/OFF is controlled by the microprocessor to prevent overcooling and to ensure efficient dehumidification. The fan speed cannot be set by the remote controller during DRY operation.   |  |
|   | ② The fan speed does not match the setting of the remote controller in HEAT operation.  | ② This is not a malfunction.<br>1) When the HEAT operation starts, to prevent the unit from blowing cold air, the fan speed is gradually increased from 0 to the set speed, in proportion to the temperature rise of the discharged air.<br>2) When the room temperature reaches the set temperature and the outdoor unit stops, the unit starts the LOW AIR operation.<br>3) During the HEAT operation, the DEFROST operation is performed to defrost the outdoor unit. During the DEFROST operation, the fan is stopped to prevent cold air coming out of the indoor unit. | The up/down vane will be automatically set to horizontal blow in these cases listed up on the left (1)–3)). After a while, the up/down vane will be automatically moved according to the setting of the remote controller. |

| Phone Calls From Customers   | How to Respond   | Note   |
|--|--|--|
| Something is wrong with the blower.....  | ③ This is not a malfunction.<br>The blower is operating just for cooling down the heated-up air conditioner. This will be done within 1 minute.<br>This control is conducted only when the HEAT operation is stopped with the electric heater ON.  | However, this control is also applied to the models which has no electric heater.  |
| Something is wrong with the airflow direction....  | ① If the up/down vane is set to downward in COOL operation, it will be automatically set to horizontal blow by the microprocessor in order to prevent water from dropping down.<br>“1 Hr.” will be displayed on the remote controller if the up/down vane is set to downward with the fan speed set to be less than “LOW”.   |  |
| ② The airflow direction is changed during HEAT operation.<br>(The airflow direction cannot be set by remote controller.) | ② In HEAT operation, the up/down vane is automatically controlled according to the temperature of the indoor unit’s heat exchanger. In the following cases written below, the up/down vane will be set to horizontal blow, and the setting cannot be changed by remote controller.<br>1) At the beginning of the HEAT operation<br>2) While the outdoor unit is being stopped by thermostat or when the outdoor unit gets started to operate.<br>3) During DEFROST operation<br>The airflow direction will be back to the setting of remote controller when the above situations are released. | “STANDBY” will be displayed on the remote controller in case of 1) and 2).<br>“DEFROST” will be displayed on the screen in case of 3). |
| ③ The airflow direction does not change.<br>(Up/down vane, left/right louver)  | ③ 1) Check if the vane is set to a fixed position.<br>(Check if the vane motor connector is removed.)<br>2) Check if the air conditioner has a function for switching the air direction.<br>3) If the air conditioner doesn’t have that function, “NOT AVAILABLE” will be displayed on the remote controller when “AIR DIRECTION” or “LOUVER” button is pressed.   |  |
| The air conditioner starts operating even though any buttons on the remote controller are not pressed.                   | ① Check if you set ON/OFF timer.<br>The air conditioner starts operating at the time designated if ON timer has been set before.   |  |
|  | ② Check if any operations are ordered by distant control system or the central remote controller. While “CENTRALLY CONTROLLED INDICATOR” is displayed on the remote controller, the air conditioner is under the control of external directive.  | There might be a case that “CENTRALLY CONTROLLED INDICATOR” will not be displayed.   |
|  | ③ Check if power is recovered from power failure (black out).<br>The units will automatically start operating when power is recovered after power failure (black out) occurs. This function is called “auto recovery feature from power”.  |  |
| The air conditioner stops even though any buttons on the remote controller are not pressed.                              | ① Check if you set ON/OFF timer.<br>The air conditioner stops operating at the time designated if OFF timer has been set before.<br>② Check if any operations are ordered by distant control system or the central remote controller. While “CENTRALLY CONTROLLED INDICATOR” is displayed on the remote controller, the air conditioner is under the control of external directive.  | There might be a case that “CENTRALLY CONTROLLED INDICATOR” will not be displayed.   |

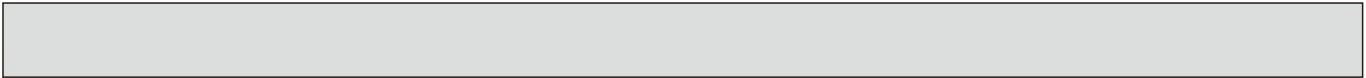

| Phone Calls From Customers   | How to Respond  | Note |
|--|---|------|
| A white mist is expelled from the indoor unit.   | This is not a malfunction.<br>This may occur when the operation gets started in the room of high humidity.  |      |
| Water or moisture is expelled from the outdoor unit.   | COOL: when pipes or piping joints are cooled, they get sweated and water drips down.<br>HEAT: water drips down from the heat exchanger.<br>Note: Use optional parts "Drain Socket" and "Drain pan" if these water needs to be collected and drained out for once. |      |
| The display of IR wireless remote controller gets dim or does not come on.<br>The indoor unit does not receive a signal from remote controller at a long distance. | Batteries are being exhausted. Replace them and press the reset button of remote controller.  |      |

## 10-6. HOW TO CHECK THE PARTS

**PUZ-A18/24/30/36/42NHA6**

**PUZ-A18/24/30/36/42NHA6-BS**

**PUY-A12/18/24/30/36/42NHA6**

**PUY-A12/18/24/30/36/42NHA6-BS**

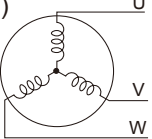
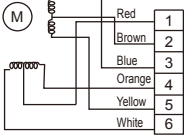
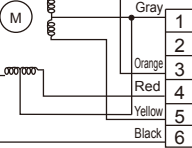
| Parts name  | Check points  |                |               |               |               |               |               |              |                |               |               |          |     |              |  |
|---|---|----------------|---------------|---------------|---------------|---------------|---------------|--------------|----------------|---------------|---------------|----------|-----|--------------|--|
| Thermistor (TH3)<br><Liquid><br>Thermistor (TH6)<br>< 2-phase pipe><br>Thermistor (TH7)<br><Ambient><br>Thermistor (TH8)<br><Heat sink><br>Thermistor (TH32)<br><Comp. Surface><br>Thermistor (TH33)<br><Suction> | Disconnect the connector then measure the resistance with a tester.<br>(At the ambient temperature 50 to 86°F [10 to 30°C]) <table border="1" style="margin-top: 10px;"> <thead> <tr> <th></th> <th>Normal</th> <th>Abnormal</th> </tr> </thead> <tbody> <tr> <td>TH32</td> <td>160 to 410 kΩ</td> <td rowspan="5">Open or short</td> </tr> <tr> <td>TH3</td> <td rowspan="3">4.3 to 9.6 kΩ</td> </tr> <tr> <td>TH6</td> </tr> <tr> <td>TH7</td> </tr> <tr> <td>TH33</td> </tr> <tr> <td>TH8</td> <td>39 to 105 kΩ</td> </tr> </tbody> </table> |                | Normal        | Abnormal      | TH32          | 160 to 410 kΩ | Open or short | TH3          | 4.3 to 9.6 kΩ  | TH6           | TH7           | TH33     | TH8 | 39 to 105 kΩ |  |
|   | Normal  | Abnormal       |               |               |               |               |               |              |                |               |               |          |     |              |  |
| TH32  | 160 to 410 kΩ   | Open or short  |               |               |               |               |               |              |                |               |               |          |     |              |  |
| TH3   | 4.3 to 9.6 kΩ   |                |               |               |               |               |               |              |                |               |               |          |     |              |  |
| TH6   |   |                |               |               |               |               |               |              |                |               |               |          |     |              |  |
| TH7   |   |                |               |               |               |               |               |              |                |               |               |          |     |              |  |
| TH33  |   |                |               |               |               |               |               |              |                |               |               |          |     |              |  |
| TH8   | 39 to 105 kΩ  |                |               |               |               |               |               |              |                |               |               |          |     |              |  |
| Fan motor (MF1,MF2)   | Refer to "10-6-8. Check method of DC fan motor (fan motor/ outdoor controller circuit board)".  |                |               |               |               |               |               |              |                |               |               |          |     |              |  |
| Solenoid valve coil<br><4-way valve><br>(21S4)  | Measure the resistance between the terminals with a tester.<br>(At the ambient temperature 68°F [20°C]) <table border="1" style="margin-top: 10px;"> <thead> <tr> <th colspan="2">Normal</th> <th>Abnormal</th> </tr> </thead> <tbody> <tr> <td>A18-36</td> <td>A42</td> <td rowspan="2">Open or short</td> </tr> <tr> <td>1500 ± 150 Ω</td> <td>2350 ± 170 Ω</td> </tr> </tbody> </table>  | Normal         |               | Abnormal      | A18-36        | A42           | Open or short | 1500 ± 150 Ω | 2350 ± 170 Ω   |               |               |          |     |              |  |
| Normal  |   | Abnormal       |               |               |               |               |               |              |                |               |               |          |     |              |  |
| A18-36  | A42   | Open or short  |               |               |               |               |               |              |                |               |               |          |     |              |  |
| 1500 ± 150 Ω  | 2350 ± 170 Ω  |                |               |               |               |               |               |              |                |               |               |          |     |              |  |
| Motor for compressor<br>(MC)   | Measure the resistance between the terminals with a tester.<br>(Winding temperature 68°F [20°C]) <table border="1" style="margin-top: 10px;"> <thead> <tr> <th colspan="3">Normal</th> <th>Abnormal</th> </tr> </thead> <tbody> <tr> <td>A12, 18</td> <td>A24, 30, 36</td> <td>A42</td> <td rowspan="2">Open or short</td> </tr> <tr> <td>0.320 Ω</td> <td>0.880 Ω</td> <td>0.266 Ω</td> </tr> </tbody> </table>  | Normal         |               |               | Abnormal      | A12, 18       | A24, 30, 36   | A42          | Open or short  | 0.320 Ω       | 0.880 Ω       | 0.266 Ω  |     |              |  |
| Normal  |   |                | Abnormal      |               |               |               |               |              |                |               |               |          |     |              |  |
| A12, 18   | A24, 30, 36   | A42            | Open or short |               |               |               |               |              |                |               |               |          |     |              |  |
| 0.320 Ω   | 0.880 Ω   | 0.266 Ω        |               |               |               |               |               |              |                |               |               |          |     |              |  |
| Linear expansion valve<br>(LEV-A)<br>For A12, 18   | Disconnect the connector then measure the resistance with a tester.<br>(Winding temperature 68°F [20°C]) <table border="1" style="margin-top: 10px;"> <thead> <tr> <th colspan="4">Normal</th> <th>Abnormal</th> </tr> </thead> <tbody> <tr> <td>Red - White</td> <td>Red - Orange</td> <td>Brown - Yellow</td> <td>Brown - Blue</td> <td rowspan="2">Open or short</td> </tr> <tr> <td colspan="4">46 ± 4 Ω</td> </tr> </tbody> </table>   | Normal         |               |               |               | Abnormal      | Red - White   | Red - Orange | Brown - Yellow | Brown - Blue  | Open or short | 46 ± 4 Ω |     |              |  |
| Normal  |   |                |               | Abnormal      |               |               |               |              |                |               |               |          |     |              |  |
| Red - White   | Red - Orange  | Brown - Yellow | Brown - Blue  | Open or short |               |               |               |              |                |               |               |          |     |              |  |
| 46 ± 4 Ω  |   |                |               |               |               |               |               |              |                |               |               |          |     |              |  |
| Linear expansion valve<br>(LEV-A)<br>For A24-42    | Disconnect the connector then measure the resistance with a tester.<br>(Winding temperature 68°F [20°C]) <table border="1" style="margin-top: 10px;"> <thead> <tr> <th colspan="4">Normal</th> <th>Abnormal</th> </tr> </thead> <tbody> <tr> <td>Gray - Black</td> <td>Gray - Red</td> <td>Gray - Yellow</td> <td>Gray - Orange</td> <td rowspan="2">Open or short</td> </tr> <tr> <td colspan="4">46 ± 3 Ω</td> </tr> </tbody> </table>  | Normal         |               |               |               | Abnormal      | Gray - Black  | Gray - Red   | Gray - Yellow  | Gray - Orange | Open or short | 46 ± 3 Ω |     |              |  |
| Normal  |   |                |               | Abnormal      |               |               |               |              |                |               |               |          |     |              |  |
| Gray - Black  | Gray - Red  | Gray - Yellow  | Gray - Orange | Open or short |               |               |               |              |                |               |               |          |     |              |  |
| 46 ± 3 Ω  |   |                |               |               |               |               |               |              |                |               |               |          |     |              |  |
| Solenoid valve coil<br><Bypass valve><br>(SV)<br>For A24-36 only  | Measure the resistance between the terminals with a tester.<br>(At the ambient temperature 68°F [20°C]) <table border="1" style="margin-top: 10px;"> <thead> <tr> <th>Normal</th> <th>Abnormal</th> </tr> </thead> <tbody> <tr> <td>1450 ± 150 Ω</td> <td>Open or short</td> </tr> </tbody> </table>  | Normal         | Abnormal      | 1450 ± 150 Ω  | Open or short |               |               |              |                |               |               |          |     |              |  |
| Normal  | Abnormal  |                |               |               |               |               |               |              |                |               |               |          |     |              |  |
| 1450 ± 150 Ω  | Open or short   |                |               |               |               |               |               |              |                |               |               |          |     |              |  |



## 10-6-2. Check method of noise filter circuit board

**PUZ-A18NHA6**  
**PUY-A12/18NHA6**

**PUZ-A18NHA6-BS**  
**PUY-A12/18NHA6-BS**

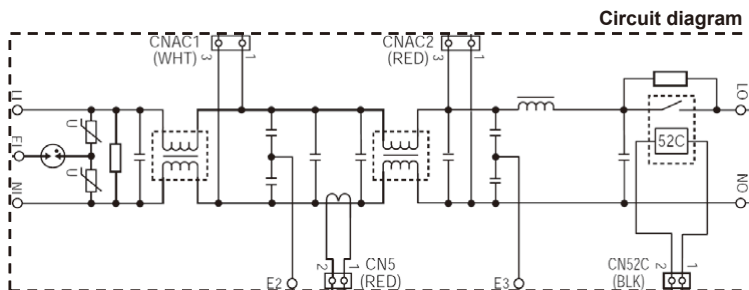
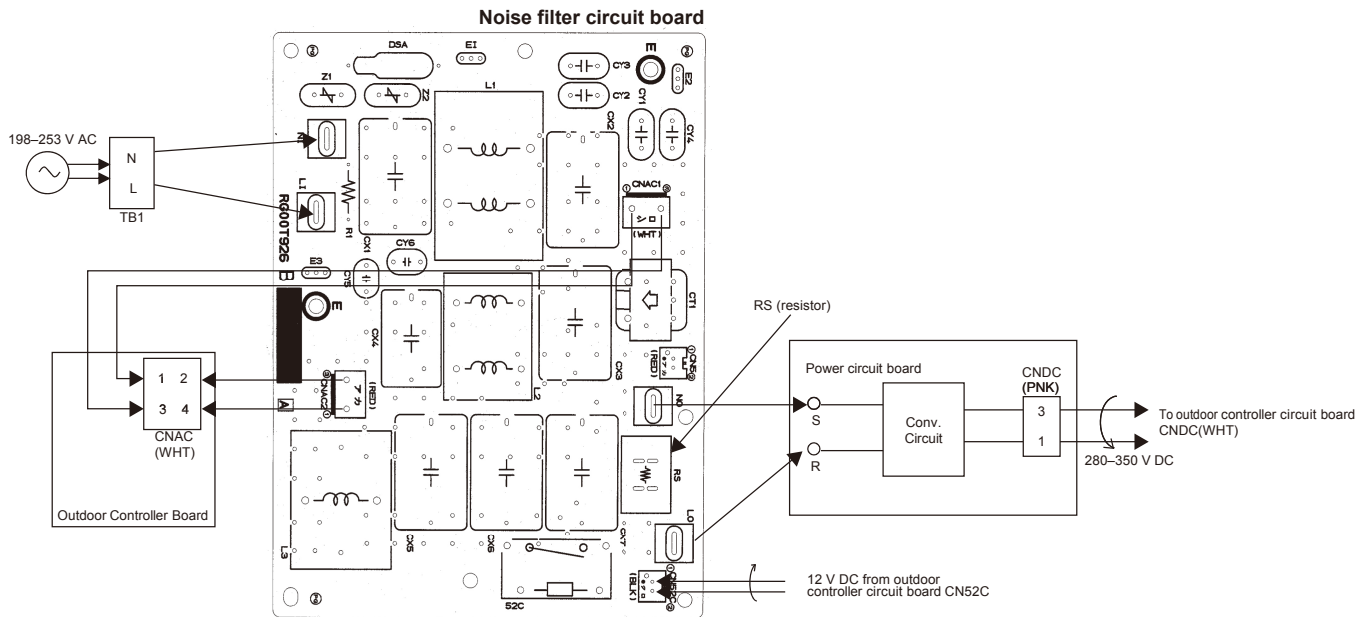
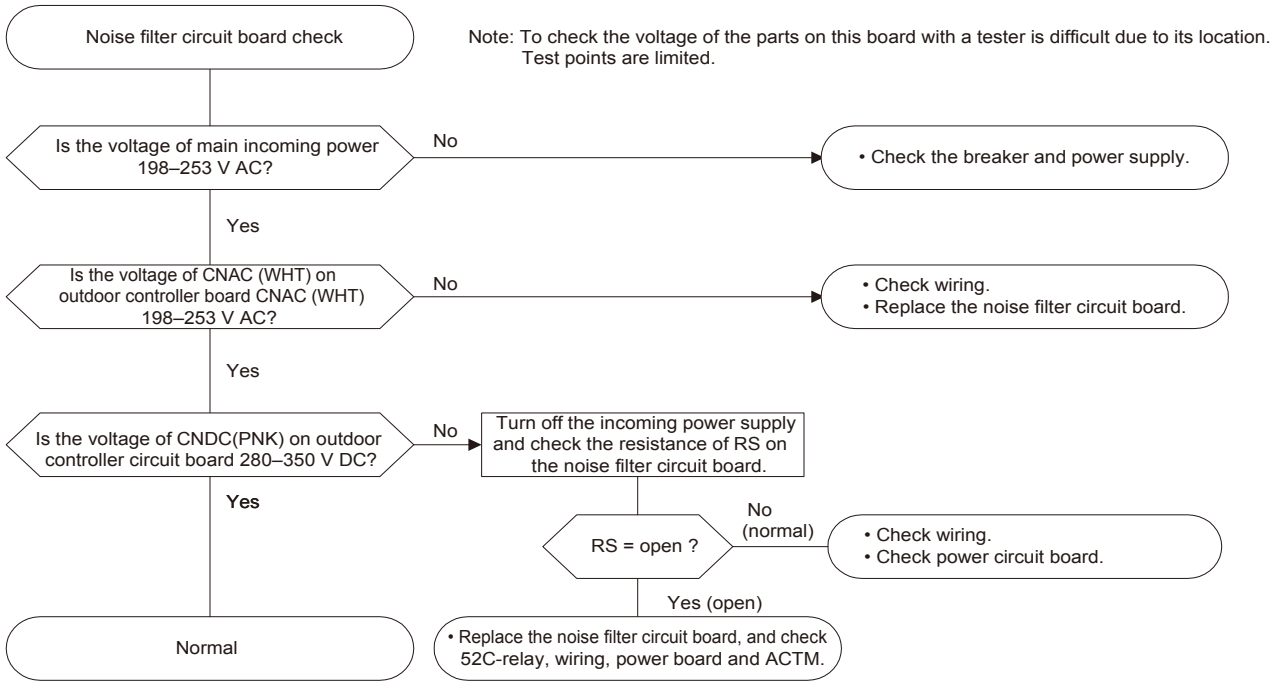

### 10-6-3. Check method of noise filter circuit board

**PUZ-A24NHA6  
PUY-A24NHA6**      **PUZ-A24NHA6-BS  
PUY-A24NHA6-BS**

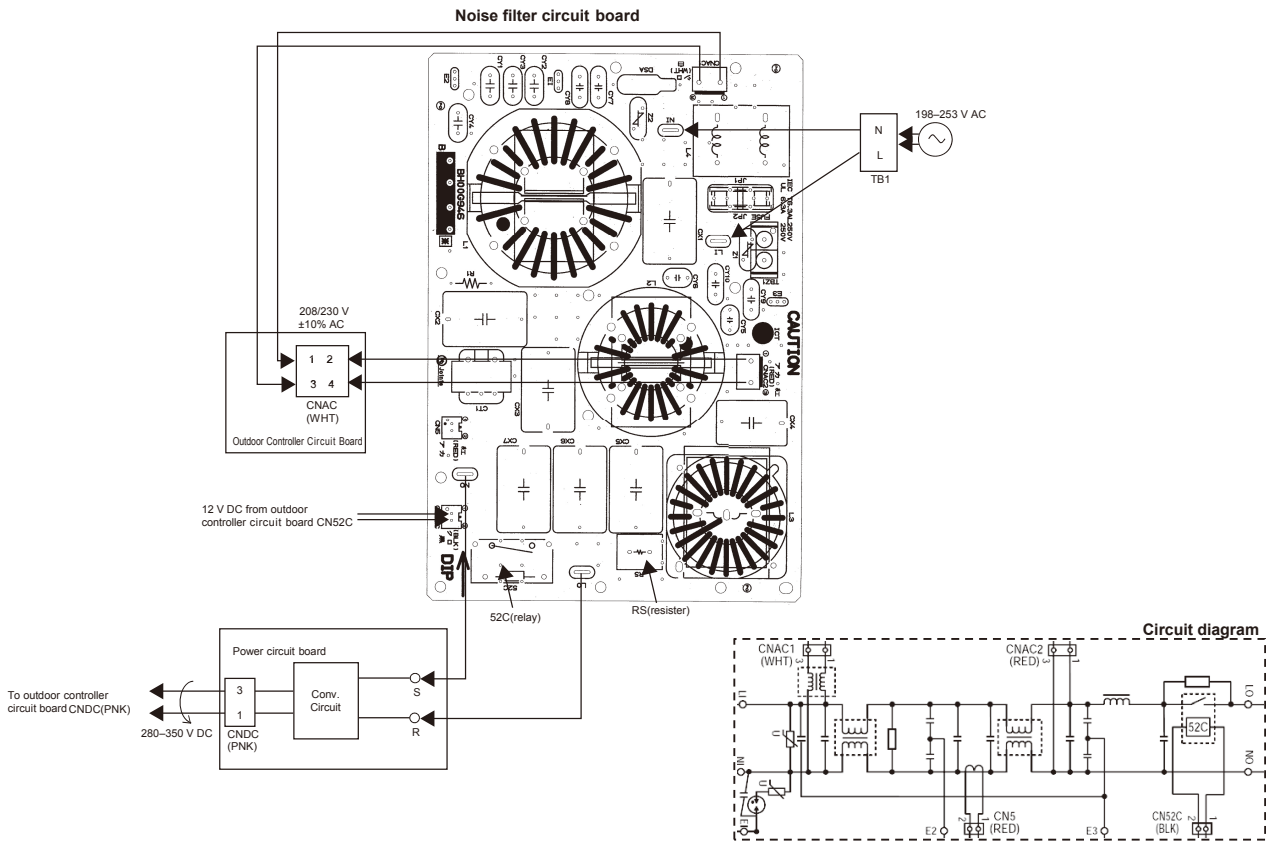
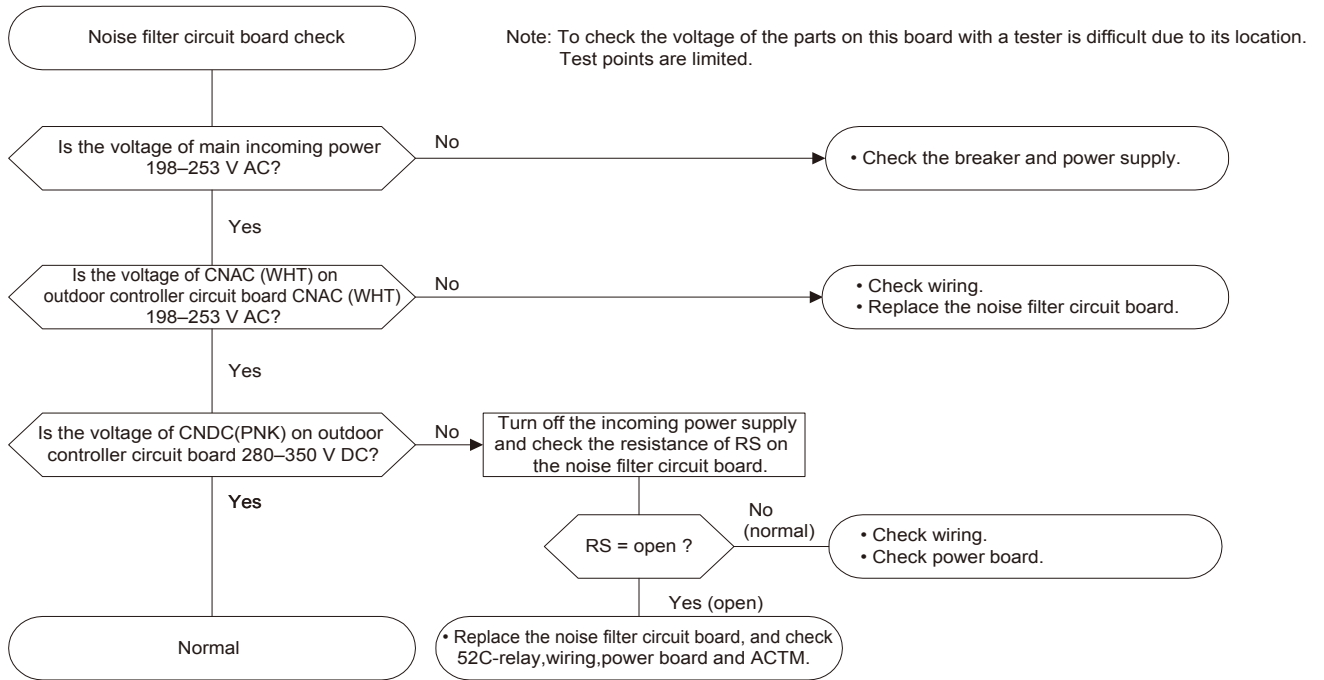

### 10-6-4. Check method of noise filter circuit board

PUZ-A30/36/42NHA6  
PUY-A30/36/42NHA6

PUZ-A30/36/42NHA6-BS  
PUY-A30/36/42NHA6-BS

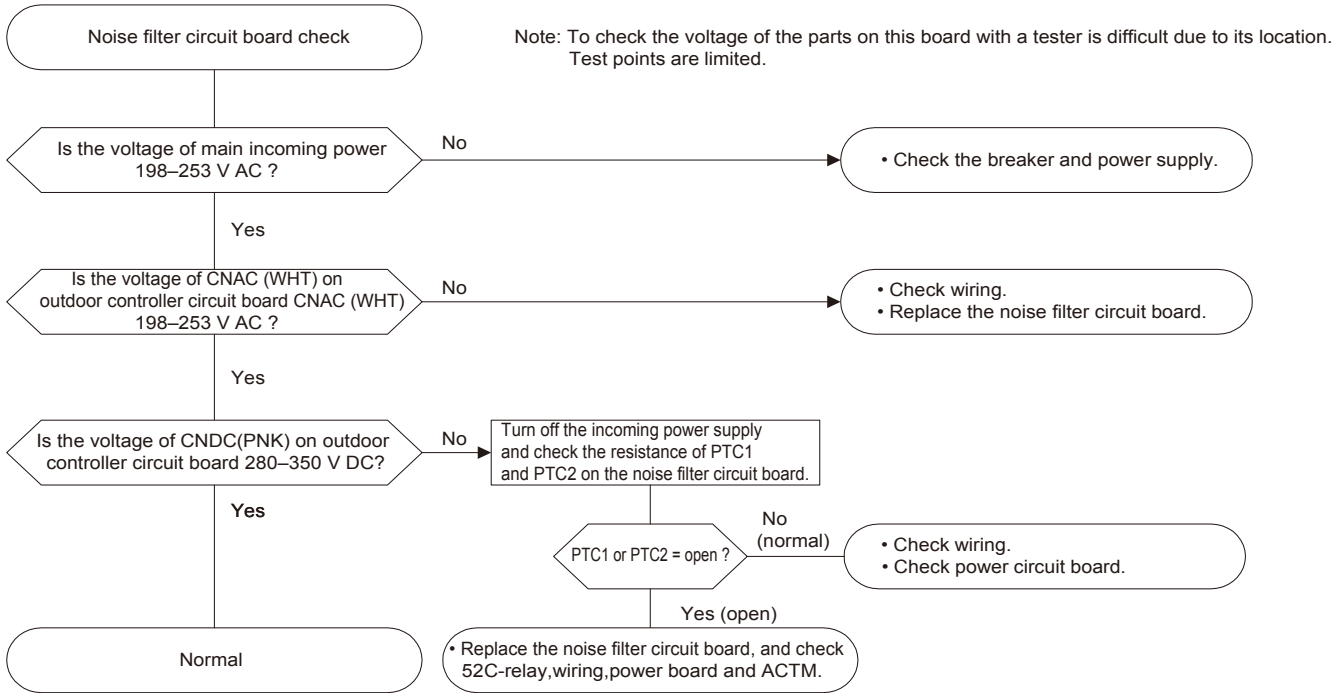

#### Circuit diagram

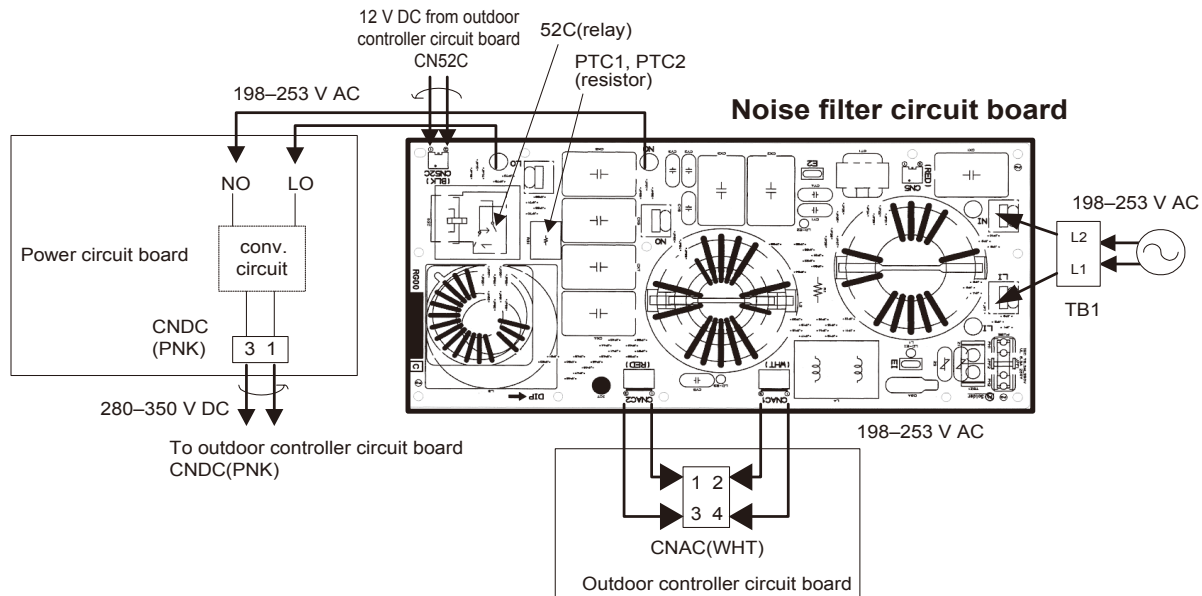
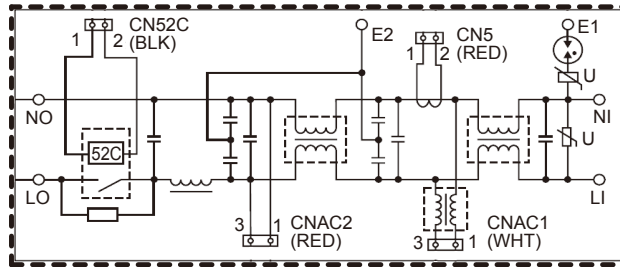

### 10-6-5. Check method of power circuit board

**PUZ-A18/24NHA6  
PUY-A12/18/24NHA6**

**PUZ-A18/24NHA6-BS  
PUY-A12/18/24NHA6-BS**

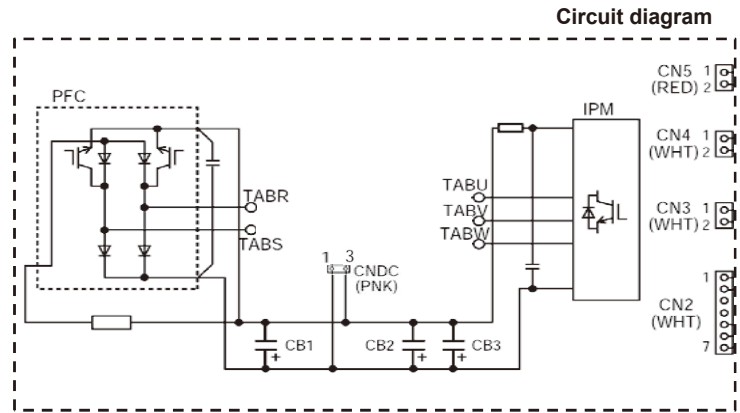
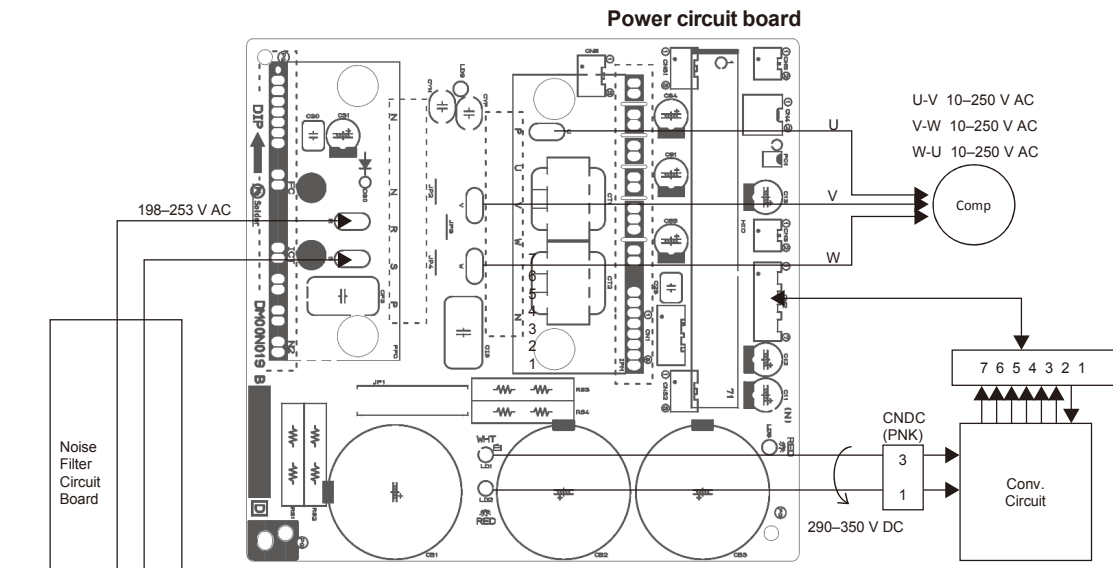
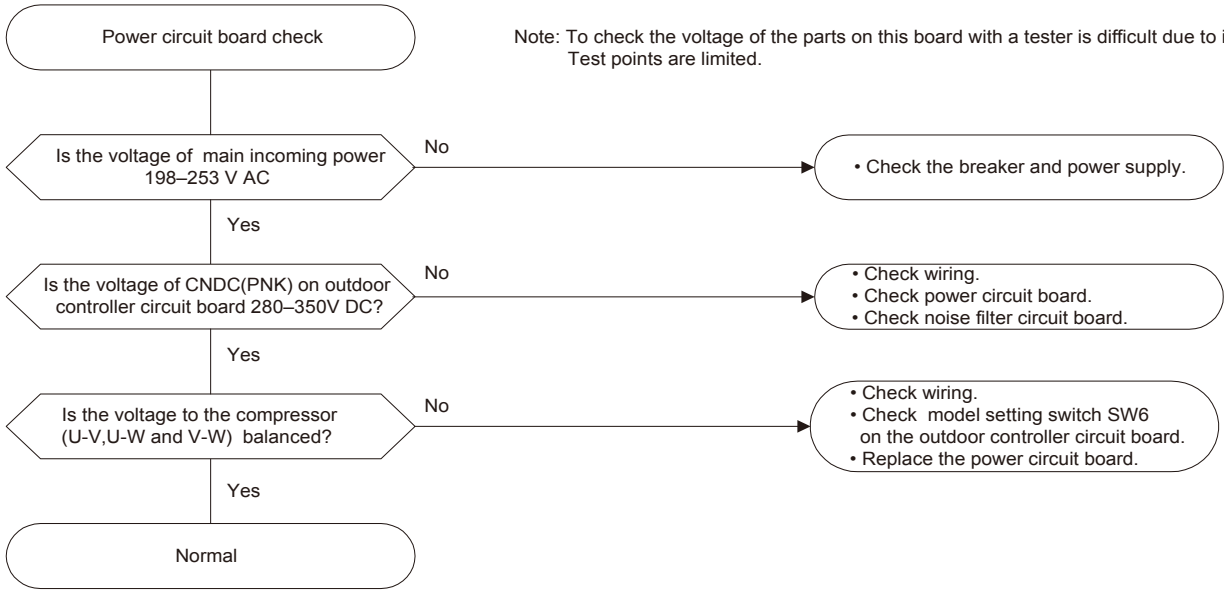

## 10-6-6. Check method of power circuit board

PUZ-A30/36/42NHA6  
PUY-A30/36/42NHA6

PUZ-A30/36/42NHA6-BS  
PUY-A30/36/42NHA6-BS

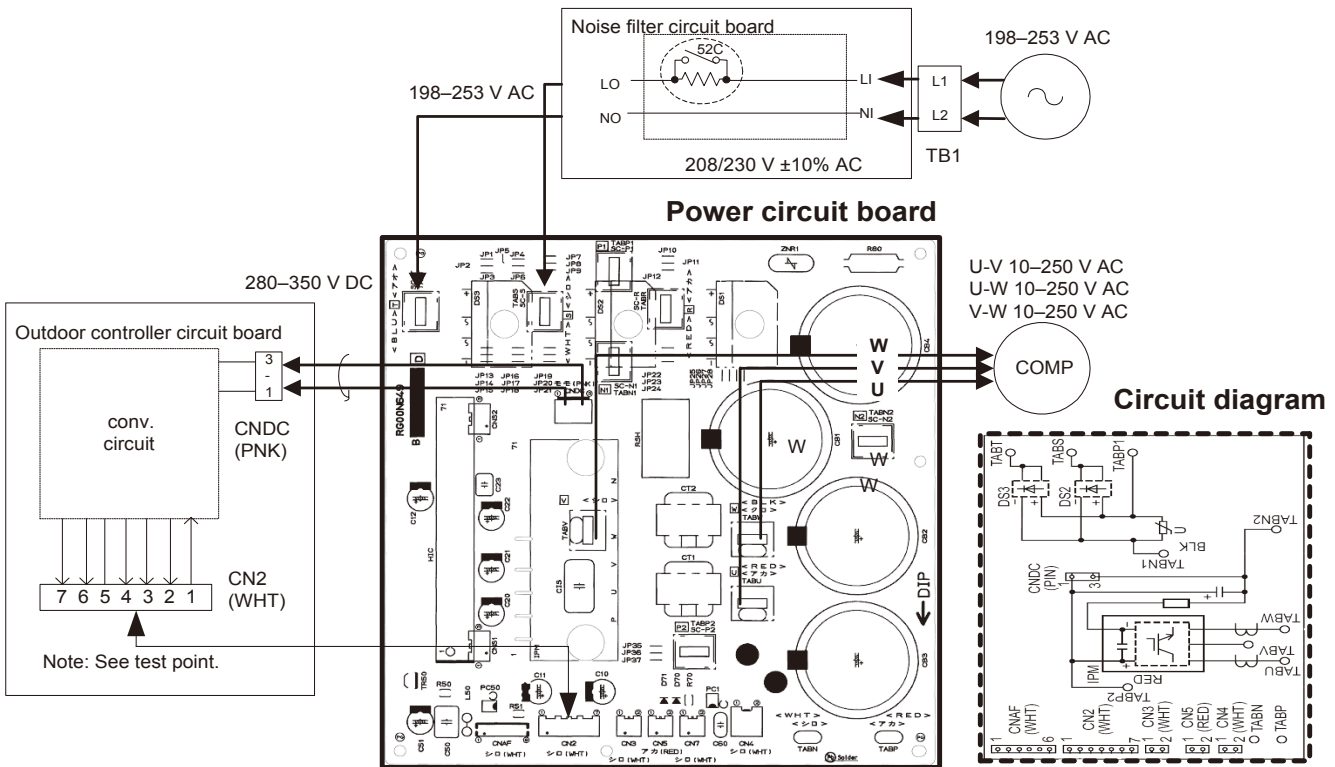
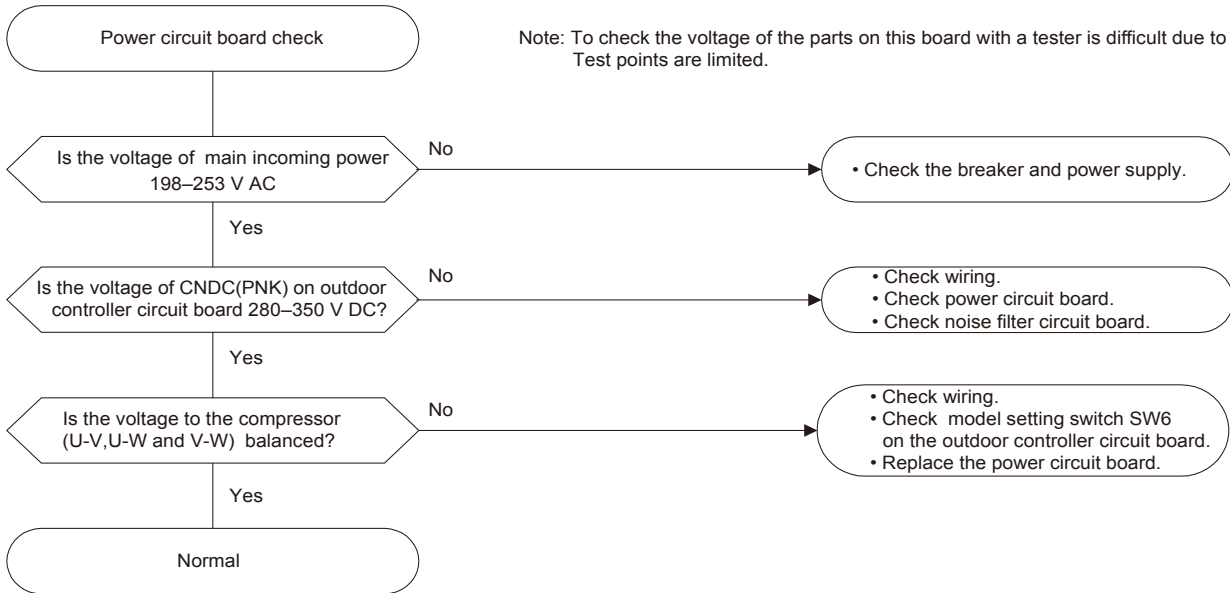

### 10-6-7. Check method of ACTM

**PUZ-A30/36/42NHA6**  
**PUY-A30/36/42NHA6**

**PUZ-A30/36/42NHA6-BS**  
**PUY-A30/36/42NHA6-BS**

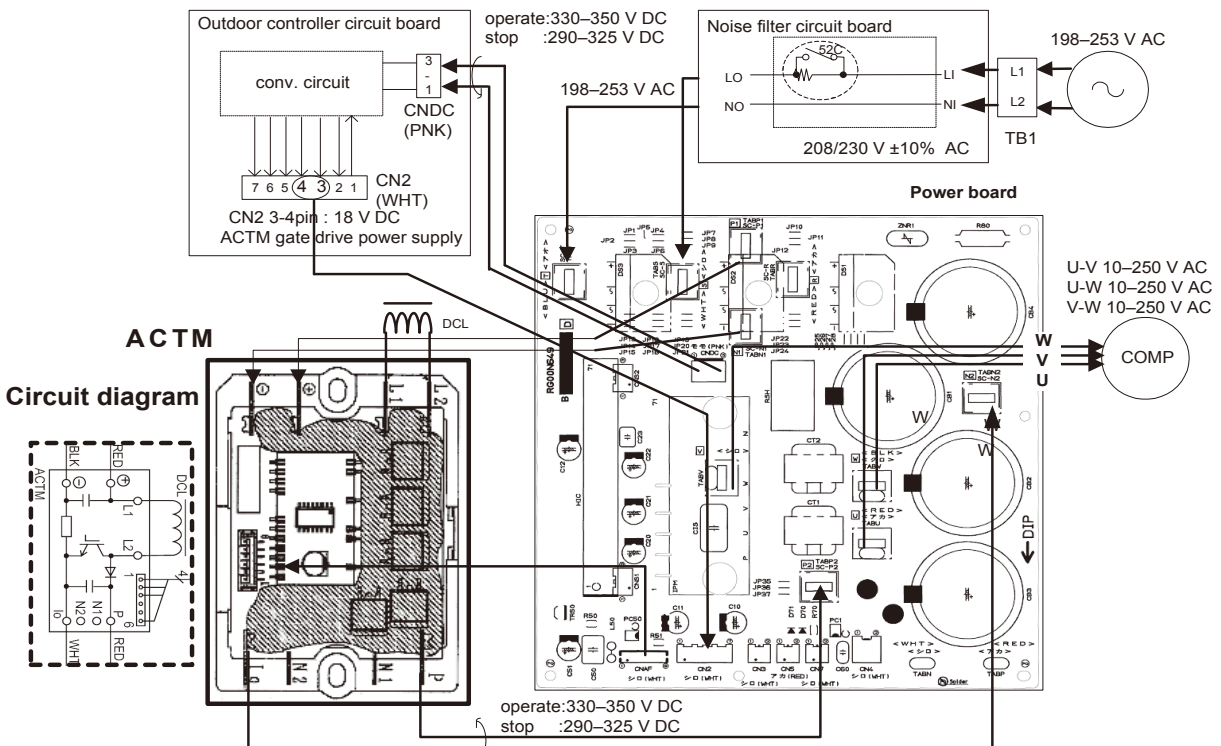
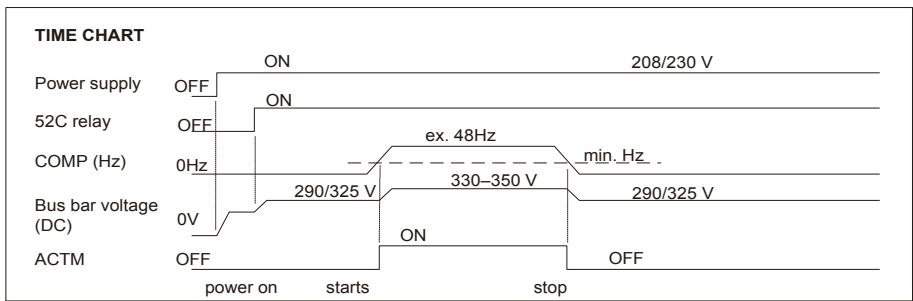
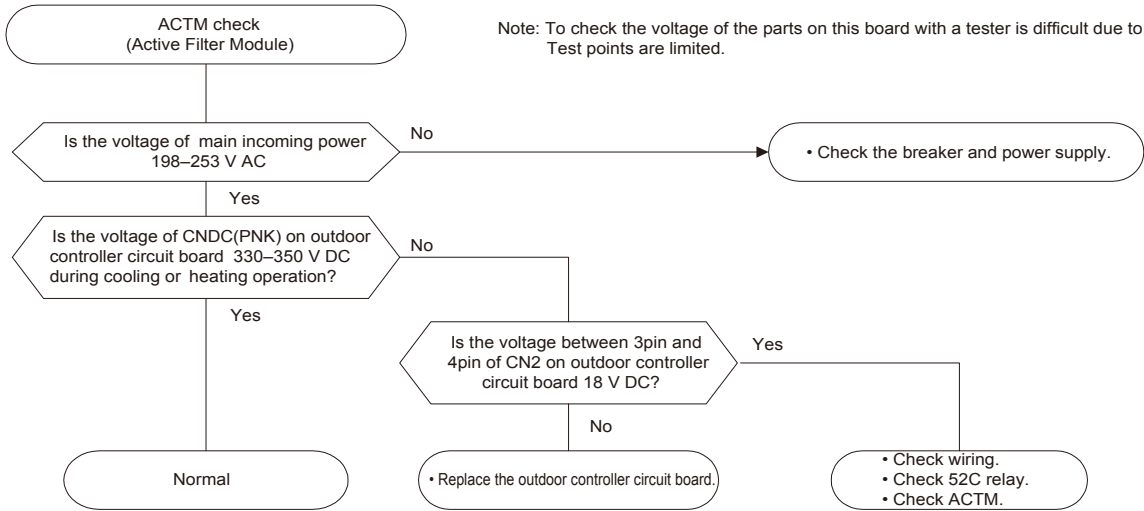

### 10-6-8. Check method of DC fan motor (fan motor/ outdoor controller circuit board)

① Notes

- High voltage is applied to the connector (CNF1, 2) for the fan motor. Pay attention to the service.
- Do not pull out the connector (CNF1, 2) for the motor with the power supply on.  
(It causes trouble of the outdoor controller circuit board and fan motor.)

② Self check

Symptom : The outdoor fan cannot rotate.

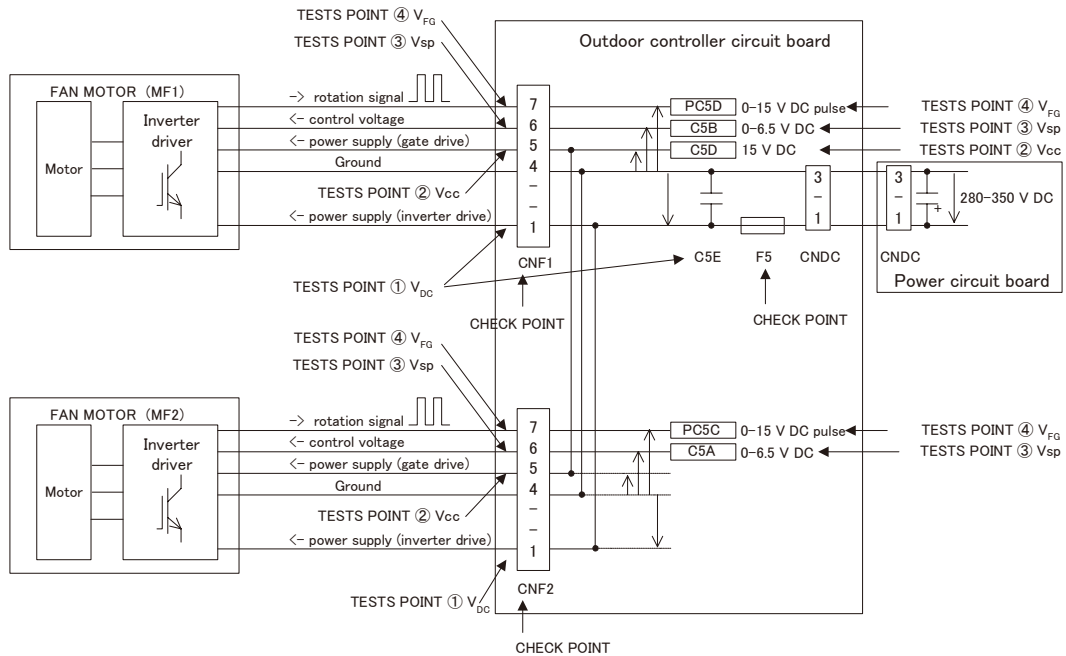
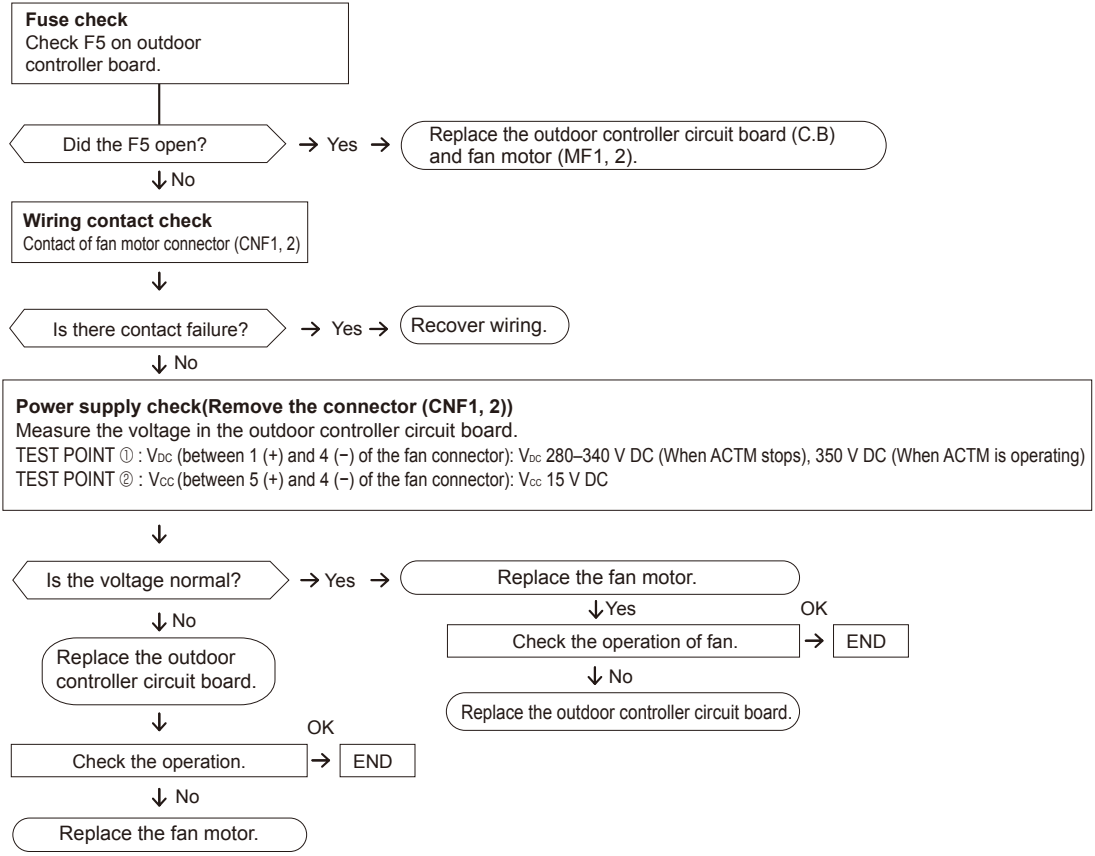

- The inverter control P.C. board is built in the fan motor of this outdoor unit.
- When F5 that is on controller board is opened, change the fan motor and outdoor controller board at the same time (F5 is impossible to change).
- For outdoor unit, there are 2 fan motors (up and down; MF1/MF2), it is possible to connect to either CNF1 or CNF2 on the board.
- It is abnormal when the abnormality is detected from either both fan motors or only one side.

## 10-7. HOW TO CHECK THE COMPONENTS

### <Thermistor feature chart>

#### Low temperature thermistors

- Thermistor <Liquid> (TH3)
- Thermistor <2-phase pipe> (TH6)
- Thermistor <Ambient> (TH7)
- Thermistor <Suction> (TH33)

Thermistor R0 = 15 kΩ ± 3%

B constant = 3480 ± 2%

$$t (^{\circ}\text{C}): R_t = 15 \exp\left\{3480 \left( \frac{1}{273+t} - \frac{1}{273} \right)\right\}$$

$$T (^{\circ}\text{F}): R_T = 15 \exp\left\{3480 \left( \frac{1}{273+(T-32)/1.8} - \frac{1}{273} \right)\right\}$$

|             |        |              |        |
|-------------|--------|--------------|--------|
| 32°F [0°C]  | 15 kΩ  | 86°F [30°C]  | 4.3 kΩ |
| 50°F [10°C] | 9.6 kΩ | 104°F [40°C] | 3.0 kΩ |
| 68°F [20°C] | 6.3 kΩ |              |        |
| 77°F [25°C] | 5.2 kΩ |              |        |

#### Medium temperature thermistor

- Thermistor <Heat sink> (TH8)

Thermistor R50 = 17 kΩ ± 2%

B constant = 4170 ± 3%

$$t (^{\circ}\text{C}): R_t = 17 \exp\left\{4170 \left( \frac{1}{273+t} - \frac{1}{323} \right)\right\}$$

$$T (^{\circ}\text{F}): R_T = 17 \exp\left\{4170 \left( \frac{1}{273+(T-32)/1.8} - \frac{1}{323} \right)\right\}$$

|              |        |
|--------------|--------|
| 32°F [0°C]   | 180 kΩ |
| 77°F [25°C]  | 50 kΩ  |
| 122°F [50°C] | 17 kΩ  |
| 158°F [70°C] | 8 kΩ   |
| 194°F [90°C] | 4 kΩ   |

#### High temperature thermistor

- Thermistor <Comp. surface> (TH32)

Thermistor R120 = 7.465 kΩ ± 2%

B constant = 4057 ± 2%

$$t (^{\circ}\text{C}): R_t = 7.465 \exp\left\{4057 \left( \frac{1}{273+t} - \frac{1}{393} \right)\right\}$$

$$T (^{\circ}\text{F}): R_T = 7.465 \exp\left\{4057 \left( \frac{1}{273+(T-32)/1.8} - \frac{1}{393} \right)\right\}$$

|              |        |               |         |
|--------------|--------|---------------|---------|
| 68°F [20°C]  | 250 kΩ | 158°F [70°C]  | 34 kΩ   |
| 86°F [30°C]  | 160 kΩ | 176°F [80°C]  | 24 kΩ   |
| 104°F [40°C] | 104 kΩ | 194°F [90°C]  | 17.5 kΩ |
| 122°F [50°C] | 70 kΩ  | 212°F [100°C] | 13.0 kΩ |
| 140°F [60°C] | 48 kΩ  | 230°F [110°C] | 9.8 kΩ  |

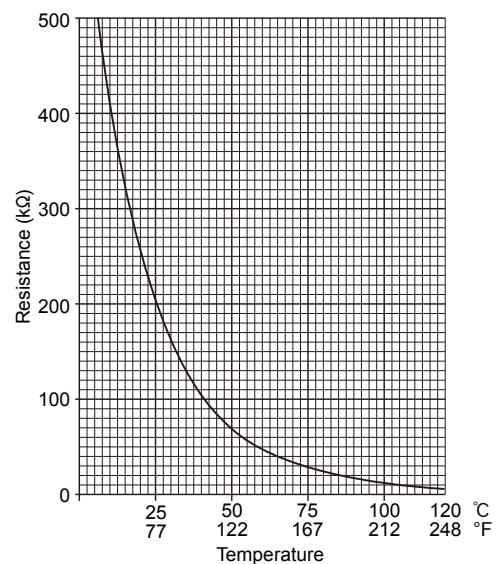
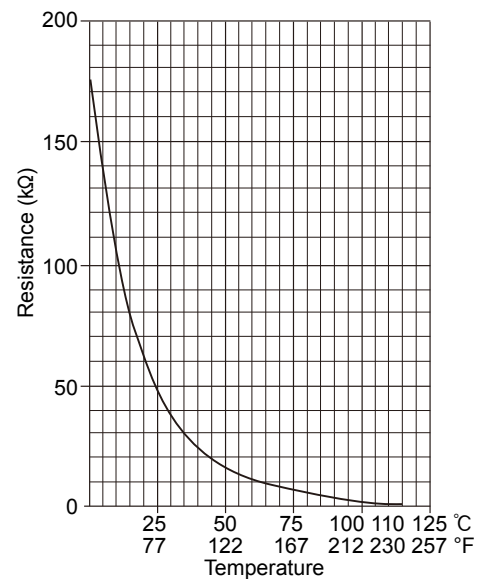
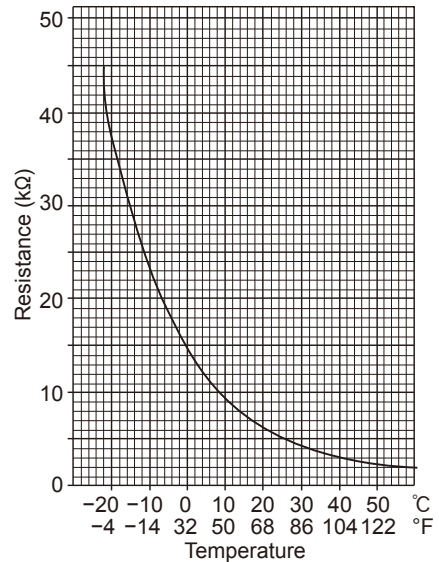

## Linear expansion valve (A12, 18)

### (1) Operation summary of the linear expansion valve

- Linear expansion valve opens/closes through stepping motor after receiving the pulse signal from the outdoor controller board.
- Valve position can be changed in proportion to the number of pulse signal.

<Connection between the outdoor controller board and the linear expansion valve>

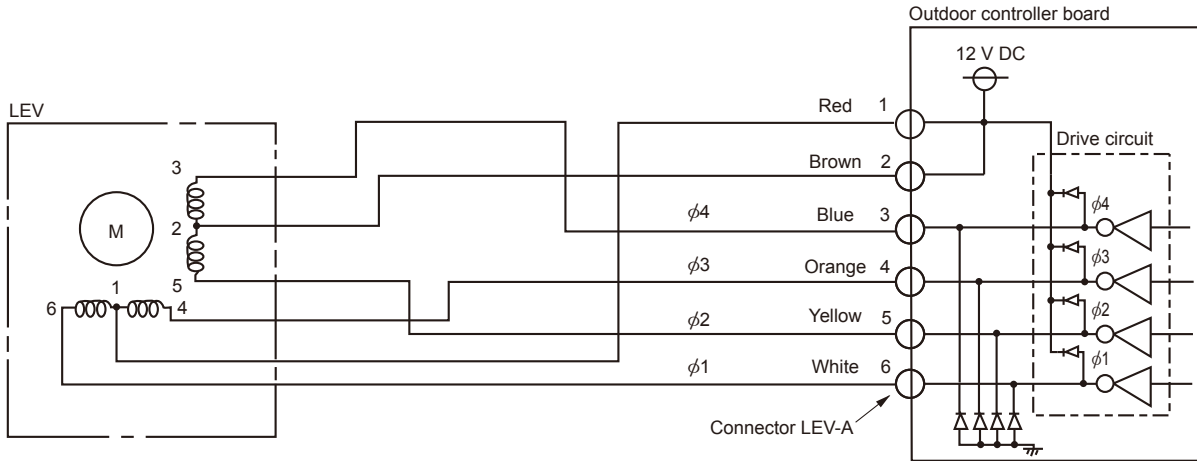

### <Output pulse signal and the valve operation>

| Output (Phase) | Output |     |     |     |     |     |     |     |
|----------------|--------|-----|-----|-----|-----|-----|-----|-----|
|                | 1      | 2   | 3   | 4   | 5   | 6   | 7   | 8   |
| $\phi 1$       | ON     | ON  | OFF | OFF | OFF | OFF | OFF | ON  |
| $\phi 2$       | OFF    | ON  | ON  | ON  | OFF | OFF | OFF | OFF |
| $\phi 3$       | OFF    | OFF | OFF | ON  | ON  | ON  | OFF | OFF |
| $\phi 4$       | OFF    | OFF | OFF | OFF | OFF | ON  | ON  | ON  |

Opening a valve : 8 → 7 → 6 → 5 → 4 → 3 → 2 → 1 → 8

Closing a valve : 1 → 2 → 3 → 4 → 5 → 6 → 7 → 8 → 1

The output pulse shifts in above order.

- When linear expansion valve operation stops, all output phases become OFF.
- When the power is turned on, 700 pulse closing valve signal will be sent till it goes to ㉓ point in order to define the valve position. (The pulse signal is being sent for about 20 seconds.)

### (2) Linear expansion valve operation

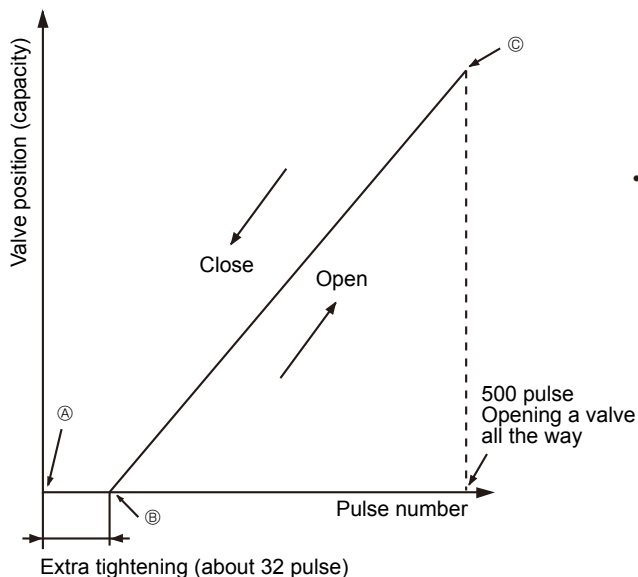

When the valve moves smoothly, there is no sound or vibration occurring from the linear expansion valve; however, when the pulse number moves from ㉓ to ㉔ or when the valve is locked, sound can be heard than normal situation. No sound is heard when the pulse number moves from ㉓ to ㉔ in case coil is burn out or motor is locked by open-phase.

- Sound can be detected by placing the ear against the screw driver handle while putting the screw driver to the linear expansion valve.

## Linear expansion valve (A24, 30, 36, 42)

### (1) Operation summary of the linear expansion valve

- Linear expansion valve opens/closes through stepping motor after receiving the pulse signal from the outdoor controller board.
- Valve position can be changed in proportion to the number of pulse signal.

<Connection between the outdoor controller board and the linear expansion valve>

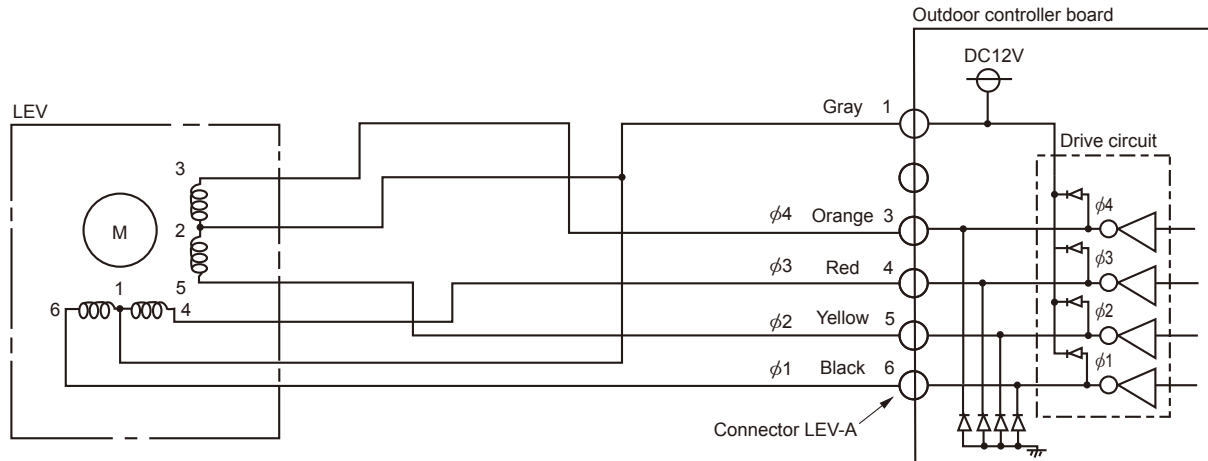

### <Output pulse signal and the valve operation>

| Output (Phase) | Output |     |     |     |     |     |     |     |
|----------------|--------|-----|-----|-----|-----|-----|-----|-----|
|                | 1      | 2   | 3   | 4   | 5   | 6   | 7   | 8   |
| φ1             | ON     | ON  | OFF | OFF | OFF | OFF | OFF | ON  |
| φ2             | OFF    | ON  | ON  | ON  | OFF | OFF | OFF | OFF |
| φ3             | OFF    | OFF | OFF | ON  | ON  | ON  | OFF | OFF |
| φ4             | OFF    | OFF | OFF | OFF | OFF | ON  | ON  | ON  |

Opening a valve : 8 → 7 → 6 → 5 → 4 → 3 → 2 → 1 → 8

Closing a valve : 1 → 2 → 3 → 4 → 5 → 6 → 7 → 8 → 1

The output pulse shifts in above order.

- When linear expansion valve operation stops, all output phases become OFF.
- When the power is turned on, 700 pulse closing valve signal will be sent till it goes to ㉓ point in order to define the valve position. (The pulse signal is being sent for about 20 seconds.)

### (2) Linear expansion valve operation

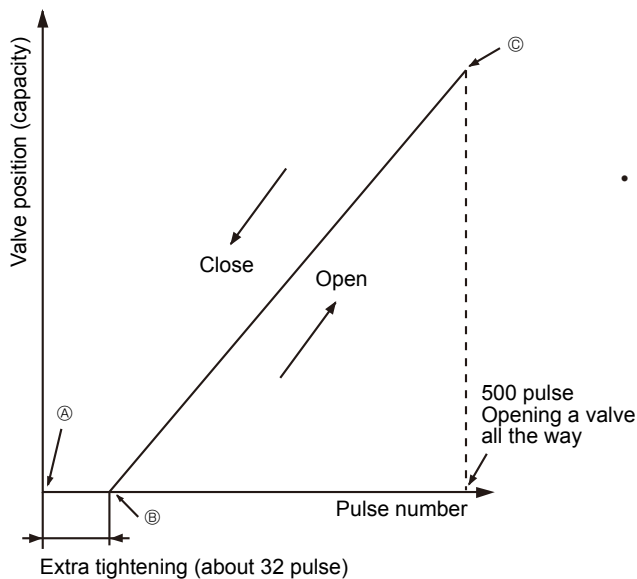

When the valve moves smoothly, there is no sound or vibration occurring from the linear expansion valve; however, when the pulse number moves from ㉔ to ㉓ or when the valve is locked, sound can be heard than normal situation. No sound is heard when the pulse number moves from ㉓ to ㉔ in case coil is burn out or motor is locked by open-phase.

- Sound can be detected by placing the ear against the screw driver handle while putting the screw driver to the linear expansion valve.

### (3) How to attach and detach the coil of linear expansion valve (A12, 18)

<Composition>

Linear expansion valve is separable into the main body and the coil as shown in the diagram below.

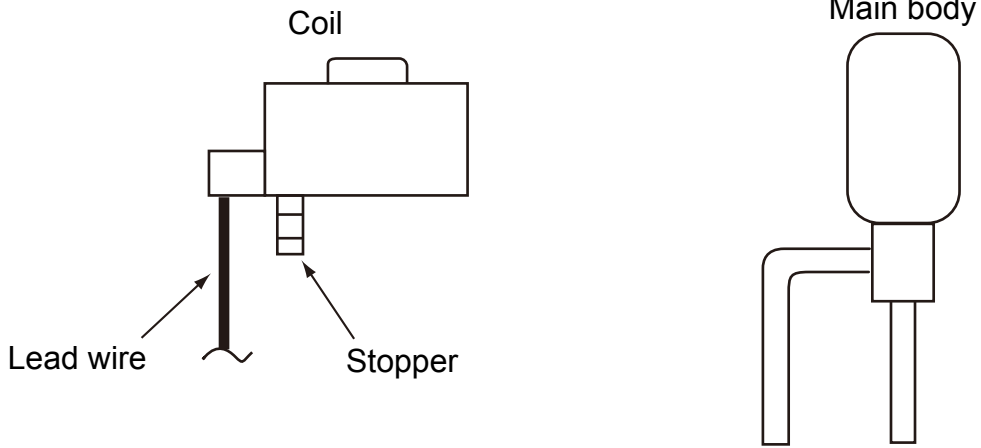

#### <How to detach the coil>

Hold the lower part of the main body (shown as A) firmly so that the main body does not move and detach the coil by pulling it upward.

Be sure to detach the coil holding main body firmly. Otherwise pipes can bend due to stress.

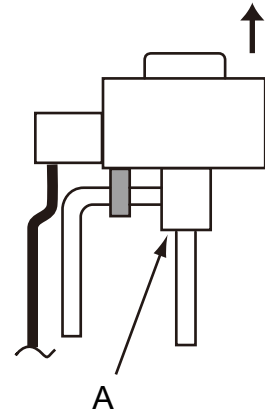

#### <How to attach the coil>

Hold the lower part of the main body (shown as A) firmly so that the main body does not move and attach the coil by inserting it downward into the main body. Then securely attach the coil stopper to pipe B. (At this time, be careful that stress is not added to lead wire and main body is not wound by lead wire.) If the stopper is not firmly attached to pipe B, coil may be detached from the main body and that can cause defective operation of linear expansion valve.

To prevent piping stress, be sure to attach the coil holding the main body of linear expansion valve firmly. Otherwise pipe may break.

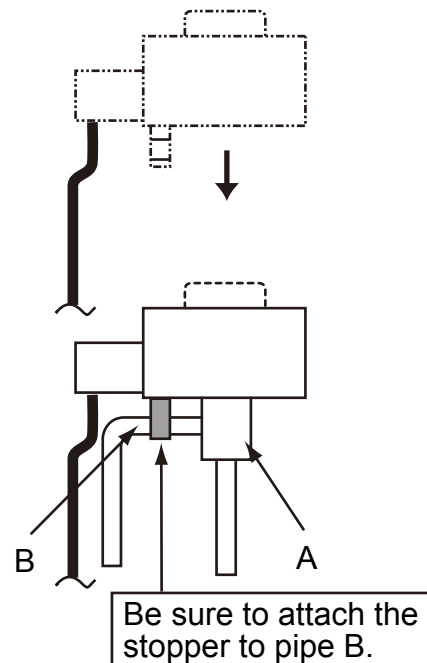

**(4) How to attach and detach the coil of linear expansion valve (A24, 30, 36, 42)**

<Composition>

Linear expansion valve is separable into the main body and the coil as shown in the diagram below.

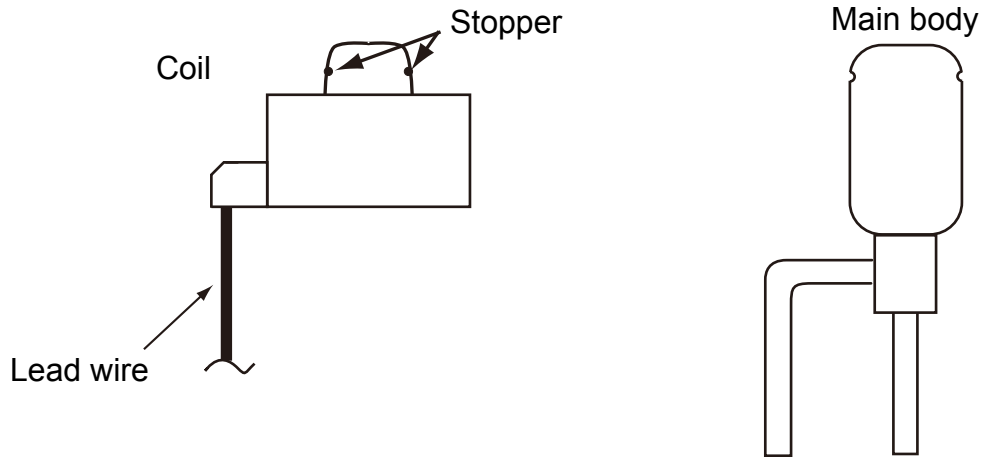

**<How to detach the coil>**

Hold the lower part of the main body (shown as A) firmly so that the main body does not move and detach the coil by pulling it upward.

Be sure to detach the coil holding main body firmly. Otherwise pipes can bend due to stress.

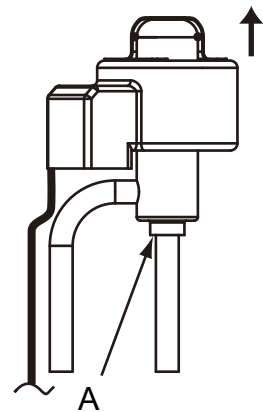

**<How to attach the coil>**

Hold the lower part of the main body (shown as A) firmly so that the main body does not move and attach the coil by inserting it downward into the main body. Then securely attach the coil stopper to main body. (At this time, be careful that stress is not added to lead wire and main body is not wound by lead wire.) If the stopper is not firmly attached to main body, coil may be detached from the main body and that can cause defective operation of linear expansion valve.

To prevent piping stress, be sure to attach the coil holding the main body of linear expansion valve firmly. Otherwise pipe may break.

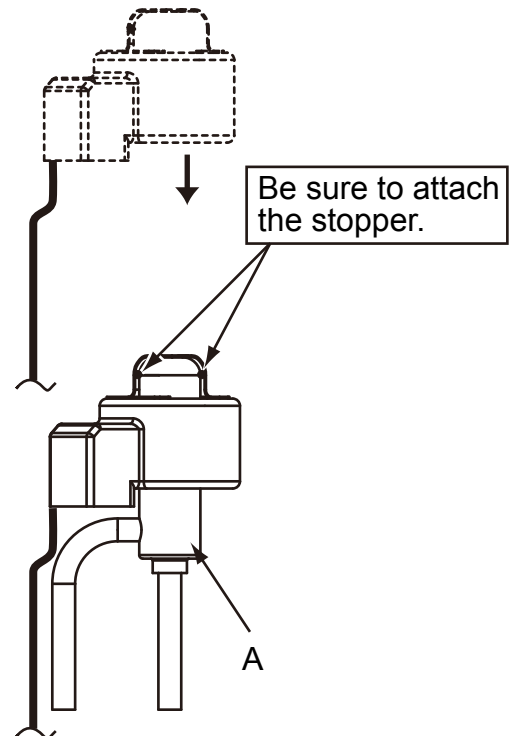

## 10-8. EMERGENCY OPERATION

- (1) When the check codes shown below are displayed on outdoor unit or microprocessor for wired remote controller or indoor unit has a failure, but no other problems are found, emergency operation will be available by setting the emergency operation switch (SWE) to ON and short-circuiting the connector (CN31) on outdoor controller board.

When following abnormalities occur, emergency operation will be available.

| Check code | Inspected content   |
|------------|---|
| U4         | Open/short of pipe thermistor (TH3/TH6)   |
| E8         | Indoor/outdoor unit communication error •Signal receiving error (Outdoor unit)                    |
| E9         | Indoor/outdoor unit communication error •Transmitting error (Indoor unit)                         |
| E0-7       | Communication error other than outdoor unit   |
| Ed         | Communication error between outdoor controller board and M-NET board (Serial communication error) |

### (2) Check the following items and cautions for emergency operation

- ① Make sure that there is no abnormality in outdoor unit other than the above abnormalities. (Emergency operation will not be available when check codes other than the above are indicated.)
- ② For emergency operation, it is necessary to set the emergency operation switch (SWE) on indoor controller board. Refer to the electrical wiring diagram of indoor unit for how to set the indoor unit.)
- ③ During emergency operation, the air-conditioner will continuously be operated by supplying power and stopping it: It cannot be turned on or off by remote control, and temperature control is not possible.
- ④ Do not perform emergency heating operation for an extended period of time: If the outdoor unit starts defrosting during this period, cold air will blow out from the indoor unit.
- ⑤ Do not perform emergency cooling operation for more than 10 hours: Neglecting this could result in freezing the heat exchanger in indoor unit.

### (3) Emergency operation procedure

- ① Turn the main power supply off.
- ② Turn on the emergency operation switch (SWE) on indoor controller board.
- ③ Set the shorting pins of emergency operation connector (CN31) on outdoor controller board to ON.
- ④ Use SW4-2 on outdoor controller board to set the operation mode (cooling or heating). (SW4-1 is not used.)

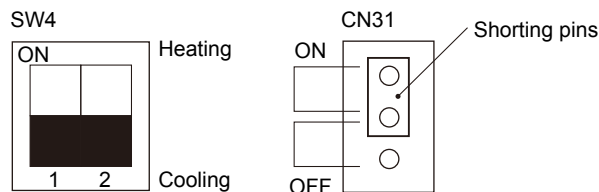

- ⑤ Turning the main power supply on will start the emergency operation.

### (4) Releasing emergency operation

- ① Turn the main power supply off.
- ② Set the emergency operation switch (SWE) on indoor controller board to OFF.
- ③ Set the shorting pins of emergency operation connector (CN31) on outdoor controller board to OFF.
- ④ Set SW4-2 on outdoor controller board as shown in the right.

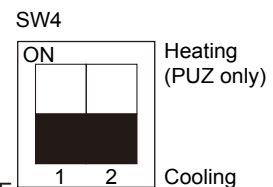

Note: If shorting pins are not set on emergency operation connector (CN31), the setting remains OFF.

### (5) Operation data during emergency operation

During emergency operation, no communication is performed with the indoor unit, so the data items needed for operation are set to the following values:

| Operation data   | Operation mode |               | Remarks |
|--|----------------|---------------|---------|
|  | COOL           | HEAT          |         |
| Intake temperature (TH1)   | 81°F [27°C]    | 69°F [20.5°C] |         |
| Indoor fluid pipe temperature (TH2)  | 41°F [5°C]     | 113°F [45°C]  |         |
| Indoor 2-phase pipe temperature (TH5)  | 41°F [5°C]     | 122°F [50°C]  |         |
| Set temperature  | 77°F [25°C]    | 72°F [22°C]   |         |
| Outdoor liquid pipe temperature (TH3)  | 113°F [45°C]   | 41°F [5°C]    | (*1)    |
| Outdoor 2-phase pipe temperature (TH6)   | 122°F [50°C]   | 41°F [5°C]    | (*1)    |
| Outdoor air temperature (TH7)  | 95°F [35°C]    | 45°F [7°C]    | (*1)    |
| Outdoor suction (TH33)   | 41°F [5°C]     | 41°F [5°C]    | (*2)    |
| Temperature difference code<br>(intake temperature–set temperature) ( $\Delta T_j$ ) | 5              | 5             |         |
| Discharge super heat (SHd)   | 54°F [30°C]    | 54°F [30°C]   | (*2)    |
| Sub-cool (SC)  | 9°F [5°C]      | 9°F [5°C]     | (*2)    |

\*1 If the thermistor temperature data is normal (not open/short), that data is loaded into the control as valid data.

When the unit enters emergency operation and TH values are mismatched, set the thermistors to open/short.

And the unit runs emergency operation with the values listed above.

\*2 If one thermistor is set to open/short, the values of SHd/SC will be different from the list above.

[Example] When liquid temperature thermistor (TH3) has an open or short circuit.

| Thermistor | COOL                                    | HEAT         |
|------------|---|--------------|
| TH3        | 113°F [45°C]                            | 41°F [5°C]   |
| TH6        | Ta                                      | Tb           |
|            | Regard normal figure as effective data. |              |
| TH4        | Tc                                      | Td           |
|            | Regard normal figure as effective data. |              |
| TH5        | 41°F [5°C]                              | 122°F [50°C] |
| TH2        | 41°F [5°C]                              | 113°F [45°C] |
| TH33       | Regard normal figure as effective data. |              |

Discharge superheat (SHd)

Cooling = TH4–TH6 = Tc–Ta

Heating = TH4–TH5 = Td–122°F [50°C]

Degree of subcooling (SC)

Cooling = TH6–TH3 = Ta–113°F [45°C]

Heating = TH5–TH2 = 50°C–45°C = 5°C

or

= 122°F–113°F = 9°F

# 10-9. TEST POINT DIAGRAM

## Outdoor controller circuit board

PUZ-A18/24/30/36/42NHA6

PUY-A12/18/24/30/36/42NHA6

PUZ-A18/24/30/36/42NHA6-BS

PUY-A12/18/24/30/36/42NHA6-BS

<CAUTION> TEST POINT ① is high voltage.

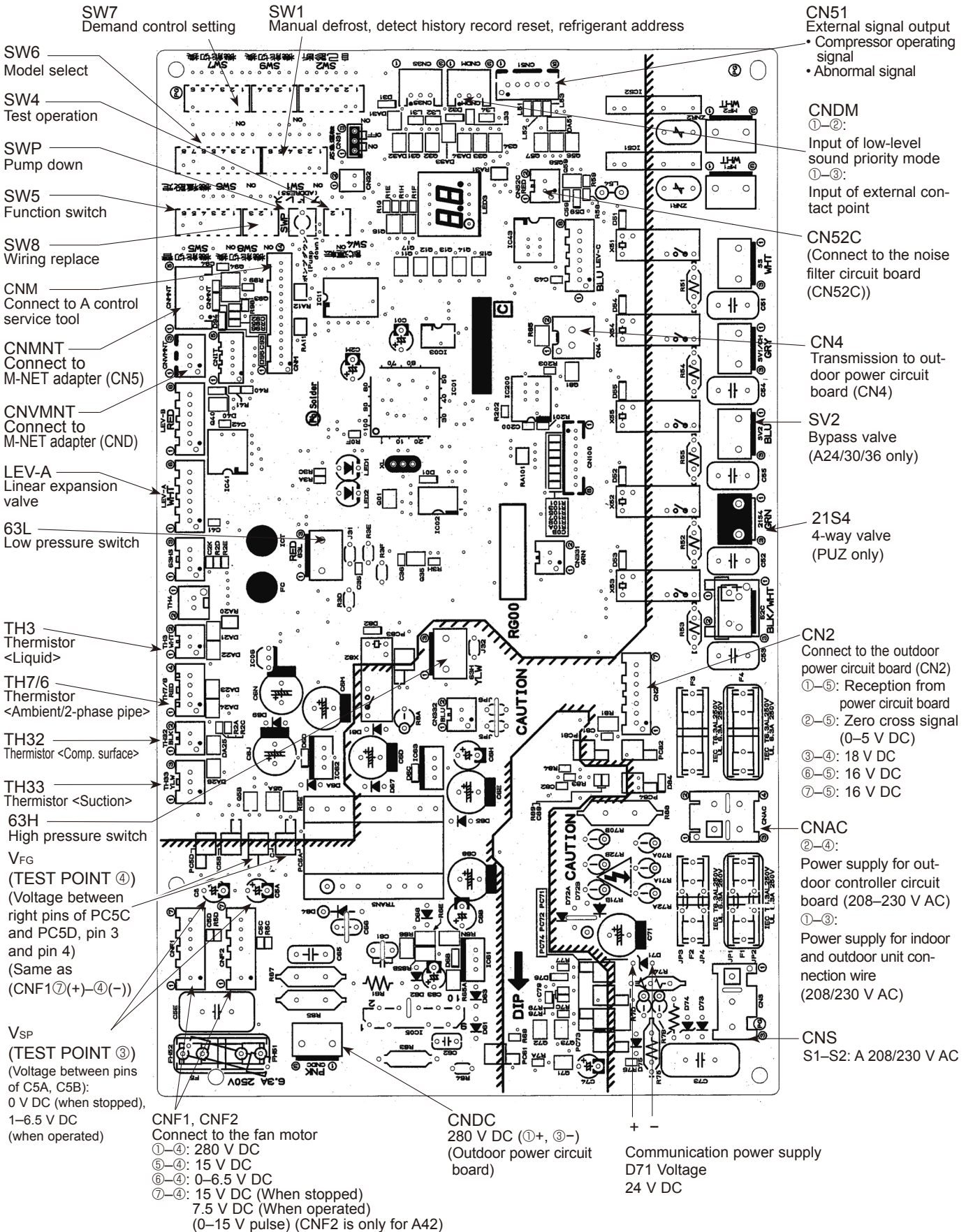

- SW7 Demand control setting
- SW1 Manual defrost, detect history record reset, refrigerant address
- SW6 Model select
- SW4 Test operation
- SWP Pump down
- SW5 Function switch
- SW8 Wiring replace
- CNM Connect to A control service tool
- CNMNT Connect to M-NET adapter (CN5)
- CNMVNT Connect to M-NET adapter (CND)
- LEV-A Linear expansion valve
- 63L Low pressure switch
- TH3 Thermistor <Liquid>
- TH7/6 Thermistor <Ambient/2-phase pipe>
- TH32 Thermistor <Comp. surface>
- TH33 Thermistor <Suction>
- 63H High pressure switch
- V<sub>FG</sub> (TEST POINT ④)  
(Voltage between right pins of PC5C and PC5D, pin 3 and pin 4)  
(Same as CNF1⑦(+)-④(-))
- V<sub>SP</sub> (TEST POINT ③)  
(Voltage between pins of C5A, C5B):  
0 V DC (when stopped),  
1-6.5 V DC (when operated)
- CNF1, CNF2 Connect to the fan motor  
①-④: 280 V DC  
⑤-④: 15 V DC  
⑥-④: 0-6.5 V DC  
⑦-④: 15 V DC (When stopped)  
7.5 V DC (When operated)  
(0-15 V pulse) (CNF2 is only for A42)

- CN51 External signal output  
• Compressor operating signal  
• Abnormal signal
- CNDM  
①-②: Input of low-level sound priority mode  
①-③: Input of external contact point
- CN52C (Connect to the noise filter circuit board (CN52C))
- CN4 Transmission to outdoor power circuit board (CN4)
- SV2 Bypass valve (A24/30/36 only)
- 21S4 4-way valve (PUZ only)
- CN2 Connect to the outdoor power circuit board (CN2)  
①-⑤: Reception from power circuit board  
②-⑤: Zero cross signal (0-5 V DC)  
③-④: 18 V DC  
⑥-⑤: 16 V DC  
⑦-⑤: 16 V DC
- CNAC  
②-④: Power supply for outdoor controller circuit board (208-230 V AC)  
①-③: Power supply for indoor and outdoor unit connection wire (208/230 V AC)
- CNS S1-S2: A 208/230 V AC
- CNDC 280 V DC (①+, ③-)  
(Outdoor power circuit board)
- Communication power supply  
D71 Voltage  
24 V DC

**Outdoor noise filter circuit board**  
**PUZ-A18NHA6      PUZ-A18NHA6-BS**  
**PUY-A12/18NHA6    PUY-A12/18NHA6-BS**

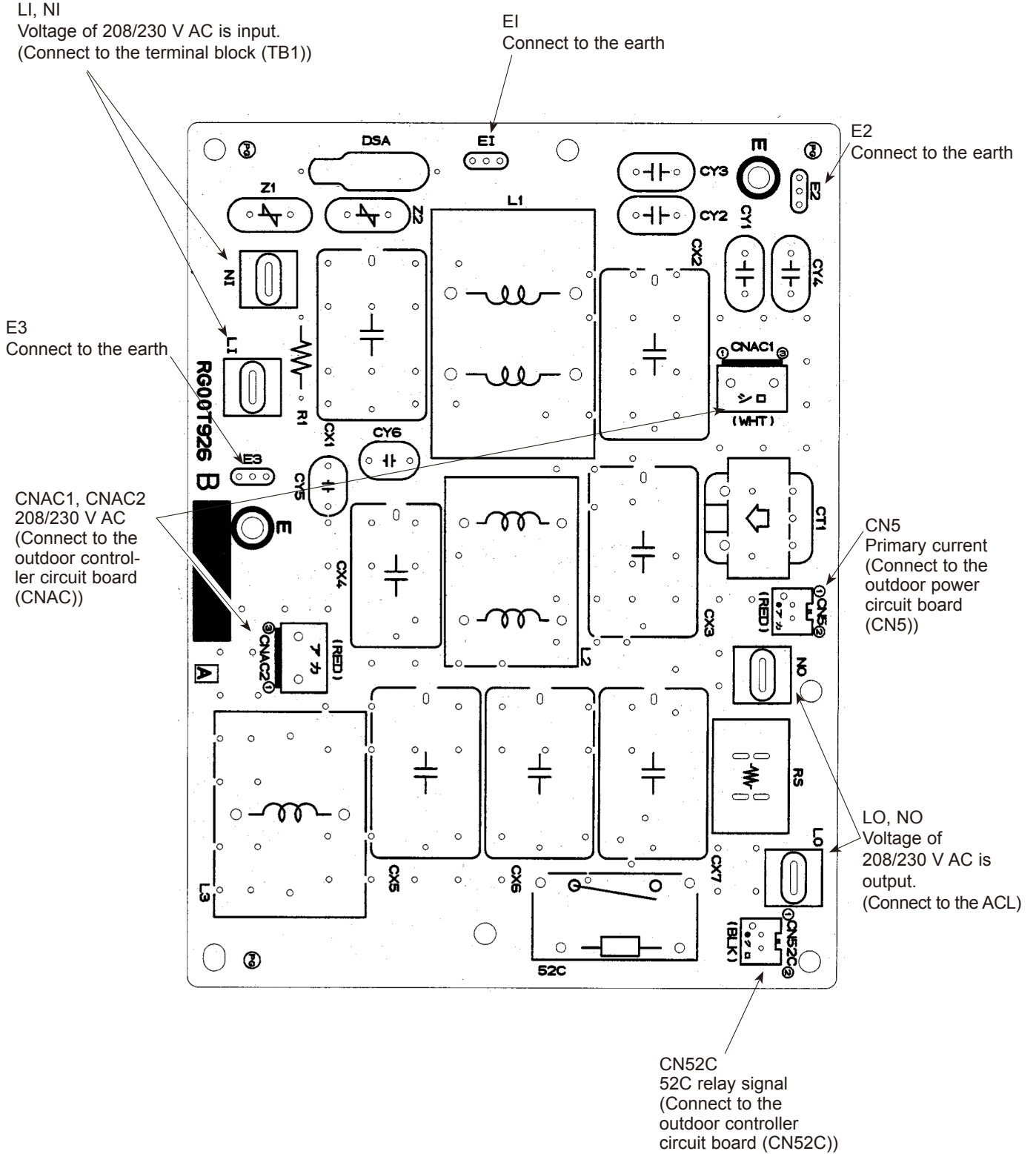

**Outdoor noise filter circuit board**  
**PUZ-A24NHA6    PUZ-A24NHA6-BS**  
**PUY-A24NHA6    PUY-A24NHA6-BS**

E1, E2  
 Connect to the earth

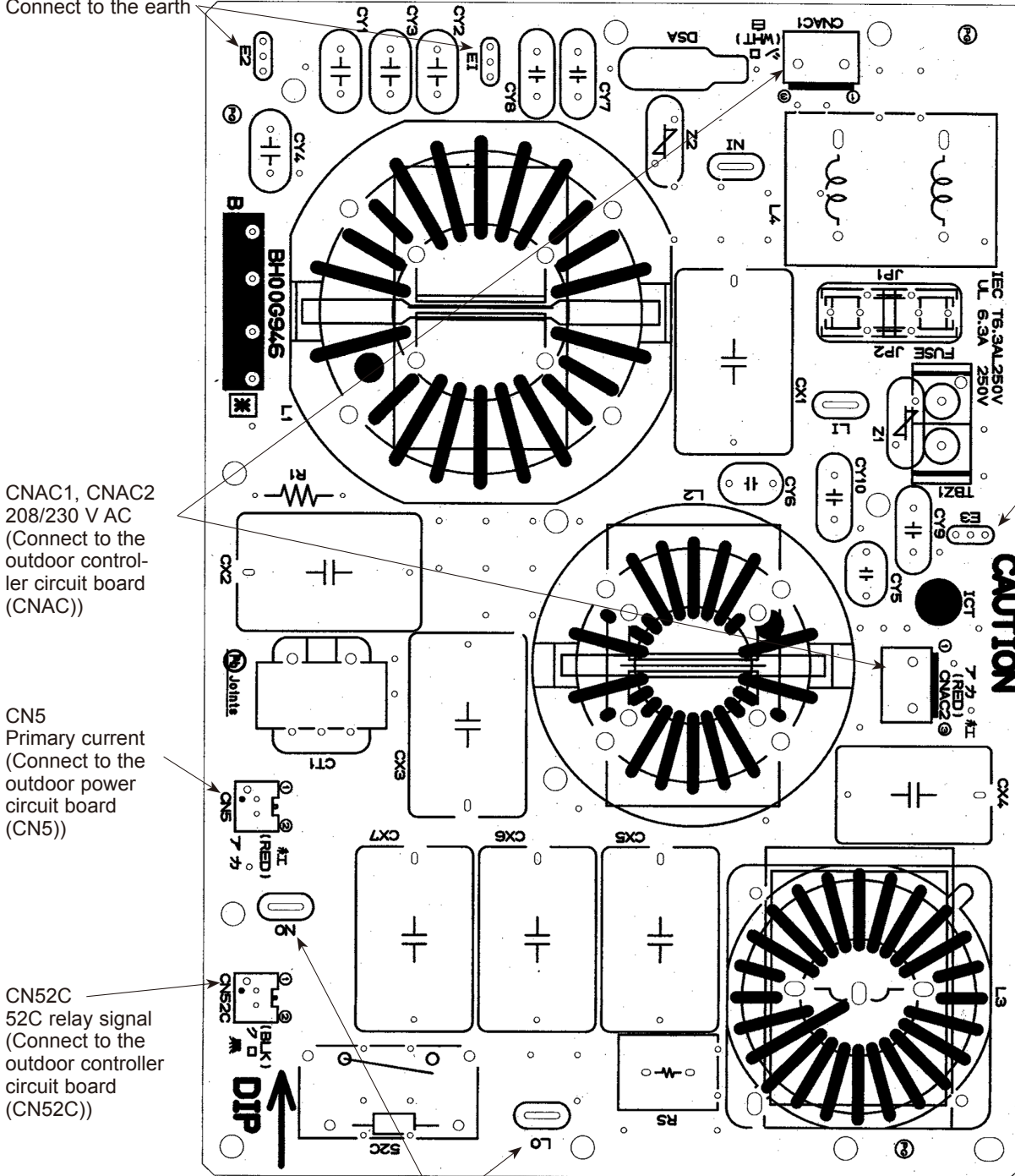

E3  
 Connect to the earth

CNAC1, CNAC2  
 208/230 V AC  
 (Connect to the outdoor controller circuit board (CNAC))

CN5  
 Primary current  
 (Connect to the outdoor power circuit board (CN5))

CN52C  
 52C relay signal  
 (Connect to the outdoor controller circuit board (CN52C))

LO, NO  
 Voltage of 208/230 V AC is output.  
 (Connect ACL)

**Outdoor noise filter circuit board**

**PUZ-A30/36/42NHA6**

**PUZ-A30/36/42NHA6-BS**

**PUY-A30/36/42NHA6**

**PUY-A30/36/42NHA6-BS**

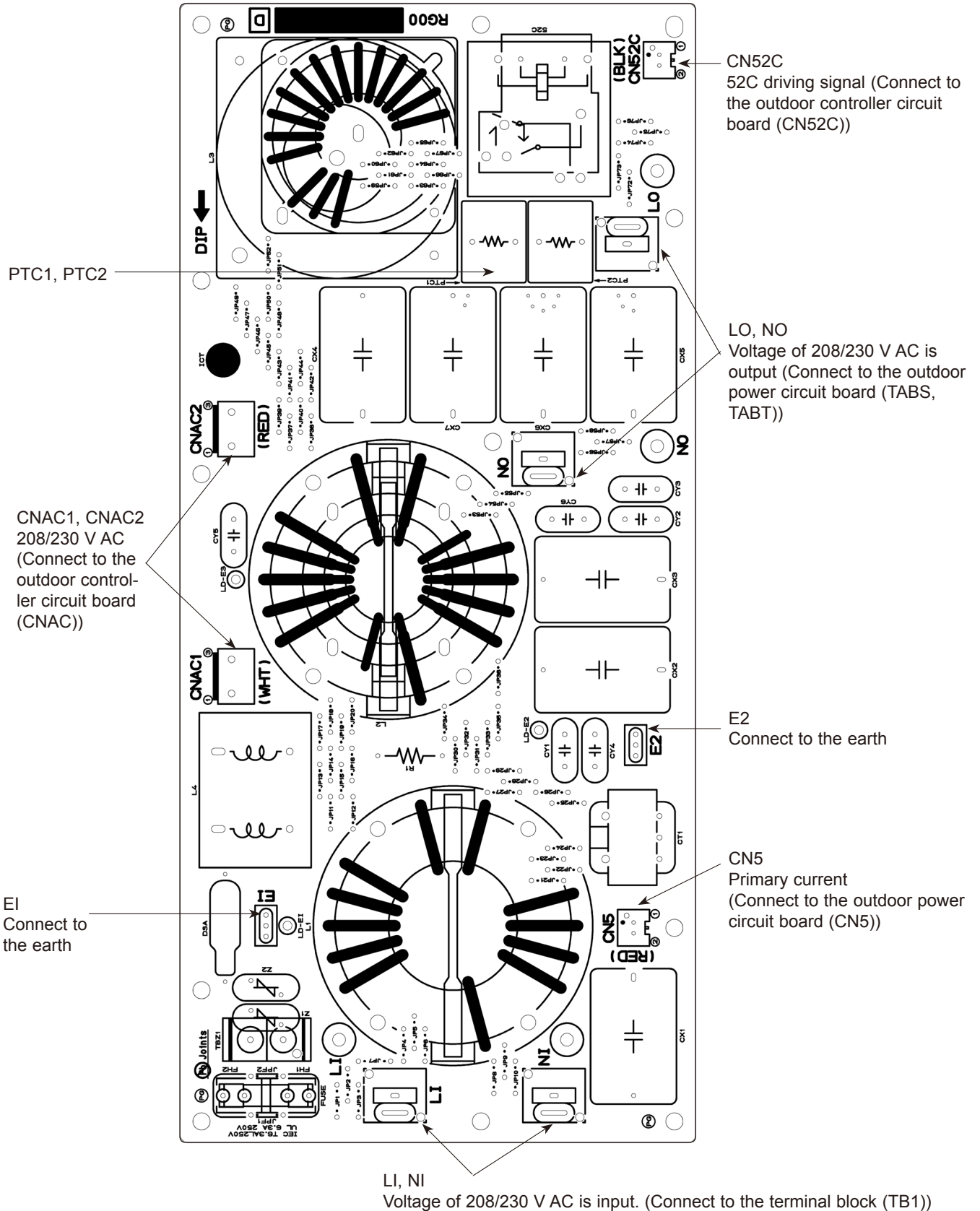



**Outdoor power circuit board**  
**PUZ-A30/36/42NHA6**  
**PUZ-A30/36/42NHA6-BS**  
**PUY-A30/36/42NHA6**  
**PUY-A30/36/42NHA6-BS**

**Brief check of POWER MODULE**

Usually, they are in a state of being short-circuited if they are broken. Measure the resistance in the following points (connectors, etc.). If they are short-circuited, it means that they are broken.

1. Check of diode bridge  
 TABP1-TABS, TABN1-TABS, TABP1-TABT, TABN1-TABT
2. Check of DIP-IPM  
 P-U, P-V, P-W, N-U, N-V, N-W

- CN2  
 Connect to the outdoor controller circuit board (CN2)  
 ①-⑤: Transmitting signal to the outdoor controller circuit board (0-5 V DC)  
 ②-⑤: Zero cross signal (0-5 V DC)  
 ③-④: 18 V DC  
 ⑥-⑤: 16 V DC  
 ⑦-⑤: 16 V DC

- CNDC  
 280-380 V DC (①+, ③-)  
 Connect to the outdoor controller circuit board

CNAF  
 Connect to ACTM

CN3  
 Thermistor (TH8)  
 <Heat sink>

CN5  
 Detection of primary current  
 Connect to the outdoor noise filter circuit board (CN5)

CN4  
 Connect to the outdoor controller circuit board (CN4)

TABP2/SC-P2  
 Connect to ACTM

TABN  
 Connect to the smoothing capacitor  
 CB⊖  
 (A42N only)

TABP  
 Connect to the smoothing capacitor  
 CB⊕  
 (A42N only)

TABU/V/W  
 Connect to the compressor (MC)  
 Voltage among phases: 10-180 V AC

TABN2  
 Connect to ACTM

TABS/TABT  
 Connect to the outdoor noise filter circuit board  
 Voltage among phases: 208/230 V AC

TABP1  
 Connect to 52C

TABN1  
 Connect to ACTM

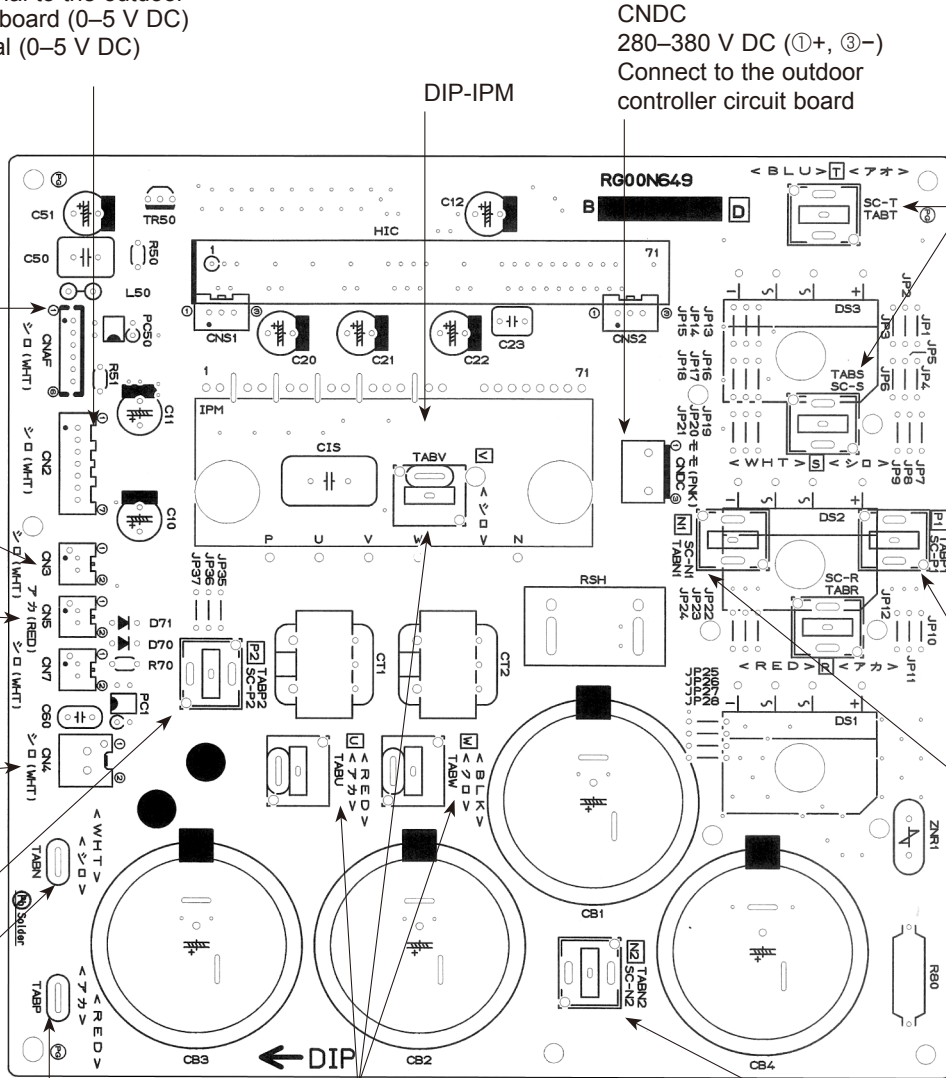

**Active filter module**  
**PUZ-A30/36/42NHA6**  
**PUY-A30/36/42NHA6**

**PUZ-A30/36/42NHA6-BS**  
**PUY-A30/36/42NHA6-BS**

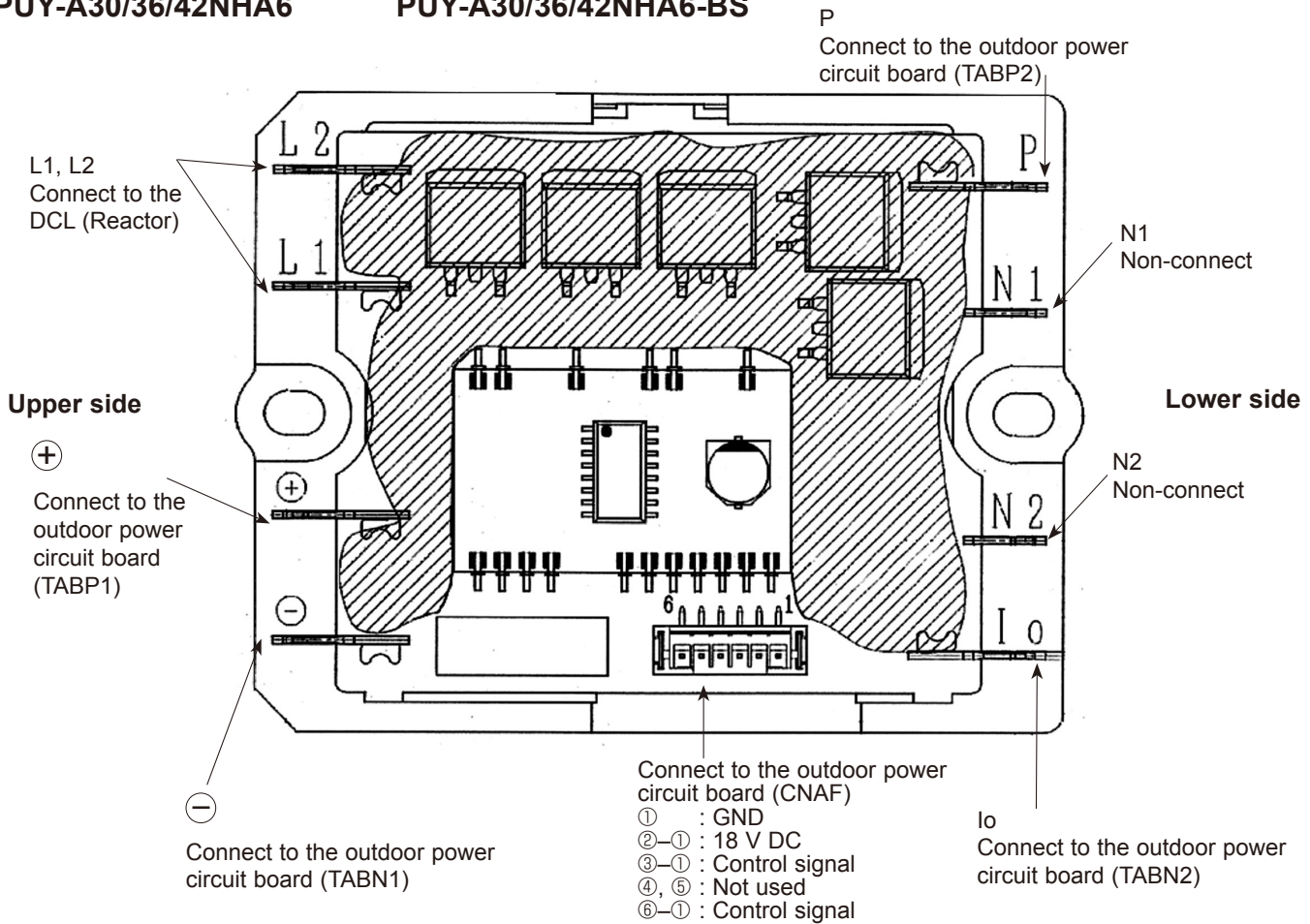

**Connection and internal circuit diagram**

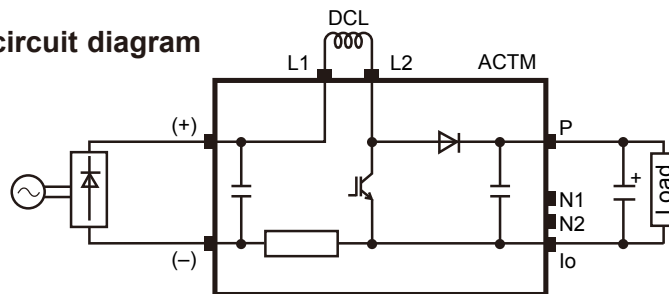

**Tester check points of Active filter module**

|            | Error condition | Normal value (reference) | Symptom when the unit is in trouble   |
|------------|-----------------|--------------------------|---|
| (-) and I0 | open            | less than 1Ω             | ① The unit does not operate (cannot be switched ON)                         |
| (-) and L2 | short           | 100 kΩ to 1 MΩ           | ① The breaker operates  |
|            | open            | *1                       | ① The unit does not operate (cannot be switched ON) ② U9 Abnormal stop (*2) |
| P and L2   | short           | 100 kΩ to 1 MΩ           | ① The breaker operates  |
|            | open            | *1                       | ① The unit does not operate (cannot be switched ON) ② U9 Abnormal stop (*2) |
| P and I0   | short           | 100 kΩ to 1 MΩ           | ① The breaker operates  |
|            | open            | *1                       | ① The unit does not operate (cannot be switched ON) ② U9 Abnormal stop (*2) |
| L2 and I0  | short           | 100 kΩ to 1 MΩ           | ① The breaker operates  |
|            | open            | *1                       | ① The unit does not operate (cannot be switched ON) ② U9 Abnormal stop (*2) |

\*1 The symptom when the unit is in open error condition is described to determine open error by tester check.





\*2 SW2 setting  ON : Code "20" display

1 6

## 10-10. FUNCTION OF SWITCHES, CONNECTORS AND JUMPERS

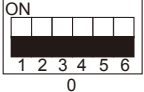
### (1) Function of switches

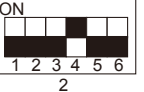
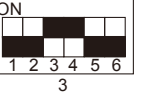
The black square (■) indicates a switch position.

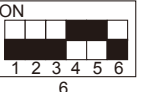
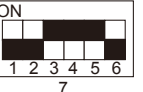
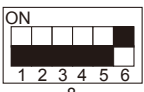
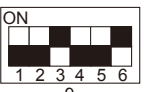
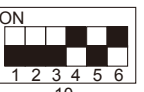
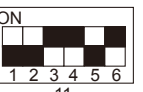
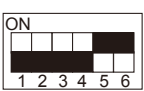
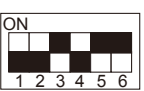
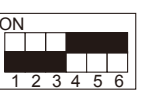
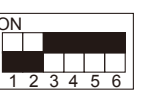
| Type of switch | Switch No.  | Function              | Action by the switch operation              |   | Effective timing  |  |   |                      |
|----------------|-------------|-----------------------|---|---|---|--|---|----------------------|
|                |             |                       | ON  | OFF   |   |  |   |                      |
| DIP switch     | SW1         | 1                     | Manual defrost *1                           | Start   | Normal  | When compressor is operating in heating operation. *1                              |   |                      |
|                |             | 2                     | Abnormal history clear                      | Clear   | Normal  | Off or operating   |   |                      |
|                |             | 3                     | Refrigerant address setting                 |  |  |  |  | When power supply ON |
|                |             |                       |   |  |  |  |  |                      |
|                |             |                       |   |  |  |  |  |                      |
|                |             |                       |   |  |  |  |  |                      |
|                | 4           | Test run              | Operating                                   | OFF   | Under suspension  |  |   |                      |
|                | 2           | Test run mode setting | Heating                                     | Cooling   |   |  |   |                      |
|                | SW8         | 1                     | No function                                 | —   | —   | —  |   |                      |
|                |             | 2                     | No function                                 | —   | —   | —  |   |                      |
|                |             | 3                     | Separate indoor/outdoor unit power supplies | Used  | Not used  | When power supply ON   |   |                      |
|                | Push switch | SWP                   | Pump down                                   | Start   | Normal  | Under suspension   |   |                      |

\*1 Manual defrost should be done as follows.

① Change the DIP SW1-1 on the outdoor controller board from OFF to ON.

② Manual defrost will start by the above operation 1 if all these conditions written below are satisfied.

· Heat mode setting

· 10 minutes have passed since compressor started operating or previous manual defrost is finished.

· Pipe temperature is less than or equal to 46°F [8°C].

Manual defrost will finish if certain conditions are satisfied.

Manual defrost can be done if above conditions are satisfied when DIP SW1-1 is changed from OFF to ON.

After DIP SW1-1 is changed from OFF to ON, there is no problem if DIP SW1-1 is left ON or changed to OFF again. This depends on the service conditions.

Continue to the next page



| Type of Switch    | Switch           | No.                      | Function                            | Action by the switch operation   |  | Effective timing     |       |             |  |             |       |                     |             |             |     |     |             |     |        |             |  |  |             |  |  |             |  |  |             |  |  |             |  |  |             |  |  |             |  |  |             |  |  |  |  |  |             |  |  |
|-------------------|------------------|--------------------------|-------------------------------------|--|--|----------------------|-------|-------------|--|-------------|-------|---------------------|-------------|-------------|-----|-----|-------------|-----|--------|-------------|--|--|-------------|--|--|-------------|--|--|-------------|--|--|-------------|--|--|-------------|--|--|-------------|--|--|-------------|--|--|--|--|--|-------------|--|--|
|                   |                  |                          |                                     | ON   | OFF  |                      |       |             |  |             |       |                     |             |             |     |     |             |     |        |             |  |  |             |  |  |             |  |  |             |  |  |             |  |  |             |  |  |             |  |  |             |  |  |  |  |  |             |  |  |
| <b>DIP switch</b> | <b>SW5</b>       | 1                        | No function                         | —  | —  | —                    |       |             |  |             |       |                     |             |             |     |     |             |     |        |             |  |  |             |  |  |             |  |  |             |  |  |             |  |  |             |  |  |             |  |  |             |  |  |  |  |  |             |  |  |
|                   |                  | 2                        | Power failure automatic recovery *2 | Auto recovery  | No auto recovery                             | When power supply ON |       |             |  |             |       |                     |             |             |     |     |             |     |        |             |  |  |             |  |  |             |  |  |             |  |  |             |  |  |             |  |  |             |  |  |             |  |  |  |  |  |             |  |  |
|                   |                  | 3,4,5                    | No function                         | —  | —  | —                    |       |             |  |             |       |                     |             |             |     |     |             |     |        |             |  |  |             |  |  |             |  |  |             |  |  |             |  |  |             |  |  |             |  |  |             |  |  |  |  |  |             |  |  |
|                   |                  | 6                        | Model select                        | Following SW5-6 reference  |  |                      |       |             |  |             |       |                     |             |             |     |     |             |     |        |             |  |  |             |  |  |             |  |  |             |  |  |             |  |  |             |  |  |             |  |  |             |  |  |  |  |  |             |  |  |
|                   | <b>SW7</b><br>*4 | 1                        | Setting of demand control *3        | <table border="1" style="width: 100%; text-align: center;"> <tr> <td>SW7-1</td> <td>SW7-2</td> <td>Max. compressor frequency (Demand switch ON)</td> </tr> <tr> <td>OFF</td> <td>OFF</td> <td>0% (Operation stop)</td> </tr> <tr> <td>ON</td> <td>OFF</td> <td>50%</td> </tr> <tr> <td>OFF</td> <td>ON</td> <td>75%</td> </tr> </table>  |  |                      | SW7-1 | SW7-2       | Max. compressor frequency (Demand switch ON) | OFF         | OFF   | 0% (Operation stop) | ON          | OFF         | 50% | OFF | ON          | 75% | Always |             |  |  |             |  |  |             |  |  |             |  |  |             |  |  |             |  |  |             |  |  |             |  |  |  |  |  |             |  |  |
|                   |                  | SW7-1                    |                                     | SW7-2  | Max. compressor frequency (Demand switch ON) |                      |       |             |  |             |       |                     |             |             |     |     |             |     |        |             |  |  |             |  |  |             |  |  |             |  |  |             |  |  |             |  |  |             |  |  |             |  |  |  |  |  |             |  |  |
|                   |                  | OFF                      | OFF                                 | 0% (Operation stop)  |  |                      |       |             |  |             |       |                     |             |             |     |     |             |     |        |             |  |  |             |  |  |             |  |  |             |  |  |             |  |  |             |  |  |             |  |  |             |  |  |  |  |  |             |  |  |
|                   |                  | ON                       | OFF                                 | 50%  |  |                      |       |             |  |             |       |                     |             |             |     |     |             |     |        |             |  |  |             |  |  |             |  |  |             |  |  |             |  |  |             |  |  |             |  |  |             |  |  |  |  |  |             |  |  |
|                   |                  | OFF                      | ON                                  | 75%  |  |                      |       |             |  |             |       |                     |             |             |     |     |             |     |        |             |  |  |             |  |  |             |  |  |             |  |  |             |  |  |             |  |  |             |  |  |             |  |  |  |  |  |             |  |  |
|                   |                  | 2                        |                                     |  |  |                      |       |             |  |             |       |                     |             |             |     |     |             |     |        |             |  |  |             |  |  |             |  |  |             |  |  |             |  |  |             |  |  |             |  |  |             |  |  |  |  |  |             |  |  |
|                   | 3                | Max. Hz setting(cooling) | Max. Hz(cooling) × 0.8              | Normal   | Always                                       |                      |       |             |  |             |       |                     |             |             |     |     |             |     |        |             |  |  |             |  |  |             |  |  |             |  |  |             |  |  |             |  |  |             |  |  |             |  |  |  |  |  |             |  |  |
|                   | 4                | Max. Hz setting(heating) | Max. Hz(heating) × 0.8              | Normal   | Always                                       |                      |       |             |  |             |       |                     |             |             |     |     |             |     |        |             |  |  |             |  |  |             |  |  |             |  |  |             |  |  |             |  |  |             |  |  |             |  |  |  |  |  |             |  |  |
|                   | 5                | No function              | —                                   | —  | —  |                      |       |             |  |             |       |                     |             |             |     |     |             |     |        |             |  |  |             |  |  |             |  |  |             |  |  |             |  |  |             |  |  |             |  |  |             |  |  |  |  |  |             |  |  |
|                   | 6                | Defrost setting          | For high humidity                   | Normal   | Always                                       |                      |       |             |  |             |       |                     |             |             |     |     |             |     |        |             |  |  |             |  |  |             |  |  |             |  |  |             |  |  |             |  |  |             |  |  |             |  |  |  |  |  |             |  |  |
|                   | <b>SW9</b>       | 1                        | No function                         | —  | —  | —                    |       |             |  |             |       |                     |             |             |     |     |             |     |        |             |  |  |             |  |  |             |  |  |             |  |  |             |  |  |             |  |  |             |  |  |             |  |  |  |  |  |             |  |  |
|                   |                  | 2                        | Function switch                     | Valid  | Normal                                       | Always               |       |             |  |             |       |                     |             |             |     |     |             |     |        |             |  |  |             |  |  |             |  |  |             |  |  |             |  |  |             |  |  |             |  |  |             |  |  |  |  |  |             |  |  |
|                   |                  | 3,4                      | No function                         | —  | —  | —                    |       |             |  |             |       |                     |             |             |     |     |             |     |        |             |  |  |             |  |  |             |  |  |             |  |  |             |  |  |             |  |  |             |  |  |             |  |  |  |  |  |             |  |  |
|                   | <b>SW6</b>       | 1                        | Model select                        | <table border="1" style="width: 100%; text-align: center;"> <tr> <td>MODEL</td> <td>SW6</td> <td>SW5-5, 6 *5</td> <td>MODEL</td> <td>SW6</td> <td>SW5-5, 6 *5</td> </tr> <tr> <td>PUZ-A18NHAG</td> <td></td> <td></td> <td>PUZ-A30NHAG</td> <td></td> <td></td> </tr> <tr> <td>PUY-A12NHAG</td> <td></td> <td></td> <td>PUZ-A36NHAG</td> <td></td> <td></td> </tr> <tr> <td>PUY-A18NHAG</td> <td></td> <td></td> <td>PUY-A30NHAG</td> <td></td> <td></td> </tr> <tr> <td>PUZ-A24NHAG</td> <td></td> <td></td> <td>PUY-A36NHAG</td> <td></td> <td></td> </tr> <tr> <td>PUY-A24NHAG</td> <td></td> <td></td> <td>PUZ-A42NHAG</td> <td></td> <td></td> </tr> <tr> <td></td> <td></td> <td></td> <td>PUY-A42NHAG</td> <td></td> <td></td> </tr> </table> |  |                      |       | MODEL       | SW6  | SW5-5, 6 *5 | MODEL | SW6                 | SW5-5, 6 *5 | PUZ-A18NHAG |     |     | PUZ-A30NHAG |     |        | PUY-A12NHAG |  |  | PUZ-A36NHAG |  |  | PUY-A18NHAG |  |  | PUY-A30NHAG |  |  | PUZ-A24NHAG |  |  | PUY-A36NHAG |  |  | PUY-A24NHAG |  |  | PUZ-A42NHAG |  |  |  |  |  | PUY-A42NHAG |  |  |
|                   |                  | MODEL                    |                                     | SW6  | SW5-5, 6 *5                                  | MODEL                | SW6   | SW5-5, 6 *5 |  |             |       |                     |             |             |     |     |             |     |        |             |  |  |             |  |  |             |  |  |             |  |  |             |  |  |             |  |  |             |  |  |             |  |  |  |  |  |             |  |  |
|                   |                  | PUZ-A18NHAG              |                                     |  |  | PUZ-A30NHAG          |       |             |  |             |       |                     |             |             |     |     |             |     |        |             |  |  |             |  |  |             |  |  |             |  |  |             |  |  |             |  |  |             |  |  |             |  |  |  |  |  |             |  |  |
|                   |                  | PUY-A12NHAG              |                                     |  |  | PUZ-A36NHAG          |       |             |  |             |       |                     |             |             |     |     |             |     |        |             |  |  |             |  |  |             |  |  |             |  |  |             |  |  |             |  |  |             |  |  |             |  |  |  |  |  |             |  |  |
|                   |                  | PUY-A18NHAG              |                                     |  |  | PUY-A30NHAG          |       |             |  |             |       |                     |             |             |     |     |             |     |        |             |  |  |             |  |  |             |  |  |             |  |  |             |  |  |             |  |  |             |  |  |             |  |  |  |  |  |             |  |  |
|                   |                  | PUZ-A24NHAG              |                                     |  |  | PUY-A36NHAG          |       |             |  |             |       |                     |             |             |     |     |             |     |        |             |  |  |             |  |  |             |  |  |             |  |  |             |  |  |             |  |  |             |  |  |             |  |  |  |  |  |             |  |  |
|                   |                  | PUY-A24NHAG              |                                     |  |  | PUZ-A42NHAG          |       |             |  |             |       |                     |             |             |     |     |             |     |        |             |  |  |             |  |  |             |  |  |             |  |  |             |  |  |             |  |  |             |  |  |             |  |  |  |  |  |             |  |  |
|                   |                  |                          |                                     |  | PUY-A42NHAG                                  |                      |       |             |  |             |       |                     |             |             |     |     |             |     |        |             |  |  |             |  |  |             |  |  |             |  |  |             |  |  |             |  |  |             |  |  |             |  |  |  |  |  |             |  |  |
| 2                 |                  |                          |                                     |  |  |                      |       |             |  |             |       |                     |             |             |     |     |             |     |        |             |  |  |             |  |  |             |  |  |             |  |  |             |  |  |             |  |  |             |  |  |             |  |  |  |  |  |             |  |  |
| 3                 |                  |                          |                                     |  |  |                      |       |             |  |             |       |                     |             |             |     |     |             |     |        |             |  |  |             |  |  |             |  |  |             |  |  |             |  |  |             |  |  |             |  |  |             |  |  |  |  |  |             |  |  |
| 4                 |                  |                          |                                     |  |  |                      |       |             |  |             |       |                     |             |             |     |     |             |     |        |             |  |  |             |  |  |             |  |  |             |  |  |             |  |  |             |  |  |             |  |  |             |  |  |  |  |  |             |  |  |
| 5                 |                  |                          |                                     |  |  |                      |       |             |  |             |       |                     |             |             |     |     |             |     |        |             |  |  |             |  |  |             |  |  |             |  |  |             |  |  |             |  |  |             |  |  |             |  |  |  |  |  |             |  |  |
| 6                 |                  |                          |                                     |  |  |                      |       |             |  |             |       |                     |             |             |     |     |             |     |        |             |  |  |             |  |  |             |  |  |             |  |  |             |  |  |             |  |  |             |  |  |             |  |  |  |  |  |             |  |  |
| 7                 |                  |                          |                                     |  |  |                      |       |             |  |             |       |                     |             |             |     |     |             |     |        |             |  |  |             |  |  |             |  |  |             |  |  |             |  |  |             |  |  |             |  |  |             |  |  |  |  |  |             |  |  |
| 8                 |                  |                          |                                     |  |  |                      |       |             |  |             |       |                     |             |             |     |     |             |     |        |             |  |  |             |  |  |             |  |  |             |  |  |             |  |  |             |  |  |             |  |  |             |  |  |  |  |  |             |  |  |
| <b>SW5</b>        | 5                |                          |                                     |  |  |                      |       |             |  |             |       |                     |             |             |     |     |             |     |        |             |  |  |             |  |  |             |  |  |             |  |  |             |  |  |             |  |  |             |  |  |             |  |  |  |  |  |             |  |  |
|                   | 6                |                          |                                     |  |  |                      |       |             |  |             |       |                     |             |             |     |     |             |     |        |             |  |  |             |  |  |             |  |  |             |  |  |             |  |  |             |  |  |             |  |  |             |  |  |  |  |  |             |  |  |

\*2 Power failure automatic recovery can be set by either remote controller or this DIP SW. If one of them is set to ON, Auto recovery activates. Please set Auto recovery basically by remote controller because not all units have DIP SW. Please refer to the indoor unit installation manual.

\*3 SW7-1,2 are used for demand control. SW7-1,2 are effective only at the demand control. (Refer to the next page: Special function (b))

\*4 Please do not use SW7-3 to 6 usually. Trouble might be caused by the usage condition.

\*5 SW5-1 to 4: Function switch

**(2) Function of connector**

| Types     | Connector | Function            | Action by open/ short operation |        | Effective timing     |
|-----------|-----------|---------------------|---------------------------------|--------|----------------------|
|           |           |                     | Short                           | Open   |                      |
| Connector | CN31      | Emergency operation | Start                           | Normal | When power supply ON |

## Special function

### (a) Low-level sound priority mode (Local wiring)

Unit enters into Low-level sound priority mode by external signal input setting.

Inputting external signals to the outdoor unit decreases the outdoor unit operation sound 3 to 4 dB lower than that of usual. Adding a commercial timer or on-off switch contactor setting to the CNDM connector which is optional contactor for demand input located on the outdoor controller board enables to control compressor operation frequency.

Note: The performance depends on the load of conditioned outdoor temperature.

#### How to wire

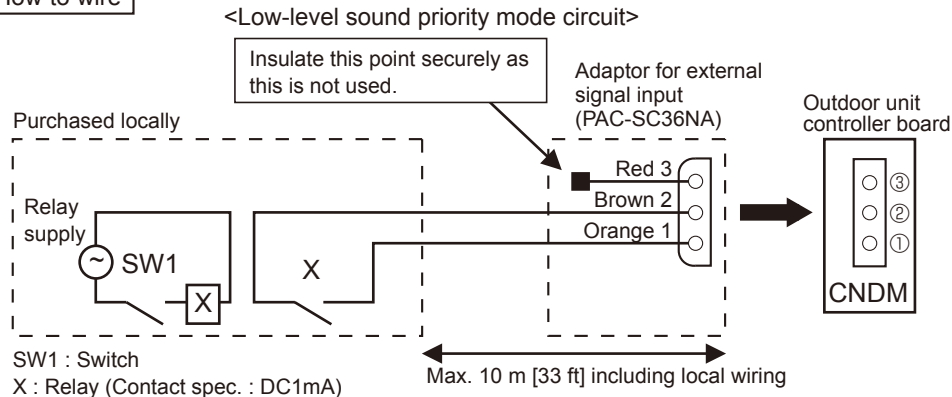

1) Make the circuit as shown above with Adaptor for external signal input (PAC-SC36NA).

2) Turn SW1 to on for Low-level sound priority mode.

Turn SW1 to off to release Low-level sound priority mode and normal operation.

### (b) Demand control (Local wiring)

Demand control is available by external input. In this mode, power consumption is decreased within the range of usual 0 to 100%.

#### How to wire

Basically, the wiring is the same as (a).

Connect an SW1 which is procured at field to the between Orange and Red (1 and 3) of the Adaptor for external signal input (PAC-SC36NA), and insulate the tip of the brown lead wire.

It is possible to set it to the following power consumption (compared with ratings) by setting the SW7-1, 2.

| SW7-1 | SW7-2 | Max. compressor frequency<br>(SW1 on) |
|-------|-------|---------------------------------------|
| OFF   | OFF   | 0% (Operation stop)                   |
| ON    | OFF   | 50%                                   |
| OFF   | ON    | 75%                                   |

### <Display function of inspection for outdoor unit>

The blinking patterns of both LED1 (green) and LED2 (red) indicate the types of abnormality when it occurs. Types of abnormality can be indicated in details by connecting an optional part 'A-Control Service Tool (PAC-SK52ST)' to connector CNM on outdoor controller board.

[Display]

(1)Normal condition

| Unit condition                | Outdoor controller board |             | A-Control Service Tool |                              |
|-------------------------------|--------------------------|-------------|------------------------|------------------------------|
|                               | LED1 (Green)             | LED2 (Red)  | Check code             | Indication of the display    |
| When the power is turned on   | Lighted                  | Lighted     | — ⇄ —                  | Alternately blinking display |
| When unit stops               | Lighted                  | Not lighted | 00, etc.               | Operation mode               |
| When compressor is warming up | Lighted                  | Not lighted | 08, etc.               |                              |
| When unit operates            | Lighted                  | Lighted     | C5, H7 etc.            |                              |

(2)Abnormal condition

| Indication               |            | Contents  | Check code<br>*1 | Error<br>Inspection method   | Detailed reference page  |
|--------------------------|------------|---|------------------|--|--|
| Outdoor controller board |            |   |                  |  |  |
| LED1 (Green)             | LED2 (Red) |   |                  |  |  |
| 1 blinking               | 2 blinking | Connector (63H) is open.  | F5               | ①Check if connector (63H) on the outdoor controller board is not disconnected.<br>②Check continuity of pressure switch (63H) by tester.  | P.34   |
| 2 blinking               | 1 blinking | Miswiring of indoor/outdoor unit connecting wire, excessive number of indoor units (4 units or more)  | —                | ①Check if indoor/outdoor connecting wire is connected correctly.<br>②Check if 4 or more indoor units are connected to outdoor unit.<br>③Check if noise entered into indoor/outdoor connecting wire or power supply.<br>④Re-check error by turning off power, and on again. | P.34<br>(EA)   |
|                          |            | Miswiring of indoor/outdoor unit connecting wire (converse wiring or disconnection)   | —                |  |  |
| Startup time over        |            | —   | P.34<br>(EC)     |  |  |
| 2 blinking               | 2 blinking | Indoor/outdoor unit communication error (signal receiving error) is detected by indoor unit.  | E6               |  | ①Check if indoor/outdoor connecting wire is connected correctly.<br>②Check if noise entered into indoor/outdoor connecting wire or power supply.<br>③Check if noise entered into indoor/outdoor controller board.<br>④Re-check error by turning off power, and on again. |
|                          |            | Indoor/outdoor unit communication error (transmitting error) is detected by indoor unit.  | E7               | *2   |  |
|                          |            | Indoor/outdoor unit communication error (signal receiving error) is detected by outdoor unit.   | —                | P.40<br>(E8)   |  |
|                          |            | Indoor/outdoor unit communication error (transmitting error) is detected by outdoor unit.   | —                | P.40<br>(E9)   |  |
| 3 blinking               | 3 blinking | Remote controller signal receiving error is detected by remote controller.  | E0               | ①Check if connecting wire of indoor unit or remote controller is connected correctly.<br>②Check if noise entered into transmission wire of remote controller.<br>③Re-check error by turning off power, and on again.   | P.39   |
|                          |            | Remote controller transmitting error is detected by remote controller.  | E3               |  | P.39   |
|                          |            | Remote controller signal receiving error is detected by indoor unit.  | E4               |  | P.39   |
|                          |            | Remote controller transmitting error is detected by indoor unit.  | E5               |  | P.39   |
| 4 blinking               | 4 blinking | Check code is not defined.  | EF               | ①Check if remote controller is MA remote controller (PAR-21MAA).<br>②Check if noise entered into transmission wire of remote controller.<br>③Check if noise entered into indoor/outdoor connecting wire.<br>④Re-check error by turning off power, and on again.            | P.40   |
| 5 blinking               | 5 blinking | Serial communication error<br><Communication between outdoor controller board and outdoor power board><br><Communication between outdoor controller board and M-NET P.C. board> | Ed               | ①Check if connector (CN4) on outdoor controller board and outdoor power board is not disconnected.<br>②Check if there is poor connection of connector on outdoor controller board(CNMNT and CNVMNT).<br>③Check M-NET communication signal.                                 | P.40   |
|                          |            | Communication error of M-NET system   | A0-A8            |  |  |

\*1 Check code displayed on remote controller

\*2 Refer to the indoor unit service manual.

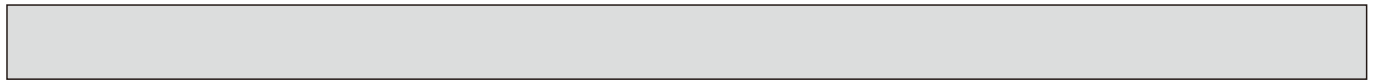

| Indication               |  | Error   |  |   |  |  |
|--------------------------|--|---|--|---|--|--|
| Outdoor controller board |  | Contents  | Check code *1  | Inspection method   | Detailed reference page  |  |
| LED1 (Green)             | LED2 (Red)                             |   |  |   |  |  |
| 3 blinking               | 1 blinking                             | Abnormality of shell thermistor (TH32) and discharging temperature (TH4)                                | U2   | ①Check if stop valves are open.<br>②Check if connectors (TH4, TH32, LEV-A) on outdoor controller board are not disconnected.<br>③Check if unit is filled with specified amount of refrigerant.<br>④Measure resistance values among terminals on indoor valve and outdoor linear expansion valve using a tester. | P.35   |  |
|                          | 2 blinking                             | Abnormal high pressure (High pressure switch 63H operated.)   | U1   | ①Check if indoor/outdoor units have a short cycle on their air ducts.<br>②Check if connector (63H) on outdoor controller board is not disconnected.<br>③Check if heat exchanger and filter is not dirty.<br>④Measure resistance values among terminals on linear expansion valve using a tester.                | P.35   |  |
|                          | 3 blinking                             | Abnormality of outdoor fan motor rotational speed   | U8   | ①Check the outdoor fan motor.   | P.37   |  |
|                          | 4 blinking                             | Compressor overcurrent breaking (Start-up locked)   | Compressor overcurrent breaking  | UF  | ①Check if stop valves are open.<br>②Check looseness, disconnection, and converse connection of compressor wiring.<br>③Measure resistance values among terminals on compressor using a tester.<br>④Check if outdoor unit has a short cycle on its air duct. | P.38   |
|                          |  |   | Abnormality of current sensor (P.B.)   | UP  |  | P.38   |
|                          |  |   | Abnormality of power module  | UH  |  | P.38   |
|                          | 5 blinking                             | Open/short of discharge thermistor (TH4)  | Open/short of outdoor thermistors (TH3, TH6, TH7, TH8 and TH33)  | U6  |  | ①Check if connectors (TH3, TH4, TH6, TH7 and TH33) on outdoor controller board and connector (CN3) on outdoor power board are not disconnected.<br>②Measure resistance value of outdoor thermistors. |
|                          |  |   | U3   | P.36  |  |  |
| 6 blinking               | Abnormality of heatsink temperature    | U5  | ①Check if indoor/outdoor units have a short cycle on their air ducts.<br>②Measure resistance value of outdoor heatsink thermistor(TH8).  | P.36  |  |  |
| 7 blinking               | Abnormality of voltage                 | U9  | ①Check looseness, disconnection, and converse connection of compressor wiring.<br>②Measure resistance value among terminals on compressor using a tester.<br>③Check the continuity of contactor (52C).<br>④Check if power supply voltage decreases.<br>⑤Check the wiring of CN52C.<br>⑥Check the wiring of CNAF. | P.37<br>-38   |  |  |
| 4 blinking               | 1 blinking                             | Abnormality of room temperature thermistor (TH1)  | P1   | ①Check if connectors (CN20, CN21, CN29, and CN44) on indoor controller board are not disconnected.<br>②Measure resistance value of indoor thermistors.  | *2   |  |
|                          |  | Abnormality of pipe temperature thermistor /Liquid (TH2)  | P2   |   | *2   |  |
|                          |  | Abnormality of pipe temperature thermistor/Condenser-Evaporator(TH5)                                    | P9   |   |  |  |
|                          | 2 blinking                             | Abnormality of drain sensor (DS)<br>Float switch connector open(FS)<br>Indoor drain overflow protection | P4   | ①Check if connector (CN31)(CN4F) on indoor controller board is not disconnected.<br>②Measure resistance value of indoor thermistors.<br>③Measure resistance value among terminals on drain pump using a tester.<br>④Check if drain pump works.<br>⑤Check drain function.  | *2   |  |
|                          |  |   | P5   |   |  |  |
|                          | 3 blinking                             | Freezing (cooling)/overheating (heating) protection   | P6   | ①Check if indoor unit has a short cycle on its air duct.<br>②Check if heat exchanger and filter is not dirty.<br>③Measure resistance value on indoor and outdoor fan motors.<br>④Check if the inside of refrigerant piping is not clogged.  | *2   |  |
|                          | 4 blinking                             | Abnormality of pipe temperature   | P8   | ①Check if indoor thermistors (TH2 and TH5) are not disconnected from holder.<br>②Check if stop valve is open.<br>③Check converse connection of extension pipe. (on plural units connection)<br>④Check if indoor/outdoor connecting wire is connected correctly. (on plural units connection)                    | *2   |  |
| 5 blinking               | Abnormality of indoor controller board | Fb  | ①Replace indoor controller board.  | *2  |  |  |
| -                        | -                                      | Abnormality of remote controller board  | E1<br>E2   | ①Replace remote controller.   | P.39   |  |

\*1 Check code displayed on remote controller

\*2 Refer to the indoor unit service manual.

**<Outdoor unit operation monitor function>**

**[When option part 'A-Control Service Tool (PAC-SK52ST)' is connected to outdoor controller board (CNM)]**

Digital indicator LED1 displays 2 digit number or code to inform operation condition and the meaning of check code by controlling DIP SW2 on 'A-Control Service Tool'.

Operation indicator SW2 : Indicator change of self diagnosis

The black square (■) indicates a switch position.

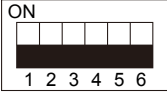
| SW2 setting  | Display detail | Explanation for display | Unit |
|--|----------------|-------------------------|------|
|  |                |                         |      |

**<Digital indicator LED1 working details>**

(Be sure that 1 to 6 in the SW2 are set to OFF.)

(1) Display when the power supply ON.

When the power supply ON, blinking displays by turns.

Wait for 4 minutes at the longest.

(2) When the display lights. (Normal operation)

① Operation mode display

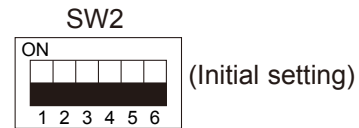
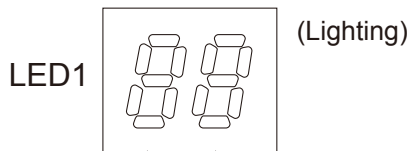
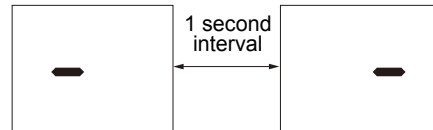

The tens digit : Operation mode

| Display | Operation Model |
|---------|-----------------|
| O       | OFF / FAN       |
| C       | COOLING / DRY   |
| H       | HEATING         |
| d       | DEFROSTING      |

The ones digit : Relay output

| Display | Warming-up Compressor | Compressor | 4-way valve | Solenoid valve |
|---------|-----------------------|------------|-------------|----------------|
| 0       | —                     | —          | —           | —              |
| 1       | —                     | —          | —           | ON             |
| 2       | —                     | —          | ON          | —              |
| 3       | —                     | —          | ON          | ON             |
| 4       | —                     | ON         | —           | —              |
| 5       | —                     | ON         | —           | ON             |
| 6       | —                     | ON         | ON          | —              |
| 7       | —                     | ON         | ON          | ON             |
| 8       | ON                    | —          | —           | —              |
| A       | ON                    | —          | ON          | —              |

② Display during error postponement  
Postponement code is displayed when compressor stops due to the work of protection device.  
Postponement code is displayed while error is being postponed.

(3) When the display blinks

Inspection code is displayed when compressor stops due to the work of protection devices.

| Display | Inspection unit |
|---------|-----------------|
| 0       | Outdoor unit    |
| 1       | Indoor unit 1   |
| 2       | Indoor unit 2   |

| Display | Contents to be inspected (During operation)                          |
|---------|--|
| U1      | Abnormal high pressure (63H worked)                                  |
| U2      | Abnormal high discharge temperature, shortage of refrigerant         |
| U3      | Open/short circuit of comp. surface thermistor (TH32)                |
| U4      | Open/short of outdoor unit thermistors (TH3, TH6, TH7, TH8 and TH33) |
| U5      | Abnormal temperature of heat sink                                    |
| U6      | Abnormality of power module  |
| U8      | Abnormality in outdoor fan motor.                                    |
| UF      | Compressor overcurrent interruption (When Comp. locked)              |
| UH      | Current sensor error   |
| UL      | Abnormal low pressure (63L worked)                                   |
| UP      | Compressor overcurrent interruption                                  |
| P1-P8   | Abnormality of indoor units  |
| A0-A7   | Communication error of M-NET system                                  |

| Display | Contents to be inspected (When power is turned on)   |
|---------|--|
| F3      | 63L connector(red) is open.  |
| F5      | 63H connector(yellow) is open.   |
| F9      | 2 connectors (63H/63L) are open.   |
| E8      | Indoor/outdoor communication error (Signal receiving error) (Outdoor unit)                           |
| E9      | Indoor/outdoor communication error (Transmitting error) (Outdoor unit)                               |
| EA      | Miswiring of indoor/outdoor unit connecting wire, excessive number of indoor units (4 units or more) |
| Eb      | Miswiring of indoor/outdoor unit connecting wire(converse wiring or disconnection)                   |
| EC      | Startup time over  |
| E0-E7   | Communication error except for outdoor unit  |

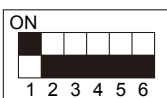
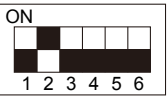
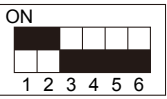
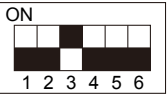
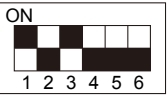
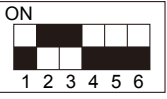
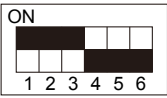
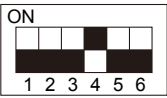
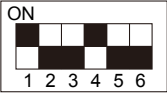
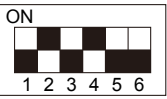

The black square (■) indicates a switch position.

| SW2 setting   | Display detail  | Explanation for display  | Unit         |
|---|---|--|--------------|
|    | Pipe temperature/Liquid (TH3)<br>-58 to 194           | -58 to 194 [-50 to 90°C]<br>(When the coil thermistor detects 0°F or below, “-” and temperature are displayed by turns.)<br>(Example) When -10°F;<br><div style="text-align: center;">           0.5 s    0.5 s    2 s<br/>           -□    →10    →□□<br/>           ↑         </div>                           | °F<br>[°C]   |
|    | Comp. Surface temperature (TH32)<br>37 to 327         | 37 to 327 [3 to 164°C]<br>(When the discharge thermistor detects 100°F or more, hundreds digit, tens digit and ones digit are displayed by turns.)<br>(Example) When 105°F;<br><div style="text-align: center;">           0.5 s    0.5 s    2 s<br/>           □1    →05    →□□<br/>           ↑         </div> | °F<br>[°C]   |
|    | Output step of outdoor FAN<br>0 to 10                 | 0 to 10  | Step         |
|    | The number of ON/OFF times of compressor<br>0 to 9999 | 0 to 9999<br>(When the number of times is 100 or more, hundreds digit, tens digit and ones digit are displayed by turns.)<br>(Example) When 42500 times (425 × 100 times);<br><div style="text-align: center;">           0.5 s    0.5 s    2 s<br/>           □4    →25    →□□<br/>           ↑         </div>  | 100 times    |
|  | Compressor integrating operation times<br>0 to 9999   | 0 to 9999<br>(When it is 100 hours or more, hundreds digit, tens digit and ones digit are displayed by turns.)<br>(Example) When 2450 hours (245 × 10 hours);<br><div style="text-align: center;">           0.5 s    0.5 s    2 s<br/>           □2    →45    →□□<br/>           ↑         </div>               | 10 hours     |
|  | Compressor operating current<br>0 to 50               | 0 to 50<br>Note: Omit the figures after the decimal fractions.   | A            |
|  | Compressor operating frequency<br>0 to 255            | 0 to 255<br>(When it is 100Hz or more, hundreds digit, tens digit and ones digit are displayed by turns.)<br>(Example) When 125Hz;<br><div style="text-align: center;">           0.5 s    0.5 s    2 s<br/>           □1    →25    →□□<br/>           ↑         </div>  | Hz           |
|  | LEV-A opening pulse<br>0 to 480                       | 0 to 480<br>(When it is 100 pulse or more, hundreds digit, tens digit and ones digit are displayed by turns.)<br>(Example) When 150 pulse;<br><div style="text-align: center;">           0.5 s    0.5 s    2 s<br/>           □1    →50    →□□<br/>           ↑         </div>                                  | Pulse        |
|  | Error postponement code history (1) of outdoor unit   | Postponement code display<br>Blinking: During postponement<br>Lighting: Cancellation of postponement<br>“00” is displayed in case of no postponement.  | Code display |
|  | Operation mode on error occurring                     | Operation mode of when operation stops due to error is displayed by setting SW2 as below. (SW2)  | Code display |

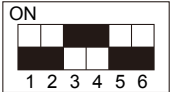
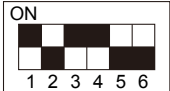
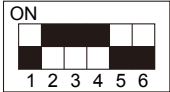
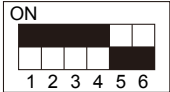
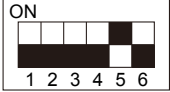
The black square (■) indicates a switch position.

| SW2 setting  | Display detail   | Explanation for display   | Unit         |
|--|--|---|--------------|
|    | Pipe temperature/Liquid (TH3) on error occurring<br>-58 to 194                   | -58 to 194 [-50 to 90°C]<br>(When the coil thermistor detects 0°F or below, “-” and temperature are displayed by turns.)<br>(Example) When -15°F;<br>0.5 s    0.5 s    2 s<br>-□    → 15    → □□<br>↑                 | °F<br>[°C]   |
|    | Comp. surface temperature (TH32) on error occurring<br>37 to 327                 | 37 to 327 [3 to 164°C]<br>(When the temperature is 100°F or more, the hundreds digit, tens digit and ones digit are displayed by turns.)<br>(Example) When 130°F;<br>0.5 s    0.5 s    2 s<br>□1    → 30    → □□<br>↑ | °F<br>[°C]   |
|    | Compressor operating current on error occurring<br>0 to 50                       | 0 to 50   | A            |
|  | Error history (1) (latest)<br>Alternate display of abnormal unit number and code | When no error history,<br>“ 0 ” and “ - - ” are displayed by turns.   | Code display |
|  | Error history (2)<br>Alternate display of error unit number and code             | When no error history,<br>“ 0 ” and “ - - ” are displayed by turns.   | Code display |
|  | Thermostat ON time<br>0 to 999   | 0 to 999<br>(When it is 100 minutes or more, the hundreds digit, tens digit and ones digit are displayed by turns.)<br>(Example) When 245 minutes;<br>0.5 s    0.5 s    2 s<br>□2    → 45    → □□<br>↑                | Minute       |
|  | Test run elapsed time<br>0 to 120  | 0 to 120<br>(When it is 100 minutes or more, the hundreds digit, tens digit and ones digit are displayed by turns.)<br>(Example) When 105 minutes;<br>0.5 s    0.5 s    2 s<br>□1    → 05    → □□<br>↑                | Minute       |

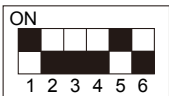
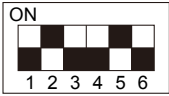
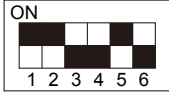
The black square (■) indicates a switch position.

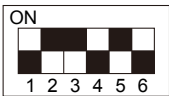
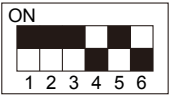
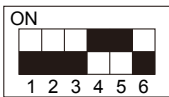
| SW2 setting   | Display detail  | Explanation for display   | Unit            |                 |                    |                               |                        |                                |                 |                 |                   |                                     |              |    |      |    |      |    |              |
|---|---|---|-----------------|-----------------|--------------------|-------------------------------|------------------------|--------------------------------|-----------------|-----------------|-------------------|-------------------------------------|--------------|----|------|----|------|----|--------------|
|    | The number of connected indoor units                                  | 0 to 3<br>(The number of connected indoor units are displayed.)   | Unit            |                 |                    |                               |                        |                                |                 |                 |                   |                                     |              |    |      |    |      |    |              |
|    | Capacity setting display  | Displayed as an outdoor capacity code<br><table border="1" data-bbox="868 491 1302 640"> <thead> <tr> <th>Capacity</th> <th>Code</th> <th>Capacity</th> <th>Code</th> </tr> </thead> <tbody> <tr> <td>A12N</td> <td>9</td> <td>A30N</td> <td>14</td> </tr> <tr> <td>A18N</td> <td>10</td> <td>A36N</td> <td>20</td> </tr> <tr> <td>A24N</td> <td>11</td> <td>A42N</td> <td>25</td> </tr> </tbody> </table>  | Capacity        | Code            | Capacity           | Code                          | A12N                   | 9                              | A30N            | 14              | A18N              | 10                                  | A36N         | 20 | A24N | 11 | A42N | 25 | Code display |
| Capacity  | Code  | Capacity  | Code            |                 |                    |                               |                        |                                |                 |                 |                   |                                     |              |    |      |    |      |    |              |
| A12N  | 9   | A30N  | 14              |                 |                    |                               |                        |                                |                 |                 |                   |                                     |              |    |      |    |      |    |              |
| A18N  | 10  | A36N  | 20              |                 |                    |                               |                        |                                |                 |                 |                   |                                     |              |    |      |    |      |    |              |
| A24N  | 11  | A42N  | 25              |                 |                    |                               |                        |                                |                 |                 |                   |                                     |              |    |      |    |      |    |              |
|    | Outdoor unit setting information                                      | <ul style="list-style-type: none"> <li>The tens digit (Total display for applied setting)</li> </ul> <table border="1" data-bbox="820 697 1394 821"> <thead> <tr> <th>Setting details</th> <th>Display details</th> </tr> </thead> <tbody> <tr> <td>H·P / Cooling only</td> <td>0 : H·P      1 : Cooling only</td> </tr> <tr> <td>Single phase / 3 phase</td> <td>0 : Single phase   2 : 3 phase</td> </tr> </tbody> </table> <ul style="list-style-type: none"> <li>The ones digit</li> </ul> <table border="1" data-bbox="820 874 1394 959"> <thead> <tr> <th>Setting details</th> <th>Display details</th> </tr> </thead> <tbody> <tr> <td>Defrosting switch</td> <td>0 : Normal    1 : For high humidity</td> </tr> </tbody> </table> <p>(Example) When heat pump, 3 phase and defrosting (normal) are set up, "20" is displayed.</p> | Setting details | Display details | H·P / Cooling only | 0 : H·P      1 : Cooling only | Single phase / 3 phase | 0 : Single phase   2 : 3 phase | Setting details | Display details | Defrosting switch | 0 : Normal    1 : For high humidity | Code display |    |      |    |      |    |              |
| Setting details   | Display details   |   |                 |                 |                    |                               |                        |                                |                 |                 |                   |                                     |              |    |      |    |      |    |              |
| H·P / Cooling only  | 0 : H·P      1 : Cooling only   |   |                 |                 |                    |                               |                        |                                |                 |                 |                   |                                     |              |    |      |    |      |    |              |
| Single phase / 3 phase  | 0 : Single phase   2 : 3 phase  |   |                 |                 |                    |                               |                        |                                |                 |                 |                   |                                     |              |    |      |    |      |    |              |
| Setting details   | Display details   |   |                 |                 |                    |                               |                        |                                |                 |                 |                   |                                     |              |    |      |    |      |    |              |
| Defrosting switch   | 0 : Normal    1 : For high humidity                                   |   |                 |                 |                    |                               |                        |                                |                 |                 |                   |                                     |              |    |      |    |      |    |              |
|  | Indoor pipe temperature/Liquid (TH2(1))<br>Indoor 1<br>-38 to 190     | -38 to 190 [-39 to 88°C]<br>(When the temperature is 0°F or less, "-" and temperature are displayed by turns.)  | °F<br>[°C]      |                 |                    |                               |                        |                                |                 |                 |                   |                                     |              |    |      |    |      |    |              |
|  | Indoor pipe temperature/Cond./Eva. (TH5(1))<br>Indoor 1<br>-38 to 190 | -38 to 190 [-39 to 88°C]<br>(When the temperature is 0°F or less, "-" and temperature are displayed by turns.)  | °F<br>[°C]      |                 |                    |                               |                        |                                |                 |                 |                   |                                     |              |    |      |    |      |    |              |
|  | Indoor pipe temperature/Liquid (TH2(2))<br>Indoor 2<br>-38 to 190     | -38 to 190 [-39 to 88°C]<br>(When the temperature is 0°F or less, "-" and temperature are displayed by turns.)  | °F<br>[°C]      |                 |                    |                               |                        |                                |                 |                 |                   |                                     |              |    |      |    |      |    |              |
|  | Indoor pipe temperature/Cond./Eva. (TH5(2))<br>Indoor 2<br>-38 to 190 | -38 to 190 [-39 to 88°C]<br>(When the temperature is 0°F or less, "-" and temperature are displayed by turns.)  | °F<br>[°C]      |                 |                    |                               |                        |                                |                 |                 |                   |                                     |              |    |      |    |      |    |              |
|  | Indoor room temperature (TH1)<br>46 to 102                            | 46 to 102 [8 to 39°C]   | °F<br>[°C]      |                 |                    |                               |                        |                                |                 |                 |                   |                                     |              |    |      |    |      |    |              |



The black square (■) indicates a switch position.

| SW2 setting | Display detail  | Explanation for display   | Unit         |
|-------------|---|---|--------------|
|             | <p>Capacity save<br/>0 to 100</p> <p>When air conditioner is connected to M-NET and capacity save mode is demanded, a value from "0" to "100" is displayed.</p> <p>[ When there is no setting of capacity save, "100" is displayed. ]</p> | <p>0 to 100<br/>(When the capacity is 100%, hundreds digit, tens digit and ones digit are displayed by turns.)<br/>(Example) When 100%;</p> <p>0.5 s    0.5 s    2 s<br/>□1    →00    →□□</p>   | %            |
|             | <p>Error postponement code history (2) of outdoor unit</p>  | <p>Postponement code display<br/>Blinking: During postponement<br/>Lighting: Cancellation of postponement<br/>"00" is displayed in case of no postponement.</p>                                 | Code display |
|             | <p>Error postponement code history (3) of outdoor unit</p>  | <p>Postponement code display<br/>Blinking: During postponement<br/>Lighting: Cancellation of postponement<br/>"00" is displayed in case of no postponement.</p>                                 | Code display |
|             | <p>Check code history (3) (Oldest)<br/>Alternate display of abnormal unit number and code.</p>  | <p>When no error history, "0" and "--" are displayed by turns.</p>  | Code display |
|             | <p>Error thermistor display</p> <p>[ When there is no error thermistor, "--" is displayed. ]</p>  | <p>3: Outdoor pipe temperature /Liquid (TH3)<br/>6: Outdoor pipe temperature /2-phase (TH6)<br/>7: Outdoor ambient temperature (TH7)<br/>8: Outdoor heat sink (TH8)</p>                         | Code display |
|             | <p>Operation frequency on error occurring<br/>0 to 255</p>  | <p>0 to 255<br/>(When it is 100 Hz or more, hundreds digit, tens digit and ones digit are displayed by turns.)<br/>(Example) When 125 Hz;</p> <p>0.5 s    0.5 s    2 s<br/>□1    →25    →□□</p> | Hz           |
|             | <p>Fan step on error occurring<br/>0 to 10</p>  | <p>0 to 10</p>  | Step         |

The black square (■) indicates a switch position.

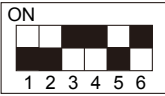
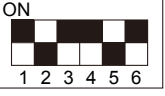
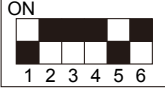
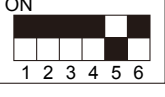
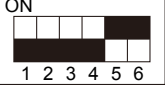
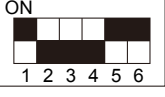
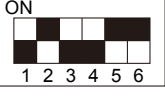
| SW2 setting   | Display detail  | Explanation for display   | Unit       |
|---|---|---|------------|
|    | LEV-A opening pulse on error occurring<br>0 to 480                        | 0 to 480<br>(When it is 100 pulse or more, hundreds digit, tens digit and ones digit are displayed by turns.)<br>(Example) When 130 pulse;<br>0.5 s    0.5 s    2 s<br>□1    → 30    → □□                                     | Pulse      |
|    | Indoor room temperature (TH1) on error occurring<br>46 to 102             | 46 to 102 [8 to 39°C]   | °F<br>[°C] |
|    | Indoor pipe temperature/Liquid (TH2) on error occurring<br>-38 to 190     | -38 to 190 [-39 to 88°C]<br>(When the temperature is 0°F or less, “-” and temperature are displayed by turns.)<br>(Example) When -15°F;<br>0.5 s    0.5 s    2 s<br>-□    → 15    → □□  | °F<br>[°C] |
|  | Indoor pipe temperature/Cond./Eva. (TH5) on error occurring<br>-38 to 190 | -38 to 190 [-39 to 88°C]<br>(When the temperature is 0°F or less, “-” and temperature are displayed by turns.)<br>(Example) When -15°F;<br>0.5 s    0.5 s    2 s<br>-□    → 15    → □□  | °F<br>[°C] |
|  | Outdoor pipe temperature/2-phase (TH6) on error occurring<br>-38 to 190   | -38 to 190 [-39 to 88°C]<br>(When the temperature is 0°F or less, “-” and temperature are displayed by turns.)<br>(Example) When -15°F;<br>0.5 s    0.5 s    2 s<br>-□    → 15    → □□  | °F<br>[°C] |
|  | Outdoor outside temperature (TH7) on error occurring<br>-38 to 190        | -38 to 190 [-39 to 88°C]<br>(When the temperature is 0°F or less, “-” and temperature are displayed by turns.)<br>(Example) When -15°F;<br>0.5 s    0.5 s    2 s<br>-□    → 15    → □□  | °F<br>[°C] |
|  | Outdoor heat sink temperature (TH8) on error occurring<br>-40 to 327      | -40 to 327 [-40 to 164°C]<br>(When the temperature is 0°F or less, “-” and temperature are displayed by turns.)<br>(When the temperature is 100°F or more, hundreds digit, tens digit and ones digit are displayed by turns.) | °F<br>[°C] |

The black square (■) indicates a switch position.

| SW2 setting  | Display detail  | Explanation for display  | Unit        |                 |         |        |   |    |                   |                     |    |                    |                          |    |   |                          |    |                                   |                     |    |  |                     |    |                                |   |    |              |
|--|---|--|-------------|-----------------|---------|--------|---|----|-------------------|---------------------|----|--------------------|--------------------------|----|---|--------------------------|----|-----------------------------------|---------------------|----|--|---------------------|----|--------------------------------|---|----|--------------|
|  | Discharge superheat on error occurring SHd<br>32 to 360<br>[Cooling = TH32-TH6]<br>[Heating = TH32-TH5] | 32 to 360 [0 to 182°C]<br>(When the temperature is 100°F or more, hundreds digit, tens digit and ones digit are displayed by turns.)<br>(Example) When 150°F;<br>0.5 s    0.5 s    2 s<br>□1    →50    →□□   | °F<br>[°C]  |                 |         |        |   |    |                   |                     |    |                    |                          |    |   |                          |    |                                   |                     |    |  |                     |    |                                |   |    |              |
|  | Sub cool on error occurring. SC<br>32 to 266<br>[Cooling = TH6-TH3]<br>[Heating = TH5-TH2]              | 32 to 266 [0 to 130°C]<br>(When the temperature is 100°F or more, hundreds digit, tens digit and ones digit are displayed by turns.)<br>(Example) When 115°F;<br>0.5 s    0.5 s    2 s<br>□1    →15    →□□   | °F<br>[°C]  |                 |         |        |   |    |                   |                     |    |                    |                          |    |   |                          |    |                                   |                     |    |  |                     |    |                                |   |    |              |
|  | Thermostat-on time until error stops<br>0 to 999  | 0 to 999<br>(When it is 100 minutes or more, hundreds digit, tens digit and ones digit are displayed by turns.)<br>(Example) When 415 minutes;<br>0.5 s    0.5 s    2 s<br>□4    →15    →□□  | Minute      |                 |         |        |   |    |                   |                     |    |                    |                          |    |   |                          |    |                                   |                     |    |  |                     |    |                                |   |    |              |
|  | Pipe temperature/Suction (TH33)<br>-58 to 194   | -58 to 194 [-50 to 90°C]<br>(When the coil thermistor detects 0°F or below, “-” and temperature are displayed by turns.)<br>(Example) When -10°F;<br>0.5 s    0.5 s    2 s<br>-□    →10    →□□   | °F<br>[°C]  |                 |         |        |   |    |                   |                     |    |                    |                          |    |   |                          |    |                                   |                     |    |  |                     |    |                                |   |    |              |
|  | U9 Error status during the Error postponement period  | <table border="1"> <thead> <tr> <th>Description</th> <th>Detection point</th> <th>Display</th> </tr> </thead> <tbody> <tr> <td>Normal</td> <td>-</td> <td>00</td> </tr> <tr> <td>Overvoltage error</td> <td>Power circuit board</td> <td>01</td> </tr> <tr> <td>Undervoltage error</td> <td>Controller circuit board</td> <td>02</td> </tr> <tr> <td>Input current sensor error.<br/>L1 or L2-phase open error.</td> <td>Controller circuit board</td> <td>04</td> </tr> <tr> <td>Abnormal power synchronous signal</td> <td>Power circuit board</td> <td>08</td> </tr> <tr> <td>PFC error (A12, 18, 24NHA)<br/>(Overvoltage/Undervoltage/Overcurrent)</td> <td>Power circuit board</td> <td>10</td> </tr> <tr> <td>PFC/ACTM error<br/>Undervoltage</td> <td>Check CNAF wiring.<br/>Defective ACTM/P.B.</td> <td>20</td> </tr> </tbody> </table> <p>Display examples for multiple errors:<br/>           Overvoltage (01) + Undervoltage (02) = 03<br/>           Undervoltage (02) + Power-sync signal error (08) = 0A<br/>           L-phase open error (04) + PFC error (10) = 14</p> | Description | Detection point | Display | Normal | - | 00 | Overvoltage error | Power circuit board | 01 | Undervoltage error | Controller circuit board | 02 | Input current sensor error.<br>L1 or L2-phase open error. | Controller circuit board | 04 | Abnormal power synchronous signal | Power circuit board | 08 | PFC error (A12, 18, 24NHA)<br>(Overvoltage/Undervoltage/Overcurrent) | Power circuit board | 10 | PFC/ACTM error<br>Undervoltage | Check CNAF wiring.<br>Defective ACTM/P.B. | 20 | Code display |
| Description  | Detection point   | Display  |             |                 |         |        |   |    |                   |                     |    |                    |                          |    |   |                          |    |                                   |                     |    |  |                     |    |                                |   |    |              |
| Normal   | -   | 00   |             |                 |         |        |   |    |                   |                     |    |                    |                          |    |   |                          |    |                                   |                     |    |  |                     |    |                                |   |    |              |
| Overvoltage error  | Power circuit board   | 01   |             |                 |         |        |   |    |                   |                     |    |                    |                          |    |   |                          |    |                                   |                     |    |  |                     |    |                                |   |    |              |
| Undervoltage error   | Controller circuit board  | 02   |             |                 |         |        |   |    |                   |                     |    |                    |                          |    |   |                          |    |                                   |                     |    |  |                     |    |                                |   |    |              |
| Input current sensor error.<br>L1 or L2-phase open error.            | Controller circuit board  | 04   |             |                 |         |        |   |    |                   |                     |    |                    |                          |    |   |                          |    |                                   |                     |    |  |                     |    |                                |   |    |              |
| Abnormal power synchronous signal                                    | Power circuit board   | 08   |             |                 |         |        |   |    |                   |                     |    |                    |                          |    |   |                          |    |                                   |                     |    |  |                     |    |                                |   |    |              |
| PFC error (A12, 18, 24NHA)<br>(Overvoltage/Undervoltage/Overcurrent) | Power circuit board   | 10   |             |                 |         |        |   |    |                   |                     |    |                    |                          |    |   |                          |    |                                   |                     |    |  |                     |    |                                |   |    |              |
| PFC/ACTM error<br>Undervoltage                                       | Check CNAF wiring.<br>Defective ACTM/P.B.   | 20   |             |                 |         |        |   |    |                   |                     |    |                    |                          |    |   |                          |    |                                   |                     |    |  |                     |    |                                |   |    |              |

The black square (■) indicates a switch position.

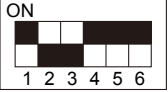
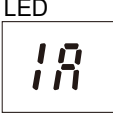
| SW2 setting  | Display detail  | Explanation for display   | Unit    |  |   |                         |   |                           |         |  |   |  |   |   |   |                             |   |   |              |
|--|---|---|---------|--|---|-------------------------|---|---------------------------|---------|--|---|--|---|---|---|-----------------------------|---|---|--------------|
|  | Controlling status of compressor operating frequency                        | <p>The following code will be a help to know the operating status of unit.</p> <ul style="list-style-type: none"> <li>•The tens digit</li> </ul> <table border="1" data-bbox="762 346 1302 440"> <thead> <tr> <th>Display</th> <th>Compressor operating frequency control</th> </tr> </thead> <tbody> <tr> <td>1</td> <td>Primary current control</td> </tr> <tr> <td>2</td> <td>Secondary current control</td> </tr> </tbody> </table> <ul style="list-style-type: none"> <li>•The ones digit (In this digit, the total number of activated control is displayed.)</li> </ul> <table border="1" data-bbox="762 517 1302 759"> <thead> <tr> <th>Display</th> <th>Compressor operating frequency control</th> </tr> </thead> <tbody> <tr> <td>1</td> <td>Preventive control for excessive temperature rise of discharge temperature</td> </tr> <tr> <td>2</td> <td>Preventive control for excessive temperature rise of condensing temperature</td> </tr> <tr> <td>4</td> <td>Frosting preventing control</td> </tr> <tr> <td>8</td> <td>Preventive control for excessive temperature rise of heatsink</td> </tr> </tbody> </table> <p>(Example)<br/>The following controls are activated.</p> <ul style="list-style-type: none"> <li>• Primary current control</li> <li>• Preventive control for excessive temperature rise of condensing temperature</li> <li>• Preventive control for excessive temperature rise of heatsink</li> </ul>  | Display | Compressor operating frequency control | 1 | Primary current control | 2 | Secondary current control | Display | Compressor operating frequency control | 1 | Preventive control for excessive temperature rise of discharge temperature | 2 | Preventive control for excessive temperature rise of condensing temperature | 4 | Frosting preventing control | 8 | Preventive control for excessive temperature rise of heatsink | Code display |
| Display  | Compressor operating frequency control                                      |   |         |  |   |                         |   |                           |         |  |   |  |   |   |   |                             |   |   |              |
| 1  | Primary current control   |   |         |  |   |                         |   |                           |         |  |   |  |   |   |   |                             |   |   |              |
| 2  | Secondary current control   |   |         |  |   |                         |   |                           |         |  |   |  |   |   |   |                             |   |   |              |
| Display  | Compressor operating frequency control                                      |   |         |  |   |                         |   |                           |         |  |   |  |   |   |   |                             |   |   |              |
| 1  | Preventive control for excessive temperature rise of discharge temperature  |   |         |  |   |                         |   |                           |         |  |   |  |   |   |   |                             |   |   |              |
| 2  | Preventive control for excessive temperature rise of condensing temperature |   |         |  |   |                         |   |                           |         |  |   |  |   |   |   |                             |   |   |              |
| 4  | Frosting preventing control   |   |         |  |   |                         |   |                           |         |  |   |  |   |   |   |                             |   |   |              |
| 8  | Preventive control for excessive temperature rise of heatsink               |   |         |  |   |                         |   |                           |         |  |   |  |   |   |   |                             |   |   |              |

# 11

# EASY MAINTENANCE FUNCTION

## 11-1. SMOOTH MAINTENANCE

### 11-1-1. PAR-30MAA/PAR-31MAA

Maintenance data, such as the indoor/outdoor unit's heat exchanger temperature and compressor operation current can be displayed with "Smooth maintenance".

**This cannot be executed during test operation.**

**Depending on the combination with the outdoor unit, this may not be supported by some models.**

Select "Service" from the Main menu, and press the  button.



Select "Check" with the **F1** or **F2** button, and press the  button.



Select "Smooth maintenance" with the **F1** or **F2** button, and press the  button.

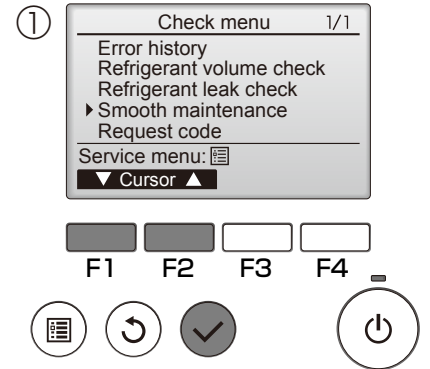

Set each item.

Select the item to be changed with the **F1** or **F2** button.

Select the required setting with the **F3** or **F4** button.

- <Ref.address>setting [ 0 ] to [ 15 ]
- <Stable mode>setting [ Cool ] / [ Heat ] / [ Normal ]

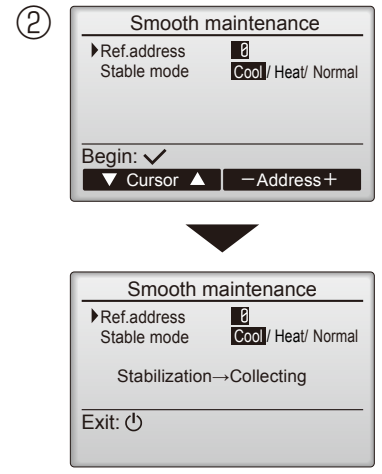

Press the  button, Fixed operation will start.



Note: Stable mode will take approx. 20 minutes.

The operation data will appear.

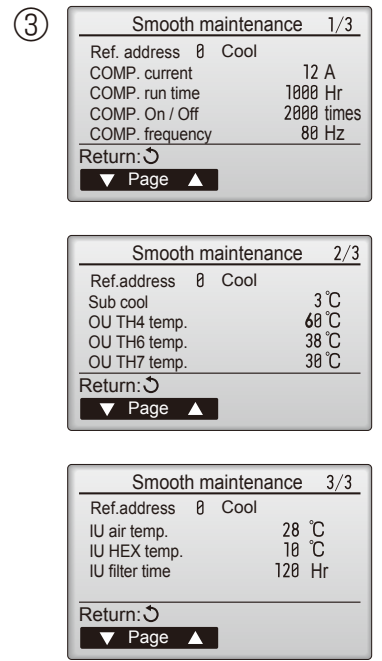
- The Compressor-Accumulated operating (COMP. run) time is 10-hour unit, and the Compressor-Number of operation times (COMP. ON/OFF) is a 100-time unit (fractions discarded).



**Navigating through the screens**

- To go back to the Main menu .....  button
- To return to the previous screen .....  button

● **Data measurement**

When the operation is stabilized, measure operation data as explained below.

➤(4) Press the [TEMP] buttons ( and ) to select the desired refrigerant address.



➤(5) Select the type of data to be displayed.  
After selecting, go to step (6).

**Compressor information**

button

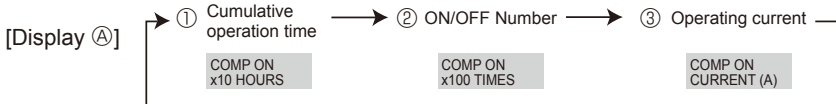

**Outdoor unit information**

button

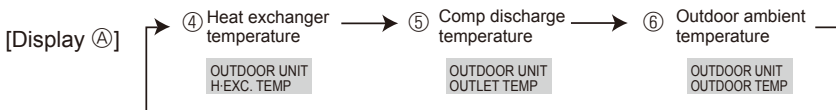

**Indoor unit information**

button

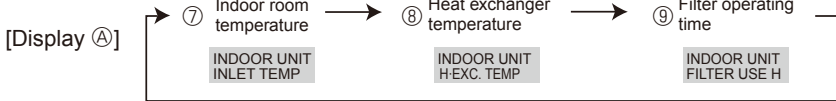

(6) Press the **[FILTER]** () button to confirm the setting.

[Display example for accumulated operating time]

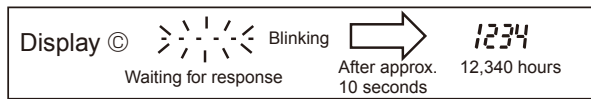

(7) Data is displayed on the display (at ).

**To check the data for each item, repeat steps (5) to (7).**

(8) To cancel maintenance mode, press the **[TEST]** button for 3 seconds or press the button.

■ **Refrigerant address**

Single refrigerant system

In the case of single refrigerant system, the refrigerant address is "00" and no operation is required.  
Simultaneous twin, triple units belong to this category (single refrigerant system).

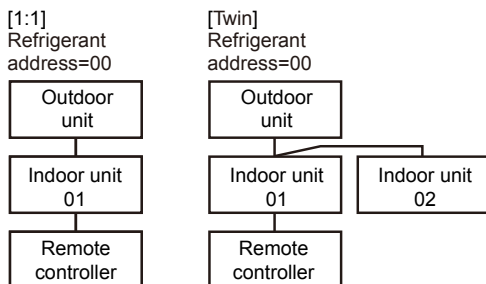

Multi refrigerant system (group control)

Up to 16 refrigerant systems (16 outdoor units) can be connected as a group by 1 remote controller. To check or set the refrigerant addresses.

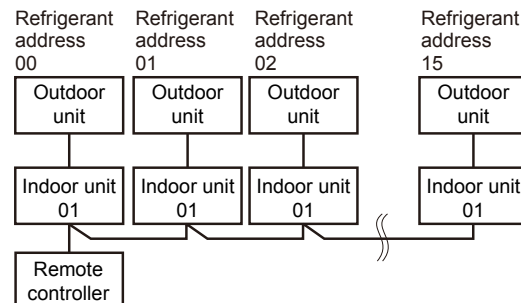

## 11-2.GUIDE FOR OPERATION CONDITION

|                 |                  | Inspection item                          |                 | Result            |             |
|-----------------|------------------|--|-----------------|-------------------|-------------|
| Power supply    | Loose connection | Terminal block                           | Breaker         | Good              | Retightened |
|                 |                  |  | Outdoor Unit    | Good              | Retightened |
|                 |                  |  | Indoor Unit     | Good              | Retightened |
|                 |                  | (Insulation resistance)                  |                 | MΩ                |             |
|                 |                  | (Voltage)                                |                 | V                 |             |
| Compressor      |                  | ① Accumulated operating time             |                 | Time              |             |
|                 |                  | ② Number of ON/OFF times                 |                 | Times             |             |
|                 |                  | ③ Current                                |                 | A                 |             |
| Outdoor Unit    | Temperature      | ④ Refrigerant/heat exchanger temperature | COOL °F HEAT °F |                   |             |
|                 |                  | ⑤ Refrigerant/discharge temperature      | COOL °F HEAT °F |                   |             |
|                 |                  | ⑥ Air/outside air temperature            | COOL °F HEAT °F |                   |             |
|                 |                  | (Air/discharge temperature)              | COOL °F HEAT °F |                   |             |
|                 | Cleanliness      | Appearance                               | Good            | Cleaning required |             |
|                 |                  | Heat exchanger                           | Good            | Cleaning required |             |
| Sound/vibration |                  | None                                     | Present         |                   |             |
| Indoor Unit     | Temperature      | ⑦ Air/intake air temperature             | COOL °F HEAT °F |                   |             |
|                 |                  | (Air/discharge temperature)              | COOL °F HEAT °F |                   |             |
|                 |                  | ⑧ Refrigerant/heat exchanger temperature | COOL °F HEAT °F |                   |             |
|                 |                  | ⑨ Filter operating time*                 |                 | Time              |             |
|                 | Cleanliness      | Decorative panel                         | Good            | Cleaning required |             |
|                 |                  | Filter                                   | Good            | Cleaning required |             |
|                 |                  | Fan                                      | Good            | Cleaning required |             |
|                 |                  | Heat exchanger                           | Good            | Cleaning required |             |
|                 |                  | Sound/vibration                          | None            | Present           |             |

\* The filter operating time is the time that has elapsed since the filter was reset.

### Check Points

Enter the temperature differences between ⑤, ④, ⑦ and ⑧ into the graph given below.

Operation state is determined according to the plotted areas on the graph.

For data measurements, set the fan speed to "Hi" before activating maintenance mode.

| Classification | Item                   | Result  |                 |
|----------------|------------------------|---|-----------------|
| Cool           | Inspection             | Is "000" displayed stably in Display ⑩ on the remote controller?          | Stable Unstable |
|                | Temperature difference | (⑤ Discharge temperature) – (④ Outdoor heat exchanger temperature)        | °F              |
|                |                        | (⑦ Indoor intake air temperature) – (⑧ Indoor heat exchanger temperature) | °F              |
| Heat           | Inspection             | Is "000" displayed stably in Display ⑩ on the remote controller?          | Stable Unstable |
|                | Temperature difference | (⑤ Discharge temperature) – (⑧ Indoor heat exchanger temperature)         | °F              |
|                |                        | (⑧ Indoor heat exchanger temperature) – (⑦ Indoor intake air temperature) | °F              |

Notes:

1. Fixed Hz operation may not be possible under the following temperature ranges.

A) In cool mode, outdoor intake air temperature is 104°F or higher or indoor intake air temperature is 73°F or lower.

B) In heat mode, outdoor intake air temperature is 68°F or higher or indoor intake air temperature is 77°F or lower.

2. If the air conditioner is operated at a temperature range other than the ones above but operation is not stabilized after 30 minutes or more have elapsed, carry out inspection.

3. In heat mode, the operation state may vary due to frost forming on the outdoor heat exchanger.

| Area              | Check item   | Judgment |      |
|-------------------|--|----------|------|
|                   |  | Cool     | Heat |
| Normal            | Normal operation state                                     |          |      |
| Filter inspection | Filter may be clogged.*                                    |          |      |
| Inspection A      | Performance has dropped. Detailed inspection is necessary. |          |      |
| Inspection B      | Refrigerant amount is dropping.                            |          |      |
| Inspection C      | Filter or indoor heat exchanger may be clogged.            |          |      |

Note: The above judgment is just guide based on Japanese standard conditions. It may be changed depending on the indoor and outdoor temperature.

\* It may be judged as "filter inspection" due to the outdoor and indoor temperature, even though it is not clogged.

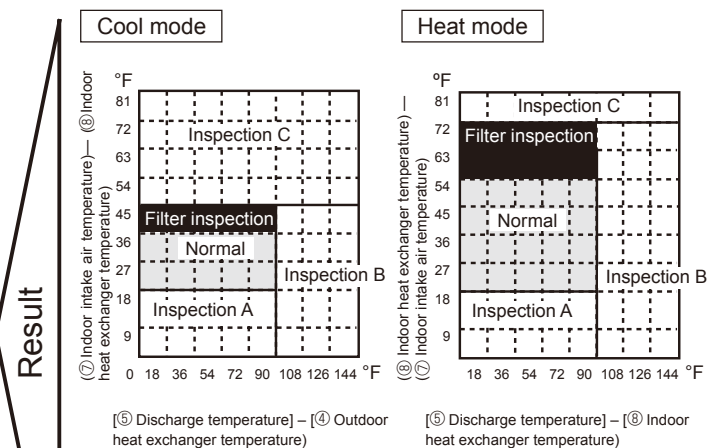

## 11-3. INITIAL SETTINGS FOR REFRIGERANT LEAKAGE DETECTION FUNCTION

### 11-3-1. PAR-30MAA/PAR-31MAA

Refrigerant leakage is detected after a long time.

To enable this function, the refrigerant volume must be saved (initial learning) after installation. Always operate this function in the following manners after installation.

- Always perform test run before using this function, and confirm that the air conditioner operates normally.
- To accurately detect refrigerant leaks, set the wind speed to strong, and execute this operation.

"Refrigerant leak check" is valid only with models which support the refrigerant leak check function.

- ① Select "Service" from the Main menu, and press the  button.



Select "Check" with the **F1** or **F2** button, and press the  button.



Select "Refrigerant leak check" with the **F1** or **F2** button, and press the  button.

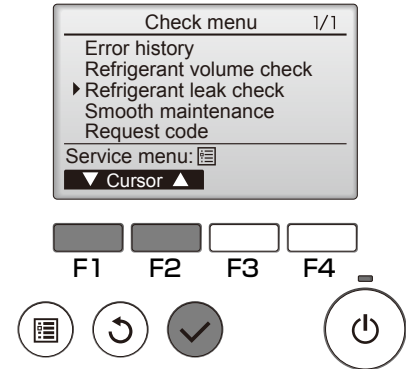

- ② Stable mode will start.

Press the  button, stable mode(\*) will start.

\*Stable mode will take approx. 20 minutes.

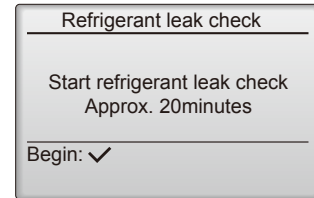

- ③ The operation data will appear.

The following value is the reference for the refrigerant volume check. If the refrigerant is leaking, "NG" will appear.

The refrigerant volume check reference value can be changed with the function selection.

**Default value RP71 – : 80%**  
**– RP50 : 70%**

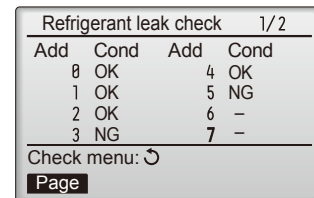

#### <Resetting the initial learning data>

- If the unit has been relocated or if refrigerant has been additionally charged, the initial learning data must be reset and learning performed again.

How to reset the data:

1. Turn the main power OFF.
2. Attach the short-circuit pin for the emergency operation connector (CN31) on the outdoor controller board to the ON side.
3. Turn ON the test run switch (SW4-1) on the outdoor controller board.
4. The data will be reset when the main power is turned ON.
5. Turn the main power OFF.
6. Turn OFF the test run switch (SW4-1).
7. Return the short-circuit pin for the emergency operation connector (CN31) to the OFF side.

- Under the following conditions, it may not be possible to carry out stable operation or accurately detect refrigerant leaks.
  - When the outdoor intake temperature is 40°C or higher, or when the indoor intake temperature is 23°C or less.
  - When the indoor fan speed is not set to strong.

12-1. UNIT FUNCTION SETTING BY THE REMOTE CONTROLLER

Each function can be set according to necessity using the remote controller. The setting of function for each unit can only be done by the remote controller. Select function available from the table 1.

(1) Functions available when setting the unit number to 00 (Select 00 referring to ④ setting the indoor unit number.)

<Table 1> Function selections

| Function                         | Settings  | Mode No.                                   | Setting No. | ● : Initial setting<br>(when sent from the factory) | Remarks   |
|----------------------------------|---|--|-------------|---|---|
|                                  |   | Wired remote controller<br>(RF thermistor) |             |   |   |
| Power failure automatic recovery | Not available   | 01   | 1           |   | The setting is applied to all the units in the same refrigerant system. |
|                                  | Available   | (101)                                      | 2           | ●   |   |
| Indoor temperature detecting     | Average data from each indoor unit                                  |  | 1           | ●   |   |
|                                  | Data from the indoor unit with remote controllers                   | 02   | 2           |   |   |
|                                  | Data from main remote controller                                    | (—)  | 3           |   |   |
| LOSSNAY connectivity             | Not supported   |  | 1           | ●   |   |
|                                  | Supported (indoor unit dose not intake outdoor air through LOSSNAY) | 03   | 2           |   |   |
|                                  | Supported (indoor unit intakes outdoor air through LOSSNAY)         | (103)                                      | 3           |   |   |
| Power supply voltage             | 230V  | 04   | 1           | ●   |   |
|                                  | 208V  | (104)                                      | 2           |   |   |
| Frost prevention temperature     | 2°C [36°F] (Normal)   | 15   | 1           | ●   |   |
|                                  | 3°C [37°F]  | (115)                                      | 2           |   |   |
| Humidifier control               | When the compressor operates, the humidifier also operates.         | 16   | 1           | ●   |   |
|                                  | When the fan operates, the humidifier also operates.                | (116)                                      | 2           |   |   |
| Change of defrosting control     | Standard  | 17   | 1           | ●   |   |
|                                  | For high humidity   | (117)                                      | 2           |   |   |

Meaning of "Function setting"

Mode02 : indoor temperature detecting

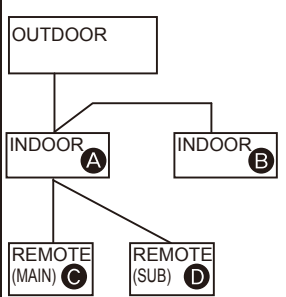
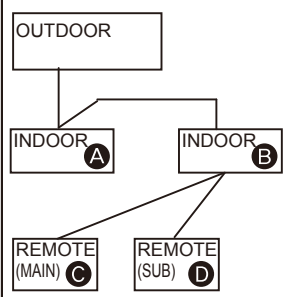
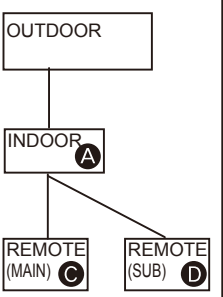
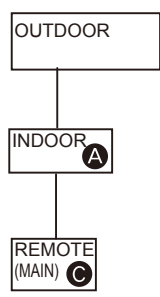
| No.  | Indoor temperature(ta)=   |                 |  |  |  |  |
|------|---|-----------------|---|--|---|---|
| No1. | Average data of the sensor on all the indoor units                          | Initial setting | ta=(A+B)/2  | ta=(A+B)/2   | ta=A  | ta=A  |
| No2. | Data of the sensor on the indoor unit that connected with remote controller |                 | ta=A  | ta=B   | ta=A  | ta=A  |
| No3. | Data of the sensor on main remote controller                                |                 | ta=C  | ta=C   | ta=C  | ta=C  |

- (2) Functions available when setting the unit number to 01-03 or AL (07 in case of IR wireless remote controller)
- When setting functions for an indoor unit in an independent system, set the unit number to 01 referring to ④ setting the indoor unit number.
  - When setting functions for a simultaneous twin indoor unit system, set the unit number to 01 to 03 for each indoor unit in case of selecting different functions for each unit referring to ④ setting the indoor unit number.
  - When setting the same functions for an entire simultaneous Twin-indoor unit system, set refrigerant address to AL (07 in case of IR wireless remote controller) referring to ④ setting the indoor unit number.

| Function   | Settings  | Mode No.<br>-----<br>Wired remote controller<br>(RF thermistor) | Setting No. | ● : Initial setting (Factory setting)<br>- : Not available |                   |              |           |
|--|---|---|-------------|--|-------------------|--------------|-----------|
|  |   |   |             | 4-Way cassette   | Ceiling suspended | Wall mounted |           |
|  |   |   |             | PLA-BA   | PCA-KA            | PKA-HA(L)    | PKA-KA(L) |
| Filter sign  | 100h  | 07<br>(107)   | 1           |  |                   | ●            | ●         |
|  | 2500h   |   | 2           | ●  | ●                 |              |           |
|  | "Clean the filter" indicator is not displayed   |   | 3           |  |                   |              |           |
| Air flow<br>(Fan speed)  | Quiet   | 08<br>(108)   | 1           |  |                   | -            |           |
|  | Standard  |   | 2           | ●  | ●                 | ●            | ●         |
|  | High ceiling                                    |   | 3           |  |                   |              | -         |
| No. of air outlets   | 4 directions                                    | 09<br>(109)   | 1           | ●  | -                 | -            | -         |
|  | 3 directions                                    |   | 2           |  | -                 | -            | -         |
|  | 2 directions                                    |   | 3           |  | -                 | -            | -         |
| Optional high efficiency filter  | Not supported                                   | 10<br>(110)   | 1           | ●  | ●                 | -            | -         |
|  | Supported                                       |   | 2           |  |                   | -            | -         |
| Vane setting   | No vanes (Vane No.3 setting : PLA only)         | 11<br>(111)   | 1           |  |                   | -            | -         |
|  | Vane No.1 setting                               |   | 2           | ●  | ●                 | -            | -         |
|  | Vane No.2 setting                               |   | 3           |  |                   | -            | -         |
| Optional humidifier<br>(PLA only)                                      | Not supported                                   | 13<br>(113)   | 1           | ●  | -                 | -            | -         |
|  | Supported                                       |   | 2           |  | -                 | -            | -         |
| Vane differential setting<br>in heating mode<br>(cold wind prevention) | No.1 setting (TH5: 75-82°F (24-28°C))           | 14<br>(114)   | 1           |  |                   |              |           |
|  | No.2 setting (Standard, TH5: 82-90°F (28-32°C)) |   | 2           | ●  | ●                 | ●            | ●         |
|  | No.3 setting (TH5: 90-100°F (32-38°C))          |   | 3           |  |                   |              |           |
| Swing  | Not available : Swing } PLA-BA                  | 23<br>(123)   | 1           |  |                   |              |           |
|  | Available : Wave air flow }                     |   | 2           | ●  | ●                 | ●            | ●         |
| Set temperature in heating mode (4 deg up) *1                          | Available                                       | 24<br>(124)   | 1           | ●  | ●                 | ●            | ●         |
|  | Not available                                   |   | 2           |  |                   |              |           |
| Fan speed when the heating thermostat is OFF                           | Extra low                                       | 25<br>(125)   | 1           | ●  | ●                 | ●            | ●         |
|  | Stop  |   | 2           |  |                   |              |           |
|  | Keeping fan speed set by remote controller      |   | 3           |  |                   |              |           |
| Fan speed when the cooling thermostat is OFF                           | Keeping fan speed set by remote controller      | 27<br>(127)   | 1           | ●  | ●                 | ●            | ●         |
|  | Stop  |   | 2           |  |                   |              |           |
| Detection of abnormality of the pipe temperature (P8)                  | Detect  | 28<br>(128)   | 1           | ●  | ●                 | ●            | ●         |
|  | Neglect   |   | 2           |  |                   |              |           |

\*1. PKA-HA(L)/KA(L): 3.6°F (2°C) up.

### Mode No.11

| Setting No. | Settings                      | PLA-BA   | PCA-KA  |
|-------------|-------------------------------|--|---|
| 1           | Vane No.3 setting<br>No Vanes | Less smudging<br>( Downward position than the standard ) | No vane function                                      |
| 2           | Vane No.1 setting             | Standard   | Standard  |
| 3           | Vane No.2 setting             | Less draft *<br>( Upward position than the standard )    | Less draft *<br>( Upward position than the standard ) |

\* Be careful of the smudge on ceiling.

### PEAD-AA

| Function  | Settings                 | Mode No.<br>-----<br>Wired remote controller<br>(RF thermistor) | Setting No.              | ● : Initial setting<br>(Factory setting) |
|---|--------------------------|---|--------------------------|--|
|   |                          |   |                          |  |
|   | 2500h                    | 2   |                          |  |
|   | No filter sign indicator | 3   | ●                        |  |
| External static pressure                              | 35/50/70/100/125Pa       | 08<br>(108)   | Refer to the right table |  |
|   |                          |   | 10<br>(110)              | Refer to the right table                 |
| Set temperature in heating mode (4 deg up)            | Available                | 24<br>(124)   | 1                        | ●  |
|   | Not available            |   | 2                        |  |
| Fan speed during the heating thermo OFF               | Extra low                | 25<br>(125)   | 1                        | ●  |
|   | Stop                     |   | 2                        |  |
|   | Set fan speed            |   | 3                        |  |
| Fan speed during the cooling thermo OFF               | Set fan speed            | 27<br>(127)   | 1                        | ●  |
|   | Stop                     |   | 2                        |  |
| Detection of abnormality of the pipe temperature (P8) | Available                | 28<br>(128)   | 1                        | ●  |
|   | Not available            |   | 2                        |  |

| External static pressure | Setting No.                                  |          | Initial setting<br>(Factory setting) |
|--------------------------|--|----------|--------------------------------------|
|                          | Mode No.<br>-----<br>Wired remote controller | 10 (110) |                                      |
| 35Pa                     | 2  | 1        |                                      |
| 50Pa                     | 3  | 1        | ●                                    |
| 70Pa                     | 1  | 2        |                                      |
| 100Pa                    | 2  | 2        |                                      |
| 125Pa                    | 3  | 2        |                                      |

12-1-1. Selecting functions using the wired remote controller <PAR-30MAA> <PAR-31MAA>

<Service menu>

**Maintenance password is required**

① Select "Service" from the Main menu, and press the  button.

\*At the main display, the menu button and select "Service" to make the maintenance setting.

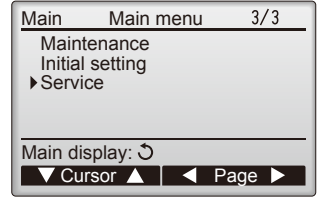

② When the Service menu is selected, a window will appear asking for the password.

To enter the current maintenance password (4 numerical digits), move the cursor to the digit you want to change with the **F1** or **F2** button.



Set each number (0 through 9) with the **F3** or **F4** button.



Then, press the  button.

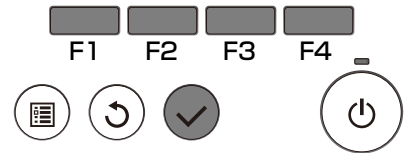
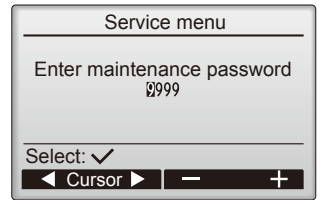

**Note:** The initial maintenance password is "9999". Change the default password as necessary to prevent unauthorized access. Have the password available for those who need it.

: If you forget your maintenance password, you can initialize the password to the default password "9999" by pressing and holding the **F1** and **F2** buttons simultaneously for three seconds on the maintenance password setting screen.

③ If the password matches, the Service menu will appear.

The type of menu that appears depends on the connected indoor units' type.

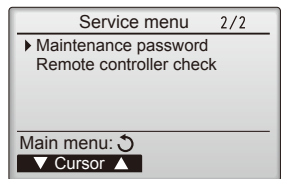
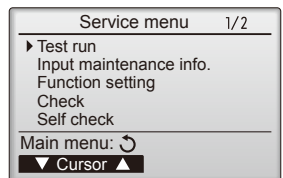



**Note:** Air conditioning units may need to be stopped to make certain settings. There may be some settings that cannot be made when the system is centrally controlled.



A screen will appear that indicates the setting has been saved.



**Navigating through the screens**

- To go back to the Main menu .....  button
- To return to the previous screen.....  button

## <Function setting>

- ① Select "Service" from the Main menu, and press the  button.



Select "Function setting" with the **F1** or **F2** button, and press the  button.

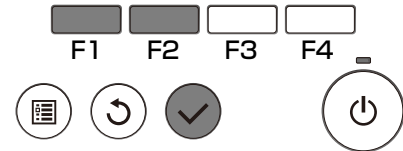
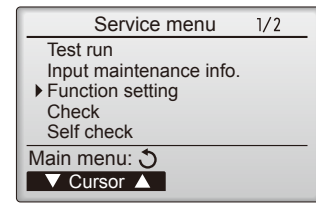

- ② Set the indoor unit refrigerant addresses and unit numbers with the **F1** through **F4** buttons, and then press the  button to confirm the current setting.

### <Checking the indoor unit No.>

When the  button is pressed, the target indoor unit will start fan operation. If the unit is common or when running all units, all indoor units for the selected refrigerant address will start fan operation.

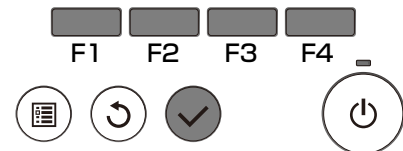
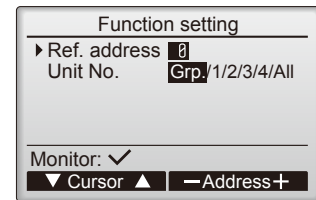

- ③ When data collection from the indoor units is completed, the current settings appears highlighted. Non-highlighted items indicate that no function settings are made. Screen appearance varies depending on the "Unit No." setting.

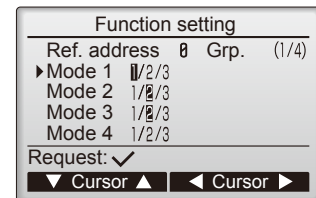

- ④ Use the **F1** or **F2** button to move the cursor to select the mode number, and change the setting number with the **F3** or **F4** button.

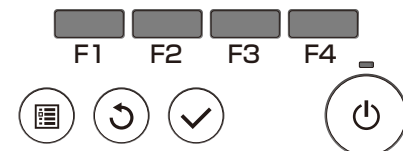
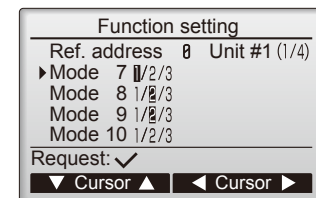

- ⑤ When the settings are completed, press the  button to send the setting data from the remote controller to the indoor units. When the transmission is successfully completed, the screen will return to the Function setting screen.

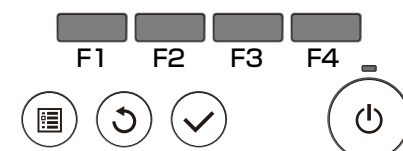
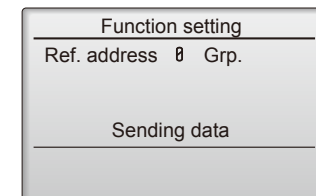

**Note:**

- Make the above settings only on Mr. Slim units as necessary.
- The above function settings are not available for the City Multi units.
- Table 1 summarizes the setting options for each mode number. Refer to the indoor unit Installation Manual for the detailed information about initial settings, mode numbers, and setting numbers for the indoor units.
- Be sure to write down the settings for all functions if any of the initial settings has been changed after the completion of installation work.

## [Operating Procedure]

- ① Check the setting items provided by function selection.  
If settings for a mode are changed by function selection, the functions of that mode will be changed accordingly. Check all the current settings according to steps ② to ⑦, fill in the "Check" column in Table 1, then change them as necessary. For initial settings, refer to the indoor unit's installation manual.

- ② Switch off the remote controller.

- Ⓐ Hold down the **(FILTER)** (mode is 15 to 28) and **(TEST)** buttons simultaneously for at least 2 seconds. **FUNCTION SELECTION** will start to blink, then the remote controller's display content will change as shown below.

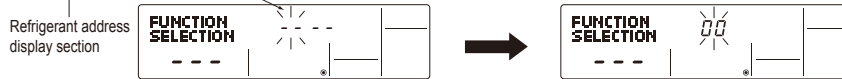

If the unit stops after **FUNCTION SELECTION** blinked for 2 seconds or "88" blinks in the room temperature display area for 2 seconds, a transmission error may have occurred. Check to see if there are any sources of noise or interference near the transmission path.

Note: If you have made operational mistakes during this procedure, exit function selection (see step ⑩), then restart from step ②.

- ④ Set the indoor unit number.

- Ⓓ Press the **(ON/OFF)** button so that "-" blinks in the unit number display area.



- ③ Set the outdoor unit's refrigerant address.

- Ⓒ Press the **(CLOCK)** buttons (**(DOWN)** and **(UP)**) to select the desired refrigerant address. The refrigerant address changes from "00" to "15". (This operation is not possible for single refrigerant systems.)

- Ⓒ Press the **(CLOCK)** buttons (**(DOWN)** and **(UP)**) to select the unit number of the indoor unit for which you want to perform function selection. The unit number changes to "00", "01", "02", "03", "04" and "AL" each time a button is pressed.

To set modes 01 to 06 or 15 to 22, select unit number "00".

To set modes 07 to 14 or 23 to 28, carry out as follows:

To set each indoor unit individually, select "01" to "04".

To set all the indoor units collectively, select "AL".

- ⑤ Confirm the refrigerant address and unit number.

- Ⓔ Press the **(MODE)** button to confirm the refrigerant address and unit number. After a while, "-" will start to blink in the mode number display area.



"88" will blink in the room temperature display area if the selected refrigerant address does not exist in the system.

Furthermore, if "F" appears and blinks in the unit number display area and the refrigerant address display area also blinks, there are no units that correspond to the selected unit number. In this case, the refrigerant address and unit number may be incorrect, so repeat steps ② and ③ to set the correct ones.

- Ⓔ When the refrigerant address and unit number are confirmed by pressing the **(MODE)** button, the corresponding indoor unit will start fan operation. This helps you find the location of the indoor unit for which you want to perform function selection. However, if "00" or "AL" is selected as the unit number, all the indoor units corresponding to the specified refrigerant address will start fan operation.

Example: When the refrigerant address is set to 00 and the unit number is 02.

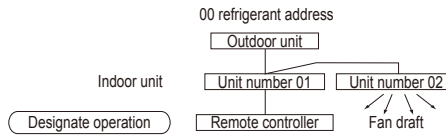

When grouping different refrigerant systems, if an indoor unit other than the one to which the refrigerant address has been set to perform fan operation, there may be another refrigerant address that is the same as the specified one. In this case, check the DIP switch of the outdoor unit to see whether such a refrigerant address exists.

- ⑥ Select the mode number.

- Ⓕ Press the **(TEMP)** buttons (**(DOWN)** and **(UP)**) to set the desired mode number. (Only the selectable mode numbers can be selected.)

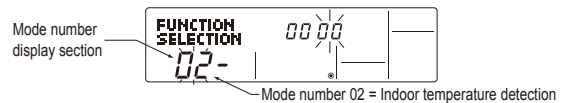

- ⑦ Select the setting content for the selected mode.

- Ⓖ Press the **(MENU)** button. The currently selected setting number will blink, so check the currently set content.

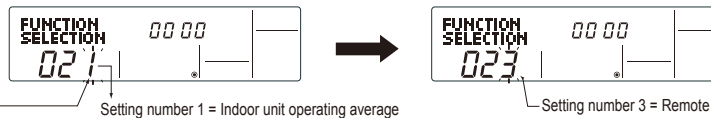

- ⑧ Register the settings you have made in steps ③ to ⑦.

- Ⓗ Press the **(MODE)** button. The mode number and setting number will start to blink and registration starts.

The mode number and setting number will stop blinking and remain lit, indicating the end of registration.



If "-" is displayed for both the mode number and setting number and "88" blinks in the room temperature display area, a transmission error may have occurred. Check to see if there are any sources of noise or interference near the transmission path.

- ⑨ If you wish to continue to select other functions, repeat steps ③ to ⑧.

- ⑩ Complete function selection.

- Ⓐ Hold down the **(FILTER)** (mode is 15 to 28) and **(TEST)** buttons simultaneously for at least 2 seconds.

After a while, the function selection screen will disappear and the air conditioner OFF screen will reappear.

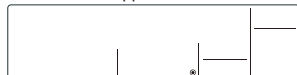

Do not operate the remote controller for at least 30 seconds after completing function selection. (No operations will be accepted even if they are made.)

Note:

If a function of an indoor unit is changed by function selection after installation is complete, make sure that a "O" mark, etc., is given in the "Check" column of Table 1 to indicate the change.

## 12-1-2. Selecting functions using the IR wireless remote controller (Type C)

Functions can be selected with the IR wireless remote controller. Function selection using IR wireless remote controller is available only for refrigerant system with wireless function. Refrigerant address cannot be specified by the IR wireless remote controller.

### [Flow of function selection procedure]

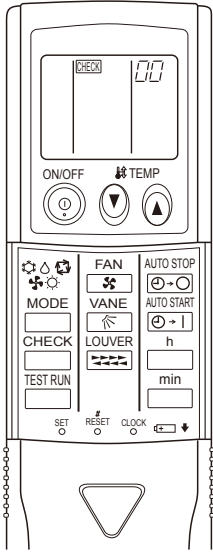

The flow of the function selection procedure is shown below. This example shows how to turn off the function that raises the set temperature by 4 degrees during HEAT operation. The procedure is given after the flow chart.

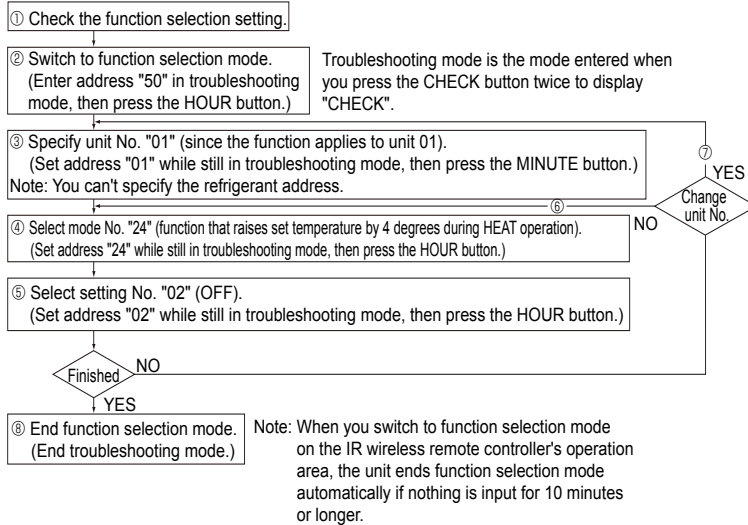

### [Operating instructions]

- ① Check the function settings.
- ② Press the button twice continuously. → is lit and "00" blinks. Press the TEMP button once to set "50". Direct the IR wireless remote controller toward the receiver of the indoor unit and press the button.

- ③ Set the unit number. Press the TEMP button to set the unit number. (Press "01" to specify the indoor unit whose unit number is 01.) Direct the IR wireless remote controller toward the receiver of the indoor unit and press the button.

(By setting unit number with the button, specified indoor unit starts performing fan operation. Detect which unit is assigned to which number using this function. If unit number is set to AL, all the indoor units in same refrigerant system start performing fan operation simultaneously.)

Notes:

1. If a unit number that cannot be recognized by the unit is entered, 3 beeps of 0.4 seconds will be heard. Reenter the unit number setting.
2. If the signal was not received by the sensor, you will not hear a beep or a "double ping sound" may be heard. Reenter the unit number setting.

- ④ Select a mode.

Press the TEMP button to set a mode. Press "24" to turn on the function that raises the set temperature by 4 degrees during heat operation. Direct the IR wireless remote controller toward the sensor of the indoor unit and press the button. → The sensor-operation indicator will blink and beeps will be heard to indicate the current setting number.

Current setting number: 1 = 1 beep (one second)  
2 = 2 beeps (one second each)  
3 = 3 beeps (one second each)

Notes:

1. If a mode number that cannot be recognized by the unit is entered, 3 beeps of 0.4 seconds will be heard. Reenter the mode number.
2. If the signal was not received by the sensor, you will not hear a beep or a "double ping sound" may be heard. Reenter the mode number.

- ⑤ Select the setting number.

Press the TEMP button to select the setting number. (02: Not available) Direct the IR wireless remote controller toward the receiver of the indoor unit and press the button. → The sensor-operation indicator will blink and beeps will be heard to indicate the setting number.

Setting number: 1 = 2 beeps (0.4 seconds each)  
2 = 2 beeps (0.4 seconds each, repeated twice)  
3 = 2 beeps (0.4 seconds each, repeated 3 times)

Notes:

1. If a setting number that cannot be recognized by the unit is entered, the setting will turn back to the original setting.
2. If the signal was not received by the sensor, you will not hear a beep or a "double ping sound" may be heard. Reenter the setting number.

- ⑥ Repeat steps ④ and ⑤ to make an additional setting without changing unit number.

- ⑦ Repeat steps ③ to ⑤ to change unit number and make function settings on it.

- ⑧ Complete the function settings

Press button.

Note: Do not use the IR wireless remote controller for 30 seconds after completing the function setting.

## 12-2. FUNCTION SELECTION OF REMOTE CONTROLLER

### 12-2-1. PAR-30MAA/PAR-31MAA

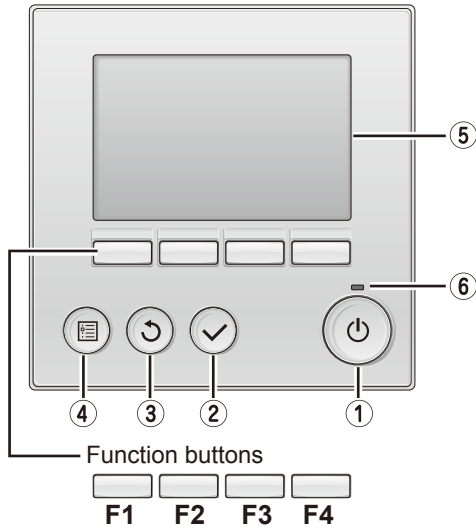

#### ① ON/OFF button

Press to turn ON/OFF the indoor unit.

#### ② SELECT button

Press to save the setting.

#### ③ RETURN button

Press to return to the previous screen.

#### ④ MENU button

Press to bring up the Main menu.

#### ⑤ Backlit LCD

Operation settings will appear.  
When the backlight is off, pressing any button turns the backlight on and it will stay lit for a certain period of time depending on the screen.

**When the backlight is off, pressing any button turns the backlight on and does not perform its function. (except for the  (ON/OFF) button)**

The functions of the function buttons change depending on the screen. Refer to the button function guide that appears at the bottom of the LCD for the functions they serve on a given screen.

When the system is centrally controlled, the button function guide that corresponds to the locked button will not appear.

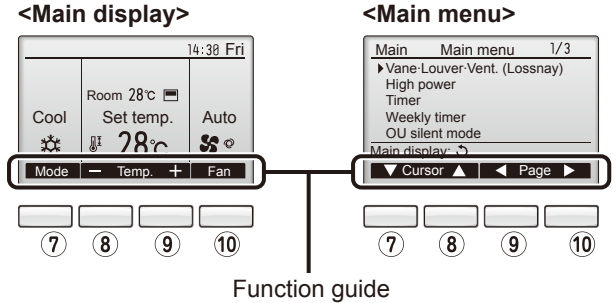

#### ⑥ ON/OFF lamp

This lamp lights up in green while the unit is in operation. It blinks while the remote controller is starting up or when there is an error.

#### ⑦ Function button **F1**

Main display : Press to change the operation mode.  
Main menu : Press to move the cursor down.

#### ⑧ Function button **F2**

Main display : Press to decrease temperature.  
Main menu : Press to move the cursor up.

#### ⑨ Function button **F3**

Main display : Press to increase temperature.  
Main menu : Press to go to the previous page.

#### ⑩ Function button **F4**

Main display : Press to change the fan speed.  
Main menu : Press to go to the next page.

## Menu structure

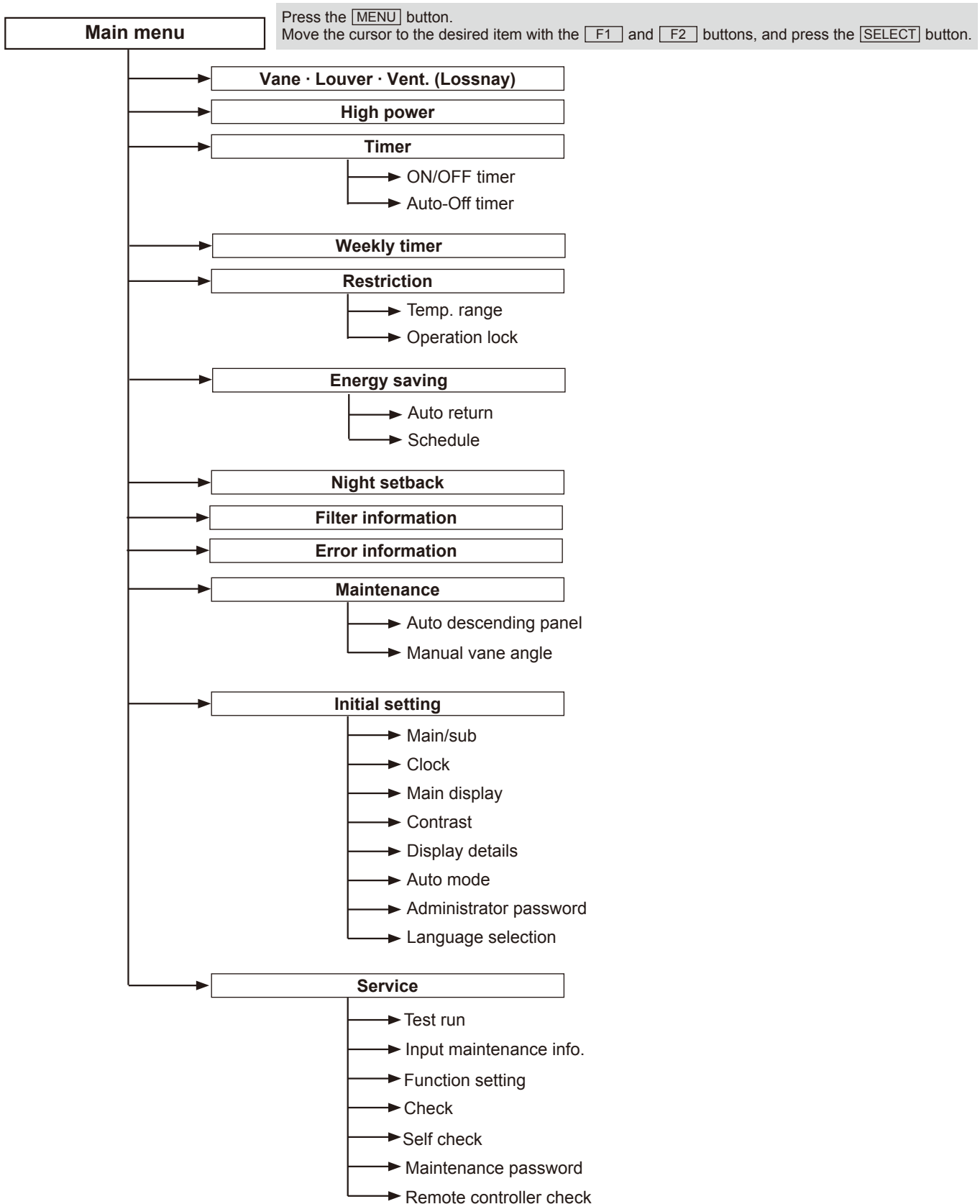



Not all functions are available on all models of indoor units.

## Main menu list

| Setting and display items       |                         | Setting details  |
|---------------------------------|-------------------------|--|
| Vane · Louver · Vent. (Lossnay) |                         | <p>Use to set the vane angle.</p> <ul style="list-style-type: none"> <li>• Select a desired vane setting from five different settings.</li> </ul> <p>Use to turn ON/OFF the louver.</p> <ul style="list-style-type: none"> <li>• Select a desired setting from "ON" and "OFF."</li> </ul> <p>Use to set the amount of ventilation.</p> <ul style="list-style-type: none"> <li>• Select a desired setting from "Off," "Low," and "High."</li> </ul> |
| High power                      |                         | <p>Use to reach the comfortable room temperature quickly.</p> <ul style="list-style-type: none"> <li>• Units can be operated in the High-power mode for up to 30 minutes.</li> </ul>   |
| Timer                           | ON/OFF timer*           | <p>Use to set the operation ON/OFF times.</p> <ul style="list-style-type: none"> <li>• Time can be set in 5-minute increments.</li> </ul>  |
|                                 | Auto-Off timer          | <p>Use to set the Auto-Off time.</p> <ul style="list-style-type: none"> <li>• Time can be set to a value from 30 to 240 in 10-minute increments.</li> </ul>  |
| Weekly timer*                   |                         | <p>Use to set the weekly operation ON/OFF times.</p> <ul style="list-style-type: none"> <li>• Up to 8 operation patterns can be set for each day.<br/>(Not valid when the ON/OFF timer is enabled.)</li> </ul>   |
| Restriction                     | Temp. range             | <p>Use to restrict the preset temperature range.</p> <ul style="list-style-type: none"> <li>• Different temperature ranges can be set for different operation modes.</li> </ul>  |
|                                 | Operation lock          | <p>Use to lock selected functions.</p> <ul style="list-style-type: none"> <li>• The locked functions cannot be operated.</li> </ul>  |
| Energy saving                   | Auto return             | <p>Use to get the units to operate at the preset temperature after performing energy-save operation for a specified time period.</p> <ul style="list-style-type: none"> <li>• Time can be set to a value from 30 and 120 in 10-minute increments.<br/>(This function will not be valid when the preset temperature ranges are restricted.)</li> </ul>  |
|                                 | Schedule*               | <p>Set the start/stop times to operate the units in the energy-save mode for each day of the week, and set the energy-saving rate.</p> <ul style="list-style-type: none"> <li>• Up to 4 energy-save operation patterns can be set for each day.</li> <li>• Time can be set in 5-minute increments.</li> <li>• Energy-saving rate can be set to a value from 0% or 50 to 90% in 10% increments.</li> </ul>  |
| Night setback*                  |                         | <p>Use to make Night setback settings.</p> <ul style="list-style-type: none"> <li>• Select "Yes" to enable the setting, and "No" to disable the setting. The temperature range and the start/stop times can be set.</li> </ul>   |
| Filter information              |                         | <p>Use to check the filter status.</p> <ul style="list-style-type: none"> <li>• The filter sign can be reset.</li> </ul>   |
| Error information               |                         | <p>Use to check error information when an error occurs.</p> <ul style="list-style-type: none"> <li>• Check code, error source, refrigerant address, unit model, manufacturing number, contact information (dealer's phone number) can be displayed.<br/>(The unit model, manufacturing number, and contact information need to be registered in advance to be displayed.)</li> </ul>   |
| Maintenance                     | Auto descending panel   | Auto descending panel (Optional parts) Up / Down you can do.   |
|                                 | Manual vane angle       | Use to set the vane angle for each vane to a fixed position.   |
| Initial setting                 | Main/Sub                | When connecting two remote controllers, one of them needs to be designated as a sub controller.  |
|                                 | Clock                   | Use to set the current time.   |
|                                 | Main display            | Use to switch between "Full" and "Basic" modes for the Main display.<br>• The initial setting is "Full."   |
|                                 | Contrast                | Use to adjust screen contrast.   |
|                                 | Display details         | <p>Make the settings for the remote controller related items as necessary.</p> <p><b>Clock:</b> The initial settings are "Yes" and "24h" format.<br/> <b>Temperature:</b> Set either Celsius (°C) or Fahrenheit (°F).<br/> <b>Room temp. :</b> Set Show or Hide.<br/> <b>Auto mode:</b> Set the Auto mode display or Only Auto display.</p>  |
|                                 | Auto mode               | Whether or not to use the Auto mode can be selected by using the button.<br>This setting is valid only when indoor units with the Auto mode function are connected.  |
|                                 | Administrator password  | <p>The administrator password is required to make the settings for the following items.</p> <ul style="list-style-type: none"> <li>• Timer setting • Energy-save setting • Weekly timer setting</li> <li>• Restriction setting • Outdoor unit silent mode setting • Night set back</li> </ul>  |
|                                 | Language selection      | Use to select the desired language.  |
| Service                         | Test run                | <p>Select "Test run" from the Service menu to bring up the Test run menu.</p> <ul style="list-style-type: none"> <li>• Test run • Drain pump test run</li> </ul>   |
|                                 | Input maintenance       | <p>Select "Input maintenance Info." from the Service menu to bring up the Maintenance information screen. The following settings can be made from the Maintenance information screen.</p> <ul style="list-style-type: none"> <li>• Model name input • Serial No. input • Dealer information input</li> </ul>   |
|                                 | Function setting        | Make the settings for the indoor unit functions via the remote controller as necessary.  |
|                                 | Check                   | <p><b>Error history:</b> Display the error history and execute "delete error history".</p> <p><b>Refrigerant leak check:</b> Refrigerant leaks can be judged.</p> <p><b>Smooth maintenance:</b> The indoor and outdoor maintenance data can be displayed.</p> <p><b>Request code:</b> Details of the operation data including each thermistor temperature and error history can be checked.</p>  |
|                                 | Self check              | Error history of each unit can be checked via the remote controller.   |
|                                 | Maintenance password    | Use to change the maintenance password.  |
|                                 | Remote controller check | When the remote controller does not work properly, use the remote controller checking function to troubleshoot the problem.  |

\* Clock setting is required.

### 12-3. Function selection of IR wireless remote controller TEMPERATURE DISPLAY °C/°F SETTING (Change of temp mode from °F to °C)

- ① Press the set button with something sharp at the end. **MODEL SELECT** blinks.
- ② Press the  button. “°F” blinks.
- ③ Press the  button. “°C” blinks.
- ④ Press the set button with something sharp at the end. **MODEL SELECT** is lighted for 3 seconds, then turned off.

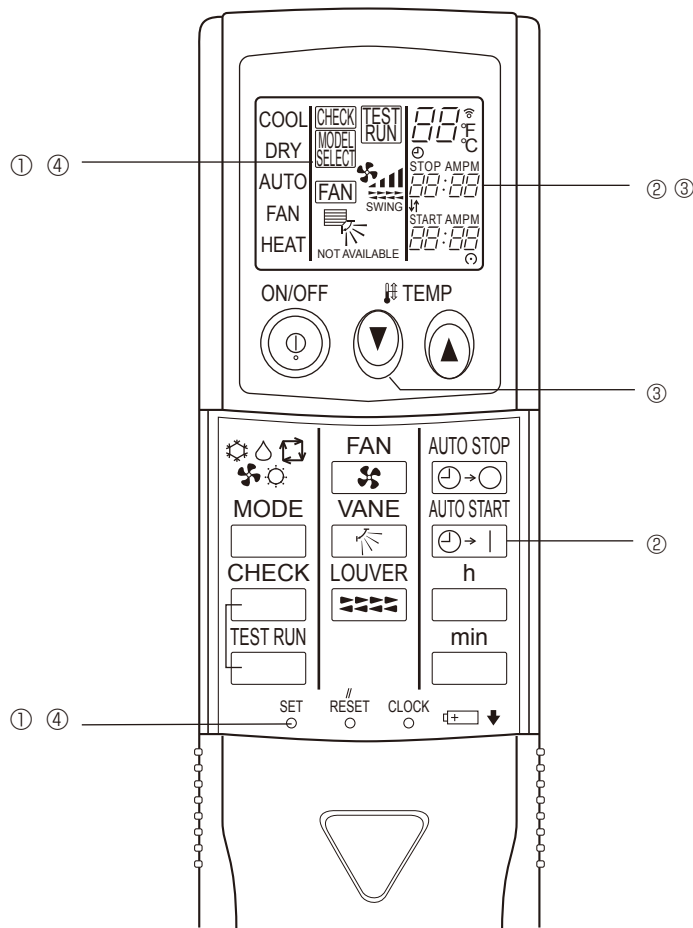







13-1. HOW TO "MONITOR THE OPERATION DATA"

13-1-1. PAR-30MAA/PAR-31MAA

Details on the operation data including each thermistor temperature and error history can be confirmed with the remote controller.

① Select "Service" from the Main menu, and press the  button.

Select "Check" with the  or  button, and press the  button.

Select "Request code" with the  or  button, and press the  button.

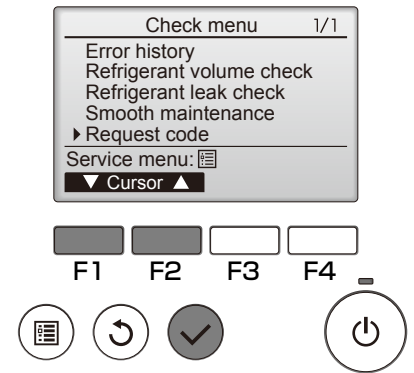

② Set the Refrigerant address and Request code.

Select the item to be changed with the  or  button.

Select the required setting with the  or  button.

- <Ref.address>setting [ 0 ] – [ 15 ]
- <Request code>setting

Press the  button, Data will be collected and displayed.

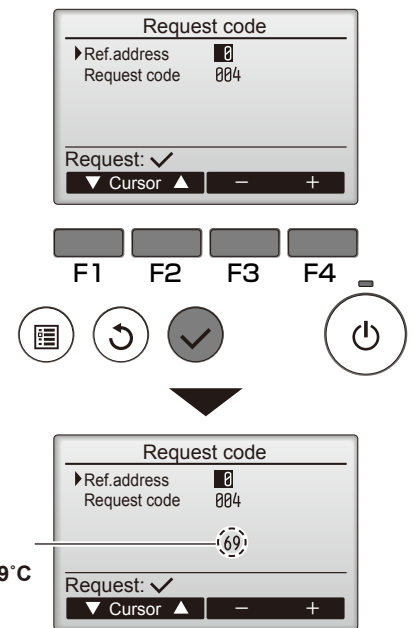

## 13-2. REQUEST CODE LIST

Certain indoor/outdoor combinations do not have the request code function; therefore, no request codes are displayed.

| Request code | Request content   | Description<br>(Display range)                    | Unit      | Remarks  |
|--------------|---|---|-----------|--|
| 0            | Operation state   | Refer to 13-2-1. Detail Contents in Request Code. | –         |  |
| 1            | Compressor-Operating current (rms)  | 0–50  | A         |  |
| 2            | Compressor-Accumulated operating time   | 0–9999  | 10 hours  |  |
| 3            | Compressor-Number of operation times  | 0–9999  | 100 times |  |
| 4            | Discharge temperature (TH32)  | 37–327  | °F        |  |
| 5            | Outdoor unit - Liquid pipe 1 temperature (TH3)                                  | –58–194   | °F        |  |
| 6            | Outdoor unit - Liquid pipe 2 temperature  | –40–194   | °F        |  |
| 7            | Outdoor unit-2-phase pipe temperature (TH6)                                     | –58–190   | °F        |  |
| 8            | Suction temperature (TH33)  | –58–194   | °F        |  |
| 9            | Outdoor unit-Outside air temperature (TH7)                                      | –58–190   | °F        |  |
| 10           | Outdoor unit-Heatsink temperature (TH8)   | –40–327   | °F        |  |
| 11           |   |   |           |  |
| 12           | Discharge super heat (SHd)  | 0–327   | °F        |  |
| 13           | Sub-cool (SC)   | 0–234   | °F        |  |
| 14           |   |   |           |  |
| 15           |   |   |           |  |
| 16           | Compressor-Operating frequency  | 0–255   | Hz        |  |
| 17           | Compressor-Target operating frequency   | 0–255   | Hz        |  |
| 18           | Outdoor unit-Fan output step  | 0–10  | Step      |  |
| 19           | Outdoor unit-Fan 1 speed<br>(Only for air conditioners with DC fan motor)       | 0–9999  | rpm       |  |
| 20           | Outdoor unit-Fan 2 speed<br>(Only for air conditioners with DC fan motor)       | 0–9999  | rpm       | "0" is displayed if the air conditioner is a single-fan type.    |
| 21           |   |   |           |  |
| 22           | LEV (A) opening   | 0–500   | Pulses    |  |
| 23           | LEV (B) opening   | 0–500   | Pulses    |  |
| 24           |   |   |           |  |
| 25           | Primary current   | 0–50  | A         |  |
| 26           | DC bus voltage  | 180–370   | V         |  |
| 27           |   |   |           |  |
| 28           |   |   |           |  |
| 29           | Number of connected indoor units  | 0–4   | Units     |  |
| 30           | Indoor unit-Setting temperature   | 62–86   | °F        |  |
| 31           | Indoor unit-Intake air temperature <Measured by thermostat>                     | 46–102  | °F        |  |
| 32           | Indoor unit-Intake air temperature (Unit No. 1)<br><Heat mode-4-deg correction> | 46–102  | °F        | "0" is displayed if the target unit is not present.              |
| 33           | Indoor unit-Intake air temperature (Unit No. 2)<br><Heat mode-4-deg correction> | 46–102  | °F        | ↑  |
| 34           | Indoor unit-Intake air temperature (Unit No. 3)<br><Heat mode-4-deg correction> | 46–102  | °F        | ↑  |
| 35           | Indoor unit-Intake air temperature (Unit No. 4)<br><Heat mode-4-deg correction> | 46–102  | °F        | ↑  |
| 36           |   |   |           |  |
| 37           | Indoor unit - Liquid pipe temperature (Unit No. 1)                              | –38–190   | °F        | "0" is displayed if the target unit is not present.              |
| 38           | Indoor unit - Liquid pipe temperature (Unit No. 2)                              | –38–190   | °F        | ↑  |
| 39           | Indoor unit - Liquid pipe temperature (Unit No. 3)                              | –38–190   | °F        | ↑  |
| 40           | Indoor unit - Liquid pipe temperature (Unit No. 4)                              | –38–190   | °F        | ↑  |
| 41           |   |   |           |  |
| 42           | Indoor unit-Cond./Eva. pipe temperature (Unit No. 1)                            | –38–190   | °F        | "0" is displayed if the target unit is not present.              |
| 43           | Indoor unit-Cond./Eva. pipe temperature (Unit No. 2)                            | –38–190   | °F        | ↑  |
| 44           | Indoor unit-Cond./Eva. pipe temperature (Unit No. 3)                            | –38–190   | °F        | ↑  |
| 45           | Indoor unit-Cond./Eva. pipe temperature (Unit No. 4)                            | –38–190   | °F        | ↑  |
| 46           |   |   |           |  |
| 47           |   |   |           |  |
| 48           | Thermo ON operating time  | 0–999   | Minutes   |  |
| 49           | Test run elapsed time   | 0–120   | Minutes   | ← Not possible to activate maintenance mode during the test run. |

| Request code | Request content  | Description<br>(Display range)  | Unit | Remarks |
|--------------|--|---|------|---------|
| 50           | Indoor unit-Control state                                  | Refer to 13-2-1.Detail Contents in Request Code.  | —    |         |
| 51           | Outdoor unit-Control state                                 | Refer to 13-2-1.Detail Contents in Request Code.  | —    |         |
| 52           | Compressor-Frequency control state                         | Refer to 13-2-1.Detail Contents in Request Code.  | —    |         |
| 53           | Outdoor unit-Fan control state                             | Refer to 13-2-1.Detail Contents in Request Code.  | —    |         |
| 54           | Actuator output state                                      | Refer to 13-2-1.Detail Contents in Request Code.  | —    |         |
| 55           | Error content (U9)   | Refer to 13-2-1.Detail Contents in Request Code.  | —    |         |
| 56           |  |   |      |         |
| 57           |  |   |      |         |
| 58           |  |   |      |         |
| 59           |  |   |      |         |
| 60           | Signal transmission demand capacity                        | 0–255   | %    |         |
| 61           | Contact demand capacity                                    | Refer to 13-2-1.Detail Contents in Request Code.  | —    |         |
| 62           | External input state (silent mode, etc.)                   | Refer to 13-2-1.Detail Contents in Request Code.  | —    |         |
| 63           |  |   |      |         |
| 64           |  |   |      |         |
| 65           |  |   |      |         |
| 66           |  |   |      |         |
| 67           |  |   |      |         |
| 68           |  |   |      |         |
| 69           |  |   |      |         |
| 70           | Outdoor unit-Capacity setting display                      | Refer to 13-2-1.Detail Contents in Request Code.  | —    |         |
| 71           | Outdoor unit-Setting information                           | Refer to 13-2-1.Detail Contents in Request Code.  | —    |         |
| 72           |  |   |      |         |
| 73           |  |   | —    |         |
| 74           |  |   | —    |         |
| 75           |  |   |      |         |
| 76           |  |   | —    |         |
| 77           |  |   | —    |         |
| 78           |  |   | —    |         |
| 79           |  |   | —    |         |
| 80           |  |   | —    |         |
| 81           |  |   | —    |         |
| 82           |  |   | —    |         |
| 83           |  |   |      |         |
| 84           | M-NET adapter connection (presence/absence)                | "0000": Not connected<br>"0001": Connected  | —    |         |
| 85           |  |   |      |         |
| 86           |  |   |      |         |
| 87           |  |   |      |         |
| 88           |  |   |      |         |
| 89           | Display of execution of replace/wash operation             | "0000": Not washed<br>"0001": Washed  | —    |         |
| 90           | Outdoor unit-Microprocessor version information            | Examples) Ver 5.01 → "0501"   | Ver  |         |
| 91           | Outdoor unit-Microprocessor version information (sub No.)  | Auxiliary information (displayed after version information)<br>Examples) Ver 5.01 A000 → "A000" | —    |         |
| 92           |  |   |      |         |
| 93           |  |   |      |         |
| 94           |  |   |      |         |
| 95           |  |   |      |         |
| 96           |  |   |      |         |
| 97           |  |   |      |         |
| 98           |  |   |      |         |
| 99           |  |   |      |         |
| 100          | Outdoor unit - Error postponement history 1 (latest)       | Displays postponement code. (" - - " is displayed if no postponement code is present)           | Code |         |
| 101          | Outdoor unit - Error postponement history 2 (previous)     | Displays postponement code. (" - - " is displayed if no postponement code is present)           | Code |         |
| 102          | Outdoor unit - Error postponement history 3 (last but one) | Displays postponement code. (" - - " is displayed if no postponement code is present)           | Code |         |

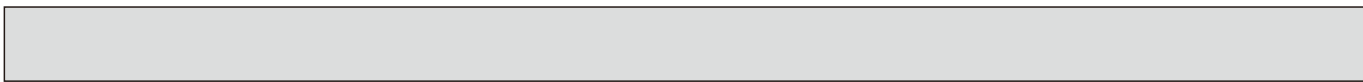

| Request code | Request content  | Description<br>(Display range)  | Unit             | Remarks  |
|--------------|--|---|------------------|--|
| 103          | Error history 1 (latest)   | Displays error history. ("--" is displayed if no history is present.) | Code             |  |
| 104          | Error history 2 (second to last)   | Displays error history. ("--" is displayed if no history is present.) | Code             |  |
| 105          | Error history 3 (third to last)  | Displays error history. ("--" is displayed if no history is present.) | Code             |  |
| 106          | Abnormal thermistor display<br>(TH3/TH6/TH7/TH8)                                       | 3 : TH3<br>6 : TH6<br>7 : TH7<br>8 : TH8<br>0 : No thermistor error   | Sensor<br>number |  |
| 107          | Operation mode at time of error  | Displayed in the same way as request code "0".                        | –                |  |
| 108          | Compressor-Operating current at time of error  | 0–50  | A                |  |
| 109          | Compressor-Accumulated operating time at time of error                                 | 0–9999  | 10 hours         |  |
| 110          | Compressor-Number of operation times at time of error                                  | 0–9999  | 100 times        |  |
| 111          | Discharge temperature at time of error   | 37–327  | °F               |  |
| 112          | Outdoor unit - Liquid pipe 1 temperature (TH3) at time of error                        | –40–194   | °F               |  |
| 113          | Outdoor unit - Liquid pipe 2 temperature at time of error                              | –40–194   | °F               |  |
| 114          | Outdoor unit-2-phase pipe temperature (TH6) at time of error                           | –38–194   | °F               |  |
| 115          |  |   |                  |  |
| 116          | Outdoor unit-Outside air temperature (TH7) at time of error                            | –38–194   | °F               |  |
| 117          | Outdoor unit-Heatsink temperature (TH8) at time of error                               | –40–327   | °F               |  |
| 118          | Discharge super heat (SHd) at time of error  | 0–327   | °F               |  |
| 119          | Sub-cool (SC) at time of error   | 0–234   | °F               |  |
| 120          | Compressor-Operating frequency at time of error  | 0–255   | Hz               |  |
| 121          | Outdoor unit at time of error<br>• Fan output step                                     | 0–10  | Step             |  |
| 122          | Outdoor unit at time of error<br>• Fan 1 speed (Only for air conditioners with DC fan) | 0–9999  | rpm              |  |
| 123          | Outdoor unit at time of error<br>• Fan 2 speed (Only for air conditioners with DC fan) | 0–9999  | rpm              | "0" is displayed if the air conditioner is a single-fan type.  |
| 124          |  |   |                  |  |
| 125          | LEV (A) opening at time of error   | 0–500   | Pulses           |  |
| 126          | LEV (B) opening at time of error   | 0–500   | Pulses           |  |
| 127          |  |   |                  |  |
| 128          |  |   |                  |  |
| 129          |  |   |                  |  |
| 130          | Thermo ON time until operation stops due to error                                      | 0–999   | Minutes          |  |
| 131          |  |   |                  |  |
| 132          | Indoor - Liquid pipe temperature at time of error                                      | –38–190   | °F               | Average value of all indoor units is displayed if the air conditioner consists of two or more indoor units (twin, triple, quad). |
| 133          | Indoor-Cond./Eva. pipe temperature at time of error                                    | –38–190   | °F               | Average value of all indoor units is displayed if the air conditioner consists of two or more indoor units (twin, triple, quad). |
| 134          | Indoor at time of error<br>• Intake air temperature <Thermostat judge temperature>     | –38–190   | °F               |  |
| 135          |  |   |                  |  |
| 136          |  |   |                  |  |
| 137          |  |   |                  |  |
| 138          |  |   |                  |  |
| 139          |  |   |                  |  |
| 140          |  |   |                  |  |
| ~            |  |   |                  |  |
| 146          |  |   |                  |  |
| 147          |  |   |                  |  |
| 148          |  |   |                  |  |
| 149          |  |   |                  |  |
| 150          | Indoor-Actual intake air temperature   | –38–190   | °F               |  |
| 151          | Indoor - Liquid pipe temperature   | –38–190   | °F               |  |
| 152          | Indoor-Cond./Eva. pipe temperature   | –38–190   | °F               |  |

| Request code | Request content  | Description<br>(Display range)  | Unit     | Remarks                               |
|--------------|--|---|----------|---------------------------------------|
| 153          |  |   |          |                                       |
| 154          | Indoor-Fan operating time<br>(After filter is reset)     | 0-9999  | 1 hour   |                                       |
| 155          | Indoor-Total operating time<br>(Fan motor ON time)       | 0-9999  | 10 hours |                                       |
| 156          |  |   |          |                                       |
| 157          | Indoor fan output value (Sj value)                       | 0-255 Fan control data  | -        | For indoor fan phase control          |
| 158          | Indoor fan output value<br>(Pulsation ON/OFF)            | "00 ***" **** indicates fan control data.   | -        | For indoor fan pulsation control      |
| 159          | Indoor fan output value (duty value)                     | "00 ***" **** indicates fan control data.   | -        | For indoor DC brushless motor control |
| 160          |  |   |          |                                       |
| 161          |  |   |          |                                       |
| 162          | Indoor unit-Model setting information                    | Refer to 13-2-1 Detail Contents in Request Code.  | -        |                                       |
| 163          | Indoor unit-Capacity setting information                 | Refer to 13-2-1 Detail Contents in Request Code.  | -        |                                       |
| 164          | Indoor unit-SW3 information                              | Undefined   | -        |                                       |
| 165          | Wireless pair No. (indoor control board side) setting    | Refer to 13-2-1 Detail Contents in Request Code.  | -        |                                       |
| 166          | Indoor unit-SW5 information                              | Undefined   | -        |                                       |
| 167          |  |   |          |                                       |
| ~            |  |   |          |                                       |
| 189          |  |   |          |                                       |
| 190          | Indoor unit-Microprocessor version information           | Examples) Ver 5.01 → "0501"   | Ver      |                                       |
| 191          | Indoor unit-Microprocessor version information (sub No.) | Auxiliary information (displayed after version information)<br>Examples) Ver 5.01 A000 → "A000"   | -        |                                       |
| 192          |  |   |          |                                       |
| ~            |  |   |          |                                       |
| 764          |  |   |          |                                       |
| 765          | Stable operation (Heat mode)                             | This request code is not provided to collect data. It is used to fix the operation state.   |          |                                       |
| 766          | Stable operation (Cool mode)                             | This request code is not provided to collect data. It is used to fix the operation state.   |          |                                       |
| 767          | Stable operation cancellation                            | This request code is not provided to collect data. It is used to cancel the operation state that has been fixed by request codes "765" and "766". |          |                                       |

### 13-2-1. Detail Contents in Request Code

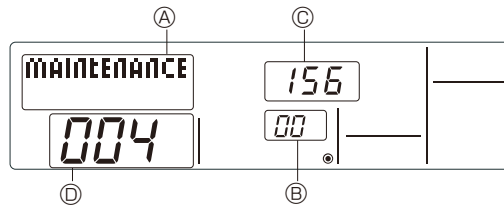

[ Example ) Request code "004"  
Discharge temperature 156°F  
Refrigerant address "00" ]

- A: Mode display
- B: Refrigerant address
- C: Data display area
- D: Request code display area

#### [Operation state] (Request code : "0")

Data display



Relay output state  
Operation mode

Operation mode

| Display | Operation mode |
|---------|----------------|
| 0       | STOP • FAN     |
| C       | COOL • DRY     |
| H       | HEAT           |
| d       | DEFROST        |

Relay output state

| Display | Power currently supplied to compressor | Compressor | Four-way valve | Solenoid valve |
|---------|--|------------|----------------|----------------|
| 0       | –                                      | –          | –              | –              |
| 1       |  |            |                | ON             |
| 2       |  |            | ON             |                |
| 3       |  |            | ON             | ON             |
| 4       |  | ON         |                |                |
| 5       |  | ON         |                | ON             |
| 6       |  | ON         | ON             |                |
| 7       |  | ON         | ON             | ON             |
| 8       | ON                                     |            |                |                |
| A       | ON                                     |            | ON             |                |

#### [Indoor unit – Control state] (Request code : "50")

Data display



Unit No. 4 state  
Unit No. 3 state  
Unit No. 2 state  
Unit No. 1 state

| Display | State                              |
|---------|------------------------------------|
| 0       | Normal                             |
| 1       | Preparing for heat operation.      |
| 2       | –                                  |
| 3       | –                                  |
| 4       | Heater is ON.                      |
| 5       | Anti-freeze protection is ON.      |
| 6       | Overheat protection is ON.         |
| 7       | Requesting compressor to turn OFF. |
| F       | There are no corresponding units.  |

#### [Outdoor unit – Control state] (Request code : "51")

| Data display | State                         |
|--------------|-------------------------------|
| 0 0 0 0      | Normal                        |
| 0 0 0 1      | Preparing for heat operation. |
| 0 0 0 2      | Defrost                       |

#### [Compressor – Frequency control state] (Request code : "52")

Data display

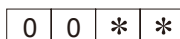

Frequency control state ②  
Frequency control state ①

Frequency control state ①

| Display | Current limit control                  |
|---------|--|
| 0       | No current limit                       |
| 1       | Primary current limit control is ON.   |
| 2       | Secondary current limit control is ON. |

Frequency control state ②

| Display | Discharge temperature overheat prevention | Condensation temperature overheat prevention | Anti-freeze protection control | Heatsink temperature overheat prevention |
|---------|---|--|--------------------------------|--|
| 0       |   |  |                                |  |
| 1       | Controlled                                |  |                                |  |
| 2       |   | Controlled                                   |                                |  |
| 3       | Controlled                                | Controlled                                   |                                |  |
| 4       |   |  | Controlled                     |  |
| 5       | Controlled                                |  | Controlled                     |  |
| 6       |   | Controlled                                   | Controlled                     |  |
| 7       | Controlled                                | Controlled                                   | Controlled                     |  |
| 8       |   |  |                                | Controlled                               |
| 9       | Controlled                                |  |                                | Controlled                               |
| A       |   | Controlled                                   |                                | Controlled                               |
| b       | Controlled                                | Controlled                                   |                                | Controlled                               |
| C       |   |  | Controlled                     | Controlled                               |
| d       | Controlled                                |  | Controlled                     | Controlled                               |
| E       |   | Controlled                                   | Controlled                     | Controlled                               |
| F       | Controlled                                | Controlled                                   | Controlled                     | Controlled                               |

**[Fan control state] (Request code : "53")**

Data display 0 0 \* \*

Fan step correction value by heatsink temperature overheat prevention control  
 Fan step correction value by cool condensation temperature overheat prevention control

| Display   | Correction value |
|-----------|------------------|
| - (minus) | - 1              |
| 0         | 0                |
| 1         | +1               |
| 2         | +2               |

**[Actuator output state] (Request code : "54")**

Data display 0 0 \* \*

Actuator output state ①  
 Actuator output state ②

Actuator output state ①

| Display | SV1 | Four-way valve | Compressor | Compressor is warming up |
|---------|-----|----------------|------------|--------------------------|
| 0       |     |                |            |                          |
| 1       | ON  |                |            |                          |
| 2       |     | ON             |            |                          |
| 3       | ON  | ON             |            |                          |
| 4       |     |                | ON         |                          |
| 5       | ON  |                | ON         |                          |
| 6       |     | ON             | ON         |                          |
| 7       | ON  | ON             | ON         |                          |
| 8       |     |                |            | ON                       |
| 9       | ON  |                |            | ON                       |
| A       |     | ON             |            | ON                       |
| b       | ON  | ON             |            | ON                       |
| C       |     |                | ON         | ON                       |
| d       | ON  |                | ON         | ON                       |
| E       |     | ON             | ON         | ON                       |
| F       | ON  | ON             | ON         | ON                       |

Actuator output state ②

| Display | 52C | SV2 | SS |
|---------|-----|-----|----|
| 0       |     |     |    |
| 1       | ON  |     |    |
| 2       |     | ON  |    |
| 3       | ON  | ON  |    |
| 4       |     |     | ON |
| 5       | ON  |     | ON |
| 6       |     | ON  | ON |
| 7       | ON  | ON  | ON |

**[Error content (U9)] (Request code : "55")**

Data display 0 0 \* \*

Error content ①  
 Error content ②

Error content ①

● : Detected

| Display | Oversvoltage error | Undersvoltage error | L1-phase open error | Power synchronizing signal error |
|---------|--------------------|---------------------|---------------------|----------------------------------|
| 0       |                    |                     |                     |                                  |
| 1       | ●                  |                     |                     |                                  |
| 2       |                    | ●                   |                     |                                  |
| 3       | ●                  | ●                   |                     |                                  |
| 4       |                    |                     | ●                   |                                  |
| 5       | ●                  |                     | ●                   |                                  |
| 6       |                    | ●                   | ●                   |                                  |
| 7       | ●                  | ●                   | ●                   |                                  |
| 8       |                    |                     |                     | ●                                |
| 9       | ●                  |                     |                     | ●                                |
| A       |                    | ●                   |                     | ●                                |
| b       | ●                  | ●                   |                     | ●                                |
| C       |                    |                     | ●                   | ●                                |
| d       | ●                  |                     | ●                   | ●                                |
| E       |                    | ●                   | ●                   | ●                                |
| F       | ●                  | ●                   | ●                   | ●                                |

Error content ②

● : Detected

| Display | Converter Fo error | PAM error |
|---------|--------------------|-----------|
| 0       |                    |           |
| 1       | ●                  |           |
| 2       |                    | ●         |
| 3       | ●                  | ●         |

**[Contact demand capacity] (Request code : "61")**

Data display 

|   |   |   |   |
|---|---|---|---|
| 0 | 0 | 0 | * |
|---|---|---|---|

 Setting content

Setting content

| Display | Setting value | Setting |       |
|---------|---------------|---------|-------|
|         |               | SW7-1   | SW7-2 |
| 0       | 0%            |         |       |
| 1       | 50%           | ON      |       |
| 2       | 75%           |         | ON    |
| 3       | 100%          | ON      | ON    |

**[External input state] (Request code : "62")**

Data display 

|   |   |   |   |
|---|---|---|---|
| 0 | 0 | 0 | * |
|---|---|---|---|

 Input state

Input state

● : Input present

| Display | Contact demand input | Silent mode input | Spare 1 input | Spare 2 input |
|---------|----------------------|-------------------|---------------|---------------|
| 0       |                      |                   |               |               |
| 1       | ●                    |                   |               |               |
| 2       |                      | ●                 |               |               |
| 3       | ●                    | ●                 |               |               |
| 4       |                      |                   | ●             |               |
| 5       | ●                    |                   | ●             |               |
| 6       |                      | ●                 | ●             |               |
| 7       | ●                    | ●                 | ●             |               |
| 8       |                      |                   |               | ●             |
| 9       | ●                    |                   |               | ●             |
| A       |                      | ●                 |               | ●             |
| b       | ●                    | ●                 |               | ●             |
| C       |                      |                   | ●             | ●             |
| d       | ●                    |                   | ●             | ●             |
| E       |                      | ●                 | ●             | ●             |
| F       | ●                    | ●                 | ●             | ●             |

**[Outdoor unit – Capacity setting display] (Request code : "70")**

| Data display | Capacity |
|--------------|----------|
| 9            | 12       |
| 10           | 18       |
| 11           | 24       |
| 14           | 30       |
| 20           | 36       |
| 25           | 42       |

**[Outdoor unit – Setting information] (Request code : "71")**

Data display 

|   |   |   |   |
|---|---|---|---|
| 0 | 0 | * | * |
|---|---|---|---|

 Setting information ①  
Setting information ②

Setting information ①

| Display | Defrost mode      |
|---------|-------------------|
| 0       | Standard          |
| 1       | For high humidity |

Setting information ②

| Display | Single-/3-phase | Heat pump/cooling only |
|---------|-----------------|------------------------|
| 0       | Single-phase    | Heat pump              |
| 1       |                 | Cooling only           |
| 2       | 3-phase         | Heat pump              |
| 3       |                 | Cooling only           |

**[Indoor unit – Model setting information] (Request code : 162)**

Data display

0 0 \* \*

See the table on the right.

| Display | Model setting state | Display | Model setting state |
|---------|---------------------|---------|---------------------|
| 00      | PEAD-A-AA           | 20      |                     |
| 01      | PEAD-A-AA           | 21      |                     |
| 02      |                     | 22      |                     |
| 03      |                     | 23      |                     |
| 04      |                     | 24      |                     |
| 05      |                     | 25      | PLA-A-BA            |
| 06      |                     | 26      |                     |
| 07      |                     | 27      |                     |
| 08      |                     | 28      |                     |
| 09      |                     | 29      |                     |
| 0A      |                     | 2A      |                     |
| 0b      |                     | 2b      |                     |
| 0C      |                     | 2C      |                     |
| 0d      |                     | 2d      |                     |
| 0E      |                     | 2E      |                     |
| 0F      |                     | 2F      |                     |
| 10      |                     | 30      | PEA-A-AA            |
| 11      |                     | 31      | PCA-A-KA            |
| 12      |                     | 32      | PKA-A-HA(L)/KA(L)   |
| 13      |                     | 33      |                     |
| 14      |                     | 34      |                     |
| 15      |                     | 35      |                     |
| 16      |                     | 36      |                     |
| 17      |                     | 37      |                     |
| 18      |                     | 38      |                     |
| 19      |                     | 39      |                     |
| 1A      |                     | 3A      |                     |
| 1b      |                     | 3b      |                     |
| 1C      |                     | 3C      |                     |
| 1d      |                     | 3d      |                     |
| 1E      |                     | 3E      |                     |
| 1F      |                     | 3F      |                     |

**[Indoor unit – Capacity setting information] (Request code : 163)**

Data display

0 0 \* \*

See the table on the right.

| Display | Capacity setting state | Display | Capacity setting state |
|---------|------------------------|---------|------------------------|
| 00      |                        | 10      | 42                     |
| 01      |                        | 11      |                        |
| 02      |                        | 12      |                        |
| 03      |                        | 13      |                        |
| 04      |                        | 14      |                        |
| 05      |                        | 15      |                        |
| 06      | 12                     | 16      |                        |
| 07      |                        | 17      |                        |
| 08      |                        | 18      |                        |
| 09      | 18                     | 19      |                        |
| 0A      |                        | 1A      |                        |
| 0b      | 24                     | 1b      |                        |
| 0C      |                        | 1C      |                        |
| 0d      | 30                     | 1d      |                        |
| 0E      |                        | 1E      |                        |
| 0F      | 36                     | 1F      |                        |

**[Wireless pair No. (indoor control board side) setting] (Request code : 165)**

Data display

0 0 \* \*

See the table on the right.

| Display | Pair No. setting state      |
|---------|-----------------------------|
| 00      | No. 0                       |
| 01      | No. 1 J41 disconnected      |
| 02      | No. 2 J42 disconnected      |
| 03      | No. 3 J41, J42 disconnected |

**PUZ-A18NHA6  
PUY-A12/18NHA6**

**PUZ-A18NHA6-BS  
PUY-A12/18NHA6-BS**

**OPERATING PROCEDURE**

- 1. Removing the top panel, service panel, front panel and back panel**
- (1) Remove the top panel fixing screws (4 × 10), one from the right and two from the left side, and detach the top panel.
  - (2) Remove 1 service panel fixing screw (4 × 10) and detach the service panel by pulling it downward. (See Photo 1)
  - (3) Remove the front panel fixing screws (4 × 10), 5 from the front, 2 from the right and 2 from the left side, and detach the front panel.
  - (4) Remove the conduit cover and cord cover fixing screw (2 pcs. 4 × 10), and detach the conduit cover and cord cover. (See Photo 2)
  - (5) Remove the back panel fixing screws (4 × 10), 4 from the right and 3 from the rear side, and detach the back panel.

**PHOTOS**

**Photo 1**

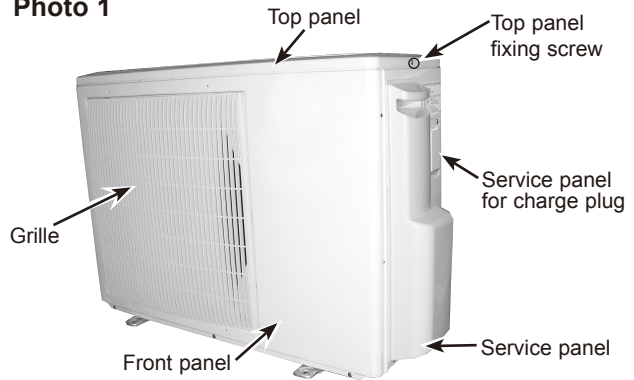

**Photo 2**

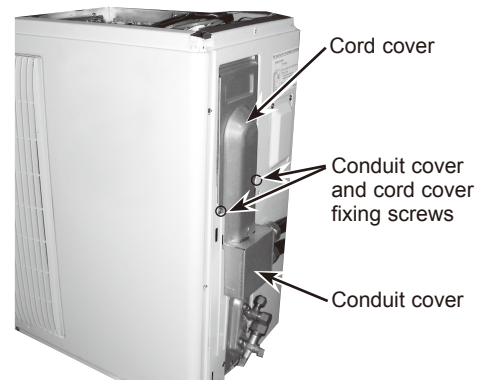

**2. Removing the fan motor**

- (1) Remove the top panel. (See Photo 1)
- (2) Remove the front panel. (See Photo 1)
- (3) Remove 1 nut (M6, left-screw) and detach the propeller.
- (4) Disconnect the connector CNF1 on the controller circuit board in the electrical parts box.
- (5) Loosen the clamp for the lead wire in the motor support.
- (6) Remove 4 fan motor fixing screws (4 × 18) and detach the fan motor. (See Photo 3)

**Photo 3**

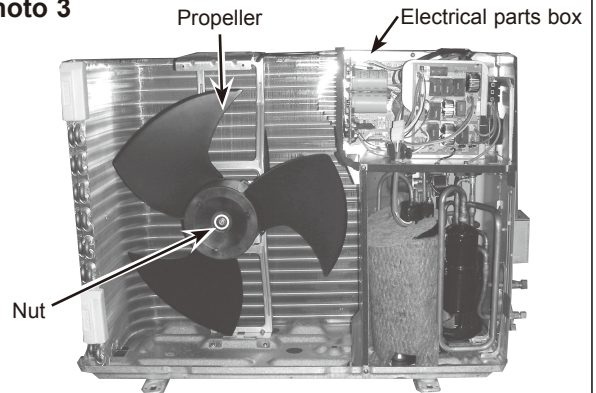

**Photo 4**

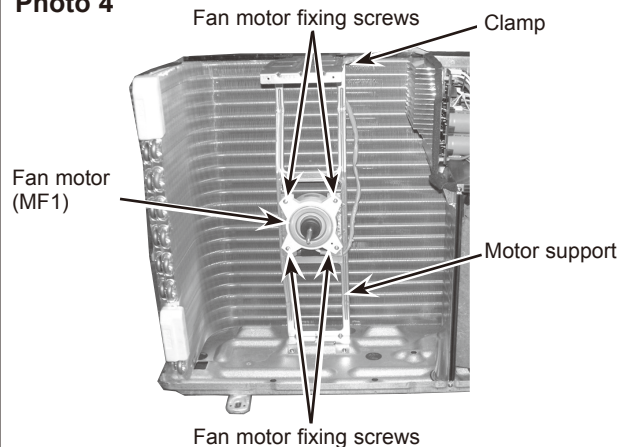

## OPERATING PROCEDURE

### 3. Removing the electrical parts box

- (1) Remove the service panel. (See Photo 1)
- (2) Remove the top panel. (See Photo 1)
- (3) Remove the front panel. (See Photo 1)
- (4) Disconnect the indoor/outdoor connecting wire from terminal block.
- (5) Remove all the following connectors from controller circuit board; fan motor, linear expansion valve, thermistor<Outdoor pipe>, thermistor<Shell>, thermistor<Outdoor 2-phase pipe>, thermistor<Outdoor>, high pressure switch, four-way valve and bypass valve.  
Pull out the disconnected wire from the electrical parts box.  
<Diagram symbol in the connector housing>
  - Fan motor (CNF1)
  - Linear expansion valve (LEV-A)
  - Thermistor <Liquid> (TH3)
  - Thermistor <Comp. surface> (TH32)
  - Thermistor <2-phase pipe, Ambient> (TH6/7)
  - High pressure switch (63H)
- (6) Remove the terminal cover and disconnect the compressor lead wire.
- (7) Remove the electrical parts box fixing screws, 1 from the front, the right and the rear side, and detach the electrical parts box by pulling it upward.

### 4. Removing the thermistor <2-phase pipe> (TH6), thermistor <Liquid> (TH3) and thermistor <Suction> (TH33)

- (1) Remove the service panel. (See Photo 1)
- (2) Remove the top panel. (See Photo 1)
- (3) Remove the front panel. (See Photo 1)
- (4) Remove the conduit cover and cord cover.
- (5) Remove the back panel fixing screws, 4 from the right and 3 from the rear side, and detach the back panel. (See Photo 1)
- (6) Disconnect the connector TH3 (white) or TH6/7 (red) or TH33 (yellow) on the controller circuit board in the electrical parts box.
- (7) Loosen the clamp for the lead wire in the rear of the electrical parts box.
- (8) Pull out the thermistor <Liquid> (TH3) and thermistor <2-phase pipe> (TH6) and thermistor <suction> (TH33) from the sensor holder.

**Note:** Replace the thermistor <2-phase pipe> (TH6) and the thermistor <Ambient> (TH7) together since they are combined.  
Refer to No. 5. to remove the thermistor <Ambient> (TH7).

## PHOTOS

Photo 5

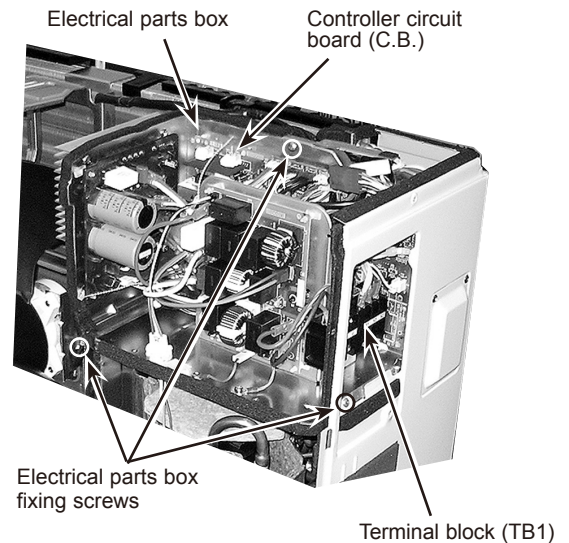
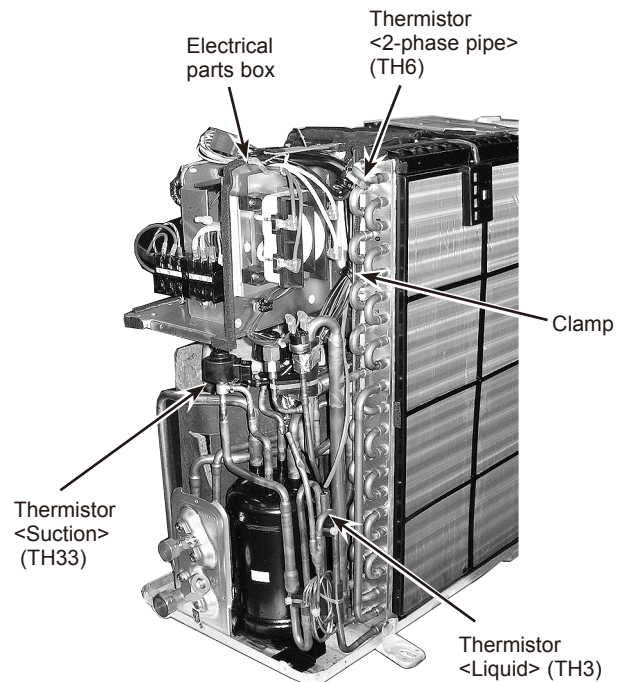

Photo 6



## OPERATING PROCEDURE

### 5. Removing the thermistor <Ambient> (TH7)

- (1) Remove the service panel. (See Photo 1)
- (2) Remove the top panel. (See Photo 1)
- (3) Disconnect the connector TH7 (red) on the controller circuit board in the electrical parts box.
- (4) Loosen the clamp for the lead wire in the rear of the electrical parts box. (See Photo 4)
- (5) Pull out the thermistor <Ambient> (TH7) from the sensor holder.

**Note: In case of replacing thermistor <Ambient> (TH7), replace it together with thermistor <2-phase pipe> (TH6), since they are combined together. Refer to No.4. to remove thermistor <2-phase pipe>.**

## PHOTOS

Photo 7

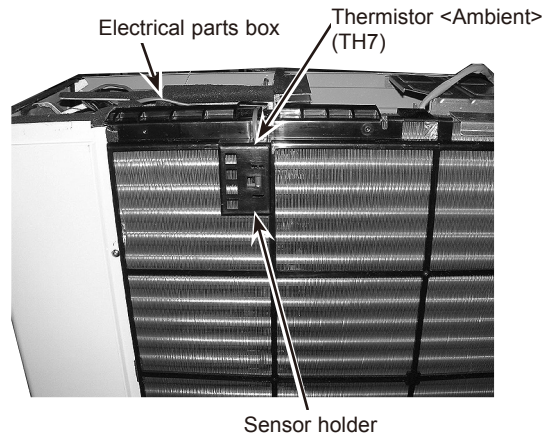

### 6. Removing the thermistor <Comp. surface> (TH32)

- (1) Remove the service panel. (See Photo 1)
- (2) Remove the top panel. (See Photo 1)
- (3) Remove the front panel. (See Photo 1)
- (4) Remove the back panel. (See Photo 1)
- (5) Remove the electrical parts box. (See Photo 5)
- (6) Remove the sound proof cover (upper) for compressor.
- (6) Pull out the thermistor <Comp. surface> (TH32) from the holder of the compressor shell.

Photo 8

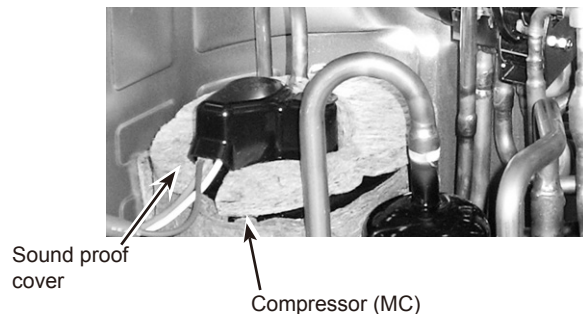

### 7. Removing the 4-way valve coil (21S4) and linear expansion valve coil (LEV-A)

- (1) Remove the service panel. (See Photo 1)
- (2) Remove the top panel. (See Photo 1)
- (3) Remove the front panel. (See Photo 1)
- (4) Remove the conduit cover and cord cover.
- (5) Remove the back panel. (See Photo 1)
- (6) Remove the electrical parts box. (See Photo 5)

#### [Removing the 4-way valve coil (21S4)]

- (7) Remove 1 4-way valve coil fixing screw (M4 × 6).
- (8) Remove the 4-way valve coil by sliding the coil to the right.

#### [Removing the linear expansion valve coil (LEV-A)]

- (9) Remove the linear expansion valve coil by sliding the coil upward.

Photo 9

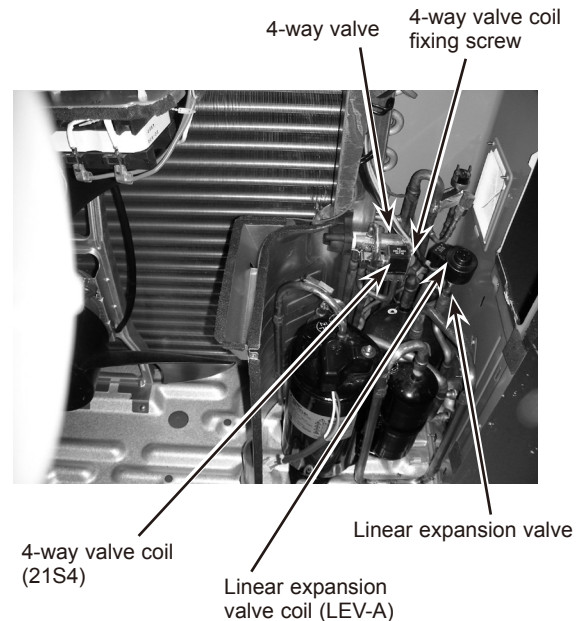

## OPERATING PROCEDURE

## PHOTOS

### 8. Removing the 4-way valve

- (1) Remove the service panel. (See Photo 1)
- (2) Remove the top panel. (See Photo 1)
- (3) Remove the front panel. (See Photo 1)
- (4) Remove the conduit cover and cord cover. (See Photo 2)
- (5) Remove the back panel. (See Photo 1)
- (6) Remove the electrical parts box. (See Photo 5)
- (7) Remove the 4-way valve coil (See Photo 8)
- (8) Recover refrigerant.
- (9) Remove the welded part of four-way valve.

**Note 1: Recover refrigerant without spreading it in the air.**

**Note 2: The welded part can be removed easily by removing the right side panel.**

**Note 3: When installing the four-way valve, cover it with a wet cloth to prevent it from heating (250°F or more), then braze the pipes so that the inside of pipes are not oxidized.**

Photo 10

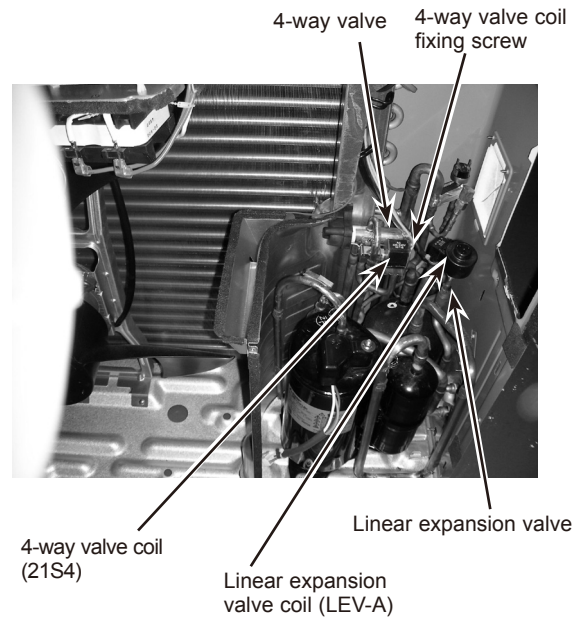

### 9. Removing linear expansion valve

- (1) Remove the service panel. (See Photo 1)
- (2) Remove the top panel. (See Photo 1)
- (3) Remove the front panel. (See Photo 1)
- (4) Remove the conduit cover and cord cover. (See Photo 2)
- (5) Remove the back panel. (See Photo 1)
- (6) Remove the electrical parts box. (See Photo 5)
- (7) Remove the linear expansion valve coil . (See Photo 10)
- (8) Recover refrigerant.
- (9) Remove the welded part of linear expansion valve.

**Note 1: Recover refrigerant without spreading it in the air.**

**Note 2: The welded part can be removed easily by removing the back panel.**

**Note 3: When installing the linear expansion valve, cover it with a wet cloth to prevent it from heating (250°F or more), then braze the pipes so that the inside of pipes are not oxidized.**

Photo 11

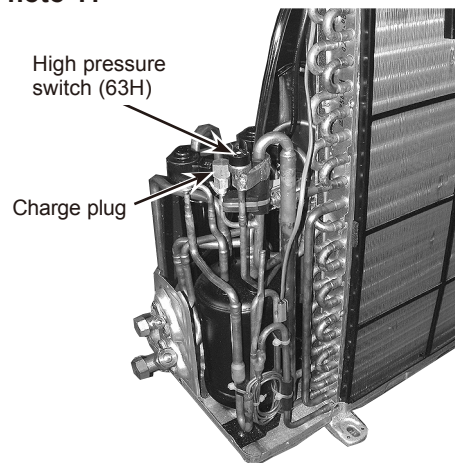

### 10. Removing the high pressure switch (63H)

- (1) Remove the service panel. (See Photo 1)
- (2) Remove the top panel. (See Photo 1)
- (3) Remove the front panel. (See Photo 1)
- (4) Remove the conduit cover and cord cover. (See Photo 2)
- (5) Remove the back panel. (See Photo 1)
- (6) Remove the electrical parts box. (See Photo 5)
- (7) Pull out the lead wire of high pressure switch.
- (8) Recover refrigerant.
- (9) Remove the welded part of high pressure switch.

**Note 1: Recover refrigerant without spreading it in the air.**

**Note 2: The welded part can be removed easily by removing the back panel.**

**Note 3: When installing the high pressure switch, cover it with a wet cloth to prevent it from heating (210°F or more), then braze the pipes so that the inside of pipes are not oxidized.**

Photo 12

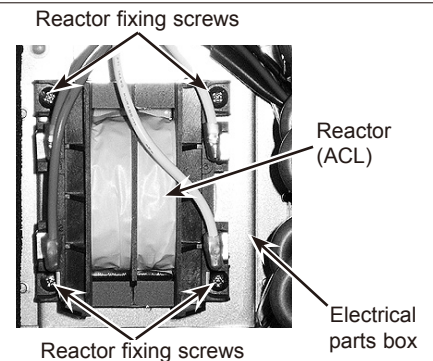

### 11. Removing the reactor (ACL)

- (1) Remove the service panel. (See Photo 1)
- (2) Remove the top panel. (See Photo 1)
- (3) Remove the front panel. (See Photo 1)
- (4) Remove the back panel. (See Photo 1)
- (5) Remove 3 reactor fixing screws (4 × 20) and remove the reactor.

Note: The reactor is attached to the rear of the electrical parts box.

## OPERATING PROCEDURE

### 12. Removing the compressor (MC)

- (1) Remove the service panel. (See Photo 1)
- (2) Remove the top panel. (See Photo 1)
- (3) Remove the front panel. (See Photo 1)
- (4) Remove the conduit cover and cord cover.  
(See Photo 2)
- (5) Remove the back panel. (See Photo 1)
- (6) Remove the electrical parts box. (See Photo 5)
- (7) Remove 3 separator fixing screws (4 × 10) and remove the separator.
- (8) Remove the thermistor <Comp. surface> (TH32). (Refer to procedure 6)
- (9) Recover refrigerant.
- (10) Remove 3 compressor fixing nuts by using spanner or adjustable wrench.
- (11) Remove the welded pipe of motor for compressor inlet and outlet.

**Note: Recover refrigerant without spreading it in the air.**

## PHOTOS

Photo 13

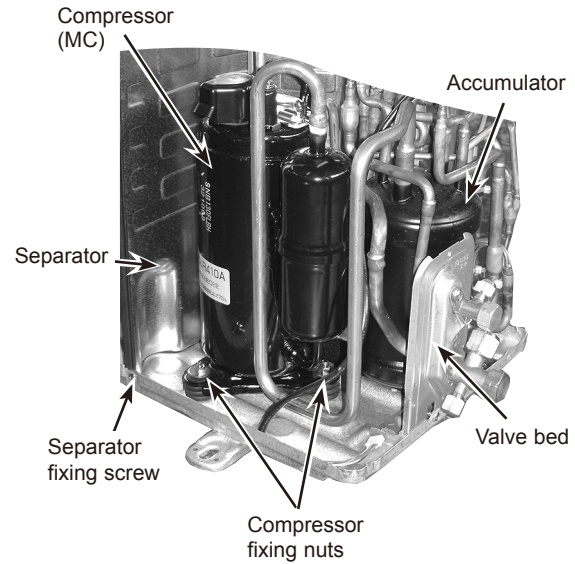

### 13. Removing the accumulator

- (1) Remove the service panel. (See Photo 1)
- (2) Remove the top panel. (See Photo 1)
- (3) Remove the front panel. (See Photo 1)
- (4) Remove the conduit cover and cord cover. (See Photo 2)
- (5) Remove the back panel. (See Photo 1)
- (6) Remove the electrical parts box. (See Photo 5)
- (7) Recover refrigerant.
- (8) Remove 2 welded pipes of accumulator inlet and outlet.
- (9) Remove 2 accumulator leg fixing screws (4 × 10).
- (10) Remove the accumulator together with the receiver leg.

**Note: Recover refrigerant without spreading it in the air.**

Photo 14

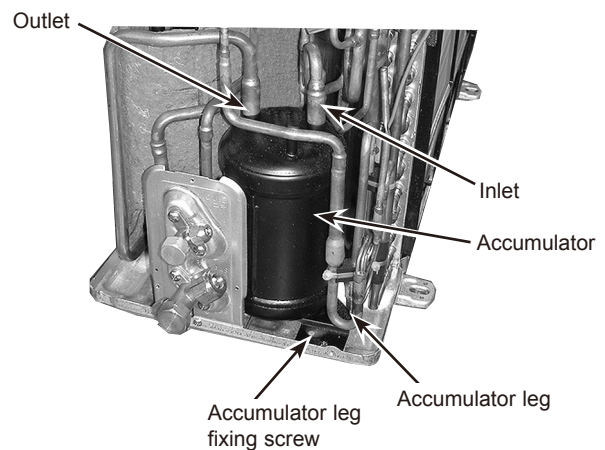

**PUZ-A24/30/36NHA6(-BS) PUY-A24/30/36NHA6(-BS)**

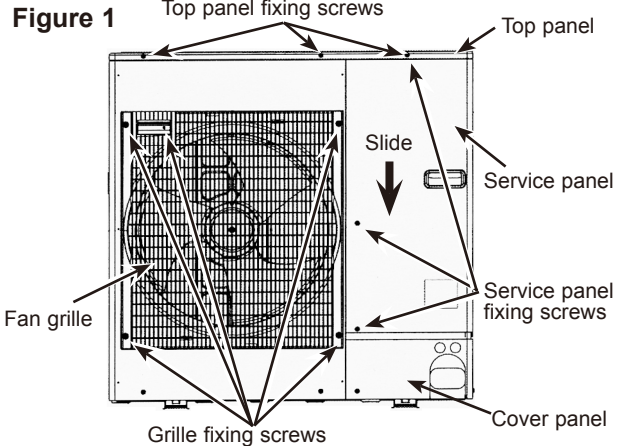
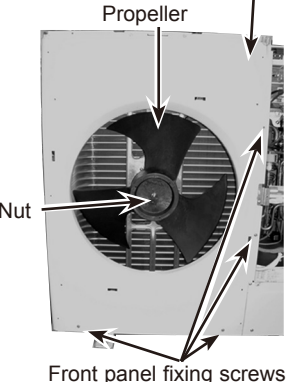
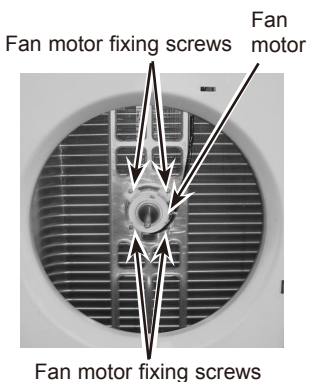
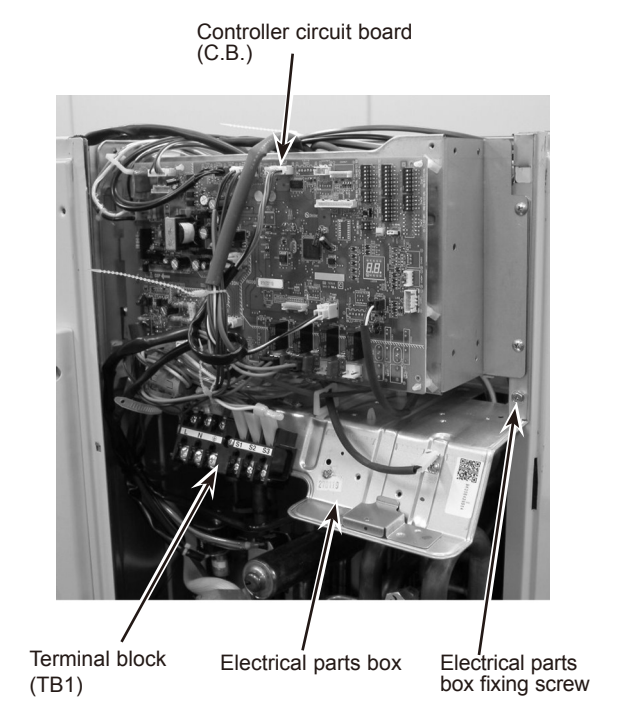
| OPERATING PROCEDURE   | PHOTOS & ILLUSTRATION  |
|---|--|
| <p><b>1. Removing the service panel and top panel</b></p> <ol style="list-style-type: none"> <li>(1) Remove 3 service panel fixing screws (5 × 12) and slide the hook on the right downward to remove the service panel.</li> <li>(2) Remove screws (3 for front, 3 for rear/5 × 12) of the top panel and remove it.</li> </ol>   | <p><b>Figure 1</b></p>   |
| <p><b>2. Removing the fan motor (MF1)</b></p> <ol style="list-style-type: none"> <li>(1) Remove the service panel. (See Figure 1)</li> <li>(2) Remove the top panel. (See Figure 1)</li> <li>(3) Remove 5 fan grille fixing screws (5 × 12) to detach the fan grille. (See Figure 1)</li> <li>(4) Remove a nut (for right handed screw of M6) to detach the propeller. (See Photo 1)</li> <li>(5) Disconnect the connector CNF1 on controller circuit board in electrical parts box.</li> <li>(6) Remove 4 fan motor fixing screws (5 × 25) to detach the fan motor. (See Photo 2)</li> </ol>   | <div style="display: flex; justify-content: space-around;"> <div data-bbox="885 787 1173 1202"> <p><b>Photo 1</b></p>  </div> <div data-bbox="1197 787 1508 1202"> <p><b>Photo 2</b></p>  </div> </div> |
| <p><b>3. Removing the electrical parts box</b></p> <ol style="list-style-type: none"> <li>(1) Remove the service panel. (See Figure 1)</li> <li>(2) Remove the top panel. (See Figure 1)</li> <li>(3) Disconnect the indoor/outdoor connecting wire from terminal block.</li> <li>(4) Remove all the following connectors from controller circuit board, fan motor, linear expansion valve, thermistor&lt;Liquid&gt;, thermistor&lt;Comp. surface&gt;, thermistor&lt;2-phase pipe&gt;, thermistor&lt;Ambient&gt;, high pressure switch, 4-way valve and bypass valve.<br/>Pull out the disconnected wire from the electrical parts box.<br/>&lt;Diagram symbol in the connector housing&gt; <ul style="list-style-type: none"> <li>• Fan motor (CNF1)</li> <li>• Linear expansion valve (LEV-A)</li> <li>• Thermistor &lt;Liquid&gt; (TH3)</li> <li>• Thermistor &lt;Comp. surface&gt; (TH32)</li> <li>• Thermistor &lt;2-phase pipe, Ambient &gt; (TH6/7)</li> <li>• High pressure switch (63H)</li> <li>• 4-way valve coil (21S4)</li> <li>• Bypass valve coil (SV2)</li> </ul> </li> <li>(5) Remove the terminal cover and disconnect the compressor lead wire.</li> <li>(6) Remove an electrical parts box fixing screw (4 × 10) and detach the electrical parts box by pulling it upward. The electrical parts box is fixed with 2 hooks on the left and 1 hook on the right.</li> </ol> | <p><b>Photo 3</b></p>    |

## OPERATING PROCEDURE

### 4. Removing the thermistor <2-phase pipe> (TH6)

- (1) Remove the service panel. (See Figure 1)
- (2) Remove the top panel. (See Figure 1)
- (3) Disconnect the connectors, TH6 and TH7 (red), on the controller circuit board in the electrical parts box.
- (4) Loosen the clamp for the lead wire in the rear of the electrical parts box.
- (5) Pull out the thermistor <2-phase pipe> (TH6) from the sensor holder.

**Note: In case of replacing thermistor <2-phase pipe> (TH6), replace it together with thermistor <Ambient> (TH7), since they are combined together.**

**Refer to No.5 below to remove thermistor <Ambient>.**

### 5. Removing the thermistor <Ambient> (TH7)

- (1) Remove the service panel. (See Figure 1)
- (2) Remove the top panel. (See Figure 1)
- (3) Disconnect the connector TH7 (red) on the controller circuit board in the electrical parts box.
- (4) Loosen the clamp for the lead wire in the rear of the electrical parts box. (See Photo 4)
- (5) Pull out the thermistor <Ambient> (TH7) from the sensor holder.

**Note: In case of replacing thermistor <Ambient> (TH7), replace it together with thermistor <2-phase pipe> (TH6), since they are combined together.**  
**Refer to No.4 above to remove thermistor <2-phase pipe>.**

### 6. Removing the thermistor <Liquid> (TH3)

- (1) Remove the service panel. (See Figure 1)
- (2) Disconnect the connector TH3 (white) on the controller circuit board in the electrical parts box.
- (3) Loosen the clamp for the lead wire in the rear of the electrical parts box. (See Photo 4)
- (4) Pull out the thermistor <Liquid> (TH3) from the sensor holder.

### 7. Removing the thermistor <Comp. surface> (TH32) and thermistor <Suction> (TH33)

- (1) Remove the service panel. (See Figure 1)
- (2) Disconnect the connector TH32 (black) or TH33 (yellow) on the controller circuit board in the electrical parts box.
- (3) Loosen the clamp for the lead wire under the electrical parts box. (See Photo 4)
- (4) Pull out the thermistor <Comp. surface> (TH32) and thermistor <Suction> (TH33) from the holder of the compressor shell. (See Photo 6)

## PHOTOS

Photo 4

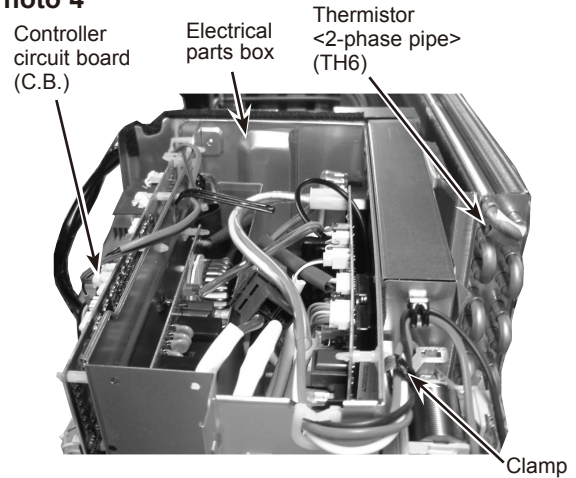

Photo 5

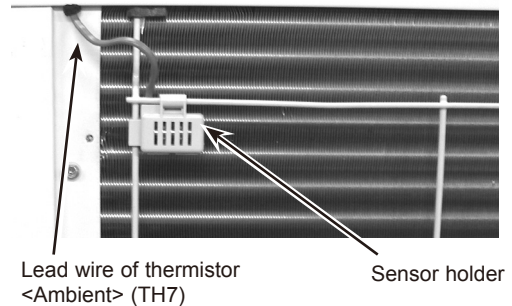

Photo 6

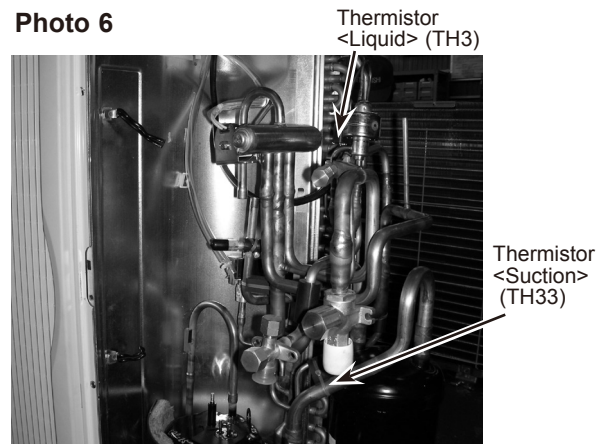
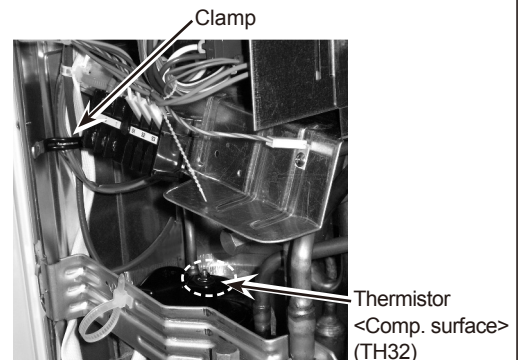

Photo 7



## OPERATING PROCEDURE

### 8. Removing the 4-way valve coil (21S4), linear expansion valve coil (LEV-A) and bypass valve coil (SV)

- (1) Remove the service panel. (See Figure 1)
- (2) Remove the top panel. (See Figure 1)
- (3) Remove the electrical parts box. (See Photo 3)

#### [Removing the 4-way valve coil]

- (4) Remove 4-way valve coil fixing screw (M4 × 6).
- (5) Remove the 4-way valve coil by sliding the coil toward you.
- (6) Disconnect the connector 21S4 (green) on the controller board in the electrical parts box.

#### [Removing the linear expansion valve coil]

- (4) Remove the linear expansion valve coil by sliding the coil upward.
- (5) Disconnect the connectors, LEV-A (white), on the controller circuit board in the electrical parts box.

#### [Removing the bypass valve coil]

- (4) Remove the bypass valve coil fixing screw (M4 × 6).
- (5) Remove the bypass valve coil by sliding the coil upward.
- (6) Disconnect the connector SV2 (blue) on the controller circuit board in the electrical parts box.

### 9. Removing the 4-way valve

- (1) Remove the service panel. (See Figure 1)
- (2) Remove the top panel. (See Figure 1)
- (3) Remove the electrical parts box. (See Photo 3)
- (4) Remove 3 valve bed fixing screws (4 × 10), 4 ball valve and stop valve fixing screws (5 × 16), then remove the valve bed.
- (5) Remove 3 right side panel fixing screws (5 × 12) in the rear of the unit and then remove the right side panel.
- (6) Remove the 4-way valve coil. (See Photo 8)
- (7) Recover refrigerant.
- (8) Remove the welded part of 4-way valve.

**Note 1: Recover refrigerant without spreading it in the air.**

**Note 2: The welded part can be removed easily by removing the right side panel.**

**Note 3: When installing the 4-way valve, cover it with a wet cloth to prevent it from heating (250°F or more), then braze the pipes so that the inside of pipes are not oxidized.**

### 10. Removing the linear expansion valve

- (1) Remove the service panel. (See Figure 1)
- (2) Remove the top panel. (See Figure 1)
- (3) Remove the electrical parts box. (See Photo 3)
- (4) Remove 3 valve bed fixing screws (4 × 10), 4 ball valve and stop valve fixing screws (5 × 16), then remove the valve bed.
- (5) Remove 3 right side panel fixing screw (5 × 12) in the rear of the unit and then remove the right side panel.
- (6) Remove the linear expansion valve. (See Photo 8)
- (7) Recover refrigerant.
- (8) Remove the welded part of linear expansion valve.

**Note 1: Recover refrigerant without spreading it in the air.**

**Note 2: The welded part can be removed easily by removing the right side panel.**

**Note 3: When installing the linear expansion valve, cover it with a wet cloth to prevent it from heating (250°F or more), then braze the pipes so that the inside of pipes are not oxidized.**

## PHOTOS

Photo 8

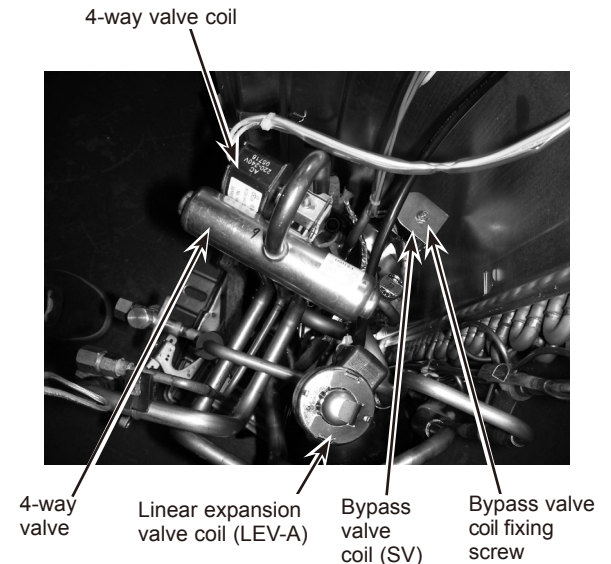
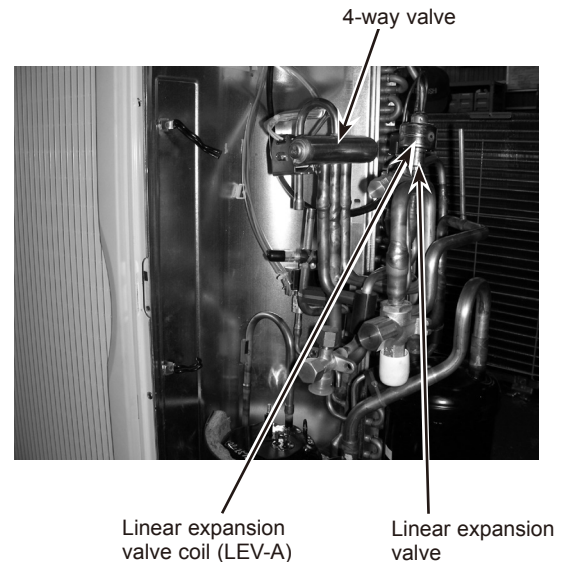

Photo 9



## OPERATING PROCEDURE

### 11. Removing the bypass valve

- (1) Remove the service panel. (See Figure 1)
- (2) Remove the top panel. (See Figure 1)
- (3) Remove the electrical parts box. (See Photo 3)
- (4) Remove 3 right side panel fixing screws (5 × 12) in the rear of the unit and remove the right side panel.
- (5) Remove the bypass valve coil. (See Photo 8).
- (6) Recover refrigerant.
- (7) Remove the welded part of bypass valve.

**Note 1: Recover refrigerant without spreading it in the air.**

**Note 2: The welded part can be removed easily by removing the right side panel.**

## PHOTOS

Photo 10



Bypass valve fixing screw

Bypass valve

### 12. Removing the high pressure switch (63H)

- (1) Remove the service panel. (See Figure 1)
- (2) Remove the top panel. (See Figure 1)
- (3) Remove the electrical parts box. (See Photo 3)
- (4) Remove 3 right side panel fixing screws (5 × 12) in the rear of the unit and remove the right side panel.
- (5) Pull out the lead wire of high pressure switch.
- (6) Recover refrigerant.
- (7) Remove the welded part of high pressure switch.

**Note 1: Recover refrigerant without spreading it in the air.**

**Note 2: The welded part can be removed easily by removing the right side panel.**

**Note 3: When installing the high pressure switch, cover it with a wet cloth to prevent it from heating (210°F or more), then braze the pipes so that the inside of pipes are not oxidized.**

Photo 11

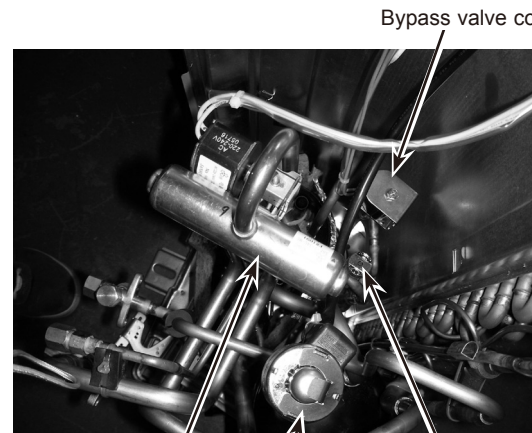

Bypass valve coil

4-way valve

Linear expansion valve coil (LEV-A)

High pressure switch (63H)

### 13. Removing the reactor (ACL) (A24)

- (1) Remove the service panel. (See Figure 1)
- (2) Remove the top panel. (See Figure 1)
- (3) Remove the electrical parts box. (See Photo 3)
- (4) Remove 3 reactor fixing screws (4 × 16) and remove the reactor.

Note: The reactor is attached to the rear of the electrical parts box.

Photo 12

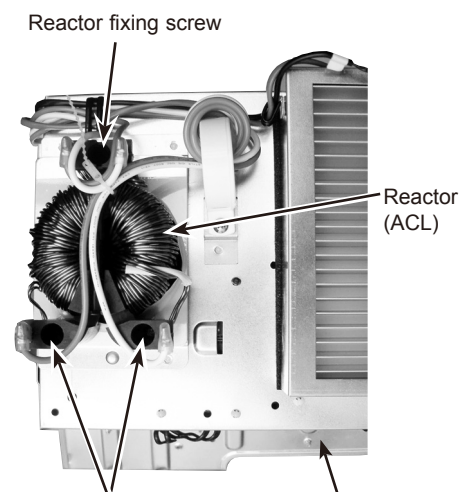

Reactor fixing screw

Reactor (ACL)

Reactor fixing screws

Electrical parts box

## OPERATING PROCEDURE

### 14. Removing the reactor (DCL) (A30, 36)

- (1) Remove the service panel. (See Figure 1)
- (2) Remove the top panel. (See Figure 1)
- (3) Remove the electrical parts box. (See Photo 3)
- (4) Remove 4 reactor fixing screws (4 × 10) and remove the reactor.

Note: The reactor is attached to the rear of the electrical parts box.

## PHOTOS

Photo 13 Reactor fixing screws

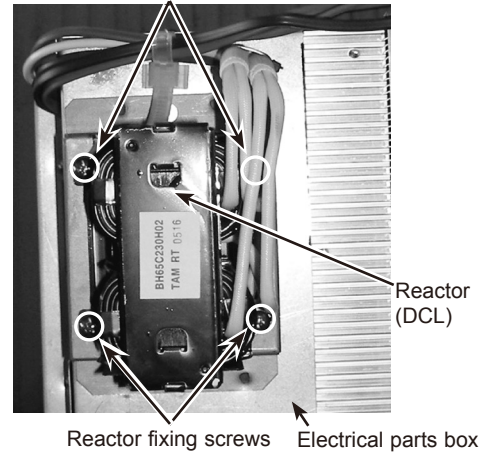

### 15. Removing the compressor (MC)

- (1) Remove the service panel. (See Figure 1)
- (2) Remove the top panel. (See Figure 1)
- (3) Remove 2 front cover panel fixing screws (5 × 12) and remove the front cover panel. (See Figure 1)
- (4) Remove 2 back cover panel fixing screws (5 × 12) and remove the back cover panel.
- (5) Remove the electrical parts box. (See Photo 3)
- (6) Remove 3 valve bed fixing screws (4 × 10), 4 ball valve and stop valve fixing screws (5 × 16), then remove the valve bed.
- (7) Remove 3 right side panel fixing screws (5 × 12) in the rear of the unit and then remove the right side panel.
- (8) Remove 3 separator fixing screws (4 × 10) and remove the separator.
- (9) Remove the thermistor <Comp. surface> (TH32). (Refer to procedure 7)
- (10) Recover refrigerant.
- (11) Remove the 3 points of the motor for compressor fixing nut using spanner or adjustable wrench.
- (12) Remove the welded pipe of motor for compressor inlet and outlet and then remove the compressor.

Note: Recover refrigerant without spreading it in the air.

Photo 14

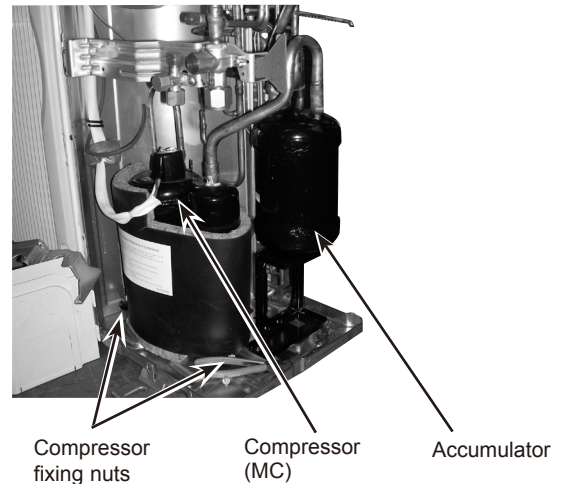

### 16. Removing the accumulator

- (1) Remove the service panel. (See Figure 1)
- (2) Remove the top panel. (See Figure 1)
- (3) Remove 2 front cover panel fixing screws (5 × 12) and remove the front cover panel. (See Photo 3)
- (4) Remove 2 back cover panel fixing screws (5 × 12) and remove the back cover panel.
- (5) Remove the electrical parts box. (See Figure 1)
- (6) Remove 3 valve bed fixing screws (4 × 10), 4 ball valve and stop valve fixing screws (5 × 16), then remove the valve bed.
- (7) Remove 3 right side panel fixing screws (5 × 12) in the rear of the unit and then remove the right side panel.
- (8) Recover refrigerant.
- (9) Remove 2 welded pipes of accumulator inlet and outlet.
- (10) Remove 2 receiver leg fixing screws (4 × 10).

Note: Recover refrigerant without spreading it in the air.

Photo 15

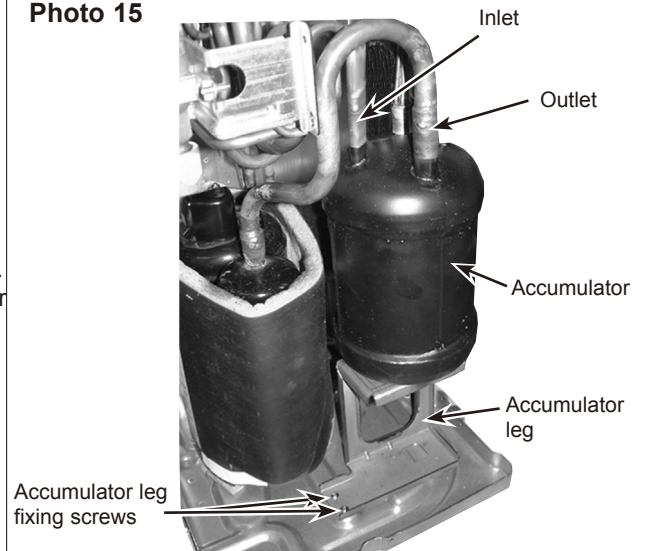

**PUZ-A42NHA6(-BS) PUY-A42NHA6(-BS)**

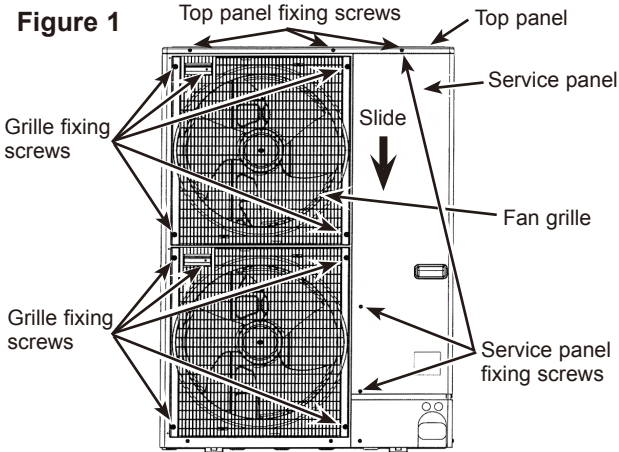
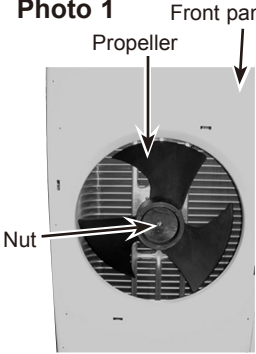
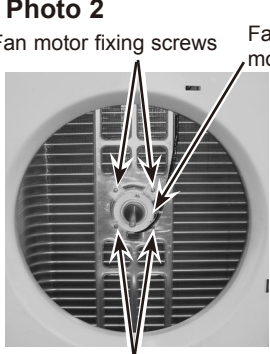
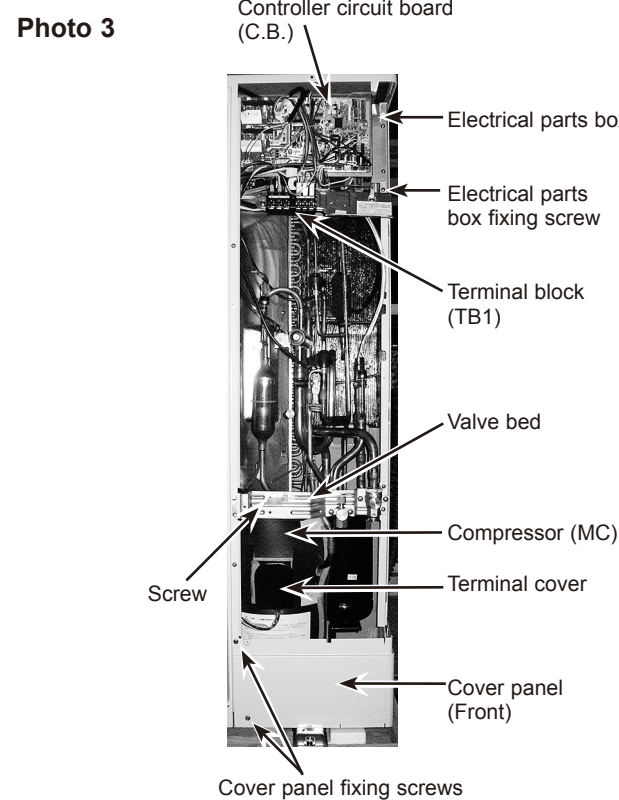
| OPERATING PROCEDURE  | PHOTOS & ILLUSTRATION  |
|--|--|
| <p><b>1. Removing the service panel and top panel</b></p> <p>(1) Remove 3 service panel fixing screws (5 × 12) and slide the hook on the right downward to remove the service panel.</p> <p>(2) Remove screws (3 for front, 3 for rear/5 × 12) of the top panel and remove it.</p>   | <p><b>Figure 1</b></p>   |
| <p><b>2. Removing the fan motor (MF1, MF2)</b></p> <p>(1) Remove the service panel. (See Figure 1)</p> <p>(2) Remove the top panel. (See Figure 1)</p> <p>(3) Remove 5 fan grille fixing screws (5 × 12) to detach the fan grille. (See Figure 1)</p> <p>(4) Remove a nut (for right handed screw of M6) to detach the propeller. (See Photo 1)</p> <p>(5) Disconnect the connectors, CNF1, CNF2 on controller circuit board in electrical parts box.</p> <p>(6) Remove 4 fan motor fixing screws (5 × 25) to detach the fan motor. (See Photo 2)</p>  | <p><b>Photo 1</b></p>  <p><b>Photo 2</b></p>  |
| <p><b>3. Removing the electrical parts box</b></p> <p>(1) Remove the service panel. (See Figure 1)</p> <p>(2) Remove the top panel. (See Figure 1)</p> <p>(3) Disconnect the indoor/outdoor connecting wire from terminal block.</p> <p>(4) Remove all the following connectors from controller circuit board; fan motor, linear expansion valve, thermistor &lt;Liquid&gt;, thermistor &lt;2-phase pipe&gt;, thermistor &lt;Ambient&gt;, high pressure switch, low pressure switch, 4-way valve coil. Then remove a screw (4 × 8) from the valve bed to remove the lead wire. Pull out the disconnected wire from the electrical parts box. &lt;Diagram symbol in the connector housing&gt;</p> <ul style="list-style-type: none"> <li>• Fan motor (CNF1, CNF2)</li> <li>• Linear expansion valve (LEV-A)</li> <li>• Thermistor &lt;Liquid&gt; (TH3)</li> <li>• Thermistor &lt;Comp. surface&gt; (TH32)</li> <li>• Thermistor &lt;2-phase pipe, Ambient&gt; (TH6/7)</li> <li>• Thermistor &lt;Suction&gt; (TH33)</li> <li>• High pressure switch (63H)</li> <li>• Low pressure switch (63L)</li> <li>• 4-way valve coil (21S4)</li> </ul> <p>(5) Remove the terminal cover and disconnect the compressor lead wire.</p> <p>(6) Remove an electrical parts box fixing screw (4 × 10) and detach the electrical parts box by pulling it upward. The electrical parts box is fixed with 2 hooks on the left and 1 hook on the right.</p> | <p><b>Photo 3</b></p>    |

## OPERATING PROCEDURE

### 4. Removing the thermistor <2-phase pipe> (TH6)

- (1) Remove the service panel. (See Figure 1)
- (2) Remove the top panel. (See Figure 1)
- (3) Disconnect the connectors, TH6 and TH7 (red), on the controller circuit board in the electrical parts box.
- (4) Loosen the clamp for the lead wire in the rear of the electrical parts box.
- (5) Pull out the thermistor <2-phase pipe> (TH6) from the sensor holder.

**Note:** In case of replacing thermistor <2-phase pipe> (TH6), replace it together with thermistor <Ambient> (TH7) since they are combined together.  
Refer to No.5 below to remove thermistor <Ambient>.

## PHOTOS

Photo 4

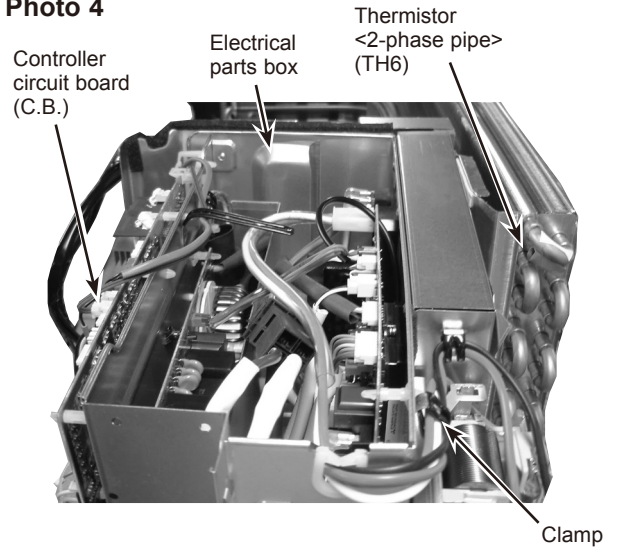

### 5. Removing the thermistor <Ambient> (TH7)

- (1) Remove the service panel. (See Figure 1)
- (2) Remove the top panel. (See Figure 1)
- (3) Disconnect the connector TH7 (red) on the controller circuit board in the electrical parts box.
- (4) Loosen the clamp for the lead wire in the rear of the electrical parts box. (See Photo 4)
- (5) Pull out the thermistor <Ambient> (TH7) from the sensor holder.

**Note:** In case of replacing thermistor <Ambient> (TH7), replace it together with thermistor <2-phase pipe> (TH6), since they are combined together.  
Refer to No.4 above to remove thermistor <2-phase pipe>.

Photo 5

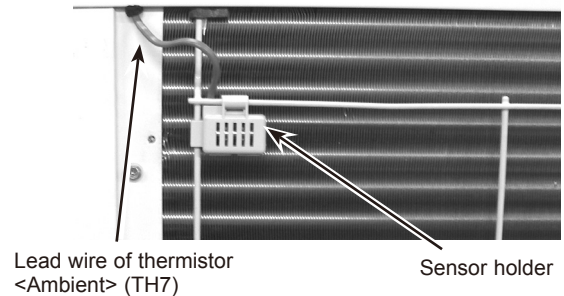

### 6. Removing the thermistor <Liquid> (TH3), thermistor <Comp. surface> (TH32) and thermistor <Suction> (TH33)

- (1) Remove the service panel. (See Figure 1)
- (2) Disconnect the connectors, TH3 (white), TH32 (black) and TH33 (yellow), on the controller circuit board in the electrical parts box.
- (3) Loosen the clamp for the lead wire in the rear of the electrical parts box. (See Photo 4)
- (4) Pull out the thermistor <Liquid> (TH3), thermistor <Comp. surface> (TH32) and thermistor <Suction> (TH33) from the sensor holder.

Photo 6

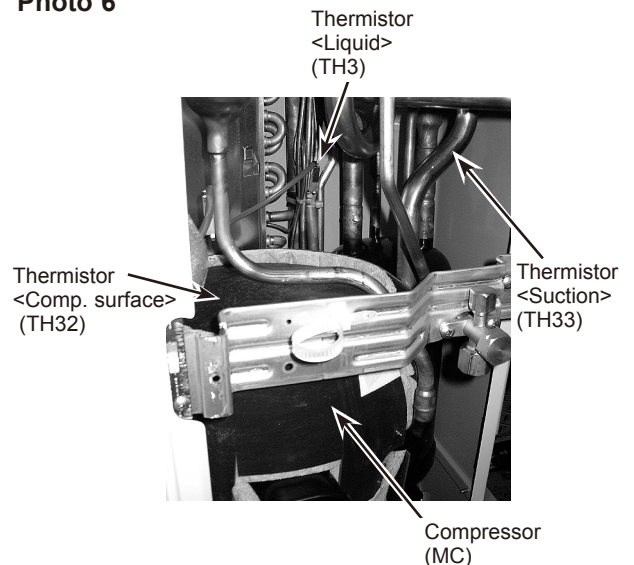

## OPERATING PROCEDURE

## PHOTOS

### 7. Removing the 4-way valve coil (21S4) and linear expansion valve coil (LEV-A)

- (1) Remove the service panel. (See Figure 1)
- (2) Remove the top panel. (See Figure 1)

#### [Removing the 4-way valve coil]

- (3) Remove 4-way valve coil fixing screw (M4 × 6).
- (4) Remove the 4-way valve coil by sliding the coil toward you.
- (5) Disconnect the connector 21S4 (green) on the controller circuit board in the electrical parts box.

#### [Removing the linear expansion valve coil]

- (3) Remove the linear expansion valve coil by sliding the coil upward.
- (4) Disconnect the connectors, LEV-A (white), on the controller circuit board in the electrical parts box.

### 8. Removing the 4-way valve

- (1) Remove the service panel. (See Figure 1)
- (2) Remove the top panel. (See Figure 1)
- (3) Remove 3 valve bed fixing screws (4 × 10), 4 ball valve and stop valve fixing screws (5 × 16), then remove the valve bed.
- (4) Remove 4 right side panel fixing screws (5 × 12) in the rear of the unit and then remove the right side panel.
- (5) Remove the 4-way valve coil. (See Photo 7)
- (6) Recover refrigerant.
- (7) Remove the welded part of 4-way valve.

**Note 1: Recover refrigerant without spreading it in the air.**

**Note 2: The welded part can be removed easily by removing the right side panel.**

**Note 3: When installing the 4-way valve, cover it with a wet cloth to prevent it from heating (250°F or more), then braze the pipes so that the inside of pipes are not oxidized.**

### 9. Removing linear expansion valve

- (1) Remove the service panel. (See Figure 1)
- (2) Remove the top panel. (See Figure 1)
- (3) Remove 3 valve bed fixing screws (4 × 10), 4 ball valve and stop valve fixing screws (5 × 16), then remove the valve bed.
- (4) Remove 4 right side panel fixing screws (5 × 12) in the rear of the unit and then remove the right side panel.
- (5) Remove the linear expansion valve. (See Photo 7)
- (6) Recover refrigerant.
- (7) Remove the welded part of linear expansion valve.

**Note 1: Recover refrigerant without spreading it in the air.**

**Note 2: The welded part can be removed easily by removing the right side panel.**

**Note 3: When installing the linear expansion valve, cover it with a wet cloth to prevent it from heating (250°F or more), then braze the pipes so that the inside of pipes are not oxidized.**

Photo 7

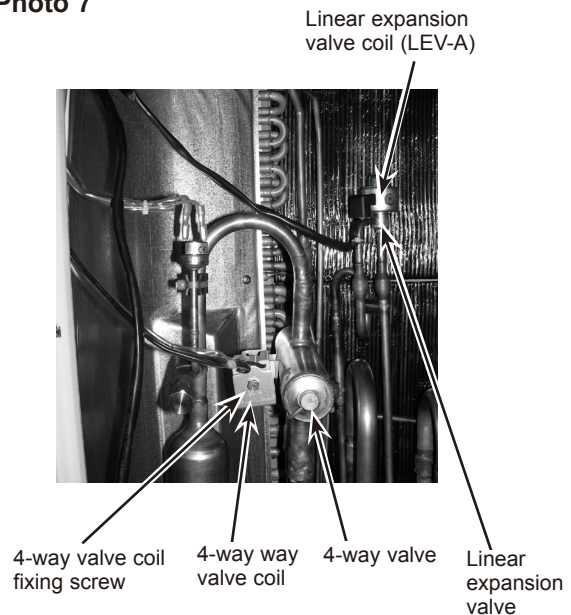

## OPERATING PROCEDURE

### 10. Removing the high pressure switch (63H)

- (1) Remove the service panel. (See photo 1)
- (2) Remove the top panel. (See photo 1)
- (3) Remove 3 right side panel fixing screws (5 × 12) in the rear of the unit and remove the right side panel.
- (4) Pull out the lead wire of high pressure switch.
- (5) Recover refrigerant.
- (6) Remove the welded part of high pressure switch.

**Note 1:** Recover refrigerant without spreading it in the air.

**Note 2:** The welded part can be removed easily by removing the right side panel.

**Note 3:** When installing the high pressure switch, cover it with a wet cloth to prevent it from heating (210°F or more), then braze the pipes so that the inside of pipes are not oxidized.

## PHOTOS

Photo 8



High pressure switch (63H)

### 11. Removing the reactor (DCL) and capacitor (CE)

- (1) Remove the service panel. (See Figure 1)
- (2) Remove the top panel. (See Figure 1)
- (3) Remove the electrical parts box. (See Photo 3)
- <Removing the reactor>
- (4) Remove 4 reactor fixing screws (4 × 10) and remove the reactor.
- <Removing the capacitor>
- (4) Remove 2 capacitor band fixing screws (4 × 10) and remove the capacitor.

Note: The reactor and capacitor is attached to the rear of the electrical parts box.

Photo 9

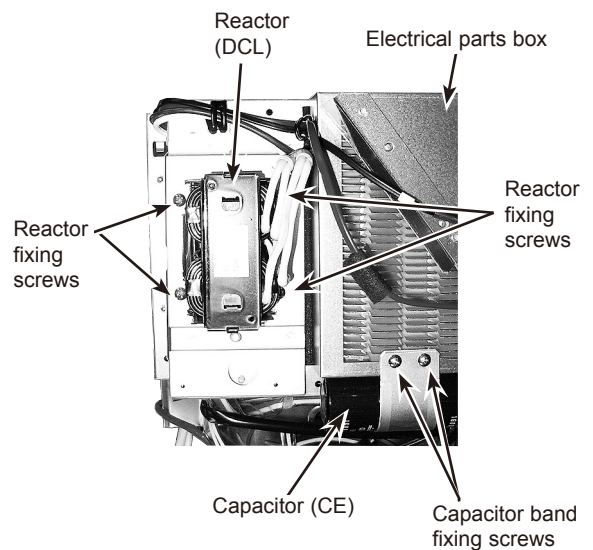

## OPERATING PROCEDURE

### 12. Removing the compressor (MC)

- (1) Remove the service panel. (See Figure 1)
- (2) Remove the top panel. (See Figure 1)
- (3) Remove 2 front cover panel fixing screws (5 × 12) and remove the front cover panel. (See Photo 3)
- (4) Remove 2 back cover panel fixing screws (5 × 12) and remove the back cover panel.
- (5) Remove the electrical parts box. (See Photo 3)
- (6) Remove 3 valve bed fixing screws (4 × 10), 4 ball valve and stop valve fixing screws (5 × 16), then remove the valve bed.
- (7) Remove 3 right side panel fixing screws (5 × 12) in the rear of the unit and then remove the right side panel.
- (8) Remove 3 separator fixing screws (4 × 10) and remove the separator.
- (9) Recover refrigerant.
- (10) Remove the 3 points of the motor for compressor fixing nut using spanner or adjustable wrench.
- (11) Remove the welded pipe of motor for compressor inlet and outlet and then remove the compressor.

**Note: Recover refrigerant without spreading it in the air.**

## PHOTOS

Photo 10

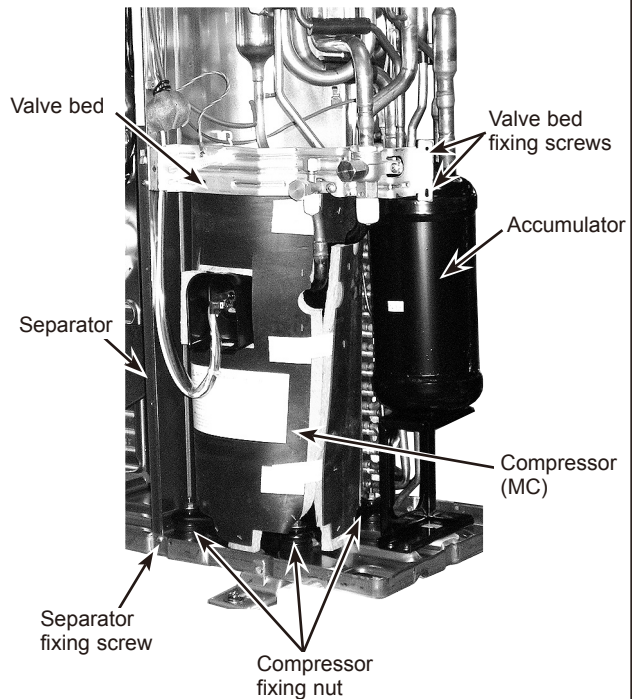

### 13. Removing the accumulator

- (1) Remove the service panel. (See Figure 1)
- (2) Remove the top panel. (See Figure 1)
- (3) Remove 2 front cover panel fixing screws (5 × 12) and remove the front cover panel. (See Photo 3)
- (4) Remove 2 back cover panel fixing screws (5 × 12) and remove the back cover panel.
- (5) Remove the electrical parts box. (See Photo 3)
- (6) Remove 3 valve bed fixing screws (4 × 10), 4 ball valve and stop valve fixing screws (5 × 16), then remove the valve bed.
- (7) Remove 3 right side panel fixing screws (5 × 12) in the rear of the unit and then remove the right side panel.
- (8) Recover refrigerant.
- (9) Remove 2 welded pipes of accumulator inlet and outlet.
- (10) Remove 2 accumulator leg fixing screws (4 × 10).

**Note: Recover refrigerant without spreading it in the air.**

Photo 11

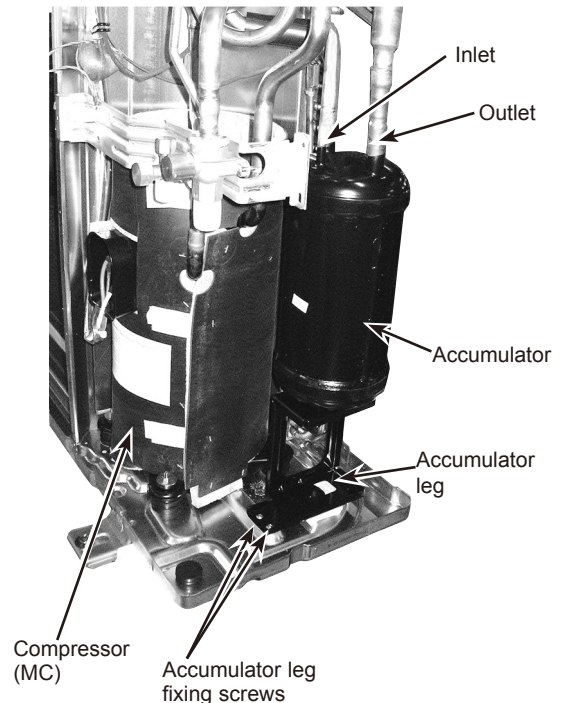

# MITSUBISHI ELECTRIC CORPORATION

HEAD OFFICE : TOKYO BLDG., 2-7-3, MARUNOUCHI, CHIYODA-KU, TOKYO 100-8310, JAPAN