

Changes for the Better

R410A

Models PUHY-P72, P96, P120Y(T)HMU-A
PUHY-P144, P168, P192, P216, P240Y(T)SHMU-A
PUHY-P264, P288, P312, P336, P360Y(T)SHMU-A

CITY MULTI

Service Handbook

Safety Precautions

- Before installing the unit, thoroughly read the following safety precautions.
- Observe these safety precautions for your safety.

WARNING

This symbol is intended to alert the user to the presence of important instructions that must be followed to avoid the risk of serious injury or death.

CAUTION

This symbol is intended to alert the user to the presence of important instructions that must be followed to avoid the risk of serious injury or damage to the unit.

- After reading this manual, give it to the user to retain for future reference.
 - Keep this manual for easy reference. When the unit is moved or repaired, give this manual to those who provide these services.
- When the user changes, make sure that the new user receives this manual.

WARNING

Ask your dealer or a qualified technician to install the unit.

Improper installation by the user may result in water leakage, electric shock, smoke, and/or fire.

Properly install the unit on a surface that can withstand the weight of the unit.

Unit installed on an unstable surface may fall and cause injury.

Only use specified cables. Securely connect each cable so that the terminals do not carry the weight of the cable.

Improperly connected or fixed cables may produce heat and start a fire.

Take appropriate safety measures against strong winds and earthquakes to prevent the unit from falling.

If the unit is not installed properly, the unit may fall and cause serious injury to the person or damage to the unit.

Do not make any modifications or alterations to the unit. Consult your dealer for repair.

Improper repair may result in water leakage, electric shock, smoke, and/or fire.

Do not touch the heat exchanger fins.

The fins are sharp and dangerous.

In the event of a refrigerant leak, thoroughly ventilate the room.

If refrigerant gas leaks and comes in contact with an open flame, poisonous gases will be produced.

When installing the All-Fresh type units, take it into consideration that the outside air may be discharged directly into the room when the thermo is turned off.

Direct exposure to outdoor air may have an adverse effect on health. It may also result in food spoilage.

Properly install the unit according to the instructions in the installation manual.

Improper installation may result in water leakage, electric shock, smoke, and/or fire.

Have all electrical work performed by an authorized electrician according to the local regulations and instructions in this manual, and a dedicated circuit must be used.

Insufficient capacity of the power supply circuit or improper installation may result in malfunctions of the unit, electric shock, smoke, and/or fire.

 **WARNING**

Securely attach the terminal block cover (panel) to the unit.

If the terminal block cover (panel) is not installed properly, dust and/or water may infiltrate and pose a risk of electric shock, smoke, and/or fire.

Only use the type of refrigerant that is indicated on the unit when installing or reinstalling the unit.

Infiltration of any other type of refrigerant or air into the unit may adversely affect the refrigerant cycle and may cause the pipes to burst or explode.

When installing the unit in a small room, exercise caution and take measures against leaked refrigerant reaching the limiting concentration.

Consult your dealer with any questions regarding limiting concentrations and for precautionary measures before installing the unit. Leaked refrigerant gas exceeding the limiting concentration causes oxygen deficiency.

Consult your dealer or a specialist when moving or reinstalling the unit.

Improper installation may result in water leakage, electric shock, and/or fire.

After completing the service work, check for a gas leak.

If leaked refrigerant is exposed to a heat source, such as a fan heater, stove, or electric grill, poisonous gases may be produced.

Do not try to defeat the safety features of the unit.

Forced operation of the pressure switch or the temperature switch by defeating the safety features of these devices, or the use of accessories other than the ones that are recommended by MITSUBISHI may result in smoke, fire, and/or explosion.

Only use accessories recommended by MITSUBISHI.

Ask a qualified technician to install the unit. Improper installation by the user may result in water leakage, electric shock, smoke, and/or fire.

Control box houses high-voltage parts.

When opening or closing the front panel of the control box, do not let it come into contact with any of the internal components. Before inspecting the inside of the control box, turn off the power, keep the unit off for at least 10 minutes, and confirm that the voltage between FT-P and FT-N on INV Board has dropped to DC20V or less. (It takes about 10 minutes to discharge electricity after the power supply is turned off.)

Precautions for handling units for use with R410A

CAUTION

Do not use the existing refrigerant piping.

- ♦A large amount of chlorine that may be contained in the residual refrigerant and refrigerating machine oil in the existing piping may cause the refrigerating machine oil in the new unit to deteriorate.
- ♦R410A is a high-pressure refrigerant and can cause the existing pipes to burst.

Use refrigerant pipes made of phosphorus deoxidized copper. Keep the inner and outer surfaces of the pipes clean and free of such contaminants as sulfur, oxides, dust, dirt, shaving particles, oil, and water.

These types of contaminants inside the refrigerant pipes may cause the refrigerant oil to deteriorate.

Store the pipes to be installed indoors, and keep both ends of the pipes sealed until immediately before brazing. (Keep elbows and other joints wrapped in plastic.)

Infiltration of dust, dirt, or water into the refrigerant system may cause the refrigerating machine oil to deteriorate or cause the unit to malfunction.

Use a small amount of ester oil, ether oil, or alkylbenzene to coat flares and flanges.

Infiltration of a large amount of mineral oil may cause the refrigerating machine oil to deteriorate.

Charge liquid refrigerant (as opposed to gaseous refrigerant) into the system.

If gaseous refrigerant is charged into the system, the composition of the refrigerant in the cylinder will change and may result in performance loss.

Use a vacuum pump with a reverse-flow check valve.

If a vacuum pump that is not equipped with a reverse-flow check valve is used, the vacuum pump oil may flow into the refrigerant cycle and cause the refrigerating machine oil to deteriorate.

Prepare tools for exclusive use with R410A. Do not use the following tools if they have been used with the conventional refrigerant (gauge manifold, charging hose, gas leak detector, reverse-flow check valve, refrigerant charge base, vacuum gauge, and refrigerant recovery equipment.).

- ♦If the refrigerant or the refrigerating machine oil left on these tools are mixed in with R410A, it may cause the refrigerating machine oil to deteriorate.
- ♦Infiltration of water may cause the refrigerating machine oil to deteriorate.
- ♦Gas leak detectors for conventional refrigerants will not detect an R410A leak because R410A is free of chlorine.

Do not use a charging cylinder.

If a charging cylinder is used, the composition of the refrigerant will change, and the unit may experience power loss.

Exercise special care when handling the tools for use with R410A.

Infiltration of dust, dirt, or water into the refrigerant system may cause the refrigerating machine oil to deteriorate.

Only use refrigerant R410A.

The use of other types of refrigerant that contain chlorine (i.e. R22) may cause the refrigerating machine oil to deteriorate.

Before installing the unit

WARNING

Do not install the unit where a gas leak may occur.

If gaseous refrigerant leaks and piles up around the unit, it may be ignited.

Do not use the unit to keep food items, animals, plants, artifacts, or for other special purposes.

The unit is not designed to preserve food products.

Do not use the unit in an unusual environment.

- ♦ Do not install the unit where a large amount of oil or steam is present or where acidic or alkaline solutions or chemical sprays are used frequently. Doing so may lead to a remarkable drop in performance, electric shock, malfunctions, smoke, and/or fire.
- ♦ The presence of organic solvents or corrosive gas (i.e. ammonia, sulfur compounds, and acid) may cause gas leakage or water leakage.

When installing the unit in a hospital, take appropriate measures to reduce noise interference.

High-frequency medical equipment may interfere with the normal operation of the air conditioner or vice versa.

Do not install the unit on or over things that cannot get wet.

When the humidity level exceeds 80% or if the drainage system is clogged, the indoor unit may drip water. Drain water is also discharged from the outdoor unit. Install a centralized drainage system if necessary.

Before installing the unit (moving and reinstalling the unit) and performing electrical work

CAUTION

Properly ground the unit.

Do not connect the grounding wire to a gas pipe, water pipe, lightning rod, or grounding wire from a telephone pole. Improper grounding may result in electric shock, smoke, fire, and/or malfunction due to noise interference.

Do not put tension on the power supply wires.

If tension is put on the wires, they may break and result in excessive heat, smoke, and/or fire.

Install an earth leakage breaker to avoid the risk of electric shock.

Failure to install an earth leakage breaker may result in electric shock, smoke, and/or fire.

Use the kind of power supply wires that are specified in the installation manual.

The use of wrong kind of power supply wires may result in current leak, electric shock, and/or fire.

Use breakers and fuses (current breaker, remote switch <switch + Type-B fuse>, moulded case circuit breaker) with the proper current capacity.

The use of wrong capacity fuses, steel wires, or copper wires may result in malfunctions, smoke, and/or fire.

Do not spray water on the air conditioner or immerse the air conditioner in water.

Otherwise, electric shock and/or fire may result.

When handling units, always wear protective gloves to protect your hands from metal parts and high-temperature parts.

Periodically check the installation base for damage.

If the unit is left on a damaged platform, it may fall and cause injury.

Properly install the drain pipes according to the instructions in the installation manual. Keep them insulated to avoid dew condensation.

Improper plumbing work may result in water leakage and damage to the furnishings.

Exercise caution when transporting products.

- ♦ Products weighing more than 20 kg should not be carried alone.
- ♦ Do not carry the product by the PP bands that are used on some products.
- ♦ Do not touch the heat exchanger fins. They are sharp and dangerous.
- ♦ When lifting the unit with a crane, secure all four corners to prevent the unit from falling.

Properly dispose of the packing materials.

- ♦ Nails and wood pieces in the package may pose a risk of injury.
- ♦ Plastic bags may pose a risk of choking hazard to children. Tear plastic bags into pieces before disposing of them.

Before the test run

 **CAUTION**

Turn on the unit at least 12 hours before the test run.

Keep the unit turned on throughout the season. If the unit is turned off in the middle of a season, it may result in malfunctions.

To avoid the risk of electric shock or malfunction of the unit, do not operate switches with wet hands.

Do not touch the refrigerant pipes with bare hands during and immediately after operation.

During or immediately after operation, certain parts of the unit such as pipes and compressor may be either very cold or hot, depending on the state of the refrigerant in the unit at the time. To reduce the risk of frost bites and burns, do not touch these parts with bare hands.

Do not operate the unit without panels and safety guards.

Rotating, high-temperature, or high-voltage parts on the unit pose a risk of burns and/or electric shock.

Do not turn off the power immediately after stopping the operation.

Keep the unit on for at least five minutes before turning off the power to prevent water leakage or malfunction.

Do not operate the unit without the air filter.

Dust particles may build up in the system and cause malfunctions.

CONTENTS

I Read Before Servicing

[1] Read Before Servicing	3
[2] Necessary Tools and Materials	4
[3] Piping Materials	5
[4] Storage of Piping	7
[5] Pipe Processing	7
[6] Brazing	8
[7] Air Tightness Test	9
[8] Vacuum Drying (Evacuation)	10
[9] Refrigerant Charging	11
[10] Remedies to be taken in case of a Refrigerant Leak	11
[11] Characteristics of the Conventional and the New Refrigerants	12
[12] Notes on Refrigerating Machine Oil	13

II Restrictions

[1] System configuration	17
[2] Types and Maximum allowable Length of Cables	18
[3] Switch Settings and Address Settings	19
[4] Sample System Connection	26
[5] An Example of a System to which an MA Remote Controller is connected	27
[6] An Example of a System to which an M-NET Remote Controller is connected	37
[7] An Example of a System to which both MA Remote Controller and M-NET Remote Controller are connected	39
[8] Restrictions on Pipe Length	41

III Outdoor Unit Components

[1] Outdoor Unit Components and Refrigerant Circuit	47
[2] Control Box of the Outdoor Unit	49
[3] Outdoor Unit Circuit Board	52

IV Remote Controller

[1] Functions and Specifications of MA and ME Remote Controllers	65
[2] Group Settings and Interlock Settings via the ME Remote Controller	66
[3] Interlock Settings via the MA Remote Controller	70
[4] Using the built-in Temperature Sensor on the Remote Controller	71

V Electrical Wiring Diagram

[1] Electrical Wiring Diagram of the Outdoor Unit	75
[2] Electrical Wiring Diagram of Transmission Booster	78

VI Refrigerant Circuit

[1] Refrigerant Circuit Diagram	81
[2] Principal Parts and Functions	82

VII Control

[1] Functions and Factory Settings of the Dipswitches	89
[2] Controlling the Outdoor Unit	96
[3] Operation Flow Chart	108

VIII Test Run Mode

[1] Items to be checked before a Test Run	115
[2] Test Run Method	116
[3] Operating Characteristic and Refrigerant Amount	117
[4] Adjusting the Refrigerant Amount	117
[5] Refrigerant Amount Adjust Mode	120
[6] The following symptoms are normal	122
[7] Standard Operation Data (Reference Data)	123

IX Troubleshooting

[1] Error Code Lists	149
[2] Responding to Error Display on the Remote Controller	152
[3] Investigation of Transmission Wave Shape/Noise	231
[4] Troubleshooting Principal Parts	234
[5] Refrigerant Leak	265
[6] Compressor Replacement Instructions	267
[7] Troubleshooting Using the Outdoor Unit LED Error Display	269

X LED Monitor Display on the Outdoor Unit Board

[1] How to Read the LED on the Service Monitor	273
--	-----



I Read Before Servicing

[1] Read Before Servicing	3
[2] Necessary Tools and Materials.....	4
[3] Piping Materials	5
[4] Storage of Piping	7
[5] Pipe Processing	7
[6] Brazing.....	8
[7] Air Tightness Test.....	9
[8] Vacuum Drying (Evacuation)	10
[9] Refrigerant Charging.....	11
[10] Remedies to be taken in case of a Refrigerant Leak.....	11
[11] Characteristics of the Conventional and the New Refrigerants	12
[12] Notes on Refrigerating Machine Oil.....	13



[1] Read Before Servicing

1. Check the type of refrigerant used in the system to be serviced.

Refrigerant Type

Multi air conditioner for building application CITY MULTI THMU-A, YHMU-A series R410A

2. Check the symptoms exhibited by the unit to be serviced.

Refer to this service handbook for symptoms relating to the refrigerant cycle.

3. Thoroughly read the safety precautions at the beginning of this manual.

4. Preparing necessary tools: Prepare a set of tools to be used exclusively with each type of refrigerant.

Refer to "Necessary Tools and Materials" for information on the use of tools.(page 4)

5. Verification of the connecting pipes: Verify the type of refrigerant used for the unit to be moved or replaced.

- Use refrigerant pipes made of phosphorus deoxidized copper. Keep the inner and outer surfaces of the pipes clean and free of such contaminants as sulfur, oxides, dust, dirt, shaving particles, oil, and water.
- These types of contaminants inside the refrigerant pipes may cause the refrigerant oil to deteriorate.

6. If there is a leak of gaseous refrigerant and the remaining refrigerant is exposed to an open flame, a poisonous gas hydrofluoric acid may form. Keep workplace well ventilated.



CAUTION

- Install new pipes immediately after removing old ones to keep moisture out of the refrigerant circuit.
- The use of refrigerant that contains chloride, such as R22, will cause the refrigerating machine oil to deteriorate.

[2] Necessary Tools and Materials

Prepare the following tools and materials necessary for installing and servicing the unit.

Tools for use with R410A (Adaptability of tools that are for use with R22 or R407C)

1. To be used exclusively with R410A (not to be used if used with R22 or R407C)

Tools/Materials	Use	Notes
Gauge Manifold	Evacuation and refrigerant charging	Higher than 5.09MPa[738psi] on the high-pressure side
Charging Hose	Evacuation and refrigerant charging	The hose diameter is larger than the conventional model.
Refrigerant Recovery Cylinder	Refrigerant recovery	
Refrigerant Cylinder	Refrigerant charging	The refrigerant type is indicated. The cylinder is pink.
Charging Port on the Refrigerant Cylinder	Refrigerant charging	The charge port diameter is larger than that of the current port.
Flare Nut	Connection of the unit with the pipes	Use Type-2 Flare nuts.

2. Tools and materials that may be used with R410A with some restrictions

Tools/Materials	Use	Notes
Gas Leak Detector	Gas leak detection	The ones for use with HFC refrigerant may be used.
Vacuum Pump	Vacuum drying	May be used if a check valve adapter is attached.
Flare Tool	Flare processing	Flare processing dimensions for the piping in the system using the new refrigerant differ from those of R22. Refer to next page.
Refrigerant Recovery Equipment	Refrigerant recovery	May be used if compatible with R410A.

3. Tools and materials that are used with R22 or R407C that may also be used with R410A

Tools/Materials	Use	Notes
Vacuum Pump with a Check Valve	Vacuum drying	
Bender	Bending pipes	
Torque Wrench	Tightening flare nuts	Only the flare processing dimensions for pipes that have a diameter of $\varnothing 12.70$ (1/2") and $\varnothing 15.88$ (5/8") have been changed.
Pipe Cutter	Cutting pipes	
Welder and Nitrogen Cylinder	Welding pipes	
Refrigerant Charging Meter	Refrigerant charging	
Vacuum Gauge	Vacuum level check	

4. Tools and materials that must not be used with R410A

Tools/Materials	Use	Notes
Charging Cylinder	Refrigerant charging	Prohibited to use

Tools for R410A must be handled with special care to keep moisture and dust from infiltrating the cycle.

[3] Piping Materials

Do not use the existing piping!

1. Copper pipe materials

O-material (Annealed)	Soft copper pipes (annealed copper pipes). They can easily be bent with hands.
1/2H-material (Drawn)	Hard copper pipes (straight pipes). They are stronger than the O-material (Annealed) at the same radial thickness.

- ♦The distinction between O-materials (Annealed) and 1/2H-materials (Drawn) is made based on the strength of the pipes themselves.
- ♦O-materials (Annealed) can easily be bent with hands.
- ♦1/2H-materials (Drawn) are considerably stronger than O-material (Annealed) at the same thickness.

2. Types of copper pipes

Maximum working pressure	Refrigerant type
3.45 MPa [500psi]	R22, R407C etc.
4.30 MPa [624psi]	R410A etc.

3. Piping materials/Radial thickness

Use refrigerant pipes made of phosphorus deoxidized copper.
 The operation pressure of the units that use R410A is higher than that of the units that use R22.
 Use pipes that have at least the radial thickness specified in the chart below.
 (Pipes with a radial thickness of 0.7 mm or less may not be used.)

Pipe size (mm[in])	Radial thickness (mm)	Type
ø6.35 [1/4"]	0.8t	O-material (Annealed)
ø9.52 [3/8"]	0.8t	
ø12.7 [1/2"]	0.8t	
ø15.88 [5/8"]	1.0t	
ø19.05 [3/4"]	1.0t	1/2H-material, H-material (Drawn)
ø22.2 [7/8"]	1.0t	
ø25.4 [1"]	1.0t	
ø28.58 [1-1/8"]	1.0t	
ø31.75 [1-1/4"]	1.1t	
ø34.93 [1-3/8"]	1.1t	
ø41.28 [1-5/8"]	1.2t	

- ♦The pipes in the system that uses the refrigerant currently on the market are made with O-material (Annealed), even if the pipe diameter is less than ø19.05 (3/4"). For a system that uses R410A, use pipes that are made with 1/2H-material (Drawn) unless the pipe diameter is at least ø19.05 (3/4") and the radial thickness is at least 1.2t.
- ♦The figures in the radial thickness column are based on the Japanese standards and provided only as a reference. Use pipes that meet the local standards.

4. Thickness and refrigerant type indicated on the piping materials

Ask the pipe manufacturer for the symbols indicated on the piping material for new refrigerant.

5. Flare processing (O-material (Annealed) and OL-material only)

The flare processing dimensions for the pipes that are used in the R410A system are larger than those in the R22 system.

Flare processing dimensions (mm[in])

Pipe size (mm[in])		A dimension (mm)	
		R410A	R22, R407C
ø6.35	[1/4"]	9.1	9.0
ø9.52	[3/8"]	13.2	13.0
ø12.7	[1/2"]	16.6	16.2
ø15.88	[5/8"]	19.7	19.4
ø19.05	[3/4"]	24.0	23.3

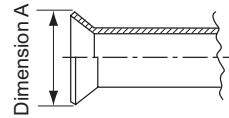

If a clutch-type flare tool is used to flare the pipes in the system using R410A, the length of the pipes must be between 1.0 and 1.5 mm. For margin adjustment, a copper pipe gauge is necessary.

6. Flare nut

The flare nut type has been changed to increase the strength. The size of some of the flare nuts have also been changed.

Flare nut dimensions (mm[in])

Pipe size (mm[in])		B dimension (mm)	
		R410A	R22, R407C
ø6.35	[1/4"]	17.0	17.0
ø9.52	[3/8"]	22.0	22.0
ø12.7	[1/2"]	26.0	24.0
ø15.88	[5/8"]	29.0	27.0
ø19.05	[3/4"]	36.0	36.0

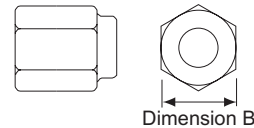

The figures in the radial thickness column are based on the Japanese standards and provided only as a reference. Use pipes that meet the local standards.

[4] Storage of Piping

1. Storage location



Store the pipes to be used indoors. (Warehouse at site or owner's warehouse)
If they are left outdoors, dust, dirt, or moisture may infiltrate and contaminate the pipe.

2. Sealing the pipe ends

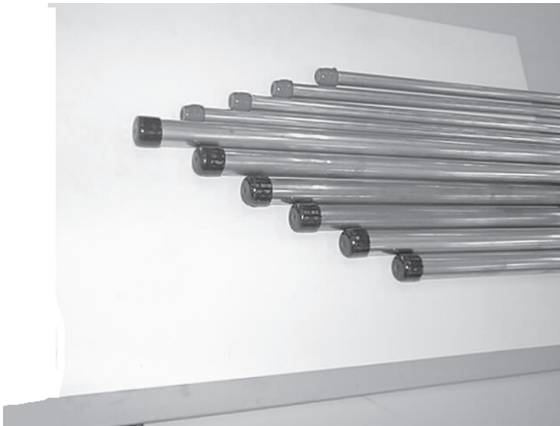

Both ends of the pipes should be sealed until just before brazing.
Keep elbow pipes and T-joints in plastic bags.

The new refrigerator oil is 10 times as hygroscopic as the conventional refrigerating machine oil (such as Suniso) and, if not handled with care, could easily introduce moisture into the system. Keep moisture out of the pipes, for it will cause the oil to deteriorate and cause a compressor failure.

[5] Pipe Processing

Use a small amount of ester oil, ether oil, or alkylbenzene to coat flares and flanges.

Note

- Use a minimum amount of oil.
- Use only ester oil, ether oil, and alkylbenzene.

[6] Brazing

No changes have been made in the brazing procedures. Perform brazing with special care to keep foreign objects (such as oxide scale, water, and dust) out of the refrigerant system.

Example: Inside the brazed connection

Use of oxidized solder for brazing

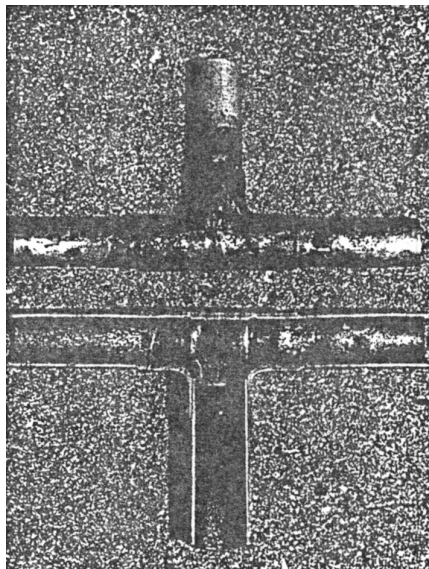

Use of non-oxidized solder for brazing

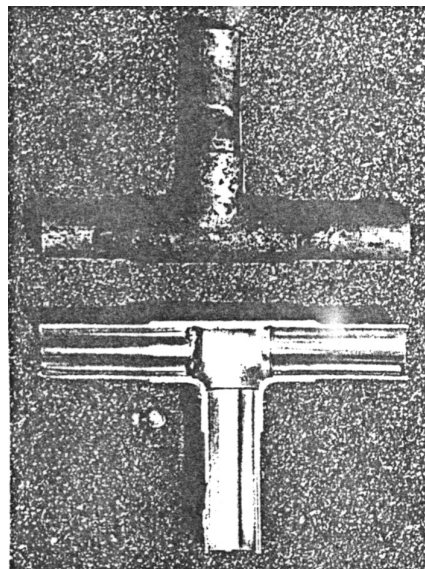

1. Items to be strictly observed

- ♦ Do not conduct refrigerant piping work outdoors if raining.
- ♦ Use non-oxidized solder.
- ♦ Use a brazing material (BCuP-3) that requires no flux when brazing between copper pipes or between a copper pipe and copper coupling.
- ♦ If installed refrigerant pipes are not immediately connected to the equipment, then braze and seal both ends.

2. Reasons

- ♦ The new refrigerating machine oil is 10 times as hygroscopic as the conventional oil and is more likely to cause unit failure if water infiltrates into the system.
- ♦ Flux generally contains chloride. Residual flux in the refrigerant circuit will cause sludge to form.

3. Notes

Do not use commercially available antioxidants because they may cause the pipes to corrode or refrigerating machine oil to deteriorate.

[7] Air Tightness Test

No changes have been made in the detection method. Note that a refrigerant leak detector for R22 will not detect an R410A leak.

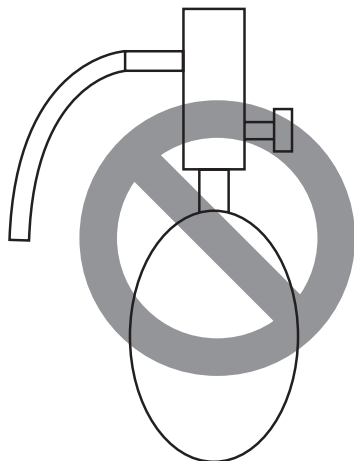

Halide torch

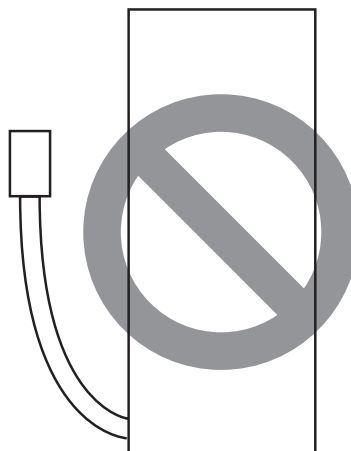

R22 leakage detector

1. Items to be strictly observed

- Pressurize the equipment with nitrogen up to the design pressure (4.15MPa[601psi]), and then judge the equipment's air tightness, taking temperature variations into account.
- Refrigerant R410A must be charged in its liquid state (vs. gaseous state).

2. Reasons

- Oxygen, if used for an air tightness test, poses a risk of explosion. (Only use nitrogen to check air tightness.)
- Refrigerant R410A must be charged in its liquid state. If gaseous refrigerant in the cylinder is drawn out first, the composition of the remaining refrigerant in the cylinder will change and become unsuitable for use.

3. Notes

Procure a leak detector that is specifically designed to detect an HFC leak. A leak detector for R22 will not detect an HFC(R410A) leak.

[8] Vacuum Drying (Evacuation)



(Photo1) 15010H



(Photo2) 14010

Recommended vacuum gauge:
ROBINAIR 14010 Thermistor Vacuum Gauge

1. Vacuum pump with a reverse-flow check valve (Photo1)

To prevent the vacuum pump oil from flowing into the refrigerant circuit during power OFF or power failure, use a vacuum pump with a reverse-flow check valve.

A reverse-flow check valve may also be added to the vacuum pump currently in use.

2. Standard of vacuum degree (Photo 2)

Use a vacuum pump that attains 0.5Torr(65Pa) or lower degree of vacuum after 5 minutes of operation, and connect it directly to the vacuum gauge. Use a pump well-maintained with an appropriate lubricant. A poorly maintained vacuum pump may not be able to attain the desired degree of vacuum.

3. Required precision of vacuum gauge

Use a vacuum gauge that registers a vacuum degree of 5Torr(650Pa) and measures at intervals of 1Torr(130Pa). (A recommended vacuum gauge is shown in Photo2.)

Do not use a commonly used gauge manifold because it cannot register a vacuum degree of 5Torr(650Pa).

4. Evacuation time

- ♦After the degree of vacuum has reached 5Torr(650Pa), evacuate for an additional 1 hour. (A thorough vacuum drying removes moisture in the pipes.)

- ♦Verify that the vacuum degree has not risen by more than 1Torr(130Pa) 1hour after evacuation. A rise by less than 1Torr(130Pa) is acceptable.

- ♦If the vacuum is lost by more than 1Torr(130Pa), conduct evacuation, following the instructions in section 6. Special vacuum drying.

5. Procedures for stopping vacuum pump

To prevent the reverse flow of vacuum pump oil, open the relief valve on the vacuum pump side, or draw in air by loosening the charge hose, and then stop the operation.

The same procedures should be followed when stopping a vacuum pump with a reverse-flow check valve.

6. Special vacuum drying

- ♦When 5Torr(650Pa) or lower degree of vacuum cannot be attained after 3 hours of evacuation, it is likely that water has penetrated the system or that there is a leak.

- ♦If water infiltrates the system, break the vacuum with nitrogen. Pressurize the system with nitrogen gas to 0.5kgf/cm²G(0.05MPa) and evacuate again. Repeat this cycle of pressurizing and evacuation either until the degree of vacuum below 5Torr(650Pa) is attained or until the pressure stops rising.

- ♦Only use nitrogen gas for vacuum breaking. (The use of oxygen may result in an explosion.)

[9] Refrigerant Charging

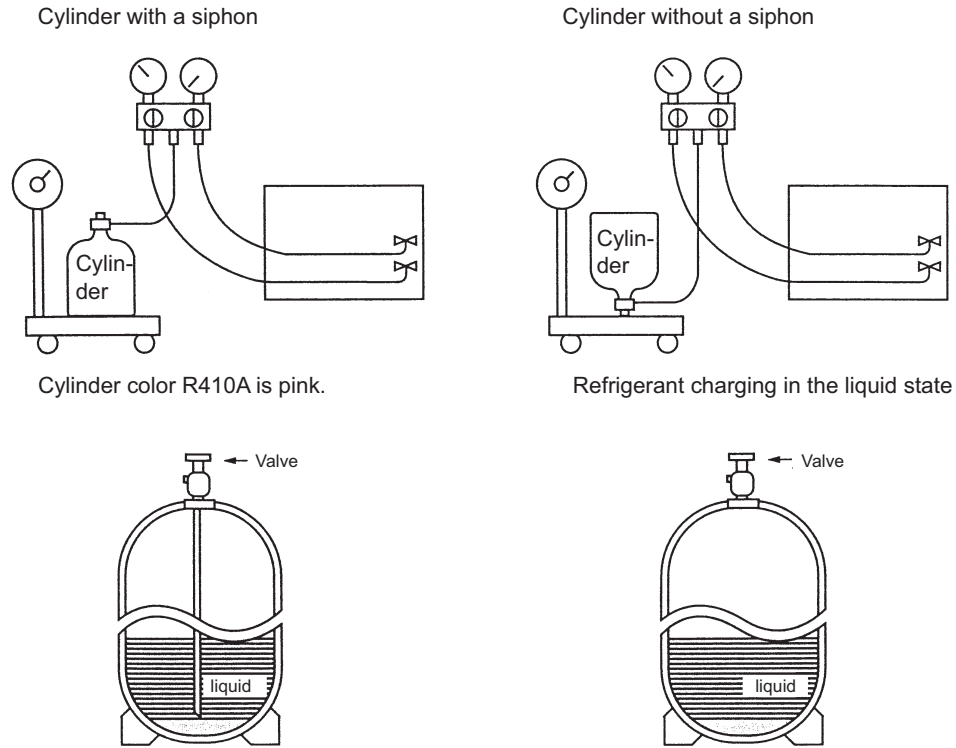

1. Reasons

R410A is a pseudo-azeotropic HFC blend (boiling point R32=-52°C[-62°F], R125=-49°C[-52°F]) and can almost be handled the same way as a single refrigerant, such as R22. To be safe, however, draw out the refrigerant from the cylinder in the liquid phase. If the refrigerant in the gaseous phase is drawn out, the composition of the remaining refrigerant will change and become unsuitable for use.

2. Notes

When using a cylinder with a siphon, refrigerant is charged in the liquid state without the need for turning it upside down. Check the type of the cylinder on the label before use.

[10] Remedies to be taken in case of a Refrigerant Leak

If the refrigerant leaks out, it may be replenished. The entire refrigerant does not need to be replaced. (Charge refrigerant in the liquid state.)

Refer to "IX [5] Refrigerant Leak".(page 265)

[11] Characteristics of the Conventional and the New Refrigerants

1. Chemical property

As with R22, the new refrigerant (R410A) is low in toxicity and chemically stable nonflammable refrigerant. However, because the specific gravity of vapor refrigerant is greater than that of air, leaked refrigerant in a closed room will accumulate at the bottom of the room and may cause hypoxia. If exposed to an open flame, refrigerant will generate poisonous gases. Do not perform installation or service work in a confined area.

	New Refrigerant (HFC type)		Conventional Refrigerant (HCFC type)
	R410A	R407C	R22
	R32/R125	R32/R125/R134a	R22
Composition (wt%)	(50/50)	(23/25/52)	(100)
Type of Refrigerant	Pseudo-azeotropic Refrigerant	Non-azeotropic Refrigerant	Single Refrigerant
Chloride	Not included	Not included	Included
Safety Class	A1/A1	A1/A1	A1
Molecular Weight	72.6	86.2	86.5
Boiling Point (°C/°F)	-51.4/-60.5	-43.6/-46.4	-40.8/-41.4
Steam Pressure (25°C,MPa/77°F,psi) (gauge)	1.557/226	0.9177/133	0.94/136
Saturated Steam Density (25°C,kg/m ³ /77°F,psi)	64.0	42.5	44.4
Flammability	Nonflammable	Nonflammable	Nonflammable
Ozone Depletion Coefficient (ODP)^{*1}	0	0	0.055
Global Warming Coefficient (GWP) ^{*2}	1730	1530	1700
Refrigerant Charging Method	Refrigerant charging in the liquid state	Refrigerant charging in the liquid state	Refrigerant charging in the gaseous state
Replenishment of Refrigerant after a Refrigerant Leak	Available	Available	Available

*1 When CFC11 is used as a reference

*2 When CO₂ is used as a reference

2. Refrigerant composition

R410A is a pseudo-azeotropic HFC blend and can almost be handled the same way as a single refrigerant, such as R22. To be safe, however, draw out the refrigerant from the cylinder in the liquid phase. If the refrigerant in the gaseous phase is drawn out, the composition of the remaining refrigerant will change and become unsuitable for use. If the refrigerant leaks out, it may be replenished. The entire refrigerant does not need to be replaced.

3. Pressure characteristics

The pressure in the system using R410A is 1.6 times as great as that in the system using R22.

Temperature (°C/°F)	Pressure (gauge)		
	R410A	R407C	R22
	MPa/psi	MPa/psi	MPa/psi
-20/-4	0.30/44	0.18/26	0.14/20
0/32	0.70/102	0.47/68	0.40/58
20/68	1.34/194	0.94/136	0.81/117
40/104	2.31/335	1.44/209	1.44/209
60/140	3.73/541	2.44/354	2.33/338
65/149	4.17/605	2.75/399	2.60/377

[12] Notes on Refrigerating Machine Oil

1. Refrigerating machine oil in the HFC refrigerant system

HFC type refrigerants use a refrigerating machine oil different from that used in the R22 system.
Note that the ester oil used in the system has properties that are different from commercially available ester oil.

Refrigerant	Refrigerating machine oil
R22	Mineral oil
R407C	Ester oil
R410A	Ester oil

2. Effects of contaminants*1

Refrigerating machine oil used in the HFC system must be handled with special care to keep contaminants out.
The table below shows the effect of contaminants in the refrigerating machine oil on the refrigeration cycle.

3. The effects of contaminants in the refrigerating machine oil on the refrigeration cycle.

Cause		Symptoms	Effects on the refrigerant cycle
Water infiltration		Frozen expansion valve and capillary tubes	Clogged expansion valve and capillary tubes Poor cooling performance Compressor overheat
		Hydrolysis	Motor insulation failure Burnt motor Coppering of the orbiting scroll Lock Burn-in on the orbiting scroll
Air infiltration		Oxidization	
Infiltration of contaminants	Dust, dirt	Adhesion to expansion valve and capillary tubes	Clogged expansion valve, capillary tubes, and drier Poor cooling performance Compressor overheat
		Infiltration of contaminants into the compressor	Burn-in on the orbiting scroll
	Mineral oil etc.	Sludge formation and adhesion	Clogged expansion valve and capillary tubes Poor cooling performance Compressor overheat
		Oil degradation	Burn-in on the orbiting scroll

*1. Contaminants is defined as moisture, air, processing oil, dust/dirt, wrong types of refrigerant, and refrigerating machine oil.

II Restrictions

[1] System configuration	17
[2] Types and Maximum allowable Length of Cables	18
[3] Switch Settings and Address Settings	19
[4] Sample System Connection.....	26
[5] An Example of a System to which an MA Remote Controller is connected.....	27
[6] An Example of a System to which an M-NET Remote Controller is connected.....	37
[7] An Example of a System to which both MA Remote Controller and M-NET Remote Controller are connected.....	39
[8] Restrictions on Pipe Length.....	41



[1] System configuration

1. Table of compatible indoor units

The table below summarizes the types of indoor units that are compatible with different types of outdoor units.

Outdoor units	Composing units			Maximum total capacity of connectable indoor units	Maximum number of connectable indoor units	Types of connectable indoor units
72	-	-	-	36 - 96	15	P06 - P96models R410A series indoor units
96	-	-	-	48 - 124	20	
120	-	-	-	60 - 156	26	
144	72	72	-	72 - 187	31	
168	96	72	-	84 - 218	36	
192	120	72	-	96 - 249	41	
216	120	96	-	108 - 280	46	
240	120	120	-	120 - 312	50	
264	120	72	72	132 - 343		
288	120	96	72	144 - 374		
312	120	120	72	156 - 405		
336	120	120	96	168 - 436		
360	120	120	120	180 - 468		

Note

- 1) "Maximum total capacity of connectable indoor units" refers to the sum of the numeric values in the indoor unit model names.
- 2) If the total capacity of the indoor units that are connected to a given outdoor unit exceeds the capacity of the outdoor unit, the indoor units will not be able to perform at the rated capacity when they are operated simultaneously. Select a combination of units so that the total capacity of the connected indoor units is at or below the capacity of the outdoor unit whenever possible.

[2] Types and Maximum allowable Length of Cables

1. Wiring work

(1) Notes

- 1) Have all electrical work performed by an authorized electrician according to the local regulations and instructions in this manual.
- 2) Install external transmission cables at least 5cm [1-31/32"] away from the power supply cable to avoid noise interference. (Do not put the control cable and power supply cable in the same conduit tube.)
- 3) Provide grounding for the outdoor unit as required.
- 4) Run the cable from the electric box of the indoor or outdoor unit in such way that the box is accessible for servicing.
- 5) Do not connect power supply wiring to the terminal block for transmission line. Doing so will damage the electronic components on the terminal block.
- 6) Use 2-core shielded cables as transmission cables.

Use a separate 2-core control cable for each refrigerant system. Do not use a single multiple-core cable to connect indoor units that belong to different refrigerant systems. The use of a multiple-core cable may result in signal transmission errors and malfunctions.

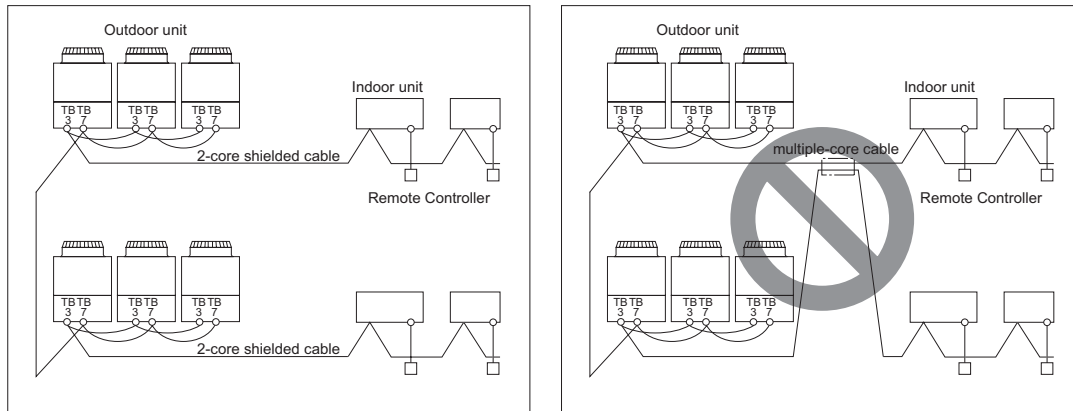

TB3: Terminal block for indoor-outdoor transmission line TB7: Terminal block for centralized control

(2) Control wiring

Different types of control wiring are used for different systems.

Refer to section "[5] An Example of a System to which an MA Remote Controller is connected - [7] An Example of a System to which both MA Remote Controller and M-NET Remote Controller are connected" before performing wiring work.

Types and maximum allowable length of cables

Control lines are categorized into 2 types: transmission line and remote controller line.

Use the appropriate type of cables and observe the maximum allowable length specified for a given system. If a given system has a long transmission line or if a noise source is located near the unit, place the unit away from the noise source to reduce noise interference.

1) M-NET transmission line

Cable type	Facility type	All facility types
	Type	Shielded cable CVVS, CPEVS, MVVS
	Number of cores	2-core cable
	Cable size	Larger than 1.25mm ² [AWG16]
Maximum transmission line distance between the outdoor unit and the farthest indoor unit		200 m [656ft] max.
Maximum transmission line distance for centralized control and Indoor/outdoor transmission line (Maximum line distance via outdoor unit)		500 m [1640ft] max. *The maximum overall line length from the power supply unit on the transmission lines for centralized control to each outdoor unit or to the system controller is 200m [656ft] max.

2) Remote controller wiring

		MA remote controller ^{*1}	M-NET remote controller ^{*2}
Cable type	Type	CVV	CVV
	Number of cores	2-core cable	2-core cable
	Cable size	0.3 to 1.25mm ² ^{*3} [AWG22 to 16] (0.75 to 1.25mm ²) ^{*4} [AWG18 to 16]	0.3 to 1.25mm ² ^{*3} [AWG22 to 16] (0.75 to 1.25mm ²) ^{*4} [AWG18 to 16]
Maximum overall line length		200 m [656ft] max.	The section of the cable that exceeds 10m [32ft] must be included in the maximum indoor-outdoor transmission line distance.

*1 MA remote controller refers to MA remote controller (PAR-20MAA, PAR-21MAA), MA simple remote controller, and wireless remote controller.

*2 M-NET remote controller refers to ME remote controller and ME simple remote controller.

*3 The use of cables that are smaller than 0.75mm² (AWG18) is recommended for easy handling.

*4 When connected to the terminal block on the Simple remote controller, use cables that meet the cable size specifications shown in the parenthesis.

[3] Switch Settings and Address Settings

1. Switch setting

Refer to section "[5] An Example of a System to which an MA Remote Controller is connected - [7] An Example of a System to which both MA Remote Controller and M-NET Remote Controller are connected" before performing wiring work. Set the switches while the power is turned off.

If the switch settings are changed while the unit is being powered, those changes will not take effect, and the unit will not function properly.

Units on which to set the switches		Symbol	Units to which the power must be shut off
CITY MULTI indoor unit	Main/sub unit	IC	Outdoor units ^{*3} and Indoor units
LOSSNAY, OA processing unit ^{*1}		LC	Outdoor units ^{*3} and LOSSNAY
Air handling kit		IC	Outdoor units ^{*3} or field supplied air handling unit
M-NET remote controller	Main/sub remote controller	RC	Outdoor units ^{*3}
MA remote controller	Main/sub remote controller	MA	Indoor units
CITY MULTI outdoor unit ^{*2}		OC,OS1,OS2	Outdoor units ^{*3}

*1. Applicable when LOSSNAY units are connected to the indoor-outdoor transmission line.

*2. The outdoor units in the same refrigerant circuit are automatically designated as OC, OS1, and OS2 in the order of capacity from large to small (if two or more units have the same capacity, in the order of address from small to large).

*3. Turn off the power to all the outdoor units in the same refrigerant circuit.

2. M-NET Address settings

(1) Address settings table

The need for address settings and the range of address setting depend on the configuration of the system.

Unit or controller		Address setting range	Setting method	Factory setting
CITY MULTI indoor unit	Main/sub unit	00, 01 to 50* ¹	Assign the smallest address to the main indoor unit in the group, and assign sequential address numbers to the rest of the indoor units in the same group. * ⁴	00
M-NET adapter				
M-NET control interface				
Free Plan adapter				
LOSSNAY, OA processing unit Air handling kit		00, 01 to 50* ¹	Assign an arbitrary but unique address to each of these units after assigning an address to all indoor units.	00
M-NET remote controller	Main remote controller	101 to 150	Add 100 to the smallest address of all the indoor units in the same group.	101
	Sub remote controller	151 to 200* ²	Add 150 to the smallest address of all the indoor units in the same group.	
MA remote controller		No address settings required. (The main/sub setting must be made if 2 remote controllers are connected to the system.)		Main
CITY MULTI outdoor unit		00, 51 to 100* ^{1,3}	Assign sequential addresses to the outdoor units in the same refrigerant circuit. The outdoor units in the same refrigerant circuit are automatically designated as OC and OS. * ⁵	00
System controller	Group remote controller	201 to 250	Assign an address that equals the sum of the smallest group number of the group to be controlled and 200.	201
	System remote controller		Assign an arbitrary but unique address within the range listed on the left to each unit.	
	ON/OFF remote controller		Assign an address that equals the sum of the smallest group number of the group to be controlled and 200.	
	Schedule timer (compatible with M-NET)		Assign an arbitrary but unique address within the range listed on the left to each unit.	202
	Central controller G(B)-50A	000, 201 to 250	Assign an arbitrary but unique address within the range listed on the left to each unit. The address must be set to "000" to control the K-control unit.	000
	LM adapter	201 to 250	Assign an arbitrary but unique address within the range listed on the left to each unit.	247

*1. Address setting is not required for a City Multi system that consists of a single refrigerant circuit (with some exceptions).

*2. To set the M-NET remote controller address to "200", set the rotary switches to "00".

*3. To set the outdoor unit address to "100," set the rotary switches to "50."

*4. Some indoor units have 2 or 3 controller boards that require address settings.

No. 2 controller board address must be equal to the sum of the No. 1 controller board address and 1, and the No.3 controller board address must equal to the No. 1 controller address and 2.

*5. The outdoor units in the same refrigerant circuit are automatically designated as OC, OS1, and OS2 in the order of capacity from large to small (if two or more units have the same capacity, in the order of address from small to large).

**(2) Power supply switch connector connection on the outdoor unit
(Factory setting: The male power supply switch connector is connected to CN41.)**

System configuration	Connection to the system controller	Power supply unit for transmission lines	Group operation of units in a system with multiple outdoor units	Power supply switch connector connection
System with one outdoor unit	–	–	–	Leave CN41 as it is (Factory setting)
System with multiple outdoor units	Not connected	–	Not grouped	Disconnect the male connector from the female power supply switch connector (CN41) and connect it to the female power supply switch connector (CN40) on only one of the outdoor units.*2
	With connection to the indoor unit system	Not required	Grouped/not grouped	
	With connection to the centralized control system	Not required*1 (Powered from the outdoor unit)	Grouped/not grouped	*Connect the S (shielded) terminal on the terminal block (TB7) on the outdoor unit whose CN41 was replaced with CN40 to the ground terminal (⌚) on the electric box.
		Required *1	Grouped/not grouped	Leave CN41 as it is (Factory setting)

*1 The need for a power supply unit for transmission lines depends on the system configuration.

*2 The replacement of the power jumper connector from CN41 to CN40 must be performed on only one outdoor unit in the system.

(3) Settings for the centralized control switch for the outdoor unit (Factory setting: SW2-1 are set to OFF.)

System configuration	Centralized control switch settings *1
Connection to the system controller Not connected	Leave it to OFF. (Factory setting)
Connection to the system controller Connected *2	ON

*1 Set SW2-1 on all outdoor units in the same refrigerant circuit to the same setting.

*2 When only the LM adapter is connected, leave SW2-1 to OFF (as it is).

(4) Selecting the position of temperature detection for the indoor unit (Factory setting: SW1-1 set to "OFF").

To stop the fan during heating Thermo-OFF (SW1-7 and 1-8 on the indoor units to be set to ON), use the built-in thermistor on the remote controller or an optional thermistor.

- 1) To use the built-in sensor on the remote controller, set the SW1-1 to ON.
 - ♦Some models of remote controllers are not equipped with a built-in temperature sensor. Use the built-in temperature sensor on the indoor unit instead.
 - ♦When using the built-in sensor on the remote controller, install the remote controller where room temperature can be detected. (Note) Factory setting for SW1-1 on the indoor unit of the All-Fresh Models is ON.
- 2) When an optional temperature sensor is used, set SW1-1 to OFF, and set SW3-8 to ON.
 - ♦When using an optional temperature sensor, install it where room temperature can be detected.

(5) Various start-stop controls (Indoor unit settings)

Each indoor unit (or group of indoor units) can be controlled individually by setting SW 1-9 and 1-10.

Function	Operation of the indoor unit when the operation is resumed after the unit was stopped	Setting (SW1)*4 *5	
		9	10
Power ON/OFF by the plug*1,*2,*3	Indoor unit will go into operation regardless of its operation status before power off (power failure). (In approx. 5 minutes)	OFF	ON
Automatic restoration after power failure	Indoor unit will go into operation if it was in operation when the power was turned off (or cut off due to power failure). (In approx. 5 minutes)	ON	OFF
	Indoor unit will remain stopped regardless of its operation status before power off (power failure).	OFF	ON

*1. Do not cut off power to the outdoor unit. Cutting off the power supply to the outdoor unit will cut off the power supply to the crankcase heater and may cause the compressor to malfunction when the unit is put back into operation.

*2. Not applicable to units with a built-in drain pump or humidifier.

*3. Models with a built-in drain pump cannot be turned on/off by the plug individually. All the units in the same refrigerant circuits will be turned on or off by the plug.

*4. Requires that the dipswitch settings for all the units in the group be made.

*5. To control the external input to and output from the air conditioners with the PLC software for general equipment via the G(B)-50A, set SW1-9 and SW1-10 to ON. With these settings made, the power start-stop function becomes disabled. To use the auto recovery function after power failure while these settings are made, set SW1-5 to ON.

(6) Miscellaneous settings

Cooling-only setting for the indoor unit: Cooling only model (Factory setting: SW3-1 "OFF.")
 When using indoor unit as a cooling-only unit, set SW3-1 to ON.

(7) Various types of control using input-output signal connector on the outdoor unit (various connection options)

Type	Usage	Function	Terminal to be used ^{*1}	Option
Input	Prohibiting cooling/heating operation (thermo OFF) by an external input to the outdoor unit. *It can be used as the DEMAND control device for each system.	DEMAND (level)	CN3D ^{*2}	Adapter for external input (PAC-SC36NA-E)
	Performs a low level noise operation of the outdoor unit by an external input to the outdoor unit. * It can be used as the silent operation device for each refrigerant system.	Low-noise mode (level) ^{*3*4}		
	Forces the outdoor unit to perform a fan operation by receiving signals from the snow sensor. ^{*5}	Snow sensor signal input (level)	CN3S	
	Cooling/heating operation can be changed by an external input to the outdoor unit.	Auto-changeover	CN3N	
Out-put	How to extract signals from the outdoor unit *It can be used as an operation status display device. *It can be used for an interlock operation with external devices.	Operation status of the compressor ^{*5}	CN51	Adapter for external output (PAC-SC37SA-E)
		Error status ^{*6}		

*1. For detailed drawing, refer to "Example of wiring connection".

*2. For details, refer to (1) through (4) shown below.

*3. Low-noise mode is valid when Dip SW4-4 on the outdoor unit is set to OFF. When DIP SW4-4 is set to ON, 4 levels of on-DEMAND are possible, using different configurations of low-noise mode input and DEMAND input settings. When 2 or more outdoor units exist in one refrigerant circuit system, 8 levels of on-DEMAND are possible. When 3 outdoor units exist in one refrigerant circuit system, 12 levels of on-DEMAND are possible.

*4. By setting Dip SW5-5, the Low-noise mode can be switched between the Capacity priority mode and the Low-noise priority mode.
 When SW5-5 is set to ON: The Low-noise mode always remains effective.
 When SW5-5 is set to OFF: The Low-noise mode is cancelled when certain outside temperature or pressure criteria are met, and the unit goes into normal operation (capacity priority mode).

Low-noise mode is effective		Capacity priority mode becomes effective	
Cooling	Heating	Cooling	Heating
TH7 < 30°C [86°F] and 63HS1 < 32kg/cm ²	TH7 > 3°C [37°F] and 63LS > 4.6kg/cm ²	TH7 > 35°C [95°F] or 63HS1 > 35kg/cm ²	TH7 < 0°C [32°F] or 63LS < 3.9kg/cm ²

*5. Each outdoor unit in the system with multiple outdoor units requires the signal input/output setting to be made.

*6. Take out signals from the outdoor unit (OC) if multiple outdoor units exist in a single system.

⚠ CAUTION

- 1) Wiring should be covered by insulation tube with supplementary insulation.
- 2) Use relays or switches with IEC or equivalent standard.
- 3) The electric strength between accessible parts and control circuit should have 2750V or more.

Example of wiring connection

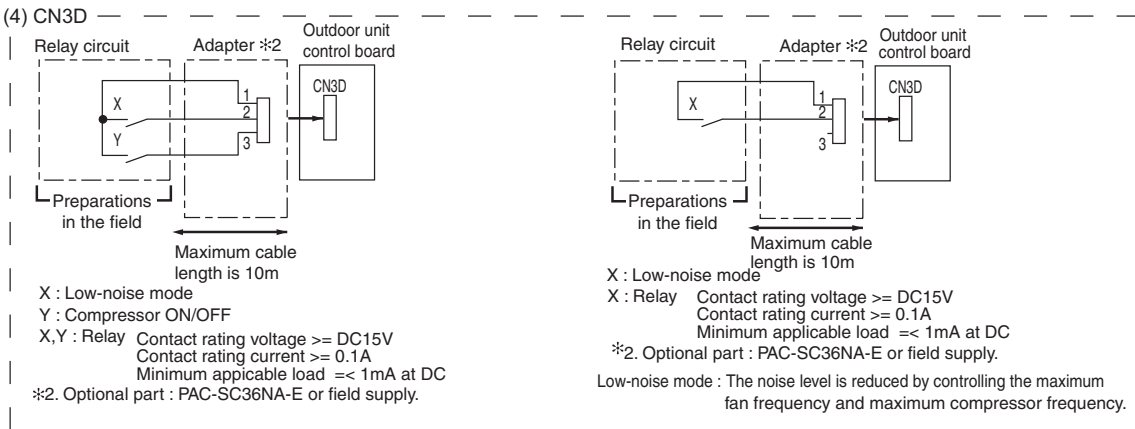
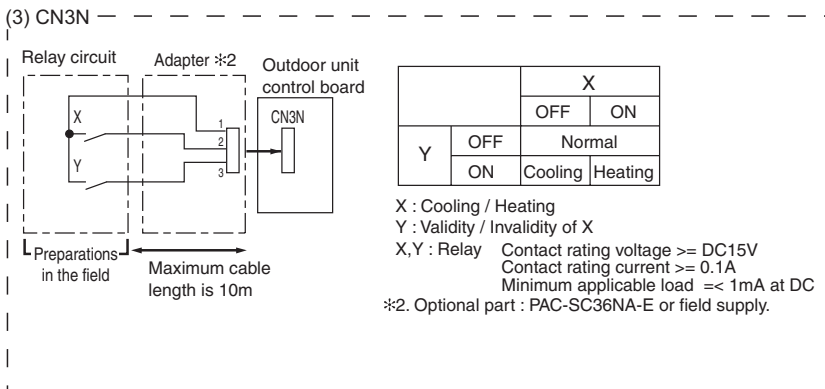
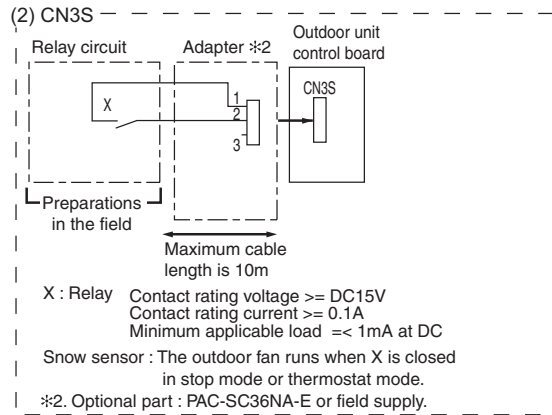
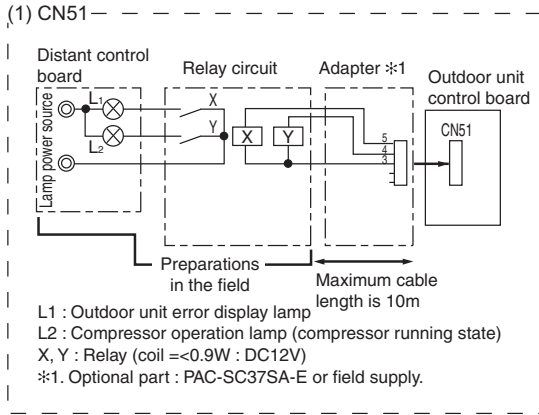

[II Restrictions]

1) SW4-4: OFF (Compressor ON/OFF, Low-noise mode)

CN3D 1-3P	Compressor ON/OFF *1
Open	Compressor ON
Short-circuit	Compressor OFF

CN3D 1-2P	Low-noise mode *2
Open	OFF
Short-circuit	ON

*1. When SW4-4 on the outdoor unit in one refrigerant circuit system is set to ON , this function cannot be used.

*2. This function and the 4 levels or 8 levels on-DEMAND function can be used together. Input the order to CN3D 1-2P on the outdoor unit whose SW4-4 is set to OFF.

2) When SW4-4 on one outdoor unit in one refrigerant circuit system is set to ON (4 levels of on-DEMAND) (*3)

	CN3D 1-2P	
CN3D 1-3P	Open	Short-circuit
Open	100% (No DEMAND)	75%
Short-circuit	0% (Compressor OFF)	50%

*3. Input the order to CN3D on the outdoor unit whose SW4-4 is set to ON.

Note the following steps to be taken when using the STEP DEMAND

(Example) When switching from 100% to 50%

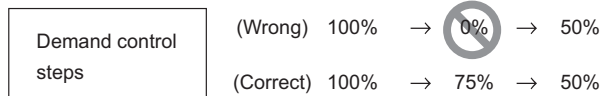

If the step listed as the wrong example above is taken, thermo may go off.
The percentage of the demand listed in the table above is an approximate value based on the compressor volume and does not necessarily correspond with the capacity.
When this function is enabled, the night mode cannot be enabled.

3) When SW4-4 on the two outdoor units in one refrigerant circuit system is set to ON (8 levels of on-DEMAND) (*4, *5)

8 levels of on-DEMAND		No.2 CN3D				
		1-2P	Open		Short-circuit	
No.1 CN3D	1-2P	1-3P	Open	Short-circuit	Open	Short-circuit
	Open	Open	100%	50%	88%	75%
		Short-circuit	50%	0%	38%	25%
	Short-circuit	Open	88%	38%	75%	63%
Short-circuit		75%	25%	63%	50%	

*4. Input the order to CN3D on the outdoor unit whose SW4-4 is set to ON.

*5. CN3D of No. 1, 2, 3 can be selected arbitrary with the outdoor unit whose SW4-4 is set to ON.

[II Restrictions]

4) When SW4-4 on the all outdoor units in one refrigerant circuit system is set to ON (12 levels of on-DEMAND) (*4)

12 levels of on-DEMAND	No.2 CN3D	1-2P	Open							
		1-3P	Open				Short-circuit			
	No.3 CN3D	1-2P	Open		Short-circuit		Open		Short-circuit	
No.1 CN3D	1-2P	1-3P	Open	Short-circuit	Open	Short-circuit	Open	Short-circuit	Open	Short-circuit
	Open	Open	100%	67%	92%	84%	67%	34%	59%	50%
		Short-circuit	67%	34%	59%	50%	34%	0%	25%	17%
	Short-circuit	Open	92%	59%	84%	75%	59%	25%	50%	42%
		Short-circuit	84%	50%	75%	67%	50%	17%	42%	34%

12 levels of on-DEMAND	No.2 CN3D	1-2P	Short-circuit							
		1-3P	Open				Short-circuit			
	No.3 CN3D	1-2P	Open		Short-circuit		Open		Short-circuit	
No.1 CN3D	1-2P	1-3P	Open	Short-circuit	Open	Short-circuit	Open	Short-circuit	Open	Short-circuit
	Open	Open	92%	59%	84%	75%	84%	50%	75%	67%
		Short-circuit	59%	25%	50%	42%	50%	17%	42%	34%
	Short-circuit	Open	84%	50%	75%	67%	75%	42%	67%	59%
		Short-circuit	75%	42%	67%	59%	67%	34%	59%	50%

*3. Input the order to CN3D on the outdoor unit whose SW4-4 is set to ON.

*4. CN3D of No. 1, 2, 3 can be selected arbitrary with the outdoor unit whose SW4-4 is set to ON.

[4] Sample System Connection

Examples of typical system connection are shown on pages [5] to [7].
Refer to the Installation Manual that came with each device or controller for details.

(1) An example of a system to which an MA remote controller is connected

	System configuration	Connection to the system controller	Address start up for indoor and outdoor units	Notes
1.	System with one outdoor unit	NO	Automatic address setup	
2.	System with one outdoor unit	NO	Manual address setup	Connection of multiple LOSS-NAY units
3.	Grouping of units in a system with multiple outdoor units	NO	Manual address setup	
4.	System with one outdoor unit	With connection to transmission line for centralized control	Manual address setup	
5.	System with one outdoor unit	With connection to indoor-outdoor transmission line	Manual address setup	

(2) An example of a system to which an M-NET remote controller is connected

	System configuration	Connection to the system controller	Address start up for indoor and outdoor units	Notes
1.	System with one outdoor unit	With connection to transmission line for centralized control	Manual address setup	

(3) An example of a system to which both MA remote controller and M-NET remote controller are connected

	System configuration	Connection to the system controller	Address start up for indoor and outdoor units	Notes
1.	System with one outdoor unit	With connection to transmission line for centralized control	Manual address setup	

[5] An Example of a System to which an MA Remote Controller is connected

1. System with one outdoor unit (automatic address setup for both indoor and outdoor units)

(1) Sample control wiring

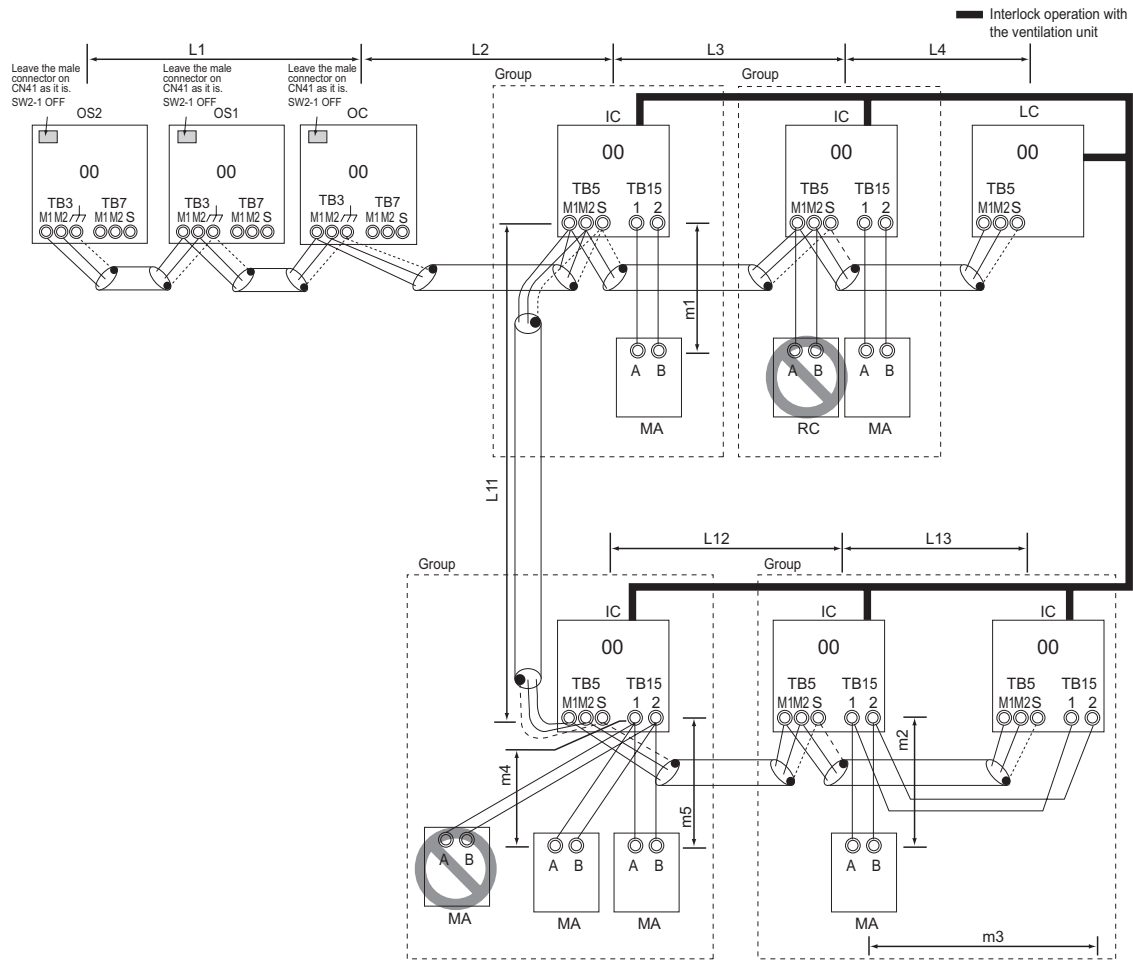

(2) Cautions

- 1) M-NET remote controller and MA remote controller cannot both be connected to the same group of indoor units.
- 2) No more than 2 MA remote controllers can be connected to a group of indoor units.
- 3) A transmission booster is required in a system to which more than 32 indoor units (26 units if one or more indoor units of the 72 model or above is connected) are connected.
- 4) Automatic address setup is not available if start-stop input (CN32, CN51, CN41) is used for a group operation of indoor units. Refer to "[5] 2. Manual address setup for both indoor and outdoor units".(page 29)
- 5) To connect more than 2 LOSSNAY units to indoor units in the same system, refer to the next section "[5] 2. An example of a system with one outdoor unit to which 2 or more LOSSNAY units are connected".(page 29)

(3) Maximum allowable length

- 1) Indoor/outdoor transmission line
 Maximum distance (1.25mm² [AWG16] or larger)
 $L1 + L2 + L3 + L4 \leq 200m [656ft]$
 $L1 + L2 + L11 + L12 + L13 \leq 200m [656ft]$
- 2) Transmission line for centralized control
 No connection is required.
- 3) MA remote controller wiring
 Maximum overall line length (0.3 to 1.25mm² [AWG22 to 16])
 $m1 \leq 200m [656ft]$
 $m2 + m3 \leq 200m [656ft]$
 $m4 + m5 \leq 200m [656ft]$

(4) Wiring method

1) Indoor/outdoor transmission line

Daisy-chain terminals M1 and M2 on the terminal block for indoor-outdoor transmission line (TB3) on the outdoor units (OC, OS1, OS2) (Note 1), and terminals M1 and M2 on the terminal block for indoor-outdoor transmission line (TB5) on each indoor unit (IC). (Non-polarized two-wire)

•Only use shielded cables.

Note

The outdoor units in the same refrigerant circuit are automatically designated as OC, OS1, and OS2 in the order of capacity from large to small (if two or more units have the same capacity, in the order of address from small to large).

Shielded cable connection

Daisy-chain the ground terminal () on the outdoor units (OC, OS1, OS2), and the S terminal on the terminal block (TB5) on the indoor unit (IC) with the shield wire of the shielded cable.

2) Transmission line for centralized control

No connection is required.

3) MA remote controller wiring

Connect terminals 1 and 2 on the terminal block for MA remote controller line (TB15) on the indoor unit (IC) to the terminal block on the MA remote controller (MA). (Non-polarized two-wire)

When 2 remote controllers are connected to the system

When 2 remote controllers are connected to the system, connect terminals 1 and 2 of the terminal block (TB15) on the indoor unit (IC) to the terminal block on the two MA remote controllers.

•Set one of the MA remote controllers to sub. (Refer to

(5) Address setting method

Procedures	Unit or controller		Address setting range	Setting method	Notes	Factory setting
1	Indoor unit	Main unit	IC	No settings required.	-	To perform a group operation of indoor units that have different functions, refer to [5] 2.(page 29)
		Sub unit	IC			
2	LOSSNAY		LC	No settings required.	-	00
3	MA remote controller	Main remote controller	MA	No settings required.	-	Main
		Sub remote controller	MA	Sub remote controller		
4	Outdoor unit (Note)		OC OS1 OS2	No settings required.	-	00

Note

The outdoor units in the same refrigerant circuit are automatically designated as OC, OS1, and OS2.

MA remote controller function selection or the installation manual for the MA remote controller for the setting method.)

Group operation of indoor units

To perform a group operation of indoor units (IC), daisy-chain terminals 1 and 2 on the terminal block (TB15) on all indoor units (IC) in the same group, and then connect terminals 1 and 2 on the terminal block (TB15) on the indoor unit on one end to the terminal block on the MA remote controller. (Non-polarized two-wire)

•When performing a group operation of indoor units that have different functions, "Automatic indoor/outdoor address setup" is not available.

4) LOSSNAY connection

Connect terminals M1 and M2 on the terminal block (TB5) on the indoor unit (IC) to the appropriate terminals on the terminal block (TB5) on LOSSNAY (LC). (Non-polarized two-wire)

•Interlock operation setting with all the indoor units in the same system will automatically be made. (It is required that the Lossnay unit be turned on before the outdoor unit.)

•Refer to "[5] 2. Manual address setup for both indoor and outdoor units" in the following cases: performing an interlock operation of part of the indoor units in the system with a LOSSNAY unit, using LOSSNAY alone without interlocking it with any units, performing an interlock operation of more than 16 indoor units with a LOSSNAY unit, or connecting two or more LOSSNAY units to indoor units in the same system.

5) Switch setting

No address settings required.

2. An example of a system with one outdoor unit to which 2 or more LOSSNAY units are connected (manual address setup for both indoor and outdoor units)

(1) Sample control wiring

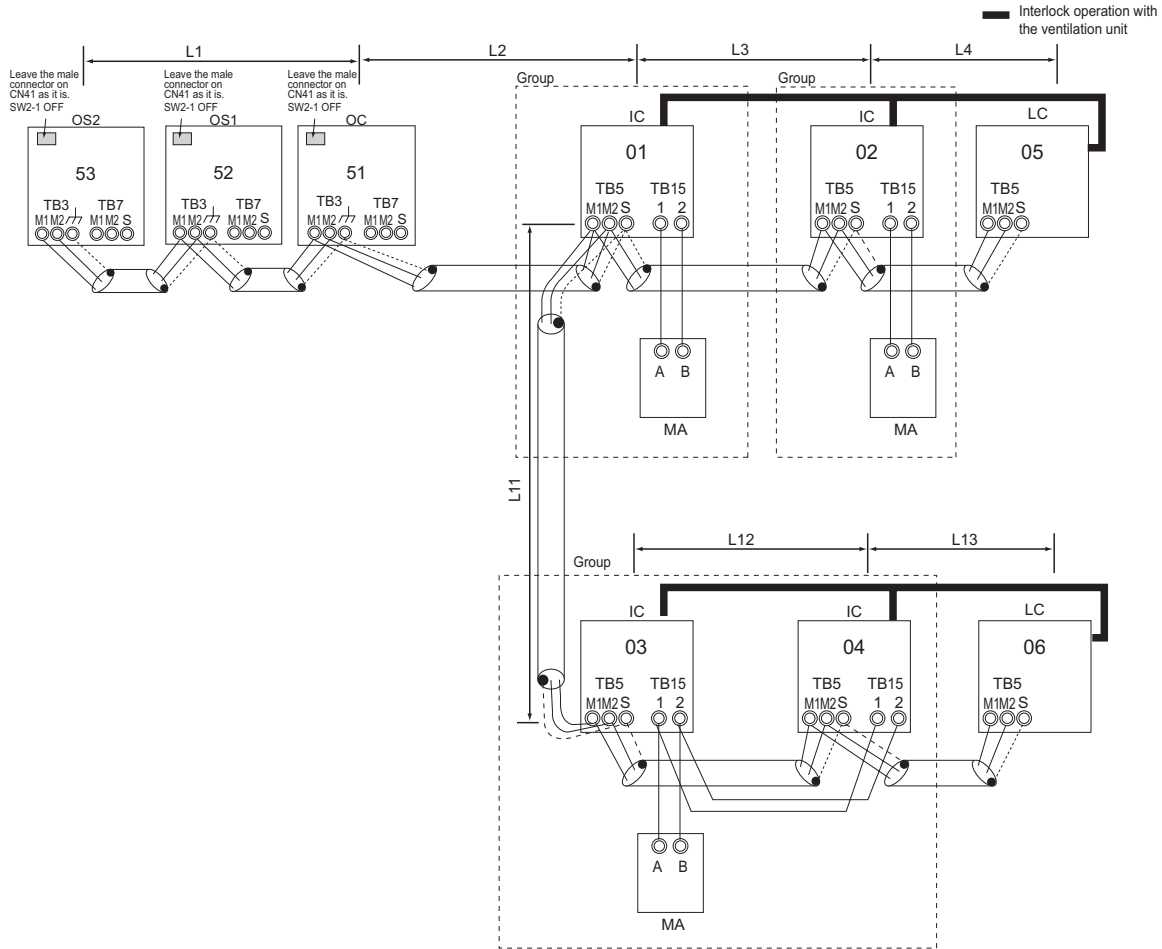

(2) Cautions

- 1) M-NET remote controller and MA remote controller cannot both be connected to the same group of indoor units.
- 2) No more than 2 MA remote controllers can be connected to a group of indoor units.
- 3) A transmission booster is required in a system to which more than 32 indoor units (26 units if one or more indoor units of the 72 model or above is connected) are connected.

(3) Maximum allowable length

- 1) Indoor/outdoor transmission line
Same as [5] 1.
- 2) Transmission line for centralized control
No connection is required.
- 3) MA remote controller wiring
Same as [5] 1.

(4) Wiring method

- 1) Indoor/outdoor transmission line
Same as [5] 1.

Shielded cable connection

Same as [5] 1.

- 2) Transmission line for centralized control

No connection is required.

- 3) MA remote controller wiring

Same as [5] 1.

When 2 remote controllers are connected to the system

Same as [5] 1.

Group operation of indoor units

Same as [5] 1.

(5) Address setting method

- 4) LOSSNAY connection

Connect terminals M1 and M2 on the terminal block (TB5) on the indoor unit (IC) to the appropriate terminals on the terminal block (TB5) on LOSSNAY (LC). (Non-polarized two-wire)

•Interlock setting between the indoor units and LOSSNAY units must be entered on the remote controller. (Refer to "IV [3] Interlock Settings via the MA Remote Controller" or the installation manual for the MA remote controller for the setting method.)

- 5) Switch setting

Address setting is required as follows.

Procedures	Unit or controller			Address setting range	Setting method	Notes	Factory setting
1	Indoor unit	Main unit	IC	01 to 50	Assign the smallest address to the main unit in the group.	To perform a group operation of indoor units that have different functions, designate the indoor unit in the group with the greatest number of functions as the main unit.	00
		Sub unit			Assign sequential numbers starting with the address of the main unit in the same group +1. (Main unit address +1, main unit address +2, main unit address +3, etc.)		
2	LOSSNAY		LC	01 to 50	Assign an arbitrary but unique address to each of these units after assigning an address to all indoor units.	None of these addresses may overlap any of the indoor unit addresses.	00
3	MA remote controller	Main remote controller	MA	No settings required.	-		Main
		Sub remote controller	MA	Sub remote controller	Settings to be made according to the remote controller function selection		
4	Outdoor unit		OC OS1 OS2	51 to 100	Assign sequential address to the outdoor units in the same refrigerant circuit. The outdoor units are automatically designated as OC, OS1, and OS2.(Note)	To set the address to 100, set the rotary switches to 50.	00

Note

The outdoor units in the same refrigerant circuit are automatically designated as OC, OS1, and OS2.

3. Group operation of units in a system with multiple outdoor units

(1) Sample control wiring

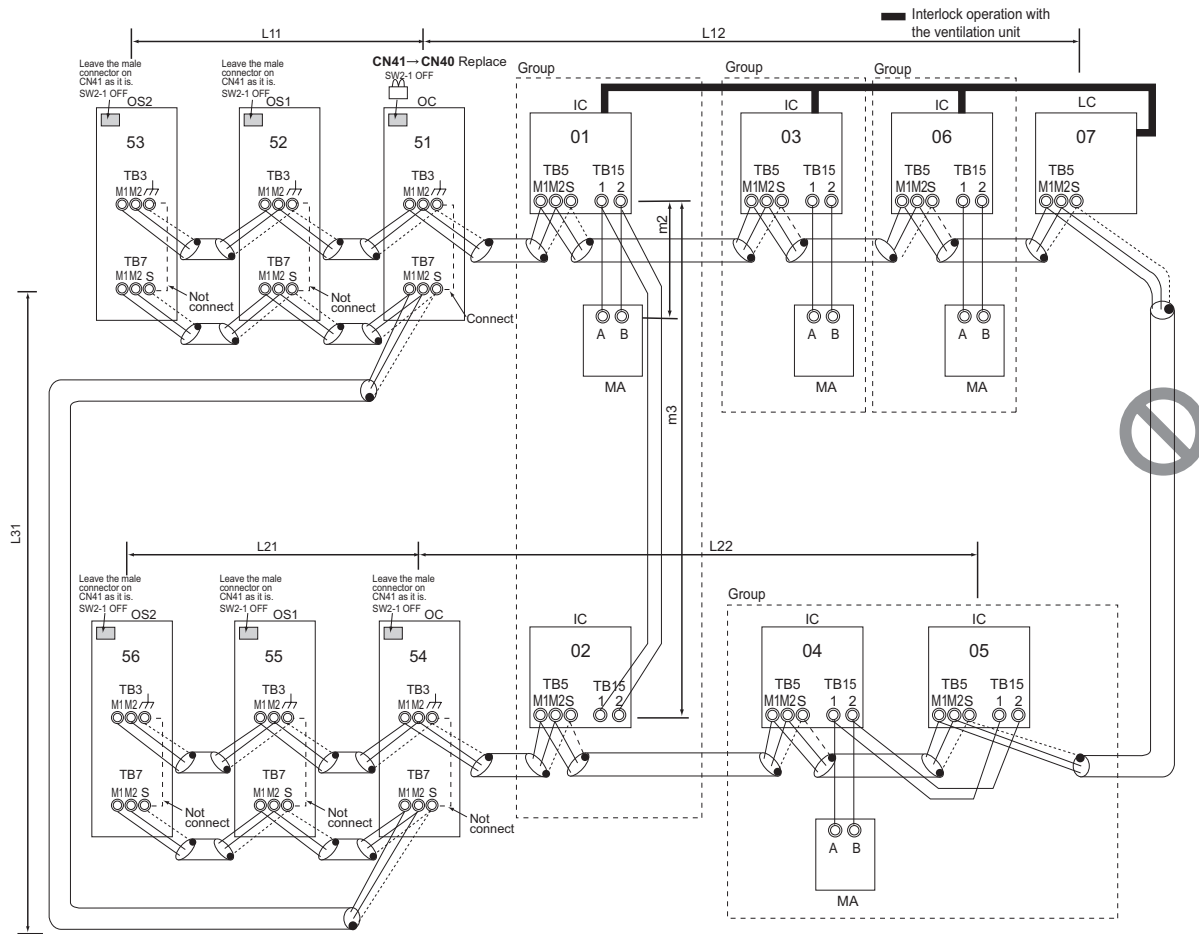

(2) Cautions

- 1) M-NET remote controller and MA remote controller cannot both be connected to the same group of indoor units.
- 2) No more than 2 MA remote controllers can be connected to a group of indoor units.
- 3) Do not connect the terminal blocks (TB5) on the indoor units that are connected to different outdoor units with each other.
- 4) Replacement of male power jumper connector (CN41) must be performed only on one of the outdoor units.
- 5) Provide grounding to S terminal on the terminal block for transmission line for centralized control (TB7) on only one of the outdoor units.
- 6) A transmission booster is required in a system to which more than 32 indoor units (26 units if one or more indoor units of the 72 model or above is connected) are connected.

(3) Maximum allowable length

- 1) Indoor/outdoor transmission line
Maximum distance (1.25mm² [AWG16] or larger)
L11+L12 ≤ 200m [656ft]
L21+L22 ≤ 200m [656ft]
- 2) Transmission line for centralized control
Maximum line distance via outdoor unit
(1.25mm² [AWG16] or larger)
L12+L31+L22 ≤ 500m [1640ft]
L11+L31+L21 ≤ 500m [1640ft]
- 3) MA remote controller wiring
Same as [5] 1.

(4) Wiring method

- 1) Indoor/outdoor transmission line
Same as [5] 1.

•Only use shielded cables.

Shielded cable connection

Same as [5] 1.

- 2) Transmission line for centralized control

Daisy-chain terminals M1 and M2 on the terminal block for transmission line for centralized control (TB7) on the outdoor units (OC) in different refrigerant circuits and on the OC, OS1, and OS2 in the same refrigerant circuit. If a power supply unit is not connected to the transmission line for centralized control, replace the power jumper connector on the control board from CN41 to CN40 on only one of the outdoor units.

Note

The outdoor units in the same refrigerant circuit are automatically designated as OC, OS1, and OS2 in the order of capacity from large to small (if two or more units have the same capacity, in the order of address from small to large).

•Only use shielded cables.

Shielded cable connection

Daisy-chain the S terminal on the terminal block (TB7) on the outdoor units (OC, OS1, OS2) with the shield wire of the shielded cable. Short-circuit the earth terminal (r) and the S terminal on the terminal block (TB7) on the outdoor unit whose power jumper connector is mated with CN40.

- 3) MA remote controller wiring

Same as [5] 1.

When 2 remote controllers are connected to the system

Same as [5] 1.

Group operation of indoor units

Same as [5] 2.

- 4) LOSSNAY connection

Same as [5] 2.

- 5) Switch setting

Address setting is required as follows.

(5) Address setting method

Procedures	Unit or controller			Address setting range	Setting method	Notes	Factory setting
1	Indoor unit	Main unit	IC	01 to 50	Assign the smallest address to the main unit in the group.	To perform a group operation of indoor units that have different functions, designate the indoor unit in the group with the greatest number of functions as the main unit.	00
		Sub unit					
2	LOSSNAY		LC	01 to 50	Assign an arbitrary but unique address to each of these units after assigning an address to all indoor units.	None of these addresses may overlap any of the indoor unit addresses.	00
3	MA remote controller	Main remote controller	MA	No settings required.	-		Main
		Sub remote controller	MA	Sub remote controller	Settings to be made according to the remote controller function selection		
4	Outdoor unit		OC OS1 OS2	51 to 100	Assign sequential address to the outdoor units in the same refrigerant circuit. The outdoor units are automatically designated as OC, OS1, and OS2. (Note)	To set the address to 100, set the rotary switches to 50.	00

Note

The outdoor units in the same refrigerant circuit are automatically designated as OC, OS1, and OS2.

4. A system in which a system controller is connected to the transmission line for centralized control and which is powered from an outdoor unit

(1) Sample control wiring

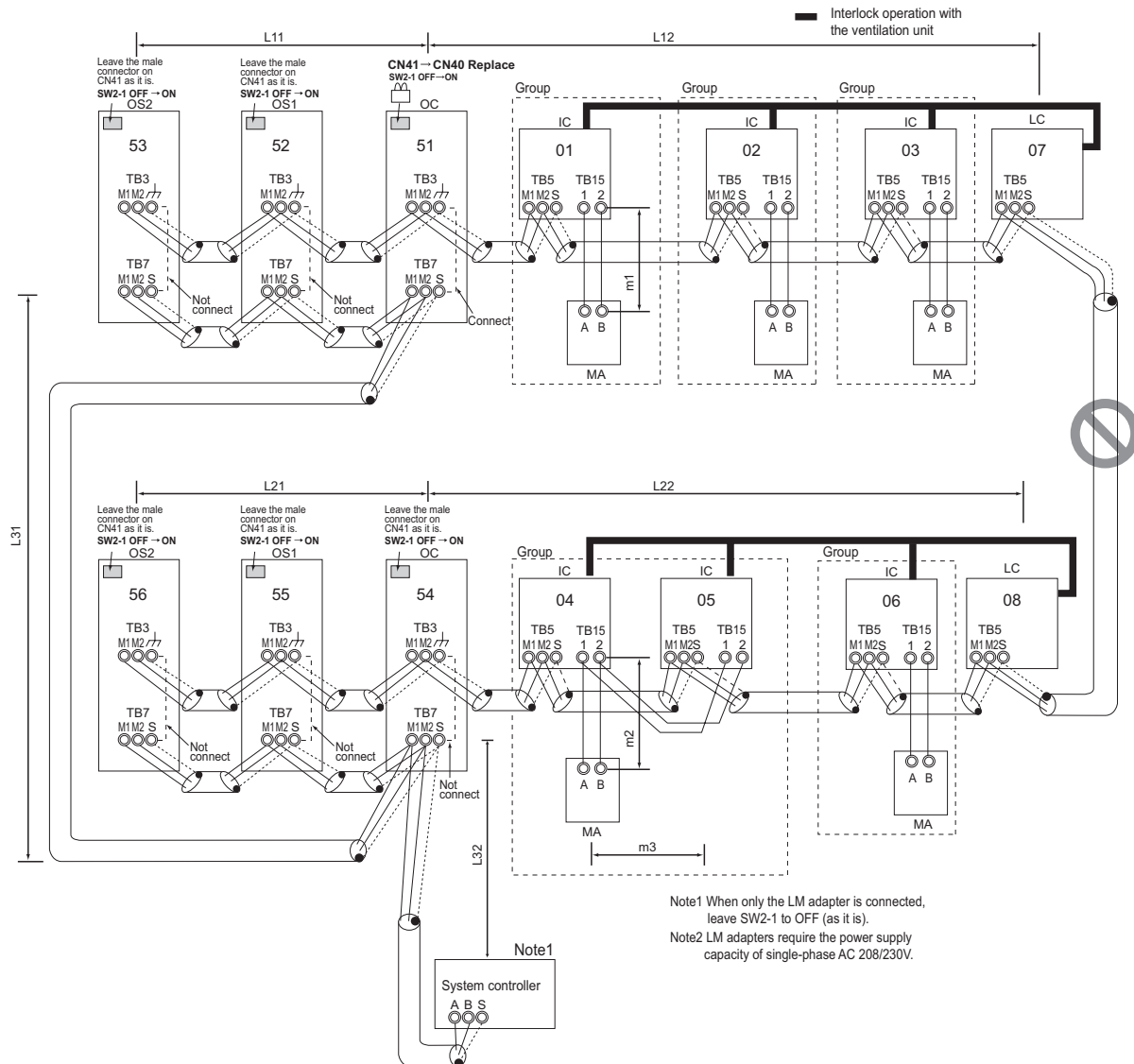

(2) Cautions

- 1) M-NET remote controller and MA remote controller cannot both be connected to the same group of indoor units.
- 2) No more than 2 MA remote controllers can be connected to a group of indoor units.
- 3) Do not connect the terminal blocks (TB5) on the indoor units that are connected to different outdoor units with each other.
- 4) Replacement of male power jumper connector (CN41) must be performed only on one of the outdoor units.
- 5) Short-circuit the shield terminal (S terminal) and the earth terminal () on the terminal block for transmission line for centralized control (TB7) on the outdoor unit whose power jumper connector is mated with CN40.
- 6) A transmission booster is required in a system to which more than 32 indoor units (26 units if one or more indoor units of the 72 model or above is connected) are connected.
- 7) When a power supply unit is connected to the transmission line for centralized control, leave the power jumper connector on CN41 as it is (factory setting).

(3) Maximum allowable length

- 1) Indoor/outdoor transmission line
Same as [5] 3.
- 2) Transmission line for centralized control
Maximum line distance via outdoor unit (1.25mm² [AWG16] or larger)
 $L32+L31+L12(L11) \leq 500m [1640ft]$
 $L32+L22(L21) \leq 500m [1640ft]$
 $L12(L11)+L31+L22(L21) \leq 500m [1640ft]$
- 3) MA remote controller wiring
Same as [5] 1.

(4) Wiring method

- 1) Indoor/outdoor transmission line

Same as [5] 1.

Only use shielded cables.

Shielded cable connection

Same as [5] 1.

- 2) Transmission line for centralized control

Daisy-chain terminals A and B on the system controller, terminals M1 and M2 on the terminal block for transmission line for centralized control (TB7) on the outdoor units (OC) in different refrigerant circuits and on the outdoor units (OC, OS1, and OS2) in the same refrigerant circuit.

If a power supply unit is not connected to the transmission line for centralized control, replace the power jumper connector on the control board from CN41 to CN40 on only one of the outdoor units.

If a system controller is connected, set the central control switch (SW2-1) on the control board of all outdoor units to "ON."

Note

The outdoor units in the same refrigerant circuit are automatically designated as OC, OS1, and OS2 in the order of capacity from large to small (if two or more units have the same capacity, in the order of address from small to large).

•Only use shielded cables.

(5) Address setting method

Procedures	Unit or controller			Address setting range	Setting method	Notes	Factory setting
1	Indoor unit	Main unit	IC	01 to 50	Assign the smallest address to the main unit in the group.	To perform a group operation of indoor units that have different functions, designate the indoor unit in the group with the greatest number of functions as the main unit.	00
		Sub unit			Assign sequential numbers starting with the address of the main unit in the same group +1. (Main unit address +1, main unit address +2, main unit address +3, etc.)		
2	LOSSNAY		LC	01 to 50	Assign an arbitrary but unique address to each of these units after assigning an address to all indoor units.	None of these addresses may overlap any of the indoor unit addresses.	00
3	MA remote controller	Main remote controller	MA	No settings required.	-	Enter the same indoor unit group settings on the system controller as the ones that were entered on the MA remote controller.	Main
		Sub remote controller	MA	Sub remote controller	Settings to be made according to the remote controller function selection		
4	Outdoor unit		OC OS1 OS2	51 to 100	Assign sequential address to the outdoor units in the same refrigerant circuit. The outdoor units are automatically designated as OC, OS1, and OS2.(Note)	To set the address to 100, set the rotary switches to 50.	00

Note

The outdoor units in the same refrigerant circuit are automatically designated as OC, OS1, and OS2.

Shielded cable connection

Daisy-chain the S terminal on the terminal block (TB7) on the outdoor units (OC, OS1, OS2) with the shield wire of the shielded cable. Short-circuit the earth terminal (rH) and the S terminal on the terminal block (TB7) on the outdoor unit whose power jumper connector is mated with CN40.

- 3) MA remote controller wiring

Same as [5] 1.

When 2 remote controllers are connected to the system

Same as [5] 1.

Group operation of indoor units

Same as [5] 1.

- 4) LOSSNAY connection

Connect terminals M1 and M2 on the terminal block (TB5) on the indoor unit (IC) to the appropriate terminals on the terminal block for indoor-outdoor transmission line (TB5) on LOSSNAY (LC). (Non-polarized 2-core cable)

•Indoor units must be interlocked with the LOSSNAY unit using the system controller. (Refer to the operation manual for the system controller for the setting method.) Interlock setting from the remote controller is required if the ON/OFF remote controller alone or the LM adapter alone is connected.

- 5) Switch setting

Address setting is required as follows.

5. An example of a system in which a system controller is connected to the indoor-outdoor transmission line (except LM adapter)

(1) Sample control wiring

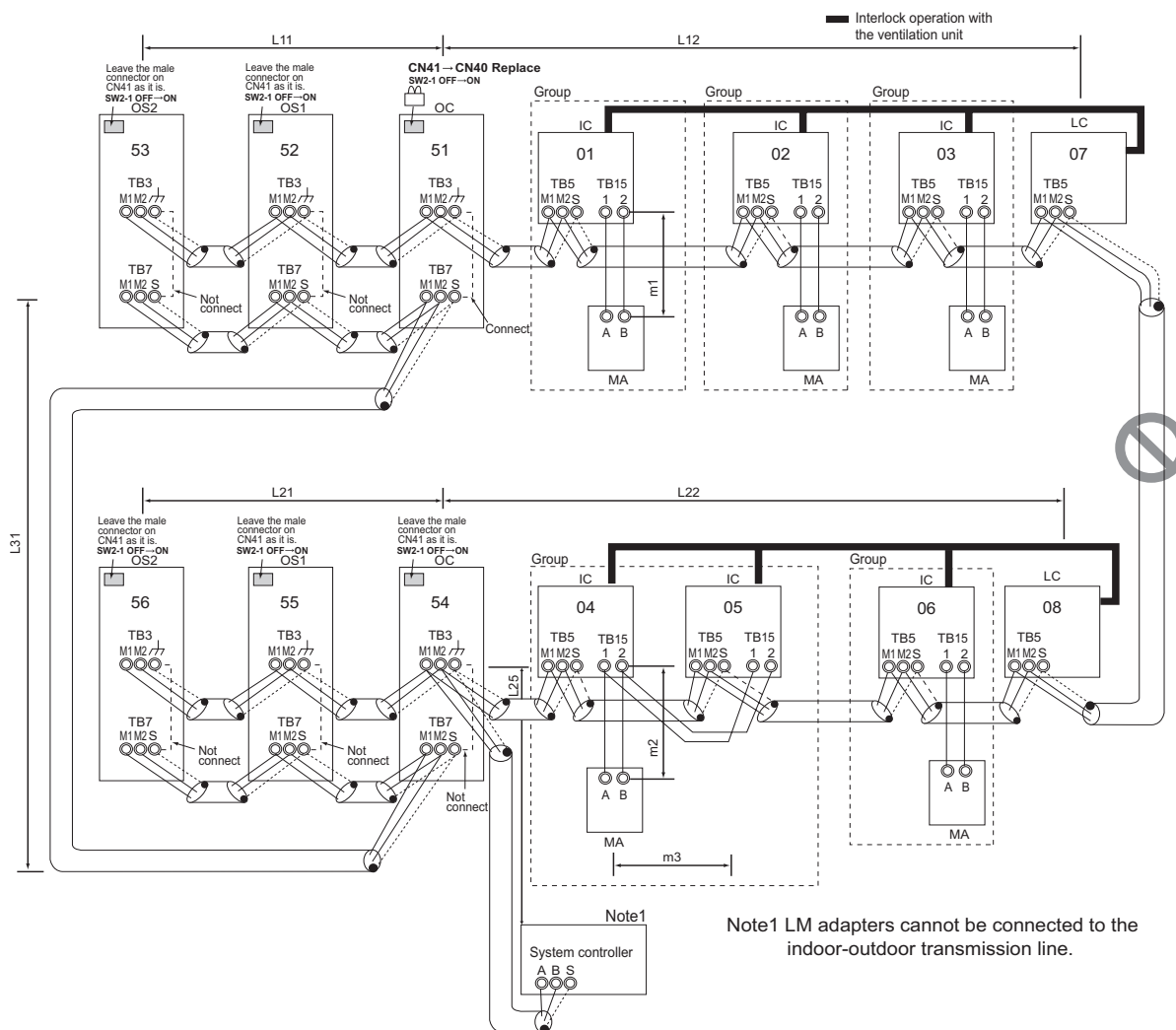

(2) Cautions

- 1) M-NET remote controller and MA remote controller cannot both be connected to the same group of indoor units.
- 2) No more than 2 MA remote controllers can be connected to a group of indoor units.
- 3) Do not connect the terminal blocks (TB5) on the indoor units that are connected to different outdoor units with each other.
- 4) Replacement of male power jumper connector (CN41) must be performed only on one of the outdoor units.
- 5) Provide grounding to S terminal on the terminal block for transmission line for centralized control (TB7) on only one of the outdoor units.
- 6) A maximum of 3 system controllers can be connected to the indoor-outdoor transmission line, with the exception that only one G(B)-50A may be connected.
- 7) When the total number of indoor units exceeds 26, it may not be possible to connect a system controller on the indoor-outdoor transmission line.
- 8) In a system to which more than 18 indoor units including one or more indoor units of 72 model or above are connected, there may be cases in which the system controller cannot be connected to the indoor-outdoor transmission line.

(3) Maximum allowable length

- 1) Indoor/outdoor transmission line
 Maximum distance (1.25mm² [AWG16] or larger)
 $L11+L12 \leq 200\text{m}$ [656ft]
 $L21+L22 \leq 200\text{m}$ [656ft]
 $L25 \leq 200\text{m}$ [656ft]
- 2) Transmission line for centralized control
 Maximum line distance via outdoor unit
 (1.25mm² [AWG16] or larger)
 $L25+L31+L12(L11) \leq 500\text{m}$ [1640ft]
 $L12(L11)+L31+L22(L21) \leq 500\text{m}$ [1640ft]
- 3) MA remote controller wiring
 Same as [5] 1.

(4) Wiring method

1) Indoor/outdoor transmission line

Daisy-chain terminals M1 and M2 on the terminal block for indoor-outdoor transmission line (TB3) on the outdoor units (OC, OS1, OS2) (Note 1), terminals M1 and M2 on the terminal block for indoor-outdoor transmission line (TB5) on each indoor unit (IC), and the S terminal on the system controller. (Non-polarized two-wire)

•Only use shielded cables.

Note

The outdoor units in the same refrigerant circuit are automatically designated as OC, OS1, and OS2 in the order of capacity from large to small (if two or more units have the same capacity, in the order of address from small to large).

Shielded cable connection

Daisy-chain the ground terminal (⏏) on the outdoor units (OC, OS1, OS2), the S terminal on the terminal block (TB5) on the indoor unit (IC), and the S terminal on the system controller with the shield wire of the shielded cable.

2) Transmission line for centralized control

Daisy-chain terminals M1 and M2 on the terminal block for transmission line for centralized control (TB7) on the outdoor units (OC) in different refrigerant circuits and on the OC, OS1, and OS2 in the same refrigerant circuit. If a power supply unit is not connected to the transmission line for centralized control, replace the power jumper connector on the control board from CN41 to CN40 on only one of the outdoor units.

(5) Address setting method

Procedures	Unit or controller			Address setting range	Setting method	Notes	Factory setting
1	Indoor unit	Main unit	IC	01 to 50	Assign the smallest address to the main unit in the group.	To perform a group operation of indoor units that have different functions, designate the indoor unit in the group with the greatest number of functions as the main unit.	00
		Sub unit			Assign sequential numbers starting with the address of the main unit in the same group +1. (Main unit address +1, main unit address +2, main unit address +3, etc.)		
2	LOSSNAY		LC	01 to 50	Assign an arbitrary but unique address to each of these units after assigning an address to all indoor units.	None of these addresses may overlap any of the indoor unit addresses.	00
3	MA remote controller	Main remote controller	MA	No settings required.	-	Enter the same indoor unit group settings on the system controller as the ones that were entered on the MA remote controller.	Main
		Sub remote controller	MA	Sub remote controller	Settings to be made according to the remote controller function selection		
4	Outdoor unit		OC OS1 OS2	51 to 100	Assign sequential address to the outdoor units in the same refrigerant circuit. The outdoor units are automatically designated as OC, OS1, and OS2. (Note)	To set the address to 100, set the rotary switches to 50.	00

Note

The outdoor units in the same refrigerant circuit are automatically designated as OC, OS1, and OS2.

Set the central control switch (SW2-1) on the control board of all outdoor units to "ON."

•Only use shielded cables.

Shielded cable connection

Daisy-chain the S terminal on the terminal block (TB7) on the outdoor units (OC, OS1, OS2) with the shield wire of the shielded cable. Short-circuit the earth terminal (⏏) and the S terminal on the terminal block (TB7) on the outdoor unit whose power jumper connector is mated with CN40.

3) MA remote controller wiring

Same as [5] 1.

When 2 remote controllers are connected to the system

Same as [5] 1.

Group operation of indoor units

Same as [5] 1.

4) LOSSNAY connection

Connect terminals M1 and M2 on the terminal block (TB5) on the indoor units (IC) to the appropriate terminals on the terminal block for indoor-outdoor transmission line (TB5) on LOSSNAY (LC). (Non-polarized two-wire)

•Indoor units must be interlocked with the LOSSNAY unit using the system controller. (Refer to the operation manual for the system controller for the setting method.) Interlock setting from the remote controller is required if the ON/OFF remote controller alone is connected.

5) Switch setting

Address setting is required as follows.

[6] An Example of a System to which an M-NET Remote Controller is connected

(1) Sample control wiring

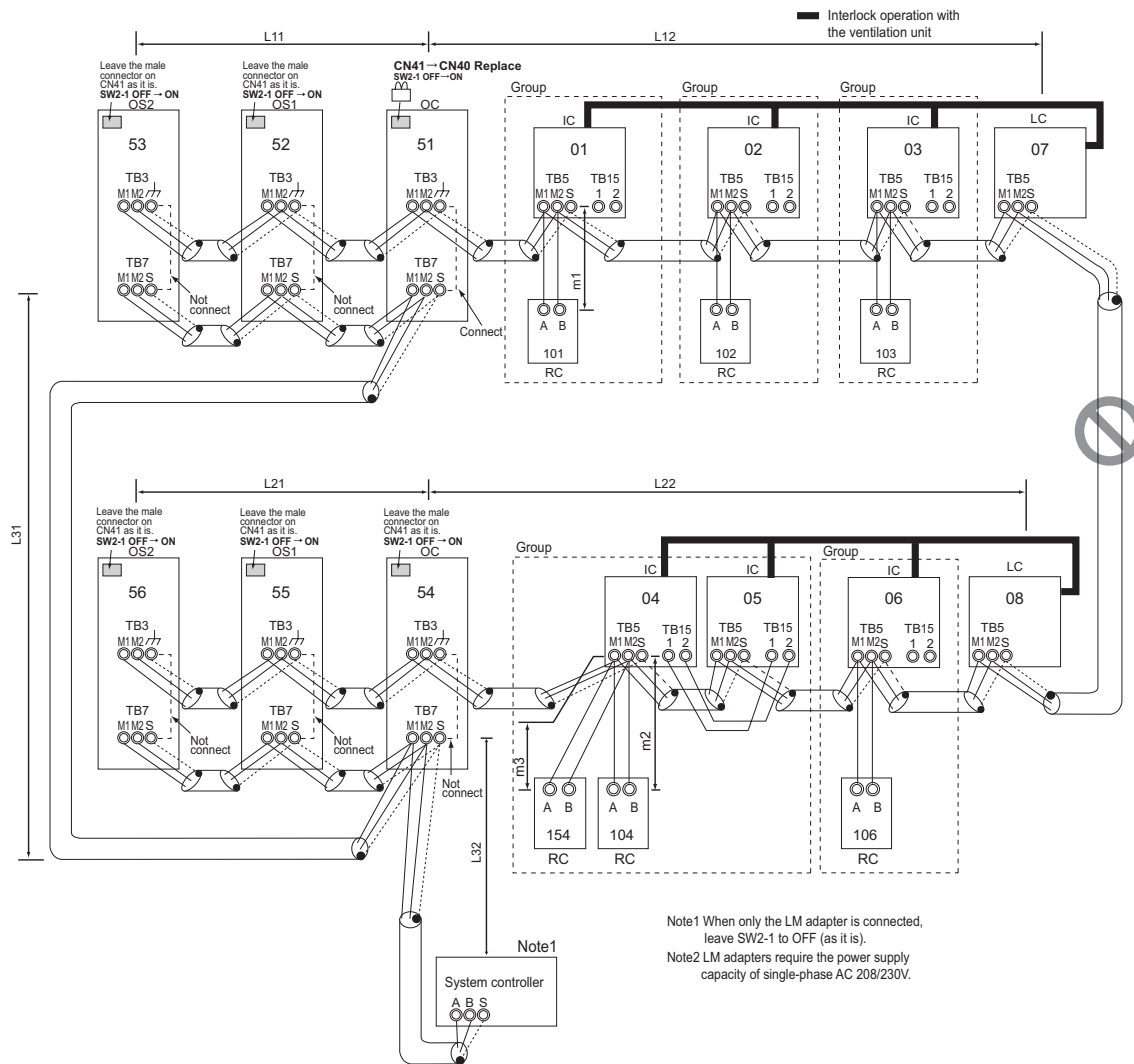

(2) Cautions

- 1) M-NET remote controller and MA remote controller cannot both be connected to the same group of indoor units.
- 2) No more than 3 M-NET remote controllers can be connected to a group of indoor units.
- 3) Do not connect the terminal blocks (TB5) on the indoor units that are connected to different outdoor units with each other.
- 4) Replace the power jumper connector of the control board from CN41 to CN40 on only one of the outdoor units.
- 5) Provide an electrical path to ground for the S terminal on the terminal block for centralized control on only one of the outdoor units.
- 6) A transmission booster must be connected to a system in which the total number of connected indoor units exceeds 20.
- 7) A transmission booster is required in a system to which more than 16 indoor including one or more indoor units of the 72 model or above are connected.
- 8) When a power supply unit is connected to the transmission line for centralized control, leave the power jumper connector on CN41 as it is (factory setting).

(3) Maximum allowable length

- 1) Indoor/outdoor transmission line
Same as [5] 3.
- 2) Transmission line for centralized control
Same as [5] 4.
- 3) M-NET remote controller wiring
Maximum overall line length
(0.3 to 1.25mm² [AWG22 to 16])
m1 ≤ 10m [32ft]
m2+m3 ≤ 10m [32ft]
If the standard-supplied cable must be extended, use a cable with a diameter of 1.25mm² [AWG16]. The section of the cable that exceeds 10m [32ft] must be included in the maximum indoor-outdoor transmission line distance described in (1).
When connected to the terminal block on the Simple remote controller, use cables that meet the following cable size specifications: 0.75 - 1.25 mm² [AWG18-14].

(4) Wiring method

- 1) Indoor/outdoor transmission line
Same as [5] 3.
Shielded cable connection
Same as [5] 1.
- 2) Transmission line for centralized control
Same as [5] 4.
Shielded cable connection
Same as [5] 4.
- 3) M-NET remote controller wiring
M-NET remote controller is connectable anywhere on the indoor-outdoor transmission line.

When 2 remote controllers are connected to the system

- Refer to the section on Switch Setting.
Performing a group operation (including the group operation of units in different refrigerant circuits).
Refer to the section on Switch Setting.
- 4) LOSSNAY connection
Same as [5] 4.
 - 5) Switch setting
Address setting is required as follows.

(5) Address setting method

Procedures	Unit or controller			Address setting range	Setting method	Notes	Factory setting
1	Indoor unit	Main unit	IC	01 to 50	Assign the smallest address to the main unit in the group.	To perform a group operation of indoor units that have different functions, designate the indoor unit in the group with the greatest number of functions as the main unit.	00
		Sub unit			Assign sequential numbers starting with the address of the main unit in the same group +1. (Main unit address +1, main unit address +2, main unit address +3, etc.)		
2	LOSSNAY		LC	01 to 50	Assign an arbitrary but unique address to each of these units after assigning an address to all indoor units.	None of these addresses may overlap any of the indoor unit addresses.	00
3	M-NET remote controller	Main remote controller	RC	101 to 150	Add 100 to the main unit address in the group	<ul style="list-style-type: none"> ♦It is not necessary to set the 100s digit. ♦To set the address to 200, set the rotary switches to 00. 	101
		Sub remote controller	RC	151 to 200	Add 150 to the main unit address in the group		
4	Outdoor unit		OC OS1 OS2	51 to 100	Assign sequential address to the outdoor units in the same refrigerant circuit. The outdoor units are automatically designated as OC, OS1, and OS2. (Note)	To set the address to 100, set the rotary switches to 50.	00

Note

The outdoor units in the same refrigerant circuit are automatically designated as OC, OS1, and OS2.

[7] An Example of a System to which both MA Remote Controller and M-NET Remote Controller are connected

(1) Sample control wiring

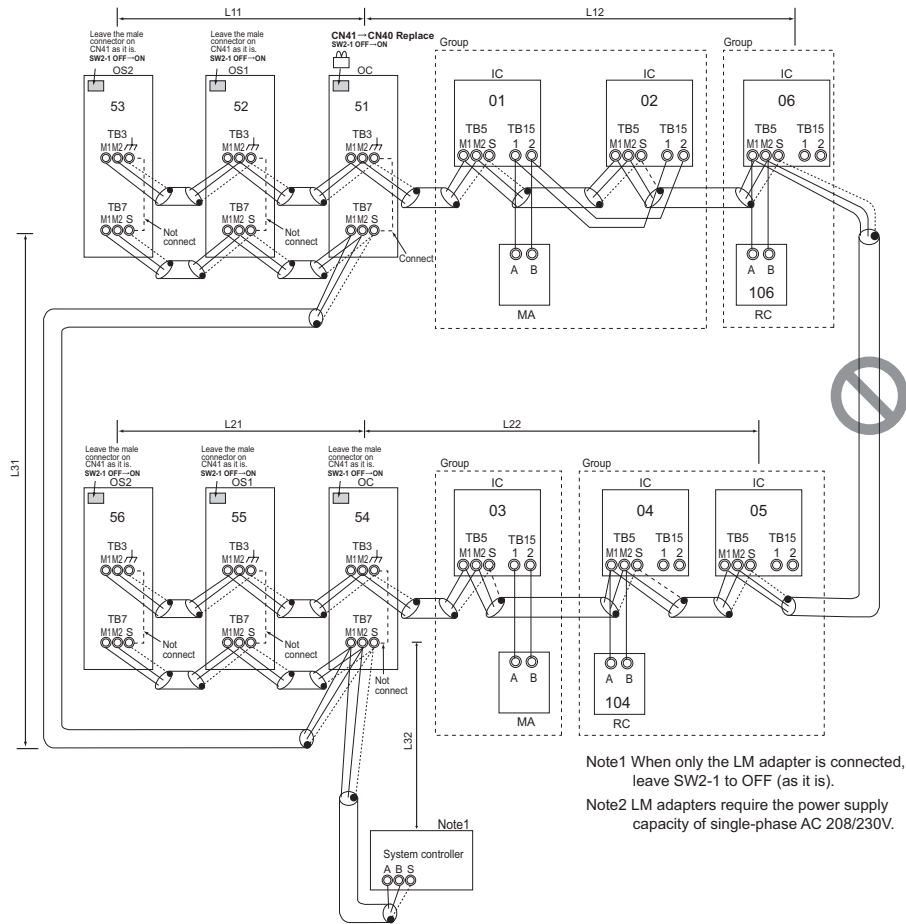

(2) Cautions

- 1) Be sure to connect a system controller.
- 2) M-NET remote controller and MA remote controller cannot both be connected to the same group of indoor units.
- 3) Assign to the indoor units connected to the MA remote controller addresses that are smaller than those of the indoor units that are connected to the M-NET remote controller.
- 4) No more than 2 M-NET remote controllers can be connected to a group of indoor units.
- 5) No more than 2 MA remote controllers can be connected to a group of indoor units.
- 6) Do not connect the terminal blocks (TB5) on the indoor units that are connected to different outdoor units with each other.
- 7) Replace the power jumper connector of the control board from CN41 to CN40 on only one of the outdoor units.
- 8) Provide an electrical path to ground for the S terminal on the terminal block for centralized control on only one of the outdoor units.
- 9) A transmission booster must be connected to a system in which the total number of connected indoor units exceeds 20.
- 10) A transmission booster is required in a system to which more than 16 indoor including one or more indoor units of the 72 model or above are connected.
- 11) When a power supply unit is connected to the transmission line for centralized control, leave the power jumper connector on CN41 as it is (factory setting).

(3) Maximum allowable length

- 1) Indoor/outdoor transmission line
Same as [5] 3.
- 2) Transmission line for centralized control
Same as [5] 4.
- 3) MA remote controller wiring
Same as [5] 1.
- 4) M-NET remote controller wiring
Same as [5] 1.

(4) Wiring method

- 1) Indoor/outdoor transmission line

Same as [5] 3.

Shielded cable connection

Same as [5] 1.

- 2) Transmission line for centralized control

Same as [5] 4.

Shielded cable connection

Same as [5] 4.

- 3) MA remote controller wiring

Same as [5] 1.

When 2 remote controllers are connected to the system

Same as [5] 1.

Group operation of indoor units

Same as [5] 1.

- 4) M-NET remote controller wiring

Same as [5] 1.

When 2 remote controllers are connected to the system

Same as [5] 1.

Group operation of indoor units

Same as [5] 1.

- 5) LOSSNAY connection

Same as [5] 4.

- 6) Switch setting

Address setting is required as follows.

(5) Address setting method

Procedures	Unit or controller				Address setting range	Setting method	Notes	Factory setting
1	Operation with the MA remote controller	Indoor unit	Main unit	IC	01 to 50	Assign the smallest address to the main unit in the group.	<ul style="list-style-type: none"> Assign an address smaller than that of the indoor unit that is connected to the M-NET remote controller. Enter the same indoor unit group settings on the system controller as the ones that were entered on the MA remote controller. To perform a group operation of indoor units that have different functions, designate the indoor unit in the group with the greatest number of functions as the main unit. 	00
			Sub unit			Assign sequential numbers starting with the address of the main unit in the same group +1. (Main unit address +1, main unit address +2, main unit address +3, etc.)		
		MA remote controller	Main remote controller	MA	No settings required.	-		Main
			Sub remote controller	MA	Sub remote controller	Settings to be made according to the remote controller function selection		
2	Operation with the M-NET remote controller	Indoor unit	Main unit	IC	01 to 50	Assign the smallest address to the main unit in the group.	<ul style="list-style-type: none"> Enter the indoor unit group settings on the system controller (MELANS). Assign an address larger than those of the indoor units that are connected to the MA remote controller. To perform a group operation of indoor units that have different functions, designate the indoor unit in the group with the greatest number of functions as the main unit. 	00
			Sub unit			Assign sequential numbers starting with the address of the main unit in the same group +1. (Main unit address +1, main unit address +2, main unit address +3, etc.)		
		M-NET remote controller	Main remote controller	RC	101 to 150	Add 100 to the main unit address in the group.	<ul style="list-style-type: none"> It is not necessary to set the 100s digit. To set the address to 200, set the rotary switches to 00. 	101
			Sub remote controller	RC	151 to 200	Add 150 to the main unit address in the group.		
3	LOSSNAY			LC	01 to 50	Assign an arbitrary but unique address to each of these units after assigning an address to all indoor units.	None of these addresses may overlap any of the indoor unit addresses.	00
4	Outdoor unit			OC OS1 OS2	51 to 100	Assign sequential address to the outdoor units in the same refrigerant circuit. The outdoor units are automatically designated as OC, OS1, and OS2.(Note)	To set the address to 100, set the rotary switches to 50.	00

Note

The outdoor units in the same refrigerant circuit are automatically designated as OC, OS1, and OS2.

[8] Restrictions on Pipe Length

(1) End branching

P72 - P120 models

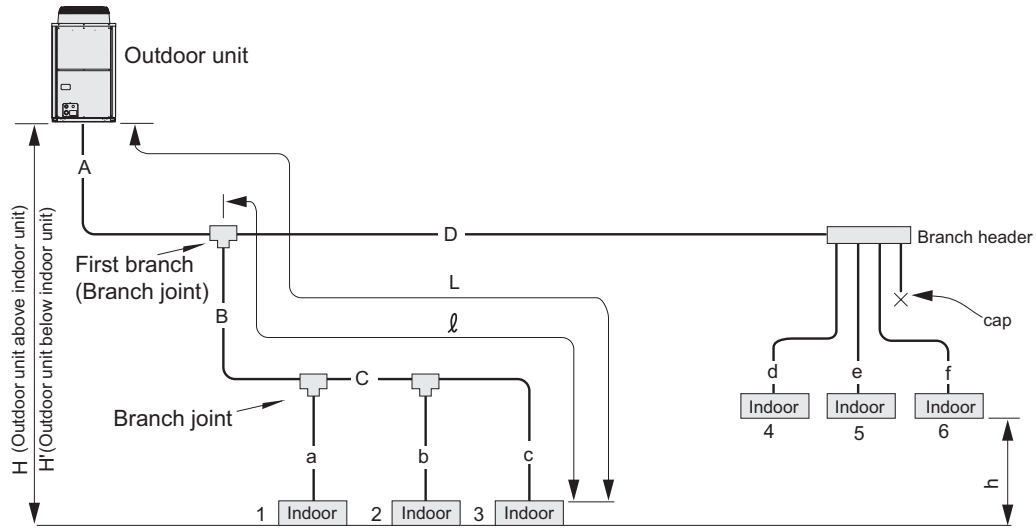

Unit: m [ft]

Operation		Pipe sections	Allowable length of pipes
Length	Total pipe length	$A+B+C+D+a+b+c+d+e+f$	1000 [3280] or less
	Total pipe length (L) from the outdoor unit to the farthest indoor unit	$A+B+C+c$ or $A+D+f$	165 [541] or less (Equivalent length 190 [623] or less)
	Total pipe length from the first branch to the farthest indoor unit (l)	$B+C+c$ or $D+f$	40 [131] or less
Height difference	Between indoor and outdoor units	Outdoor unit above indoor unit	50 [164] or less
		Outdoor unit below indoor unit	40 [131] or less
	Between indoor units	h	15 [49] or less

P144 - P360 models

The figure shows a system with three outdoor units. (P264-P360 models)

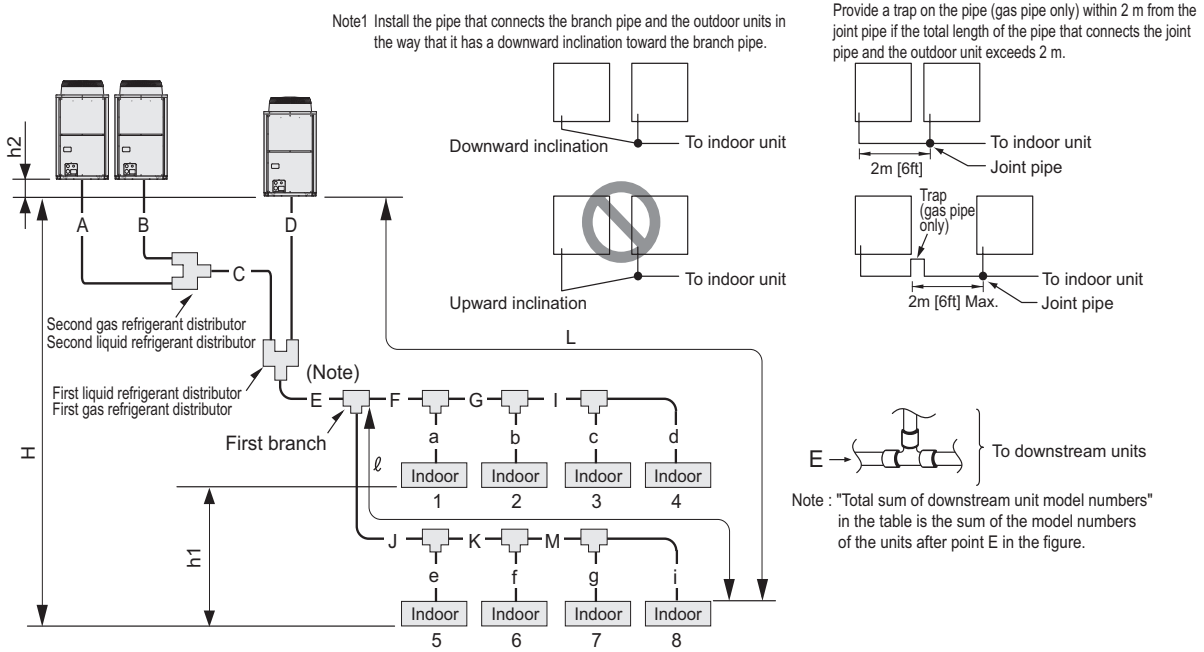

Unit: m [ft]

Operation		Pipe sections	Allowable length of pipes
Length	Between outdoor units	A+B+C+D	10 [32] or less
	Total pipe length	A+B+C+D+E+F+G+I+J+K+M+a+b+c+d+e+f+g+i	1000 [3280] or less
	Total pipe length (L) from the outdoor unit to the farthest indoor unit	A(B)+C+E+J+K+M+i	165 [541] or less (Equivalent length 190 [623] or less)
	Total pipe length from the first branch to the farthest indoor unit (ℓ)	G+I+J+i	40 [131] or less
Height difference	Between indoor and outdoor units	H	50 [164] or less (40 [131] or below if outdoor unit is below indoor unit)
	Between indoor units	h1	15 [49] or less
	Between outdoor units	h2	0.1[0.3] or less

1. Refrigerant pipe size

(1) Diameter of the refrigerant pipe between the outdoor unit and the first branch (outdoor unit pipe size)

Outdoor unit set name (total capacity)	Liquid pipe size (mm) [inch]	Gas pipe size (mm) [inch]
72 model	ø9.52 [3/8"]	ø19.05 [3/4"]
96 model	ø9.52 [3/8"] ^{*1}	ø22.2 [7/8"]
120 model	ø9.52 [3/8"] ^{*2}	ø22.2 [7/8"]
144 model	ø12.7 [1/2"]	ø28.58 [1-1/8"]
168 model	ø15.88 [5/8"]	ø28.58 [1-1/8"]
192 model	ø15.88 [5/8"]	ø28.58 [1-1/8"]
216 model	ø15.88 [5/8"]	ø28.58 [1-1/8"]
240 model	ø15.88 [5/8"]	ø28.58 [1-1/8"]
264 - 312 model	ø19.05 [3/4"]	ø34.93 [1-3/8"]
336 - 360 model	ø19.05 [3/4"]	ø41.28 [1-5/8"]

*1. Use ø12.7 [1/2"] pipes if the piping length exceeds 90 m [295 ft].

*2. Use ø12.7 [1/2"] pipes if the piping length exceeds 40 m [131 ft].

(2) Size of the refrigerant pipe between the first branch and the indoor unit (indoor unit pipe size)

model	Pipe diameter (mm) [inch]	
06 - 15 models	Liquid pipe	ø6.35 [1/4"]
	Gas pipe	ø12.7 [1/2"]
18 - 54 models	Liquid pipe	ø9.52 [3/8"]
	Gas pipe	ø15.88 [5/8"]
72 model	Liquid pipe	ø9.52 [3/8"]
	Gas pipe	ø19.05 [3/4"]
96 model	Liquid pipe	ø9.52 [3/8"]
	Gas pipe	ø22.2 [7/8"]

(3) Size of the refrigerant pipe between the branches for connection to indoor units

Total capacity of the downstream units	Liquid pipe size (mm) [inch]	Gas pipe size (mm) [inch]
- 54	ø9.52 [3/8"]	ø15.88 [5/8"]
P55 - P72	ø9.52 [3/8"]	ø19.05 [3/4"]
P72 - P108	ø9.52 [3/8"]	ø22.2 [7/8"]
P109 - P144	ø12.7 [1/2"]	ø28.58 [1-1/8"]
P145 - P240	ø15.88 [5/8"]	ø28.58 [1-1/8"]
P241 - P308	ø19.05 [3/4"]	ø34.93 [1-3/8"]
P309 -	ø19.05 [3/4"]	ø41.28 [1-5/8"]

(4) Size of the refrigerant pipe between the first distributor and the second distributor

Liquid pipe size (mm) [inch]	Gas pipe size (mm) [inch]
ø19.05 [3/4"]	ø34.93 [1-3/8"]

(5) Size of the refrigerant pipe between the first distributor or the second distributor and outdoor units

	Liquid pipe size (mm) [inch]	Gas pipe size (mm) [inch]
72 model	ø9.52 [3/8"]	ø22.2 [7/8"]
96 model		
120 model	ø12.7 [1/2"]	

* Only applicable to the 120 model and below

III Outdoor Unit Components

[1] Outdoor Unit Components and Refrigerant Circuit	47
[2] Control Box of the Outdoor Unit.....	49
[3] Outdoor Unit Circuit Board.....	52



[1] Outdoor Unit Components and Refrigerant Circuit

1. PUHY-P72, P96, P120THMU-A
PUHY-P72, P96, P120YHMU-A
(1) Front view of a outdoor unit

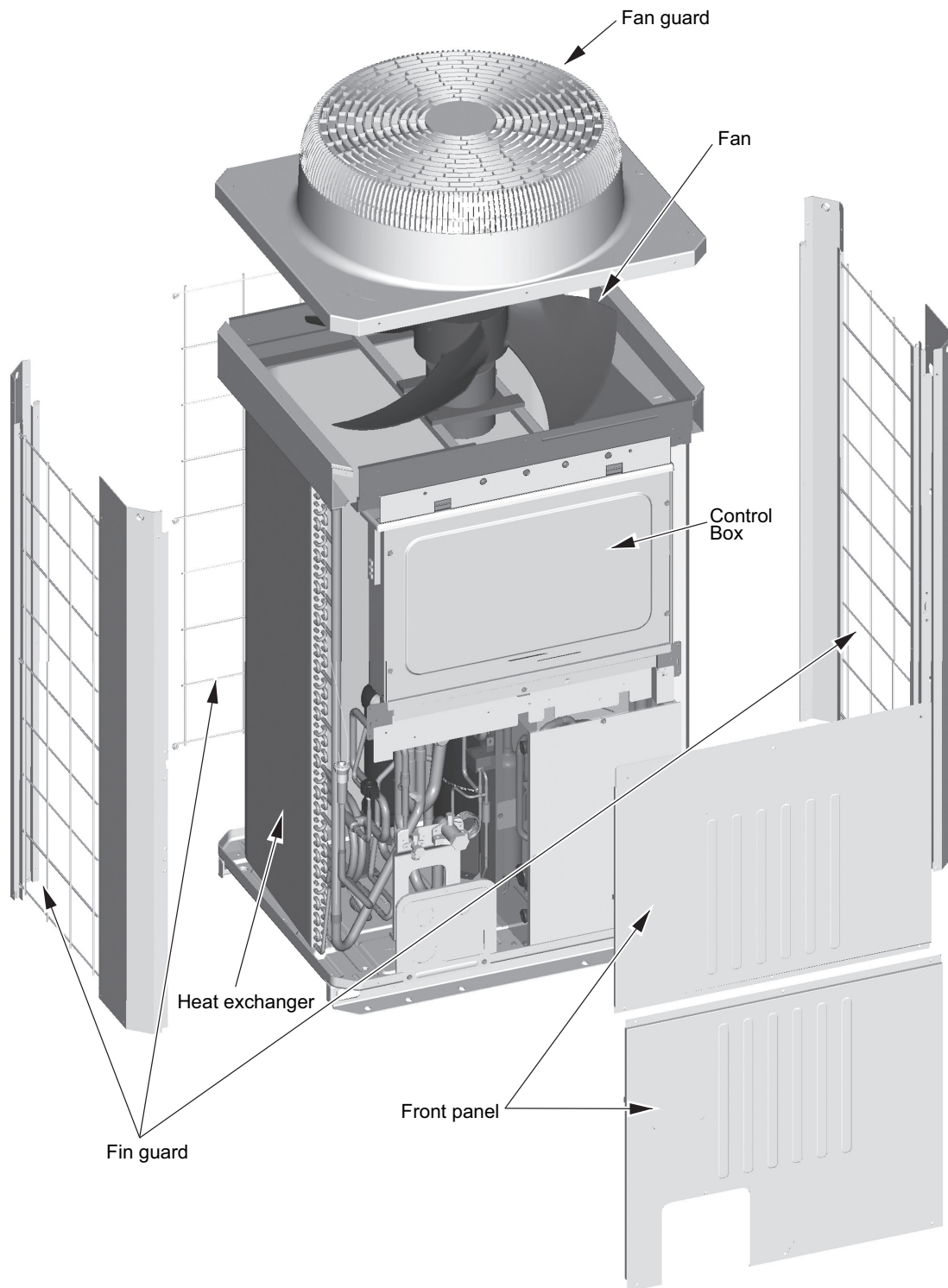

**2. PUHY-P72, P96THMU-A
PUHY-P72, P96YHMU-A**

(1) Refrigerant circuit

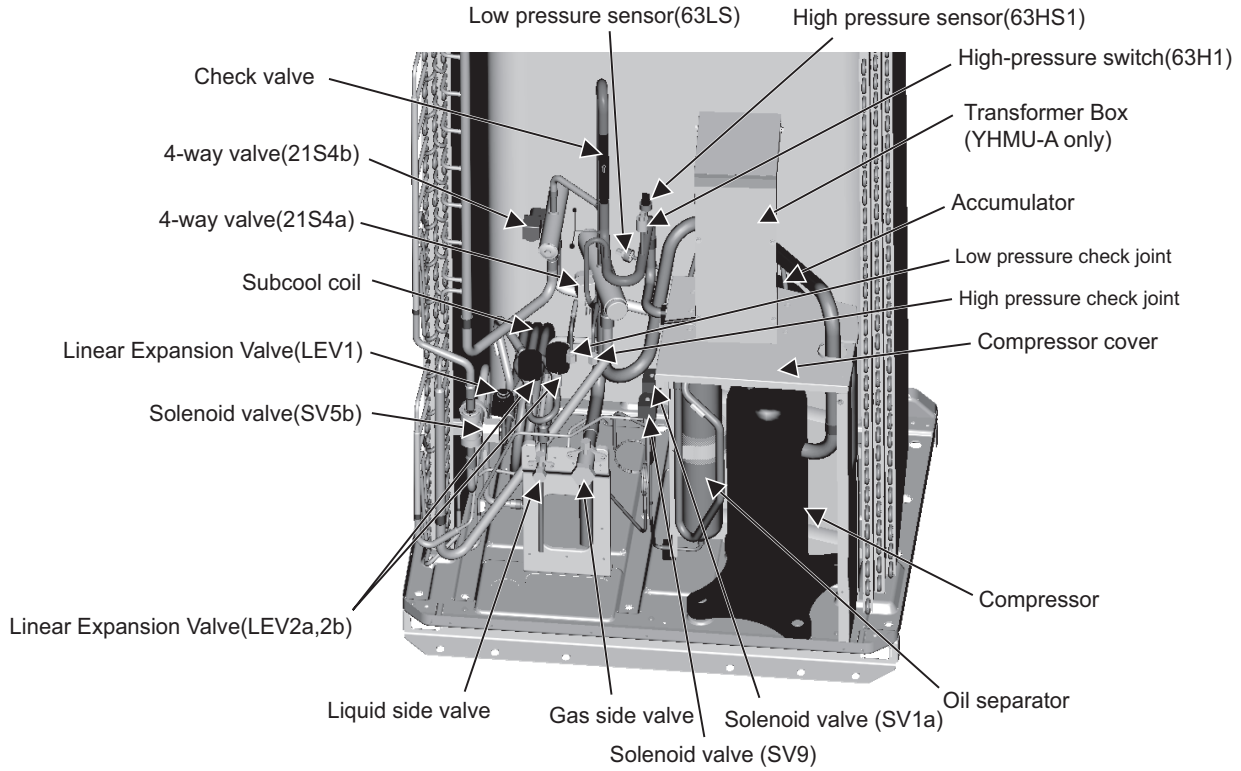

**3. PUHY- P120THMU-A
PUHY- P120YHMU-A**

(1) Refrigerant circuit

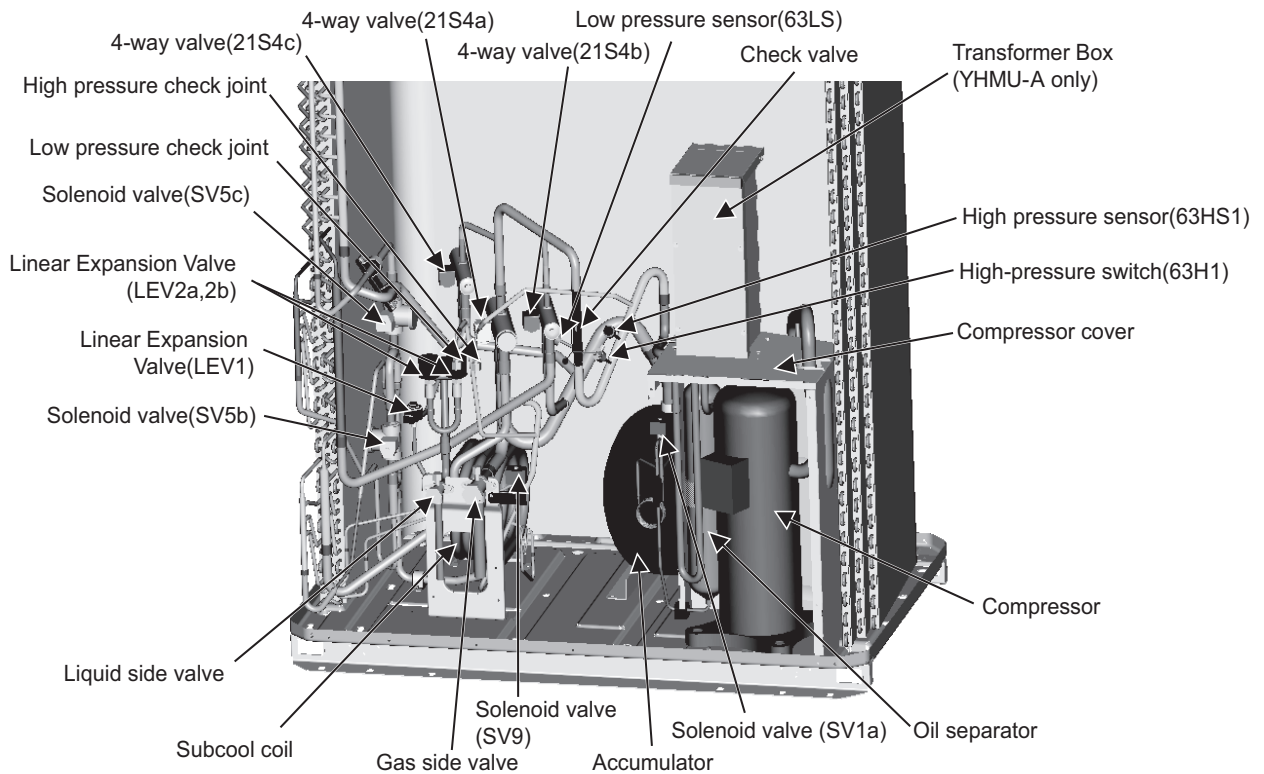

[2] Control Box of the Outdoor Unit

<HIGH VOLTAGE WARNING>



- Control box houses high-voltage parts.
- When opening or closing the front panel of the control box, do not let it come into contact with any of the internal components.
- Before inspecting the inside of the control box, turn off the power, keep the unit off for at least 10 minutes, and confirm that the voltage between FT-P and FT-N on INV Board has dropped to DC20V or less. (It takes about 10 minutes to discharge electricity after the power supply is turned off.)

1. PUHY-P72, P96THMU-A

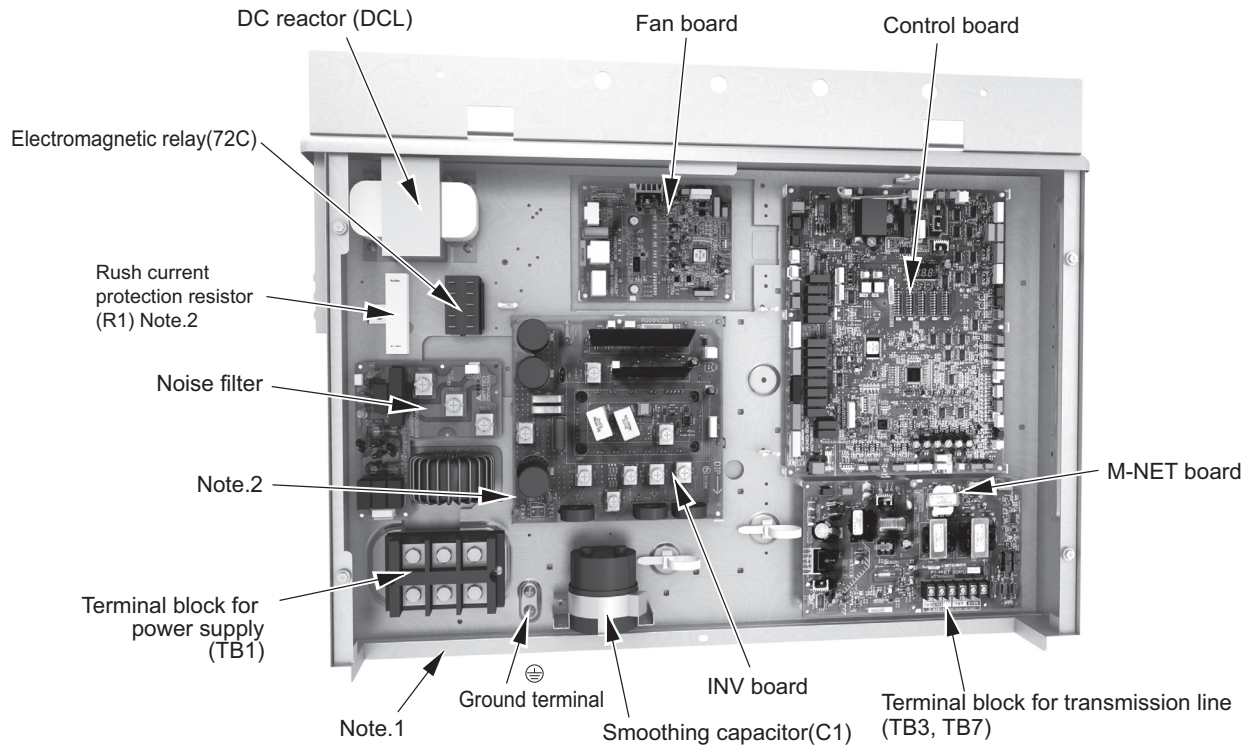

Note

- 1) Exercise caution not to damage the bottom and the front panel of the control box. Damage to these parts affect the water-proof and dust proof properties of the control box and may result in damage to its internal components.
- 2) Faston terminals have a locking function. Make sure the cable heads are securely locked in place. Press the tab on the terminals to remove them.

2. PUHY-P120THMU-A

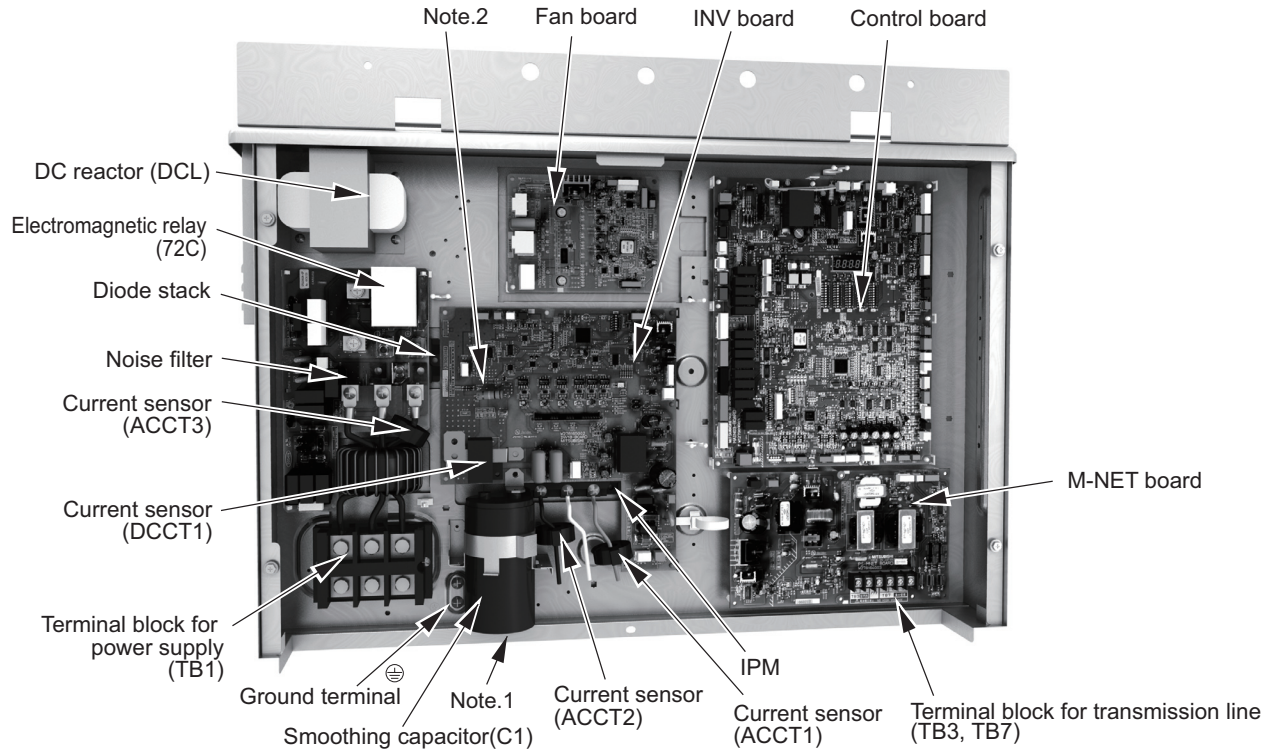

3. PUHY-P72, P96, P120YHMU-A

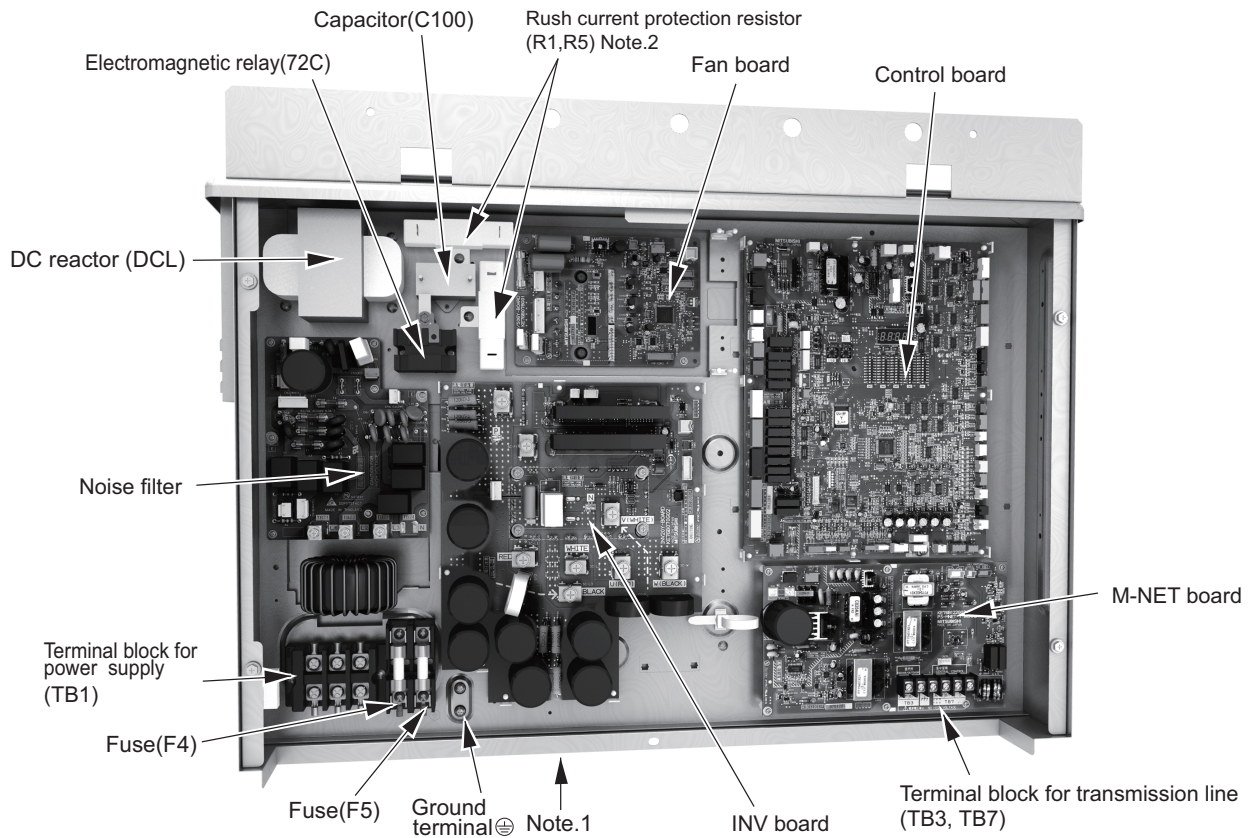

Note

- 1) Exercise caution not to damage the bottom and the front panel of the control box. Damage to these parts affect the water-proof and dust proof properties of the control box and may result in damage to its internal components.
- 2) Faston terminals have a locking function. Make sure the cable heads are securely locked in place. Press the tab on the terminals to remove them.

4. Transformer Box (PUHY-P72, P96, P120YHMU-A)

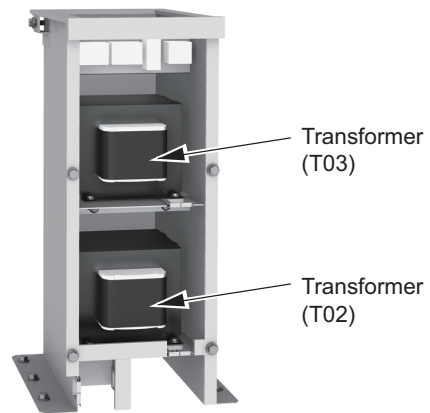

[3] Outdoor Unit Circuit Board

1. Outdoor unit control board

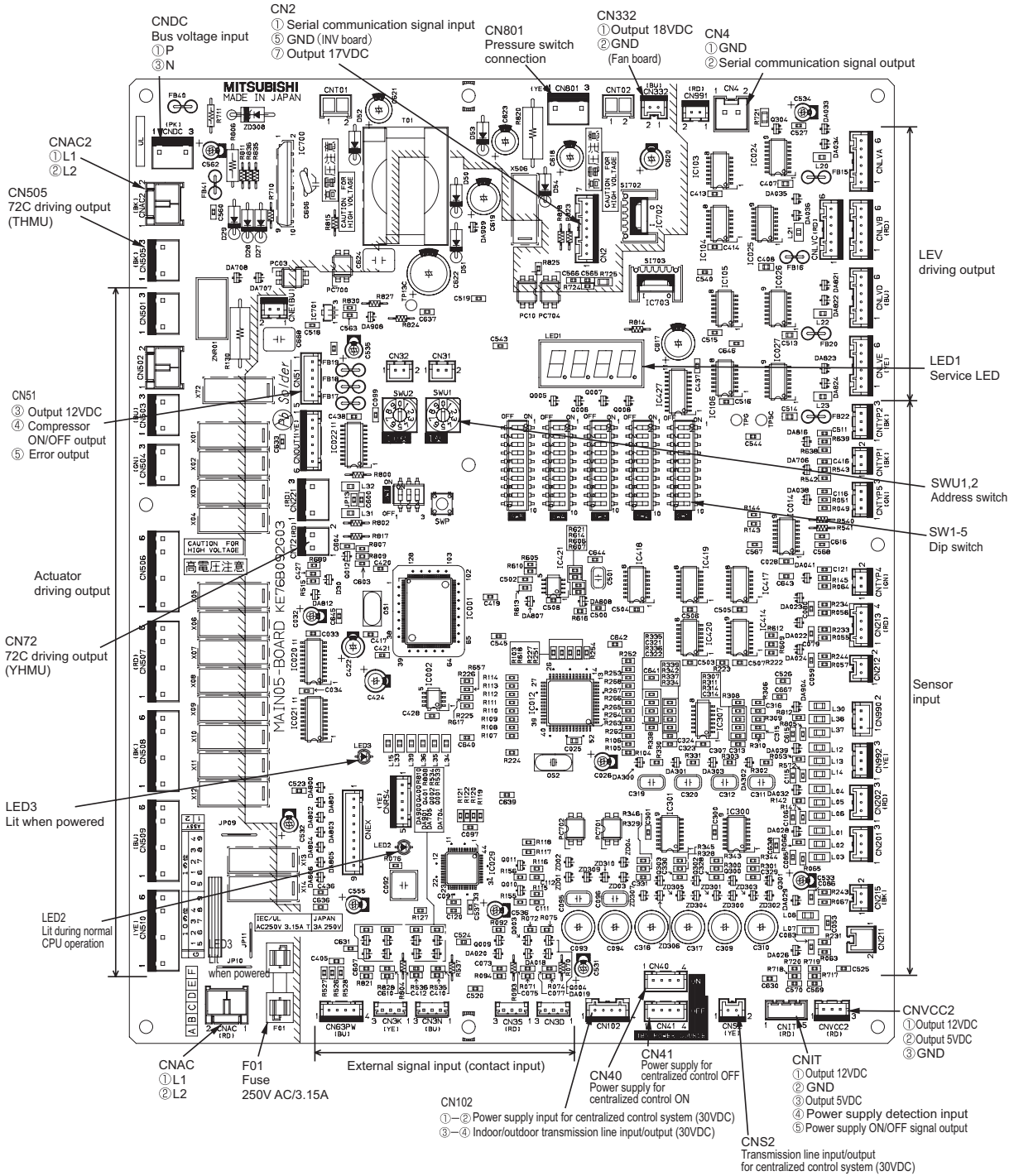

2. M-NET board

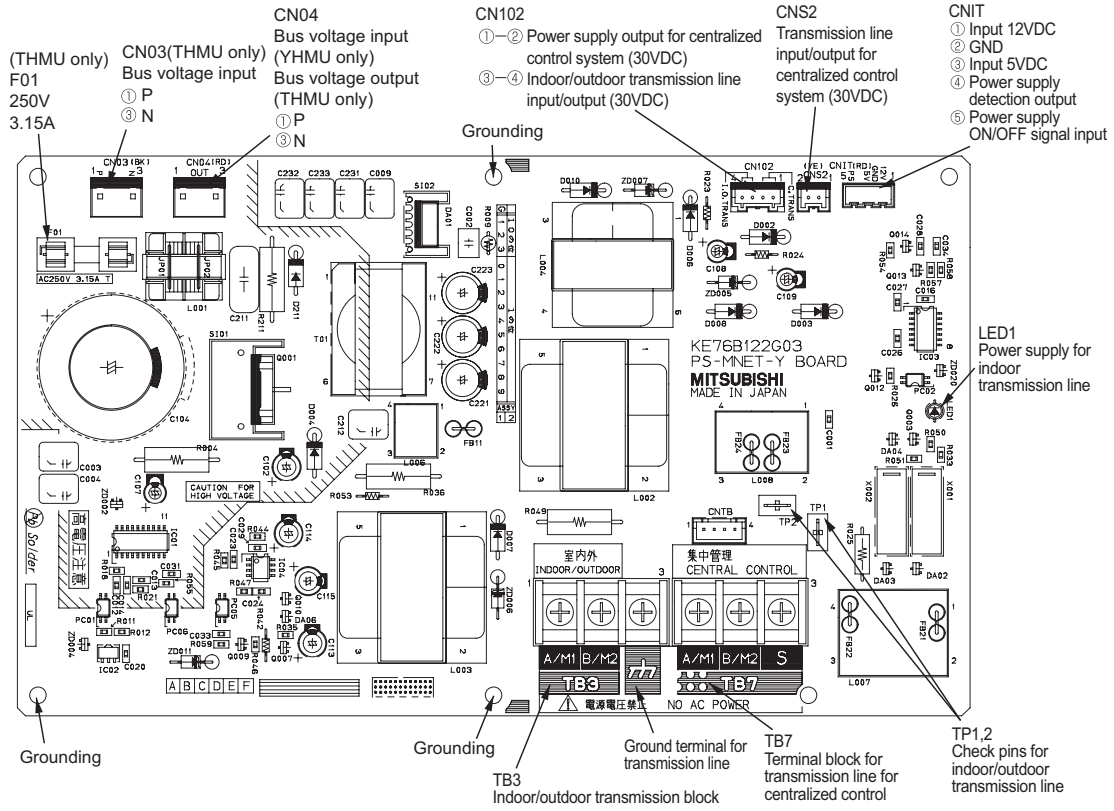

3. INV board

(1) PUHY-P72, P96THMU-A

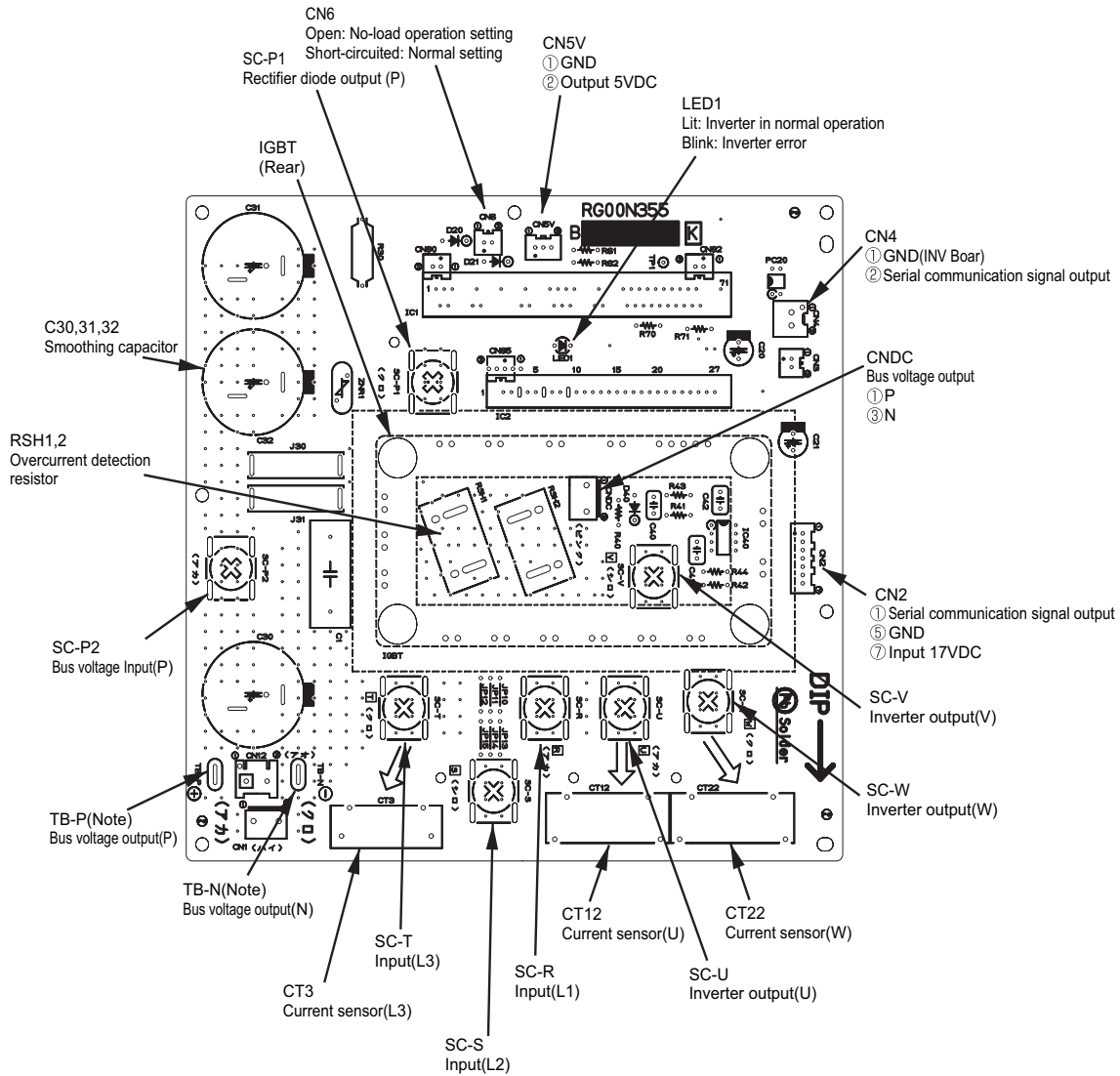

Note

Faston terminals have a locking function. Make sure the cable heads are securely locked in place. Press the tab on the terminals to remove them.

(2) PUHY-P120THMU-A

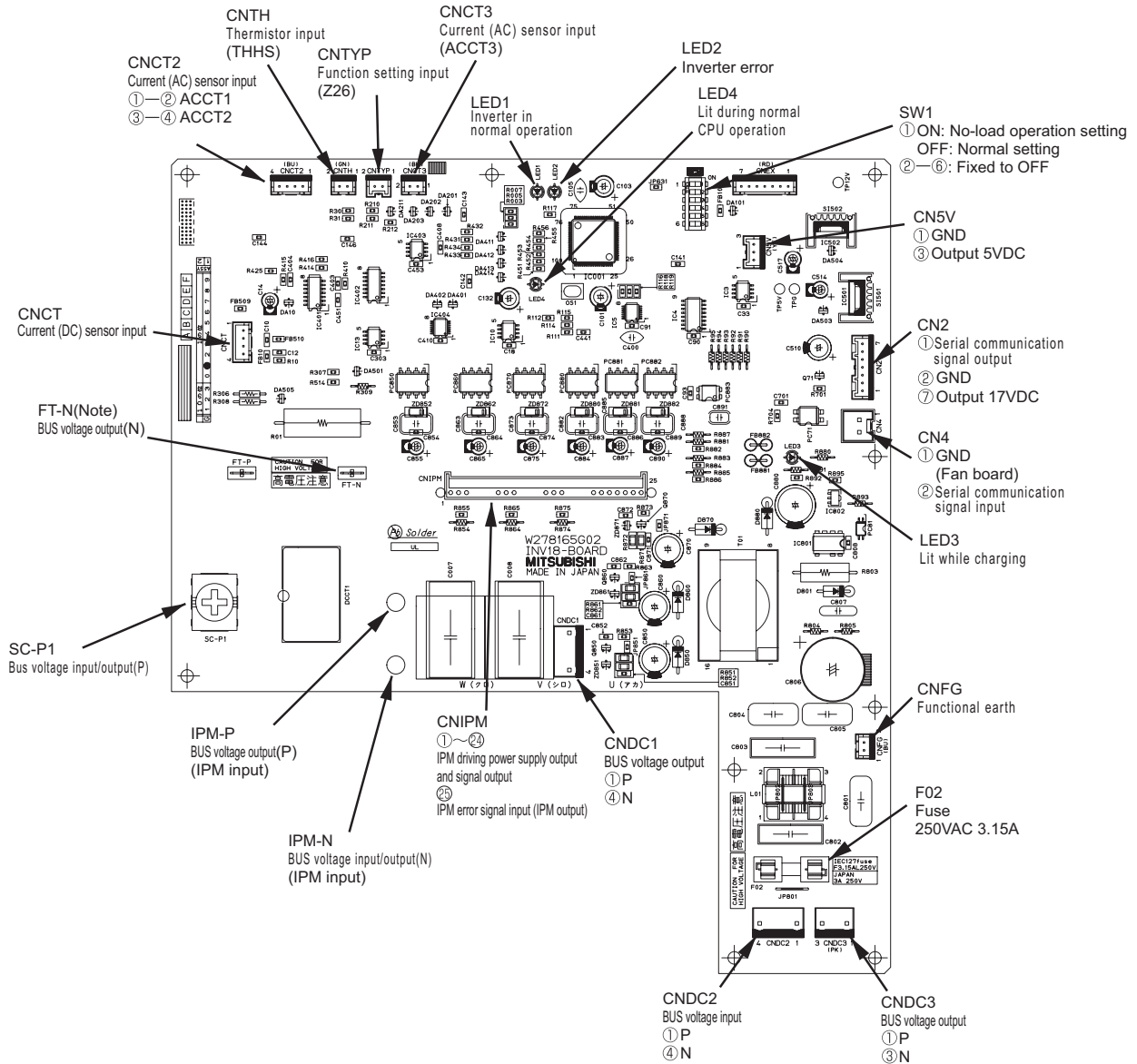

Note

Faston terminals have a locking function. Make sure the cable heads are securely locked in place. Press the tab on the terminals to remove them.

(3) PUHY-P72, P96, P120YHMU-A

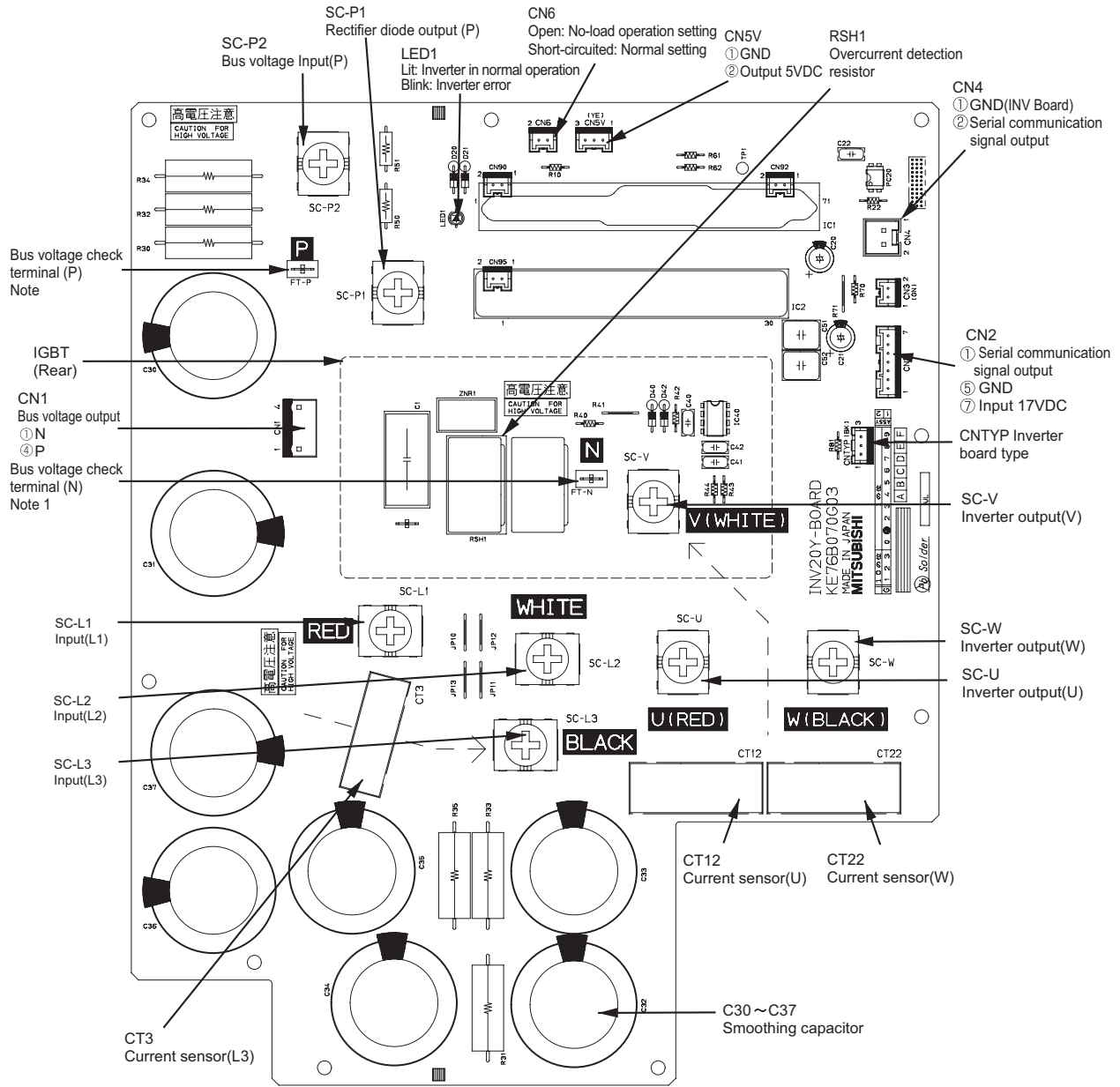

Note

- 1) Before inspecting the inside of the control box, turn off the power, keep the unit off for at least 10 minutes, and confirm that the voltage between FT-P and FT-N on INV Board has dropped to DC20V or less. (It takes about 10 minutes to discharge electricity after the power supply is turned off.)

(2) PUHY-P72, P96, P120YHMU-A

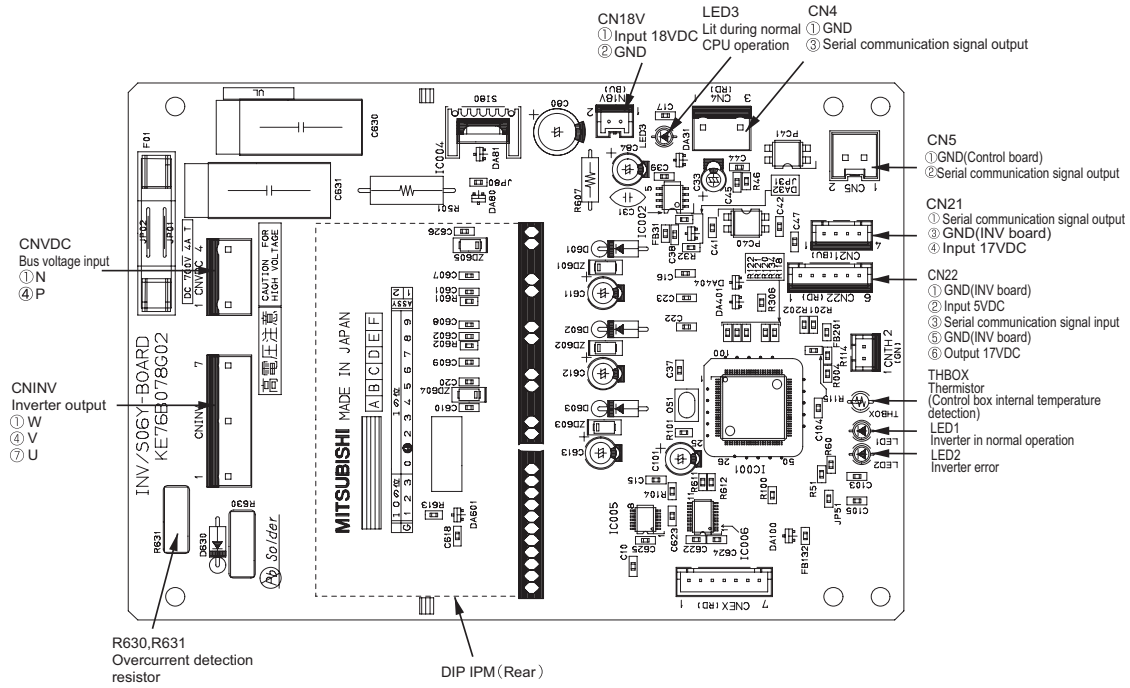

5. Noise Filter

(1) PUHY-P72, P96THMU-A

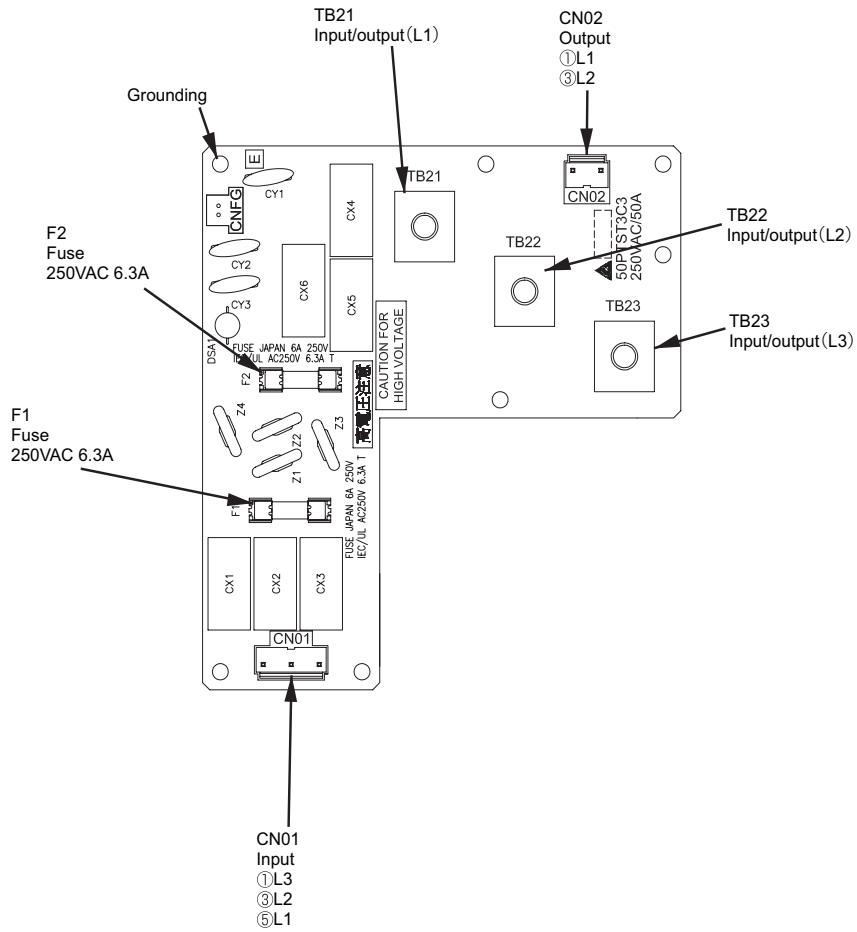

(2) PUHY-P120THMU-A

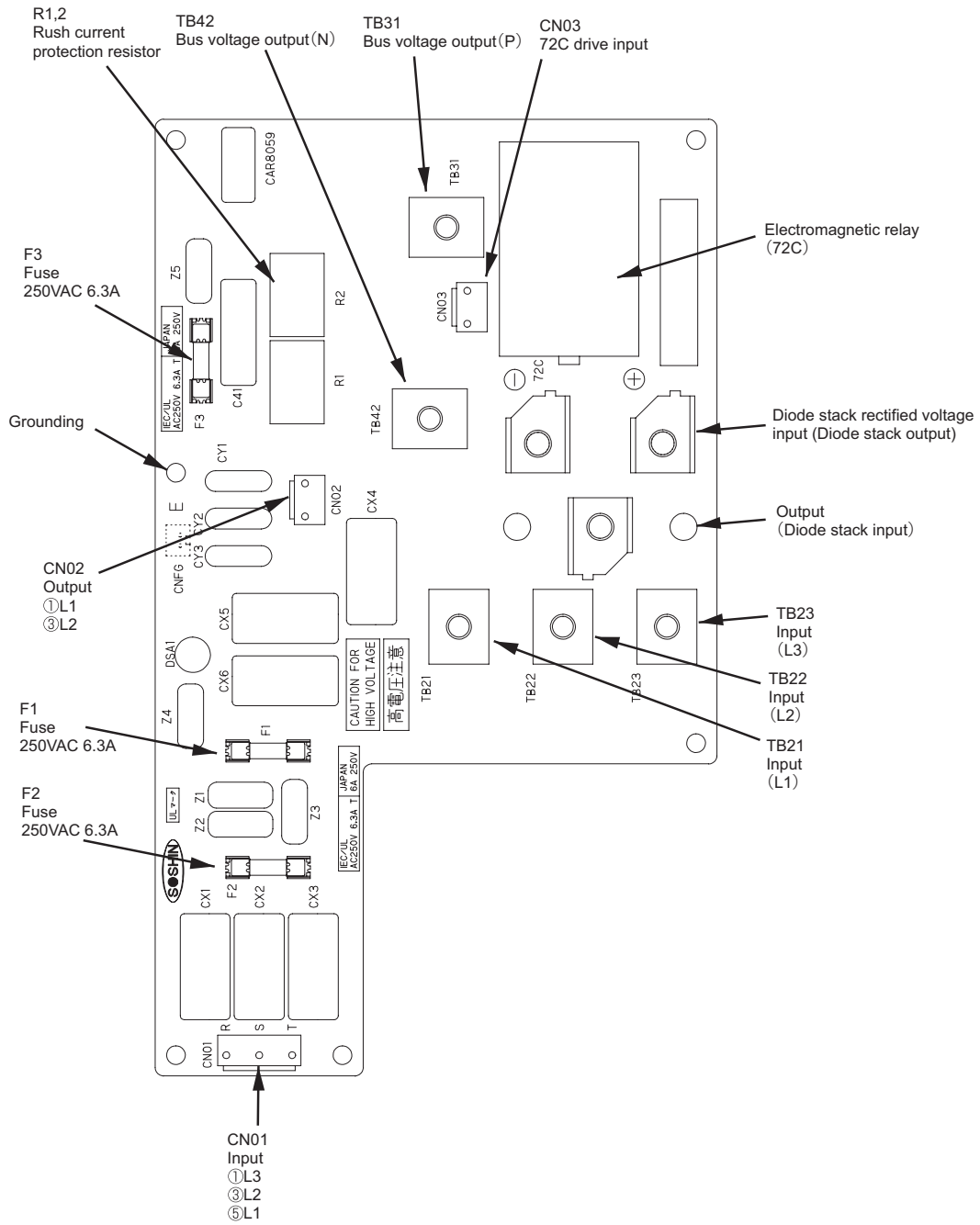

(3) PUHY-P72, P96, P120YHMU-A

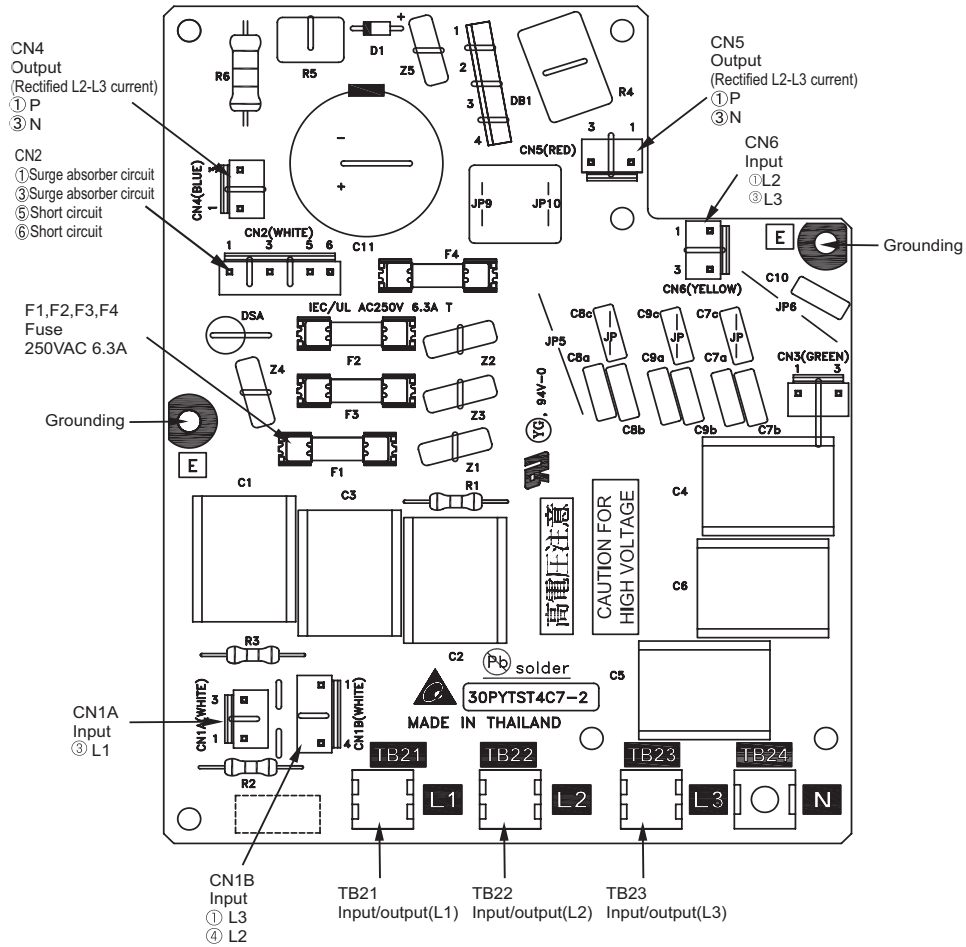

IV Remote Controller

- [1] Functions and Specifications of MA and ME Remote Controllers 65
- [2] Group Settings and Interlock Settings via the ME Remote Controller 66
- [3] Interlock Settings via the MA Remote Controller 70
- [4] Using the built-in Temperature Sensor on the Remote Controller 71



[1] Functions and Specifications of MA and ME Remote Controllers

There are two types of remote controllers: M-NET (ME) remote controller, which is connected on the indoor-outdoor transmission line, and MA remote controller, which is connected to each indoor unit.

1. Comparison of functions and specifications between MA and ME remote controllers

Functions/specifications	MA remote controller ^{*1*2}	M-NET (ME) remote controller ^{*2*3}
Remote controller address settings	Not required	Required
Indoor/outdoor unit address settings	Not required (required only by a system with one outdoor unit) ^{*4}	Required
Wiring method	Non-polarized 2-core cable *To perform a group operation, daisy-chain the indoor units using non-polarized 2-core cables.	Non-polarized 2-core cable
Remote controller connection	Connectable to any indoor unit in the group	Connectable anywhere on the indoor-outdoor transmission line
Interlock with the ventilation unit	Each indoor unit can individually be interlocked with a ventilation unit. (Set up via remote controller in the group.)	Each indoor unit can individually be interlocked with a ventilation unit. (Set up via remote controller.)
Changes to be made upon grouping change	MA remote controller wiring between indoor units requires rewiring.	Either the indoor unit address and remote controller address must both be changed, or the registration information must be changed via MELANS.

- *1. MA remote controller refers to MA remote controller (PAR-20MAA, PAR-21MAA), MA simple remote controller, and wireless remote controller.
- *2. Either the MA remote controller or the M-NET remote controller can be connected when a group operation of units in a system with multiple outdoor units is conducted or when a system controller is connected.
- *3. M-NET remote controller refers to ME remote controller and ME simple remote controller.
- *4. Depending on the system configuration, some systems with one outdoor unit may require address settings.

2. Remote controller selection criteria

MA remote controller and M-NET remote controller have different functions and characteristics. Choose the one that better suits the requirements of a given system. Use the following criteria as a reference.

MA remote controller ^{*1*2}	M-NET (ME) remote controller ^{*1*2}
<ul style="list-style-type: none"> ♦There is little likelihood of system expansion and grouping changes. ♦Grouping (floor plan) has been set at the time of installation. 	<ul style="list-style-type: none"> ♦There is a likelihood of centralized installation of remote controllers, system expansion, and grouping changes. ♦Grouping (floor plan) has not been set at the time of installation. ♦To connect the remote controller directly to the OA processing unit.

- *1. M-NET remote controller and MA remote controller cannot both be connected to the same group of indoor units.
- *2. A system controller must be connected to a system to which both MA remote controller and M-NET remote controller are connected.

<System with MA remote controller>

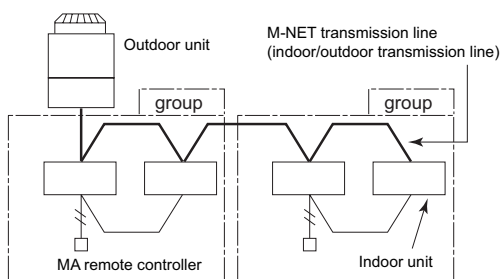

<System with M-NET remote controllers>

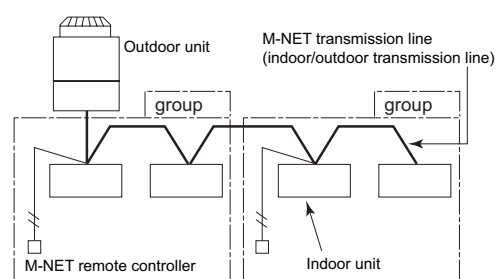

[2] Group Settings and Interlock Settings via the ME Remote Controller

1. Group settings/interlock settings

Make the following settings to perform a group operation of units that are connected to different outdoor units or to manually set up the indoor/outdoor unit address.

(A) Group settings.....Registration of the indoor units to be controlled with the remote controller, and search and deletion of registered information.

(B) Interlock settings.....Registration of LOSSNAY units to be interlocked with the indoor units, and search and deletion of registered information

[Operation Procedures]

(1) Address settings

Register the indoor unit to be controlled with the remote controller.

- ① **Bring up either the blinking display of “HO” by turning on the unit or the normal display by pressing the ON/OFF button.**

The display window must look like one of the two figures below to proceed to the next step.

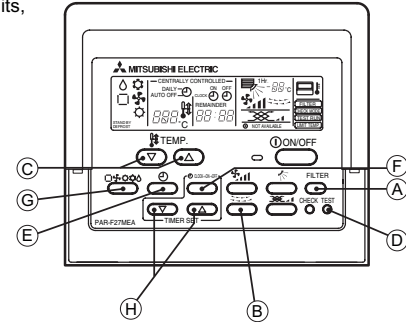
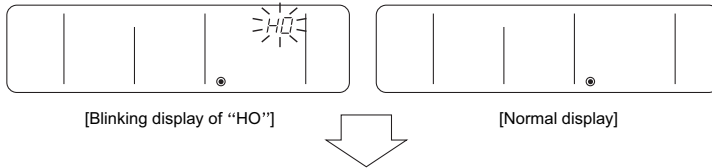

(A) Group Settings

- ② **Bring up the “Group Setting” window.**

-Press and hold buttons (A) [FILTER] and (B) [TIMER SET] simultaneously for 2 seconds to bring up the display as shown below.

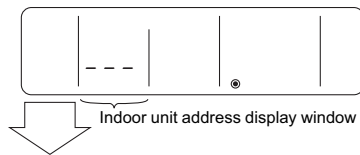

- ③ **Select the unit address.**

- Select the address of the indoor unit to be registered by pressing button (C) [TEMP. (▽) or (△)] to advance or go back through the addresses.

- ④ **Register the indoor unit whose address appears on the display.**

- Press button (D) [TEST] to register the indoor unit address whose address appears on the display.
 - If registration is successfully completed, unit type will appear on the display as shown in the figure below.
 - If the selected address does not have a corresponding indoor unit, an error message will appear on the display. Check the address, and try again.

<Successful completion of registration>

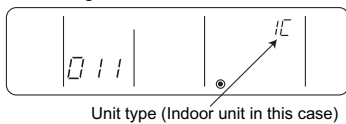

<Deletion error>

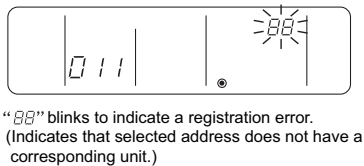

“BB” blinks to indicate a registration error. (Indicates that selected address does not have a corresponding unit.)

- ⑤ **To register the addresses for multiple indoor units, repeat steps ③ and ④ above.**

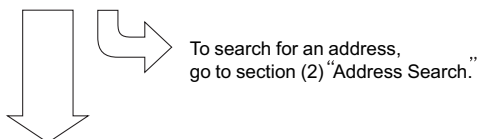

To next page.

(B) Interlock Settings

- ⑥ **Bring up the “Interlock Setting” window.**

-Press button (G) [□♦♦♦♦] to bring up the following display. Press again to go back to the “Group Setting” window as shown under step ②.

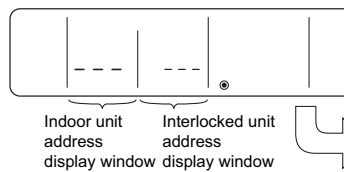

Both the “indoor unit address” and “interlocked unit address” will be displayed together.

To search for an address, go to section (2) “Address Search.”

- ⑦ **Bring up the address of the indoor unit and the address of the LOSSNAY to be interlocked on the display.**

- Select the address of the indoor unit to be registered by pressing button (C) [TEMP. (▽) or (△)] to advance or go back through the addresses.
 - Select the address of the LOSSNAY unit to be interlocked by pressing button (H) [TIMER SET (▽) or (△)] to advance or go back through the “interlocked unit addresses.”



- ⑧ **Make the settings to interlock LOSSNAY units with indoor units.**

- Press button (D) [TEST] while both the indoor unit address and the address of the LOSSNAY units to be interlocked are displayed to enter the interlock setting.
 - Interlock setting can also be made by bringing up the LOSSNAY address in the indoor unit address display window and the indoor unit address in the interlocked unit address display window.



If registration is successfully completed, the two displays as shown on the left will appear alternately.

If the registration fails, “BB” will blink on the display. (Indicates that the selected address does not have a corresponding unit.)

NOTE : Interlock all the indoor units in the group with the LOSSNAY units; otherwise, the LOSSNAY units will not operate.



(C) To return to the normal display

When all the group settings and interlock settings are made, take the following step to go back to the normal display.

- ⑩ Press and hold buttons **(A) [FILTER]** and **(B) []** simultaneously for 2 seconds to go back to the window as shown in step ①.



(2) Address search

To search for the address of indoor units that have been entered into the remote controller, follow steps ① and ②.



(A) To search group settings

⑪ Bring up the "Group Setting" window.

- Each pressing of button **(E) []** will bring up the address of a registered indoor unit and its unit type on the display.

<Entry found>



<No entries found>



- When only one unit address is registered, the same address will remain on the display regardless of how many times the button is pressed.
- When the address of multiple units are registered (i.e. "011", "012", "013"), they will be displayed one at a time in an ascending order with each pressing of button **(E) []**.

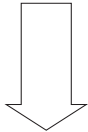

To delete an address, go to section (3) "Address Deletion."



⑨ Repeat steps ⑦ and ⑧ in the previous page to interlock all the indoor units in a group with the LOSSNAY unit.



To go back to the normal display, follow step ⑩.



To search for an address, go to section (2) "Address Search."

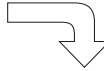

(B) Interlock setting search

After performing step ⑥, proceed as follows:

⑫ Bring up the address of the indoor unit to be searched on the display.

- Select the address of the indoor unit to be searched by pressing button **(H) [TIMER SET (▽) or (△)]** to advance or go back through the interlocked addresses.



LOSSNAY can be searched in the same manner by bringing up the LOSSNAY address in the Interlocked unit address display window.

⑬ Bring up on the display the address of the LOSSNAY unit that was interlocked with the indoor unit in step ⑫.

- With each pressing of button **(E) []**, the address of the LOSSNAY and indoor unit that is interlocked with it will be displayed alternately.

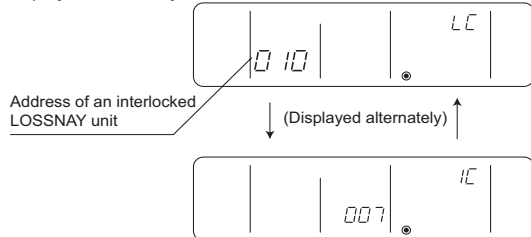

⑭ Bring up the address of another registered unit on the display.

- After completing step ⑬, a subsequent pressing of button **(E) []** will bring up the address of another registered unit.

(The display method is the same as the one in step ⑬.)

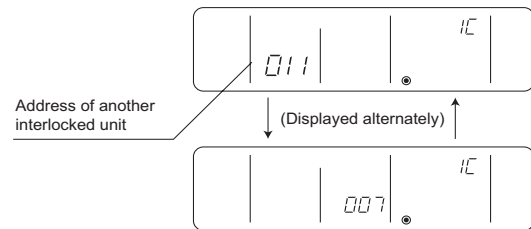

To delete an address, go to section (3) "Address Deletion."

To go back to the normal display, follow step ⑩.

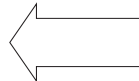

(3) Address deletion

The addresses of the indoor units that have been entered into the remote controller can be deleted by deleting the group settings.

The interlock settings between units can be deleted by deleting the interlock settings.

Follow the steps in section (2) "Address Search" to find the address to be deleted and perform deletion with the address being displayed in the display window. To delete an address, the address must first be brought up on the display.

⑮ Delete the registered indoor unit address or the interlock setting between units.

- Press button **(F) [CLOCK → ON → OFF]** twice while either the indoor unit address or the address of the interlocked unit is displayed on the display to delete the interlock setting.

[Operation Procedures]

1. Press the [ON/OFF] button on the remote controller to bring the unit to a stop. The display will appear as shown in the previous page (Normal display).
2. Press buttons ① [CHECK] and [] simultaneously for 2 seconds to go into the "Skip-Auto-Mode setting." under the remote controller function selection mode. Press button ② [SET TEMP. (▽)] or ③ [SET TEMP. (△)] to go into the other four modes under the remote controller function selection mode.

Skip-Auto-Mode setting (Making the automatic operation mode unselectable)

This setting is valid only when the controller is connected to the simultaneous cooling/heating type air conditioning units that support the automatic operation mode.

- " " blinks and either "ON" or "OFF" lights up on the controller. Pressing the ④ [TIMER SET (△) or (▽)] button switches between "ON" and "OFF."

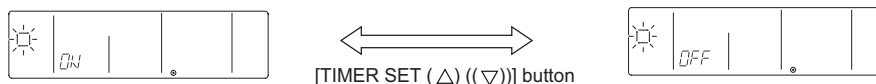

- When set to "ON," the automatic operation mode is available for selection in the function selection mode.
- When set to "OFF," the automatic operation mode is not available for selection in the function selection mode, and an automatic operation cannot be performed.
(The automatic operation mode is skipped in the function selection mode sequence.)

Operation mode display selection mode (Changing the type of display that appears during the automatic mode operation)

- When connected to the air conditioning units that do not support the automatic operation mode, the setting for this mode is invalid.
- " " " " will blink, and either "ON" or "OFF" will light up. Press button ④ [TIMER SET (△) or (▽)] in this state to switch between "ON" and "OFF."

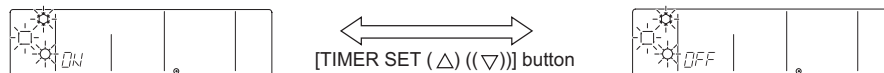

- When it is set to "ON," " " " " will appear on the display during automatic operation mode.
- When it is set to "OFF," only " " will appear on the display during automatic operation mode.

Restricted preset temperature range mode (The range of preset temperature can be changed.)

1) Temperature range setting for the cooling/dry mode

" / " will light up in the display window, and the temperature range for the cooling/dry mode will appear on the display.

[Lower limit temperature]: Appears in the preset temperature display window [Upper limit temperature: Appears in the time display window
Switch between the Lower and Upper limit temperature setting by pressing the ⑤ [CLOCK-ON-OFF] button. The selected temperature setting blinks.

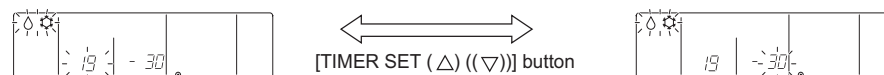

[The left figure shows the display that appears when the current temperature range setting is between 19°C and 30°C in the Cool/Dry mode, and the lower limit temperature is selected to be set.]

Press button ④ [TIMER SET (△) or (▽)] to set the lower limit temperature to the desired temperature.

[Settable range for the lower limit temperature] : 19°C ⇔ 30°C (Settable up to the upper limit temperature that is shown on the display)
[Settable range for the upper limit temperature] : 30°C ⇔ 19°C (Settable up to the lower limit temperature that is shown on the display)

2) Temperature range setting for heating

" " and the settable temperature range for heating appear on the display.

As with the Cool/Dry mode, use the ⑤ [CLOCK-ON-OFF] button and the ④ [TIMER SET (△) or (▽)] to set the temperature range.

[Settable range for the lower limit temperature] : 17°C ⇔ 28°C (Settable up to the upper limit temperature that is shown on the display)
[Settable range for the upper limit temperature] : 28°C ⇔ 17°C (Settable up to the lower limit temperature that is shown on the display)

3) Temperature range setting for the automatic mode

When connected to the air conditioning units that do not support the automatic operation mode, the setting for this mode is invalid.

" " and the temperature range for the automatic operation mode appear on the display.

As with the Cool/Dry mode, use the ⑤ [CLOCK-ON-OFF] button and the ④ [TIMER SET (△) or (▽)] to set the temperature range.

[Settable range for the lower limit temperature] : 19°C ⇔ 28°C (Settable up to the upper limit temperature that is shown on the display)
[Settable range for the upper limit temperature] : 28°C ⇔ 19°C (Settable up to the lower limit temperature that is shown on the display)

Room temperature display selection mode (Switching between the display or non-display of room temperature on the controller)

- " 88°C " blinks and either "ON" or "OFF" lights up on the controller. Pressing the ④ [TIMER SET (△) or (▽)] button switches between "ON" and "OFF."

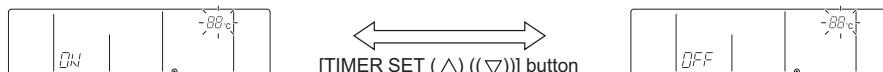

- When set to "ON," room temperature always appears on the display during operation.
When set to "OFF," room temperature does not appear on the display during operation.

[3] Interlock Settings via the MA Remote Controller

1. LOSSNAY interlock setting (Make this setting only when necessary.)

Make this setting only when necessary.

Perform this operation to enter the interlock setting between the LOSSNAY and the indoor units to which the remote controller is connected, or to search and delete registered information.
In the following example, the address of the indoor unit is 05 and the address of the LOSSNAY unit is 30.

[Operation Procedures]

- ① Press the [ON/OFF] button on the remote controller to bring the unit to a stop.
The display window on the remote controller must look like the figure below to proceed to step ②.



- ② Press and hold the [FILTER] and [LOSSNAY] buttons simultaneously for two seconds to perform a search for the LOSSNAY that is interlocked with the indoor unit to which the remote controller is connected.



- ③ Search result
- The indoor unit address and the interlocked LOSSNAY address will appear alternately.

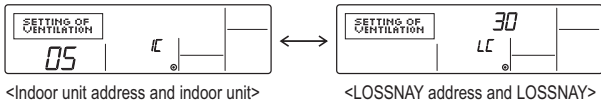

<Indoor unit address and indoor unit>

<LOSSNAY address and LOSSNAY>

- Without interlocked LOSSNAY settings

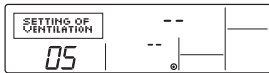

- ④ If no settings are necessary, exit the window by pressing and holding the [FILTER] and [LOSSNAY] buttons simultaneously for 2 seconds.
Go to step 1. **Registration Procedures** to make the interlock settings with LOSSNAY units, or go to step 2. **Search Procedures** to search for a particular LOSSNAY unit.
Go to step 3. **Deletion Procedures** to delete any LOSSNAY settings.

< 1. Registration Procedures >

- ⑤ To interlock an indoor unit with a LOSSNAY unit, press the [TEMP. (▽) or (△)] button on the remote controller that is connected to the indoor unit, and select its address (01 to 50).
⑥ Press the [CLOCK (▽) or (△)] button to select the address of the LOSSNAY to be interlocked (01 to 50).

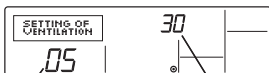

Indoor unit address LOSSNAY address

- ⑦ Press the [TEST] button to register the address of the selected indoor unit and the interlocked LOSSNAY unit.
- Registration completed
The registered indoor unit address and "IC," and the interlocked LOSSNAY address and "LC" will appear alternately.

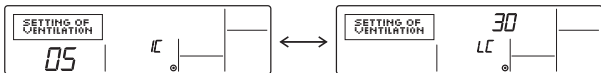

- Registration error

If the registration fails, the indoor unit address and the LOSSNAY address will be displayed alternately.

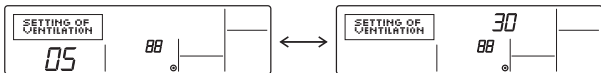

Registration cannot be completed: The selected unit address does not have a corresponding indoor unit or a LOSSNAY unit.
Registration cannot be completed: Another LOSSNAY has already been interlocked with the selected indoor unit.

< 2. Search Procedures >

⑧ To search for the LOSSNAY unit that is interlocked with a particular indoor unit, enter the address of the indoor unit into the remote controller that is connected to it.

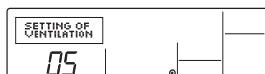

<Indoor unit address>

⑨ Press the [MENU] button to search for the address of the LOSSNAY unit that is interlocked with the selected indoor unit.

- Search completed (With a LOSSNAY connection)

The indoor unit address and "IC," and the interlocked LOSSNAY address and "LC" will appear alternately.

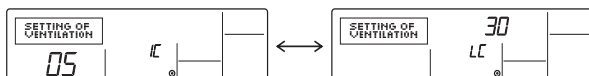

- Search completed (No interlocked settings with a LOSSNAY exist.)

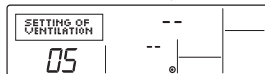

- The selected address does not have a corresponding indoor unit.

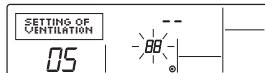

< 3. Deletion Procedures >

Take the following steps to delete the interlock setting between a LOSSNAY unit and the interlocked indoor unit from the remote controller that is connected to the indoor unit.

⑩ Find the address of the LOSSNAY to be deleted (See section 2. Search Procedures.), and bring up the result of the search for both the indoor unit and LOSSNAY on the display.

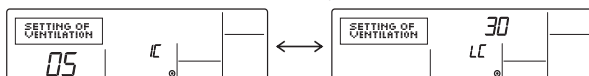

⑪ Press the [ON/OFF] button twice to delete the address of the LOSSNAY unit that is interlocked with the selected indoor unit.

- Registration completed

The indoor unit address and "--," and the interlocked LOSSNAY address and "--" will appear alternately.

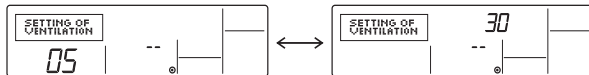

-Deletion error

If the deletion fails

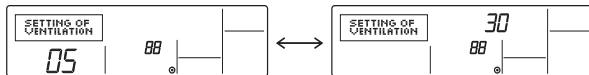

[4] Using the built-in Temperature Sensor on the Remote Controller

1. Selecting the position of temperature detection (Factory setting: SW1-1 on the controller board on the indoor unit is set to OFF.)

To use the built-in sensor on the remote controller, set the SW1-1 on the controller board on the indoor unit to ON.

•Some models of remote controllers are not equipped with a built-in temperature sensor. Use the built-in temperature sensor on the indoor unit instead.

•When using the built-in sensor on the remote controller, install the remote controller where room temperature can be detected.

V Electrical Wiring Diagram

[1] Electrical Wiring Diagram of the Outdoor Unit	75
[2] Electrical Wiring Diagram of Transmission Booster.....	78



[1] Electrical Wiring Diagram of the Outdoor Unit

1. Electrical wiring diagram of the outdoor unit (1) PUHY-P72, P96THMU-A

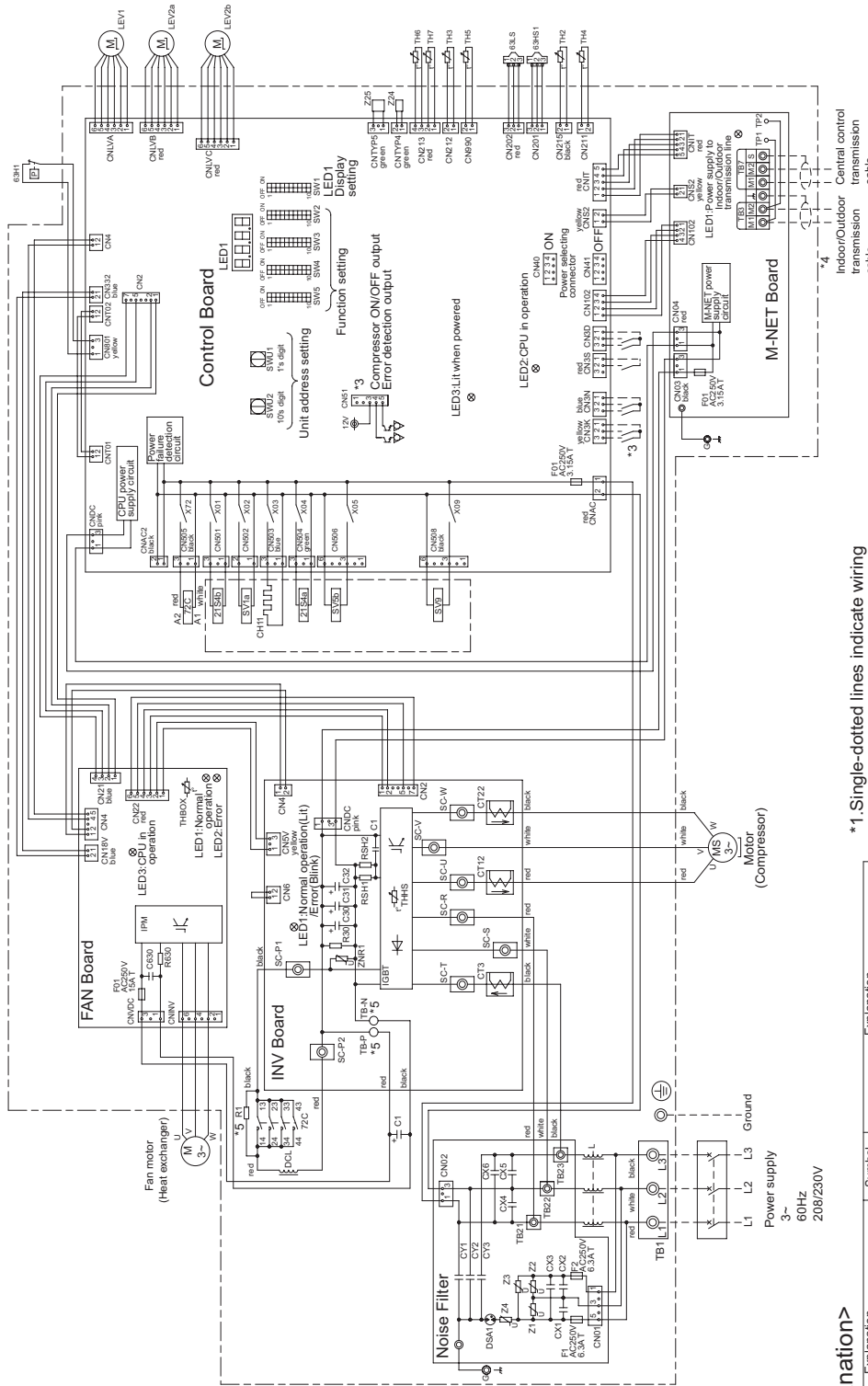

- *1. Single-dotted lines indicate wiring not supplied with the unit.
- *2. Dot-dash lines indicate the control box boundaries.
- *3. Refer to the Data book for connecting input/output signal connectors.
- *4. Daisy-chain terminals (TB3) on the outdoor units in the same refrigerant system together.
- *5. Faston terminals have a locking function. Make sure the terminals are securely locked in place after insertion. Press the tab on the terminals to removed them.

<Symbol explanation>

Symbol	Explanation	Symbol	Explanation
21S4a	Cooling/Heating switching	TB1	Power supply terminal block
21S4b	Heat exchanger capacity control	TB3	Indoor/Outdoor transmission cable
63H1	Pressure sensor	TB7	Indoor control transmission cable
63LS	Discharge pressure sensor	TH2	Subcool bypass outlet temperature
72C	Low pressure	TH3	Pipe temperature
CT12.22.3	Magnetic relay (inverter main circuit)	TH4	Discharge pipe temperature
CH11	Current sensor (AC)	TH5	ACC inlet pipe temperature
DCL	Crankcase heater (for heating the compressor)	TH6	Subcooled liquid refrigerant temperature
LEV1	DC reactor	TH7	Outdoor box internal temperature
LEV2a,b	Linear expansion valve	TH8	Control box internal temperature
SV1a	HIC bypass. Controls refrigerant flow in HIC circuit.	TH9	IGBT temperature
SV4b	For opening/closing the bypass circuit under the O/S	Z24,25	Function setting connector
SV9	Outdoor unit heat exchanger capacity control		
	For opening/closing the bypass circuit		

(2) PUHY-P120THMU-A

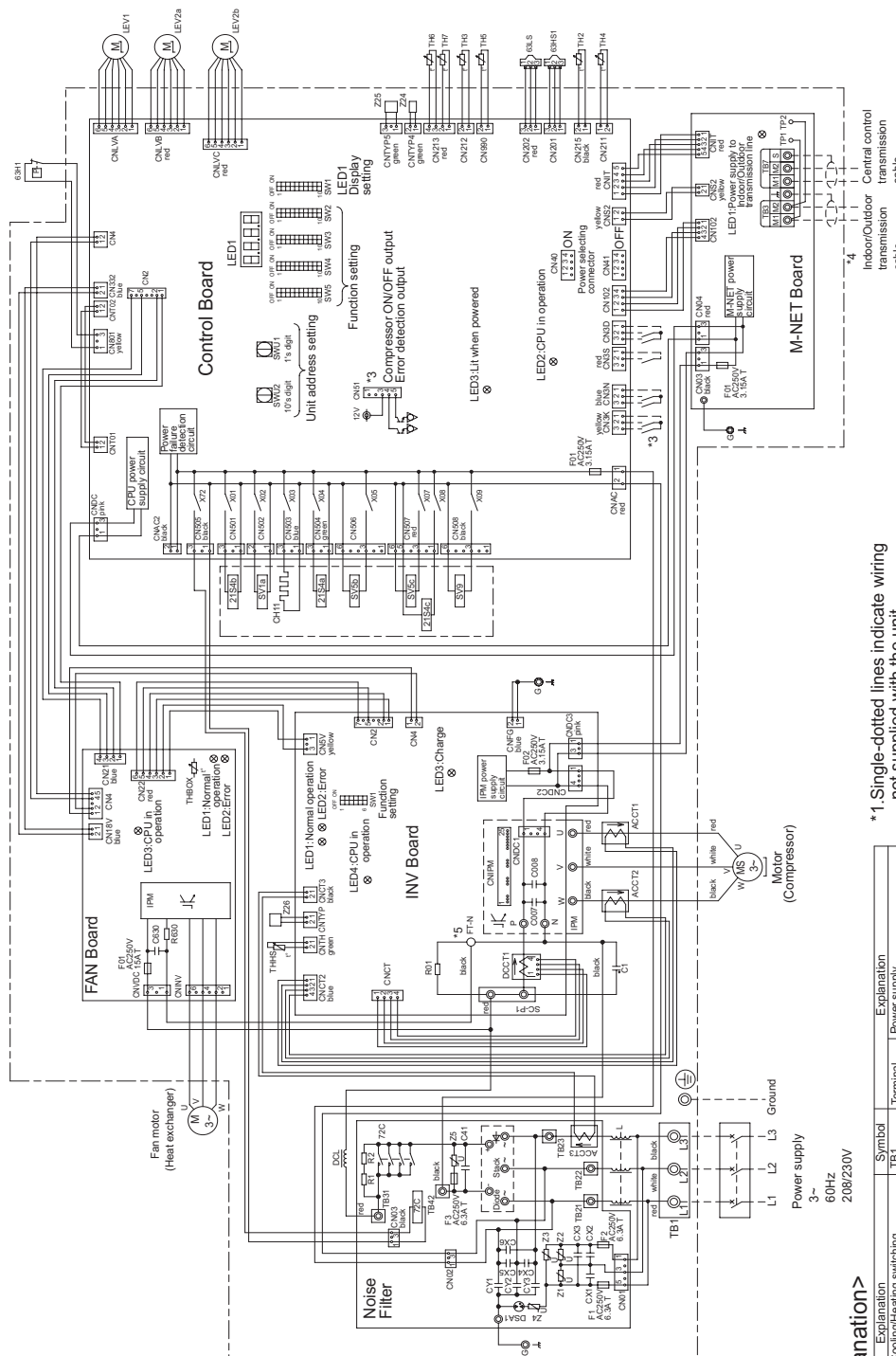

- *1. Single-dotted lines indicate wiring not supplied with the unit.
- *2. Dot-dash lines indicate the control box boundaries.
- *3. Refer to the Data book for connecting input/output signal connectors.
- *4. Daisy-chain terminals (TB3) on the outdoor units in the same refrigerant system together.
- *5. Faston terminals have a locking function. Make sure the terminals are securely locked in place after insertion. Press the tab on the terminals to removed them.

<Symbol explanation>

Symbol	Explanation	Symbol	Explanation
2/1S4a	Cooling/Heating switching	TB1	Power supply
2/1S4b,c	Heat exchanger capacity control	TB3	Indoor/Outdoor transmission terminal block
63H1	Pressure switch	TB7	Central control transmission cable
63HS1	Pressure sensor	TH2	Subcool bypass outlet temperature
63LS	Low pressure sensor	TH3	Pipe temperature
72C	Magnetic relay (inverter main circuit)	TH4	Discharge pipe temperature
ACCT1, 2, 3	Current sensor (AC)	TH5	ACC inlet pipe temperature
GH1	Crankcase heater (for heating the compressor)	TH6	Subcooled liquid refrigerant temperature
DCCT1	Current sensor (DC)	TH7	OA temperature
DCL	DC reactor	THBOX	Control box internal temperature
LEV1	MIC bypass. Controls refrigerant flow through the HPC	THHS	Function setting connector
LEV2a,b	Pressure control (Refrigerant flow rate control)	Z24, Z25, Z26	Terminal block
SV1a	For opening/closing the bypass circuit under the OIS		
SV5b,c	Outdoor unit heat exchanger capacity control		
SV9	For opening/closing the bypass circuit		

(3) PUHY-P72, P96, P120YHMU-A

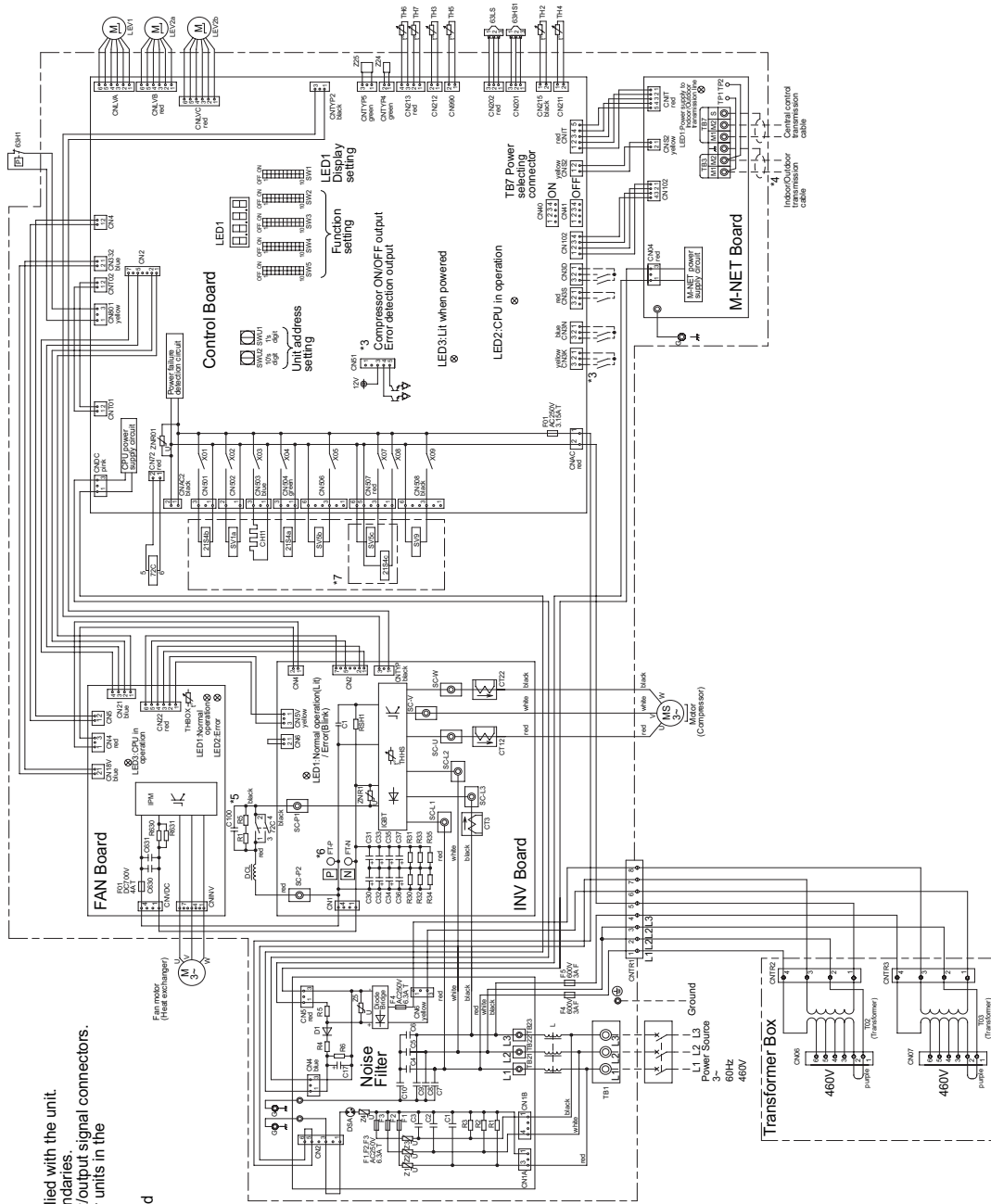

- *1 Single-dotted lines indicate wiring not supplied with the unit.
- *2 Dot-dash lines indicate the control box boundaries.
- *3 Refer to the Data book for connecting input/output signal connectors.
- *4 Daisy-chain terminals (TB3) on the outdoor units in the same refrigerant system together.
- *5 Faston terminals have a locking function. Make sure the terminals are securely locked in place after insertion. Press the tab on the terminals to removed them.
- *6 Control box houses high-voltage parts. Before inspecting the inside of the control box, turn off the power, keep the unit off for at least 10 minutes, and confirm that the voltage between FT-P and FT-N on INV Board has dropped to DC20V or less.
- *7. Difference of appliance

Model name	Appliance
P72/P96	*7 do not exist
P120	*7 exist

<Symbol explanation>

Symbol	Explanation
2-3dB	Control hearing switching
2-5A/0.1c	High pressure protection for the outdoor unit
68H1	Pressure switch
69HS1	Pressure sensor
69LS1	Low pressure sensor
72C	Magnetic relay (inverter main circuit)
CH1	Compressor heater (for heating the compressor)
DCR	DC reactor
LEV1	Linear expansion valve
LEV2a,b	Pressure control Refrigerant flow in H/C circuit
SV1a	Solenoid valve
SV5b,c	For opening/closing the bypass capacity control
SV9	For opening/closing the bypass circuit
TB1	Power supply
TB3	Indoor/Outdoor transmission cable
TB7	Central control transmission cable
TH2	Subcool bypass outlet temperature
TH3	Pipe temperature
TH4	Charge pipe temperature
TH5	A/C liquid refrigerant temperature
TH6	Subcooled liquid refrigerant temperature
TH7	O/A temperature
THBOX	Control box internal temperature
THHS	TIGBT temperature
ZZ4,Z5	Function setting connector

[2] Electrical Wiring Diagram of Transmission Booster

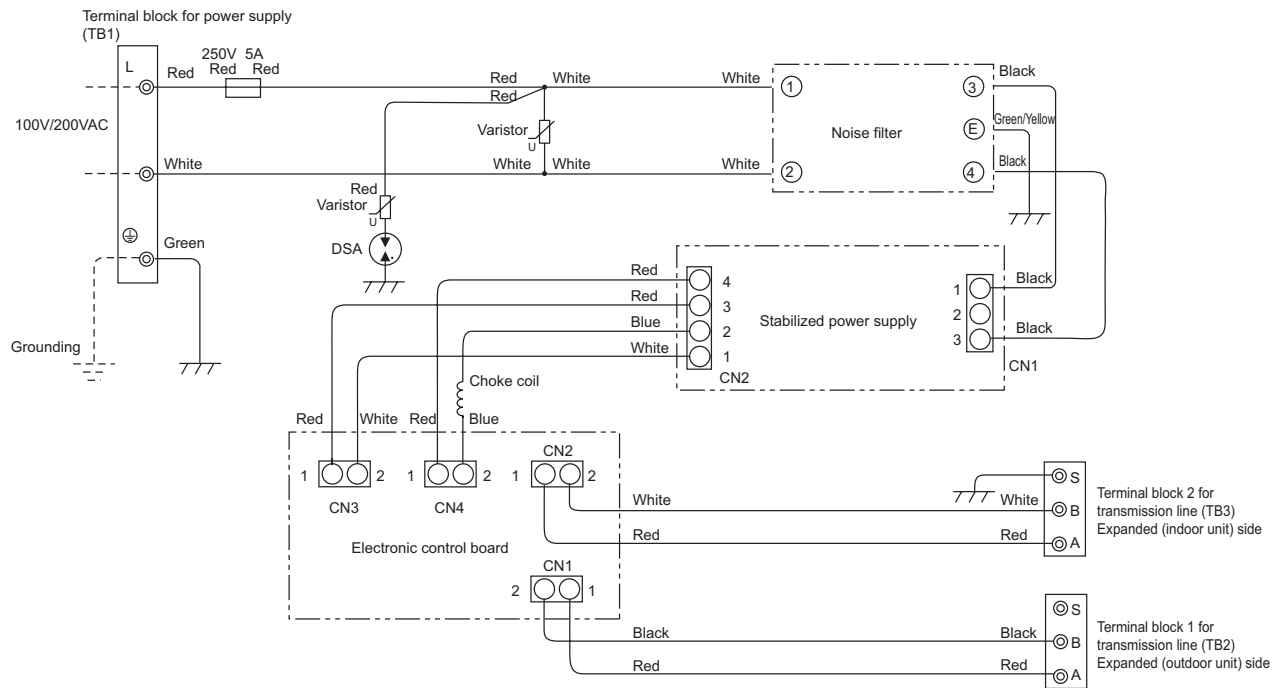

VI Refrigerant Circuit

[1] Refrigerant Circuit Diagram	81
[2] Principal Parts and Functions	82



[1] Refrigerant Circuit Diagram

1. Outdoor unit

(1) PUHY-P72, P96 models

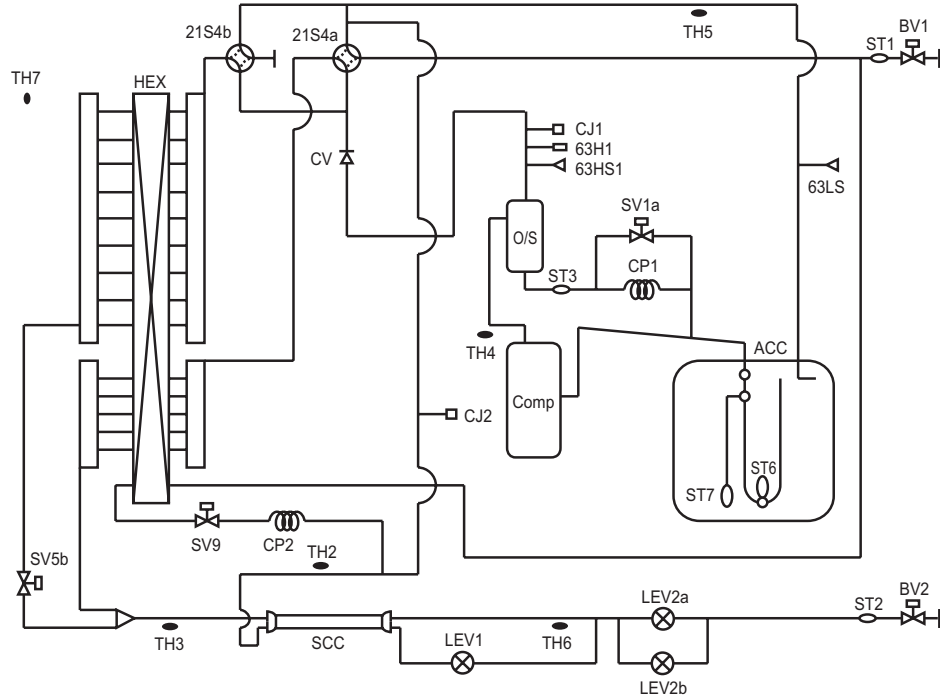

(2) PUHY-P120 models

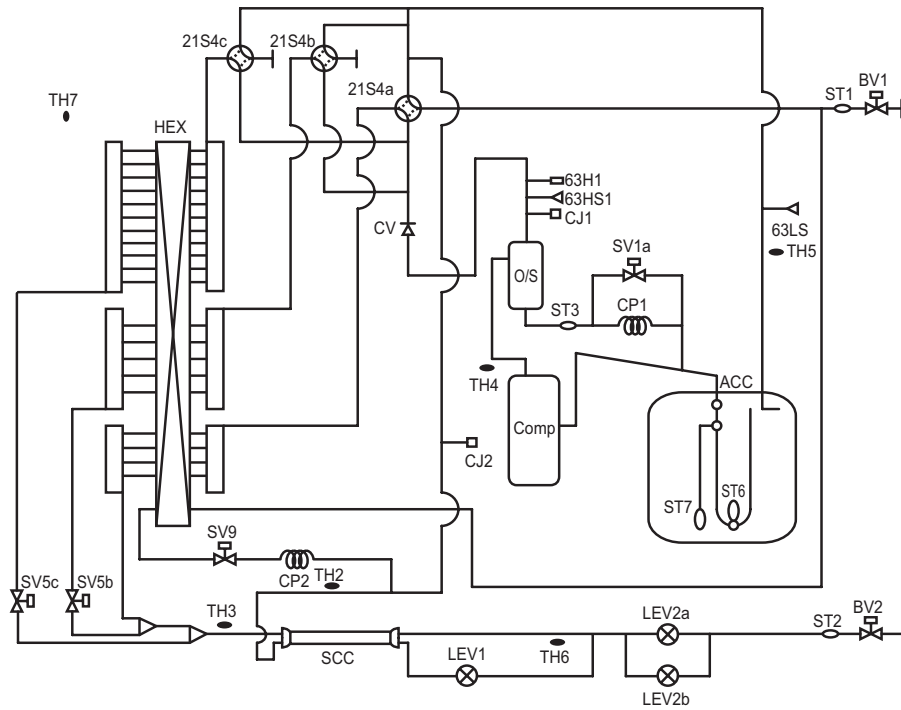

[2] Principal Parts and Functions

1. Outdoor unit

Part name	Symbols (functions)	Notes	Usage	Specifications	Check method
Compressor	MC1 (Comp1)		Adjusts the amount of circulating refrigerant by adjusting the operating frequency based on the operating pressure data	P72 and 96 models Low-pressure shell scroll compressor Wirewound resistance 20°C[68°F] : 0.268ohm(THMU) 0.981ohm(YHMU) P120 model Low-pressure shell scroll compressor Wirewound resistance 20°C[68°F] : 0.161ohm(THMU) 0.583ohm(YHMU)	
High pressure sensor	63HS1		1) Detects high pressure 2) Regulates frequency and provides high-pressure protection	<p>63HS1</p> <p>Pressure 0~4.15 MPa [601psi] Vout 0.5~3.5V 0.071V/0.098 MPa [14psi] Pressure [MPa] = 1.38 x Vout [V] - 0.69 Pressure [psi] = (1.38 x Vout [V] - 0.69) x 145</p> <p>1 GND (Black) 2 Vout (White) 3 Vcc (DC5V) (Red)</p>	
Low pressure sensor	63LS		1) Detects low pressure 2) Provides low-pressure protection	<p>63LS</p> <p>Pressure 0~1.7 MPa [247psi] Vout 0.5~3.5V 0.173V/0.098 MPa [14psi] Pressure [MPa] = 0.566 x Vout [V] - 0.283 Pressure [psi] = (0.566 x Vout [V] - 0.283) x 145</p> <p>1 GND (Black) 2 Vout (White) 3 Vcc (DC5V) (Red)</p>	
Pressure switch	63H1		1) Detects high pressure 2) Provides high-pressure protection	4.15MPa[601psi] OFF setting	

Part name	Symbols (functions)	Notes	Usage	Specifications	Check method	
Thermistor	TH4 (Discharge)		1) Detects discharge air temperature 2) Provides high-pressure protection	Degrees Celsius $R_{120} = 7.465k\Omega$ $R_{25/120} = 4057$ $R_t = 7.465 \exp\{4057(\frac{1}{273+t} - \frac{1}{393})\}$	Resistance check	
	TH2		LEV 1 is controlled based on the TH2, TH3, and TH6 values.	Degrees Celsius $R_0 = 15k\Omega$ $R_{0/80} = 3460$ $R_t = 15 \exp\{3460(\frac{1}{273+t} - \frac{1}{273})\}$ 0°C[32°F] :15kohm 10°C[50°F] :9.7kohm 20°C[68°F] :6.4kohm 25°C[77°F] :5.3kohm 30°C[86°F] :4.3kohm 40°C[104°F] :3.1kohm	Resistance check	
	TH3 (Pipe temperature)		1) Controls frequency 2) Controls defrosting during heating operation 3) Detects subcool at the heat exchanger outlet and controls LEV1 based on HPS data and TH3 data			
	TH7 (Outdoor temperature)		1) Detects outdoor air temperature 2) Controls fan operation			
	TH5		LEV2a and LEV2b are controlled based on the 63LS and TH5 values.			
	TH6		Controls LEV1 based on TH2, TH3, and TH6 data.			
	THHS Inverter heat sink temperature		Controls inverter cooling fan based on THHS temperature			Degrees Celsius $R_{50} = 17k\Omega$ $R_{25/120} = 4016$ $R_t = 17 \exp\{4016(\frac{1}{273+t} - \frac{1}{323})\}$
	THBOX Control box internal temperature detection					
Solenoid valve	SV1a Discharge-suction bypass		1) High/low pressure bypass at start-up and stopping, and capacity control during low-load operation 2) High-pressure-rise prevention	AC208-230V Open while being powered/ closed while not being powered	Continuity check with a tester	
	SV5b Heat exchanger capacity control		Controls outdoor unit heat exchanger capacity			
	SV5c	P120 model only				
	SV9		High-pressure-rise prevention			Open while being powered/ closed while not being powered

[VI Refrigerant Circuit]

Part name	Symbols (functions)	Notes	Usage	Specifications	Check method
Linear expansion valve	LEV1 (SC control)		Adjusts the amount of bypass flow from the liquid pipe on the outdoor unit during cooling	DC12V Opening of a valve driven by a stepping motor 0-480 pulses (direct driven type)	Same as indoor LEV The resistance value differs from that of the indoor LEV. (Refer to the section "LEV Troubleshooting."(page 238))
	LEV2a LEV2b (Refrigerant flow adjustment)		Adjusts refrigerant flow during heating	DC12V Opening of a valve driven by a stepping motor 1400 pulses	Same as indoor LEV
Heater	CH11		Heats the refrigerant in the compressor	Cord heater AC230V P72 and P96 models 1037 ohm 51W P120 model 928 ohm 57W	Resistance check
4-way valve	21S4a		Changeover between heating and cooling	AC208-230V Dead: cooling cycle Live: heating cycle	Continuity check with a tester
	21S4b		1) Changeover between heating and cooling 2) Controls outdoor unit heat exchanger capacity	AC208-230V Dead: cooling cycle Outdoor unit heat exchanger capacity at 100% Live: heating cycle Outdoor unit heat exchanger capacity at 50% or heating cycle	
	21S4c	P120 model only			

2. Indoor Unit

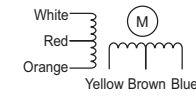
Part Name	Symbol (functions)	Notes	Usage	Specification	Check method
Linear expansion valve	LEV		1) Adjusts superheat at the indoor heat exchanger outlet during cooling 2) Adjusts subcool at the heat exchanger outlet of the indoor unit during cooling	DC12V Opening of stepping motor driving valve 0-(1400) pulses	Refer to the section "Continuity Test with a Tester". Continuity between white, red, and orange. Continuity between yellow, brown, and blue. 
Thermistor	TH1 (Suction air temperature)		Indoor unit control (Thermo)	$R_0=15k\Omega$ $R_{0/80}=3460$ $R_t = 15 \exp\{3460(\frac{1}{273+t} - \frac{1}{273})\}$ 0°C [32°F]:15kohm 10°C [50°F]:9.7kohm 20°C [68°F]:6.4kohm 25°C [77°F]:5.3kohm 30°C [86°F]:4.3kohm 40°C [104°F]:3.1kohm	Resistance check
	TH2 (Pipe temperature)		1) Indoor unit control (Frost prevention, Hot adjust) 2) LEV control during heating operation (subcool detection).		
	TH3 (Gas pipe temperature)		LEV control during cooling operation (superheat detection)		
	TH4 Outdoor air temperature)		Indoor unit control (Thermo)		
	Temperature sensor (Indoor air temperature)		Indoor unit control (Thermo)		

VII Control

[1] Functions and Factory Settings of the Dipswitches	89
[2] Controlling the Outdoor Unit	96
[3] Operation Flow Chart.....	108



[1] Functions and Factory Settings of the Dipswitches

**1. Outdoor unit
(1) Control board**

Switch	Function	Function according to switch setting		Switch setting timing		Units that require switch setting Note.2		
		OFF	ON	OFF	ON	OC	OS	
SWU	1-2	Unit address setting	Set to 00 or 51-100 with the dial switch		Before power on		C	C
SW1	1-10	For self-diagnosis/operation monitoring	Refer to the LED monitor display on the outdoor unit board.		Anytime after power on		C	C
SW2	1	Centralized control switch	Without connection to the centralized controller	With connection to the centralized controller	Before power on		B	B
	2	Deletion of connection information	Normal control	Deletion	Before power on		A	-
	3	Deletion of error history SW	(OC) Storage of IC/OC error history	(OC) Deletion of IC/OC error history	Anytime after power on (When switched from OFF to ON)		C	C
			(OS) Storage of OS error history	(OS) Deletion of OS error history				
	4	Pump down mode	Normal control	Pump down mode	After being energized and while the compressor is stopped		A	-
	5	-	-	-	-		-	-
	6	-	-	-	-		-	-
	7	Forced defrost Note 3	Normal control	Forced defrost starts	10 minutes after compressor startup	Anytime after power on (When switched from OFF to ON)	A	A
	8	Defrost timer setting Note 3	50 minutes	90 minutes	Anytime after power on (When switched from OFF to ON)		B	B
	9	Target evaporating temperature setting	Depends on the setting combination with the SW3-5 setting (Note 4)		Anytime after power on		A	-
10	-	-	-	-		-	-	

Note

- 1) Unless otherwise specified, leave the switch to OFF where indicated by "-", which may be set to OFF for a reason.
- 2) A: Only the switch on either the OC or OS needs to be set for the setting to be effective on both units.
B: The switches on both the OC and OS need to be set to the same setting for the setting to be effective.
C: The setting is effective for the unit on which the setting is made.
- 3) Refer to "VII [2] Controlling the Outdoor Unit" for details.(page 96)
- 4) The table below shows the combination of SW2-9 and SW3-5 settings and the target evaporating temperature setting that corresponds to each combination.

Switch		SW2-9	
		OFF	ON
SW3-5	OFF	0°C [32°F]	-4°C [25°F]
	ON	-2°C [28°F]	-6°C [21°F]

Switch	Function	Function according to switch setting		Switch setting timing		Units that require switch setting Note.2		
		OFF	ON	OFF	ON	OC	OS	
SW3	1	Test run mode: enabled/disabled	SW3-2 disabled	SW3-2 enabled	Anytime after power on		A	-
	2	Test run mode: ON/OFF	Stops all ICs	Sends a test-run signal to all IC	After power on and when SW3-1 is on.		A	-
	3	Defrost start temperature Note 5	-10°C [14°F]	-5°C [23°F]	Anytime after power on		B	B
	4	Defrost end temperature Note 5	P72, P96 10°C [50°F]	5°C [41°F]	Anytime after power on (except during defrost)		B	B
			P120 7°C [45°F]					
	5	Target evaporating temperature setting	Depends on the setting combination with the SW2-9 setting (Note 4)		Anytime after power on		A	-
	6	Temperature unit setting	°C	°F	Anytime after power on		C	C
	7	Target condensing temperature setting for heating	49°C [120°F]	53°C [127°F]	-		A	-
	8	-	-	-	-		-	-
	9	Model setting (To change the external static pressure setting)	Outdoor standard static pressure	Outdoor high static pressure	Before being energized		C	C
10	Model setting (To change the external static pressure setting)	High static pressure 60Pa	High static pressure 30Pa	Before being energized		C	C	
SW4	1	Enable/disable high sensible temperature operation	Normal operation mode	High sensible temperature operation mode	Before being energized		A	-
	2	-	-	-	-		-	-
	3	Refrigerant amount adjustment	Normal operation mode	Refrigerant amount adjust mode	Anytime after being energized (except during initial startup mode. Automatically cancelled 60 minutes after compressor startup)		A	-
	4	Low-noise mode/step demand switching	Low-noise mode Note 3	Step demand mode	Before being energized		C	C
	5	Automatic cooling/heating switchover (IC with the minimum address)	Normal operation mode	Automatic cooling/heating switchover	Before being energized		A	-
	6	Cumulative compressor operation time data deletion	Cumulative compressor operation time data is retained.	Cumulative compressor operation time data is deleted.	Anytime after power on (when the unit is turned on)		C	C
	7	-	-	-	-		-	-
	8	-	-	-	-		-	-
	9	-	-	-	-		-	-
	10	-	-	-	-		-	-

Note

- 1) Unless otherwise specified, leave the switch to OFF where indicated by "-", which may be set to OFF for a reason.
- 2) A: Only the switch on either the OC or OS needs to be set for the setting to be effective on both units.
B: The switches on both the OC and OS need to be set to the same setting for the setting to be effective.
C: The setting is effective for the unit on which the setting is made.
- 3) The noise level is reduced by controlling the compressor frequency and outdoor fan rotation speed. Setting of CN3D is required.
- 4) The table below shows the combination of SW2-9 and SW3-5 settings and the target evaporating temperature setting that corresponds to each combination.

Switch		SW2-9	
		OFF	ON
SW3-5	OFF	0°C [32°F]	-4°C [25°F]
	ON	-2°C [28°F]	-6°C [21°F]

- 5) Refer to VII [2] Controlling the Outdoor Unit -7- Defrost Operation Control for details.(page 99)

Switch	Function	Function according to switch setting		Switch setting timing		Units that require switch setting Note.2		
		OFF	ON	OFF	ON	OC	OS	
SW5	1	-	-	-	-	-	-	
	2	-	-	-	-	-	-	
	3	-	-	-	-	-	-	
	4	-	-	-	-	-	-	
	5	Low-noise mode selection	Capacity priority mode Note 3	Low-noise mode	Before being energized		A	-
	6	-	-	-	-	-	-	
	7	-	-	-	-	-	-	
	8	-	-	-	-	-	-	
	9	-	-	-	-	-	-	
	10	Backup heating	Ineffective	Effective	Any time after power on		A	-

Note

- 1) Unless otherwise specified, leave the switch to OFF where indicated by "-", which may be set to OFF for a reason.
- 2) A: Only the switch on either the OC or OS needs to be set for the setting to be effective on both units.
 B: The switches on both the OC and OS need to be set to the same setting for the setting to be effective.
 C: The setting is effective for the unit on which the setting is made.
- 3) When set to the capacity priority mode and if the following conditions are met, the Low-noise mode will terminate, and the unit will go back into the normal operation mode.
 Cooling: Outside temperature is high or high pressure is high.
 Heating: Outside temperature is low or low pressure is low.

(2) INV board

- 1) PUHY-P72, P96, P120YHMU-A, PUHY-P72, P96THMU-A
 Functions are switched with the following connector.

Connector	Function	Function according to connector		Setting timing	
		Enabled	Disabled	Enabled	Disabled
CN6 short-circuit connector	Enabling/disabling the following error detection functions; ACCT sensor failure (5301 Detail No. 115) ACCT sensor circuit failure (5301 Detail No.117) IPM open/ACCT erroneous wiring (5301 Detail No. 119) Detection of ACCT erroneous wiring (5301 Detail No.120)	Error detection enabled	Error detection disable (No load operation is possible.)	Anytime after power on	

Note

- CN6 short-circuit connector is mated with the mating connector.
- Leave the short-circuit connector on the mating connector during normal operation to enable error detection and protect the equipment from damage.

2) PUHY-P120THMU-A

Switch		Function	Function according to switch setting		Switch setting timing	
			OFF	ON	OFF	ON
SW1	1	Enabling/disabling the following error detection functions; ACCT/DCCT sensor failure (5301 Detail No. 115, 116) ACCT/DCCT sensor circuit failure (5301 Detail No.117,118) IPM open/Disconnected CNCT2 (5301 Detail No. 119) Detection of erroneous wiring (5301 Detail No.120)	Error detection enabled	Error detection disable (No load operation is possible.)	Anytime after power on	
	2	-	-	-	-	
	3	-	-	-	-	
	4	-	-	-	-	
	5	-	-	-	-	
	6	-	-	-	-	

Note

- ♦All are set to OFF at factory shipment. Unless otherwise specified, set the switch to OFF where indicated by "-", which may be set to a certain setting for a reason.
- ♦Leave SW1-1 to OFF during normal operation. If it is set to ON, errors cannot be detected and the unit may be damaged.

2. Function of the switch (Indoor unit)

(1) Dipswitches

1) SW1,3

Switch	Function	Function according to switch setting		Switch setting timing		Notes
		OFF	ON	OFF	ON	
SW1	1	Room temperature detection position	Indoor unit inlet	Built-in sensor on the remote controller	While the unit is stopped (Remote controller OFF)	Set to ON (built-in sensor on the remote controller) on All Fresh (PEFY-VMH-F) model units
	2	Clogged filter detection	Not available	Available		
	3	Filter check reminder time setting	100h	2500h		
	4	Outside air intake	Disabled	Enabled		Always set to OFF on PKFY-AM model units
	5	Remote display option	Fan output	Thermo-ON signal		
	6	Humidifier control	During heating operation	Always on while in the heating mode		
	7	Fan speed setting for Heating Thermo-OFF	Very Low	Low		
		Forced heating operation at OA temp of 5°C or below	Not available	Available		Applicable to All Fresh model units (PEFY-VMH-F) only
	8	Fan speed setting for Heating Thermo-OFF	According to the SW1-7 setting	Preset speed		
		-	-	-		Applicable to All Fresh model units (PEFY-VMH-F) only
9	Self-recovery after power failure	Disabled	Enabled			
10	Power source start-stop	Disabled	Enabled			
SW3	1	Unit model selection	Heat pump	Cooling only		
	2	Louver	Not available	Available		
	3	Vane	Not available	Available		
	4	Vane swing function	Not available	Available		Always set to OFF on PKFY-VAM model units
	5	-	-	-		
	6	Vane angle limit setting for cooling operation	Downblow B,C	Horizontal		Always set to Downblow B or C on PKFY-VAM model units
		Initial vane position	Enabled	Disabled		PLFY-VLMD model only
	7	Automatic LEV value conversion function	Not available	Available		
	8	Heating 4°C [7.2°F] up	Enabled	Disabled		Set to OFF on floor-standing (PFFY) type units
	9	SHm setting	2°C [3.6°F]	5°C [9°F]		The setting depends on the model and type.
10	SCm setting	10°C [18°F]	15°C [27°F]	The setting depends on the model and type.		

Note 1. Settings in the shaded areas are factory settings. (Refer to the table below for the factory setting of the switches whose factory settings are not indicated by the shaded cells.)

Note 2. If both SW1-7 and SW1-8 are set to ON, the fan remains stopped during heating Thermo-OFF.

To prevent incorrect temperature detection due to a build-up of warm air around the indoor unit, use the built-in temperature sensor on the remote controller (SW1-1) instead of the one on the indoor unit inlet thermistor.

Note 3. By setting SW3-1, SW1-7, and SW1-8 to a certain configuration, the fan can be set to remain stopped during cooling Thermo-OFF. See the table below for details.

Switch setting	Fan speed during Thermo-OFF		Cooling-only/heat pump		
	Heating	Cooling			
OFF	SW3-1	SW1-7	SW1-8	Preset speed	Heat pump
	OFF	OFF	OFF		
	ON	ON	ON		
	ON	ON	ON		
ON	SW3-1	SW1-7	SW1-8	Preset speed	Cooling-only
	OFF	OFF	OFF		
	ON	ON	ON		
	ON	ON	ON		

(2) Address switch

Actual indoor unit address setting varies in different systems. Refer to the installation manual for the outdoor unit for details on how to make the address setting.

Each address is set with a combination of the settings for the 10's digit and 1's digit.

(Example)

When setting the address to "3", set the 1's digit to 3, and the 10's digit to 0.

When setting the address to "25", set the 1's digit to 5, and the 10's digit to 2.

3. Function of the switch <Remote controller>

(1) MA remote controller (PAR-20MAA)

The SW is located at the bottom of the remote controller under the cover. Operate the switches to perform the remote controller main/sub setting or other function settings. Normally, do not change the settings of switches other than the SW1 (main/sub switching switch). (All the switches are set to "ON" at factory setting.)

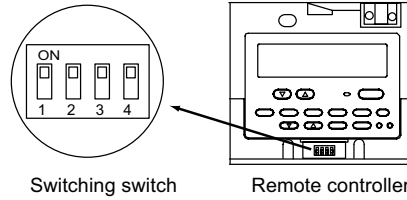

Switch	Function	ON	OFF	Operation by switch settings	Switch setting timing
1	Remote controller main/sub setting	Main	Sub	When two remote controllers are connected to one group, set either of the remote controllers to "Sub".	Before power on
2	At power on of the remote controller	Normal startup	Timer mode startup	When the program timer (only few stock products are available) is connected, set to "Timer mode startup" to resume the operation with timer mode after power is restored.	Before power on
3	Cooling/heating display set by automatic setting	Displayed	Not displayed	When the automatic mode is set and the "Cooling"/"Heating" display is not necessary, set to "Not displayed".	Before power on
4	Suction temperature display (discharge temperature display)	Displayed	Not displayed	When the suction temperature (discharge temperature) display is not necessary, set to "Not displayed".	Before power on

Note

The MA remote controller (PAR-21MAA) does not have the switches listed above. Refer to the installation manual for the function setting.

(2) ME remote controller (PAR-F27MEA)

Set the address of the remote controller with the rotary switch.

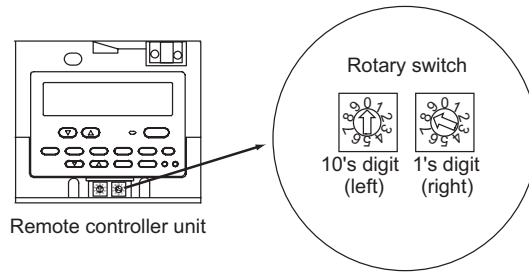

Example: In case of address 108

	Address setting range	Setting method
Main remote controller	101-150	Add 100 to the smallest address of all the indoor units in the same group.
Sub remote controller	151-200	Add 150 to the smallest address of all the indoor units in the same group.
Setting of rotary switch	Address No.	
01-99*1	101-199 with the 100's digit automatically being set to 1*2	
00	200	

*1. At factory shipment, the rotary switch is set to 01.

*2. The address range that can be set with the ME remote controller is between 101 and 200. When the dials are set to a number between 01 and 99, the 100's digit is automatically set to [1]. When the dials are set to 00, the 100's digit is automatically set to [2].

Note

To set addresses, use a precision slotted screw driver [2.0 mm [0.08 in] (w)], and do not apply than 19.6N. The use of any other tool or applying too much load may damage the switch.

[2] Controlling the Outdoor Unit

-1- Outline of Control Method

- ♦The outdoor units are designated as OC, OS1 and OS2 in the order of capacity from large to small (if two or more units have the same capacity, in the order of address from small to large).
- ♦The setting of outdoor unit can be verified by using the self-diagnosis switch (SW1).

SW1		Display																														
ON	<table border="1"> <tr> <td>1</td><td>2</td><td>3</td><td>4</td><td>5</td><td>6</td><td>7</td><td>8</td><td>9</td><td>10</td> </tr> <tr> <td>■</td><td>■</td><td>■</td><td>■</td><td>■</td><td>■</td><td>■</td><td>■</td><td>■</td><td>■</td> </tr> <tr> <td>□</td><td>□</td><td>□</td><td>□</td><td>□</td><td>□</td><td>□</td><td>□</td><td>□</td><td>□</td> </tr> </table>	1	2	3	4	5	6	7	8	9	10	■	■	■	■	■	■	■	■	■	■	□	□	□	□	□	□	□	□	□	□	<ul style="list-style-type: none"> ■ The unit is designated as the OC: "oc" appears on the display. ■ The unit is designated as OS1: "oS-1" appears on the display ■ The unit is designated as OS2: "oS-2" appears on the display.
1	2	3	4	5	6	7	8	9	10																							
■	■	■	■	■	■	■	■	■	■																							
□	□	□	□	□	□	□	□	□	□																							

- ♦The OC determines the operation mode and the control mode, and it also communicates with the indoor units.
- ♦The OS exercises autonomous distributed control (over defrost, error detection, and actuator control etc.) according to the operation/control mode signals that are sent from the OC.

-2- Startup sequence rotation

- ♦At the initial startup, outdoor units start up in the order of "OC, OS1 and OS2." After two or more hours of operation, the startup sequence changes to "OS1, OS2 and OC" or "OS2, OC and OS1".
- ♦Startup sequence rotation is performed while all the indoor units are stopped. (Even after two hours of operation, startup sequence rotation is not performed while the compressor is in operation.)
- ♦Refer to [-12- Control at Initial Start-up] for the initial startup.
- ♦Performing startup sequence rotation does not change the basic operation of OC and OS. Only startup sequence is changed.
- ♦Startup sequence of the outdoor units can be checked with the self-diagnosis switch (SW1) on the OC.

SW1		Display																														
ON	<table border="1"> <tr> <td>1</td><td>2</td><td>3</td><td>4</td><td>5</td><td>6</td><td>7</td><td>8</td><td>9</td><td>10</td> </tr> <tr> <td>■</td><td>■</td><td>■</td><td>■</td><td>■</td><td>■</td><td>■</td><td>■</td><td>■</td><td>■</td> </tr> <tr> <td>□</td><td>□</td><td>□</td><td>□</td><td>□</td><td>□</td><td>□</td><td>□</td><td>□</td><td>□</td> </tr> </table>	1	2	3	4	5	6	7	8	9	10	■	■	■	■	■	■	■	■	■	■	□	□	□	□	□	□	□	□	□	□	<ul style="list-style-type: none"> ■ OC→OS1→OS2: "oc" and the OC address appear alternately on the display. ■ OS1→OS2→OC: "oS-1" and the OS1 address appear alternately on the display. ■ OS2→OC→OS1: "oS-2" and the OS2 address appear alternately on the display.
1	2	3	4	5	6	7	8	9	10																							
■	■	■	■	■	■	■	■	■	■																							
□	□	□	□	□	□	□	□	□	□																							

-3- Initial Control

- ♦When the power is turned on, the initial processing of the microcomputer is given top priority.
- ♦During the initial processing, control processing of the operation signal is suspended. (The control processing is resumed after the initial processing is completed. Initial processing involves data processing in the microcomputer and initial setting of each of the LEV opening. This process will take up to 5 minutes.)
- ♦During the initial processing, the LED monitor on the outdoor unit's control board displays S/W version -> refrigerant type -> heat pump -> cooling only and capacity -> and communication address in turn every second.

-4- Control at Start-up

- ♦The upper limit of frequency during the first 3 minutes of the operation is 50 Hz.
- ♦When the power is turned on, normal operation will start after the initial start-up mode (to be described later) has been completed (with a restriction on the frequency).

-5- Bypass Control

Bypass solenoid valves (SV1a), which bypass the high- and low- pressure sides, perform the following functions.

(1) Bypass solenoid valve (SV1a) (ON = Open), (SV9) (ON = Open)

Operation	SV1a	
	ON	OFF
When starting-up the compressor of each outdoor unit	ON for 4 minutes.	
After the restoration of thermo or 3 minutes after restart	ON for 4 minutes.	
During cooling or heating operation with the compressor stopped	Always ON. Exception: OFF when 63HS1-63LS is 0.2 MPa [29 psi] or less	
After the operation has stopped	ON for 3 minutes. Exception: OFF when 63HS1-63LS is 0.2 MPa [29 psi] or less	
During defrost operation	ON	
While the compressor is operating at the minimum frequency and when the low pressure (63LS) drops (3 or more minutes after compressor startup)	When low pressure (63LS) drops below 0.23 MPa [33 psi].	When low pressure (63LS) exceeds 0.38 MPa [55 psi].
When high pressure (63HS1) rises	When 63HS1 exceeds 3.62 MPa [525 psi]	When 63HS1 is or below 3.43 MPa [497 psi] and 30 seconds have passed

Operation	SV9	
	ON	OFF
When high pressure (63HS1) rises during the heating operation	When 63HS1 exceeds 3.50MPa [507psi]	When 63HS1 is or below 2.70Mpa [391psi]
When startup or resuming operation after a defrost cycle	ON for 5 minutes and goes OFF	
Others	Always OFF	

-6- Compressor Frequency Control

- Depending on the capacity required, the frequency of the compressor is controlled to keep constant evaporation temperature (0°C [32°F] = 0.71 MPa [103 psi]) during cooling operation, and condensing temperature (49°C [120°F] = 2.88 MPa [418 psi]) during heating operation.
- The table below summarizes the operating frequency ranges of the inverter compressor during normal operation.
- The OS in the multiple-outdoor-unit system operates at the actual compressor frequency value that is calculated by the OS based on the preliminary compressor frequency value that the OC determines.

Model	Frequency/cooling (Hz)		Frequency/heating (Hz)	
	Max	Min	Max	Min
72 model	52	10	53	10
96 model	65	10	71	10
120 model	74	15	81	15

Note

The maximum frequency during heating operation is affected by the outdoor air temperature to a certain extent.

(1) Pressure limit

The upper limit of high pressure (63HS1) is preset, and when it exceeds the upper limit, the frequency is decreased every 15 seconds.

- The actuation pressure is when the high-pressure reading on 63HS1 is 3.58MPa[519psi].

(2) Discharge temperature limit

Discharge temperature (TH4) of the compressor in operation is monitored, and when it exceeds the upper limit, the frequency is decreased every minute.

- Operating temperature is 115°C [239°F].

(3) Periodic frequency control

Frequency control other than the ones performed at start-up, upon status change, and for protection is called periodic frequency control (convergent control) and is performed in the following manner.

Periodic control cycle

Periodic control is performed after the following time has passed

- 30 seconds after either compressor start-up or the completion of defrost operation
- 30 seconds after frequency control based on discharge temperature or pressure limit

The amount of frequency change

The amount of frequency change is controlled to approximate the target value based on the evaporation temperature (Te) and condensing temperature (Tc).

-7- Defrost Operation Control

(1) Starting the defrost operation

- The defrost cycle starts when the pipe temperature (TH3), in the following table, or below has continuously been detected for 3 minutes after the integrated compressor operation time of 50 minutes have passed.
- If 10 minutes have passed since compressor start-up or since the completion of defrost operation, forced defrost operation will start by turning on the forced defrost switch (DIP SW2-7).
- Even if the defrost prohibit timer is set to 90 minutes, the actual defrost prohibit time for the next operation will be 50 minutes if defrosting took 12 minutes.
- In the multiple-outdoor-unit system, all of the outdoor units that are in operation go into the defrost mode simultaneously. The unit(s) that is stopped at the time defrost operation starts remains stopped.

Model	TH3	
	SW3 - 3 OFF	SW3 - 3 ON
72 model	- 10°C [14°F]	- 5°C [23°F]
96 model	- 10°C [14°F]	- 5°C [23°F]
120 model	- 10°C [14°F]	- 5°C [23°F]

(2) Defrost operation

Compressor frequency	Model	Compressor frequency
	72 model	65 Hz
	96 model	65 Hz
	120 model	103 Hz
Outdoor unit fan	Stopped	
SV1a	ON	
SV5b, SV5c	ON	
21S4a	OFF	
21S4b, 21S4c	OFF	
SV9	OFF	
LEV1	0 pulses*1	
LEV2a	1400 pulses	
LEV2b	1400 pulses	

*1. This value may be greater than 0 pulse depending on the 63LS and TH4 status.

(3) Stopping the defrost operation

- The defrost cycle ends when 12 minutes have passed since the beginning of the cycle, or when the pipe temperature (TH3) has been continuously detected for 4 minutes (when SW3-4 is set to OFF) or 2 minutes (when SW3-4 is set to ON) that exceeds the values in the table below.
- The defrost cycle will not end for two minutes once started unless one of the following conditions is met : Pipe temperature reaches 25°C [77°F] and SW3-4 is set to OFF OR $\alpha = 25 + TH7^{\circ}C [77^{\circ}F + TH7]$ and SW3-4 is set to ON.
*1 (5°C [41°F] ≤ α ≤ 25°C [77°F]).
- In the multiple-outdoor-unit system, defrosting is stopped on all units at the same time.

Model	TH3	
	SW3 - 4 OFF	SW3 - 4 ON
72 model	10°C [50°F]	5°C [41°F]
96 model	10°C [50°F]	5°C [41°F]
120 model	7°C [45°F]	5°C [41°F]

(4) Problems during defrost operation

- If a problem is detected during defrost operation, the operation will be stopped, and the defrost prohibition time based on the integrated compressor operation time will be set to 20 minutes.

(5) Change in the number of operating indoor units during defrost operation

- Even when there is a change in the number of operating indoor units during defrost operation, the operation will continue, and an adjustment will be made after the completion of the defrost operation.
- Defrost operation will be continued, even if the indoor units stop or under the Thermo-OFF conditions until it has run its course.

-8- Refrigerant Recovery Control

Recovery of refrigerant is performed during heating operation to prevent the refrigerant from accumulating inside the unit while it is stopped (unit in fan mode), or inside the indoor unit that is in cooling mode or in heating mode with thermo off. It is also performed during cooling operation to prevent an excessive amount of refrigerant from accumulating in the outdoor heat exchanger.

It is also performed during cooling operation to prevent an excessive amount of refrigerant from accumulating in the outdoor heat exchanger.

(1) During heating operation

Starting refrigerant recovery mode

The refrigerant recovery mode in heating starts when all of the following three conditions are met:

- 15 minutes have passed since the completion of previous refrigerant recovery.
- TH4 > 115°C [239°F]
- Frequencies below 50 Hz

Refrigerant recovery

- 1) Refrigerant is recovered with the LEV on the applicable indoor unit (unit under stopping mode, fan mode, cooling, heating with thermo off) being opened for 30 seconds.

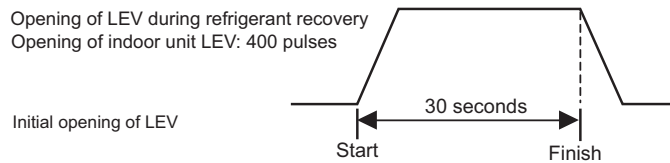

- 2) Periodic capacity control of the outdoor units and periodic LEV control of the indoor units will be suspended during refrigerant recovery operation; they will be performed after the recovery has been completed.

(2) During cooling operation

Starting refrigerant recovery mode

The refrigerant recovery mode starts when all the following conditions are met:

- 30 minutes have passed since the completion of previous refrigerant recovery.
- When the unit keeps running for 3 minutes in a row or more with high discharge temperature
- TH4 > 105°C [221°F] or 63HS1 > 3.43 MPa [497 psi] (35 kg/cm²G) and SC0 > 10°C [18°F]

Refrigerant recovery

The opening of LEV1 is increased and periodic control begins again.

-9- Capacity Control of Outdoor Fan

(1) Control method

- Depending on the capacity required, the rotation speed of the outdoor unit fan is controlled by the inverter, targeting a constant evaporation temperature of (0°C [32°F]= 0.71 MPa [103 psi]) during cooling operation and constant condensing temperature of (49°C [120°F]= 2.88 MPa [418 psi]) during heating operation.
- The OS in the multiple-outdoor-unit system operates at the actual outdoor unit fan control value that is calculated by the OS based on the preliminary outdoor unit fan control value that the OC determines.

(2) Control

- Outdoor unit fan stops while the compressor is stopped (except in the presence of input from snow sensor).
- The fan operates at full speed for 5 seconds after start-up.(Only when TH7<0°C [32°F])
- The outdoor unit fan stops during defrost operation.

-10- Subcool Coil Control (Linear Expansion Valve <LEV1>)

- The OC, OS1, and OS2 controls the subcool coil individually.
- The LEV is controlled every 30 seconds to maintain constant the subcool at the outdoor unit heat exchanger outlet that is calculated from the values of high pressure (63HS1) and liquid piping temperature (TH3), or the superheat that is calculated from the values of low pressure (63LS) and the bypass outlet temperature (TH2) of the subcool coil.
- LEV opening is controlled based on the values of the inlet (TH6) and the outlet (TH3) temperatures of the subcool coil, high pressure (63HS1), and discharge temperature (TH4). In a single-outdoor-unit system, the LEV is closed (0) in the heating mode, while the compressor is stopped, and during cooling Thermo-OFF. In a multiple-outdoor-unit system, the LEV closes (0) during heating operation, while the compressor is stopped, or during cooling Thermo-OFF. The LEV opens to a specified position when 15 minutes have passed after Thermo-OFF. (65 pulses)
- The valve remains open at the preset position. (480 pulses)

-11- Refrigerant flow control (Linear expansion valve <LEV2a, LEV2b>)

- Refrigerant flow is controlled by each unit in the combined models during heating. Refrigerant flow control is performed by the OC, OS1, and OS2 individually. The valve opens to a specified angle during cooling (Opening: 1400 pulses)
- Valve opening is controlled based on the values of high pressure (63HS1), discharge temperature (TH4), low pressure(63LS), and piping temperature (TH5).
- The valve moves to the predetermined position while the unit is stopped.
- The valve remains open at the preset position. (1400 pulses)

-12- Control at Initial Start-up

- When started up for the first time before 12 hours have elapsed after power on, the unit goes into the initial startup mode.
- At the completion of the initial operation mode on the OC, OS1, and OS2, they will go into the normal control mode.

1. Flowchart of initial operation

(1) P72, P96, P120 models

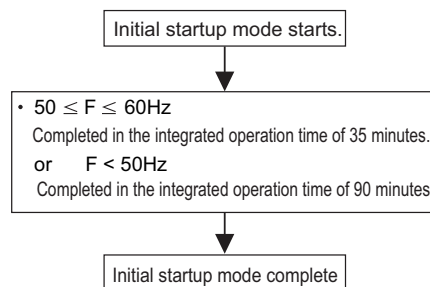

(2) P144, P168, P192, P216, P240 models

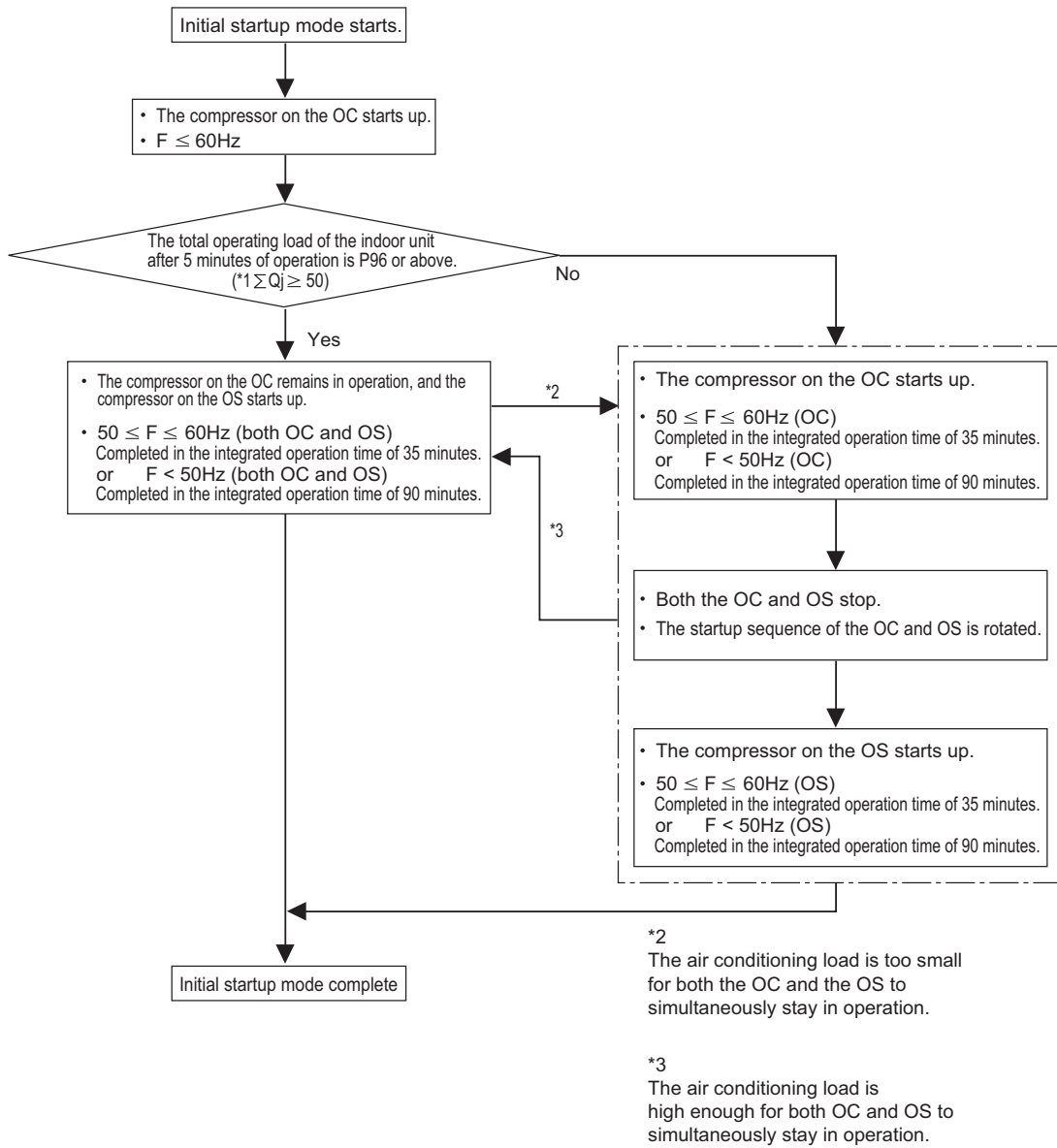

*1 $\sum Q_j$: Total capacity (models) code
Refer to the VII [1] 2. (1) Dipswitches for the capacity code. (page 93)

(3) P264, P288, P312, P336, P368 models

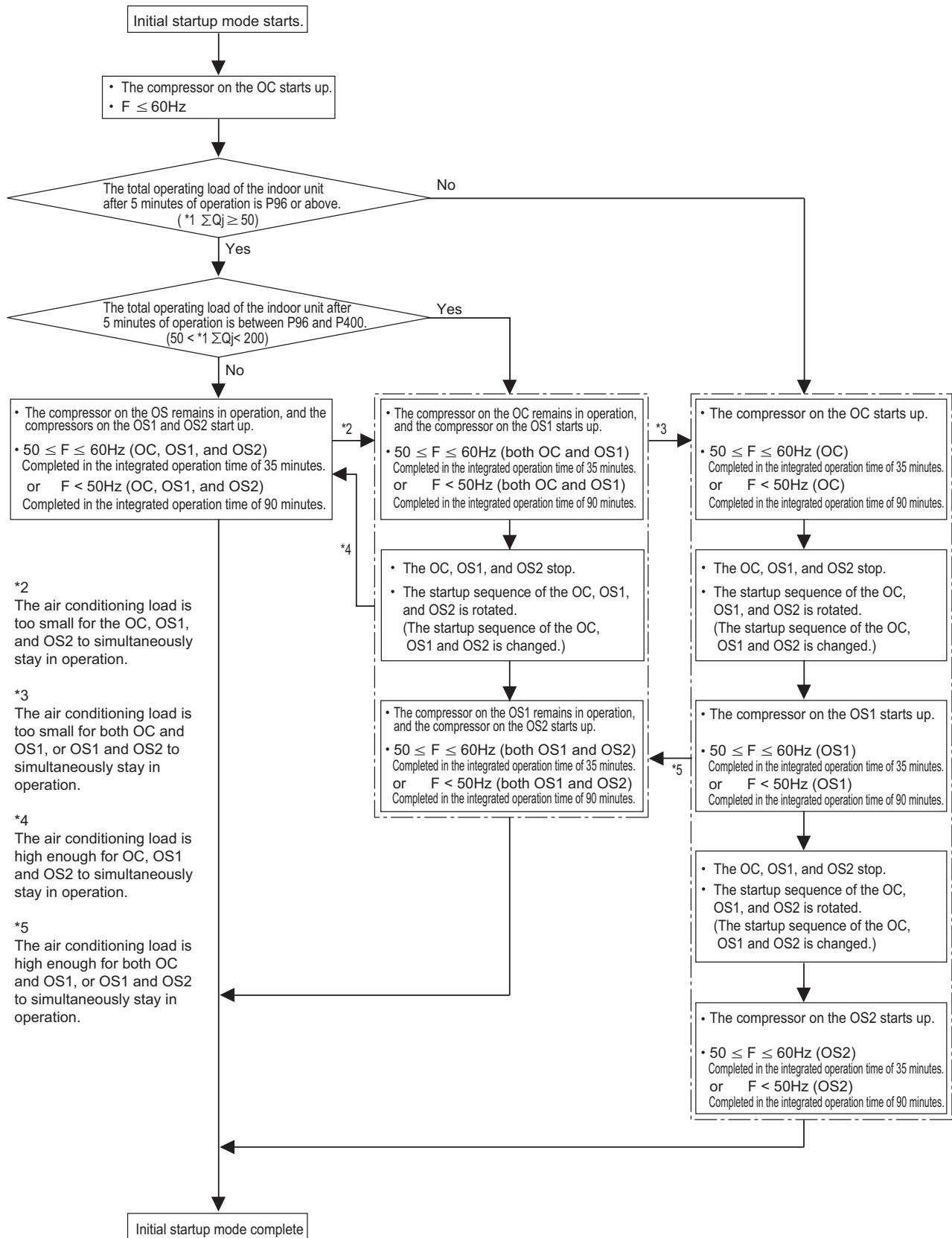

*2
The air conditioning load is too small for the OC, OS1, and OS2 to simultaneously stay in operation.

*3
The air conditioning load is too small for both OC and OS1, or OS1 and OS2 to simultaneously stay in operation.

*4
The air conditioning load is high enough for OC, OS1 and OS2 to simultaneously stay in operation.

*5
The air conditioning load is high enough for both OC and OS1, or OS1 and OS2 to simultaneously stay in operation.

*1 ΣQj: Total capacity (models) code
Refer to the VII [1] 2. (1) Dipswitches for the capacity code. (page 93)

-13- Emergency Operation Mode

1. Problems with the outdoor unit

- Emergency operation mode is a temporary operation mode in which the outdoor unit that is not in trouble operates when one of the outdoor units in the P144 through P240 models is in trouble or when one or two of the outdoor units in the P264 through P360 models are in trouble.
- This mode can be started by performing an error reset via the remote controller.

(1) Starting the emergency operation

- 1) When an error occurs, the error source and the error code will be displayed on the display on the remote controller.
- 2) The error is reset using the remote controller.
- 3) If an error code appears that permits an emergency operation in step 1) above, (See the table below.), the retry operation starts.
- 4) If the same error is detected during the retry operation (step 3 above), an emergency operation can be started by resetting the error via the remote controller.

Error codes that permit an emergency operation (Applicable to both OC and OS)

Trouble source		Error codes that permit an emergency operation	Error code description
Compressor Fan motor Inverter		0403	Serial communication error
		4220, 4225	Bus voltage drop
		4230	Heatsink overheat protection
		4240	Overload protection
		4250, 4255	Overcurrent relay trip
		5110	Heatsink temperature sensor failure (THHS)
	5301	Current sensor/circuit failure	
Thermistor	TH2	5102	Subcool heat exchanger bypass outlet temperature sensor failure
	TH3	5103	Pipe temperature sensor failure
	TH4	5104	Discharge temperature sensor failure
	TH5	5105	Accumulator inlet temperature sensor failure
	TH6	5106	Subcool heat exchanger liquid outlet sensor failure
	TH7	5107	Outside air temperature sensor failure
Power		4102	Open phase
		4115	Power supply sync signal abnormality

Emergency operation pattern (2 outdoor units)

		OC failure pattern	OS failure pattern
OC		Trouble	Normal
OS		Normal	Trouble
Emergency operation	Cooling	Permitted	Permitted
	Heating	Permitted	Permitted
Maximum total capacity of indoor units (Note 1)		60%	

Emergency operation pattern (3 outdoor units)

		OC failure pattern	OS1 failure pattern	OS2 failure pattern	OC, OS1 failure pattern	OC, OS2 failure pattern	OS1, OS2 failure pattern
OC		Trouble	Normal	Normal	Trouble	Trouble	Normal
OS1		Normal	Trouble	Normal	Trouble	Normal	Trouble
OS2		Normal	Normal	Trouble	Normal	Trouble	Trouble
Emergency operation	Cooling	Permitted	Permitted	Permitted	Permitted	Permitted	Permitted
	Heating	Permitted	Permitted	Permitted	Permitted	Permitted	Permitted
Maximum total capacity of indoor units (Note 1)		60%			40%		

(Note 1) If an attempt is made to put into operation a group of indoor units whose total capacity exceeds the maximum allowable capacity, some of the indoor units will go into the same condition as Thermo-OFF.

(2) Ending the emergency operation

1) End conditions

When one of the following conditions is met, emergency operation stops, and the unit makes an error stop.

- When the integrated operation time of compressor in cooling mode has reached four hours.
- When the integrated operation time of compressor in heating mode has reached two hours.
- When an error is detected that does not permit the unit to perform an emergency operation.

2) Control at or after the completion of emergency operation

- At or after the completion of emergency operation, the compressor stops, and the error code reappears on the remote controller.
- If another error reset is performed at the completion of an emergency mode, the unit repeats the procedures in section (1) above.
- To stop the emergency mode and perform a current-carrying operation after correcting the error, perform a power reset.

2. Communication circuit failure or when some of the outdoor units are turned off

This is a temporary operation mode in which the outdoor unit that is not in trouble operates when communication circuit failure occurs or when some of the outdoor units are turned off.

(1) Starting the emergency operation (When the OC is in trouble)

- 1) When an error occurs, the error source and the error code appear on the display on the remote controller.
- 2) Reset the error via the remote controller to start an emergency operation.

Precautions before servicing the unit

- When the OC is in trouble, the OS temporarily takes over the OC's function and performs an emergency operation. When this happens, the indoor unit connection information are changed.
- In a system that has a billing function, a message indicating that the billing system information has an error may appear on the TG-2000A. Even if this message appears, do not change (or set) the refrigerant system information on the TG-2000A. After the completion of an emergency operation, the correct connection information will be restored.

(2) Starting the emergency operation (When the OS is in trouble)

- 1) A communication error occurs. -> An emergency operation starts in approximately six minutes.

Error codes that permit an emergency operation (Applicable to both OC and OS)

Trouble source	Error codes that permit an emergency operation	Error code description
Circuit board failure or the power to the outdoor units is off	6607	No acknowledgement error
	6608	No response error

Emergency operation pattern (2 outdoor units)

		OC failure pattern	OS failure pattern
OC		Trouble	Normal
OS		Normal	Trouble
Emergency operation	Cooling	Permitted	Permitted
	Heating	Permitted	Permitted
Maximum total capacity of indoor units (Note 1)		Capacity that matches the total capacity of the operable outdoor units	

Emergency operation pattern (3 outdoor units)

		OC failure pattern	OS1 failure pattern	OS2 failure pattern	OC, OS1 failure pattern	OC, OS2 failure pattern	OS1, OS2 failure pattern
OC		Trouble	Normal	Normal	Trouble	Trouble	Normal
OS1		Normal	Trouble	Normal	Trouble	Normal	Trouble
OS2		Normal	Normal	Trouble	Normal	Trouble	Trouble
Emergency operation	Cooling	Permitted	Permitted	Permitted	Permitted	Permitted	Permitted
	Heating	Permitted	Permitted	Permitted	Permitted	Permitted	Permitted
Maximum total capacity of indoor units (Note 1)		Capacity that matches the total capacity of the operable outdoor units					

(Note 1) If an attempt is made to put into operation a group of indoor units whose total capacity exceeds the maximum allowable capacity, some of the indoor units will go into the same condition as Thermo-OFF.

(3) Ending the emergency operation

When communication is restored, the emergency mode is cancelled, and the units go into the normal operation mode.

-14- Operation Mode

(1) Indoor unit operation mode

The operation mode can be selected from the following 5 modes using the remote controller.

1	Cooling mode
2	Heating mode
3	Dry mode
4	Fan mode
5	Stopping mode

(2) Outdoor unit operation mode

1	Cooling mode	All indoor units in operation are in cooling mode.
2	Heating mode	All indoor units in operation are in heating mode.
3	Stopping mode	All indoor units are in fan mode or stopping mode.

Note

When the outdoor unit is performing a cooling operation, the operation mode of the connected indoor units that are not in the cooling mode (Stopped, Fan, Thermo-OFF) cannot be changed to heating from the remote controller. If this attempt is made, "Heating" will flash on the remote controller. The opposite is true when the outdoor unit is performing a heating operation. (The first selection has the priority.)

-15- DEMAND Control

Cooling/heating operation can be prohibited (Thermo-OFF) by an external input to the indoor units.

Note

When DIP SW4-4 is set to ON, the 4-step DEMAND control is enabled.

Eight-step demand control is possible in the system with two outdoor units.

Twelve-step demand control is possible in the system with three outdoor units.

Refer to Chapter II [3] 2. (7) "Various types of control using input-output signal connector on the outdoor unit (various connection options)" for details.(page 22)

[3] Operation Flow Chart

1. Mode determination flowchart

(1) Indoor unit (cooling, heating, dry, fan mode)

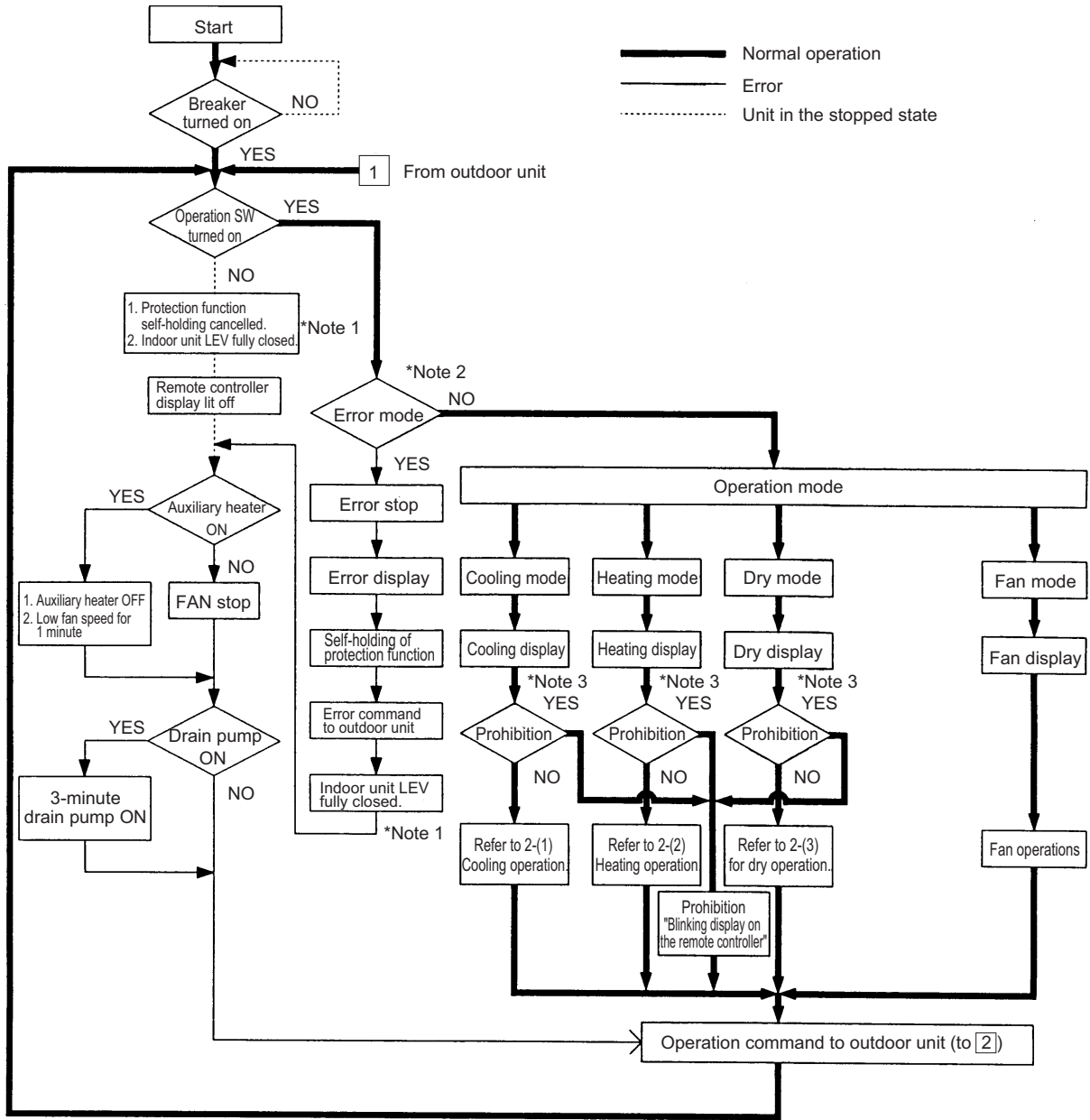

*Note 1. Indoor unit LEV fully closed : Opening 41.

*Note 2. The system may go into the error mode on either the indoor unit or the outdoor unit side. If some of the indoor units are experiencing a problem (except water leakage), only those indoor units that are experiencing the problems will stop.
If the outdoor unit is experiencing a problem, all connected indoor units will stop.

*Note 3. The operation will be prohibited when the set cooling/heating mode is different from that of the outdoor unit.

(2) Outdoor unit (cooling and heating modes)

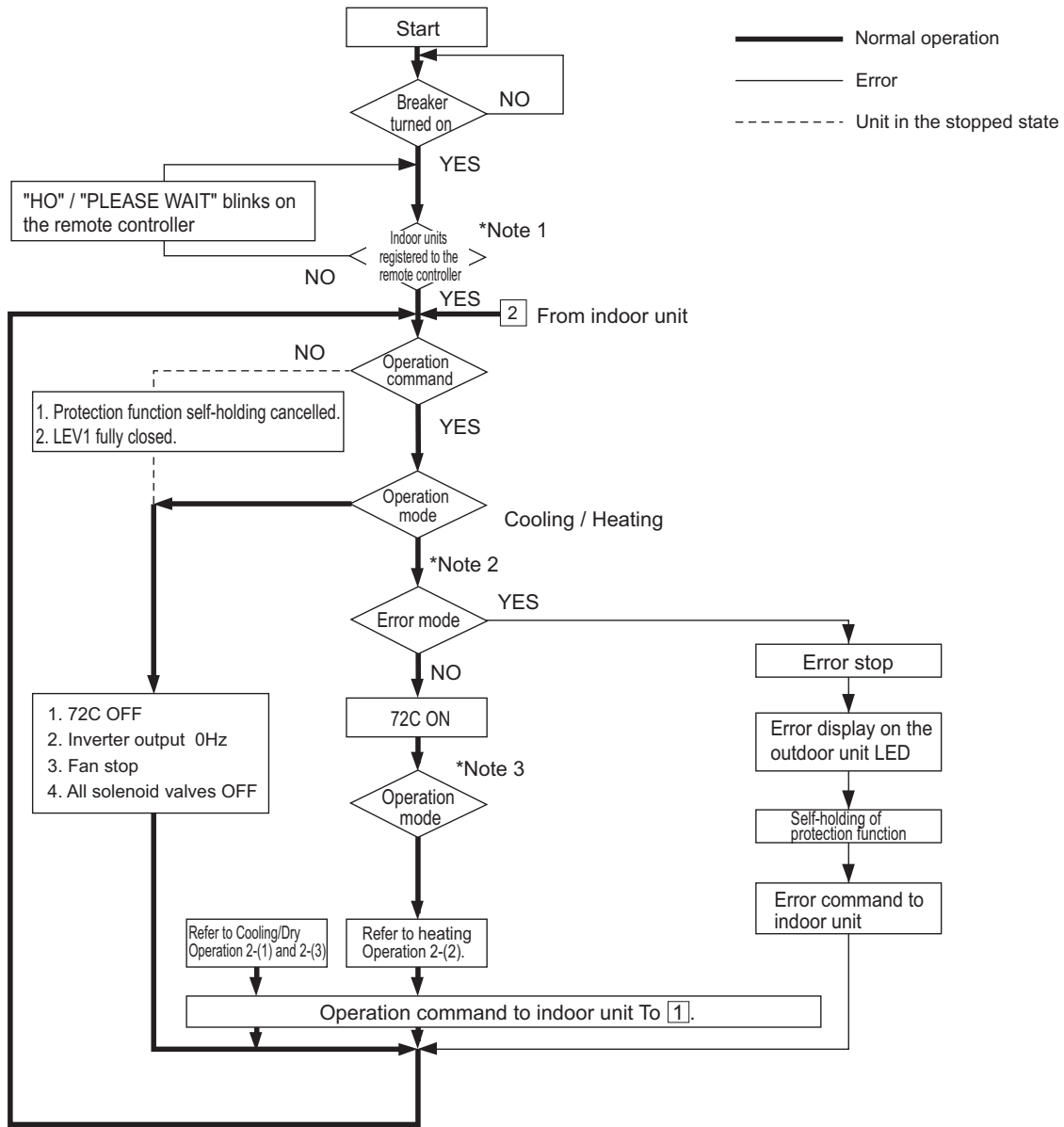

*Note 1. For about 3 minutes after power on, search for the indoor unit address, for the remote controller address, and for the group information will start. During this, "HO" / "PLEASE WAIT" blinks on the display of the remote controller. When the indoor unit to be controlled by the remote controller is missing, "HO" / "PLEASE WAIT" keeps blinking on the display of the remote controller even after 3 or more minutes after power on.

*Note 2. The system may go into the error mode on either the indoor unit or the outdoor unit side. The outdoor stops only when all of the connected indoor units are experiencing problems. The operation of even a single indoor unit will keep the outdoor unit running. The error will be indicated on the LED display.

*Note 3. The outdoor unit operates according to the operation mode commanded by the indoor unit. However, when the outdoor unit is running a cooling operation, come of the operating indoor units will stop, or the operation of these indoor units will be prohibited even when the indoor unit mode is switched from fan mode to heating mode. This also applies when the outdoor unit is running a heating operation.

2. Operations in each mode
(1) Cooling operation

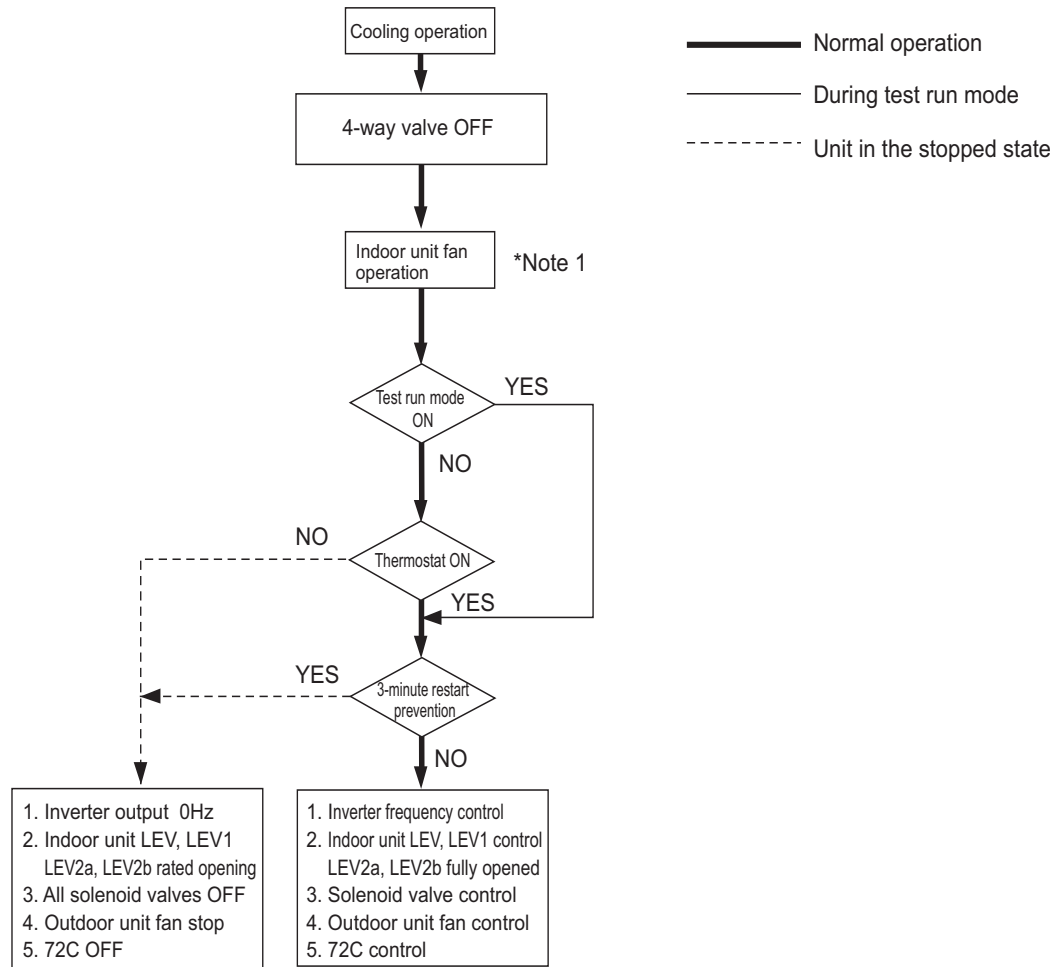

*Note 1. The indoor fan operates at the set notch under cooling mode regardless of the ON/OFF state of the thermostat.

(2) Heating operation

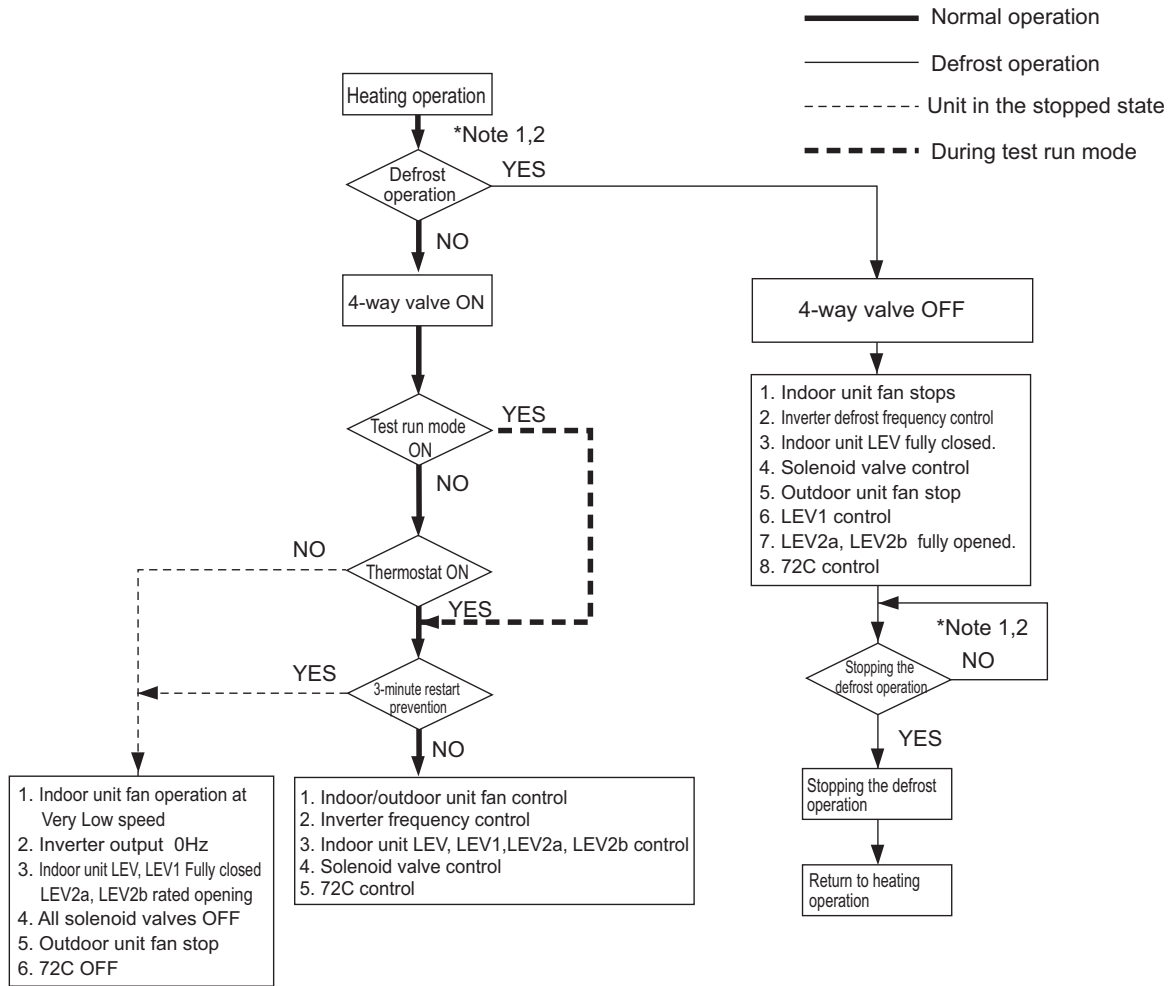

Note

- 1) When outdoor unit starts defrosting, it transmits defrost operations command to indoor unit, and the indoor unit start defrosting operations. Similarly when defrosting operation stops, indoor unit returns to heating operation after receiving defrost end command of outdoor unit.
- 2) Defrost end condition: 12 or more minutes must pass after defrost operation or outdoor unit piping temperature. Refer to "-7-. Defrost operation control" of [2] Controlling the Outdoor Unit for the temperature.

(3) Dry operation

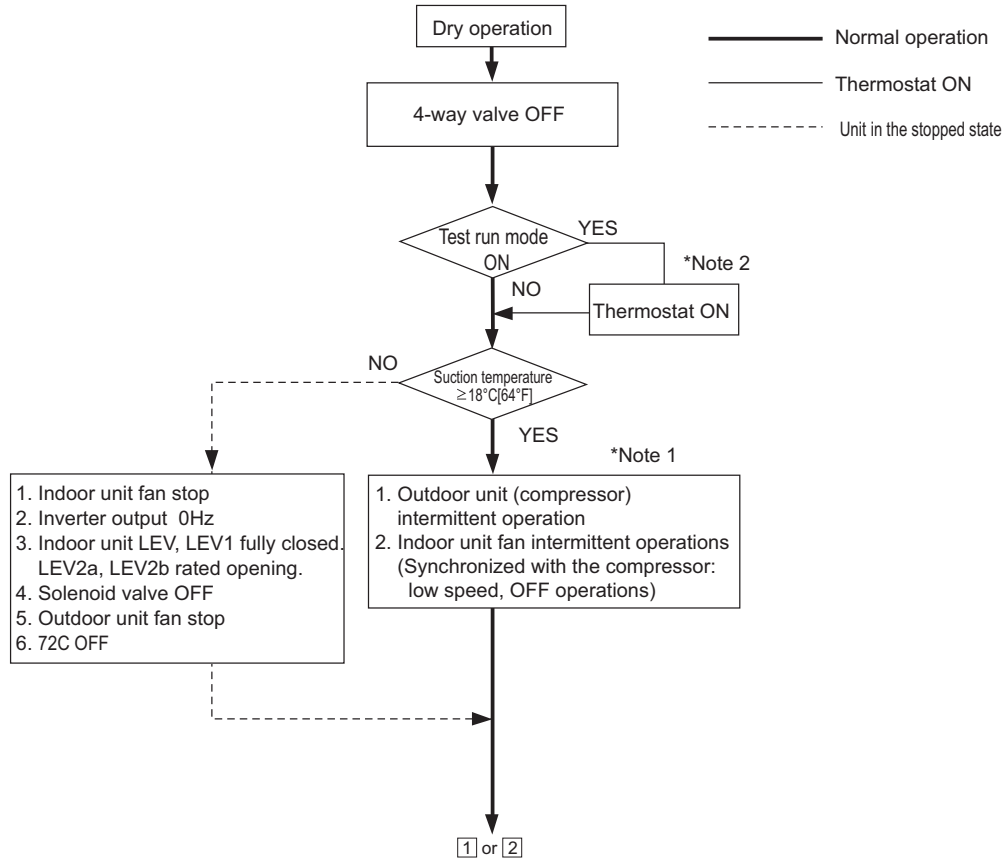

*Note 1. When the indoor unit inlet temperature exceeds 18°C [64°F], the outdoor unit (compressor) and the indoor unit fan start the intermittent operation simultaneously. When the indoor unit inlet temperature becomes 18°C [64°F], or less, the fan always runs (at low speed). The outdoor unit, the indoor unit, and the solenoid valve operate in the same way as they do in the cooling operation when the compressor is turned on.

*Note 2. Thermostat is always kept on during test run mode, and indoor and outdoor unit intermittent operation (ON) time is a little longer than that of normal operation.

VIII Test Run Mode

[1] Items to be checked before a Test Run.....	115
[2] Test Run Method	116
[3] Operating Characteristic and Refrigerant Amount.....	117
[4] Adjusting the Refrigerant Amount.....	117
[5] Refrigerant Amount Adjust Mode.....	120
[6] The following symptoms are normal.	122
[7] Standard Operation Data (Reference Data)	123



[1] Items to be checked before a Test Run

(1) Check for refrigerant leak and loose cables and connectors.

(2) Measure the insulation resistance between the power supply terminal block and the ground with a 500V megger and make sure it reads at least 1.0Mohm.

Note

- ♦Do not operate the unit if the insulation resistance is below 1.0Mohm.
- ♦Do not apply megger voltage to the terminal block for transmission line. Doing so will damage the controller board.
- ♦The insulation resistance between the power supply terminal block and the ground could go down to close to 1Mohm immediately after installation or when the power is kept off for an extended period of time because of the accumulation of refrigerant in the compressor.
- ♦If insulation resistance reads at least 1Mohm, by turning on the main power and powering the crankcase heater for at least 12 hours, the refrigerant in the compressor will evaporate and the insulation resistance will go up.
- ♦Do not measure the insulation resistance of the terminal block for transmission line for the unit remote controller.

(3) Check that the valve on the gas pipe and liquid pipe are fully open.

Note

Securely tighten the cap.

(4) Check the phase sequence and the voltage of the power supply.

(5) [When a transmission booster is connected]

Turn on the transmission booster before turning on the outdoor units.

Note

- ♦If the outdoor units are turned on first, the connection information for the refrigerant circuit may not be properly recognized.
- ♦In case the outdoor units are turned on before the transmission booster is turned on, perform a power reset on the outdoor units after turning on the power booster.

(6) Turn on the main power to the unit at least 12 hours before test run to power the crankcase heater.

Note

Insufficient powering time may result in compressor damage.

(7) When a power supply unit is connected to the transmission line for centralized control, perform a test run with the power supply unit being energized. Leave the power jumper connector on CN41 as it is (factory setting).

[2] Test Run Method

The figure shows an MA remote controller (PAR-21MAA).

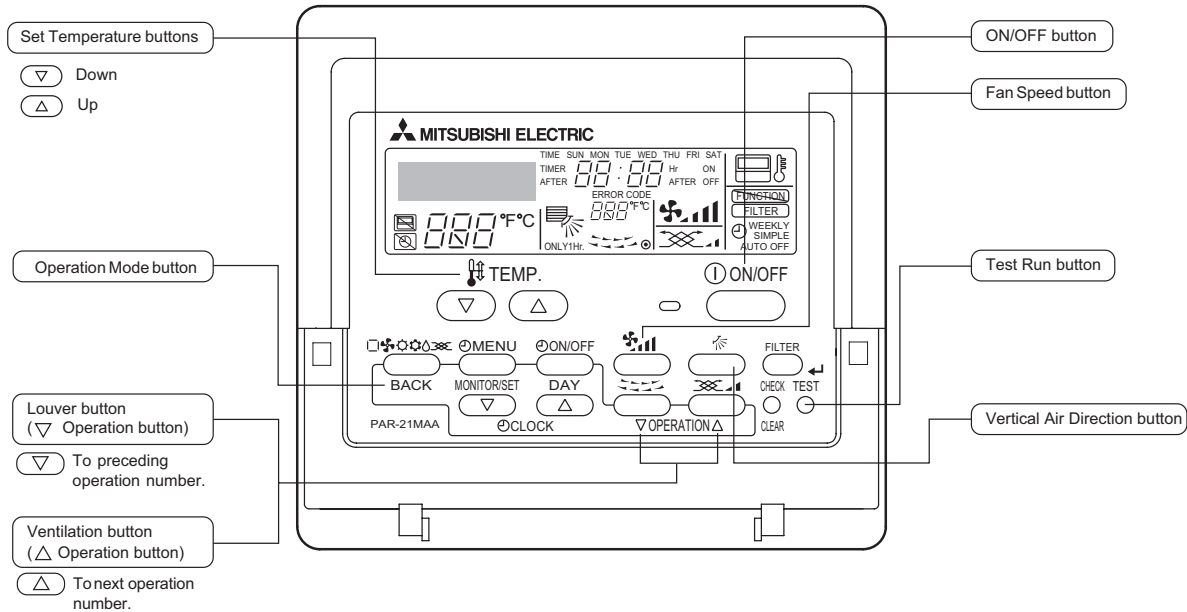

Operation procedures	
Turn on the main power.	→ "PLEASE WAIT" appears on the LCD for up to five minutes. Leave the power on for 12 hours. (Energize the crankcase heater.)
Press the Test button twice.	→ Operation mode display "TEST RUN" and OPERATION MODE are displayed alternately.
Press the Operation Mode button.	→ Make sure that the air is blowing out.
Switch to cooling (or heating) operation by pressing the Operation Mode button.	→ Make sure that cold (or warm) air blows out.
Press the Fan Speed button.	→ Make sure that the fan speed changes with each pressing of the button.
Change the air flow direction by pressing the Vertical Air Direction button or the Louver button.	→ Make sure that the air flow direction changes with each pressing of the button.
	→ Confirm the operation of outdoor unit fan.
	Confirm the operation of all interlocked equipment, such as ventilation equipment.
Cancel the test run by pressing the ON/OFF button.	→ Stop
<p>Note 1: Refer to the following pages if an error code appears on the remote controller or when the unit malfunctions.</p> <p>2: The OFF timer will automatically stop the test run after 2 hours.</p> <p>3: The remaining time for the test run will be displayed in the time display during test run.</p> <p>4: The temperature of the liquid pipe on the indoor unit will be displayed in the room temperature display window on the remote controller during test run.</p> <p>5: On some models, "NOT AVAILABLE" may appear on the display when the Vane Control button is pressed. This is normal.</p> <p>6: If an external input is connected, perform a test run using the external input signal.</p>	

[3] Operating Characteristic and Refrigerant Amount

It is important to have a clear understanding of the characteristics of refrigerant and the operating characteristics of air conditioners before attempting to adjust the refrigerant amount in a given system.

1. Operating characteristic and refrigerant amount

The following table shows items of particular importance.

- 1) During cooling operation, the amount of refrigerant in the accumulator is the smallest when all indoor units are in operation.
- 2) During heating operation, the amount of refrigerant in the accumulator is the largest when all indoor units are in operation.
- 3) General tendency of discharge temperature
 - Discharge temperature tends to rise when the system is short on refrigerant.
 - Changing the amount of refrigerant in the system while there is refrigerant in the accumulator has little effect on the discharge temperature.
 - The higher the pressure, the more likely it is for the discharge temperature to rise.
 - The lower the pressure, the more likely it is for the discharge temperature to rise.
- 4) When the amount of refrigerant in the system is adequate, the compressor shell temperature is 10 to 60°C [18 to 108°F] higher than the low pressure saturation temperature (Te).
 - > If the temperature difference between the compressor shell temperature and low pressure saturation temperature (Te) is smaller than 5°C [9°F], an overcharging of refrigerant is suspected.

[4] Adjusting the Refrigerant Amount

1. Symptoms

Overcharging or undercharging of refrigerant can cause the following symptoms:
 Before attempting to adjust the amount of refrigerant in the system, thoroughly check the operating conditions of the system. Then, adjust the refrigerant amount by running the unit in the refrigerant amount adjust mode.

The system comes to an abnormal stop, displaying 1500 (overcharged refrigerant) on the controller.	Overcharged refrigerant
The operating frequency does not reach the set frequency, and there is a problem with performance.	Insufficient refrigerant amount
The system comes to an abnormal stop, displaying 1102 (abnormal discharge temperature) on the controller.	

2. Amount of refrigerant

(1) To be checked during operation

Operate all indoor units in either cooling-only or heating-only mode, and check such items as discharge temperature, subcooling, low pressure, suction temperature, and shell bottom temperature to estimate the amount of refrigerant in the system.

Symptoms	Conclusion
Discharge temperature is high. (Normal discharge temperature is below 95°C [203°F].)	Slightly undercharged refrigerant
Low pressure is unusually low.	
Suction superheat is large. (Normal suction superheat is less than 20°C [36°F].)	
Compressor shell bottom temperature is high. (The difference between the compressor shell bottom temperature and low pressure saturation temperature (Te) is greater than 60°C [108°F].)	Slightly overcharged refrigerant
Discharge superheat is small. (Normal discharge superheat is greater than 10°C [18°F].)	
Compressor shell bottom temperature is low. (The difference between the compressor shell bottom temperature and low pressure saturation temperature (Te) is less than 5°C [9°F].)	

3. Amount of refrigerant to be added

The amount of refrigerant that is shown in the table below is factory-charged to the outdoor units. The amount necessary for extended pipe (field piping) is not included and must be added on site.

Outdoor unit model	P72	P96	P120
Amount of pre-charged refrigerant in the outdoor unit (kg)	9.0	9.0	11.5
Amount of pre-charged refrigerant in the outdoor unit [lbs-oz]	19-13	19-13	25-6

(1) Calculation formula

The amount of refrigerant to be added depends on the size and the length of field piping. (unit in m[ft])

$\begin{aligned} \text{Amount of added refrigerant (kg)} &= (0.29 \times L_1) + (0.2 \times L_2) + (0.12 \times L_3) + (0.06 \times L_4) + (0.024 \times L_5) + \alpha \\ \text{Amount of added refrigerant (oz)} &= (3.12 \times L_1') + (2.15 \times L_2') + (1.29 \times L_3') + (0.65 \times L_4') + (0.26 \times L_5') + \alpha' \end{aligned}$
--

L_1 : Length of $\varnothing 19.05$ [3/4"] liquid pipe (m) L_2 : Length of $\varnothing 15.88$ [5/8"] liquid pipe (m) L_3 : Length of $\varnothing 12.7$ [1/2"] liquid pipe (m) L_4 : Length of $\varnothing 9.52$ [3/8"] liquid pipe (m) L_5 : Length of $\varnothing 6.35$ [1/4"] liquid pipe (m) α, α' : Refer to the table below.	L_1' : Length of $\varnothing 19.05$ [3/4"] liquid pipe [ft] L_2' : Length of $\varnothing 15.88$ [5/8"] liquid pipe [ft] L_3' : Length of $\varnothing 12.7$ [1/2"] liquid pipe [ft] L_4' : Length of $\varnothing 9.52$ [3/8"] liquid pipe [ft] L_5' : Length of $\varnothing 6.35$ [1/4"] liquid pipe [ft]
--	---

Total capacity of connected indoor units	α (kg)	α' (oz)
- 27	2.0	71
28 - 54	2.5	89
55 - 126	3.0	106
127 - 144	3.5	124
145 - 180	4.5	159
181 - 234	5.0	177
235 - 273	6.0	212
274 - 307	8.0	283
308 - 342	9.0	318
343 - 411	10.0	353
412 - 480	12.0	424
481 -	14.0	494

Round up the calculation result to the nearest 0.1kg. (Example: 18.04kg to 18.1kg)

Round up the calculation result in increments of 4oz (0.1kg) or round it up to the nearest 1oz. (Example: 178.21oz to 179oz)

(2) Example: PUHY-P144Y(T)SHMU-A

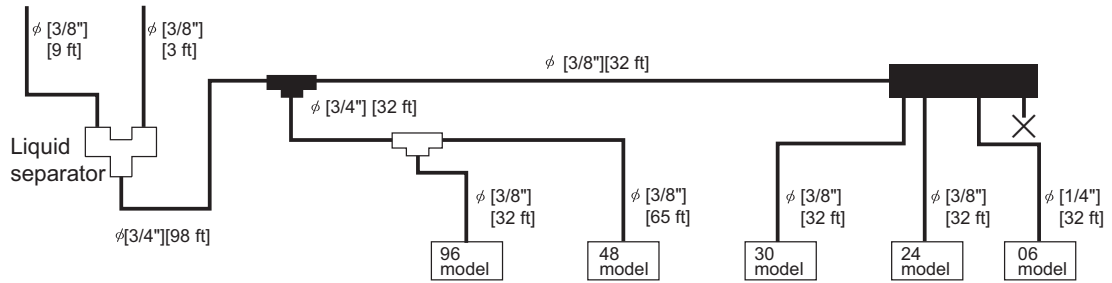
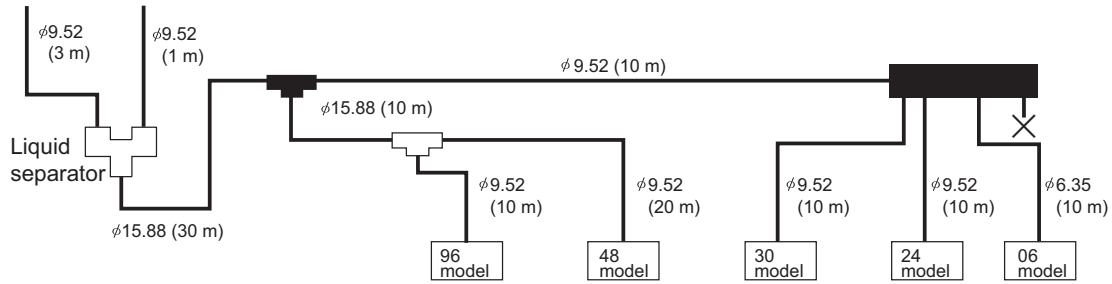

(3) Sample calculation

All the pipes in the figure are liquid pipes.

$$\phi 15.88 : 30 \text{ m} + 10 \text{ m} = 40 \text{ m}$$

$$\phi 9.52 : 3 \text{ m} + 1 \text{ m} + 10 \text{ m} + 10 \text{ m} + 20 \text{ m} + 10 \text{ m} + 10 \text{ m} = 64 \text{ m}$$

$$\phi 6.35 : 10 \text{ m}$$

According to the above formula

$$\text{Amount of refrigerant to be charged (kg)} = (0.2 \times 40) + (0.06 \times 64) + (0.024 \times 10) + 5.0 = 17.08\text{kg}$$

The calculation result would be 17.08, and it is rounded up to the nearest 0.1.

The final result will be as follows:

$$\text{Amount of refrigerant to be charged} = 17.1\text{kg}$$



All the pipes in the figure are liquid pipes.

$$\phi [3/4"] : [98 \text{ ft}] + [32 \text{ ft}] = [130 \text{ ft}]$$

$$\phi [3/8"] : [9 \text{ ft}] + [3 \text{ ft}] + [32 \text{ ft}] + [32 \text{ ft}] + [65 \text{ ft}] + [32 \text{ ft}] + [32 \text{ ft}] = [205 \text{ ft}]$$

$$\phi [1/4"] : [32 \text{ ft}]$$

According to the above formula

$$\text{Amount of refrigerant to be charged (oz)} = (2.15 \times 130) + (0.65 \times 205) + (0.26 \times 32) + 177 = 598.07\text{oz}$$

The calculation result would be 598.07 oz, and it is rounded up to the nearest 1 oz.

The final result will be as follows:

$$\text{Amount of refrigerant to be charged} = 599 \text{ oz}$$



CAUTION

Charge liquid refrigerant (as opposed to gaseous refrigerant) into the system.

- If gaseous refrigerant is charged into the system, the composition of the refrigerant in the cylinder will change and may result in performance loss.

[5] Refrigerant Amount Adjust Mode

1. Procedures

Follow the procedures below to add or extract refrigerant as necessary depending on the operation mode.

When the function switch (SW4-3) on the main board on the outdoor unit (OC only) is turned to ON, the unit goes into the refrigerant amount adjust mode, and the following sequence is followed.

Note

SW4-3 on the OS is invalid, and the unit will not go into the refrigerant amount adjust mode.

Operation

When the unit is in the refrigerant amount adjust mode, the LEV on the indoor unit does not open as fully as it normally does during cooling operation to secure subcooling.

Note

- 1) Adjust the refrigerant amount based on the values of TH4, TH3, TH6, and Tc, following the flowchart below. Check the TH4, TH3, TH6, and Tc values on the OC, OS1, and OS2 by following the flowchart. The TH4, TH3, TH6, and Tc values can be displayed by setting the self-diagnosis switch (SW1) on the main board on the OC, OS1, and OS2.
- 2) There may be cases when the refrigerant amount may seem adequate for a short while after starting the unit in the refrigerant amount adjust mode but turn out to be inadequate later on (when the refrigerant system stabilizes).

When the amount of refrigerant is truly adequate.

TH3-TH6 on the indoor unit is 5°C [9°F] or above and SH on the indoor unit is between 5 and 15°C [9 and 27°F].

The refrigerant amount may seem adequate at the moment, but may turn out to be inadequate later on.

TH3-TH6 on the indoor unit is 5°C [9°F] or less and SH on the indoor unit is 5°C [9°F] or less.

Wait until the TH3-TH6 reaches 5°C [9°F] or above and the SH of the indoor unit is between 5 and 15°C [9 and 27°F] to determine that the refrigerant amount is adequate.

- 3) High pressure must be at least 2.0MPa[290psj] to enable a proper adjustment of refrigerant amount to be made.
- 4) Refrigerant amount adjust mode automatically ends 90 minutes after beginning. When this happens, by turning off the SW4-3 and turning them back on, the unit will go back into the refrigerant amount adjust mode.

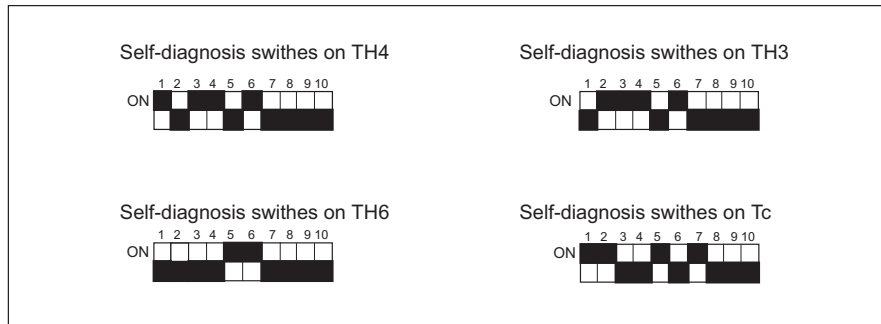

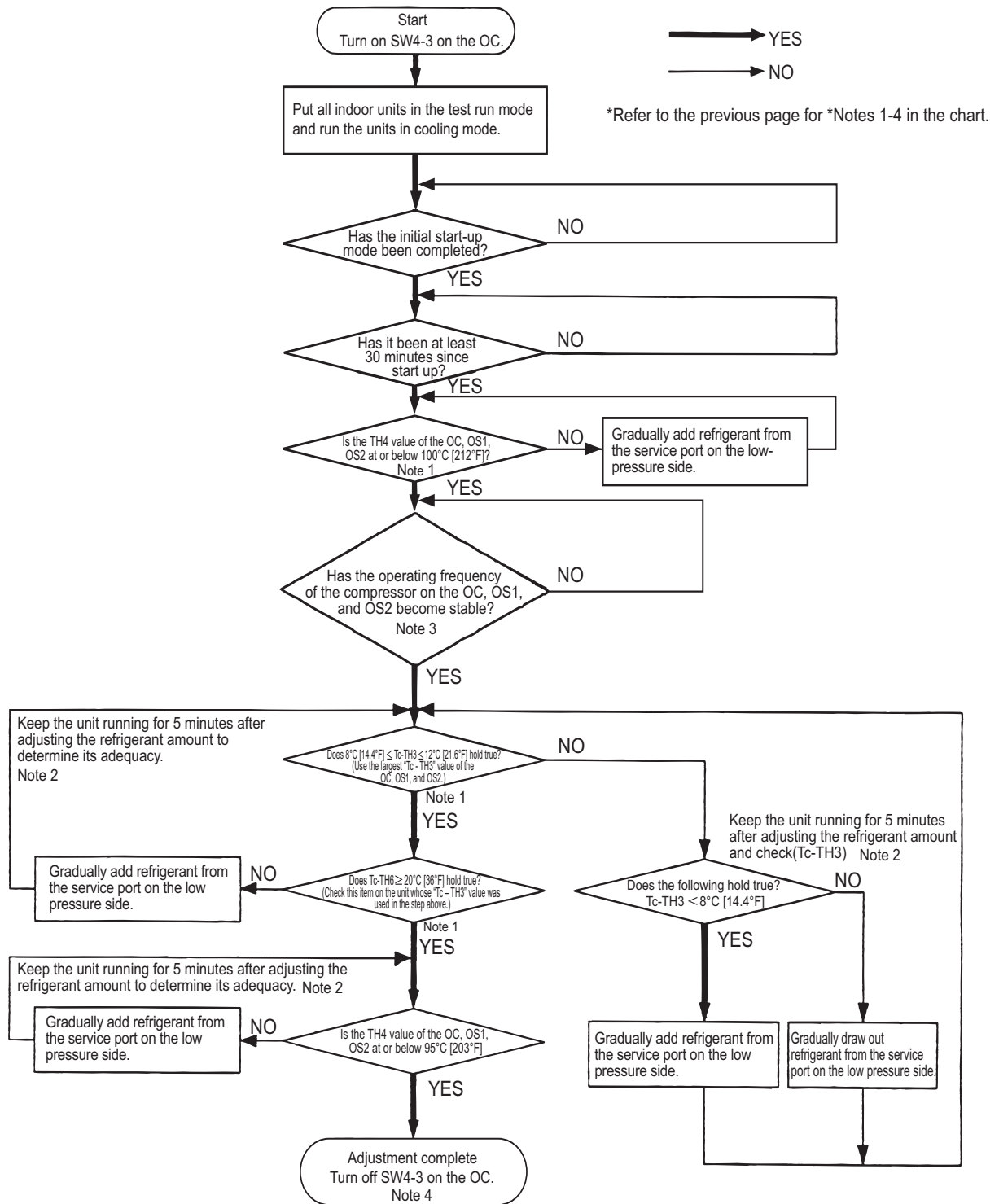

CAUTION
Do not release the extracted refrigerant into the air.

CAUTION
Charge liquid refrigerant (as opposed to gaseous refrigerant) into the system.
•If gaseous refrigerant is charged into the system, the composition of the refrigerant in the cylinder will change and may result in performance loss.

[6] The following symptoms are normal.

Symptoms	Remote controller display	Cause
The indoor unit does not start after starting cooling (heating) operation.	"Cooling (heating)" icon blinks on the display.	The unit cannot perform a heating (cooling) operation when other indoor units are performing a cooling (heating) operation.
The auto vane adjusts its position by itself.	Normal display	After an hour of cooling operation with the auto vane in the vertical position, the vane may automatically move into the horizontal position. Louver blades will automatically move into the horizontal position while the unit is in the defrost mode, pre-heating stand-by mode, or when the thermostat triggers unit off.
The fan stops during heating operation.	Defrost	The fan remains stopped during defrost operation.
The fan keeps running after the unit has stopped.	Unlit	When the auxiliary heater is turned on, the fan operates for one minute after stopping to dissipate heat.
The fan speed does not reach the set speed when operation switch is turned on.	STAND BY	The fan operates at extra low speed for 5 minutes after it is turned on or until the pipe temperature reaches 35°C[95°F], then it operates at low speed for 2 minutes, and finally it operates at the set speed. (Pre-heating stand-by)
When the main power is turned on, the display shown on the right appears on the indoor unit remote controller for 5 minutes.	"HO" or "PLEASE WAIT" icons blink on the display.	The system is starting up. Wait until the blinking display of "HO" or "PLEASE WAIT" go off.
The drain pump keeps running after the unit has stopped.	Unlit	The drain pump stays in operation for three minutes after the unit in the cooling mode is stopped.
The drain pump is running while the unit is stopped.		When drain water is detected, the drain pump goes into operation even while the unit is stopped.
Indoor unit and BC controller make noise during cooling/heating changeover.	Normal display	This noise is made when the refrigerant circuit is reversed and is normal.
Sound of the refrigerant flow is heard from the indoor unit immediately after starting operation.	Normal display	This is caused by the transient instability of the refrigerant flow and is normal.
Warm air sometimes comes out of the indoor units that are not in the heating mode.	Normal display	This is due to the fact that the LEVs on some of the indoor units are kept slightly open to prevent the refrigerant in the indoor units that are not operating in the heating mode from liquefying and accumulating in the compressor. It is part of a normal operation.

[7] Standard Operation Data (Reference Data)

1. Single unit

(1) Cooling operation

Operation				Outdoor unit model	
				PUHY-P72THMU-A	PUHY-P96THMU-A
Operating conditions	Ambient temperature	Indoor	DB/WB	26.7°C/19.4°C [80°F/67°F]	26.7°C/19.4°C [80°F/67°F]
		Outdoor		35°C/ - [95°F/ -]	35°C/ - [95°F/ -]
	Indoor unit	No. of connected units	Unit	2	2
		No. of units in operation		2	2
		Model		-	36/36
	Piping	Main pipe	m [ft]	5 [16-3/8]	5 [16-3/8]
		Branch pipe		10 [32-3/4]	10 [32-3/4]
		Total pipe length		25 [82]	25 [82]
	Fan speed		-	Hi	Hi
	Amount of refrigerant		kg [lbs-oz]	11 [24]	11 [24]
Outdoor unit	Electric current		A	14.6	23.4
	Voltage		V	230	230
	Compressor frequency		Hz	52	65
LEV opening	Indoor unit		Pulse	325/325	387/387
	SC (LEV1)			80	100
	LEV2			1400	1400
Pressure	High pressure (after O/S)/low pressure (before accumulator)		MPa [psi]	2.59/10.96 [376/139]	2.83/0.84 [410/122]
Temp. of each section	Outdoor unit	Discharge (TH4)	°C [°F]	69 [156]	74 [165]
		Heat exchanger outlet (TH3)		44 [111]	46 [115]
		Accumulator inlet		10 [50]	10 [50]
		Accumulator outlet		10 [50]	10 [50]
		SCC outlet (TH6)		24 [75]	26 [79]
		Compressor inlet		17 [63]	14 [57]
		Compressor shell bottom		47 [117]	38 [100]
	Indoor unit	LEV inlet		23 [73]	25 [77]
		Heat exchanger outlet		10 [50]	10 [50]

Operation				Outdoor unit model
				PUHY-P120THMU-A
Operating conditions	Ambient temperature	Indoor	DB/WB	26.7°C/19.4°C [80°F/67°F]
		Outdoor		35°C/ - [95°F/ -]
	Indoor unit	No. of connected units	Unit	3
		No. of units in operation		3
		Model		-
	Piping	Main pipe	m [ft]	5 [16-3/8]
		Branch pipe		10 [32-3/4]
		Total pipe length		35 [114-13/16]
	Fan speed		-	Hi
	Amount of refrigerant		kg [lbs-oz]	15 [33]
Outdoor unit	Electric current		A	28.1
	Voltage		V	230
	Compressor frequency		Hz	74
LEV opening	Indoor unit		Pulse	325/325/325
	SC (LEV1)			100
	LEV2			1400
Pressure	High pressure (after O/S)/low pressure (before accumulator)		MPa [psi]	2.92/0.90 [424/131]
Temp. of each section	Outdoor unit	Discharge (TH4)	°C [°F]	73 [163]
		Heat exchanger outlet (TH3)		40 [104]
		Accumulator inlet		10 [50]
		Accumulator outlet		10 [50]
		SCC outlet (TH6)		20 [68]
		Compressor inlet		15 [59]
		Compressor shell bottom		42 [108]
	Indoor unit	LEV inlet		19 [66]
		Heat exchanger outlet		10 [50]

(2) Heating operation

Operation				Outdoor unit model	
				PUHY-P72THMU-A	PUHY-P96THMU-A
Operating conditions	Ambient temperature	Indoor	DB/WB	21.1°C/ - [70°F/ -]	21.1°C/ - [70°F/ -]
		Outdoor		8.3°C/6.1°C [47°F/43°F]	8.3°C/6.1°C [47°F/43°F]
	Indoor unit	No. of connected units	Unit	2	2
		No. of units in operation		2	2
		Model		-	36/36
	Piping	Main pipe	m [ft]	5 [16-3/8]	5 [16-3/8]
		Branch pipe		10 [32-3/4]	10 [32-3/4]
		Total pipe length		25 [82]	25 [82]
	Fan speed		-	Hi	Hi
	Amount of refrigerant		kg [lbs-oz]	11 [24]	11 [24]
Outdoor unit	Electric current		A	15.8	24.0
	Voltage		V	230	230
	Compressor frequency		Hz	53	71
LEV opening	Indoor unit		Pulse	332/332	406/406
	SC (LEV1)			0	0
	LEV2			1400	1400
Pressure	High pressure (after O/S)/low pressure (before accumulator)		MPa [psi]	2.59/0.67 [376/97]	2.85/0.64 [413/93]
Temp. of each section	Outdoor unit	Discharge (TH4)	°C [°F]	72 [162]	75 [167]
		Heat exchanger outlet (TH3)		0 [32]	-2 [28]
		Accumulator inlet		0 [32]	-2 [28]
		Accumulator outlet		0 [32]	-2 [28]
		Compressor inlet		0 [32]	-2 [28]
		Compressor shell bottom		40 [104]	40 [104]
	Indoor unit	LEV inlet		36 [97]	37 [99]
		Heat exchanger inlet		70 [158]	73 [163]

Operation				Outdoor unit model
				PUHY-P120THMU-A
Operating conditions	Ambient temperature	Indoor	DB/WB	21.1°C/ - [70°F/ -]
		Outdoor		8.3°C/6.1°C [47°F/43°F]
	Indoor unit	No. of connected units	Unit	3
		No. of units in operation		3
		Model		-
	Piping	Main pipe	m [ft]	5 [16-3/8]
		Branch pipe		10 [32-3/4]
		Total pipe length		35 [114-13/16]
	Fan speed		-	Hi
	Amount of refrigerant		kg [lbs-oz]	15 [33]
Outdoor unit	Electric current		A	25.8
	Voltage		V	230
	Compressor frequency		Hz	81
LEV opening	Indoor unit		Pulse	332/332/332
	SC (LEV1)			0
	LEV2			1400
Pressure	High pressure (after O/S)/low pressure (before accumulator)		MPa [psi]	2.70/0.65 [392/94]
Temp. of each section	Outdoor unit	Discharge (TH4)	°C [°F]	70 [158]
		Heat exchanger outlet (TH3)		-1 [30]
		Accumulator inlet		-1 [30]
		Accumulator outlet		-1 [30]
		Compressor inlet		-1 [30]
		Compressor shell bottom		40 [104]
	Indoor unit	LEV inlet		36 [97]
		Heat exchanger inlet		69 [156]

2. 2-unit combination
(1) Cooling operation

Operation				Outdoor unit model	
				PUHY-P144TSHMU-A	
				PUHY-P72THMU-A	PUHY-P72THMU-A
Operating conditions	Ambient temperature	Indoor	DB/WB	26.7 °C /19.4 °C [80 °F/67 °F]	
		Outdoor		35 °C / - [95 °F/ -]	
	Indoor unit	No. of connected units	Unit	4	
		No. of units in operation		4	
		Model		-	36/36/36/36
	Piping	Main pipe	m [ft]	5 [16-3/8]	
		Branch pipe		10 [32-3/4]	
		Total pipe length		45 [147-5/8]	
	Fan speed		-	Hi	
	Amount of refrigerant		kg [lbs-oz]	19 [42]	
Outdoor unit	Electric current		A	30.3	
	Voltage		V	230	
	Compressor frequency		Hz	48	48
LEV opening	Indoor unit		Pulse	325/325/325/325	
	SC (LEV1)			190	190
	LEV2			1400	1400
Pressure	High pressure (after O/S)/low pressure (before accumulator)		MPa [psi]	2.59/0.96 [376/139]	2.59/0.96 [376/139]
Temp. of each section	Outdoor unit	Discharge (TH4)	°C [°F]	69 [156]	69 [156]
		Heat exchanger outlet (TH3)		44 [111]	44 [111]
		Accumulator inlet		10 [50]	10 [50]
		Accumulator outlet		10 [50]	10 [50]
		SCC outlet (TH6)		24 [75]	24 [75]
		Compressor inlet		17 [63]	17 [63]
		Compressor shell bottom		47 [117]	47 [117]
	Indoor unit	LEV inlet		23 [73]	23 [73]
		Heat exchanger outlet		10 [50]	10 [50]

Operation				Outdoor unit model	
				PUHY-P168TSHMU-A	
				PUHY-P72THMU-A	PUHY-P96THMU-A
Operating conditions	Ambient temperature	Indoor	DB/WB	26.7 °C /19.4 °C [80 °F/67 °F]	
		Outdoor		35 °C / - [95 °F/ -]	
	Indoor unit	No. of connected units	Unit	4	
		No. of units in operation		4	
		Model		-	36/36/48/48
	Piping	Main pipe	m [ft]	5 [16-3/8]	
		Branch pipe		10 [32-3/4]	
		Total pipe length		45 [147-5/8]	
	Fan speed		-	Hi	
	Amount of refrigerant		kg [lbs-oz]	19 [42]	
Outdoor unit	Electric current		A	39.3	
	Voltage		V	230	
	Compressor frequency		Hz	52	60
LEV opening	Indoor unit		Pulse	325/325/387/387	
	SC (LEV1)			190	190
	LEV2			1400	1400
Pressure	High pressure (after O/S)/low pressure (before accumulator)		MPa [psi]	2.71/0.90 [393/131]	2.71/0.90 [393/131]
Temp. of each section	Outdoor unit	Discharge (TH4)	°C [°F]	69 [156]	74 [165]
		Heat exchanger outlet (TH3)		44 [111]	46 [115]
		Accumulator inlet		10 [50]	10 [50]
		Accumulator outlet		10 [50]	10 [50]
		SCC outlet (TH6)		24 [75]	26 [79]
		Compressor inlet		17 [63]	14 [57]
		Compressor shell bottom		47 [117]	38 [100]
	Indoor unit	LEV inlet		23 [73]	25 [77]
		Heat exchanger outlet		10 [50]	10 [50]

Operation				Outdoor unit model	
				PUHY-P192TSHMU-A	
				PUHY-P72THMU-A	PUHY-P120THMU-A
Operating conditions	Ambient temperature	Indoor	DB/WB	26.7 °C /19.4 °C [80 °F/67 °F]	
		Outdoor		35 °C / - [95 °F/ -]	
	Indoor unit	No. of connected units	Unit	4	
		No. of units in operation		4	
		Model		48/48/48/48	
	Piping	Main pipe	m [ft]	5 [16-3/8]	
		Branch pipe		10 [32-3/4]	
		Total pipe length		45 [147-5/8]	
	Fan speed		-	Hi	
	Amount of refrigerant		kg [lbs-oz]	22 [49]	
Outdoor unit	Electric current		A	44.1	
	Voltage		V	230	
	Compressor frequency		Hz	52	74
LEV opening	Indoor unit		Pulse	387/387/387/387	
	SC (LEV1)			100	100
	LEV2			1400	1400
Pressure	High pressure (after O/S)/low pressure (before accumulator)		MPa [psi]	2.76/0.93 [400/135]	2.76/0.93 [400/135]
Temp. of each section	Outdoor unit	Discharge (TH4)	°C [°F]	69 [156]	73 [163]
		Heat exchanger outlet (TH3)		44 [111]	40 [104]
		Accumulator inlet		10 [50]	10 [50]
		Accumulator outlet		10 [50]	10 [50]
		SCC outlet (TH6)		24 [75]	20 [68]
		Compressor inlet		17 [63]	15 [59]
		Compressor shell bottom		47 [117]	42 [108]
	Indoor unit	LEV inlet		23 [73]	[19] [66]
		Heat exchanger outlet		10 [50]	[10] [50]

Operation				Outdoor unit model	
				PUHY-P216TSHMU-A	
				PUHY-P96THMU-A	PUHY-P120THMU-A
Operating conditions	Ambient temperature	Indoor	DB/WB	26.7 °C /19.4 °C [80 °F/67 °F]	
		Outdoor		35 °C / - [95 °F/ -]	
	Indoor unit	No. of connected units	Unit	6	
		No. of units in operation		6	
		Model		- 06/36/36/36/48/48	
	Piping	Main pipe	m [ft]	5 [16-3/8]	
		Branch pipe		10 [32-3/4]	
		Total pipe length		65 [213-1/4]	
	Fan speed		-	Hi	
	Amount of refrigerant		kg [lbs-oz]	25 [55]	
Outdoor unit	Electric current		A 53.2		
	Voltage		V 230		
	Compressor frequency		Hz 65	71	
LEV opening	Indoor unit		Pulse 222/325/325/325/387/387		
	SC (LEV1)		159	237	
	LEV2		1400	1400	
Pressure	High pressure (after O/S)/low pressure (before accumulator)		MPa [psi] 2.88/0.87 [417/126]	2.88/0.87 [417/126]	
Temp. of each section	Outdoor unit	Discharge (TH4)	°C [°F]	74 [165]	73 [163]
		Heat exchanger outlet (TH3)		46 [115]	40 [104]
		Accumulator inlet		10 [50]	10 [50]
		Accumulator outlet		10 [50]	10 [50]
		SCC outlet (TH6)		26 [79]	20 [68]
		Compressor inlet		14 [57]	15 [59]
		Compressor shell bottom		38 [100]	42 [108]
	Indoor unit	LEV inlet		25 [77]	19 [66]
		Heat exchanger outlet		10 [50]	10 [50]

Operation				Outdoor unit model	
				PUHY-P240TSHMU-A	
				PUHY-P120THMU-A	PUHY-P120THMU-A
Operating conditions	Ambient temperature	Indoor	DB/WB	26.7 °C /19.4 °C [80 °F/67 °F]	
		Outdoor		35 °C / - [95 °F/ -]	
	Indoor unit	No. of connected units	Unit	6	
		No. of units in operation		6	
		Model		- 18/36/36/36/48/48	
	Piping	Main pipe	m [ft]	5 [16-3/8]	
		Branch pipe		10 [32-3/4]	
		Total pipe length		65 [213-1/4]	
	Fan speed		-	Hi	
	Amount of refrigerant		kg [lbs-oz]	25 [55]	
Outdoor unit	Electric current		A	58.0	
	Voltage		V	230	
	Compressor frequency		Hz	74	74
LEV opening	Indoor unit		Pulse	362/325/325/387/387	
	SC (LEV1)			237	237
	LEV2			1400	1400
Pressure	High pressure (after O/S)/low pressure (before accumulator)		MPa [psi]	2.92/0.90 [424/131]	2.92/0.90 [424/131]
Temp. of each section	Outdoor unit	Discharge (TH4)	°C [°F]	73 [163]	73 [163]
		Heat exchanger outlet (TH3)		40 [104]	40 [104]
		Accumulator inlet		10 [50]	10 [50]
		Accumulator outlet		10 [50]	10 [50]
		SCC outlet (TH6)		20 [68]	20 [68]
		Compressor inlet		15 [59]	15 [59]
		Compressor shell bottom		42 [108]	42 [108]
	Indoor unit	LEV inlet		19 [66]	19 [66]
		Heat exchanger outlet		10 [50]	10 [50]

(2) Heating operation

Operation				Outdoor unit model	
				PUHY-P144TSHMU-A	
				PUHY-P72THMU-A	PUHY-P72THMU-A
Operating conditions	Ambient temperature	Indoor	DB/WB	21.1°C/ - [70°F/ -]	
		Outdoor		8.3°C/6.1°C [47°F/43°F]	
	Indoor unit	No. of connected units	Unit	4	
		No. of units in operation		4	
		Model		36/36/36/36	
	Piping	Main pipe	m [ft]	5 [16-3/8]	
		Branch pipe		10 [32-3/4]	
		Total pipe length		45 [147-5/8]	
	Fan speed		-	Hi	
	Amount of refrigerant		kg [lbs-oz]	19 [42]	
Outdoor unit	Electric current		A	32.6	
	Voltage		V	230	
	Compressor frequency		Hz	51	51
LEV opening	Indoor unit		Pulse	332/332/332/332	
	SC (LEV1)			0	
	LEV2			1400	1400
Pressure	High pressure (after O/S)/low pressure (before accumulator)		MPa [psi]	2.59/0.67 [376/97]	2.59/0.67 [376/97]
Temp. of each section	Outdoor unit	Discharge (TH4)	°C [°F]	72 [162]	72 [162]
		Heat exchanger outlet (TH3)		0 [32]	0 [32]
		Accumulator inlet		0 [32]	0 [32]
		Accumulator outlet		0 [32]	0 [32]
		Compressor inlet		0 [32]	0 [32]
		Compressor shell bottom		40 [104]	40 [104]
	Indoor unit	LEV inlet		36 [97]	36 [97]
		Heat exchanger inlet		70 [158]	70 [158]

Operation				Outdoor unit model	
				PUHY-P168TSHMU-A	
				PUHY-P72THMU-A	PUHY-P96THMU-A
Operating conditions	Ambient temperature	Indoor	DB/WB	21.1°C/ - [70°F/ -]	
		Outdoor		8.3°C/6.1°C [47°F/43°F]	
	Indoor unit	No. of connected units	Unit	4	
		No. of units in operation		4	
		Model		- 36/36/48/48	
	Piping	Main pipe	m [ft]	5 [16-3/8]	
		Branch pipe		10 [32-3/4]	
		Total pipe length		45 [147-5/8]	
	Fan speed		-	Hi	
	Amount of refrigerant		kg [lbs-oz]	19 [42]	
Outdoor unit	Electric current		A	41.0	
	Voltage		V	230	
	Compressor frequency		Hz	53	64
LEV opening	Indoor unit		Pulse	332/332/406/406	
	SC (LEV1)			0	
	LEV2			1400	1400
Pressure	High pressure (after O/S)/low pressure (before accumulator)		MPa [psi]	2.72/0.66 [395/95]	2.72/0.66 [395/95]
Temp. of each section	Outdoor unit	Discharge (TH4)	°C [°F]	72 [162]	75 [167]
		Heat exchanger outlet (TH3)		0 [32]	2 [28]
		Accumulator inlet		0 [32]	2 [28]
		Accumulator outlet		0 [32]	2 [28]
		Compressor inlet		0 [32]	2 [28]
		Compressor shell bottom		40 [104]	40 [104]
	Indoor unit	LEV inlet		36 [97]	37 [99]
		Heat exchanger inlet		70 [158]	73 [163]

Operation				Outdoor unit model	
				PUHY-P192TSHMU-A	
				PUHY-P72THMU-A	PUHY-P120THMU-A
Operating conditions	Ambient temperature	Indoor	DB/WB	21.1°C / - [70°F / -]	
		Outdoor		8.3°C/6.1°C [47°F/43°F]	
	Indoor unit	No. of connected units	Unit	4	
		No. of units in operation		4	
		Model		48/48/48/48	
	Piping	Main pipe	m [ft]	5 [16-3/8]	
		Branch pipe		10 [32-3/4]	
		Total pipe length		45 [147-5/8]	
	Fan speed		-	Hi	
	Amount of refrigerant		kg [lbs-oz]	22 [49]	
Outdoor unit	Electric current		A	42.8	
	Voltage		V	230	
	Compressor frequency		Hz	71	71
LEV opening	Indoor unit		Pulse	406/406/406/406	
	SC (LEV1)			0	
	LEV2			1400	1400
Pressure	High pressure (after O/S)/low pressure (before accumulator)		MPa [psi]	2.65/0.66 [384/96]	2.65/0.66 [384/96]
Temp. of each section	Outdoor unit	Discharge (TH4)	°C [°F]	72 [162]	70 [158]
		Heat exchanger outlet (TH3)		0 [32]	-1 [30]
		Accumulator inlet		0 [32]	-1 [30]
		Accumulator outlet		0 [32]	-1 [30]
		Compressor inlet		0 [32]	-1 [30]
		Compressor shell bottom		40 [104]	40 [104]
	Indoor unit	LEV inlet		36 [97]	36 [97]
		Heat exchanger inlet		70 [158]	69 [156]

Operation				Outdoor unit model	
				PUHY-P216TSHMU-A	
				PUHY-P96THMU-A	PUHY-P120THMU-A
Operating conditions	Ambient temperature	Indoor	DB/WB	21.1°C/ - [70°F/ -]	
		Outdoor		8.3°C/6.1°C [47°F/43°F]	
	Indoor unit	No. of connected units	Unit	6	
		No. of units in operation		6	
		Model		06/36/36/36/48/48	
	Piping	Main pipe	m [ft]	5 [16-3/8]	
		Branch pipe		10 [32-3/4]	
		Total pipe length		65 [213-1/4]	
	Fan speed		-	Hi	
	Amount of refrigerant		kg [lbs-oz]	25 [55]	
Outdoor unit	Electric current		A	51.3	
	Voltage		V	230	
	Compressor frequency		Hz	75	75
LEV opening	Indoor unit		Pulse	229/332/332/332/406/406	
	SC (LEV1)			0	
	LEV2			1400	1400
Pressure	High pressure (after O/S)/low pressure (before accumulator)		MPa [psi]	2.78/0.65 [402/94]	2.78/0.65 [402/94]
Temp. of each section	Outdoor unit	Discharge (TH4)	°C [°F]	75 [167]	70 [158]
		Heat exchanger outlet (TH3)		-2 [28]	-1 [30]
		Accumulator inlet		-2 [28]	-1 [30]
		Accumulator outlet		-2 [28]	-1 [30]
		Compressor inlet		-2 [28]	-1 [30]
		Compressor shell bottom		40 [104]	40 [104]
	Indoor unit	LEV inlet		37 [99]	36 [97]
		Heat exchanger inlet		73 [163]	69 [156]

Operation				Outdoor unit model	
				PUHY-P240TSHMU-A	
				PUHY-P120THMU-A	PUHY-P120THMU-A
Operating conditions	Ambient temperature	Indoor	DB/WB	21.1°C/ - [70°F/ -]	
		Outdoor		8.3°C/6.1°C [47°F/43°F]	
	Indoor unit	No. of connected units	Unit	6	
		No. of units in operation		6	
		Model		18/36/36/36/48/48	
	Piping	Main pipe	m [ft]	5 [16-3/8]	
		Branch pipe		10 [32-3/4]	
		Total pipe length		65 [213-1/4]	
	Fan speed		-	Hi	
	Amount of refrigerant		kg [lbs-oz]	25 [55]	
Outdoor unit	Electric current		A	53.1	
	Voltage		V	230	
	Compressor frequency		Hz	85	85
LEV opening	Indoor unit		Pulse	373/332/332/332/406/406	
	SC (LEV1)			0	
	LEV2			1400	1400
Pressure	High pressure (after O/S)/low pressure (before accumulator)		MPa [psi]	2.70/0.65 [392/94]	2.70/0.65 [392/94]
Temp. of each section	Outdoor unit	Discharge (TH4)	°C [°F]	70 [158]	70 [158]
		Heat exchanger outlet (TH3)		-1 [30]	-1 [30]
		Accumulator inlet		-1 [30]	-1 [30]
		Accumulator outlet		-1 [30]	-1 [30]
		Compressor inlet		-1 [30]	-1 [30]
		Compressor shell bottom		40 [104]	40 [104]
	Indoor unit	LEV inlet		36 [97]	36 [97]
		Heat exchanger inlet		69 [156]	69 [156]

3. 3-unit combination
(1) Cooling operation

Operation				Outdoor unit model		
				PUHY-P264TSHMU-A		
				PUHY-P72THMU-A	PUHY-P72THMU-A	PUHY-P120THMU-A
Operating conditions	Ambient temperature	Indoor	DB/WB	26.7°C/19.4°C [80°F/67°F]		
		Outdoor		35°C/ - [95°F/ -]		
	Indoor unit	No. of connected units	Unit	6		
		No. of units in operation		6		
		Model		- 36/36/48/48/48/48		
	Piping	Main pipe	m [ft]	5 [16-3/8]		
		Branch pipe		10 [32-3/4]		
		Total pipe length		65 [213-1/4]		
	Fan speed		-	Hi		
	Amount of refrigerant		kg [lbs-oz]	31 [68]		
Outdoor unit	Electric current		A	59.3		
	Voltage		V	230		
	Compressor frequency		Hz	52	52	74
LEV opening	Indoor unit		Pulse	325/325/387/387/387/387		
	SC (LEV1)			105	105	105
	LEV2			1400	1400	1400
Pressure	High pressure (after O/S)/low pressure (before accumulator)		MPa [psi]	2.70/0.94 [392/136]	2.70/0.94 [392/136]	2.70/0.94 [392/136]
Temp. of each section	Outdoor unit	Discharge (TH4)	°C [°F]	69 [156]	69 [156]	73 [163]
		Heat exchanger outlet (TH3)		44 [111]	44 [111]	40 [104]
		Accumulator inlet		10 [50]	10 [50]	10 [50]
		Accumulator outlet		10 [50]	10 [50]	10 [50]
		SCC outlet (TH6)		24 [75]	24 [75]	20 [68]
		Compressor inlet		17 [63]	17 [63]	15 [59]
		Compressor shell bottom		47 [117]	47 [117]	42 [108]
	Indoor unit	LEV inlet		23 [73]	23 [73]	19 [66]
		Heat exchanger outlet		10 [50]	10 [50]	10 [50]

Operation				Outdoor unit model		
				PUHY-P288TSHMU-A		
				PUHY-P72THMU-A	PUHY-P96THMU-A	PUHY-P120THMU-A
Operating conditions	Ambient temperature	Indoor	DB/WB	26.7°C/19.4°C [80°F/67°F]		
		Outdoor		35°C/ - [95°F/ -]		
	Indoor unit	No. of connected units	Unit	6		
		No. of units in operation		6		
		Model		48/48/48/48/48/48		
	Piping	Main pipe	m [ft]	5 [16-3/8]		
		Branch pipe		10 [32-3/4]		
		Total pipe length		65 [213-1/4]		
	Fan speed		-	Hi		
	Amount of refrigerant		kg [lbs-oz]	34 [75]		
Outdoor unit	Electric current		A	68.3		
	Voltage		V	230		
	Compressor frequency		Hz	52	65	74
LEV opening	Indoor unit		Pulse	387/387/387/387/387/387		
	SC (LEV1)			141	185	185
	LEV2			1400	1400	1400
Pressure	High pressure (after O/S)/low pressure (before accumulator)		MPa [psi]	2.78/0.90 [403/131]	2.78/0.90 [403/131]	2.78/0.90 [403/131]
	Temp. of each section	Outdoor unit	Discharge (TH4)	°C [°F]	69 [156]	74 [165]
Heat exchanger outlet (TH3)			44 [111]		46 [115]	40 [104]
Accumulator inlet			10 [50]		10 [50]	10 [50]
Accumulator outlet			10 [50]		10 [50]	10 [50]
SCC outlet (TH6)			24 [75]		26 [79]	20 [68]
Compressor inlet			17 [63]		14 [57]	15 [59]
Compressor shell bottom			47 [117]		38 [100]	42 [108]
Indoor unit		LEV inlet	23 [73]		25 [77]	19 [66]
		Heat exchanger outlet	10 [50]		10 [50]	10 [50]

Operation				Outdoor unit model		
				PUHY-P312TSHMU-A		
				PUHY-P72THMU-A	PUHY-P120THMU-A	PUHY-P120THMU-A
Operating conditions	Ambient temperature	Indoor	DB/WB	26.7°C/19.4°C [80°F/67°F]		
		Outdoor		35°C/ - [95°F/ -]		
	Indoor unit	No. of connected units	Unit	6		
		No. of units in operation		6		
		Model		48/48/48/54/54/54		
	Piping	Main pipe	m [ft]	5 [16-3/8]		
		Branch pipe		10 [32-3/4]		
		Total pipe length		65 [213-1/4]		
	Fan speed		-	Hi		
	Amount of refrigerant		kg [lbs-oz]	34 [75]		
Outdoor unit	Electric current		A	73.2		
	Voltage		V	230		
	Compressor frequency		Hz	52	74	74
LEV opening	Indoor unit		Pulse	387/387/387/310/310/310		
	SC (LEV1)			141	185	185
	LEV2			1400	1400	1400
Pressure	High pressure (after O/S)/low pressure (before accumulator)		MPa [psi]	2.81/0.92 [408/133]	2.81/0.92 [408/133]	2.81/0.92 [408/133]
	Temp. of each section	Outdoor unit	Discharge (TH4)	°C [°F]	69 [156]	73 [163]
Heat exchanger outlet (TH3)			44 [111]		40 [104]	40 [104]
Accumulator inlet			10 [50]		10 [50]	10 [50]
Accumulator outlet			10 [50]		10 [50]	10 [50]
SCC outlet (TH6)			24 [75]		20 [68]	20 [68]
Compressor inlet			17 [63]		15 [59]	15 [59]
Compressor shell bottom			47 [117]		42 [108]	42 [108]
Indoor unit		LEV inlet	23 [73]		19 [66]	19 [66]
		Heat exchanger outlet	10 [50]		10 [50]	10 [50]

Operation				Outdoor unit model		
				PUHY-P336TSHMU-A		
				PUHY-P96THMU-A	PUHY-P120THMU-A	PUHY-P120THMU-A
Operating conditions	Ambient temperature	Indoor	DB/WB	26.7°C/19.4°C [80°F/67°F]		
		Outdoor		35°C/ - [95°F/ -]		
	Indoor unit	No. of connected units	Unit	6		
		No. of units in operation		6		
		Model		54/54/54/54/54/54		
	Piping	Main pipe	m [ft]	5 [16-3/8]		
		Branch pipe		10 [32-3/4]		
		Total pipe length		65 [213-1/4]		
	Fan speed		-	Hi		
	Amount of refrigerant		kg [lbs-oz]	37 [82]		
Outdoor unit	Electric current		A	82.2		
	Voltage		V	230		
	Compressor frequency		Hz	65	72	72
LEV opening	Indoor unit		Pulse	395/395/395/395/395/395		
	SC (LEV1)			171	171	171
	LEV2			1400	1400	1400
Pressure	High pressure (after O/S)/low pressure (before accumulator)		MPa [psi]	2.89/0.88 [419/128]	2.89/0.88 [419/128]	2.89/0.88 [419/128]
Temp. of each section	Outdoor unit	Discharge (TH4)	°C [°F]	74 [165]	73 [163]	73 [163]
		Heat exchanger outlet (TH3)		46 [115]	40 [104]	40 [104]
		Accumulator inlet		10 [50]	10 [50]	10 [50]
		Accumulator outlet		10 [50]	10 [50]	10 [50]
		SCC outlet (TH6)		26 [79]	20 [68]	20 [68]
		Compressor inlet		14 [57]	15 [59]	15 [59]
		Compressor shell bottom		38 [100]	42 [108]	42 [108]
	Indoor unit	LEV inlet		25 [77]	19 [66]	19 [66]
		Heat exchanger outlet		10 [50]	10 [50]	10 [50]

Operation				Outdoor unit model		
				PUHY-P360TSHMU-A		
				PUHY-P120THMU-A	PUHY-P120THMU-A	PUHY-P120THMU-A
Operating conditions	Ambient temperature	Indoor	DB/WB	26.7°C/19.4°C [80°F/67°F]		
		Outdoor		35°C/ - [95°F/ -]		
	Indoor unit	No. of connected units	Unit	7		
		No. of units in operation		7		
		Model		48/48/48/54/54/54/54		
	Piping	Main pipe	m [ft]	5 [16-3/8]		
		Branch pipe		10 [32-3/4]		
		Total pipe length		75 [246-1/16]		
	Fan speed		-	Hi		
	Amount of refrigerant		kg [lbs-oz]	39 [86]		
Outdoor unit	Electric current		A	87.1		
	Voltage		V	230		
	Compressor frequency		Hz	74	74	74
LEV opening	Indoor unit		Pulse	325/325/325/387/387/387/387		
	SC (LEV1)			171	171	171
	LEV2			1400	1400	1400
Pressure	High pressure (after O/S)/low pressure (before accumulator)		MPa [psi]	2.92/0.90 [424/131]	2.92/0.90 [424/131]	2.92/0.90 [424/131]
Temp. of each section	Outdoor unit	Discharge (TH4)	°C [°F]	73 [163]	73 [163]	73 [163]
		Heat exchanger outlet (TH3)		40 [104]	40 [104]	40 [104]
		Accumulator inlet		10 [50]	10 [50]	10 [50]
		Accumulator outlet		10 [50]	10 [50]	10 [50]
		SCC outlet (TH6)		20 [68]	20 [68]	20 [68]
		Compressor inlet		15 [59]	15 [59]	15 [59]
		Compressor shell bottom		42 [108]	42 [108]	42 [108]
	Indoor unit	LEV inlet		19 [66]	19 [66]	19 [66]
		Heat exchanger outlet		10 [50]	10 [50]	10 [50]

(2) Heating operation

Operation				Outdoor unit model		
				PUHY-P264TSHMU-A		
				PUHY-P72THMU-A	PUHY-P72THMU-A	PUHY-P120THMU-A
Operating conditions	Ambient temperature	Indoor	DB/WB	21.1°C / - [70°F / -]		
		Outdoor		8.3°C/6.1°C [47°F/43°F]		
	Indoor unit	No. of connected units	Unit	6		
		No. of units in operation		6		
		Model		-	36/36/48/48/48/48	
	Piping	Main pipe	m [ft]	5 [16-3/8]		
		Branch pipe		10 [32-3/4]		
		Total pipe length		65 [213-1/4]		
	Fan speed		-	Hi		
	Amount of refrigerant		kg [lbs-oz]	31 [68]		
Outdoor unit	Electric current		A	59.2		
	Voltage		V	230		
	Compressor frequency		Hz	53	53	77
LEV opening	Indoor unit		Pulse	332/332/406/406/406/406		
	SC (LEV1)			0	0	0
	LEV2			1400	1400	1400
Pressure	High pressure (after O/S)/low pressure (before accumulator)		MPa [psi]	2.63/0.66 [381/96]	2.63/0.66 [381/96]	2.63/0.66 [381/96]
	Temp. of each section	Outdoor unit	Discharge (TH4)	°C [°F]	72 [162]	72 [162]
Heat exchanger outlet (TH3)			0 [32]		0 [32]	-1 [30]
Accumulator inlet			0 [32]		0 [32]	-1 [30]
Accumulator outlet			0 [32]		0 [32]	-1 [30]
Compressor inlet			0 [32]		0 [32]	-1 [30]
Compressor shell bottom			40 [104]		40 [104]	40 [104]
Indoor unit		LEV inlet	36 [97]		36 [97]	36 [97]
		Heat exchanger inlet	70 [158]		70 [158]	69 [156]

Operation				Outdoor unit model		
				PUHY-P288TSHMU-A		
				PUHY-P72THMU-A	PUHY-P96THMU-A	PUHY-P120THMU-A
Operating conditions	Ambient temperature	Indoor	DB/WB	21.1°C/ - [70°F/ -]		
		Outdoor		8.3°C/6.1°C [47°F/43°F]		
	Indoor unit	No. of connected units	Unit	6		
		No. of units in operation		6		
		Model		48/48/48/48/48/48		
	Piping	Main pipe	m [ft]	5 [16-3/8]		
		Branch pipe		10 [32-3/4]		
		Total pipe length		65 [213-1/4]		
	Fan speed		-	Hi		
	Amount of refrigerant		kg [lbs-oz]	34 [75]		
Outdoor unit	Electric current		A	67.6		
	Voltage		V	230		
	Compressor frequency		Hz	53	71	75
LEV opening	Indoor unit		Pulse	332/332/406/406/406/406		
	SC (LEV1)			0		
	LEV2			1160	1280	1280
Pressure	High pressure (after O/S)/low pressure (before accumulator)		MPa [psi]	2.71/0.65 [394/95]	2.71/0.65 [394/95]	2.71/0.65 [394/95]
	Temp. of each section	Outdoor unit	Discharge (TH4)	°C [°F]	72 [162]	75 [167]
Heat exchanger outlet (TH3)			0 [32]		-2 [28]	-1 [30]
Accumulator inlet			0 [32]		-2 [28]	-1 [30]
Accumulator outlet			0 [32]		-2 [28]	-1 [30]
Compressor inlet			0 [32]		-2 [28]	-1 [30]
Compressor shell bottom			40 [104]		40 [104]	40 [104]
Indoor unit		LEV inlet	36 [97]		37 [99]	36 [97]
		Heat exchanger inlet	70 [158]		73 [163]	69 [156]

Operation				Outdoor unit model		
				PUHY-P312TSHMU-A		
				PUHY-P72THMU-A	PUHY-P120THMU-A	PUHY-P120THMU-A
Operating conditions	Ambient temperature	Indoor	DB/WB	21.1°C/ - [70°F/ -]		
		Outdoor		8.3°C/6.1°C [47°F/43°F]		
	Indoor unit	No. of connected units	Unit	6		
		No. of units in operation		6		
		Model		48/48/48/54/54/54		
	Piping	Main pipe	m [ft]	5 [16-3/8]		
		Branch pipe		10 [32-3/4]		
		Total pipe length		65 [213-1/4]		
	Fan speed		-	Hi		
	Amount of refrigerant		kg [lbs-oz]	34 [75]		
Outdoor unit	Electric current		A	69.5		
	Voltage		V	230		
	Compressor frequency		Hz	53	81	81
LEV opening	Indoor unit		Pulse	406/406/406/414/414/414		
	SC (LEV1)			0		
	LEV2			1160	1280	1280
Pressure	High pressure (after O/S)/low pressure (before accumulator)		MPa [psi]	2.66/0.66 [386/95]	2.66/0.66 [386/95]	2.66/0.66 [386/95]
	Temp. of each section	Outdoor unit	Discharge (TH4)	°C [°F]	72 [162]	70 [158]
Heat exchanger outlet (TH3)			0 [32]		-1 [30]	-1 [30]
Accumulator inlet			0 [32]		-1 [30]	-1 [30]
Accumulator outlet			0 [32]		-1 [30]	-1 [30]
Compressor inlet			0 [32]		-1 [30]	-1 [30]
Compressor shell bottom			40 [104]		40 [104]	40 [104]
Indoor unit		LEV inlet	36 [97]		36 [97]	36 [97]
		Heat exchanger inlet	70 [158]		69 [156]	69 [156]

Operation				Outdoor unit model		
				PUHY-P336TSHMU-A		
				PUHY-P96THMU-A	PUHY-P120THMU-A	PUHY-P120THMU-A
Operating conditions	Ambient temperature	Indoor	DB/WB	21.1°C / - [70°F / -]		
		Outdoor		8.3°C/6.1°C [47°F/43°F]		
	Indoor unit	No. of connected units	Unit	6		
		No. of units in operation		6		
		Model		54/54/54/54/54/54		
	Piping	Main pipe	m [ft]	5 [16-3/8]		
		Branch pipe		10 [32-3/4]		
		Total pipe length		65 [213-1/4]		
	Fan speed		-	Hi		
	Amount of refrigerant		kg [lbs-oz]	37 [82]		
Outdoor unit	Electric current		A	77.9		
	Voltage		V	230		
	Compressor frequency		Hz	71	74	74
LEV opening	Indoor unit		Pulse	414/414/414/414/414/414		
	SC (LEV1)			0		
	LEV2			1280	1280	1280
Pressure	High pressure (after O/S)/low pressure (before accumulator)		MPa [psi]	2.75/0.65 [399/94]	2.75/0.65 [399/94]	2.75/0.65 [399/94]
	Temp. of each section	Outdoor unit	Discharge (TH4)	°C [°F]	75 [167]	70 [158]
Heat exchanger outlet (TH3)			-2 [28]		-1 [30]	-1 [30]
Accumulator inlet			-2 [28]		-1 [30]	-1 [30]
Accumulator outlet			-2 [28]		-1 [30]	-1 [30]
Compressor inlet			-2 [28]		-1 [30]	-1 [30]
Compressor shell bottom			40 [104]		40 [104]	40 [104]
Indoor unit		LEV inlet	37 [99]		36 [97]	36 [97]
		Heat exchanger inlet	73 [163]		69 [156]	69 [156]

Operation				Outdoor unit model		
				PUHY-P360TSHMU-A		
				PUHY-P120THMU-A	PUHY-P120THMU-A	PUHY-P120THMU-A
Operating conditions	Ambient temperature	Indoor	DB/WB	21.1°C/ - [70°F/ -]		
		Outdoor		8.3°C/6.1°C [47°F/43°F]		
	Indoor unit	No. of connected units	Unit	7		
		No. of units in operation		7		
		Model		48/48/48/54/54/54/54		
	Piping	Main pipe	m [ft]	5 [16-3/8]		
		Branch pipe		10 [32-3/4]		
		Total pipe length		75 [246-1/16]		
	Fan speed		-	Hi		
	Amount of refrigerant		kg [lbs-oz]	39 [86]		
Outdoor unit	Electric current		A	79.7		
	Voltage		V	230		
	Compressor frequency		Hz	78	78	78
LEV opening	Indoor unit		Pulse	332/332/332/406/406/406/406		
	SC (LEV1)			0		
	LEV2			1280	1280	1280
Pressure	High pressure (after O/S)/low pressure (before accumulator)		MPa [psi]	2.70/0.65 [392/94]	2.70/0.65 [392/94]	2.70/0.65 [392/94]
	Temp. of each section	Outdoor unit	Discharge (TH4)	°C [°F]	70 [158]	70 [158]
Heat exchanger outlet (TH3)			-1 [30]		-1 [30]	-1 [30]
Accumulator inlet			-1 [30]		-1 [30]	-1 [30]
Accumulator outlet			-1 [30]		-1 [30]	-1 [30]
Compressor inlet			-1 [30]		-1 [30]	-1 [30]
Compressor shell bottom			40 [104]		40 [104]	40 [104]
Indoor unit		LEV inlet	36 [97]		36 [97]	36 [97]
		Heat exchanger inlet	69 [156]		69 [156]	69 [156]

IX Troubleshooting

[1] Error Code Lists	149
[2] Responding to Error Display on the Remote Controller	152
[3] Investigation of Transmission Wave Shape/Noise.....	231
[4] Troubleshooting Principal Parts	234
[5] Refrigerant Leak	265
[6] Compressor Replacement Instructions.....	267
[7] Troubleshooting Using the Outdoor Unit LED Error Display.....	269



[1] Error Code Lists

Error Code	Preliminary error code	Error (preliminary) detail code	Error code definition	Searched unit				Notes
				Outdoor unit	Indoor unit	LOSSNAY	Remote controller	
0403	4300 4305	01 05 (Note)	Serial communication error	O				
0900	-	-	Test run			O		
1102	1202	-	Discharge temperature fault	O				
1301	-	-	Low pressure fault	O				
1302	1402	-	High pressure fault	O				
1500	1600	-	Refrigerant overcharge	O				
-	1605	-	Preliminary suction pressure fault	O				
2500	-	-	Drain sensor submergence		O			
2502	-	-	Drain pump fault		O			
2503	-	-	Drain sensor (Thd) fault		O	O		
2600	-	-	Water leakage			O		
2601	-	-	Water supply cutoff			O		
4102	4152	-	Open phase	O				
4106	-	-	Transmission power supply fault	O				
4115	-	-	Power supply signal sync error	O				
4116	-	-	RPM error/Motor error		O	O		
4220 4225 (Note)	4320 4325 (Note)	[108]	Abnormal bus voltage drop	O				
		[109]	Abnormal bus voltage rise	O				
		[111]	Logic error	O				
		[131]	Low bus voltage at startup	O				
4230	4330	-	Heatsink overheat protection	O				
4240	4340	-	Overload protection	O				
4250 4255 (Note)	4350 4355 (Note)	[101]	IPM error	O				
		[104]	Short-circuited IPM/Ground fault	O				
		[105]	Overcurrent error due to short-circuited motor	O				
		[106]	Instantaneous overcurrent	O				
		[107]	Overcurrent	O				
4260	-	-	Heatsink overheat protection at startup	O				
5101	1202	-	Temperature sensor fault		O			
			Return air temperature (TH21)					
			OA processing unit inlet temperature (TH4)			O		

Error Code	Preliminary error code	Error (preliminary) detail code	Error code definition		Searched unit				Notes
					Outdoor unit	Indoor unit	LOSSNAY	Remote controller	
5102	1217	-	Temperature sensor fault	Indoor unit pipe temperature (TH22)		O			
				OA processing unit pipe temperature (TH2)			O		
				HIC bypass circuit outlet temperature (TH2)	O				
5103	1205	00	Temperature sensor fault	Indoor unit gas-side pipe temperature (TH23)		O			
				OA processing unit gas-side pipe temperature (TH3)			O		
				Pipe temperature at heatexchanger outlet (TH3)	O				
5104	1202	-	Temperature sensor fault	OA processing unit intake air temperature (TH1)			O		
				Outside temperature (TH24)		O			Detectable only by the All-Fresh type indoor units
				Outdoor unit discharge temperature (TH4)	O				
5105	1204	-	Temperature sensor fault	Accumulator inlet temperature (TH5)	O				
5106	1216	-	Temperature sensor fault	HIC circuit outlet temperature (TH6)	O				
5107	1221	-	Temperature sensor fault	Outside temperature (TH7)	O				
5110	1214	01	Temperature sensor fault	Heatsink temperature (THHS)	O				
5201	-	-	High-pressure sensor fault (63HS1)		O				
5301	4300	[115]	ACCT sensor fault		O				
		[117]	ACCT sensor circuit fault		O				
		[119]	Open-circuited IPM/Loose ACCT connector		O				
		[120]	Faulty ACCT wiring		O				
5701	-	-	Loose float switch connector			O			
6201	-	-	Remote controller board fault (nonvolatile memory error)					O	
6202	-	-	Remote controller board fault (clock IC error)					O	
6600	-	-	Address overlap		O	O	O	O	
6601	-	-	Polarity setting error		O				
6602	-	-	Transmission processor hardware error		O	O	O	O	
6603	-	-	Transmission line bus busy error		O	O	O	O	
6606	-	-	Communication error between device and transmission processors		O	O	O	O	
6607	-	-	No ACK error		O	O	O	O	

Error Code	Preliminary error code	Error (preliminary) detail code	Error code definition	Searched unit				Notes
				Outdoor unit	Indoor unit	LOSSNAY	Remote controller	
6608	-	-	No response error	○	○	○	○	
6831	-	-	MA controller signal reception error (No signal reception)		○		○	
6832	-	-	MA remote controller signal transmission error (Synchronization error)		○		○	
6833	-	-	MA remote controller signal transmission error (Hardware error)		○		○	
6834	-	-	MA controller signal reception error (Start bit detection error)		○		○	
7100	-	-	Total capacity error	○				
7101	-	-	Capacity code setting error	○	○	○		
7102	-	-	Wrong number of connected units	○				
7105	-	-	Address setting error	○				
7106	-	-	Attribute setting error			○		
7110	-	-	Connection information signal transmission/reception error	○				
7111	-	-	Remote controller sensor fault		○	○		
7113	-	-	Function setting error	○				
7117	-	-	Model setting error	○				
7130	-	-	Incompatible unit combination	○				

Note

The last digit in the check error codes in the 4000's and 5000's and two-digit detail codes indicate if the codes apply to compressor inverter or fan inverter.

Example

Code 4225 (detail code 108): Bus voltage drop in the fan inverter system

Code 4230 : Heatsink overheat protection in the compressor inverter system

The last digit	Inverter system
0 or 1	Compressor inverter system
5	Fan inverter system

[2] Responding to Error Display on the Remote Controller

1. Error Code

0403 (THMU-A)

Serial communication error

2. Error definition and error detection method

Serial communication error between the control board and the INV board on the compressor, and between the control board and the Fan board

Detail code 01: Between the control board and the INV board

Detail code 05: Between the control board and the Fan board

3. Cause, check method and remedy

(1) Faulty wiring

Check the following wiring connections.

1) Between Control board and Fan board

Control board	FAN board
CN2	CN21
CN4	CN4
CN332	CN18V

2) Between Fan board and INV board

FAN board	INV board
CN22	CN2 CN5V
CN4	CN4

(2) INV board failure, Fan board failure and Control board failure

Replace the INV board or the Fan board or control board when the power turns on automatically, even if the power source is reset.

Note

Refer to section -6- "Inverter (THMU-A)" under part [4] Troubleshooting Principal Parts for error codes related to the inverter.(page 244)

1. Error Code

0403 (YHMU-A)

Serial communication error

2. Error definition and error detection method

Serial communication error between the control board and the INV board on the compressor, and between the control board and the Fan board

Detail code 01: Between the control board and the INV board

Detail code 05: Between the control board and the Fan board

3. Cause, check method and remedy

(1) Faulty wiring

Check the following wiring connections.

1) Between Control board and Fan board

Control board	FAN board
CN2	CN21
CN4	CN5
CN332	CN18V

2) Between Fan board and INV board

FAN board	INV board
CN22	CN2 CN5V
CN4	CN4

(2) INV board failure, Fan board failure and Control board failure

Replace the INV board or the Fan board or control board when the power turns on automatically, even if the power source is reset.

Note

Refer to section -6- "Inverter (YHMU-A)" under part [4] Troubleshooting Principal Parts for error codes related to the inverter.(page 252)

1. Error Code

1102

Discharge temperature fault

2. Error definition and error detection method

- 1) If the discharge temperature of 120 °C [248°F] or more is detected during the above operation (the first detection), the outdoor unit stops once, turns to anti-restart mode for 3 minutes, and restarts after 3 minutes automatically.
- 2) If the discharge temperature of 120° C [248°F] or more is detected again (the second detection) within 30 minutes after the second stop of the outdoor unit described above, the mode will be changed to 3 - minute restart mode, then the outdoor unit will restart in 3 minutes.
- 3) If the discharge temperature of 120°C [248°F] or more is detected (the 30th detection) within 30 minutes after the stop of the outdoor unit described above (regardless of the first or the 29th stop), the outdoor unit will make an error stop, and the error code "1102" will be displayed.
- 4) If the discharge temperature of 120°C [248°F] or more is detected more than 30 minutes after the previous stop of the outdoor unit, the detection is regarded as the first detection, and the operation described in step 1 above will start.
- 5) For 30 minutes after the stop (the first stop or the second stop) of the outdoor unit, preliminary errors will be displayed on the LED display.

3. Cause, check method and remedy

Cause	Check method and remedy
(1) Gas leak, gas shortage	Refer to the page on refrigerant amount evaluation.(page 117)
(2) Overload operation	Check operating conditions and operation status of indoor/ outdoor units.
(3) LEV failure on the indoor unit (4) Outdoor unit LEV1 actuation failure Outdoor unit LEV2a, b actuation failure	Perform a cooling or heating operation to check the operation. Cooling: Indoor unit LEV LEV1 LEV2a,b Heating: Indoor unit LEV LEV2a,b Refer to the section on troubleshooting the LEV.(page 238)
(5) Closed refrigerant service valve	Confirm that the refrigerant service valve is fully open.
(6) Outdoor fan (including fan parts) failure, motor failure, or fan controller malfunction Rise in discharge temp. by low pressure drawing for (3) - (6).	Check the fan on the outdoor unit. Refer to the section on troubleshooting the outdoor unit fan.(page 237)
(7) Gas leak between low and high pressures (4-way valve failure, Compressor failure, Solenoid valve (SV1a) failure)	Perform a cooling or heating operation and check the operation.
(8) Thermistor failure (TH4)	Check the thermistor resistor.(page 185)
(9) Input circuit failure on the controller board thermistor	Check the inlet air temperature on the LED monitor.

1. Error Code

1301

Low pressure fault

2. Error definition and error detection method

When starting the compressor from Stop Mode for the first time if low pressure reads 0.098MPa [14psi] immediately before start-up, the operation immediately stops.

3. Cause, check method and remedy

Cause	Check method and remedy
(1) Inner pressure drop due to a leakage.	Refer to the section on troubleshooting the low pressure sensor.(page 235)
(2) Low pressure sensor failure	
(3) Short-circuited pressure sensor cable due to torn outer rubber	
(4) A pin on the male connector is missing.	
(5) Disconnected wire	
(6) Failure of the low pressure input circuit on the controller board	

1. Error Code

1302

High pressure fault 1 (Outdoor unit)

2. Error definition and error detection method

- 1) If the pressure of 3.78MPa [548psi] or higher is detected by the pressure sensor during operation (the first detection), the outdoor stops once, turns to antirestart mode for 3 minutes, and restarts after 3 minutes automatically.
- 2) If the pressure of 3.78MPa [548psi] or higher is detected by the pressure sensor again (the second detection) within 30 minutes after the first stop of the outdoor unit, the outdoor unit stops once, turns to anti-restart mode for 3 minutes, and restarts after 3 minutes automatically.
- 3) If the pressure of 3.87MPa [561psi] or higher is detected by the pressure sensor (the third detection) within 30 minutes of the second stop of the outdoor unit, the outdoor unit will make an error stop, and the error code "1302" will be displayed.
- 4) If the pressure of 3.78MPa [548psi] or higher is detected more than 30 minutes after the stop of the outdoor unit, the detection is regarded as the first detection, and the operation described in step 1 above will start.
- 5) For 30 minutes after the stop of the outdoor unit, preliminary errors will be displayed on the LED display.
- 6) The outdoor unit makes an error stop immediately when not only the pressure sensor but also the pressure switch detects $4.15^{+0,-0.15}$ MPa [$601^{+0,-22}$ psi]
- 7) Open phase due to unstable power supply voltage may cause the pressure switch to malfunction or cause the units to come to an abnormal stop.

3. Cause, check method and remedy

Cause	Check method and remedy	
(1) Indoor unit LEV2a, b actuation failure -> Cooling Indoor unit LEV actuation failure -> Heating	Perform a cooling or heating operation to check the operation. Cooling: Indoor unit LEV2a, b Heating: Indoor unit LEV Refer to the section on troubleshooting the LEV.(page 238)	
(2) Closed refrigerant service valve	Confirm that the refrigerant service valve is fully open.	
(3) Short cycle on the indoor unit side	Check the indoor units for problems and correct them, if any.	
(4) Clogged filter on the indoor unit		
(5) Reduced air flow due to dirty fan on the indoor unit fan		
(6) Dirty heat exchanger of the indoor unit		
(7) Indoor fan (including fan parts) failure or motor failure Rise in high pressure caused by lowered condensing capacity in heating operation for (2) - (7).		
(8) Short cycle on the outdoor unit		Check the outdoor units for problems and correct them, if any.
(9) Dirty heat exchanger of the outdoor unit		
(10) Outdoor fan (including fan parts) failure, motor failure, or fan controller malfunction Rise in discharge temp. by low pressure drawing for (8) - (10).	Check the fan on the outdoor unit. Refer to the section on troubleshooting the outdoor unit fan.(page 237)	
(11) Solenoid valve (SV1a) malfunction (The by-pass valve (SV1a) can not control rise in high pressure).	Refer to the section on troubleshooting the solenoid valve.	
(12) Thermistor failure (TH3, TH7)	Check the thermistor resistor.(page 185)	
(13) Pressure sensor failure	Refer to the page on the troubleshooting of the high pressure sensor. (page 234)	
(14) Failure of the thermistor input circuit and pressure sensor input circuit on the controller board	Check the temperature and the pressure of the sensor with LED monitor.	
(15) Thermistor mounting problem (TH3, TH7)	Check the temperature and the pressure of the sensor with LED monitor.	
(16) Disconnected male connector on the pressure switch (63H1) or disconnected wire		
(17) Voltage drop caused by unstable power supply voltage	Check the input voltage at the power supply terminal block (TB1).	

1. Error Code

1302

High pressure fault 2 (Outdoor unit)

2. Error definition and error detection method

If the pressure of 0.098MPa [14psi] or lower is registered on the pressure sensor immediately before start-up, it will trigger an abnormal stop, and error code "1302" will be displayed.

3. Cause, check method and remedy

Cause		Check method and remedy
(1)	Inner pressure drop due to a leakage.	Refer to the page on the troubleshooting of the high pressure sensor.(page 234)
(2)	Pressure sensor failure	
(3)	Shorted-circuited pressure sensor cable due to torn outer rubber	
(4)	A pin on the male connector on the pressure sensor is missing or contact failure	
(5)	Disconnected pressure sensor cable	
(6)	Failure of the pressure sensor input circuit on the controller board	

1. Error Code

1500

Refrigerant overcharge

2. Error definition and error detection method

An error can be detected by the discharge temperature superheat (TdSH).

- 1) If the formula " $TdSH \leq 10^{\circ}C [18^{\circ}F]$ " is satisfied during operation (first detection), the outdoor unit stops, goes into the 3-minute restart mode, and starts up in three minutes.
- 2) If a TdSH of $10^{\circ}C [18^{\circ}F]$ or below is detected again (second detection) within 30 minutes of the first stoppage of the outdoor unit as described above, the outdoor unit stops again, goes into the 3-minute restart mode, and restarts after three minutes.
- 3) If a TdSH of $10^{\circ}C [18^{\circ}F]$ or below is detected (sixth detection) within 30 minutes of the fifth stoppage of the outdoor unit as described above, the unit comes to an abnormal stop, and "1500" appears on the display.
- 4) If a TdSH of $10^{\circ}C [18^{\circ}F]$ or below is detected after 30 minutes have elapsed after a stoppage of the outdoor unit, the unit will follow the same sequence as the first detection of the condition as described in section 1) above.
- 5) The period of 30 minutes after a stoppage of the outdoor unit is regarded as a preliminary error, and a preliminary error code appears on the LED display.

3. Cause, check method and remedy

Cause		Check method and remedy
(1)	Overcharged refrigerant	Refer to the page on refrigerant amount evaluation.(page 117)
(2)	Thermistor input circuit failure on the control board	Check the temperature and pressure readings on the sensor that are displayed on the LED monitor.
(3)	Faulty mounting of thermistor (TH4)	Check the temperature and pressure readings on the thermistor that are displayed on the LED monitor.
(4)	Outdoor unit LEV2a, b actuation failure -> Heating	Refer to the section on troubleshooting the LEV. (page 238)

1. Error Code

2500

Drain sensor submergence (Models with a drain sensor)

2. Error definition and error detection method

- 1) If an immersion of the drain sensor in the water is detected while the unit is in any mode other than the Cool/Dry mode and when the drain pump goes from OFF to ON, this condition is considered preliminary water leakage. While this error is being detected, humidifier output cannot be turned on.(Applicable to the units manufactured in or after October 2006)
- 2) If the immersion of the sensor in the water is detected four consecutive times at an hour interval, this is considered water leakage, and "2500" appears on the monitor.
- 3) Detection of water leakage is also performed while the unit is stopped.
- 4) Preliminary water leakage is cancelled when the following conditions are met:
 - ♦One hour after the preliminary water leakage was detected, it is not detected that the drain pump goes from OFF to ON.
 - ♦The operation mode is changed to Cool/Dry.
 - ♦The liquid pipe temperature minus the inlet temperature is -10°C [-18°F] or less.

3. Cause, check method and remedy

Cause	Check method and remedy
(1) Drain water drainage problem ♦Clogged drain pump ♦Clogged drain piping ♦Backflow of drain water from other units	Check for proper drainage.
(2) Adhesion of water drops to the drain sensor ♦Trickling of water along the lead wire ♦Rippling of drain water caused by filter clogging	1) Check for proper lead wire installation. 2) Check for clogged filter.
(3) Failure of the relay circuit for the solenoid valve	Replace the relay.
(4) Indoor unit control board failure ♦Drain sensor circuit failure	If the above item checks out OK, replace the indoor unit control board.

1. Error Code

2500

Drain sensor submergence (Models with a float switch)

2. Error definition and error detection method

- 1) If an immersion of the float switch in the water is detected while the unit is in any mode other than the Cool/Dry mode and when the drain pump goes from OFF to ON, this condition is considered preliminary water leakage. While this error is being detected, humidifier output cannot be turned on.
- 2) If the drain pump turns on within one hour after preliminary water leakage is detected and the above-mentioned condition is detected two consecutive times, water leakage error water leakage is detected, and "2500" appears on the monitor.
- 3) Detection of water leakage is also performed while the unit is stopped.
- 4) Preliminary water leakage is cancelled when the following conditions are met:
 - ♦One hour after the preliminary water leakage was detected, it is not detected that the drain pump goes from OFF to ON.
 - ♦The operation mode is changed to Cool/Dry.
 - ♦The liquid pipe temperature minus the inlet temperature is - 10°C [-18°F] or less.

3. Cause, check method and remedy

Cause	Check method and remedy
(1) Drain water drainage problem ♦Clogged drain pump ♦Clogged drain piping ♦Backflow of drain water from other units	Check for proper drainage.
(2) Stuck float switch Check for slime in the moving parts of the float switch.	Check for normal operation of the float switch.
(3) Float switch failure	Check the resistance with the float switch turned on and turned off.

<Reference>

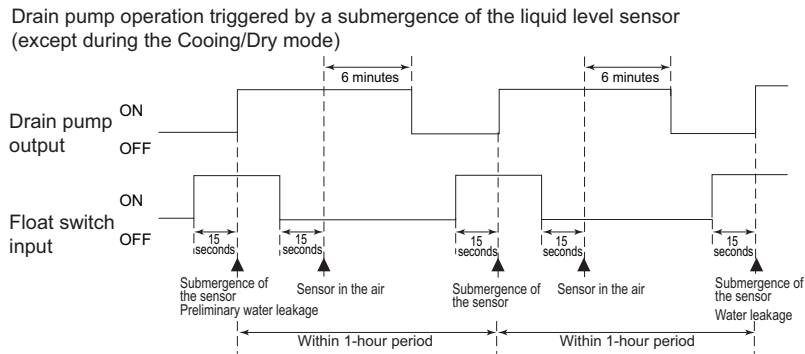

1. Error Code

2502

Drain pump fault (Models with a drain sensor)

2. Error definition and error detection method

- 1) Make the drain sensor thermistor self-heat. If the temperature rise is small, it is interpreted that the sensor is immersed in water. This condition is considered to be a preliminary error, and the unit goes into the 3-minute restart delay mode.
- 2) If another episode of the above condition is detected during the preliminary error, this is considered a drain pump error, and "2502" appears on the monitor.
- 3) This error is always detected while the drain pump is in operation.
- 4) The following criteria are met when the criteria for the forced stoppage of outdoor unit (system stoppage) are met.
 - *"Liquid pipe temperature - inlet temperature \leq -10°C [-18 °F] " has been detected for 30 minutes.
 - *The immersion of drain sensor is detected 10 consecutive times.
 - *The conditions that are listed under items 1) through 3) above are always met before the criteria for the forced stoppage of the outdoor unit.
- 5) The indoor unit that detected the conditions that are listed in item 4) above brings the outdoor unit in the same refrigerant circuit to an error stop (compressor operation prohibited), and the outdoor unit brings all the indoor units in the same refrigerant circuit that are in any mode other than Fan or Stop to an error stop. "2502" appears on the monitor of the units that came to an error stop.
- 6) Forced stoppage of the outdoor unit
 Detection timing: The error is detected whether the unit is in operation or stopped.
- 7) Ending criteria for the forced stoppage of outdoor unit
 Power reset the indoor unit that was identified as the error source and the outdoor unit that is connected to the same refrigerant circuit.
 Forced stoppage of the outdoor unit cannot be cancelled by stopping the unit via the remote controller.
 (Note) Items 1) - 3) and 4) - 7) are detected independently from each other.

Note

The address and attribute that appear on the remote controller are those of the indoor unit (or OA processing unit) that caused the error.

3. Cause, check method and remedy

Cause	Check method and remedy
(1) Drain pump failure	Check for proper functioning of the drain pump.
(2) Drain water drainage problem ♦Clogged drain pump ♦Clogged drain piping	Check for proper drainage.
(3) Adhesion of water drops to the drain sensor ♦Trickling of water along the lead wire ♦Rippling of drain water caused by filter clogging	1) Check for proper lead wire installation. 2) Check for clogged filter.
(4) Indoor unit control board failure ♦Drain pump drive circuit failure ♦Drain heater output circuit failure	If the above item checks out OK, replace the indoor unit control board.
(5) Items (1) through (4) above and an indoor unit electronic valve closure failure (leaky valve) occurred simultaneously.	Check the solenoid valves on the indoor unit for leaks.

1. Error Code

2502

Drain pump fault (Models with a float switch)

2. Error definition and error detection method

- 1) The immersion of sensor tip in water is detected by the ON/OFF signal from the float switch.
 - *Submergence of the sensor
When it is detected that the float switch has been ON for 15 seconds, it is interpreted that the sensor tip is immersed in water.
 - *Sensor in the air
When it is detected that the float switch has been OFF for 15 seconds, it is interpreted that the sensor tip is not immersed in water.
- 2) If it is detected that the float switch has been ON for 3 minutes after the immersion of the sensor tip was detected, this is considered a drain pump failure, and "2502" appears on the monitor.
 - *The total time it takes for this error to be detected is 3 minutes and 15 seconds, including the time it takes for the first immersion of the sensor tip to be detected.
- 3) Detection of drain pump failure is performed while the unit is stopped.
- 4) The following criteria are met when the criteria for the forced stoppage of outdoor unit (system stoppage) are met.
 - *"Liquid pipe temperature - inlet temperature \leq - 10°C [-18°F] " has been detected for 30 minutes.
 - *It is detected by the float switch that the sensor tip has been immersed in water for 15 minutes or more.
 - *The conditions that are listed under items 1) through 3) above are always met before the criteria for the forced stoppage of the outdoor unit.
- 5) The indoor unit that detected the conditions that are listed in item 4) above brings the outdoor unit in the same refrigerant circuit to an error stop (compressor operation prohibited), and the outdoor unit brings all the indoor units in the same refrigerant circuit that are in any mode other than Fan or Stop to an error stop.
- 6) Forced stoppage of the outdoor unit
Detection timing: The error is detected whether the unit is in operation or stopped.
This error is detected whether the unit is in operation or stopped.
- 7) Ending criteria for the forced stoppage of outdoor unit
Power reset the indoor unit that was identified as the error source and the outdoor unit that is connected to the same refrigerant circuit.
Forced stoppage of the outdoor unit cannot be cancelled by stopping the unit via the remote controller.
(Note) Items 1) - 3) and 4) - 7) are detected independently from each other.

Note

The address and attribute that appear on the remote controller are those of the indoor unit (or OA processing unit) that caused the error.

3. Cause, check method and remedy

Cause	Check method and remedy
(1) Drain pump failure	Check for proper functioning of the drain pump mechanism
(2) Drain water drainage problem •Clogged drain pump •Clogged drain piping	Check for proper drainage.
(3) Stuck float switch Check for slime in the moving parts of the float switch.	Check for normal operation of the float switch.
(4) Float switch failure	Check the resistance with the float switch turned on and turned off.
(5) Indoor unit control board failure •Drain pump drive circuit failure •Float switch input circuit failure	Replace indoor unit control board.
(6) Items (1) through (5) above and an indoor unit electronic valve closure failure (leaky valve) occurred simultaneously.	Check the solenoid valves on the indoor unit for leaks.

1. Error Code

2503

Drain sensor (Thd) fault

2. Error definition and error detection method

- ♦If the open or short circuit of the thermistor has been detected for 30 seconds, this condition is considered to be a preliminary error, and the unit goes into the 3-minute restart delay mode.
- ♦If another episode of the above condition is detected during the preliminary error, this is considered a drain sensor error.(If the short or open circuit of the thermistor is no longer detected, normal operation will be restored in 3 minutes.)
- ♦This error is detected when one of the following conditions are met.
 - *During Cool/Dry operation
 - *Liquid pipe temperature minus inlet temperature is equal to or smaller than - 10°C [-18°F] (except during the defrost cycle)
 - *When the liquid temperature thermistor or suction temperature thermistor or short or open circuited.
 - *Drain pump is in operation.
 - *One hour has elapsed since the drain sensor went off.
 - Short: 90°C [194 °F] or above
 - Open: - 20°C [-4 °F] or below

3. Cause, check method and remedy

Cause	Check method and remedy
(1) Faulty connector (CN31) insertion.	1) Check for connector connection failure. Reinsert the connector, restart the operation, and check for proper operation.
(2) Broken or semi-broken thermistor wire	2) Check for a broken thermistor wire.
(3) Thermistor failure	3) Check the resistance of the thermistor. 0°C[32 °F]:6.0kΩ 10°C[50 °F]:3.9kΩ 20°C[68°F]:2.6kΩ 30°C[86°F]:1.8kΩ 40°C[104 °F]:1.3kΩ
(4) Indoor unit control board (error detection circuit) failure	4) Replace the indoor unit control board if the problem recurs when the unit is operated with the No.-1 and No.-2 pins on the drain sensor connector (CN31) being short-circuited. If the above item checks out OK, there are no problems with the drain sensor. Turn off the power and turn it back on.

1. Error Code

2600

Water leakage

2. Cause, check method and remedy

Check that water does not leak from the pipes in such as the humidifier.

1. Error Code

2601

Water supply cutoff

2. Cause, check method and remedy

Cause	Check method and remedy
(1) The water tank of the humidifier is empty.	Check the amount of supply water. Check for the solenoid valve and for the connection.
(2) The solenoid valve for humidification is OFF.	Check the connector.
(3) Disconnected float switch	Check the connecting part.
(4) Poor operation of float switch	Check for the float switch.
(5) Frozen water tank	Turn off the power source of the water tank to defrost, and turn it on again.

1. Error Code

4102 (THMU-A)

Open phase

2. Error definition and error detection method

- ♦An open phase of the power supply (L1 phase, L2 phase) was detected at power on.
- ♦The L3 phase current is outside of the specified range.

Note

The open phase of the power supply may not always be detected if a power voltage from another circuit is applied.

3. Cause, check method and remedy

Cause	Check method and remedy
(1) Power supply problem ♦Open phase voltage of the power supply ♦Power supply voltage drop	Check the input voltage to the power supply terminal block TB1.
(2) Noise filter problem ♦Coil problem ♦Circuit board failure	♦Check the coil connections. ♦Check for coil burnout. ♦Confirm that the voltage at the CN02 connector is 188 V or above.
(3) Wiring failure	Confirm that the voltage at the control board connector CNAC is 188 V or above. If the voltage is below 188V, check the wiring connection between the noise filter board CN02 and control board CNAC. P72 and P96 models Confirm that the wiring between TB23 and INV board SC-T is put through CT3. P120 model Confirm that the wiring between the coil L3 and TB23 is put through ACCT3.
(4) Blown fuse	Check that F01 on the control board is not blown. ->If a blown fuse is found, check for a short-circuiting or earth fault of the actuator.
(5) CT3 failure	P72 and P96 models Replace the inverter if this problem is detected after the compressor has gone into operation. P120 model Replace the ACCT3 if this problem is detected after the compressor has gone into operation.
(6) Control board failure	Replace the control board if none of the above is causing the problem.

1. Error Code

4102 (YHMU-A)

Open phase

2. Error definition and error detection method

- ♦An open phase of the power supply (L1 phase, L2 phase) was detected at power on.
- ♦The L3 phase current is outside of the specified range.

Note

The open phase of the power supply may not always be detected if a power voltage from another circuit is applied.

3. Cause, check method and remedy

Cause	Check method and remedy
(1) Power supply problem ♦Open phase voltage of the power supply ♦Power supply voltage drop	Check the input voltage to the power supply terminal block TB1.
(2) Noise filter problem ♦Coil problem ♦Circuit board failure	♦Check the coil connections. ♦Check for coil burnout. ♦Check that the voltage across TB21 and TB22 on the noise filter board is 414V or above.
(3) Wiring failure	Confirm that the voltage at the control board connector CNAC is 190 V or above. If the voltage is below 190, check the wiring between noise filter CN6, noise filter CN2, transformer box, and control board CNAC. Confirm that the wiring between noise filter TB23 and INV board SC-L3 is put through CT3.
(4) Blown fuse	Check F01 on the control board, F4, and F5 for a blown fuse. ->If a blown fuse is found, check for a short-circuiting or earth fault of the actuator.
(5) CT3 failure	Replace the inverter if this problem is detected after the compressor has gone into operation.
(6) Control board failure	Replace the control board if none of the above is causing the problem.

1. Error Code

4106

<Transmission power supply fault error detail FF (Outdoor unit)>

2. Error definition and error detection method

Transmission power output failure

3. Cause

- 1) Wiring failure
- 2) Transmission power supply cannot output voltage because overcurrent was detected.
- 3) Voltage cannot be output due to transmission power supply problem.
- 4) Transmission voltage detection circuit failure

4. Check method and remedy

Check the items in IX [4] -7- (2) Troubleshooting transmission power circuit of outdoor unit on all outdoor units in the same refrigerant circuit.

<Transmission power supply fault other than error detail code FF (Outdoor unit)>

2. Error definition and error detection method

Transmission power reception failure

3. Cause

One of the outdoor units stopped supplying power, but no other outdoor units start supplying power.

4. Check method and remedy

Check the items in IX [4] -7- (2) Troubleshooting transmission power circuit of outdoor unit on all outdoor units in the same refrigerant circuit.

1. Error Code

4115 (THMU-A)

Power supply signal sync error

2. Error definition and error detection method

The frequency cannot be determined when the power is switched on.

3. Cause, check method and remedy

Cause	Check method and remedy
(1) Power supply error	Check the voltage of the power supply terminal block (TB1).
(2) Noise filter problem •Coil problem •Circuit board failure	•Check the coil connections. •Check for coil burnout. •Confirm that the voltage at the CN02 connector is 188 V or above.
(3) Faulty wiring	Check fuse F01 on the control board (or F1, F2).
(4) Wiring failure Between noise filter board CN02 and control board CNAC	Confirm that the voltage at the control board connector CNAC is 188 V or above.
(5) Control board failure	If none of the items described above is applicable, and if the trouble reappears even after the power is switched on again, replace the control board.

1. Error Code

4115 (YHMU-A)

Power supply signal sync error

2. Error definition and error detection method

The frequency cannot be determined when the power is switched on.

3. Cause, check method and remedy

Cause	Check method and remedy
(1) Power supply error	Check the voltage of the power supply terminal block (TB1).
(2) Noise filter problem •Coil problem •Circuit board failure	•Check the coil connections. •Check for coil burnout. •Check that the voltage across TB21 and TB22 on the noise filter board is 414V or above.
(3) Faulty wiring	Check F01 on the control board, F4, and F5 for a blown fuse.
(4) Wiring failure Between noise filter CN3, noise filter CN2, transformer box, and control board CNAC	Confirm that the voltage at the control board connector CNAC is 190 V or above.
(5) Control board failure	If none of the items described above is applicable, and if the trouble reappears even after the power is switched on again, replace the control board.

1. Error Code

4116

RPM error/Motor error

2. Error definition and error detection method

♦LOSSNAY

- *The motor keep running even if the power is OFF.
- *The thermal overload relay is ON. (Only for the three-phase model)

♦Indoor unit

If detected less than 180rpm or more than 2000rpm, the indoor unit will restart and keep running for 3 minutes.If detected again, the display will appear.

3. Cause, check method and remedy

Cause		Check method and remedy
(1)	Board failure	Replace the board.
(2)	Motor malfunction	Check for the motor and the solenoid switch.
(3)	Solenoid switch malfunction	

1. Error Code

4220 4225	(THMU-A)
----------------------------	-----------------

Abnormal bus voltage drop (Detail code 108)

2. Error definition and error detection method

If Vdc 160V or less is detected during Inverter operation. (S/W detection)

3. Cause, check method and remedy

(1) Power supply environment

Check whether the unit makes an instantaneous stop when the detection result is abnormal or a power failure occurs.
Check whether the power voltage is 188V or less across all phases.

(2) Voltage drop detected

4220

P72 and P96 models

♦Check the voltage between the tab terminal TB-P and TB-N on the INV board while the inverter is stopped. -> Check the following items if it is 253V or above.

1) Confirm on the LED monitor that the bus voltage is above 160 V.

Replace the INV board if it is below 160 V.

2) Check the voltage at CN505 on the control board. ->Go to (3).

3) Check the coil connections (L1 - L3) and for coil burnout.

4) Check the wiring connections between the following sections

Between the noise filter board and INV board. Between the INV board and DCL. Between the INV board and C1.

Replace 72C if no problems are found.-> Check the following items if the voltage is below 253V.

1) Check the coil connections (L1 - L3) and for coil burnout.

2) Check the wiring between the noise filter board and INV board.

3) Check the connection to SC-P1 and SC-P2 on the INV board.

4) Check the in-rush current resistor value. Replace the INV board if no problems are found.

P120 model

♦Check the voltage between SC-P1 and IPM N terminals on the INV board while the inverter is stopped.

-> Check the following items if it is 253V or above.

1) Confirm on the LED monitor that the bus voltage is above 160 V.

Replace the INV board if it is below 160 V.

2) Check the voltage at CN505 on the control board. ->Go to (3).

3) Check the coil connections (L1 - L3) and coil burnout.

4) Check the resistance of the diode stack. ->Refer to [4] -6- (6).(page 251)

5) Check the wiring connections between the following sections:

Between the noise filter board and INV board. Between the INV board and C1.

Replace the noise filter board if no problems are found.

-> Check the following items if the voltage is below 253 V.

1) Check the connection to SC-P1 and IPM N on the INV board.

2) Check the wiring between the noise filter board and INV board.

3) Check the resistance of the diode stack. ->Refer to [4] -6- (6).(page 251)

4) Check the in-rush current resistor value. ->Refer to [4] -6- (4).(page 249)

5) Replace the noise filter board.

4225

♦Check the voltage at CNVDC on the Fan board while the inverter is stopped.

->Check the following items if it is 253 V or above.

1) Check the voltage at CN505 on the control board. ->Go to 3).

2) Check the coil connections (L1 - L3) and for coil burnout.

3) Check the wiring connections.

Replace 72C if no problems are found.

(P120 model: Replace the noise filter board.)

If the problem recurs after replacing 72C, replace the Fan board.

-> Check the following items if the voltage is below 253V.

1) Check the CNVDC connector connection.

(3) Control board failure

Confirm that a voltage of 208-230 VAC is applied to the connector CN505 on the control board during inverter operation.

->If voltage is absent, check the fuse F01. If no problems are found, replace the control board.

Note

Refer to section -6- "Inverter (THMU-A)" under part [4] Troubleshooting Principal Parts for error codes related to the inverter.(page 244)

1. Error Code

4220 4225	(YHMU-A)
----------------------------	-----------------

Abnormal bus voltage drop (Detail code 108)

2. Error definition and error detection method

If Vdc 289V or less is detected during Inverter operation. (S/W detection)

3. Cause, check method and remedy

(1) Power supply environment

Check whether the unit makes an instantaneous stop when the detection result is abnormal or a power failure occurs.
Check whether the power voltage (Between L1 and L2, L2 and L3, and L1 and L3) is 414V or less across all phases.

(2) Voltage drop detected

4220

♦Check the voltage between the FT-P and FT-N terminals on the INV board while the inverter is stopped and if it is 420 V or above, check the following items.

1) Confirm on the LED monitor that the bus voltage is above 289V.

Replace the INV board if it is below 289 V.

2) Check the voltage at CN72 on the control board. ->Go to (3).

3) Check the noise filter coil connections and for coil burnout.

4) Check the wiring connections between the following sections

Between the noise filter board and INV board. Between the INV board and DCL.

Replace 72C if no problems are found.

5) Check the IGBT module resistance on the INV board (Refer to the Trouble shooting for IGBT module).

♦Check the voltage between the FT-P and FT-N terminals on the INV board while the inverter is stopped and if it is less than 420 V, check the following items.

1) Check the coil connections and for coil burnout on the noise filter.

2) Check the wiring between the noise filter board and INV board.

3) Check the connection to SCP1 and SC-P2 on the INV board.

4) Check the in-rush current resistor value.

5) Check the 72C resistance value.

6) Check the DCL resistance value.

Replace the INV board if no problems are found.

4225

♦Check the voltage at CNVDC on the Fan board while the inverter is stopped and if it is 420 V or above, check the following items.

1) Check the voltage at CN72 on the control board. ->Go to 3).

2) Check the noise filter coil connections and for coil burnout.

3) Check the wiring connections between the following sections

Between the INV board and the Fan board.

4) Check contents 4220

Replace the Fan board if no problems are found.

♦Check the voltage at CNVDC on the Fan board while the inverter is stopped and if it is less than 420 V, check the following items.

1) Check the state of the wiring connections between the INV board and the Fan board.

2) Check contents 4220

Replace the Fan board if no problems are found.

(3) Control board failure

Check that 12VDC is applied to connector CN72 on the control board while the inverter is operating. If voltage is absent or the wrong voltage is applied, check the fuse F01. Replace the control board if no problems are found with the fuse.

Note

Refer to section -6- "Inverter (YHMU-A)" under part [4] Troubleshooting Principal Parts for error codes related to the inverter.(page 252)

1. Error Code

4220
4225 (THMU-A)

Abnormal bus voltage rise (Detail code 109)

2. Error definition and error detection method

If $V_{dc} \geq 400V$ is detected during inverter operation.

3. Cause, check method and remedy

(1) Different voltage connection

Check the power supply voltage on the power supply terminal block (TB1).

(2) INV board failure

If the problem recurs, replace the INV board.

In the case of 4220: INV board

In the case of 4225: Fan board

Note

Refer to section -6- "Inverter (THMU-A)" under part [4] Troubleshooting Principal Parts for error codes related to the inverter.(page 244)

1. Error Code

4220
4225 (YHMU-A)

Abnormal bus voltage rise (Detail code 109)

2. Error definition and error detection method

If $V_{dc} \geq 830V$ is detected during inverter operation.

3. Cause, check method and remedy

(1) Different voltage connection

Check the power supply voltage on the power supply terminal block (TB1).

(2) INV board failure

If the problem recurs, replace the INV board.

In the case of 4220: INV board

In the case of 4225: Fan board

Note

Refer to section -6- "Inverter (YHMU-A)" under part [4] Troubleshooting Principal Parts for error codes related to the inverter.(page 252)

1. Error Code

4220
4225

(THMU-A) (P120 model)

VDC error (Detail code 110)

2. Error definition and error detection method

Bus voltage abnormality If $V_{dc} \geq 400V$ or $V_{dc} \leq 160V$ is detected. (H/W detection)

3. Cause, check method and remedy

Same as detail code No.108 and 109 of 4220 error

Note

Refer to section -6- "Inverter (THMU-A)" under part [4] Troubleshooting Principal Parts for error codes related to the inverter.(page 244)

1. Error Code

4220 4225	(THMU-A)
----------------------------	-----------------

Logic error (Detail code 111)

2. Error definition and error detection method

H/W error

If only the H/W error logic circuit operates, and no identifiable error is detected.

3. Cause, Check method and remedy

In the case of 4220

Cause	Check method and remedy
(1) External noise	
(2) INV board failure	Refer to IX [4] -6- (2) [1].(page 246)
(3) IPM failure (P120 model only)	Replace the IPM.
(4) DCCT failure (P120 model only)	Replace the DCCT.

In the case of 4225

Cause	Check method and remedy
(1) External noise	
(2) Fan board failure	Refer to IX [4] -6- (2) [6].(page 247)

Note

Refer to section -6- "Inverter (THMU-A)" under part [4] Troubleshooting Principal Parts for error codes related to the inverter.(page 244)

1. Error Code

4220 4225	(YHMU-A)
----------------------------	-----------------

Logic error (Detail code 111)

2. Error definition and error detection method

H/W error
 If only the H/W error logic circuit operates, and no identifiable error is detected.

3. Cause, Check method and remedy

In the case of 4220

Cause	Check method and remedy
(1) External noise	
(2) INV board failure	Refer to IX [4] -6- (2) [1].(page 254)

In the case of 4225

Cause	Check method and remedy
(1) External noise	
(2) Fan board failure	Refer to IX [4] -6- (2) [6].(page 255)

Note

Refer to section -6- "Inverter (YHMU-A)" under part [4] Troubleshooting Principal Parts for error codes related to the inverter.(page 252)

1. Error Code

4220 4225	(YHMU-A)
----------------------------	-----------------

Low bus voltage at startup (Detail code 131)

2. Error definition and error detection method

When $V_{dc} \leq 160$ V is detected just before the inverter operation.

3. Cause, check method and remedy

(1) Inverter main circuit failure

Same as detail code 108 of 4220 error

Note

Refer to section -6- "Inverter (YHMU-A)" under part [4] Troubleshooting Principal Parts for error codes related to the inverter.(page 252)

1. Error Code

4230 (THMU-A)

Heatsink overheat protection

2. Error definition and error detection method

When the heat sink temperature (THHS) remains at or above TOH is detected.

Model	TOH
P72, P96 models	100°C [212°F]
P120 model	90°C [194°F]

3. Cause, check method and remedy

Cause	Check method and remedy
(1) Fan board failure	Refer to IX [4] -6- (2) [6].(page 247)
(2) Outdoor unit fan failure	Check the outdoor unit fan operation. If any problem is found with the fan operation, check the fan motor. ->Refer to IX [4] -6- (2) [5].(page 247)
(3) Air passage blockage	Check that the heat sink cooling air passage is not blocked
(4) THHS failure	<p>P72 and P96 models</p> <ol style="list-style-type: none"> 1) Check for proper installation of the INV board IGBT. (Check for proper installation of the IGBT heatsink.) 2) Check for proper installation of the INV board IGBT. ->If an abnormal value appears, replace the INV board. <p>P120 model</p> <ol style="list-style-type: none"> 3) Check the THHS sensor reading on the LED monitor. ->If an abnormal value appears, check the sensor resistance, and replace the sensor as necessary.

Note

Refer to section -6- "Inverter (THMU-A)" under part [4] Troubleshooting Principal Parts for error codes related to the inverter.(page 244)

1. Error Code

4230 (YHMU-A)

Heatsink overheat protection

2. Error definition and error detection method

When the heat sink temperature (THHS) remains at or above 100°C [212°F] is detected.

3. Cause, check method and remedy

Cause	Check method and remedy
(1) Fan board failure	Refer to IX [4] -6- (2) [6].(page 255)
(2) Outdoor unit fan failure	Check the outdoor unit fan operation. If any problem is found with the fan operation, check the fan motor. ->Refer to IX [4] -6- (2) [5].(page 255)
(3) Air passage blockage	Check that the heat sink cooling air passage is not blocked
(4) THHS failure	1) Check for proper installation of the INV board IGBT. (Check for proper installation of the IGBT heatsink.) 2) Check the THHS sensor reading on the LED monitor. ->If an abnormal value appears, replace the INV board.

Note

Refer to section -6- "Inverter (YHMU-A)" under part [4] Troubleshooting Principal Parts for error codes related to the inverter.(page 252)

1. Error Code

4240 (THMU-A)

Overload protection

2. Error definition and error detection method

If the output current of "(Iac) > I_{max} (Arms)" or "THHS > TOL" is continuously detected for 10 minutes or more during inverter operation.

Model	I _{max} (Arms)
P72, P96 models	35
P120 model	53

Model	TOL
P72, P96 models	95°C [203°F]
P120 model	80°C [175°F]

3. Cause, check method and remedy

Cause	Check method and remedy
(1) Air passage blockage	Check that the heat sink cooling air passage is not blocked
(2) Power supply environment	Power supply voltage is 188 V or above.
(3) Inverter failure	Refer to IX [4] -6-(page 244)
(4) Current sensor (ACCT) failure	Refer to IX [4] -6- (4).
(5) Compressor failure	Check that the compressor has not overheated during operation. -> Check the refrigerant circuit (oil return section). Refer to IX [4] -6- (2) [2].(page 246)

Note

Refer to section -6- "Inverter (THMU-A)" under part [4] Troubleshooting Principal Parts for error codes related to the inverter.(page 244)

1. Error Code

4240 (YHMU-A)

Overload protection

2. Error definition and error detection method

If the output current of "(Iac) > I_{max} (Arms)" or "THHS > 95°C [203°F]" is continuously detected for 10 minutes or more during inverter operation.

Model	I _{max} (Arms)
P72, P96 models	19
P120 model	27

3. Cause, check method and remedy

Cause	Check method and remedy
(1) Air passage blockage	Check that the heat sink cooling air passage is not blocked
(2) Power supply environment	Power supply voltage is 414 V or above.
(3) Inverter failure	Refer to IX [4] -6-.(page 252)
(4) Compressor failure	Check that the compressor has not overheated during operation. -> Check the refrigerant circuit (oil return section). Refer to IX [4] -6- (2) [2].(page 254)

Note

Refer to section -6- "Inverter (YHMU-A)" under part [4] Troubleshooting Principal Parts for error codes related to the inverter.(page 252)

1. Error Code

4250 4255	(THMU-A)
----------------------------	-----------------

IPM error (Detail code 101)

2. Error definition and error detection method

In the case of 4250

P72, P96 models

Overcurrent is detected by the overcurrent detection resistor (RSH) on the INVboard.

P120 model

IPM error signal is detected.

In the case of 4255

IPM error signal is detected.

3. Cause, check method and remedy

In the case of 4250

P72 and P96 models

Cause	Check method and remedy
(1) Inverter output related	Refer to IX [4] -6- (2) [1] - [4].(page 246)

P120 model

Cause	Check method and remedy
(1) Inverter output related	Refer to IX [4] -6- (2) [1] - [4].(page 246)
(2) Same as 4230 error	Same as 4230 error

In the case of 4255

Cause	Check method and remedy
(1) Fan motor abnormality	Refer to IX [4] -6- (2) [5].(page 247)
(2) Fan board failure	Refer to IX [4] -6- (2) [6].(page 247)

Note

Refer to section -6- "Inverter (THMU-A)" under part [4] Troubleshooting Principal Parts for error codes related to the inverter.(page 244)

1. Error Code

4250 4255	(YHMU-A)
----------------------------	-----------------

IPM error (Detail code 101)

2. Error definition and error detection method

In the case of 4250

Overcurrent is detected by the overcurrent detection resistor (RSH) on the INV board.

In the case of 4255

IPM error signal is detected.

3. Cause, check method and remedy

In the case of 4250

Cause	Check method and remedy
(1) Inverter output related	Refer to IX [4] -6- (2) [1] - [4].(page 254) Check the IGBT module resistance value of the INV board, if no problems are found. (Refer to the Trouble shooting for IGBT module)

In the case of 4255

Cause	Check method and remedy
(1) Fan motor abnormality	Refer to IX [4] -6- (2) [5].(page 255)
(2) Fan board failure	Refer to IX [4] -6- (2) [6].(page 255)

Note

Refer to section -6- "Inverter (YHMU-A)" under part [4] Troubleshooting Principal Parts for error codes related to the inverter.(page 252)

1. Error Code

4250 (THMU-A)

ACCT overcurrent (H/W detection) (Detail code 102)
DCCT overcurrent (H/W detection) (Detail code 103)
Instantaneous overcurrent (Detail code 106)
Overcurrent (Detail code 107)

2. Error definition and error detection method

P76 and P96 models

Overcurrent 88 Apeak or 42 Arms and above is detected by the current sensor.

P120 model

Overcurrent 128 Apeak or 60 Arms and above is detected by the current sensor.

3. Cause, check method and remedy

Cause	Check method and remedy
(1) Inverter output related	Refer to IX [4] -6- (2) [1] - [4].(page 246)

Note

Refer to section -6- "Inverter (THMU-A)" under part [4] Troubleshooting Principal Parts for error codes related to the inverter.(page 244)

1. Error Code

4250 (YHMU-A)

**Instantaneous overcurrent (Detail code 106)
Overcurrent (Detail code 107)**

2. Error definition and error detection method

P72 and P96 models

Overcurrent 94 Apeak or 22 Arms and above is detected by the current sensor.

P120 model

Overcurrent 94 Apeak or 35 Arms and above is detected by the current sensor.

3. Cause, check method and remedy

Cause	Check method and remedy
(1) Inverter output related	Refer to IX [4] -6- (2) [1] - [4].(page 254) Check the IGBT module resistance value of the INV board, if no problems are found. (Refer to the Trouble shooting for IGBT module)

Note

Refer to section -6- "Inverter (YHMU-A)" under part [4] Troubleshooting Principal Parts for error codes related to the inverter.(page 252)

1. Error Code

**4250
4255**

Short-circuited IPM/Ground fault (Detail code 104)

2. Error definition and error detection method

When IPM/IGBT short damage or grounding on the load side is detected just before starting the inverter.

3. Cause, check method and remedy

In the case of 4250

Cause	Check method and remedy
(1) Grounding fault compressor	Refer to IX [4] -6- (2) [2].
(2) Inverter output related	Refer to IX [4] -6- (2) [1] - [4].

In the case of 4255

Cause	Check method and remedy
(1) Grounding fault of fan motor	Refer to IX [4] -6- (2) [5].
(2) Fan board failure	Refer to IX [4] -6- (2) [6].

Note

Refer to section -6- "Inverter" under part [4] Troubleshooting Principal Parts for error codes related to the inverter.

1. Error Code

4250 4255

Overcurrent error due to short-circuited motor (Detail code 105)

2. Error definition and error detection method

When a short is detected on the load side just before starting the inverter operation.

3. Cause, Check method and remedy

In the case of 4250

Cause	Check method and remedy
(1) Short - circuited compressor	Refer to IX [4] -6- (2) [2].
(2) Output wiring	Check for a short circuit.

In the case of 4255

Cause	Check method and remedy
(1) Short - circuited fan motor	Refer to IX [4] -6- (2) [5].
(2) Output wiring	Check for a short circuit.

Note

Refer to section -6- "Inverter" under part [4] Troubleshooting Principal Parts for error codes related to the inverter.

1. Error Code

4260	(THMU-A)
-------------	-----------------

Heatsink overheat protection at startup

2. Error definition and error detection method

The heatsink temperature (THHS) remains at or above TOH for 10 minutes or more at inverter startup.

Model	TOH
P72, P96 models	100°C [212°F]
P120 model	90°C [194°F]

3. Cause, check method and remedy

Same as 4230 error

1. Error Code

4260	(YHMU-A)
-------------	-----------------

Heatsink overheat protection at startup

2. Error definition and error detection method

The heatsink temperature (THHS) remains at or above 100°C [212°F] for 10 minutes or more at inverter startup.

3. Cause, check method and remedy

Same as 4230 error

1. Error Code

5101

Return air temperature sensor (TH21) fault (Indoor unit)
Return air temperature sensor (TH4) fault (OA processing unit)

5102

Pipe temperature sensor (TH22) fault (Indoor unit)
Pipe temperature sensor (TH2) fault (OA processing unit)

5103

Gas-side pipe temperature sensor (TH23) fault (Indoor unit)
Gas-side pipe temperature sensor (TH3) fault (OA processing unit)

5104

Intake air temperature sensor (TH1) fault (OA processing unit)
Intake air temperature sensor (TH24) fault (All-fresh (100% outdoor air) type indoor unit)

2. Error definition and error detection method

♦If a short or an open is detected during thermostat ON, the outdoor unit turns to anti-restart mode for 3 minutes. When the error is not restored after 3 minutes (if restored, the outdoor unit runs normally), the outdoor unit makes an error stop.

Short: detectable at 90°C [194°F] or higher

Open: detectable at -40°C [-40°F] or lower

♦Sensor error at gas-side cannot be detected under the following conditions.

*During heating operation

*During cooling operation for 3 minutes after the compressor turns on.

3. Cause, check method and remedy

Cause	Check method and remedy
(1) Thermistor failure	Check the thermistor resistor.
(2) Connector contact failure	0°C [32°F]: 15 kohm
(3) Disconnected wire or partial disconnected thermistor wire	10°C [50°F]: 9.7 kohm
(4) Unattached thermistor or contact failure	20°C [68°F]: 6.4 kohm
	30°C [86°F]: 4.3 kohm
	40°C [104°F]: 3.1 kohm
(5) Indoor board (detection circuit) failure	Check the connector contact.
	When no fault is found, the indoor board is a failure.

1. Error Code

5102

HIC bypass circuit outlet temperature sensor (TH2) fault (Outdoor unit)

5103

Heat exchanger outlet temperature sensor (TH3) fault (Outdoor unit)

5104

Discharge temperature sensor (TH4) fault (Outdoor unit)

5105

Accumulator inlet temperature sensor (TH5) fault (Outdoor unit)

5106

HIC circuit outlet temperature sensor (TH6) fault (Outdoor unit)

5107

Outside temperature sensor (TH7) fault (Outdoor unit)

2. Error definition and error detection method

- ♦When a short (high temperature intake) or an open (low temperature intake) of the thermistor is detected (the first detection), the outdoor unit stops, turns to anti-restart mode for 3 minutes, and restarts when the detected temperature of the thermistor.
- ♦When a short or an open is detected again (the second detection) after the first restart of the outdoor unit, the outdoor unit stops, turns to anti-restart mode for 3 minutes, and restarts in 3 minutes when the detected temperature is within the normal range.
- ♦When a short or an open is detected again (the third detection) after the previous restart of the outdoor unit, the outdoor unit makes an error stop.
- ♦When a short or an open of the thermistor is detected just before the restart of the outdoor unit, the outdoor unit makes an error stop, and the error code "5102", "5103", "5104", "5105", "5106" or "5107" will appear.
- ♦During 3-minute antirestart mode, preliminary errors will be displayed on the LED display.
- ♦A short or an open described above is not detected for 10 minutes after the compressor start, during defrost mode, or for 3 minutes after defrost mode.

3. Cause, check method and remedy

Cause	Check method and remedy
(1) Thermistor failure	Check thermistor resistance.
(2) Pinched lead wire	Check for pinched lead wire.
(3) Torn wire coating	Check for wire coating.
(4) A pin on the male connector is missing or contact failure	Check connector.
(5) Disconnected wire	Check for wire.
(6) Thermistor input circuit failure on the control board	Check the intake temperature of the sensor with the LED monitor. When the temperature is far different from the actual temperature, replace the control board.

<Reference>

	Short detection	Open detection
TH2	70 °C [158 °F] and above (0.4 k Ω)	-40 °C [-40 °F] and below (130 k Ω)
TH3	110 °C [230 °F] and above (0.4 k Ω)	-40 °C [-40 °F] and below (130 k Ω)
TH4	240 °C [464 °F] and above (0.57 k Ω)	0 °C [32 °F] and below (698 k Ω)
TH5	70 °C [158 °F] and above (0.4 k Ω)	-40 °C [-40 °F] and below (130 k Ω)
TH6	70 °C [158 °F] and above (1.14 k Ω)	-40 °C [-40 °F] and below (130 k Ω)
TH7	110 °C [230 °F] and above (0.4 k Ω)	-40 °C [-40 °F] and below (130 k Ω)

1. Error Code

5110 (THMU-A) (P120 model only)

Heatsink temperature sensor (THHS) fault (Detail code 01)

2. Error definition and error detection method

When a short or an open of THHS is detected just before or during the inverter operation.

3. Cause, check method and remedy

P72 and P96 models

Cause	Check method and remedy
(1) INV board failure	If the problem recurs when the unit is put into operation, replace the INV board.

P120 model

Cause	Check method and remedy
(1) THHS sensor failure	Check the THHS sensor reading on the LED monitor. Replace the sensor if it reads below - 30°C[-22°F] or above 150°C[302°F].
(2) Contact failure	Check the connector connection (CNTH) on the INV board.

Note

Refer to section -6- "Inverter (THMU-A)" under part [4] Troubleshooting Principal Parts for error codes related to the inverter.(page 244)

1. Error Code

5110 (YHMU-A)

Heatsink temperature sensor (THHS) fault (Detail code 01)

2. Error definition and error detection method

When a short or an open of THHS is detected just before or during the inverter operation.

3. Cause, check method and remedy

Cause	Check method and remedy
(1) INV board failure	If the problem recurs when the unit is put into operation, replace the INV board.

Note

Refer to section -6- "Inverter (YHMU-A)" under part [4] Troubleshooting Principal Parts for error codes related to the inverter.(page 252)

1. Error Code

5201

High-pressure sensor fault (63HS1)

2. Error definition and error detection method

- If the high pressure sensor detects 0.098MPa [14psi] or less during the operation, the outdoor unit stops once, turns to anti-restart mode for 3 minutes, and restarts after 3 minutes when the detected high pressure sensor is 0.098MPa [14psi] or more.
- If the high pressure sensor detects 0.098MPa [14psi] or less just before the restart, the outdoor unit makes an error stop, and the error code "5201" will appear.
- During 3-minute antirestart mode, preliminary errors will be displayed on the LED display.
- A error is not detected for 3 minutes after the compressor start, during defrost operation, or 3 minutes after defrost operation.

3. Cause, check method and remedy

Cause	Check method and remedy
(1) High pressure sensor failure	Refer to the page on the troubleshooting of the high pressure sensor. (IX [4] -1- (page 234))
(2) Pressure drop due to refrigerant leak	
(3) Torn wire coating	
(4) A pin on the male connector is missing or contact failure	
(5) Disconnected wire	
(6) High pressure sensor input circuit failure on the control board	

1. Error Code

5301 (THMU-A)

ACCT sensor fault (Detail code 115)

2. Error definition and error detection method

When the formula "output current < 2 Arms" remains satisfied for 10 seconds while the inverter is in operation.

3. Cause, check method and remedy

P72 and P96 models

Cause	Check method and remedy
(1) Inverter open output phase	Check the output wiring connections.
(2) Compressor failure	Refer to IX [4] -6- (2) [2].(page 246)
(3) INV board failure	Refer to IX [4] -6- (2) [1], [3], [4].(page 246)

P120 model

Cause	Check method and remedy
(1) Inverter open output phase	Check the output wiring connections.
(2) Compressor failure	Refer to IX [4] -6- (2) [2].(page 246)
(3) INV board failure	Refer to IX [4] -6- (2) [1], [3], [4].(page 246)
(4) Contact failure	Check the connection of the connector (CNCT2) on the INV board-INV board.
(5) ACCT sensor failure	Refer to IX [4] -6- (4).

Note

Refer to section -6-"Inverter (THMU-A)" under part [4] Troubleshooting Principal Parts for error codes related to the inverter.(page 244)

1. Error Code

5301 (YHMU-A)

ACCT sensor fault (Detail code 115)

2. Error definition and error detection method

When the formula "output current < 1.5 Arms" remains satisfied for 10 seconds while the inverter is in operation.

3. Cause, check method and remedy

Cause	Check method and remedy
(1) Inverter open output phase	Check the output wiring connections.
(2) Compressor failure	Refer to IX [4] -6- (2) [2].(page 254)
(3) INV board failure	Refer to IX [4] -6- (2) [1], [3], [4].(page 254)

Note

Refer to section -6-"Inverter (YHMU-A)" under part [4] Troubleshooting Principal Parts for error codes related to the inverter.(page 252)

1. Error Code

5301 (THMU-A) (P120 model only)

DCCT sensor fault (Detail code116)

2. Error definition and error detection method

When the bus current less than 18 Apeak is detected at startup (6Hz)

3. Cause, check method and remedy

Cause	Check method and remedy
(1) Contact failure	Check the contact of the connector (CNCT) on the INV board, and the contact the connector on DCCT side.
(2) Misorientation	Check the installation direction of DCCT.
(3) DCCT sensor failure	Replace the DCCT sensor.
(4) INV board failure	Replace the INV board.

Note

Refer to section -6-"Inverter (THMU-A)" under part [4] Troubleshooting Principal Parts for error codes related to the inverter.(page 244)

1. Error Code

5301

ACCT sensor circuit fault (Detail code 117)

2. Error definition and error detection method

When an error value is detected with the ACCT detection circuit just before the inverter starts

3. Cause, check method and remedy

Cause	Check method and remedy
(1) INV board failure	Refer to IX [4] -6- (2) [1], [3], [4].
(2) Compressor failure	Refer to IX [4] -6- (2) [2].

Note

Refer to section -6-"Inverter" under part [4] Troubleshooting Principal Parts for error codes related to the inverter.

1. Error Code

5301 (THMU-A) (P120 model only)

DCCT sensor circuit fault (Detail code118)

2. Error definition and error detection method

When an error value is detected with the DCCT detection circuit just before the inverter starts

3. Cause, check method and remedy

Cause	Check method and remedy
(1) Contact failure	Check for good contact of the INV board connector CNCT and the connector on the DCCT side.
(2) INV board failure	Refer to IX [4] -6- (2) [1], [3], [4].(page 246)
(3) DCCT sensor failure	Replace the DCCT sensor.
(4) Compressor failure	Refer to IX [4] -6- (2) [2].(page 246)
(5) Inverter failure	Refer to IX [4] -6-.(page 244)

Note

Refer to section -6- "Inverter (THMU-A)" under part [4] Troubleshooting Principal Parts for error codes related to the inverter.(page 244)

1. Error Code

5301 (THMU-A)

Open-circuited IPM/Loose ACCT connector (Detail code 119)

2. Error definition and error detection method

Presence of enough current cannot be detected during the self-diagnostic operation immediately before inverter startup.

3. Cause, check method and remedy

P72 and P96 models

Cause	Check method and remedy
(1) Inverter output wiring problem	Check output wiring connections. Confirm that the U- and W-phase output cables are put through CT12 and CT22 on the INV board respectively.
(2) Inverter failure	Refer to IX [4] -6- (2) [3], [4].(page 247)
(3) Compressor failure	Refer to IX [4] -6- (2) [2].(page 246)

P120 model

Cause	Check method and remedy
(1) ACCT sensor disconnection	Check the connection of the connector (CNCT2) on the INV board. Check for proper mounting of ACCT.
(2) ACCT sensor failure	Refer to IX [4] -6- (4).(page 249)
(3) Inverter failure	Refer to IX [4] -6- (2) [3], [4].(page 247)
(4) Compressor failure	Refer to IX [4] -6- (2) [2].(page 246)

Note

Refer to section -6- "Inverter (THMU-A)" under part [4] Troubleshooting Principal Parts for error codes related to the inverter.(page 244)

1. Error Code

5301 (YHMU-A)

Open-circuited IPM/Loose ACCT connector (Detail code 119)

2. Error definition and error detection method

Presence of enough current cannot be detected during the self-diagnostic operation immediately before inverter startup.

3. Cause, check method and remedy

Cause	Check method and remedy
(1) Inverter output wiring problem	Check output wiring connections. Confirm that the U- and W-phase output cables are put through CT12 and CT22 on the INV board respectively.
(2) Inverter failure	Refer to IX [4] -6- (2) [3], [4].(page 255)
(3) Compressor failure	Refer to IX [4] -6- (2) [2].(page 254)

Note

Refer to section -6- "Inverter (YHMU-A)" under part [4] Troubleshooting Principal Parts for error codes related to the inverter.(page 252)

1. Error Code

5301 (THMU-A)

Faulty ACCT wiring (Detail code 120)

2. Error definition and error detection method

Presence of target current cannot be detected during the self-diagnostic operation immediately before startup. (Detection of improperly mounted ACCT sensor)

3. Cause, check method and remedy

P72 and P96 models

Cause	Check method and remedy
(1) Inverter output wiring problem	Check output wiring connections. Confirm that the U- and W-phase output cables are put through CT12 and CT22 on the INV board respectively.
(2) Inverter failure	Refer to IX [4] -6- (2) [3], [4].(page 247)
(3) Compressor failure	Refer to IX [4] -6- (2) [2].(page 246)
(4) INV board failure	Replace the INV board.

P120 model

Cause	Check method and remedy
(1) Wrongly mounted ACCT sensor	Check for proper mounting of ACCT. Refer to IX [4] -6- (4).
(2) ACCT sensor failure	Refer to IX [4] -6- (4).(page 249)
(3) Inverter failure	Refer to IX [4] -6- (2) [3], [4].(page 247)
(4) Compressor failure	Refer to IX [4] -6- (2) [2].(page 246)

Note

Refer to section -6- "Inverter (THMU-A)" under part [4] Troubleshooting Principal Parts for error codes related to the inverter.(page 244)

1. Error Code

5301 (YHMU-A)

Faulty ACCT wiring (Detail code 120)

2. Error definition and error detection method

Presence of target current cannot be detected during the self-diagnostic operation immediately before startup.

3. Cause, check method and remedy

Cause	Check method and remedy
(1) Inverter output wiring problem	Check output wiring connections. Confirm that the U- and W-phase output cables are put through CT12 and CT22 on the INV board respectively.
(2) Inverter failure	Refer to IX [4] -6- (2) [3], [4].(page 255)
(3) Compressor failure	Refer to IX [4] -6- (2) [2].(page 254)

Note

Refer to section -6- "Inverter (YHMU-A)" under part [4] Troubleshooting Principal Parts for error codes related to the inverter.(page 252)

1. Error Code

5701

Loose float switch connector

2. Error definition and error detection method

Detection of the disconnected float switch (open-phase condition) during operation

3. Cause, check method and remedy

(1) CN4F disconnection or contact failure

Check for disconnection of the connector (CN4F) on the indoor unit control board.

1. Error Code

6201

Remote controller board fault (nonvolatile memory error)

2. Error definition and error detection method

This error is detected when the data cannot be read out from the built-in nonvolatile memory on the remote controller.

3. Cause, check method and remedy

(1) Remote controller failure

Replace the remote controller.

1. Error Code

6202

Remote controller board fault (clock IC error)

2. Error definition and error detection method

This error is detected when the built-in clock on the remote controller is not properly functioning.

3. Cause, check method and remedy

(1) Remote controller failure

Replace the remote controller.

1. Error Code

6600

Address overlap

2. Error definition and error detection method

An error in which signals from more than one indoor units with the same address are received

Note

The address and attribute that appear on the remote controller indicate the controller that detected the error.

3. Cause, check method and remedy

Cause	Check method and remedy
Two or more of the following have the same address: Outdoor units, indoor units, LOSSNAY units, controllers such as M-NET remote controllers. <Example> 6600 "01" appears on the remote controller Unit #01 detected the error. Two or more units in the system have 01 as their address.	Find the unit that has the same address as that of the error source. Once the unit is found, correct the address. Then, turn off the outdoor units, indoor units, and LOSSNAY units, keep them all turned off for at least five minutes, and turn them back on.

1. Error Code

6601

Polarity setting error

2. Error definition and error detection method

The error detected when transmission processor cannot distinguish the polarities of the M-NET transmission line.

3. Cause, check method and remedy

Cause	Check method and remedy
(1) No voltage is applied to the M-NET transmission line that G(B)-50A is connected to.	Check if power is supplied to the M-NET transmission line of the G(B)-50A, and correct any problem found.
(2) M-NET transmission line to which G(B)-50A is connected is short-circuited.	

1. Error Code

6602

Transmission processor hardware error

2. Error definition and error detection method

Although "0" was surely transmitted by the transmission processor, "1" is displayed on the transmission line.

Note

The address/attribute appeared on the display on the remote controller indicates the controller where an error occurred.

3. Cause

- 1) When the wiring work of or the polarity of either the indoor or outdoor transmission line is performed or is changed while the power is on, the transmitted data will collide, the wave shape will be changed, and an error will be detected.
- 2) Grounding fault of the transmission line
- 3) When grouping the indoor units that are connected to different outdoor units, the male power supply connectors on the multiple outdoor units are connected to the female power supply switch connector (CN40).
- 4) When the power supply unit for transmission lines is used in the system connected with MELANS, the male power supply connector is connected to the female power supply switch connector (CN40) on the outdoor unit.
- 5) Controller failure of the source of the error
- 6) When the transmission data is changed due to the noise on the transmission line
- 7) Voltage is not applied on the transmission line for centralized control (in case of grouped indoor units connected to different outdoor units or in case of the system connected with MELANS)

4. Check method and remedy

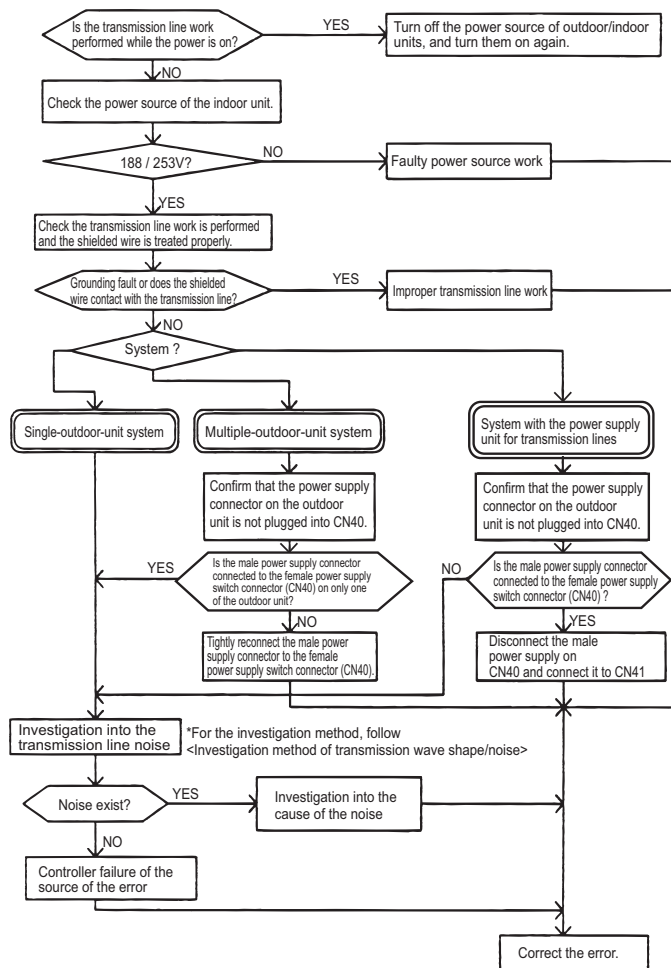

1. Error Code

6603

Transmission line bus busy error

2. Error definition and error detection method

- ♦Generated error when the command cannot be transmitted for 4-10 minutes in a row due to bus-busy
- ♦Generated error when the command cannot be transmitted to the transmission line for 4-10 minutes in a row due to noise

Note

The address/attribute appeared on the display on the remote controller indicates the controller where an error occurred.

3. Cause, check method and remedy

Cause	Check method and remedy
(1) The transmission processor cannot be transmitted as the short-wavelength voltage like noise exists consecutively on the transmission line.	No noise indicates that the error source controller is a failure. If noise exists, investigate the noise. -> No noise indicates that the error source controller is a failure. -> If noise exists, investigate the noise.
(2) Error source controller failure	

1. Error Code

6606

Communication error between device and transmission processors

2. Error definition and error detection method

Communication error between the main microcomputer on the indoor unit board and the microcomputer for transmission

Note

The address/attribute appeared on the display on the remote controller indicates the controller where an error occurred.

3. Cause, check method and remedy

Cause	Check method and remedy
(1) Data is not properly transmitted due to accidental erroneous operation of the controller of the error source.	Turn off the power source of the outdoor and the indoor units.(When the power source is turned off separately, the microcomputer will not be reset, and the error will not be corrected.) -> If the same error occurs, the error source controller is a failure.
(2) Error source controller failure	

1. Error Code

6607

No ACK error

2. Error definition and error detection method

The error is detected when no acknowledgement (ACK signal) is received after the transmission. (eg. When the data is transmitted six times in a row with 30 seconds interval, the error is detected on the transmission side.)

Note

The address/attribute appeared on the display on the remote controller indicates the controller which did not provide the response (ACK).

3. System configuration

(1) System with one outdoor unit

Error source address	Error display	Detection method	Cause	Check method and remedy
Outdoor unit (OC)	M-NET remote controller (RC) MA remote controller (MA)	No acknowledgement (ACK) at IC transmission to OC	(1) Contact failure of transmission line of OC or IC (2) Decrease of transmission line voltage/signal by exceeding acceptable range of transmission wiring. Farthest:200 m [656ft] or less Remote controller wiring: 10m [32ft] or less (3) Erroneous sizing of transmission line (Not within the range below). Wire diameter: 1.25mm ² [AWG16] or more (4) Indoor unit control board failure	Turn off the power source of the outdoor unit, and turn it on again. If the error is accidental, it will run normally. If not, check the causes (1) - (4).
Indoor unit (IC)	M-NET remote controller (RC) MA remote controller (MA)	No acknowledgement (ACK) at RC transmission to IC	(1) When IC unit address is changed or modified during operation. (2) Faulty or disconnected IC transmission wiring (3) Disconnected IC connector (CN2M) (4) Indoor unit controller failure (5) M-NET remote controller failure	Turn off the outdoor/indoor units for 5 or more minutes, and turn them on again. If the error is accidental, they will run normally. If not, check the causes (1) - (5).
LOSSNAY (LC)	M-NET remote controller (RC) MA remote controller (MA)	No acknowledgement (ACK) at IC transmission to LC	(1) The power source of LOSSNAY has been shut off. (2) When the address of LOSSNAY is changed in the middle of the operation (3) Faulty or disconnected transmission wiring of LOSSNAY (4) Disconnected connector (CN1) on LOSSNAY (5) Controller failure of LOSSNAY	Turn off the power source of LOSSNAY and turn it on again. If the error is accidental, it will run normally. If not, check the causes (1) - (5).
M-NET remote controller (RC)	M-NET remote controller (RC) MA remote controller (MA)	No acknowledgement (ACK) at IC transmission to RC	(1) Faulty transmission wiring at IC unit side. (2) Faulty wiring of the transmission line for M-NET remote controller (3) When the address of M-NET remote controller is changed in the middle of the operation (4) M-NET remote controller failure	Turn off the power source of the outdoor unit for 5 minutes or more, and turn it on again. If the error is accidental, it will run normally. If not, check the causes (1) - (4).

1. Error Code

6607

No ACK error

2. Error definition and error detection method

The error is detected when no acknowledgement (ACK signal) is received after the transmission. (eg. When the data is transmitted six times in a row with 30 seconds interval, the error is detected on the transmission side.)

Note

The address/attribute appeared on the display on the remote controller indicates the controller which did not provide the response (ACK).

3. System configuration

(2) Grouping of units in a system with multiple outdoor units

Error source address	Error display	Detection method	Cause	Check method and remedy
Outdoor unit (OC)	M-NET remote controller (RC) MA remote controller (MA)	No acknowledgement (ACK) at IC transmission to OC	Same cause as that for system with one outdoor unit	Same remedy as that for system with one outdoor unit
Indoor unit (IC)	M-NET remote controller (RC) MA remote controller (MA)	No acknowledgement (ACK) at RC transmission to IC	<p>(1) Same causes as (1) - (5) for system with one outdoor unit</p> <p>(2) Disconnection or short circuit of the transmission line for the outdoor unit on the terminal block for centralized control line connection (TB7)</p> <p>(3) When multiple outdoor units are connected and the power source of one of the outdoor units has been shut off.</p> <p>(4) The male power supply connector of the outdoor unit is not connected to the female power supply switch connector (CN40).</p> <p>(5) The male power supply connectors on 2 or more outdoor units are connected to the female power supply switch connector (CN40) for centralized control.</p> <p>If an error occurs, after the unit runs normally once, the following causes may be considered.</p> <ul style="list-style-type: none"> ♦Total capacity error (7100) ♦Capacity code error (7101) ♦Error in the number of connected units (7102) ♦Address setting error (7105) 	<p>1) Turn off the power sources of the outdoor and indoor units for 5 or more minutes, and turn them on again. If the error is accidental, the will run normally.If not, check the cause 2).</p> <p>2) Check the causes of (1) - (5). If the cause is found, correct it. If no cause is found, check 3).</p> <p>3) Check the LED displays for troubleshooting on other remote controllers whether an error occurs.</p> <p>If an error is found, -> If an error is found, check the check code definition, and correct the error. If no error is found, -> Indoor unit board failure</p>

1. Error Code

6607

No ACK error

2. Error definition and error detection method

The error is detected when no acknowledgement (ACK signal) is received after the transmission. (eg. When the data is transmitted six times in a row with 30 seconds interval, the error is detected on the transmission side.)

Note

The address/attribute appeared on the display on the remote controller indicates the controller which did not provide the response (ACK).

3. System configuration

(2) Grouping of units in a system with multiple outdoor units

Error source address	Error display	Detection method	Cause	Check method and remedy
LOSS-NAY (LC)	M-NET remote controller (RC) MA remote controller (MA)	No acknowledgement (ACK) at IC transmission to LC	<p>(1) Factors (1) through (5) in the "Factors in system with one outdoor unit" (When performing an interlocked operation of the LOSSNAY unit and the indoor units that are connected to different outdoor units.)</p> <p>(2) Disconnection or short circuit of the transmission line for the outdoor unit on the terminal block for centralized control line connection (TB7)</p> <p>(3) When multiple outdoor units are connected and the power source of one of the outdoor units has been shut off.</p> <p>(4) The male power supply connector of the outdoor unit is not connected to the female power supply switch connector (CN40).</p> <p>(5) The male power supply connectors on 2 or more outdoor units are connected to the female power supply switch connector (CN40) for centralized control.</p> <p>If an error occurs, after the unit runs normally once, the following causes may be considered.</p> <ul style="list-style-type: none"> ◆Total capacity error (7100) ◆Capacity code error (7101) ◆Error in the number of connected units (7102) ◆Address setting error (7105) 	<p>1) Turn off the power source of LOSSNAY for 5 or more minutes, and turn it on again. If the error is accidental, it will run normally. If not, check the cause 2).</p> <p>2) Check the causes of (1) - (5). If the cause is found, correct it. If no cause is found, check 3).</p> <p>3) Same cause as that for indoor unit described in 3)</p>

1. Error Code

6607

No ACK error

2. Error definition and error detection method

The error is detected when no acknowledgement (ACK signal) is received after the transmission. (eg. When the data is transmitted six times in a row with 30 seconds interval, the error is detected on the transmission side.)

Note

The address/attribute appeared on the display on the remote controller indicates the controller which did not provide the response (ACK).

3. System configuration

(2) Grouping of units in a system with multiple outdoor units

Error source address	Error display	Detection method	Cause	Check method and remedy
M-NET remote controller (RC)	M-NET remote controller (RC) MA remote controller (MA)	No acknowledgement (ACK) at IC transmission to RC	<p>(1) Same causes as (1) - (4) for system with one outdoor unit</p> <p>(2) Disconnection or short circuit of the transmission line for the outdoor unit on the terminal block for centralized control line connection (TB7)</p> <p>(3) When multiple outdoor units are connected and the power source of one of the outdoor units has been shut off.</p> <p>(4) The male power supply connector of the outdoor unit is not connected to the female power supply switch connector (CN40).</p> <p>(5) The male power supply connectors on 2 or more outdoor units are connected to the female power supply switch connector (CN40) for centralized control.</p> <p>If the problem recurs after normal operation is restored, the problem is caused by one of the following factors:</p> <ul style="list-style-type: none"> ◆Total capacity error (7100) ◆Capacity code setting error (7101) ◆Error in the number of connected units (7102) ◆Address setting error (7105) 	<p>1) Turn off the power source of LOSSNAY for 5 or more minutes, and turn it on again. If the error is accidental, it will run normally. If not, check the cause 2).</p> <p>2) Check the causes of (1) - (5). If the cause is found, correct it. If no cause is found, check 3).</p> <p>3) Same cause as that for indoor unit described in 3)</p>

1. Error Code

6607

No ACK error

2. Error definition and error detection method

The error is detected when no acknowledgement (ACK signal) is received after the transmission. (eg. When the data is transmitted six times in a row with 30 seconds interval, the error is detected on the transmission side.)

Note

The address/attribute appeared on the display on the remote controller indicates the controller which did not provide the response (ACK).

3. System configuration

(3) System connected to the system controllers (MELANS)

Error source address	Error display	Detection method	Cause	Check method and remedy
Outdoor unit (OC)	M-NET remote controller (RC) System controller (SC) MA remote controller (MA)	No acknowledgement (ACK) at IC transmission to OC	Same cause as that for system with one outdoor unit	Same remedy as that for system with one outdoor unit
Indoor unit (IC)	M-NET remote controller (RC) MA remote controller (MA)	No acknowledgement (ACK) at RC transmission to IC	Same as grouping of units in a system with multiple outdoor units	Same remedy as that for grouping of units in a system with multiple outdoor units
	System controller (SC)	No acknowledgement (ACK) at SC transmission to IC	1. Error occurrence on some IC	Same remedy as that for system with one outdoor unit
			(1) Same cause as that for system with one outdoor unit	
2. Error occurrence on all IC in the system with one outdoor unit				
(1) Total capacity error (7100)	1) Check the LED display for troubleshooting on the outdoor unit. ♦If an error is found, check the check code definition, and correct the error. ♦If no error is found, check 2).			
(2) Capacity code error (7101)				
(3) Error in the number of connected units (7102)				
(4) Address setting error (7105)				
(5) Disconnection or short circuit of the transmission line for the outdoor unit on the terminal block for centralized control line connection (TB7)		2) Check (5) - (7) on the left.		
(6) Turn off the power source of the outdoor unit				
(7) Malfunction of electrical system for the outdoor unit				
3. Error occurrence on all IC	Check voltage of the transmission line for centralized control. ♦20V or more: Check (1) and (2) on the left. ♦Less than 20V: Check (3) on the left.			
(1) Same causes as (1) - (7) described in 2.				
(2) The male power supply connectors on 2 or more outdoor units are connected to the female power supply switch connector (CN40) for the transmission line for centralized control.				
(3) Disconnection or shutdown of the power source of the power supply unit for transmission line				
(4) System controller (MELANS) malfunction				

1. Error Code

6607

No ACK error

2. Error definition and error detection method

The error is detected when no acknowledgement (ACK signal) is received after the transmission. (eg. When the data is transmitted six times in a row with 30 seconds interval, the error is detected on the transmission side.)

Note

The address/attribute appeared on the display on the remote controller indicates the controller which did not provide the response (ACK).

3. System configuration

(3) System connected to the system controllers (MELANS)

Error source address	Error display	Detection method	Cause	Check method and remedy
M-NET remote controller (RC)	M-NET remote controller (RC) System controller (SC) MA remote controller (MA)	No acknowledgement (ACK) at IC transmission to RC	Same as grouping of units in a system with multiple outdoor units	Same remedy as that for grouping of units in a system with multiple outdoor units
	System controller (SC)	No acknowledgement (ACK) at MELANS transmission to RC	1. Error occurrence on some IC (1) Same cause as that for system with one outdoor unit	Same remedy as that for system with one outdoor unit
			2. Error occurrence on all IC in the system with one outdoor unit (1) An error is found by the outdoor unit. Total capacity error (7100) Capacity code error (7101) Error in the number of connected units (7102) Address setting error (7105) (2) Disconnection or short circuit of the transmission line for the outdoor unit on the terminal block for centralized control line connection (TB7) (3) Turn off the power source of the outdoor unit (4) Malfunction of electrical system for the outdoor unit	1) Check the LED display for troubleshooting on the outdoor unit. ♦ If an error is found, check the check code definition, and correct the error. ♦ If no error is found, check the cause 2). 2) Check (2) - (4) on the left.
		3. Error occurrence on all IC (1) Same causes as (1) - (4) described in 2. (2) When the power supply unit for transmission lines is used and the male power supply connector is connected to the female power supply switch connector (CN40) for the transmission line for centralized control (3) Disconnection or shutdown of the power source of the power supply unit for transmission line (4) System controller (MELANS) malfunction	Check (1) - (4) on the left.	

1. Error Code

6607

No ACK error

2. Error definition and error detection method

The error is detected when no acknowledgement (ACK signal) is received after the transmission. (eg. When the data is transmitted six times in a row with 30 seconds interval, the error is detected on the transmission side.)

Note

The address/attribute appeared on the display on the remote controller indicates the controller which did not provide the response (ACK).

3. System configuration

(3) System connected to the system controllers (MELANS)

Error source address	Error display	Detection method	Cause	Check method and remedy
System controller (SC)	M-NET remote controller (RC) MA remote controller (MA)	No acknowledgement (ACK) at IC transmission to SC	1. Error display on some displays on M-NET remote controllers	Check (1) - (3) on the left.
			(1) Faulty wiring of the transmission line for M-NET remote controller	
			(2) Disconnection or contact failure of the transmission connector for M-NET remote controller	
			(3) M-NET remote controller failure	
			2. Error occurrence on all IC in the system with one outdoor unit	1) Check the LED display for troubleshooting on the outdoor unit. ♦ If an error is found, check the check code definition, and correct the error. ♦ If no error is found, check the cause 2)
		(1) An error is found by the outdoor unit. Total capacity error (7100) Capacity code error (7101) Error in the number of connected units (7102) Address setting error (7105)		
		(2) Disconnection or short circuit of the transmission line for the outdoor unit on the terminal block for centralized control line connection (TB7)	2) Check (2) - (4) on the left.	
		(3) Turn off the power source of the outdoor unit		
			(4) Malfunction of electrical system for the outdoor unit	
			3. Error display on all displays on M-NET remote controllers	Check (1) - (4) on the left
			(1) Same causes as (1) - (4) described in 2.	
			(2) When the power supply unit for transmission lines is used and the male power supply connector is connected to the female power supply switch connector (CN40) for the transmission line for centralized control	
			(3) Disconnection or shutdown of the power source of the power supply unit for transmission line	
			(4) System controller (MELANS) malfunction	

1. Error Code

6607

No ACK error

2. Error definition and error detection method

The error is detected when no acknowledgement (ACK signal) is received after the transmission. (eg. When the data is transmitted six times in a row with 30 seconds interval, the error is detected on the transmission side.)

Note

The address/attribute appeared on the display on the remote controller indicates the controller which did not provide the response (ACK).

3. System configuration

(4) Errors that are not limited to a particular system

Error source address	Error display	Detection method	Cause	Check method and remedy
Address which should not be existed	-	-	<p>(1) Although the address of M-NET remote controller has been changed after the group is set using M-NET remote controller, the indoor unit is keeping the memory of the previous address. The same symptom will appear for the registration with SC.</p> <p>(2) Although the address of LOSSNAY has been changed after the interlock registration of LOSSNAY is made using M-NET remote controller, the indoor unit is keeping the memory of the previous address.</p>	<p>Delete unnecessary information of non-existing address which some indoor units have. Use either of the following two methods for deletion.</p> <p>1) Address deletion by M-NET remote controller Delete unnecessary address information using the manual setting function of M-NET remote controller. Refer to this service handbook "IV [2] Group Settings and Interlock Settings via the ME Remote Controller 1. (3) Address deletion".</p> <p>2) Deletion of connection information of the outdoor unit by the deleting switch</p> <p>Note that this switch deletes all the group information set via M-NET remote controller and all the interlock information of LOSSNAY and the indoor unit.</p> <ul style="list-style-type: none"> ♦ Turn off the power source of the outdoor unit, and wait for 5 minutes. ♦ Turn on the dip switch (SW2-2) on the outdoor unit control board. ♦ Turn on the power source of the outdoor unit, and wait for 5 minutes. ♦ Turn off the power source of the outdoor unit, and wait for 5 minutes. ♦ Turn off the dip switch (SW2-2) on the outdoor unit control board. ♦ Turn on the power source of the outdoor unit.

1. Error Code

6608

No response error

2. Error definition and error detection method

- ♦When no response command is returned although acknowledgement (ACK) is received after transmission, an error is detected.
- ♦When the data is transmitted 10 times in a row with 3 seconds interval, an error is detected on the transmission side.

Note

The address/attribute appeared on the display on the remote controller indicates the controller where an error occurred.

3. Cause

- 1) The transmission line work is performed while the power is on, the transmitted data will collide, and the wave shape will be changed.
- 2) The transmission is sent and received repeatedly due to noise.
- 3) Decrease of transmission line voltage/signal by exceeding acceptable range of transmission wiring.
Farthest:200m [656ft] or less
Remote controller wiring:12m [39ft] or less
- 4) The transmission line voltage/signal is decreased due to erroneous sizing of transmission line.
Wire diameter: 1.25mm²[AWG16] or more

4. Check method and remedy

- 1) When an error occurs during commissioning, turn off the power sources for the outdoor unit, indoor unit, and LOSSNAY for 5 or more minutes, and then turn them on again.
 - ♦ When they return to normal operation, the cause of the error is the transmission line work performed with the power on.
 - ♦ If an error occurs again, check the cause 2).
- 2) Check 3) and 4) above.
 - ♦ If the cause is found, correct it.
 - ♦ If no cause is found, check 3).
- 3) Check transmission wave shape/ noise on trans-mission line by following IX [3] Investigation of Transmission Wave Shape/ Noise(page 231).

Noise is the most possible cause of the error "6608".

1. Error Code

6831

MA controller signal reception error (No signal reception)

2. Error definition and error detection method

- Communication between the MA remote controller and the indoor unit is not done properly.
- No proper data has been received for 3 minutes.

3. Cause

- 1) Contact failure of the remote controller lines of MA remote controller or the indoor unit.
- 2) All the remote controllers are set to SUB.
- 3) Failure to meet wiring regulations
 - Wire length
 - Wire size
 - Number of remote controllers
 - Number of indoor units
- 4) The remote controller is removed after the installation without turning the power source off.
- 5) Noise interference on the remote controller transmission lines
- 6) Faulty circuit that is on the indoor board and performs transmission/ reception of the signal from the remote controller
- 7) Problems with the circuit on the remote controller that sends or receives the signals from the remote controller

4. Check method and remedy

- 1) Check for disconnected or loose transmission lines for the indoor units or MA remote controllers.
- 2) Confirm that the power is supplied to the main power source and the remote controller line.
- 3) Confirm that MA remote controller's capacity limit is not exceeded.
- 4) Check the sub/main setting of the MA remote controllers. One of them must be set to MAIN.
- 5) Diagnose the remote controller (described in the remote controller installation manual).
[OK]: no problems with the remote controller (check the wiring regulations)
[NO]: Replace the MA remote controller.
[6832, 6833, ERC]: Due to noise interference <Go to 6>
- 6) Check wave shape/noise on MA remote controller line by following "IX [3] Investigation of Transmission Wave Shape/ Noise". (page 231)
- 7) When no problems are found with items 1) through 6), replace the indoor unit board or the MA remote controller.
The following status can be confirmed on LED1 and 2 on the indoor unit board.
 - If LED1 is lit, the main power source of the indoor unit is turned on.
 - If LED2 is lit, the MA remote controller line is being powered.

1. Error Code

6832

MA remote controller signal transmission error (Synchronization error)

2. Error definition and error detection method

- MA remote controller and the indoor unit is not done properly.
- Failure to detect opening in the transmission path and unable to send signals
 - *Indoor unit : 3 minutes
 - *Remote controller : 6 seconds

3. Cause

- 1) Contact failure of the remote controller lines of MA remote controller or the indoor unit
- 2) 2 or more remote controllers are set to MAIN
- 3) Overlapped indoor unit address
- 4) Noise interference on the remote controller lines
- 5) Failure to meet wiring regulations
 - Wire length
 - Wire size
 - Number of remote controllers
 - Number of indoor units
- 6) Problems with the circuit on the remote controller that sends or receives the signals from the remote controller

4. Check method and remedy

- 1) Check for disconnected or loose transmission lines for the indoor units or MA remote controllers.
- 2) Confirm that the power is supplied to the main power source and the remote controller line.
- 3) Confirm that MA remote controller's capacity limit is not exceeded.
- 4) Check the sub/main setting of the MA remote controllers. One of them must be set to MAIN.
- 5) Diagnose the remote controller (described in the remote controller installation manual).
[OK]: no problems with the remote controller (check the wiring regulations)
[NO]: Replace the MA remote controller.
[6832, 6833, ERC]: Due to noise interference <Go to 6)>
- 6) Check wave shape/noise on MA remote controller line by following "IX [3] Investigation of Transmission Wave Shape/ Noise".(page 231)
- 7) When no problems are found with items 1) through 6), replace the indoor unit board or the MA remote controller.
The following status can be confirmed on LED1 and 2 on the indoor unit board.
 - If LED1 is lit, the main power source of the indoor unit is turned on.
 - If LED2 is lit, the MA remote controller line is being powered.

1. Error Code

6833

MA remote controller signal transmission error (Hardware error)

2. Error definition and error detection method

- ♦Communication between the MA remote controller and the indoor unit is not done properly.
- ♦An error occurs when the transmitted data and the received data differ for 30 times in a row.

3. Cause

- 1) Contact failure of the remote controller lines of MA remote controller or the indoor unit
- 2) 2 or more remote controllers are set to MAIN
- 3) Overlapped indoor unit address
- 4) Noise interference on the remote controller lines
- 5) Failure to meet wiring regulations
 - ♦Wire length
 - ♦Wire size
 - ♦Number of remote controllers
 - ♦Number of indoor units
- 6) Problems with the circuit on the remote controller that sends or receives the signals from the remote controller

4. Check method and remedy

- 1) Check for disconnected or loose transmission lines for the indoor units or MA remote controllers.
- 2) Confirm that the power is supplied to the main power source and the remote controller line.
- 3) Confirm that MA remote controller's capacity limit is not exceeded.
- 4) Check the sub/main setting of the MA remote controllers. One of them must be set to MAIN.
- 5) Diagnose the remote controller (described in the remote controller installation manual).
[OK]: no problems with the remote controller (check the wiring regulations)
[NO]: Replace the MA remote controller.
[6832, 6833, ERC]: Due to noise interference <Go to 6>
- 6) Check wave shape/noise on MA remote controller line by following "IX [3] Investigation of Transmission Wave Shape/ Noise". (page 231)
- 7) When no problems are found with items 1) through 6), replace the indoor unit board or the MA remote controller.
The following status can be confirmed on LED1 and 2 on the indoor unit board.
 - ♦If LED1 is lit, the main power source of the indoor unit is turned on.
 - ♦If LED2 is lit, the MA remote controller line is being powered.

1. Error Code

6834

MA controller signal reception error (Start bit detection error)

2. Error definition and error detection method

- Communication between the MA remote controller and the indoor unit is not done properly.
- No proper data has been received for 2 minutes.

3. Cause

- 1) Contact failure of the remote controller lines of MA remote controller or the indoor unit.
- 2) All the remote controllers are set to SUB.
- 3) Failure to meet wiring regulations
 - Wire length
 - Wire size
 - Number of remote controllers
 - Number of indoor units
- 4) The remote controller is removed after the installation without turning the power source off.
- 5) Noise interference on the remote controller transmission lines
- 6) Faulty circuit that is on the indoor board and performs transmission/ reception of the signal from the remote controller
- 7) Problems with the circuit on the remote controller that sends or receives the signals from the remote controller

4. Check method and remedy

- 1) Check for disconnected or loose transmission lines for the indoor units or MA remote controllers.
- 2) Confirm that the power is supplied to the main power source and the remote controller line.
- 3) Confirm that MA remote controller's capacity limit is not exceeded.
- 4) Check the sub/main setting of the MA remote controllers. One of them must be set to MAIN.
- 5) Diagnose the remote controller (described in the remote controller installation manual).
[OK]: no problems with the remote controller (check the wiring regulations)
[NO]: Replace the MA remote controller.
[6832, 6833, ERC]: Due to noise interference <Go to 6)>
- 6) Check wave shape/noise on MA remote controller line by following "IX [3] Investigation of Transmission Wave Shape/ Noise". (page 231)
- 7) When no problems are found with items 1) through 6), replace the indoor unit board or the MA remote controller.
The following status can be confirmed on LED1 and 2 on the indoor unit board.
 - If LED1 is lit, the main power source of the indoor unit is turned on
 - If LED2 is lit, the MA remote controller line is being powered.

1. Error Code

7100

Total capacity error

2. Error definition and error detection method

The model total of indoor units in the system with one outdoor unit exceeds limitations.

3. Error source, cause, check method and remedy,

Error source	Cause	Check method and remedy																												
Outdoor unit	(1) The model total of indoor units in the system with one outdoor unit exceeds the following table. <table border="1" style="margin: 10px auto; width: 60%;"> <thead> <tr> <th>Model</th> <th>Capacity Total</th> </tr> </thead> <tbody> <tr><td>72 model</td><td>96</td></tr> <tr><td>96 model</td><td>124</td></tr> <tr><td>120 model</td><td>156</td></tr> <tr><td>144 model</td><td>187</td></tr> <tr><td>168 model</td><td>218</td></tr> <tr><td>192 model</td><td>249</td></tr> <tr><td>216 model</td><td>280</td></tr> <tr><td>240 model</td><td>312</td></tr> <tr><td>264 model</td><td>343</td></tr> <tr><td>288 model</td><td>374</td></tr> <tr><td>312 model</td><td>405</td></tr> <tr><td>336 model</td><td>436</td></tr> <tr><td>360 model</td><td>468</td></tr> </tbody> </table>	Model	Capacity Total	72 model	96	96 model	124	120 model	156	144 model	187	168 model	218	192 model	249	216 model	280	240 model	312	264 model	343	288 model	374	312 model	405	336 model	436	360 model	468	1) Check the model total (capacity code total) of indoor units connected. 2) Check the model name (capacity code) of the connected indoor unit set by the switch (SW2 on indoor unit board). When the model name set by the switch is different from that of the unit connected, turn off the power source of the outdoor and the indoor units, and change the setting of the model name (capacity code).
	Model	Capacity Total																												
	72 model	96																												
96 model	124																													
120 model	156																													
144 model	187																													
168 model	218																													
192 model	249																													
216 model	280																													
240 model	312																													
264 model	343																													
288 model	374																													
312 model	405																													
336 model	436																													
360 model	468																													
(2) The model selection switches (SW5-1 - 5-4) on the outdoor unit are set incorrectly. <table border="1" style="margin: 10px auto; width: 60%;"> <thead> <tr> <th rowspan="2">Model</th> <th colspan="4">SW5</th> </tr> <tr> <th>1</th> <th>2</th> <th>3</th> <th>4</th> </tr> </thead> <tbody> <tr><td>72 model</td><td>OFF</td><td>ON</td><td>OFF</td><td>OFF</td></tr> <tr><td>96 model</td><td>ON</td><td>ON</td><td>OFF</td><td>OFF</td></tr> <tr><td>120 model</td><td>OFF</td><td>OFF</td><td>ON</td><td>OFF</td></tr> </tbody> </table>	Model	SW5				1	2	3	4	72 model	OFF	ON	OFF	OFF	96 model	ON	ON	OFF	OFF	120 model	OFF	OFF	ON	OFF	Check the setting for the model selection switch on the outdoor unit (Dipswitches SW5-1 - 5-4 on the outdoor unit control board).					
Model		SW5																												
	1	2	3	4																										
72 model	OFF	ON	OFF	OFF																										
96 model	ON	ON	OFF	OFF																										
120 model	OFF	OFF	ON	OFF																										
(3) The outdoor unit and the auxiliary unit (OS) that is connected to the same system are not properly connected.		Confirm that the TB3 on the OC and OS are properly connected.																												

1. Error Code

7101

Capacity code setting error

2. Error definition and error detection method

Connection of incompatible (wrong capacity code) indoor unit or outdoor unit

3. Error source, cause, check method and remedy

Error source	Cause	Check method and remedy
Outdoor unit Indoor unit	(1) The model name (capacity code) set by the switch (SW2) is wrong. *The capacity of the indoor unit can be confirmed by the self-diagnosis function (SW1 operation) of the outdoor unit.	1) Check the model name (capacity code) of the indoor unit which has the error source address set by the switch (SW2 on indoor unit board). When the model name set by the switch is different from that of the unit connected, turn off the power source of the outdoor and the indoor units, and change the setting of the capacity code.
Outdoor unit	(2) The model selection switches (SW5-1 - 5-4) on the outdoor unit are set incorrectly.	Check the setting for the model selection switch on the outdoor unit (Dipswitches SW5-1 - 5-4 on the outdoor unit control board).

Model	SW5			
	1	2	3	4
72 model	OFF	ON	OFF	OFF
96 model	ON	ON	OFF	OFF
120 model	OFF	OFF	ON	OFF

1. Error Code

7102

Wrong number of connected units

2. Error definition and error detection method

The number of connected indoor units is "0" or exceeds the allowable value.

3. Error source, cause, check method and remedy

Error source	Cause	Check method and remedy																	
Outdoor unit	<p>(1) Number of indoor units connected to the outdoor terminal block (TB3) for indoor/ outdoor transmission lines exceeds limitations described below.</p> <table border="1" style="margin-left: 20px;"> <thead> <tr> <th style="width: 30%;">Number of units</th> <th>Restriction on the number of units</th> </tr> </thead> <tbody> <tr> <td rowspan="7">Total number of indoor units</td> <td>15 : P72 model</td> </tr> <tr> <td>20 : P96 model</td> </tr> <tr> <td>26 : P120 model</td> </tr> <tr> <td>31 : P144 model</td> </tr> <tr> <td>36 : P168 model</td> </tr> <tr> <td>41 : P192 model</td> </tr> <tr> <td>46 : P216 model</td> </tr> <tr> <td>50 : P240 - 360 models</td> </tr> <tr> <td>Total number of LOSSNAY units (During auto address start-up only)</td> <td>0 or 1</td> </tr> <tr> <td rowspan="3">Total number of outdoor units</td> <td>1 : 72 - 120 models</td> </tr> <tr> <td>2 : 144 - 240 models</td> </tr> <tr> <td>3 : P264 - 360 models</td> </tr> </tbody> </table>	Number of units	Restriction on the number of units	Total number of indoor units	15 : P72 model	20 : P96 model	26 : P120 model	31 : P144 model	36 : P168 model	41 : P192 model	46 : P216 model	50 : P240 - 360 models	Total number of LOSSNAY units (During auto address start-up only)	0 or 1	Total number of outdoor units	1 : 72 - 120 models	2 : 144 - 240 models	3 : P264 - 360 models	<p>1) Check whether the number of units connected to the outdoor terminal block (TB3) for indoor/ outdoor transmission lines does not exceed the limitation. (See (1) and (2) on the left.)</p>
	Number of units	Restriction on the number of units																	
	Total number of indoor units	15 : P72 model																	
		20 : P96 model																	
		26 : P120 model																	
31 : P144 model																			
36 : P168 model																			
41 : P192 model																			
46 : P216 model																			
50 : P240 - 360 models																			
Total number of LOSSNAY units (During auto address start-up only)	0 or 1																		
Total number of outdoor units	1 : 72 - 120 models																		
	2 : 144 - 240 models																		
	3 : P264 - 360 models																		
(2) Disconnected transmission line of the outdoor unit	2) Check (2) - (3) on the left.																		
<p>(3) Short-circuited transmission line When (2) and (3) apply, the following display will appear.</p> <ul style="list-style-type: none"> •M-NET remote controller Nothing appears on the remote controller because it is not powered. •MA remote controller "HO" or "PLEASE WAIT" blinks. 	3) Check whether the transmission line for the terminal block for centralized control (TB7) is not connected to the terminal block for the indoor/outdoor transmission line (TB3).																		
(4) The model selection switch (SW5-7) on the outdoor unit is set to OFF. (Normally set to ON)	4) Check the setting for the model selection switch on the outdoor unit (Dipswitches SW5-7 on the outdoor unit control board).																		
(5) Outdoor unit address setting error The outdoor units in the same refrigerant circuit do not have sequential address numbers.																			

1. Error Code

7105

Address setting error

2. Error definition and error detection method

Erroneous setting of OC unit address

3. Cause, check method and remedy

Error source	Cause	Check method and remedy
Outdoor unit	Erroneous setting of OC unit address The address of outdoor unit is not being set to 51 - 100.	Check that the address of OC unit is set to 51-100. Reset the address if it stays out of the range, while shutting the power source off.

1. Error Code

7106

Attribute setting error

2. Error definition and error detection method

Error source	Cause	Check method and remedy						
-	A remote controller for use with indoor units, such as the MA remote controller, is connected to the OA processing unit whose attribute is FU.	To operate the OA processing unit directly via a remote controller for use with indoor units, such as the MA remote controller, set the DIP SW 3-1 on the OA processing unit to ON. <table border="1" style="margin-left: 20px;"> <tr> <td>Operation Method</td> <td>SW3-1</td> </tr> <tr> <td>Interlocked operation with the indoor unit</td> <td>OFF</td> </tr> <tr> <td>Direct operation via the MA remote controller</td> <td>ON</td> </tr> </table>	Operation Method	SW3-1	Interlocked operation with the indoor unit	OFF	Direct operation via the MA remote controller	ON
Operation Method	SW3-1							
Interlocked operation with the indoor unit	OFF							
Direct operation via the MA remote controller	ON							

1. Error Code

7110

Connection information signal transmission/reception error

2. Error definition and error detection method

The given indoor unit is inoperable because it is not properly connected to the outdoor unit in the same system.

3. Error source, cause, check method and remedy

Error source	Cause	Check method and remedy
Outdoor unit	(1) Power to the transmission booster is cut off.	1) Confirm that the power to the transmission booster is not cut off by the booster being connected to the switch on the indoor unit. (The unit will not function properly unless the transmission booster is turned on.) ->Reset the power to the outdoor unit.
	(2) Power resetting of the transmission booster and outdoor unit.	
	(3) Wiring failure between OC and OS	2) Confirm that the TB3 on the OC and OS are properly connected.
	(4) Broken wire between OC and OS.	3) Check the model selection switch on the outdoor unit (Dipswitch SW5-7 on the control board.).
	(5) The model selection switch (SW5-7) on the outdoor unit is set to OFF. (Normally set to ON)	

1. Error Code

7111

Remote controller sensor fault

2. Error definition and error detection method

This error occurs when the temperature data is not sent although the remote controller sensor is specified.

3. Error source, cause, check method and remedy

Error source	Cause	Check method and remedy
Indoor unit OA processing unit	The remote controller without the temperature sensor (the wireless remote controller or the M-NET compact remote controller (mounted type)) is used and the remote controller sensor for the indoor unit is specified. (SW1-1 is ON.)	Replace the remote controller with the one with built-in temperature sensor.

1. Error Code

7113

Function setting error (incorrect resistor connection)

2. Error source, cause, check method and remedy

Error source	Cause	Check method and remedy
Outdoor unit	(1) Wiring fault	(Detail code 15)
	(2) Loose connectors, short-circuit, contact failure	1) Check the connector CNTYP5 on the control board for proper connection.
		(Detail code 14)
	(3) Incompatible control board and INV board (replacement with a wrong circuit board)	1) Check the connector CNTYP4 on the control board for proper connection.
		2) Check the connector CNTYP5 on the control board for proper connection.
	(4) DIP SW setting error on the control board	3) Check the settings of SW5-1 through SW5-4 on the control board.
		(Detail code 12)
(4) DIP SW setting error on the control board	1) Check the connector CNTYP2 on the control board for proper connection.	
	2) Check the connector CNTYP5 on the control board for proper connection.	
	3) Check the connector CNTYP4 on the control board for proper connection.	
	4) Check the settings of SW5-1 through SW5-4 on the control board.	
	(Detail code 16)	
(4) DIP SW setting error on the control board	1) Check the connector CNTYP on the INV board for proper connection.	
	2) Check the connector CNTYP5 on the control board for proper connection.	
	3) Check the connector CNTYP4 on the control board for proper connection.	
	4) Check the settings of SW5-1 through SW5-4 on the control board.	
	5) Check the wiring between the control board and INV board. (Refer to the section on Error code 0403.)	
(4) DIP SW setting error on the control board	(Detail code 00, 01, 05)	
	1) Check the wiring between the control board and INV board. (Refer to the section on Error code 0403.)	
	2) Check the settings of SW5-1 through SW5-4 on the control board.	
	3) Check the connector CNTYP5 on the control board for proper connection.	
(4) DIP SW setting error on the control board	4) Check the connector CNTYP4 on the control board for proper connection.	
	(Detail code Miscellaneous)	
		*If a set-model-name identification error occurs, check the detail code on the unit on which the error occurred. The detail code that appears on other units will be different from the ones shown above.

1. Error Code

7117

Model setting error

2. Error source, cause, check method and remedy

Error source	Cause	Check method and remedy
Outdoor unit	(1) Wiring fault	(Detail code 15) 1) Check the connector CNTYP5 on the control board for proper connection.
	(2) Loose connectors, short-circuit, contact failure	(Detail code 14) 1) Check the connector CNTYP4 on the control board for proper connection.
		(Detail code 12) 1) Check the connector CNTYP2 on the control board for proper connection. 2) Check the connector CNTYP5 on the control board for proper connection.
	(2) Loose connectors, short-circuit, contact failure	(Detail code 16) 1) Check the connector CNTYP on the INV board for proper connection. 2) Check the connector CNTYP5 on the control board for proper connection. 3) Check the connector CNTYP4 on the control board for proper connection. 4) Check the wiring between the control board and INV board. (Refer to the section on Error code 0403.)
		(Detail code 00, 01, 05) 1) Check the wiring between the control board and INV board. (Refer to the section on Error code 0403.) 2) Check the settings of SW5-1 through SW5-4 on the control board. 3) Check the connector CNTYP5 on the control board for proper connection. 4) Check the connector CNTYP4 on the control board for proper connection.
		(Detail code Miscellaneous) *If a set-model-name identification error occurs, check the detail code on the unit on which the error occurred. The detail code that appears on other units will be different from the ones shown above.

1. Error Code

7130

Incompatible unit combination

2. Error definition and error detection method

The check code will appear when the indoor units with different refrigerant systems are connected.

3. Error source, cause, check method and remedy

Error source	Cause	Check method and remedy
Outdoor unit	The connected indoor unit is for use with R22 or R407C. Incorrect type of indoor units are connected. The M-NET connection adapter is connected to the indoor unit system in a system in which the Slim Model (A control) of units are connected to the M-NET.	Check the connected indoor unit model. Check whether the connecting adapter for M-NET is not connected to the indoor unit. (Connect the connecting adapter for M-NET to the outdoor unit.)

-1- Troubleshooting according to the remote controller malfunction or the external input error

In the case of MA remote controller

1. Phenomena

Even if the operation button on the remote controller is pressed, the display remains unlit and the unit does not start running. (Power indicator  does not appear on the screen.)

(1) Cause

- 1) The power is not supplied to the indoor unit.
 - ♦The main power of the indoor unit is not on.
 - ♦The connector on the indoor unit board has come off.
 - ♦The fuse on the indoor unit board has melted.
 - ♦Transformer failure and disconnected wire of the indoor unit.
- 2) Incorrect wiring for the MA remote controller
 - ♦Disconnected wire for the MA remote controller or disconnected line to the terminal block.
 - ♦Short-circuited MA remote controller wiring
 - ♦Incorrect wiring of the MA remote controller cables
 - ♦Incorrect connection of the MA remote wiring to the terminal block for transmission line (TB5) on the indoor unit
 - ♦Wiring mixup between the MA remote controller cable and power supply cable
 - ♦Reversed connection of the wire for the MA remote controller and the M-NET transmission line on the indoor unit
- 3) The number of the MA remote controllers that are connected to an indoor unit exceeds the allowable range (2 units).
- 4) The length or the diameter of the wire for the MA remote controller are out of specification.
- 5) Short circuit of the wire for the remote display output of the outdoor unit or reversed polarity connection of the relay.
- 6) The indoor unit board failure
- 7) MA remote controller failure

(2) Check method and remedy

- 1) Measure voltages of the MA remote controller terminal (among 1 to 3).
 - ♦If the voltage is between DC 9 and 12V, the remote controller is a failure.
 - ♦If no voltage is applied, check the causes 1) and 3) and if the cause is found, correct it.
If no cause is found, refer to 2).
- 2) Remove the wire for the remote controller from the terminal block (TB13) on the MA remote controller for the indoor unit, and check voltage among 1 to 3.
 - ♦If the voltage is between DC 9 and 12 V, check the causes 2) and 4) and if the cause is found, correct it.
 - ♦If no voltage is applied, check the cause 1) and if the cause is found, correct it.
If no cause is found, check the wire for the remote display output (relay polarity).
If no further cause is found, replace the indoor unit board.

In the case of MA remote controller

2. Phenomena

When the remote controller operation SW is turned on, the operation status briefly appears on the display, then it goes off, and the display lights out immediately, and the unit stops.

(1) Cause

- 1) The power for the M-NET transmission line is not supplied from the outdoor unit.
 - 2) Short circuit of the transmission line.
 - 3) Incorrect wiring of the M-NET transmission line on the outdoor unit.
 - Disconnected wire for the MA remote controller or disconnected line to the terminal block.
 - The indoor transmission line is connected incorrectly to the transmission terminal block for centralized controller (TB7).
 - The male power supply connectors on the multiple outdoor units are connected to the female power supply switch connector (CN40).
- In the system to which the power supply unit for transmission lines is connected, the male power supply connector is connected to the female power supply switch connector (CN40) on the outdoor unit.
- 4) Disconnected M-NET transmission line on the indoor unit side.
 - 5) Disconnected wire between the terminal block for M-NET line (TB5) of the indoor unit and the indoor unit board (CN2M) or disconnected connector.

(2) Check method and remedy

- 1) **When 2) and 3) above apply, check code 7102 will be displayed on the self-diagnosis LED.**

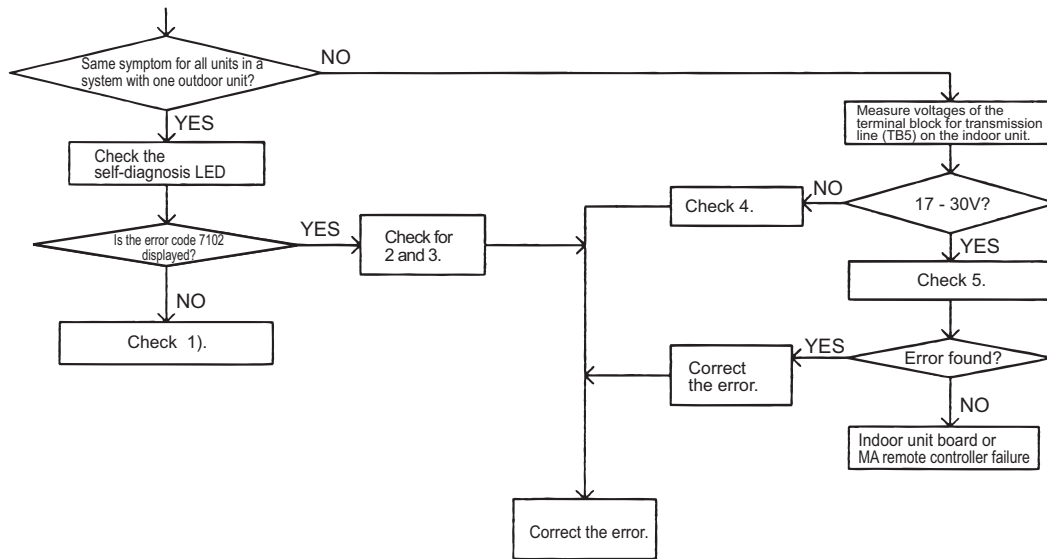

Refer to section IX [4] -7- (2) Troubleshooting transmission power circuit of outdoor unit for how to check the first item in the flowchart above.(page 261)(page 264)

In the case of MA remote controller

3. Phenomena

"HO" or "PLEASE WAIT" display on the remote controller does not disappear, and no operation is performed even if the button is pressed. ("HO" or "PLEASE WAIT" display will normally turn off 5 minutes later after the power on.)

(1) Cause

- 1) The power for the M-NET transmission line is not supplied from the outdoor unit.
- 2) Short-circuited transmission line
- 3) Incorrect wiring of the M-NET transmission line on the outdoor unit.
 - Disconnected wire for the MA remote controller or disconnected line to the terminal block.
 - The indoor transmission line is connected incorrectly to the transmission terminal block for centralized controller (TB7).
 - The male power supply connectors on the multiple outdoor units are connected to the female power supply switch connector (CN40).

In the system to which the power supply unit for transmission lines is connected, the male power supply connector is connected to the female power supply switch connector (CN40) on the outdoor unit
- 4) Disconnected M-NET transmission line on the indoor unit.
- 5) Disconnected wire between the terminal block for M-NET line (TB5) of the indoor unit and the indoor unit board (CN2M) or disconnected connector.
- 6) Incorrect wiring for the MA remote controller
 - Short-circuited wire for the MA remote controller
 - Disconnected wire for the MA remote controller (No.2) and disconnected line to the terminal block.
 - Reversed daisy-chain connection between groups
 - Incorrect wiring for the MA remote controller to the terminal block for transmission line connection (TB5) on the indoor unit
 - The M-NET transmission line is connected incorrectly to the terminal block (TB13) for the MA remote controller.
- 7) The sub/main setting of the MA remote controller is set to sub.
- 8) 2 or more main MA remote controllers are connected.
- 9) Indoor unit board failure (MA remote controller communication circuit)
- 10) Remote controller failure
- 11) Outdoor unit failure (Refer to IX [7] Troubleshooting Using the Outdoor Unit LED Error Display.)(page 269)

(2) Check method and remedy

- 1) **When 2) and 3) above apply, check code 7102 will be displayed on the self-diagnosis LED.**

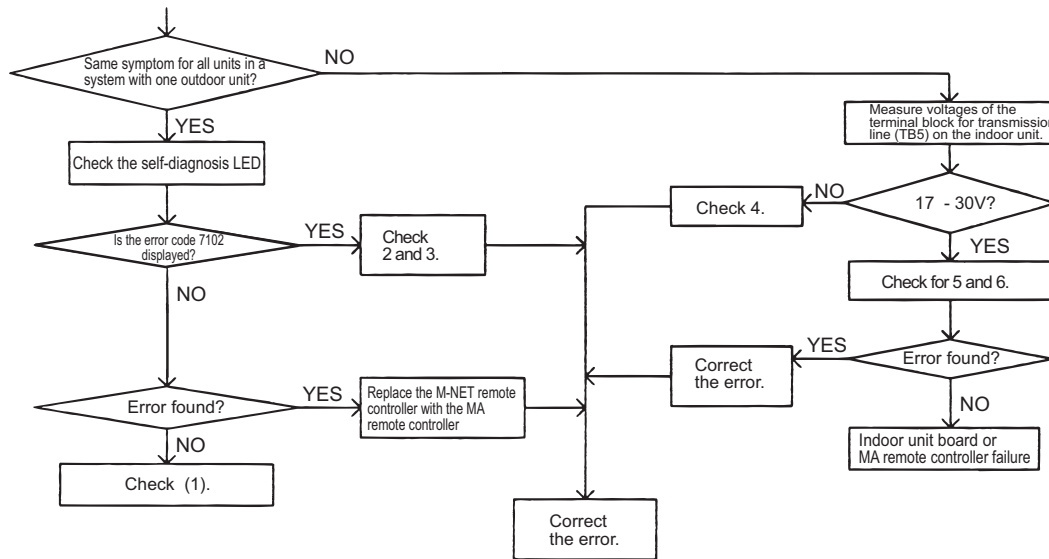

Refer to section IX [4] -7- (2) Troubleshooting transmission power circuit of outdoor unit for how to check the first item in the flowchart above.(page 261)(page 264)

In case of M-NET remote controller

1. Phenomena

Even if the operation button on the remote controller is pressed, the display remains unlit and the unit does not start running.
(Power indicator ☉ does not appear on the screen.)

(1) Cause

- 1) The power for the M-NET transmission line is not supplied from the outdoor unit.
- 2) Short circuit of the transmission line.
- 3) Incorrect wiring of the M-NET transmission line on the outdoor unit.
 - ♦Disconnected wire for the MA remote controller or disconnected line to the terminal block.
 - ♦The indoor transmission line is connected incorrectly to the transmission terminal block for centralized controller (TB7).
- 4) Disconnected transmission line on the remote controller.
- 5) Remote controller failure
- 6) Outdoor unit failure (Refer to 9 [7] Troubleshooting Using the Outdoor Unit LED Error Display.)(page 269)

(2) Check method and remedy

- 1) Check voltage of the transmission terminal block for of the M-NET remote controller.
 - ♦If voltage between is 17V and 30V -> M-NET remote controller failure
 - ♦ When voltage is 17V or less -> Refer to IX [4] -7- (2) Troubleshooting transmission power circuit of outdoor unit .
- 2) **When 2) and 3) above apply, check code 7102 will be displayed on the self-diagnosis LED.**

In case of M-NET remote controller

2. Phenomena

When the remote controller operation SW is turned on, a temporary operation display is indicated, and the display lights out immediately.

(1) Cause

1) The power is not supplied to the indoor unit.

- ♦The main power of the indoor unit (AC208/230V) is not on.
- ♦The connector on the indoor unit board has come off.
- ♦The fuse on the indoor unit board has melted.
- ♦Transformer failure and disconnected wire of the indoor unit
- ♦The indoor unit board failure

2) The outdoor control board failure

As the indoor unit does not interact with the outdoor unit, the outdoor unit model cannot be recognized.

(2) Check method and remedy

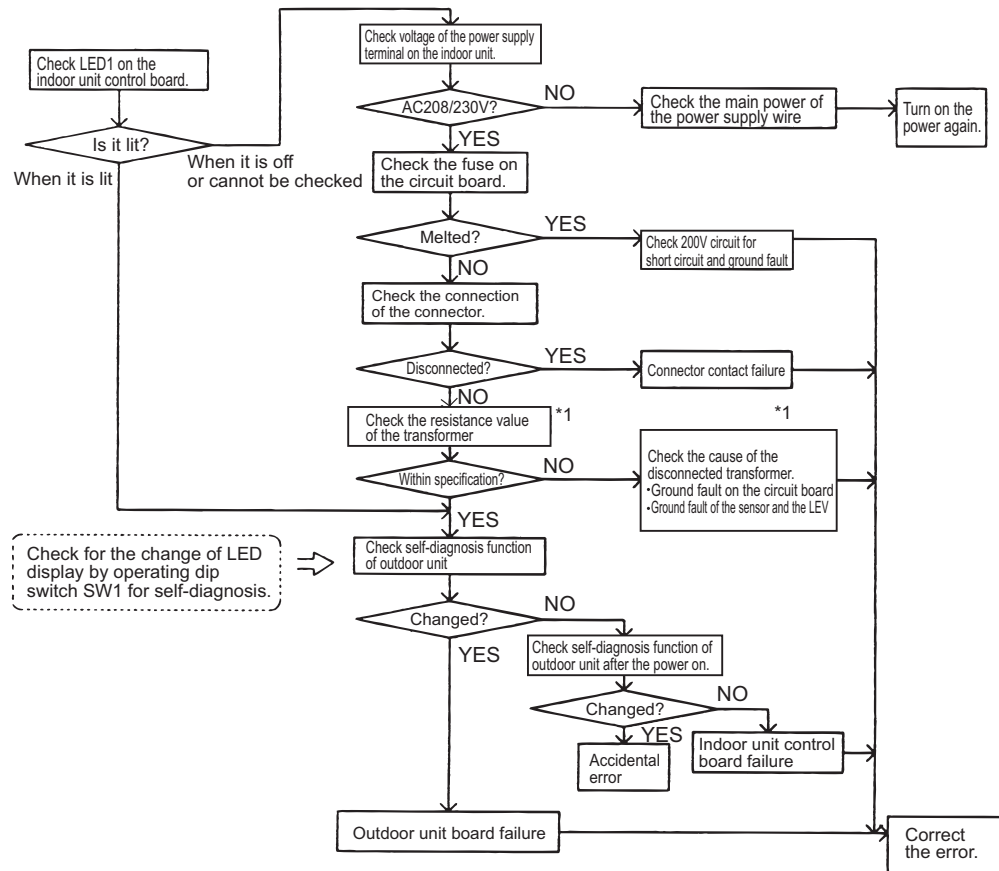

*1. Refer to the parts catalog "transformer check".

In case of M-NET remote controller

3. Phenomena

"HO" display on the remote controller does not disappear, and no operation is performed even if the button is pressed.

(1) Cause

Without using MELANS

- 1) Outdoor unit address is set to "00"
- 2) A wrong address is set.
 - ♦The address of the indoor unit that is connected to the remote controller is incorrect. (It should equal the M-NET remote controller address plus 100.)
 - ♦A wrong address is set to the M-NET remote controller. (100 must be added to the address of the indoor unit.)
- 3) Faulty wiring of the terminal block for transmission line (TB5) of the indoor unit in the same group with the remote controller.
- 4) The centralized control switch (SW2-1) on the outdoor unit is set to ON.
- 5) Disconnection or faulty wiring of indoor unit transmission line.
- 6) Disconnection between the terminal block for M-NET line connection (TB5) of the indoor unit and the male connector (CN2M)
- 7) The male power supply connectors on 2 or more outdoor units are connected to the female power supply switch connector (CN40) for the transmission line for centralized control.
- 8) Outdoor unit control board failure
- 9) Outdoor unit control board failure
- 10) Remote controller failure

Interlocking control with MELANS

- 1) No group registration is made using MELANS. (The indoor unit and the M-NET remote controller are not grouped.)
- 2) Disconnected transmission line for centralized control (TB7) of the outdoor unit
- 3) The male power supply connector is connected to CN40 on more than one outdoor unit, or the connector is connected to CN40 on the outdoor unit in the system to which a power supply unit for transmission line is connected.

Using MELANS

- 1) When MELANS is used, "HO" display on the remote controller will disappear when the indoor unit and the local remote controller (M-NET remote controller) are grouped.
If "HO" does not disappear after the registration, check the causes (2) 1) - 3).

(2) Check method and remedy

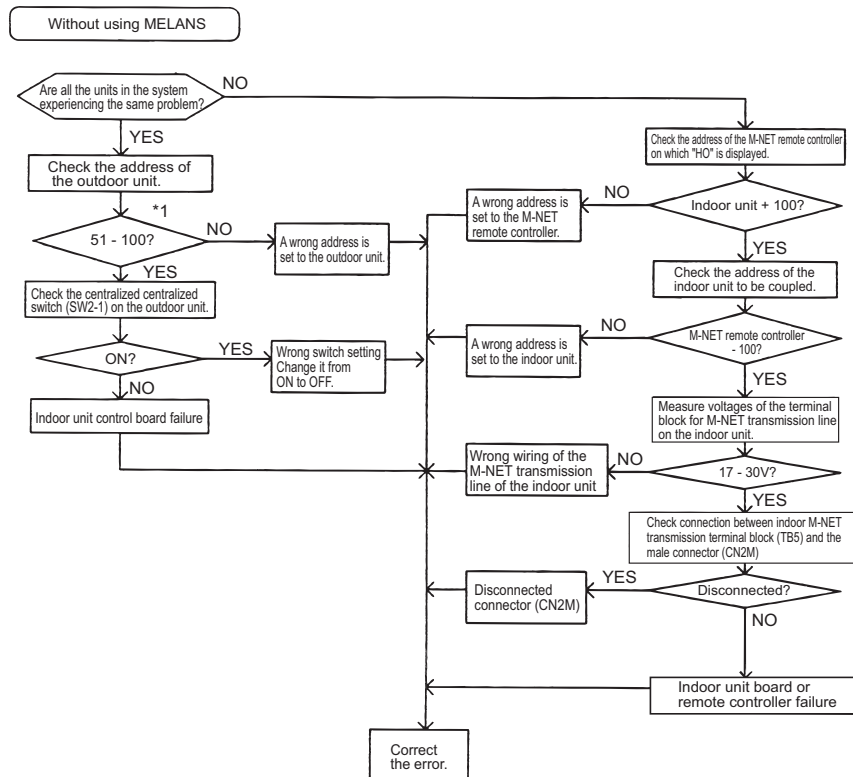

*1. When the indoor unit address is set to 1 - 50, the address will be forcibly set to 100.

In case of M-NET remote controller

4. Phenomena

"88" appears on the remote controller when the address is registered or confirmed.

(1) Cause, check method and remedy

Cause	Check method and remedy
An error occurs when the address is registered or confirmed. (common)	
1. A wrong address is set to the unit to be coupled.	(1) Confirm the address of unit to be coupled.
2. The transmission line of the unit to be coupled is disconnected or is not connected.	(2) Check the connection of transmission line.
3. Circuit board failure of the unit to be coupled	(3) Check voltage of the terminal block for transmission line of the unit to be coupled.
4. Improper transmission line work	1) Normal if voltage is between DC17 and 30V. 2) Check (5) in case other than 1).
Generates at interlocking registration between LOSSNAY and the indoor unit	
5. The power of LOSSNAY is OFF.	(4) Check for the main power of LOSSNAY.
Generates at confirmation of controllers used in the system in which the indoor units connected to different outdoor units are grouped	
6. The power of the outdoor unit to be confirmed has been cut off.	(5) Check the power supply of the outdoor unit which is coupled with the unit to be confirmed.
7. Transmission line is disconnected from the terminal block for central control system connection (TB7) on the outdoor unit.	(6) Check that the transmission line for centralized control (TB7) of the outdoor unit is not disconnected.
8. When the indoor units connected to different outdoor units are grouped without MELANS, the male power supply connector is not connected to the female power supply switch connector (CN40) for the transmission line for centralized control.	(7) Check voltage of the transmission line for centralized control.
9. The male power supply connectors on 2 or more outdoor units are connected to the female power supply switch connector (CN40) for the transmission line for centralized control.	1) Normal when voltage is between 10V and 30V
10. In the system to which MELANS is connected, the male power supply connector is connected to the female power supply switch connector (CN40) for the transmission line for centralized control.	2) Check 8 - 11 described on the left in case other than 1).
11. Short circuit of the transmission line for centralized control	

Both for MA remote controller and M-NET remote controller

1. Phenomena

Although cooling operation starts with the normal remote controller display, the capacity is not enough

(1) Cause, check method and remedy

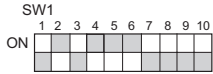
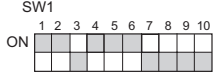
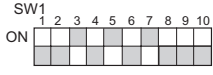
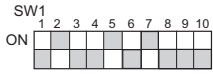

Cause	Check method and remedy
<p>1. Compressor frequency does not rise sufficiently.</p> <ul style="list-style-type: none"> ♦Faulty detection of pressure sensor. ♦Protection works and compressor frequency does not rise due to high discharge temperature ♦Protection works and compressor frequency does not rise due to high pressure ♦Pressure drops excessively. 	<p>(1) Check pressure difference between the detected pressure by the pressure sensor and the actual pressure with self-diagnosis LED. -> If the accurate pressure is not detected, check the pressure sensor. (Refer to the page on Troubleshooting of Pressure Sensor).</p> <p>Note: Lower inlet pressure by the low pressure sensor than the actual pressure causes insufficient capacity. SW1 setting</p> <p>High pressure sensor</p>  <p>Low pressure sensor</p>  <p>(2) Check temperature difference between the evaporating temperature (Te) and the target evaporating temperature (Tem) with self-diagnosis LED.</p> <p>Note: Higher Te than Tem causes insufficient capacity. SW1 setting</p> <p>Evaporating temperature Te</p>  <p>Target evaporating temperature Tem</p>  <p>Note: Protection works and compressor frequency does not rise even at higher Te than Tem due to high discharge temperature and high pressure. At high discharge temperature: Refer to 1102.(page 154) At high pressure: Refer to 1302.(page 156)</p>
<p>2. Indoor unit LEV malfunction</p> <ul style="list-style-type: none"> ♦Insufficient refrigerant flows due to LEV malfunction (not enough opening) or protection works and compressor frequency does not rise due to pressure drop. ♦Refrigerant leak from LEV on the stopping unit causes refrigerant shortage on the running unit. 	<p>Refer to the page of LEV troubleshooting ([4] -5-).(page 238)</p>
<p>3. RPM error of the outdoor unit FAN</p> <ul style="list-style-type: none"> ♦Motor failure or board failure, or airflow rate decrease due to clogging of the heat exchanger ♦The fan is not properly controlled as the outdoor temperature cannot be precisely detected by the temperature sensor. ♦The fan is not properly controlled as the pressure cannot be precisely detected by the pressure sensor. 	<p>Refer to the page on troubleshooting of the outdoor unit fan. Refer to 5106.(page 185) Refer to 1302.(page 156)</p>

Cause	Check method and remedy
4. Long piping length The cooling capacity varies greatly depending on the pressure loss. (When the pressure loss is large, the cooling capacity drops.)	Check the piping length to determine if it is contributing to performance loss. Piping pressure loss can be estimated from the temperature difference between the indoor unit heat exchanger outlet temperature and the saturation temperature (Te) of 63LS. ->Correct the piping.
5. Piping size is not proper (thin)	
6. Insufficient refrigerant amount Protection works and compressor frequency does not rise due to high discharge temperature.	Refer to 1-1. (Compressor frequency does not rise sufficiently.)Refer to the page on refrigerant amount adjustment
7. Clogging by foreign object	Check the temperature difference between in front of and behind the place where the foreign object is clogging the pipe (upstream side and downstream side). When the temperature drops significantly, the foreign object may clog the pipe. -> Remove the foreign object inside the pipe.
8. The indoor unit inlet temperature is excessively. (Less than 15°C [59°F] WB)	Check the inlet air temperature and for short cycling. Change the environment where the indoor unit is used.
9. Compressor failure The amount of circulating refrigerant decreases due to refrigerant leak in the compressor.	Check the discharge temperature to determine if the refrigerant leaks, as it rises if there is a leak.
10. LEV1 malfunction Sufficient liquid refrigerant is not be supplied to the indoor unit as sufficient sub cool cannot be secured due to LEV1 malfunction.	Refer to the page of LEV troubleshooting ([4] -5-).(page 238) It most likely happens when there is little difference or no difference between TH3 and TH6.
11. TH3, TH6 and 63HS1 sensor failure or faulty wiring LEV1 is not controlled normally.	<ul style="list-style-type: none"> ◆Check the thermistor. ◆Check wiring.
12. LEV2 actuation failure A drop in the low pressure that is caused either by a blockage of liquid pipe or by a pressure loss and the resultant slowing of refrigerant flow causes a tendency for the discharge temperature to rise.	Refer to the page on troubleshooting the LEV ([4] -5-).(page 238)

2. Phenomena

Although heating operation starts with the normal remote controller display, the capacity is not enough.

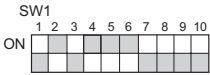
(1) Cause, check method and remedy

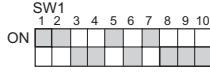
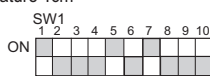
Cause	Check method and remedy
<p>1. Compressor frequency does not rise sufficiently.</p> <ul style="list-style-type: none"> ♦Faulty detection of pressure sensor. ♦Protection works and compressor frequency does not rise due to high discharge temperature ♦Protection works and compressor frequency does not rise due to high pressure. 	<p>(1) Check pressure difference between the detected pressure by the pressure sensor and the actual pressure with self-diagnosis LED. -> If the accurate pressure is not detected, check the pressure sensor.(Refer to the page on Troubleshooting of Pressure Sensor)</p> <p>Note: Higher inlet pressure by the high pressure sensor than the actual pressure causes insufficient capacity. SW1 setting</p> <p>High pressure sensor</p>  <p>Low pressure sensor</p>  <p>(2) Check the difference between the condensing temperature (Tc) and the target condensing temperature (Tcm) with self-diagnosis LED.</p> <p>Note: Higher Tc than Tcm causes insufficient capacity. SW1 setting</p> <p>Condensing temperature Tc</p>  <p>Target condensing temperature Tcm</p>  <p>Note: Protection works and compressor frequency does not rise even at lower Tc than Tcm due to high discharge temperature and high pressure. At high discharge temperature: Refer to 1102.(page 154) At high pressure: Refer to 1302.(page 156)</p>

Cause	Check method and remedy
2. Indoor unit LEV malfunction Insufficient refrigerant flows due to LEV malfunction (not enough opening).	Refer to the page of LEV troubleshooting ([4] -5-).(page 238)
3. Temperature reading error on the indoor unit piping temperature sensor If the temperature reading on the sensor is higher than the actual temperature, it makes the subcool seem smaller than it is, and the LEV opening decreases too much.	Check the thermistor.
4 RPM error of the outdoor unit FAN ♦Motor failure or board failure, or airflow rate decrease, pressure drop due to clogging of the heat exchanger leading to high discharge temperature ♦The fan is not properly controlled as the temperature cannot be precisely detected with the piping sensor.	Refer to the page on outdoor unit fan ([4] -4-).(page 237)
5. Insulation failure of the refrigerant piping	
6. Long piping length Excessively long piping on the high pressure side causes pressure loss leading to increase in the high pressure.	Confirm that the characteristic of capacity drop due to piping length. -> Change the pipe
7. Piping size is not proper (thin)	
8. Clogging by foreign object	Check the temperature difference between the upstream and the downstream of the pipe section that is blocked. Since blockage in the extended section is difficult to locate, operate the unit in the cooling cycle, and follow the same procedures that are used to locate the blockage of pipe during cooling operation. ->Remove the blockage in the pipe.
9. The indoor unit inlet temperature is excessively high.(exceeding 28°C [82°F])	Check the inlet air temperature and for short cycling. Change the environment where the indoor unit is used.
10. Insufficient refrigerant amount Protection works and compressor frequency does not rise due to low discharge temperature Refrigerant recovery operation is likely to start.	Refer to 2 - 1. (Compressor frequency does not rise sufficiently.)(page 226) Refer to the page on refrigerant amount adjustment.(page 117)
11. Compressor failure (same as in case of cooling)	Check the discharge temperature.
12. LEV2 actuation failure A drop in the low pressure that is caused either by a blockage of liquid pipe or by a pressure loss and the resultant slowing of refrigerant flow causes a tendency for the discharge temperature to rise.	Refer to the page on troubleshooting the LEV ([4] -5-).(page 238)

3. Phenomena

Outdoor unit stops at times during operation.

(1) Cause, check method and remedy

Cause	Check method and remedy
<p>The first stop is not considered as an error, as the unit turns to anti-restart mode for 3 minutes as a preliminary error.</p> <p>Error mode</p> <p>1) Abnormal high pressure</p> <p>2) Abnormal discharge air temperature</p> <p>3) Heatsink thermistor failure</p> <p>4) Thermistor failure</p> <p>5) Pressure sensor failure</p> <p>6) Over-current break</p> <p>7) Refrigerant overcharge</p> <p>Note1: Frost prevention tripping only under cooling mode may be considered in addition to the above. (Freeze protection is detected by one or all indoor units.)</p> <p>Note2: Even the second stop is not considered as an error when some specified errors occur. (eg. The third stop is considered as an error when the thermistor error occurs.)</p>	<p>(1) Check the mode operated in the past by displaying preliminary error history on LED display with SW1.</p> <p>(2) Reoperate the unit to find the mode that stops the unit by displaying preliminary error history on LED display with SW1. Refer to the reference page for each error mode.</p> <p>*Display the indoor piping temperature table with SW1 to check whether the freeze proof operation runs properly, and check the temperature.</p>

[3] Investigation of Transmission Wave Shape/Noise

1. M-NET transmission

Control is performed by exchanging signals between the outdoor unit and the indoor unit (M-NET remote controller) through M-NET transmission. Noise interference on the transmission line will interrupt the normal transmission, leading to erroneous operation.

(1) Symptoms caused by noise interference on the transmission line

Cause	Erroneous operation	Error code	Error code definition
Noise interference on the transmission line	Signal is transformed and will be misjudged as the signal of another address.	6600	Address overlap
	Transmission wave pattern is transformed due to the noise creating a new signal	6602	Transmission processor hardware error
	Transmission wave pattern is transformed due to the noise, and will not be received normally leading to no acknowledgement (ACK).	6607	No ACK error
	Transmission cannot be performed due to the fine noise.	6603	Transmission line bus busy error
	Transmission is successful; however, the acknowledgement (ACK) or the response cannot be received normally due to the noise.	6607 6608	No ACK error No response error

(2) Wave shape check

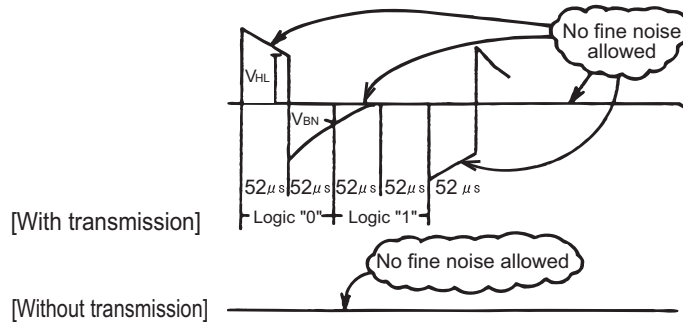

Wave shape check

Check the wave pattern of the transmission line with an oscilloscope. The following conditions must be met.

- Small wave pattern (noise) must not exist on the transmission signal. (Minute noise (approximately 1V) can be generated by DC-DC converter or the inverter operation; however, such noise is not a problem when the shield of the transmission line is grounded.)
- The sectional voltage level of transmission signal should be as follows.

Logic	Voltage level of the transmission line
0	$V_{HL} = 2.5V$ or higher
1	$V_{BN} = 1.3V$ or below

(3) Check method and remedy

1) Measures against noise

Check the followings when noise exists on the wave or the errors described in (1) occur.

	Error code definition	Remedy
Check that the wiring work is performed according to wiring specifications.	1. The transmission line and the power line are not wired too closely.	Isolate the transmission line from the power line (5cm [1-31/32"] or more). Do not insert them in the same conduit.
	2. The transmission line is not bundled with that for another systems.	The transmission line must be isolated from another transmission line. When they are bundled, erroneous operation may be caused.
	3. The specified wire is used for the transmission line.	Use the specified transmission line. Type: Shielded wire CVVS/CPEVS/MVVS (For M-NET remote controller) Diameter: 1.25mm ² [AWG16] or more (Remote controller wire: 0.3 - 1.25mm ² [AWG22-16])
	4. When the transmission line is daisy-chained on the indoor unit terminals, are the shields daisy-chained on the terminals, too?	The transmission is two-wire daisy-chained. The shielded wire must be also daisy-chained. When the shielded cable is not daisy-chained, the noise cannot be reduced enough.
Check that the grounding work is performed according to grounding specifications.	5. Is the shield of the indoor-outdoor transmission cable grounded to the earth terminal on the outdoor unit?	Connect the shield of the indoor-outdoor transmission cable to the earth terminal (♣) on the outdoor unit. If no grounding is provided, the noise on the transmission line cannot escape leading to change of the transmission signal.
	6. Check the treatment method of the shield of the transmission line (for centralized control).	The transmission cable for centralized control is less subject to noise interference if it is grounded to the outdoor unit whose power jumper cable was moved from CN41 to CN40 or to the power supply unit. The environment against noise varies depending on the distance of the transmission lines, the number of the connected units, the type of the controllers to be connected, or the environment of the installation site. Therefore, the transmission line work for centralized control must be performed as follows. 1. When no grounding is provided: Ground the shield of the transmission cable by connecting to the outdoor unit whose power jumper connector was moved from CN41 to CN40 or to the power supply unit. 2. When an error occurs even though one point grounding is provided: Ground the shield on all outdoor units.

2) Check the followings when the error "6607" occurs, or "HO" appears on the display on the remote controller.

Error code definition	Remedy
7. The farthest distance of transmission line is 200m [656ft] or longer.	Check that the farthest distance from the outdoor unit to the indoor unit and to the remote controller is within 200m [656ft].
8. The types of transmission lines are different.	Use the specified transmission line. Type: Shielded wire CVVS/CPEVS/MVVS (For M-NET remote controller) Diameter: 1.25mm ² [AWG16] or more (Remote controller wire: 0.3-1.25mm ² [AWG22-16])
9. Outdoor unit circuit board failure	Replace the outdoor unit control board or the power supply board for the transmission line.
10. Indoor unit circuit board failure or remote controller failure	Replace the indoor unit circuit board or the remote controller.
11. The MA remote controller is connected to the M-NET transmission line.	Connect the MA remote controller to the terminal block for MA remote controller (TB15).

2. MA remote controller transmission

The communication between the MA remote controller and the indoor unit is performed with current tone burst.

(1) Symptoms caused by noise interference on the transmission line

If noise is generated on the transmission line, and the communication between the MA remote controller and the indoor unit is interrupted for 3 minutes in a row, MA transmission error (6831) will occur.

(2) Confirmation of transmission specifications and wave pattern

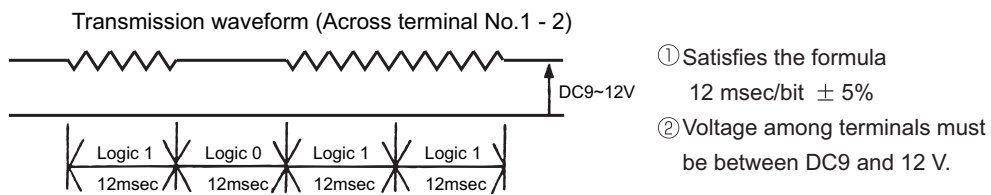
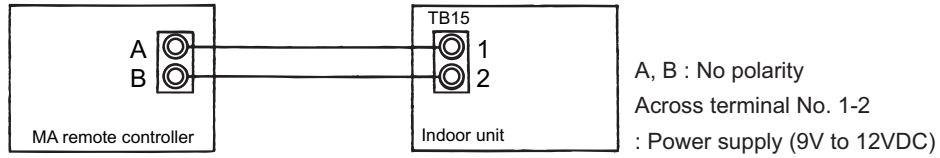

[4] Troubleshooting Principal Parts

-1- High-Pressure Sensor (63HS1)

1. Compare the pressure that is detected by the high pressure sensor, and the high-pressure gauge pressure to check for failure.

By configuring the digital display setting switch (SW1) as shown in the figure below, the pressure as measured by the high-pressure sensor appears on the LED1 on the control board.

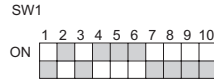

(1) While the sensor is stopped, compare the gauge pressure and the pressure displayed on self-diagnosis LED1.

- 1) When the gauge pressure is between 0 and 0.098MPa [14psi], internal pressure is caused due to gas leak.
- 2) When the pressure displayed on self-diagnosis LED1 is between 0 and 0.098MPa [14psi], the connector may be defective or be disconnected. Check the connector and go to (4).
- 3) When the pressure displayed on self-diagnosis LED1 exceeds 4.15MPa [601psi], go to (3).
- 4) If other than 1), 2) or 3), compare the pressures while the sensor is running. Go to (2).

(2) Compare the gauge pressure and the pressure displayed on self-diagnosis LED1 while the sensor is running. (Compare them by MPa [psi] unit.)

- 1) When the difference between both pressures is within 0.098MPa [14psi], both the high pressure sensor and the control board are normal.
- 2) When the difference between both pressures exceeds 0.098MPa [14psi], the high pressure sensor has a problem. (performance deterioration)
- 3) When the pressure displayed on self-diagnosis LED1 does not change, the high pressure sensor has a problem.

(3) Remove the high pressure sensor from the control board to check the pressure on the self-diagnosis LED1.

- 1) When the pressure displayed on self-diagnosis LED1 is between 0 and 0.098MPa [14psi], the high pressure sensor has a problem.
- 2) When the pressure displayed on self-diagnosis LED1 is approximately 4.15MPa [601psi], the control board has a problem.

(4) Remove the high pressure sensor from the control board, and short-circuit between the No.2 and 3 connectors (63HS1) to check the pressure with self-diagnosis LED1.

- 1) When the pressure displayed on the self-diagnosis LED1 exceeds 4.15MPa [601psi], the high pressure sensor has a problem.
- 2) If other than 1), the control board has a problem.

2. High-pressure sensor configuration

The high pressure sensor consists of the circuit shown in the figure below. If DC 5V is applied between the red and the black wires, voltage corresponding to the pressure between the white and the black wires will be output, and the value of this voltage will be converted by the microcomputer. The output voltage is 0.071V per 0.098MPa [14psi].

Note

The pressure sensor on the body side is designed to connect to the connector. The connector pin number on the body side is different from that on the control board side.

	Body side	Control board side
Vcc	Pin 1	Pin 3
Vout	Pin 2	Pin 2
GND	Pin 3	Pin 1

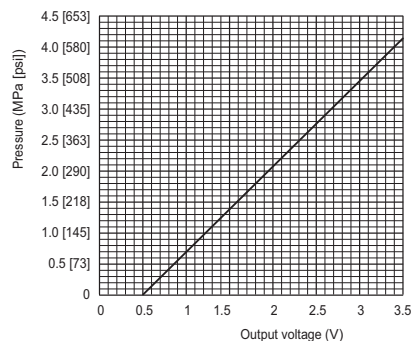
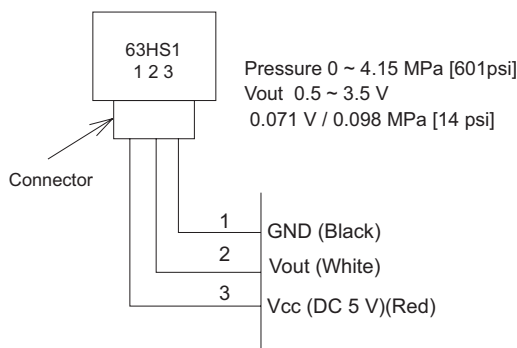

-2- Low-Pressure Sensor (63LS)

1. Compare the pressure that is detected by the low pressure sensor, and the low pressure gauge pressure to check for failure.

By configuring the digital display setting switch (SW1) as shown in the figure below, the pressure as measured by the low-pressure sensor appears on the LED1 on the control board.

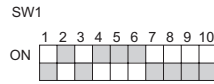

(1) While the sensor is stopped, compare the gauge pressure and the pressure displayed on self-diagnosis LED1.

- 1) When the gauge pressure is between 0 and 0.098MPa [14psi], internal pressure is caused due to gas leak.
- 2) When the pressure displayed on self-diagnosis LED1 is between 0 and 0.098MPa [14psi], the connector may be defective or be disconnected. Check the connector and go to (4).
- 3) When the pressure displayed on self-diagnosis LED1 exceeds 1.7MPa [247psi], go to (3).
- 4) If other than 1), 2) or 3), compare the pressures while the sensor is running. Go to (2).

(2) Compare the gauge pressure and the pressure displayed on self-diagnosis LED1 while the sensor is running.(Compare them by MPa [psi] unit.)

- 1) When the difference between both pressures is within 0.03MPa [4psi], both the low pressure sensor and the control board are normal.
- 2) When the difference between both pressures exceeds 0.03MPa [4psi], the low pressure sensor has a problem. (performance deterioration)
- 3) When the pressure displayed on the self-diagnosis LED1 does not change, the low pressure sensor has a problem.

(3) Remove the low pressure sensor from the control board to check the pressure with the self-diagnosis LED1 display.

- 1) When the pressure displayed on the self-diagnosis LED1 is between 0 and 0.098MPa [14psi], the low pressure sensor has a problem.
- 2) When the pressure displayed on self-diagnosis LED1 is approximately 1.7MPa [247psi], the control board has a problem.
 - When the outdoor temperature is 30°C [86°F] or less, the control board has a problem.
 - When the outdoor temperature exceeds 30°C [86°F], go to (5).

(4) Remove the low pressure sensor from the control board, and short-circuit between the No.2 and 3 connectors (63LS:CN202) to check the pressure with the self-diagnosis LED1.

- 1) When the pressure displayed on the self-diagnosis LED1 exceeds 1.7MPa [247psi], the low pressure sensor has a problem.
- 2) If other than 1), the control board has a problem.

(5) Remove the high pressure sensor (63HS1) from the control board, and insert it into the connector for the low pressure sensor (63LS) to check the pressure with the self-diagnosis LED1.

- 1) When the pressure displayed on the self-diagnosis LED1 exceeds 1.7MPa [247psi], the control board has a problem.
- 2) If other than 1), the control board has a problem.

2. Low-pressure sensor configuration

The low pressure sensor consists of the circuit shown in the figure below. If DC5V is applied between the red and the black wires, voltage corresponding to the pressure between the white and the black wires will be output, and the value of this voltage will be converted by the microcomputer. The output voltage is 0.173V per 0.098MPa [14psi].

Note

The pressure sensor on the body side is designed to connect to the connector. The connector pin number on the body side is different from that on the control board side.

	Body side	Control board side
Vcc	Pin 1	Pin 3
Vout	Pin 2	Pin 2
GND	Pin 3	Pin 1

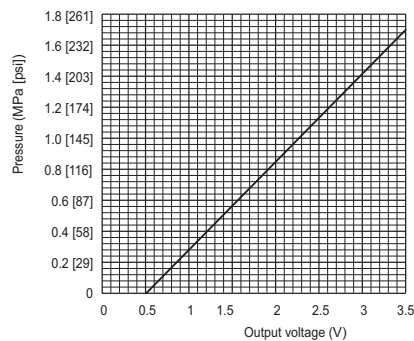
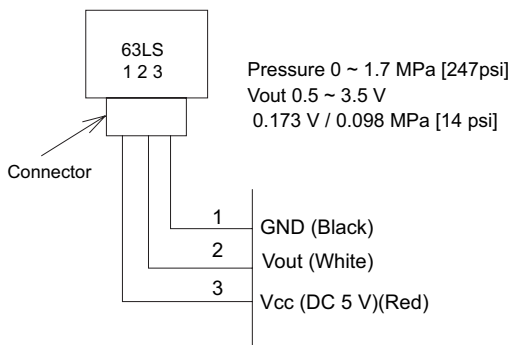

-3- Solenoid Valve

Check whether the output signal from the control board and the operation of the solenoid valve match. Setting the self-diagnosis switch (SW1) as shown in the figure below causes the ON signal of each relay to be output to the LED's. Each LED shows whether the relays for the following parts are ON or OFF. LEDs light up when relays are ON.

Note

The circuits on some parts are closed when the relays are ON. Refer to the following instructions.

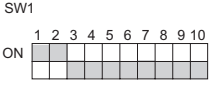
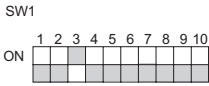
SW1		Display							
		LD1	LD2	LD3	LD4	LD5	LD6	LD7	LD8
	Upper	21S4a		CH11		SV1a			
	Lower			21S4b	SV5b				
	Upper				SV5c	21S4c		SV9	
	Lower								

When a valve malfunctions, check if the wrong solenoid valve coil is not attached the lead wire of the coil is not disconnected, the connector on the board is not inserted wrongly, or the wire for the connector is not disconnected.

(1) In case of 21S4a (4-way switching valve)

About this 4-way valve

When not powered:

Conducts electricity between the oil separator outlet and heat exchanger, and between the gas ball valve (BV1) and the accumulator to complete the circuit for the cooling cycle.

When powered:

The electricity runs between the oil separator and the gas ball valve, and between the heat exchanger and the accumulator. This circulation is for heating.

Check the LED display and the intake and the discharge temperature for the 4-way valve to check whether the valve has no faults and the electricity runs between where and where. Do not touch the pipe when checking the temperature, as the pipe on the oil separator side will be hot.

Note

Do not give an impact from outside, as the outer hull will be deformed leading to the malfunction of the inner valve.

(2) In case of 21S4b (4-way switching valve), 21S4c (4-way switching valve) (only for P120 model)

About this 4-way valve

When not powered:

Conducts electricity between the oil separator outlet and the heat exchanger1 (the top heat exchanger) and opens and closes the heat exchanger circuit for the heating and cooling cycles.

When powered:

The electricity runs between the heat exchanger and the accumulator, and the valve opens or closes the heat exchanger circuit when cooling or heating.

Whether the valve has no fault can be checked by checking the LED display and the switching sound; however, it may be difficult to check by the sound, as the switching coincides with 21S4b or 21S4c. In this case, check the intake and the discharge temperature for the 4-way valve to check that the electricity runs between where and where.

Note

- Do not touch the valve when checking the temperature, as it will be hot.
- Do not give an impact from outside, as the outer hull will be deformed leading to the malfunction of the inner valve.

(3) In case of SV1a (Bypass valve)

This solenoid valve opens when powered (Relay ON).

- 1) At compressor start-up, the SV1a turns on for 4 minutes, and the operation can be checked by the self-diagnosis LED display and the closing sound.
- 2) To check whether the valve is open or closed, check the change of the SV1a downstream piping temperature while the valve is being powered. Even when the valve is closed, high-temperature refrigerant flows inside the capillary next to the valve. (Therefore, temperature of the downstream piping will not be low with the valve closed.)

(4) In the case of SV5b (Solenoid valve) , SV5c (Solenoid valve) (only for P120 model)

This solenoid valve is a switching valve that opens when energized. Proper operation of this valve can be checked on the LED and by the switching sound. During the cooling mode, SV5b and 21S4b, SV5c and 21S4c, are switched simultaneously, which may make it difficult to check for proper operation of the SV5b or SV5c by listening for the switching sound. If this is the case, the temperature before and after SV5b or SV5c can be used to determine if the refrigerant is the pipe.

(5) In the case of SV9 (Solenoid valve)

This solenoid valve is a switching valve that opens when energized. Proper operation of this valve can be checked on the LED display and by the switching sound.

Note

Do not give an impact from outside, as the outer hull will be deformed leading to the malfunction of the inner valve.

-4- Outdoor Unit Fan

- ♦To check the revolution of the fan, check the inverter output state on the self-diagnosis LED, as the inverter on the outdoor fan controls the revolutions of the fan.
- ♦When starting the fan, the fan runs at full speed for 5 seconds.
- ♦When setting the DIP SW1 as shown in the figure below, the inverter output [%] will appear. 100% indicates the full speed and 0% indicates the stopping.

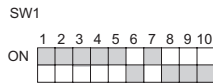

- ♦As the revolution of the fan changes under control, at the interphase or when the indoor unit operation capacity is low, the revolution of the fan may change.
- ♦If the fan does not move or it vibrates, Fan board problem or fan motor problem is suspected. Refer to IX [4] -6- (2) [5] "Check the fan motor ground fault or the winding." and IX [4] -6- (2) [6] "Check the Fan board failure."

-5- LEV

LEV operation

LEV (Indoor unit: Linear expansion valve), LEV2a, and LEV2b (Outdoor unit: Linear expansion valve) are stepping-motor-driven valves that operate by receiving the pulse signals from the indoor and outdoor unit control boards.

(1) Indoor LEV and Outdoor LEV (LEV2a, LEV2b)

The valve opening changes according to the number of pulses.

- 1) Indoor and outdoor unit control boards and the LEV (Indoor unit: Linear expansion valve)

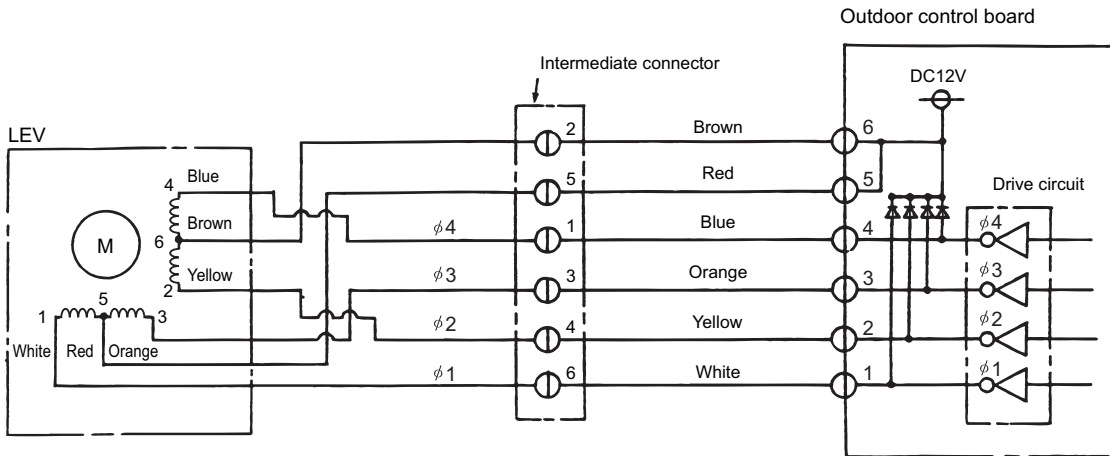

Note. The connector numbers on the intermediate connector and the connector on the control board differ. Check the color of the lead wire to judge the number.

2) Pulse signal output and valve operation

Output (phase) number	Output state			
	1	2	3	4
φ 1	ON	OFF	OFF	ON
φ 2	ON	ON	OFF	OFF
φ 3	OFF	ON	ON	OFF
φ 4	OFF	OFF	ON	ON

Output pulses change in the following orders when the
 Valve is closed; 1 → 2 → 3 → 4 → 1
 Valve is open; 4 → 3 → 2 → 1 → 4

- *1. When the LEV opening angle does not change, all the output phases will be off.
- *2. When the output is open phase or remains ON, the motor cannot run smoothly, and rattles and vibrates.

3) LEV valve closing and opening operation

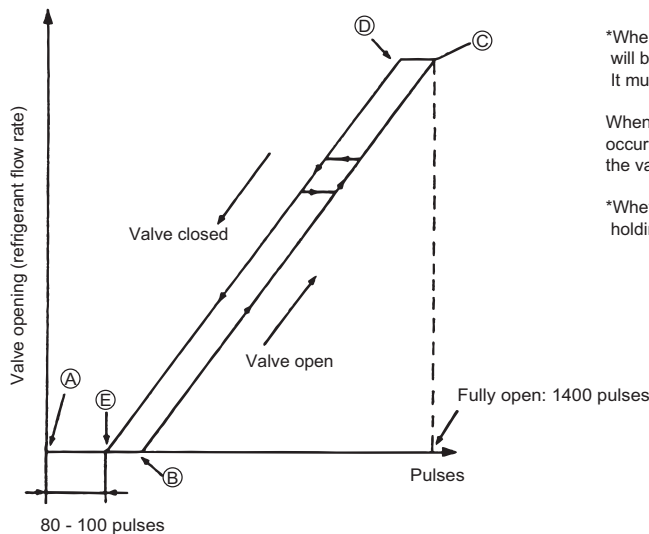

*When the power is turned on, the valve closing signal of 2200 pulses will be output from the indoor board to LEV to fix the valve position. It must be fixed at point A

When the valve operates smoothly, no sound from LEV or no vibration occurs, however, when the pulses change from E to A in the chart or the valve is locked, a big sound occurs.

*Whether a sound is generated or not can be determined by holding a screwdriver against it, then placing your ear against the handle.

(2) Outdoor LEV (LEV1)

The valve opening changes according to the number of pulses.

1) Connections between the outdoor control board and LEV1 (outdoor expansion valve)

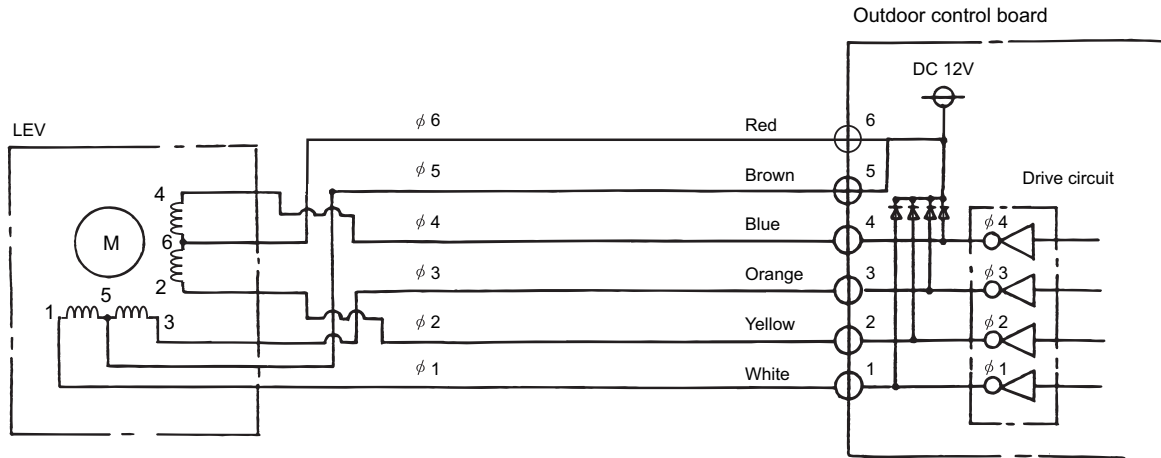

2) Pulse signal output and valve operation

Output (phase) number	Output state							
	1	2	3	4	5	6	7	8
φ 1	ON	OFF	OFF	OFF	OFF	OFF	ON	ON
φ 2	ON	ON	ON	OFF	OFF	OFF	OFF	OFF
φ 3	OFF	OFF	ON	ON	ON	OFF	OFF	OFF
φ 4	OFF	OFF	OFF	OFF	ON	ON	ON	OFF

Output pulses change in the following orders when the
 Valve is open; 1 → 2 → 3 → 4 → 5 → 6 → 7 → 8 → 1
 Valve is closed; 8 → 7 → 6 → 5 → 4 → 3 → 2 → 1 → 8

- *1. When the LEV opening angle does not change, all the output phases will be off.
- *2. When the output is open phase or remains ON, the motor cannot run smoothly, and rattles and vibrates.

3) LEV valve closing and opening operation

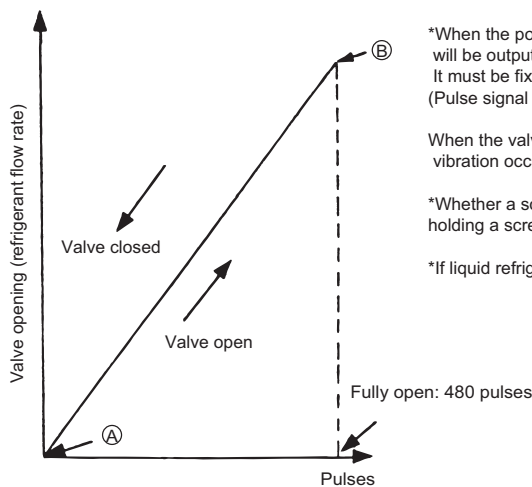

*When the power is turned on, the valve closing signal of 520 pulses will be output from the indoor board to LEV to fix the valve position. It must be fixed at point (A) (Pulse signal is output for approximately 17 seconds.)

When the valve operates smoothly, there is no sound from the LEV and no vibration occurs, but when the valve is locked, noise is generated.

*Whether a sound is generated or not can be determined by holding a screwdriver against it, then placing your ear against the handle.

*If liquid refrigerant flows inside the LEV, the sound may become smaller.

(3) Judgment methods and possible failure mode

Note

The specifications of the outdoor unit (outdoor LEV) and the indoor unit (indoor LEV) differ. Therefore, remedies for each failure may vary. Check the remedy specified for the appropriate LEV as indicated in the right column.

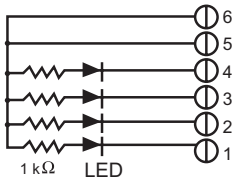
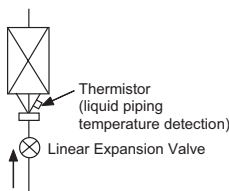
Malfunction mode	Judgment method	Remedy	Target LEV
Microcomputer driver circuit failure	<p>Disconnect the control board connector and connect the check LED as shown in the figure below.</p>  <p>resistance : 0.25W 1kΩ LED : DC15V 20mA or more</p> <p>When the main power is turned on, the indoor unit circuit board outputs pulse signals to the indoor unit LEV for 10 seconds, and the outdoor unit circuit board outputs pulse signals to the outdoor unit LEV for 17 seconds.</p> <p>If any of the LED remains lit or unlit, the drive circuit is faulty.</p>	When the drive circuit has a problem, replace the control board.	Indoor Outdoor
LEV mechanism is locked	If the LEV is locked, the drive motor runs idle, and makes a small clicking sound. When the valve makes a closing and opening sound, the valve has a problem.	Replace the LEV.	Indoor Outdoor
Disconnected or short-circuited LEV motor coil	Measure resistance between the coils (red - white, red - orange, brown - yellow, brown - blue) using a tester. They are normal if resistance is 150ohm ± 10%.	Replace the LEV coils.	Indoor Outdoor (LEV2a, LEV2b)
	Measure resistance between the coils (red - white, red - orange, brown - yellow, brown - blue) using a tester. They are normal if resistance is 46ohm ± 3%.	Replace the LEV coils.	Outdoor (LEV1)
Incomplete sealing (leak from the valve)	<p>When checking the refrigerant leak from the indoor LEV, run the target indoor unit in the fan mode, and the other indoor units in the cooling mode. Then, check the liquid temperature (TH22) with the self-diagnosis LED.</p> <p>When the unit is running in the fan mode, the LEV is fully closed, and the temperature detected by the thermistor is not low. If there is a leak, however, the temperature will be low. If the temperature is extremely low compared with the inlet temperature displayed on the remote controller, the LEV is not properly sealed, however, if there is a little leak, it is not necessary to replace the LEV when there are no effects to other parts.</p> 	If there is a large amount of leakage, replace the LEV.	Indoor
Faulty wire connections in the connector or faulty contact	<ol style="list-style-type: none"> 1. Check for loose pins on the connector and check the colors of the lead wires visually 2. Disconnect the control board's connector and conduct a continuity check using a tester. 	Check the continuity at the points where an error occurs.	Indoor Outdoor

(4) Outdoor unit LEV (LEV1) coil removal procedure

1) LEV component

As shown in the figure, the outdoor LEV is made in such a way that the coils and the body can be separated.

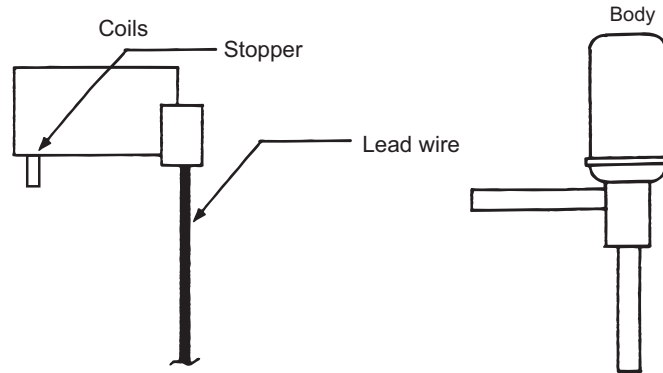

2) Removing the coils

Fasten the body tightly at the bottom (Part A in the figure) so that the body will not move, then pull out the coils toward the top. If the coils are pulled out without the body gripped, undue force will be applied and the pipe will be bent.

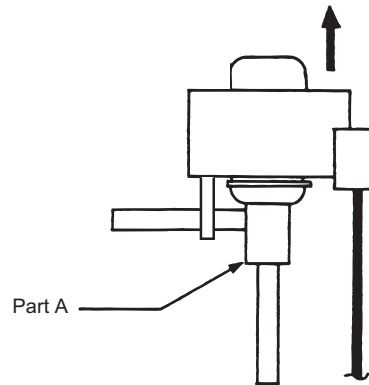

3) Installing the coils

Fix the body tightly at the bottom (Part A in the figure) so that the body will not move, then insert the coils from the top, and insert the coil stopper securely in the pipe on the body. Hold the body when pulling out the coils to prevent so that the pipe will not be bent.

If the coils are pushed without the body gripped, undue force will be applied and the pipe will be bent. Hold the body when pulling out the coils to prevent so that the pipe will not be bent.

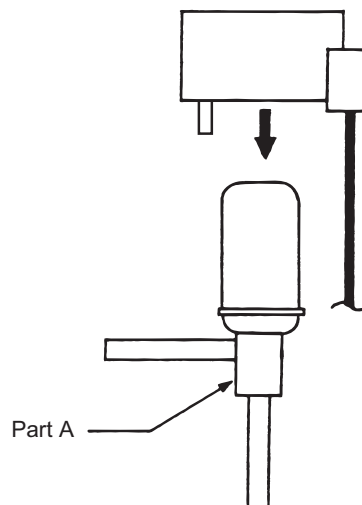

(5) Outdoor unit LEV (LEV2a,2b) coil removal procedure

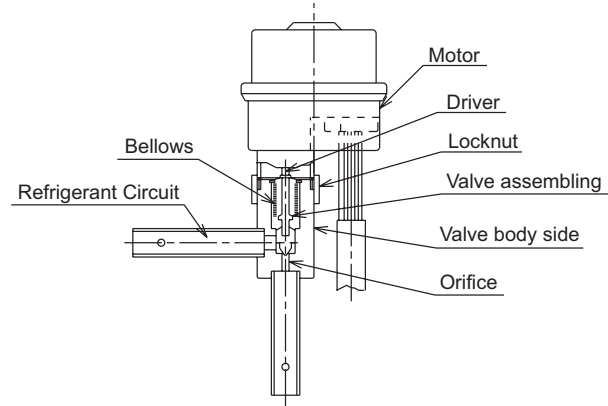

Notes on the procedure

- 1) Do not put undue pressure on the motor.
- 2) Do not use motors if dropped.
- 3) Do not remove the cap until immediately before the procedure.
- 4) Do not wipe off any molybdenum.
- 5) Do not remove the packing.
- 6) Do not apply any other than specified liquid such as screw lock agent, grease and etc.

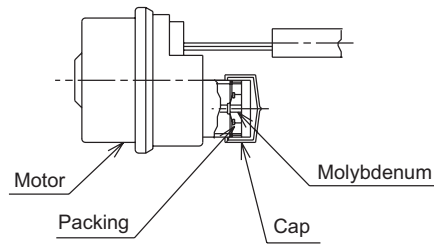

Replacement procedure

- 1) Stop the air conditioner. After checking that the air conditioner is stopped, turn off the power of the outdoor unit.
- 2) Prepare two spanners. Hold the valve body with one spanner and loosen the locknut with another one. Turning the locknut counter-clockwise from motor side view can loosen it. Two spanners must be used. Do not hold the motor with one hand and loosen the locknut with only one spanner.
- 3) Turning the locknut several times. The locknut will come off and then the motor can be removed.
- 4) Prepare a motor replacement. Use only factory settings, which the head part of the driver does not come out. **Use of other than factory settings may result in malfunction and failure of valve flow rate control.**
- 5) Keep dust, contaminants, and water out of the space between the motor and the valve body during replacement. (The space is the mechanical section of the valve.) Do not damage the junction with tools. After removing the motor, **blow N₂ gas or etc. into bellows in order to blow off water from inside.**
- 6) Remove the cap of the motor replacement. Joint the axis of the motor and the one of the valve body with the locknut to stick precisely. **Apply screw lock agent to whole part of the screw. Do not introduce screw lock agent into the motor.** Use new motors if problems are found on the motor during the replacement.
- 7) After rotating the locknut 2~3 times by hands, hold the valve body with the spanner, and tighten the locknut with the specified torque with a torque wrench. Apply the tightening torque of 15N · m (150kgf · cm) (administration value 15 ± 1 N · m (150 ± 10kgf · cm)). Note that undue tightening may cause breaking a flare nut.
- 8) When tightening the locknut, hold the motor with hands so that undue rotary torque and load can not be applied.
- 9) The differences of relative position after assembling the motor and the valve body do not affect the valve control and the switching function. Do not relocate the motor and the valve body after tightening the locknut. Even the relative position is different from before and after assembling.

Difference in rotational direction is acceptable.

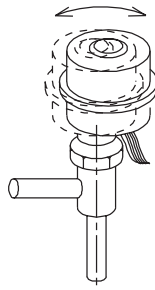

The motor may not be fixed with clamp because of the changing of the motor configuration. However, the fixing is not necessary due to the pipe fixing.

- 10) Connect the connector. Do not pull hard on the lead wire. Make sure that the connector is securely inserted into the specified position, and check that the connector does not come off easily.
- 11) Turn on the indoor unit, and operate the air conditioner. Check that no problems are found.

-6- Inverter (THMU-A)

- Replace only the compressor if only the compressor is found to be defective. (Overcurrent will flow through the inverter if the compressor is damaged, however, the power supply is automatically cut when overcurrent is detected, protecting the inverter from damage.)
- Replace only the fan motor if only the fan motor is found to be defective. (Overcurrent will flow through the inverter if the fan motor is damaged, however, the power supply is automatically cut when overcurrent is detected, protecting the inverter from damage.)
- Replace the defective components if the inverter is found to be defective.
- If both the compressor and the inverter are found to be defective, replace the defective component(s) of both devices.

(1) Inverter-related problems: Troubleshooting and remedies

- 1) The INV board has a large-capacity electrolytic capacitor, in which residual voltage remains even after the main power is turned off, posing a risk of electric shock. Before inspecting the inverter-related items, turn off the main power, wait for 5 to 10 minutes, and confirm that the voltage at both ends of the electrolytic capacitor has dropped to a sufficiently low level.
- 2) The IPM on the inverter becomes damaged if there are loose screws or connectors. If a problem occurs after replacing some of the parts, mixed up wiring is often the cause of the problem. Check for proper connection of the wiring, screws, connectors, and Faston terminals.
- 3) To avoid damage to the circuit board, do not connect or disconnect the inverter-related connectors with the main power turned on.
- 4) Current sensors become damaged if electricity is passed through without them being connected to the circuit board. Connect the current sensor to the appropriate connectors on the circuit board before operating the inverter.
- 5) Faston terminals have a locking function. Make sure the terminals are securely locked in place after insertion.

Press the tab on the terminals to remove them.

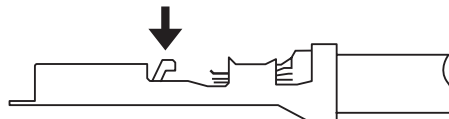

- 6) When the IPM, diode stack, or IGBT is replaced, apply a thin layer of heat radiation grease that is supplied evenly to these parts. Wipe off any grease that may get on the wiring terminal to avoid terminal contact failure.
- 7) Faulty wiring to the compressor damages the compressor. Connect the wiring in the correct phase sequence.

	Error display/failure condition	Measure/inspection item
[1]	Inverter related errors 4250, 4255, 4220, 4225, 4230, 4240, 4260, 5301, 0403	Check the details of the inverter error in the error log at 10.[1] Table of LED codes. Take appropriate measures to the error code and the error details in accordance with 9. [2] Self-diagnosis on the basis of Error Display on Remote Controller and Remedy for Error.
[2]	Main power breaker trip	<1> Check the breaker capacity. <2> Check whether the electrical system is short-circuited or ground-faulted. <3> If items cause is not <1> or <2> are not the causes of the problem, see (3)-[1].
[3]	Main power earth leakage breaker trip	<1> Check the earth leakage breaker capacity and the sensitivity current. <2> Meg failure for electrical system other than the inverter <3> If the cause is not <1> or <2>, see (3)-[1]
[4]	Only the compressor does not operate.	Check the inverter frequency on the LED monitor and proceed to (2) - [4] if the compressor is in operation.
[5]	The compressor vibrates violently at all times or makes an abnormal sound.	See (2)-[4].
[6]	Only the fan motor does not operate.	Check the inverter frequency on the LED monitor and proceed to (2)-[6] if the fan motor is in operation.
[7]	The fan motor shakes violently at all times or makes an abnormal sound.	Check the inverter frequency on the LED monitor and proceed to (2)-[6] if the fan motor is in operation.
[8]	Noise is picked up by the peripheral device	<1> Check that power supply wiring of the peripheral device does not run close to the power supply wiring of the outdoor unit. <2> Check that the inverter output wiring is not in close contact with the power supply wiring and the transmission lines. <3> Check that the shielded wire is used as the transmission line when it is required, and check that the grounding work is performed properly on the shielded wire. <4> Meg failure for electrical system other than the inverter <5> Attach a ferrite core to the inverter output wiring. (Contact the factory for details of the service part settings.) <6> Provide separate power supply to the air conditioner and other electric appliances. <7> If the error occurred suddenly, a ground fault of the inverter output can be considered. See (2)-[4]. *Contact the factory for cases other than those listed above.
[9]	Sudden malfunction (as a result of external noise.)	<1> Check that the grounding work is performed properly. <2> Check that the shielded wire is used as the transmission line when it is required, and check that the grounding work is performed properly on the shielded wire. <3> Check that neither the transmission line nor the external connection wiring does not run close to another power supply system or does not run through the same conduit pipe. * Contact the factory for cases other than those listed above.

(2) Inverter output related troubles

	Items to be checked	Phenomena	Remedy	
[1] Check the INV board error detection circuit.	<P72 and P96 models>	1) IPM/overcurrent breaker trip Error code: 4250 Detail code: No. 101, 104, 105, 106, and 107	Replace the INV board.	
		2) Logic error Error code: 4220 Detail code: No. 111	Replace the INV board.	
		3) ACCT sensor circuit failure Error code: 5301 Detail code: No.117	Replace the INV board.	
		4) IPM open Error code: 5301 Detail code: No.119	Normal	
	<P120 model>	(1) Disconnect the inverter output wire from the terminals of the INV board (SC-U, SC-V, SC-W).	1) IPM/overcurrent breaker trip Error code: 4250 Detail code: No. 101, 102, 103, 104, 105, 106, and 107	See the section "Troubleshooting the IPM" (Refer to - 6 - [5]). Replace the IPM, and put the outdoor unit back into operation. If the problem persists, replace the INV board.
			2) Logic error Error code: 4220 Detail code: No. 111	See the section "Troubleshooting the IPM" (Refer to - 6 - [5]). Replace the IPM, and put the outdoor unit back into operation. If the problem persists, replace the INV board. Replace the INV board, and put the outdoor unit back into operation. If the problem persists, replace the DCCT.
		(2) Put the outdoor unit into operation.	3) ACCT sensor circuit failure Error code: 5301 Detail code: No.117	Replace the INV board.
			4) DCCT sensor circuit failure Error code: 5301 Detail code: No.118	Replace the DCCT board. Replace the DCCT, and put the outdoor unit back into operation. If the problem persists, replace the INV board.
			5) IPM open Error code: 5301 Detail code: No.119	Normal
[2] Check for compressor wiring, and check the compressor ground fault or coil error.	Disconnect the compressor wiring, and check the compressor Meg, and coil resistance.	1) Compressor Meg failure Error if less than 1 Mohm. When no liquid refrigerant in the compressor 2) Compressor coil resistance failure Coil resistance value of 0.3 ohm (20°C [68°F]) : -P96 models Coil resistance value of 0.3 ohm (20°C [68°F]) : P120 model	Replace the compressor Check that no liquid refrigerant in the compressor.	

	Items to be checked	Phenomena	Remedy	
<p>[3] Check whether the inverter is damaged. (No load)</p>	<p><P72 and P96 models></p> <p>(1) Disconnect the inverter output wire from the terminals of the INV board (SC-U, SC-V, SC-W).</p> <p>(2) Disconnect the short-circuit connector from CN6 on the INV board.</p> <p>(3) Put the outdoor unit into operation. Check the inverter output voltage after the inverter output frequency has stabilized.</p>	1) Inverter-related problems are detected.	Connect the short-circuit connector to CN6, and go to section [1].	
		2) Inverter voltage is not output.	Replace the INV board.	
		3) There is a voltage imbalance between the wires. Greater than 5% imbalance or 5V	Replace the INV board.	
		4) There is no voltage imbalance between the wires.	Normal *Reconnect the short-circuit connector to CN6 after checking the voltage.	
	<p><P120 model></p> <p>(1) Disconnect the inverter output wire from the output terminals (U, V, W) of the IPM.</p> <p>(2) Turn on SW1-1 on the INV board.</p> <p>(3) Put the outdoor unit into operation.</p>	1) Inverter-related problems are detected.	Turn off SW1-1 and go to [1]	
		2) Inverter voltage is not output.	Check the connection between the IPM and the CNIPM on the INV board. Replace the IPM. If the problem persists, replace the INV board.	
		3) There is a voltage imbalance between the wires. Greater than 5% imbalance or 5V	Replace the IPM. If the problem persists, replace the INV board.	
		4) There is no voltage imbalance between the wires.	Normal *Turn off SW1-1	
<p>[4] Check whether the inverter is damaged. (During compressor operation)</p>	Put the outdoor unit into operation. Check the inverter output voltage after the inverter output frequency has stabilized.	1) There is a voltage imbalance between the wires. Greater than 5% imbalance or 5V	<p><P72 and P96 models> Replace the INV board.</p> <p><P120 model> Replace the IPM. If the problem persists, replace the INV board. If the problem persists after replacing the above parts, go to section [2].</p>	
<p>[5] Check the fan motor ground fault or the winding.</p>	Remove the wire for the outdoor fan motor, and check the fan motor megger and the winding resistance.	1) Fan motor megger failure Failure when the megger is 1Mohm or less.	Replace the fan motor.	
		2) Fan motor disconnection Standard: The winding resistance is approximately several ohm. (It varies depending on the temperature, or while the inner thermo is operating, it will be ∞ ohm)		
<p>[6] Check the FAN board failure.</p>	(1) Check the fan output wiring.	Connector contact failure •Board side (CNINV) •Fan motor side	Connect the connector.	
	(2) Check the connector CN-VDC connection.	Cnnector contact failure	Connect the connector.	
	(3) Check the FAN board failure.	1) The voltage imbalance among each motor wiring during operation (The voltage imbalance is greater than the larger of the values represented by 5% or 5 V.)		Replace the FAN board.
		2) The same error occurs even after the operation is restarted.		

(3) Trouble treatment when the main power breaker is tripped.

	Items to be checked	Phenomena	Remedy
[1]	Perform Meg check between the terminals on the power terminal block TB1.	Zero to several ohm, or Meg failure	Check each part in the main inverter circuit. *Refer to "Simple checking Procedures for individual components of main inverter circuit". •Diode stack •IPM •Rush current protection resistor •Electromagnetic relay •DC reactor
[2]	Turn on the power again and check again.	1) Main power breaker trip 2) No remote control display	
[3]	Turn on the outdoor unit and check that it operates normally.	1) Operates normally without tripping the main breaker.	a) The wiring may have been short-circuited. Search for the wire that short-circuited, and repair it. b) If item a) above is not the cause of the problem, the compressor may have a problem.
		2) Main power breaker trip	A compressor ground fault can be considered. Go to (2)-[2].

(4) Simple checking procedure for individual components of main inverter circuit

Note

Before checking, turn the power off and remove the parts to be checked from the control box.

Part name	Judgment method																		
Diode stack	Refer to "Diode stack" (9 [2] - 6 - (6))																		
IPM (Intelligent power module)	Refer to "Intelligent power module (IPM)" (9 [2] - 6 - (5))																		
Rush current protection resistor R1(R2)	<p><P72 and P96 models> Measure the resistance between terminals: 22 ohm \pm 10%</p> <p><P120 model> Measure the resistance between the + terminal on the diode stack and terminal TB31. (*Can be measured without the need to remove the noise filter board): 22 ohm \pm 10%</p>																		
Electromagnetic relay 72C	<p>Note This electromagnetic relay is rated at 200VAC and is driven by a coil. The resistance between the coils in row A cannot be measured with a tester. Check only for shorting.</p> <div style="display: flex; justify-content: space-around; align-items: flex-start;"> <div style="text-align: center;"> <p>Installation direction</p> </div> <div> <p><P72 - P96 models></p> <table border="1"> <thead> <tr> <th></th> <th>Check point</th> <th>Checking criteria</th> </tr> </thead> <tbody> <tr> <td>Coil</td> <td>Row A</td> <td>Not to be short-circuited</td> </tr> <tr> <td>Contact</td> <td>Row B to Row E</td> <td>With the test button turned off : ∞ With the test button turned on : 0 Ω</td> </tr> </tbody> </table> <p><P120 model></p> <table border="1"> <thead> <tr> <th></th> <th>Check point</th> <th>Checking criteria</th> </tr> </thead> <tbody> <tr> <td>Coil</td> <td>Between No. 1 pin and No. 3 pin of the CN03 on the noise filter board</td> <td>Not to be short-circuited</td> </tr> <tr> <td>Contact</td> <td>+ terminal on the diode stack and terminal TB31 on the noise filter</td> <td>With the test button turned off : 22 Ω \pm 10 % With the test button turned on : 0 Ω</td> </tr> </tbody> </table> </div> </div>		Check point	Checking criteria	Coil	Row A	Not to be short-circuited	Contact	Row B to Row E	With the test button turned off : ∞ With the test button turned on : 0 Ω		Check point	Checking criteria	Coil	Between No. 1 pin and No. 3 pin of the CN03 on the noise filter board	Not to be short-circuited	Contact	+ terminal on the diode stack and terminal TB31 on the noise filter	With the test button turned off : 22 Ω \pm 10 % With the test button turned on : 0 Ω
	Check point	Checking criteria																	
Coil	Row A	Not to be short-circuited																	
Contact	Row B to Row E	With the test button turned off : ∞ With the test button turned on : 0 Ω																	
	Check point	Checking criteria																	
Coil	Between No. 1 pin and No. 3 pin of the CN03 on the noise filter board	Not to be short-circuited																	
Contact	+ terminal on the diode stack and terminal TB31 on the noise filter	With the test button turned off : 22 Ω \pm 10 % With the test button turned on : 0 Ω																	
DC reactor DCL	<p>Measure the resistance between terminals: 1ohm or lower (almost 0 ohm)</p> <p>Measure the resistance between terminals and the chassis: ∞</p>																		
Current sensor ACCT	<p><P120 model> Disconnect the CNCT2 connector and measure the resistance between terminals: 280 ohm \pm 30 ohm 1 - 2 PIN (U-phase), 3 - 4 PIN (W-phase)</p> <div style="text-align: center;"> <p>*Check the ACCT connection phase and the direction of the connection</p> </div>																		

(5) Intelligent power module (P120 model)

Measure resistances between each pair of terminals on the IPM with a tester, and use the results for troubleshooting.

1) Notes on measurement

- Check the polarity before measuring. (On the tester, black normally indicates plus.)
- Check that the resistance is not open (∞ ohm) or not shorted (to 0 ohm).
- The values are for reference, and the margin of errors is allowed.
- The result that is more than double or half of the result that is measured at the same measurement point is not allowed.

2) Tester restriction

- Use the tester whose internal electrical power source is 1.5V or greater
- Use the dry-battery-powered tester.

Note

(The accurate diode-specific resistance cannot be measured with the button-battery-powered card tester, as the applied voltage is low.)

- Use a low-range tester if possible. A more accurate resistance can be measured.

Judgment value (reference)

		Black (+)				
		P	N	U	V	W
Red (-)	P	-	-	5 - 200 ohm	5 - 200 ohm	5 - 200 ohm
	N	-	-	∞	∞	∞
	U	∞	5 - 200 ohm	-	-	-
	V	∞	5 - 200 ohm	-	-	-
	W	∞	5 - 200 ohm	-	-	-

External view

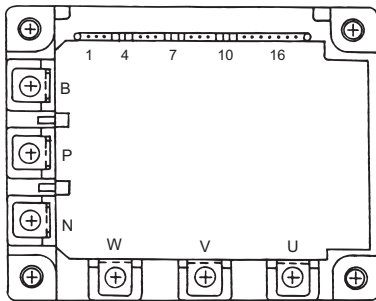

Internal circuit diagram

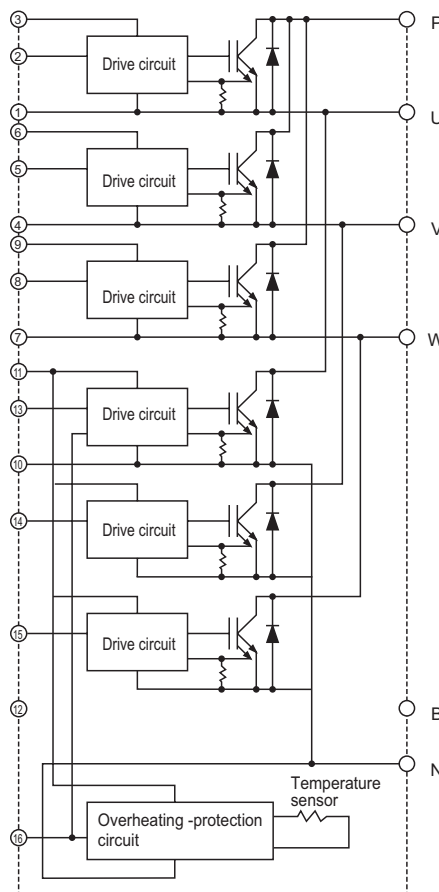

(6) Diode stack (P120 model)

Measure resistances between each pair of terminals on the diode stack with a tester, and use the results for troubleshooting. Refer to (5) " Intelligent power module (IPM) " for notes on measurement and tester selection.

Judgment value (reference)

		Black (+)				
		+ (P)	- (N)	to (L1)	to (L2)	to (L3)
Red (-)	+ (P)	-	-	5 - 200 ohm	5 - 200 ohm	5 - 200 ohm
	- (N)	-	-	∞	∞	∞
	to (L1)	∞	5 - 200 ohm	-	-	-
	to (L2)	∞	5 - 200 ohm	-	-	-
	to (L3)	∞	5 - 200 ohm	-	-	-

External view

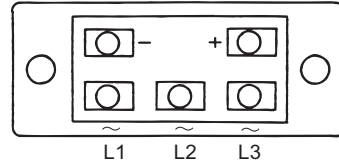

Internal circuit diagram

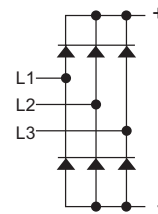

-6- Inverter (YHMU-A)

- Replace only the compressor if only the compressor is found to be defective.
- Replace only the fan motor if only the fan motor is found to be defective.
- Replace the defective components if the inverter is found to be defective.
- If both the compressor and the inverter are found to be defective, replace the defective component(s) of both devices.

(1) Inverter-related problems: Troubleshooting and remedies

- 1) The INV board has a large-capacity electrolytic capacitor, in which residual voltage remains even after the main power is turned off, posing a risk of electric shock. Turn off the unit, leave it turned off for at least 10 minutes, and check that the voltage across FT-P and FT-N terminals on the INV board or the terminals at both ends of the electrolytic capacitor is 20V or below before checking inside the control box.
(It takes about 10 minutes to discharge electricity after the power supply is turn off.)
- 2) The IPM on the inverter becomes damaged if there are loose screws are connectors. If a problem occurs after replacing some of the parts, mixed up wiring is often the cause of the problem. Check for proper connection of the wiring, screws, connectors, and Faston terminals.
- 3) To avoid damage to the circuit board, do not connect or disconnect the inverter-related connectors with the main power turned on.
- 4) Faston terminals have a locking function. Make sure the terminals are securely locked in place after insertion.

Press the tab on the terminals to remove them.

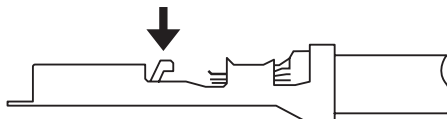

- 5) When the IPM or IGBT is replaced, apply a thin layer of heat radiation grease that is supplied evenly to these parts. Wipe off any grease that may get on the wiring terminal to avoid terminal contact failure.
- 6) Faulty wiring to the compressor damages the compressor. Connect the wiring in the correct phase sequence.

	Error display/failure condition	Measure/inspection item
[1]	Inverter related errors 4250, 4255, 4220, 4225, 4230, 4240,4260, 5301, 0403	Check the details of the inverter error in the error log at 10.[1] Table of LED codes. Take appropriate measures to the error code and the error details in accordance with 9. [2] Self-diagnosis on the basis of Error Display on Remote Controller and Remedy for Error.
[2]	Main power breaker trip	Refer to "(3) Trouble treatment when the main power breaker is tripped".
[3]	Main power earth leakage breaker trip	Refer to "(4) Trouble treatment when the main power earth leakage breaker is tripped".
[4]	Only the compressor does not operate.	Check the inverter frequency on the LED monitor and proceed to (2) - [4] if the compressor is in operation.
[5]	The compressor vibrates violently at all times or makes an abnormal sound.	See (2)-[4].
[6]	Only the fan motor does not operate.	Check the inverter frequency on the LED monitor and proceed to (2)-[6] if the fan motor is in operation.
[7]	The fan motor shakes violently at all times or makes an abnormal sound.	Check the inverter frequency on the LED monitor and proceed to (2)-[6] if the fan motor is in operation.
[8]	Noise is picked up by the peripheral device	<p><1> Check that power supply wiring of the peripheral device does not run close to the power supply wiring of the outdoor unit.</p> <p><2> Check if the inverter output wiring is not running parallel to the power supply wiring and the transmission lines.</p> <p><3> Check that the shielded wire is used as the transmission line when it is required, and check that the grounding work is performed properly on the shielded wire.</p> <p><4> Meg failure for electrical system other than the inverter</p> <p><5> Attach a ferrite core to the inverter output wiring. (Contact the factory for details of the service part settings.)</p> <p><6> Provide separate power supply to the air conditioner and other electric appliances.</p> <p><7> If the error occurred suddenly, a ground fault of the inverter output can be considered. See (2)-[4].</p> <p>*Contact the factory for cases other than those listed above.</p>
[9]	Sudden malfunction (as a result of external noise.)	<p><1> Check that the grounding work is performed properly.</p> <p><2> Check that the shielded wire is used as the transmission line when it is required, and check that the grounding work is performed properly on the shielded wire.</p> <p><3> Check that neither the transmission line nor the external connection wiring does not run close to another power supply system or does not run through the same conduit pipe.</p> <p>* Contact the factory for cases other than those listed above.</p>

(2) Inverter output related troubles

	Items to be checked	Phenomena	Remedy
[1] Check the INV board error detection circuit.	(1) Disconnect the inverter output wire from the terminals of the INV board (SC-U, SC-V, SC-W).	1) Overcurrent error Error code: 4250 Detail code: No. 101, 104, 105, 106, and 107	Replace the INV board.
		2) Logic error Error code: 4220 Detail code: No. 111	Replace the INV board.
	(2) Put the outdoor unit into operation.	3) ACCT sensor circuit failure Error code: 5301 Detail code: No.117	Replace the INV board.
		4) IPM open Error code: 5301 Detail code: No.119	Normal
[2] Check for compressor ground fault or coil error.	Disconnect the compressor wiring, and check the compressor Meg, and coil resistance.	1) Compressor Meg failure Error if less than 1 Mohm.	Check that there is no liquid refrigerant in the compressor. If there is none, replace the compressor.
		2) Compressor coil resistance failure Coil resistance value of 1 ohm (20°C [68°F]): - P96models Coil resistance value of 0.6 ohm (20°C [68°F]): P120 model	Replace the compressor.

	Items to be checked	Phenomena	Remedy
[3] Check whether the inverter is damaged. (No load)	(1) Disconnect the inverter output wire from the terminals of the INV board (SC-U, SC-V, SC-W).	1) Inverter-related problems are detected.	Connect the short-circuit connector to CN6, and go to section [1].
	(2) Disconnect the short-circuit connector from CN6 on the INV board.	2) Inverter voltage is not output at the terminals (SC-U, SC-V, and SC-W)	Replace the INV board.
	(3) Put the outdoor unit into operation. Check the inverter output voltage after the inverter output frequency has stabilized.	3) There is a voltage imbalance between the wires. Greater than 5% imbalance or 5V	Replace the INV board.
		4) There is no voltage imbalance between the wires.	Normal *Reconnect the short-circuit connector to CN6 after checking the voltage.
[4] Check whether the inverter is damaged. (During compressor operation)	Put the outdoor unit into operation. Check the inverter output voltage after the inverter output frequency has stabilized.	1) There is a voltage imbalance between the wires. Greater than 5% imbalance or 5V	Replace the INV board.
[5] Check the fan motor ground fault or the winding.	Remove the wire for the outdoor fan motor, and check the fan motor megger and the winding resistance.	1) Fan motor megger failure Failure when the megger is 1Mohm or less.	Replace the fan motor.
		2) Fan motor disconnection Standard: The winding resistance is approximately several ohm. (It varies depending on the temperature, or while the inner thermo is operating, it will be ∞ ohm)	
[6] Check the FAN board failure.	(1) Check the fan output wiring.	Connector contact failure ♦Board side (CNINV) ♦Fan motor side	Connect the connector.
	(2) Check the connector CN-VDC connection.	Cnnector contact failure	Connect the connector.
	(3) Check the FAN board failure.	1) The voltage imbalance among each motor wiring during operation (The voltage imbalance is greater than the larger of the values represented by 5% or 5 V.)	Replace the FAN board.
		2) The same error occurs even after the operation is restarted.	

(3) Trouble treatment when the main power breaker is tripped

	Items to be checked	Phenomena	Remedy
[1]	Check the breaker capacity.	Use of a non-specified breaker	Replace it with a specified breaker.
[2]	Perform Meg check between the terminals on the power terminal block TB1.	Zero to several ohm, or Meg failure	Check each part and wiring. *Refer to (5) "Simple checking Procedures for individual components of main inverter circuit".
[3]	Turn on the power again and check again.	1) Main power breaker trip 2) No remote control display	♦IGBT module ♦Rush current protection resistor ♦Electromagnetic relay ♦DC reactor
[4]	Turn on the outdoor unit and check that it operates normally.	1) Operates normally without tripping the main breaker. 2) Main power breaker trip	a) The wiring may have been short-circuited. Search for the wire that short-circuited, and repair it. b) If item a) above is not the cause of the problem, refer to (2)-[1]-[6].

(4) Trouble treatment when the main power earth leakage breaker is tripped

	Items to be checked	Phenomena	Remedy
[1]	Check the earth leakage breaker capacity and the sensitivity current.	Use of a non-specified earth leakage breaker	Replace with a regulation earth leakage breaker.
[2]	Check the resistance at the power supply terminal block with a megger.	Failure resistance value	Check each part and wiring. *Refer to (5) "Simple checking Procedures for individual components of main inverter circuit". ♦IGBT module ♦Rush current protection resistor ♦Electromagnetic relay ♦DC reactor
[3]	Disconnect the compressor wirings and check the resistance of the compressor with a megger.	Failure compressor if the insulating resistance value is not in specified range. Failure when the insulating resistance value is 1 Mohm or less.	Check that there is no liquid refrigerant in the compressor. If there is none, replace the compressor.
[4]	Disconnect the fan motor wirings and check the resistance of the fan motor with a megger.	Failure fan motor if the insulating resistance value is not in specified range. Failure when the insulating resistance value is 1 Mohm or less.	Replace the fan motor.

Note

The insulation resistance could go down to close to 1Mohm after installation or when the power is kept off for an extended period of time because of the accumulation of refrigerant in the compressor. If the earth leakage breaker is triggered, please use the following procedure to take care of this.

- ♦Disconnect the wires from the compressor's terminal block.
- ♦If the resistance is less than 1 Mohm, switch on the power for the outdoor unit with the wires still disconnected.
- ♦Leave the power on for at least 12 hours.
- ♦Check that the resistance has recovered to 1 Mohm or greater.

Earth leakage current measurement method

- ♦For easy on-site measurement of the earth leakage current, enable the filter with a measurement instrument that has filter functions as below, clamp all the power supply wires, and measure.
Recommended measurement instrument: CLAMP ON LEAK HiTESTER 3283 made by HIOKI E.E. CORPORATION
- ♦When measuring one device alone, measure near the device's power supply terminal block.

(5) Simple checking procedure for individual components of main inverter circuit

Note

Before inspecting the inside of the control box, turn off the power, keep the unit off for at least 10 minutes, and confirm that the voltage between FT-P and FT-N on INV Board has dropped to DC20V or less.

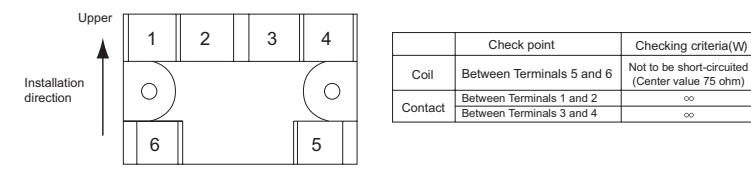
Part name	Judgment method													
IGBT module	See "Troubleshooting for IGBT Module". (9 [4] - 6 - (6))													
Rush current protection resistor R1, R5	Measure the resistance between terminals R1 and R5: 22 ohm \pm 10%													
Electromagnetic relay 72C	<p>Note This electromagnetic relay is rated at DC12V and is driven by a coil. Check the resistance between terminals</p>  <p>The diagram shows a relay with terminals 1, 2, 3, 4 in a top row and 6, 5 in a bottom row. Terminals 1 and 2 are connected to a coil, and terminals 3 and 4 are connected to contacts. Terminals 5 and 6 are also connected to a coil. An arrow labeled 'Upper' points to the top terminals, and 'Installation direction' points upwards. To the right is a table:</p> <table border="1"> <thead> <tr> <th></th> <th>Check point</th> <th>Checking criteria(W)</th> </tr> </thead> <tbody> <tr> <td rowspan="2">Coil</td> <td>Between Terminals 5 and 6</td> <td>Not to be short-circuited (Center value 75 ohm)</td> </tr> <tr> <td>Between Terminals 1 and 2</td> <td>∞</td> </tr> <tr> <td rowspan="2">Contact</td> <td>Between Terminals 1 and 2</td> <td>∞</td> </tr> <tr> <td>Between Terminals 3 and 4</td> <td>∞</td> </tr> </tbody> </table>		Check point	Checking criteria(W)	Coil	Between Terminals 5 and 6	Not to be short-circuited (Center value 75 ohm)	Between Terminals 1 and 2	∞	Contact	Between Terminals 1 and 2	∞	Between Terminals 3 and 4	∞
	Check point	Checking criteria(W)												
Coil	Between Terminals 5 and 6	Not to be short-circuited (Center value 75 ohm)												
	Between Terminals 1 and 2	∞												
Contact	Between Terminals 1 and 2	∞												
	Between Terminals 3 and 4	∞												
DC reactor DCL	Measure the resistance between terminals: 1ohm or lower (almost 0 ohm) Measure the resistance between terminals and the chassis: ∞													

(6) Troubleshooting for IGBT Module

Measure the resistances between each pair of terminals on the IGBT with a tester, and use the results for troubleshooting. The terminals on the INV board are used for the measurement.

1) Notes on measurement

- Check the polarity before measuring. (On the tester, black normally indicates plus.)
- Check that the resistance is not open (∞ ohm) or not shorted (to 0 ohm).
- The values are for reference, and the margin of errors is allowed.
- The result that is more than double or half of the result that is measured at the same measurement point is not allowed.
- Disconnect all the wiring connected the INV board, and make the measurement.

2) Tester restriction

- Use the tester whose internal electrical power source is 1.5V or greater
- Use the dry-battery-powered tester.

Note

(The accurate diode-specific resistance cannot be measured with the button-battery-powered card tester, as the applied voltage is low.)

- Use a low-range tester if possible. A more accurate resistance can be measured.

Judgment value (reference)

		Black (+)				
		SC-P1	FT-N	SC-L1	SC-L2	SC-L3
Red (-)	SC-P1	-	-	5 - 200 ohm	5 - 200 ohm	5 - 200 ohm
	FT-N	-	-	∞	∞	∞
	SC-L1	∞	5 - 200 ohm	-	-	-
	SC-L2	∞	5 - 200 ohm	-	-	-
	SC-L3	∞	5 - 200 ohm	-	-	-

		Black (+)				
		SC-P2	FT-N	SC-U	SC-V	SC-W
Red (-)	SC-P2	-	-	5 - 200 ohm	5 - 200 ohm	5 - 200 ohm
	FT-N	-	-	∞	∞	∞
	SC-U	∞	5 - 200 ohm	-	-	-
	SC-V	∞	5 - 200 ohm	-	-	-
	SC-W	∞	5 - 200 ohm	-	-	-

INV board external diagram

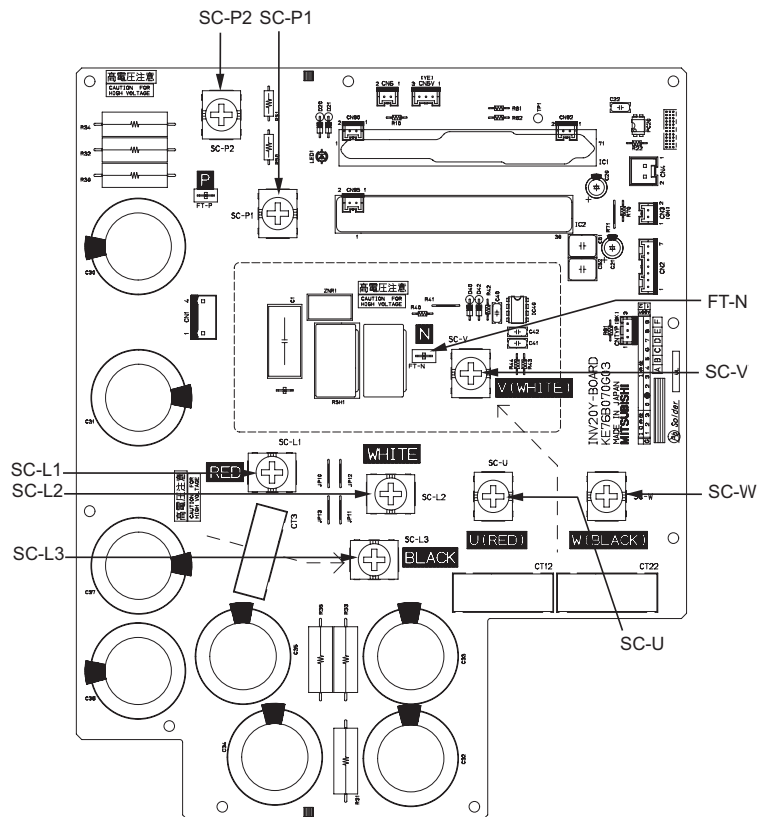

-7- Control Circuit (THMU-A)

(1) Control power source function block

1) PUHY-P72, P96THMU-A

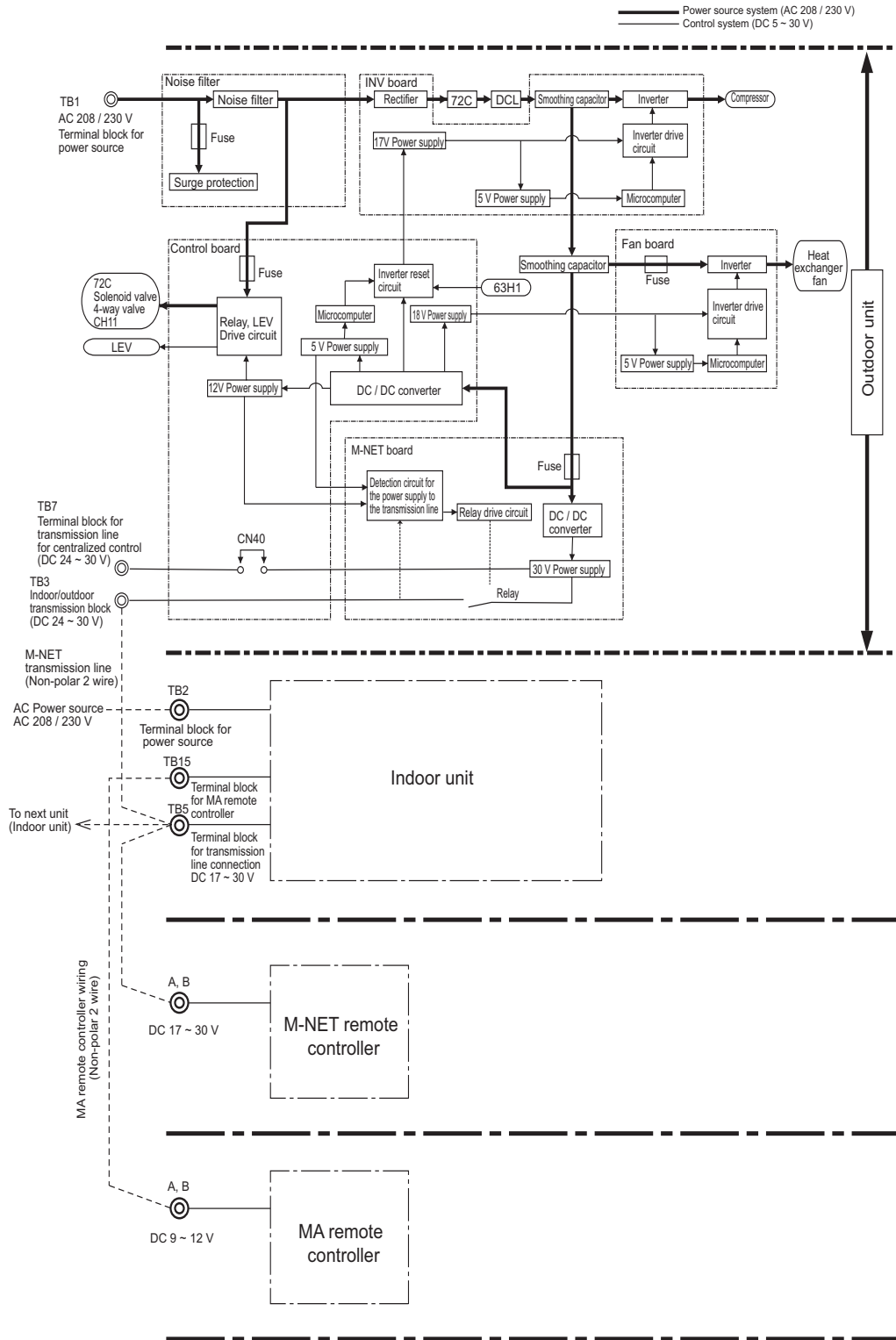

* MA remote controllers and M-NET remote controllers cannot be used together.
(Both the M-NET and MA remote controller can be connected to a system with a system controller.)

2) PUHY-P120THMU-A

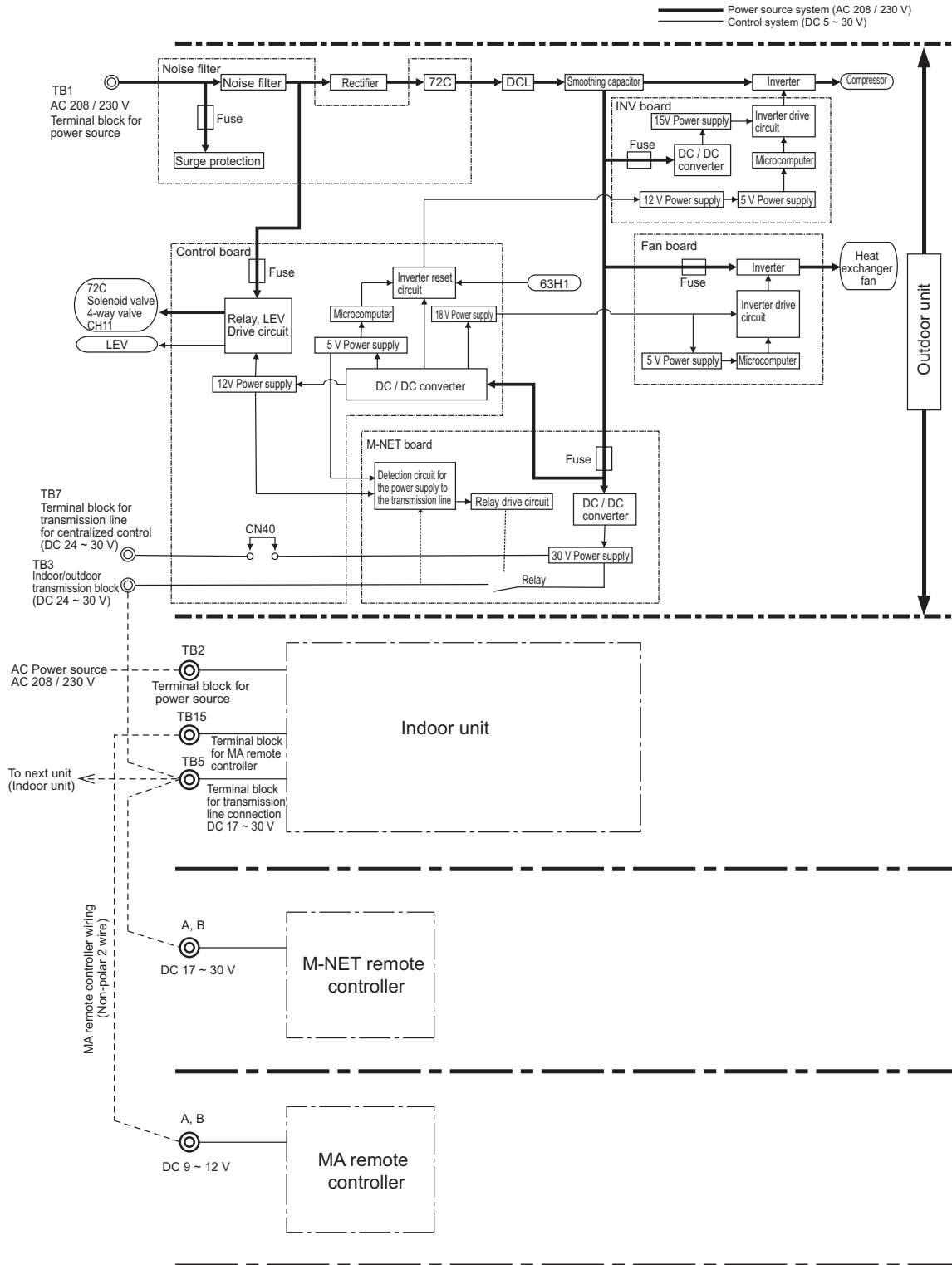

* MA remote controllers and M-NET remote controllers cannot be used together.
 (Both the M-NET and MA remote controller can be connected to a system with a system controller.)

(2) Troubleshooting transmission power circuit of outdoor unit

1) PUHY-P72, P96THMU-A

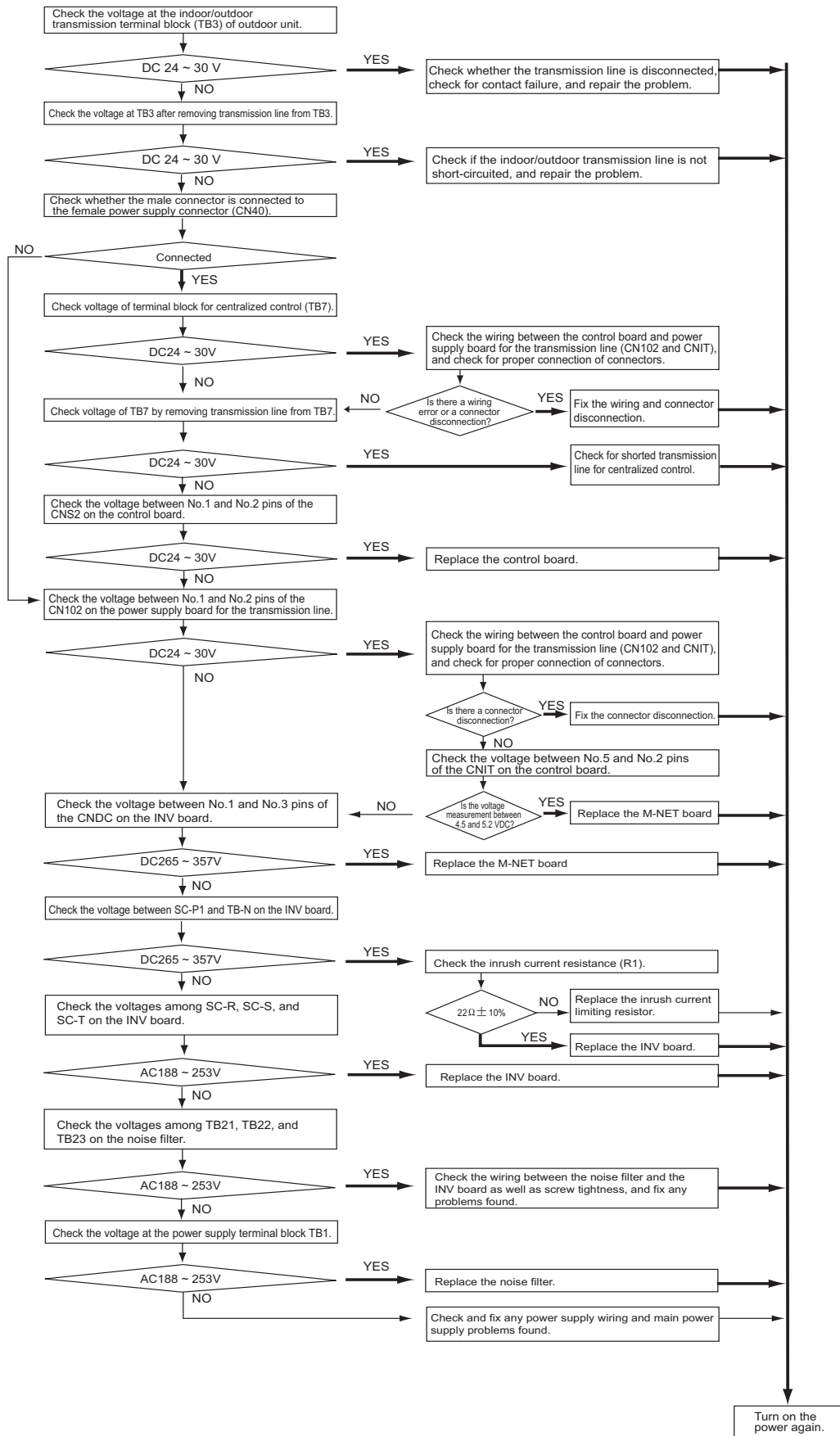

2) PUHY-P120THMU-A

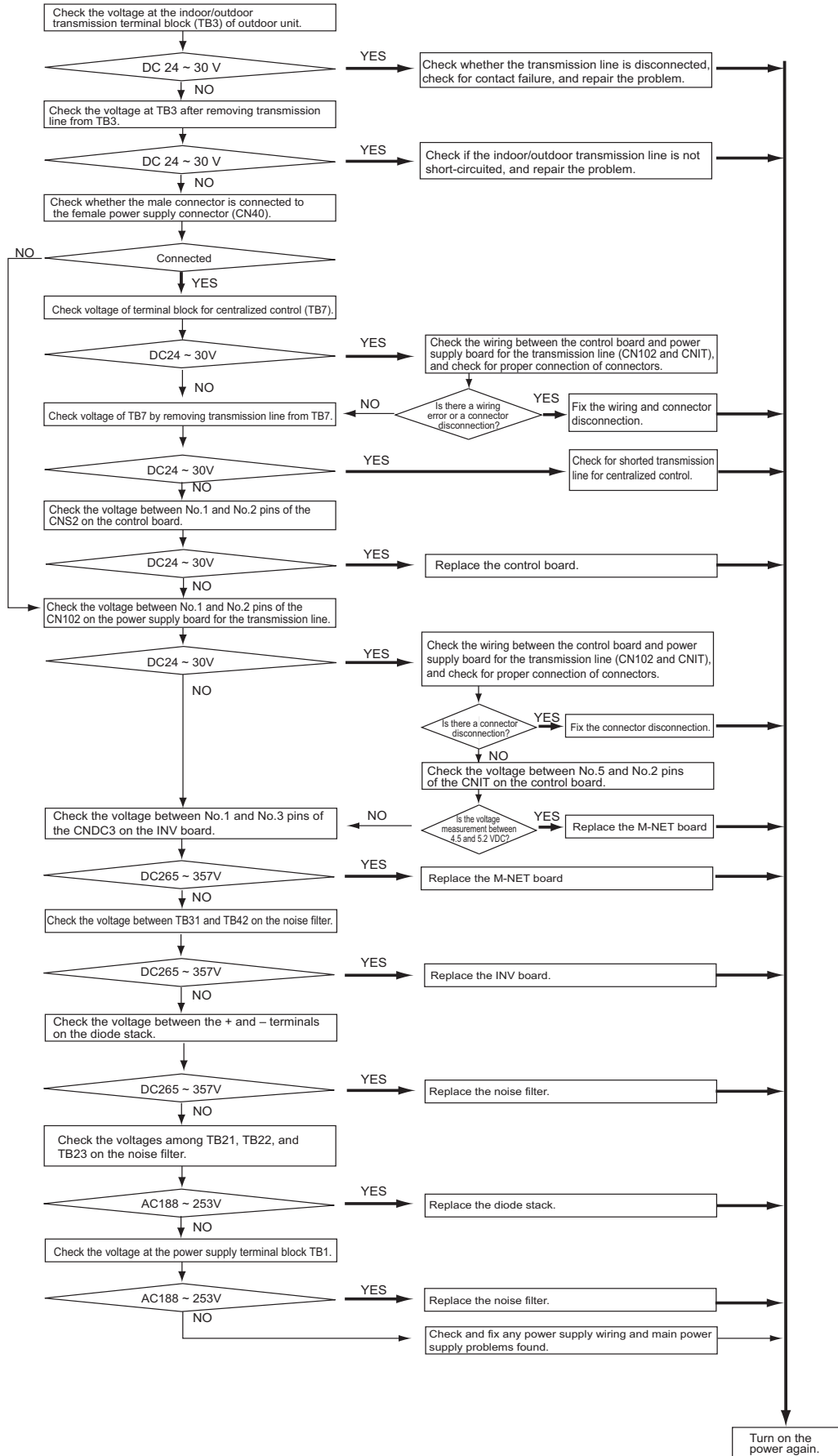

-6- Control Circuit (YHMu-A)

(1) Control power source function block

1) PUHY-P72, P96, P120YHMu-A

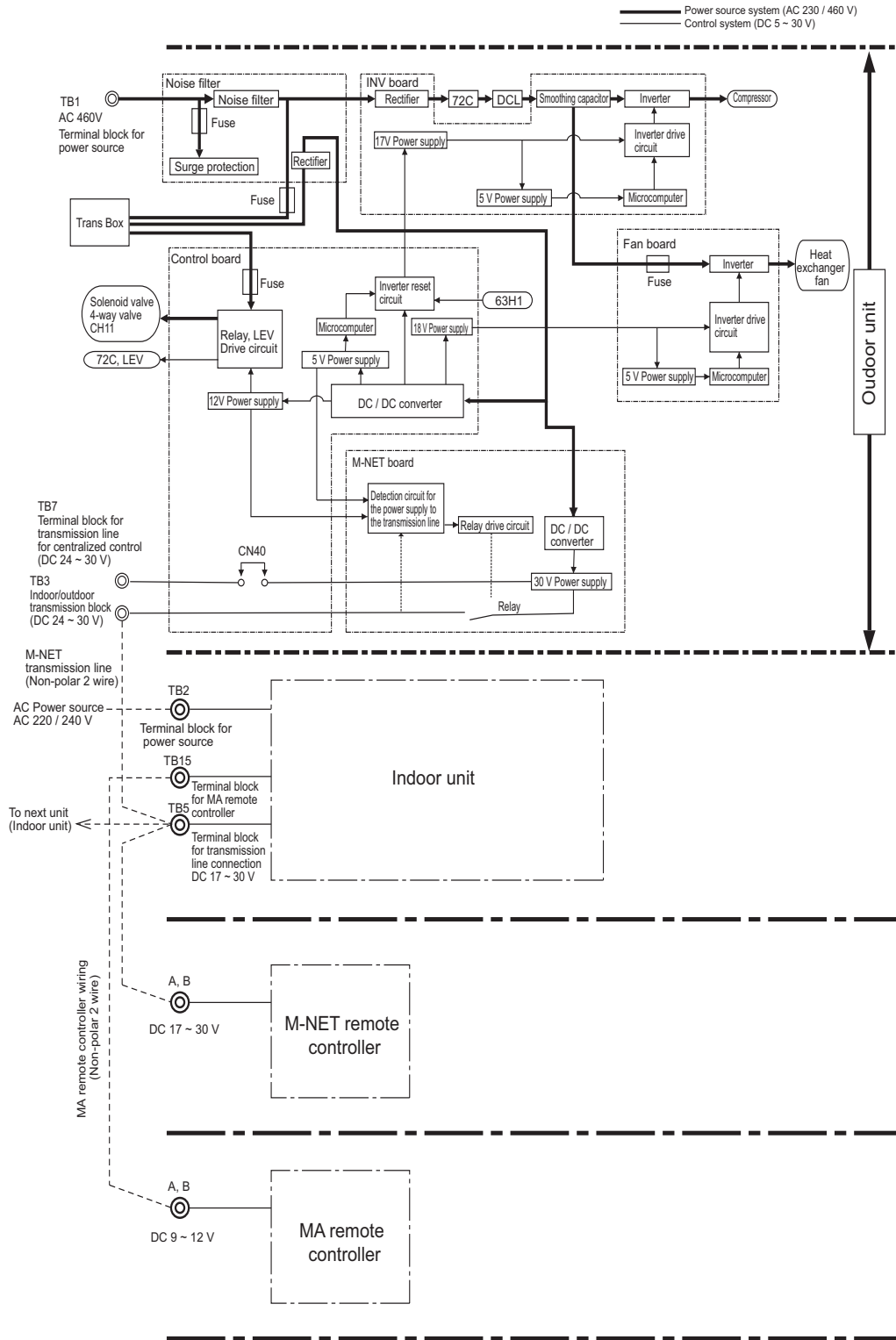

* MA remote controllers and M-NET remote controllers cannot be used together.
 (Both the M-NET and MA remote controller can be connected to a system with a system controller.)

(2) Troubleshooting transmission power circuit of outdoor unit

1) PUHY-P72, P96, P120YHMu-A

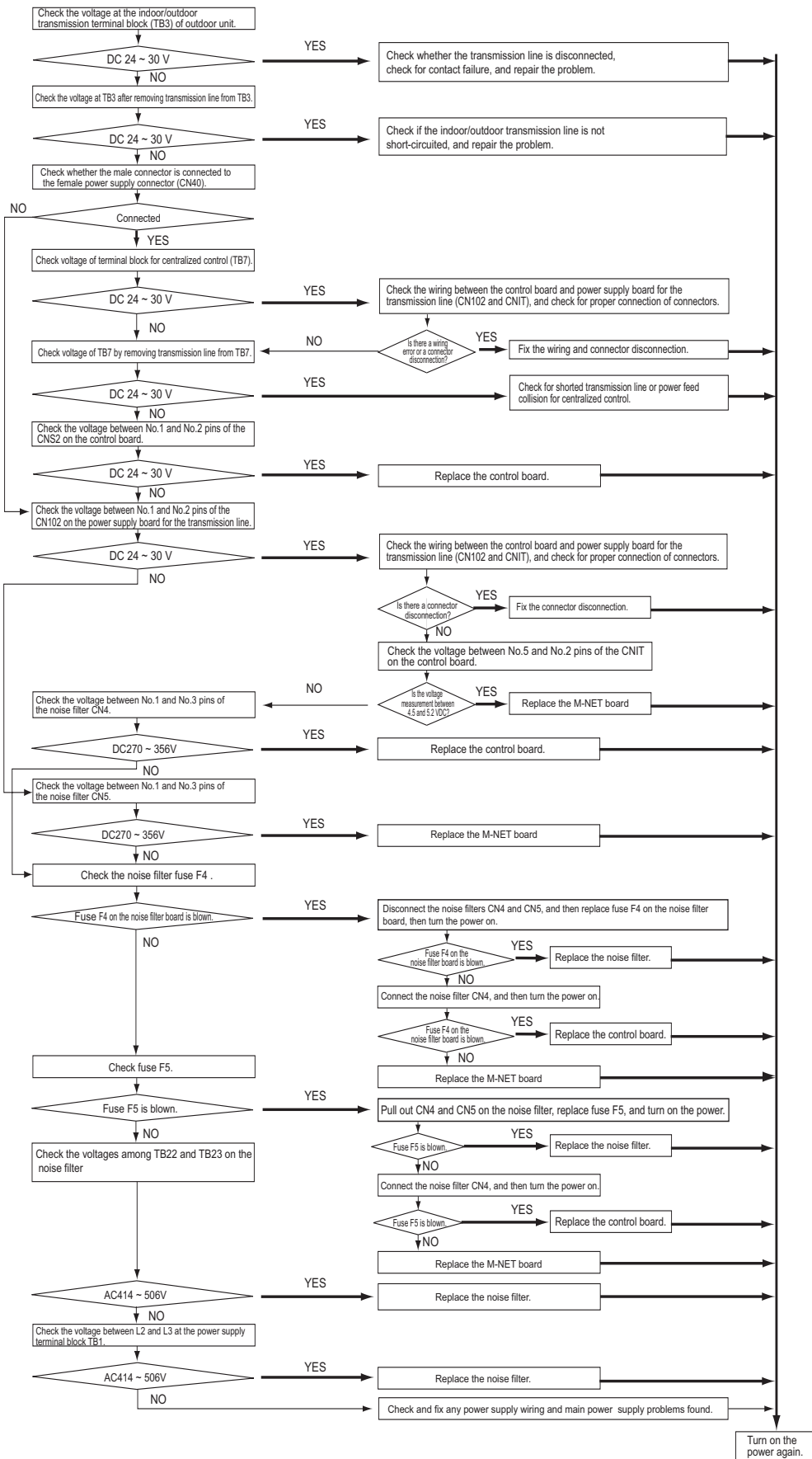

[5] Refrigerant Leak

1. Leak spot: In the case of extension pipe for indoor unit (Cooling season)

- 1) Mount a pressure gauge on the service check joint (CJ2) on the low-pressure side.
- 2) Stop all the indoor units, and close the liquid service valve (BV2) inside the outdoor unit while the compressor is being stopped.
- 3) Stop all the indoor units; turn on SW2-4 on the outdoor unit control board while the compressor is being stopped. (Pump down mode will start, and all the indoor units will run in cooling test run mode.)
- 4) In the pump down mode (SW2-4 is ON), all the indoor units will automatically stop when the low pressure (63LS) reaches 0.383MPa [55psi] or less or 15 minutes have passed after the pump mode started. Stop all the indoor units and compressors when the pressure indicated by the pressure gauge, which is on the check joint (CJ2) for low-pressure service, reaches 0.383MPa [55psi] or 20 minutes pass after the pump down operation is started.
- 5) Close the gas service valve (BV1) inside the outdoor unit.
- 6) Collect the refrigerant that remains in the extended pipe for the indoor unit. Do not discharge refrigerant into the atmosphere when it is collected.
- 7) Repair the leak.
- 8) After repairing the leak, vacuum the extension pipe and the indoor unit.
- 9) To adjust refrigerant amount, open the service valves (BV1 and BV2) inside the outdoor unit and turn off SW2-4.

2. Leak spot: In the case of outdoor unit (Cooling season)

(1) Run all the indoor units in the cooling test run mode.

- 1) To run the indoor unit in test run mode, turn SW3-2 from ON to OFF when SW3-1 on the outdoor control board is ON.
- 2) Change the setting of the remote controller for all the indoor units to the cooling mode.
- 3) Check that all the indoor units are performing a cooling operation.

(2) Check the values of Tc and TH6.

(To display the values on the LED screen, use the self-diagnosis switch (SW1) on the outdoor unit control board.)

- 1) When Tc-TH6 is 10°C [18°F] or more : See the next item (3).
- 2) When Tc-TH6 is less than 10°C [18°F] : After the compressor stops, collect the refrigerant inside the system, repair the leak, perform evacuation, and recharge new refrigerant. (Leak spot: 4. In the case of outdoor unit, handle in the same way as heating season.)

Tc self-diagnosis switch

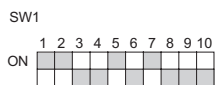

TH6 self-diagnosis switch

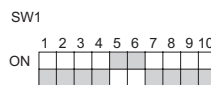

(3) Stop all the indoor units, and stop the compressor.

- 1) To stop all the indoor units and the compressors, turn SW3-2 from ON to OFF when SW3-1 on the outdoor control board is ON.
- 2) Check that all the indoor units are being stopped.

(4) Close the service valves (BV1 and BV2).

(5) To prevent the liquid seal, extract small amount of refrigerant from the check joint of the liquid service valve (BV2), as the liquid seal may cause a malfunction of the unit.

In the cooling cycle, the section between check valve CV1 and LEV 2a/b will form a closed circuit.

Open LEV1 before recovering the refrigerant or evacuating the system.

(6) Collect the refrigerant that remains inside the outdoor unit. Do not discharge refrigerant into air into the atmosphere when it is collected.

(7) Repair the leak.

(8) After repairing the leak, replace the dryer with the new one, and perform evacuation inside the outdoor unit.

(9) To adjust refrigerant amount, open the service valves (BV1 and BV2) inside the outdoor unit.

Note

When the power to the outdoor/indoor unit must be turned off to repair the leak after closing the service valves specified in the item 4, turn the power off in approximately one hour after the outdoor/indoor units stop.

- 1) When 30 minutes have passed after the item 4 above, the indoor unit lev turns from fully closed to slightly open to prevent the refrigerant seal.

LEV2a and LEV2b open when the outdoor unit remains stopped for 15 minutes to allow for the collection of refrigerant in the outdoor unit heat exchanger and to enable the evacuation of the outdoor unit heat exchanger.

If the power is turned of in less than 5 minutes, LEV2a and LEV2b may close, trapping high-pressure refrigerant in the outdoor unit heat exchanger and creating a highly dangerous situation.

- 2) Therefore, if the power source is turned off within 30 minutes, the lev remains fully closed and the refrigerant remains sealed. When only the power for the indoor unit is turned off, the indoor unit LEV turns from faintly open to fully closed.

3. Leak spot: In the case of extension pipe for indoor unit (Heating season)

(1) Run all the indoor units in heating test run mode.

- 1) To run the indoor unit in test run mode, turn SW3-2 from ON to OFF when SW3-1 on the outdoor control board is ON.
- 2) Change the setting of the remote controller for all the indoor units to the heating mode.
- 3) Check that all the indoor units are performing a heating operation.

(2) Stop all the indoor units, and stop the compressor.

- 1) To stop all the indoor units and the compressors, turn SW3-2 from ON to OFF when SW3-1 on the outdoor control board is ON.
- 2) Check that all the indoor units are stopped.

(3) Close the service valves (BV1 and BV2).

(4) Collect the refrigerant that remains inside the indoor unit. Do not discharge refrigerant into air into the atmosphere when it is collected.

(5) Repair the leak.

(6) After repairing the leak, perform evacuation of the extension pipe for the indoor unit, and open the service valves (BV1 and BV2) to adjust refrigerant.

4. Leak spot: In the case of outdoor unit (Heating season)

- 1) Collect the refrigerant in the entire system (outdoor unit, extended pipe and indoor unit). Do not discharge refrigerant into the atmosphere when it is collected. **In the cooling cycle, the section between check valve CV1 and LEV 2a/b will form a closed circuit. Open LEV1 before recovering the refrigerant or evacuating the system.**
- 2) Repair the leak.
- 3) After repairing the leak, replace the dryer with the new one, and perform evacuation of the entire system, and calculate the standard amount of refrigerant to be added (for outdoor unit, extended pipe and indoor unit), and charge the refrigerant. Refer to "VIII [4] 3. "

Note

If the indoor or outdoor units need to be turned off for repairing leaks during Step 1) above, turn off the power approximately 1 hour after the units came to a stop.

If the power is turned off in less than 15 minutes, LEV2a and LEV2b may close, trapping high-pressure refrigerant in the outdoor unit heat exchanger and creating a highly dangerous situation.

[6] Compressor Replacement Instructions

[Compressor replacement procedures]

Follow the procedures below (Steps 1 through 6) to remove the compressor components and replace the compressor. Reassemble them in the reverse order after replacing the compressor.



1. Remove both the top and bottom service panels (front panels).

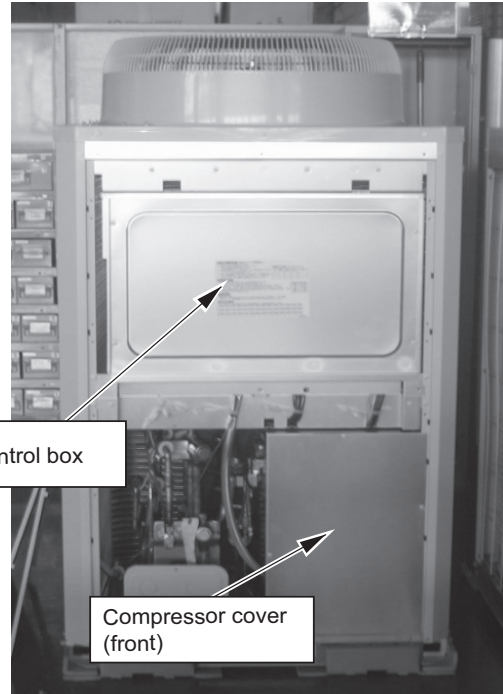

2. Remove the control box and the compressor cover (front).

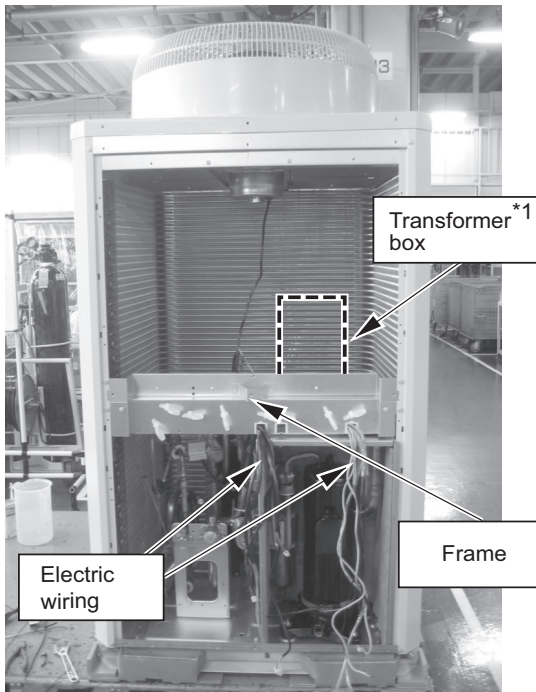

3. Remove the wires that are secured to the frame, and remove the frame.

*1 Remove the transformer box from the P72, P96, and P120YHMu-A models.



4. Remove the compressor cover (top).

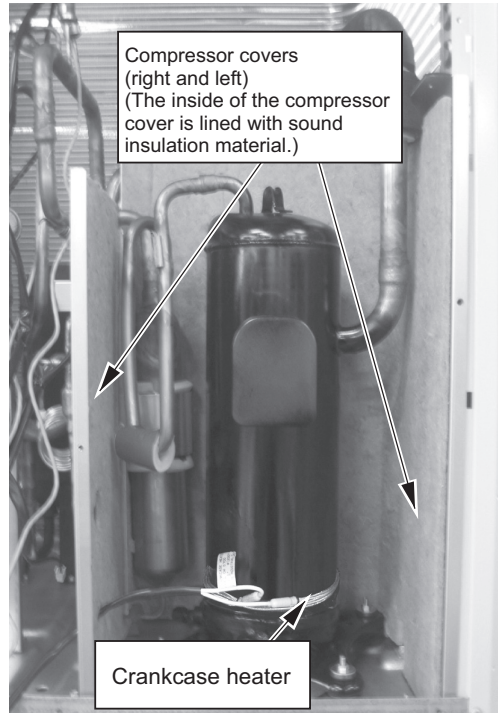

5. Remove the compressor wires, compressor covers (right and left), and crankcase heater.

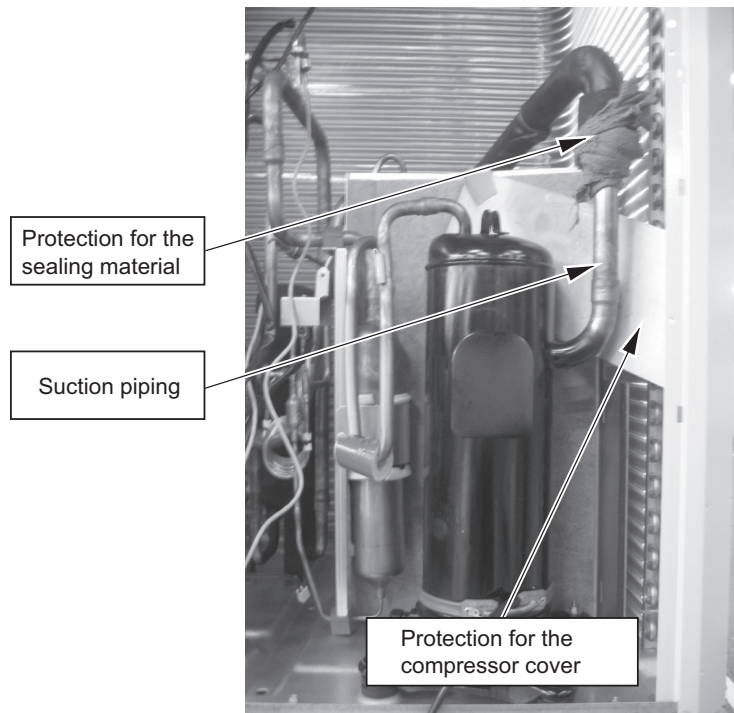

6. Place protective materials on the insulation lining of the compressor cover and on the sealing material on the compressor suction pipe to protect them from the torch flame, debraise the pipe, and replace the compressor.

[7] Troubleshooting Using the Outdoor Unit LED Error Display

If the LED error display appear as follows while all the SW1 switches are set to OFF, check the items under the applicable item numbers below.

1. Error code appears on the LED display.

Refer to IX [2] Responding to Error Display on the Remote Controller.

2. LED is blank.

Take the following troubleshooting steps.

- (1) If the voltage between pins 1 and 3 of CNDC on the control board is outside the range between 220 VDC and 380 VDC, refer to IX [4] -7- (2) Troubleshooting transmission power circuit of outdoor unit .**
- (2) If the LED error display becomes lit when the power is turned on with all the connectors on the control board except CNDC disconnected, there is a problem with the wiring to those connectors or with the connectors themselves.**
- (3) If nothing appears on the display under item (2) above AND the voltage between pins 1 and 3 of CNDC is within the range between 220 VDC and 380 VDC, control board failure is suspected.**

3. Only the software version appears on the LED display.

(1) Only the software version appears while the transmission cables to TB3 and TB7 are disconnected.

- 1) Wiring failure between the control board and the transmission line power supply board.(CNIT, CNS2, CN102)
- 2) If item 1) checks out OK, the transmission line power supply board failure is suspected.
- 3) If items 1) and 2) check out OK, control board failure is suspected.

(2) If the LED display appears as noted in "X [1] 2. LED display at Initial setting"(page 273) while the transmission cables to TB3 and TB7 are disconnected, failure with the transmission cable or the connected equipment is suspected.

X LED Monitor Display on the Outdoor Unit Board

[1] How to Read the LED on the Service Monitor	273
--	-----



[1] How to Read the LED on the Service Monitor

1. How to read the LED

By setting the DIP SW 1-1 through 1-10 (Switch number 10 is represented by 0), the operating condition of the unit can be monitored on the service monitor. (Refer to the table on the following pages for DIP SW settings.)
The service monitor uses 4-digit 7-segment LED to display numerical values and other types of information.

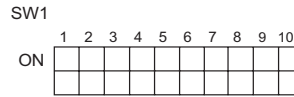
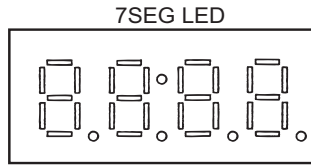

SW1-10 is represented as "0" in the table.

Pressure and temperature are examples of numerical values, and operating conditions and the on-off status of solenoid valve are examples of flag display.

1) Display of numerical values

Example: When the pressure data sensor reads 18.8kg/cm² (Item No. 58)

- The unit of pressure is in kg/cm²
- Use the following conversion formula to convert the displayed value into a value in SI unit.

$$\text{Value in SI unit (MPa)} = \text{Displayed value (kg/cm}^2\text{)} \times 0.098$$

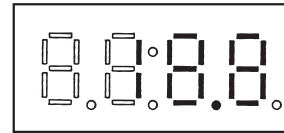

2) Flag display

Example: When 21S4a, 21S4b, SV1a are ON. (Item No. 3)

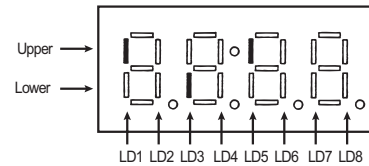

Example: 3-minutes restart mode (Item No. 14)

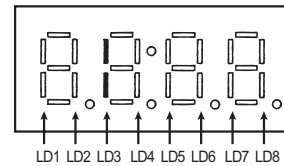

2. LED display at initial setting

From power on until the completion of initial settings, the following information will be displayed on the monitor screen. (Displays No. 1 through No. 4 in order repeatedly.)

No	Item	Display	Remarks
1	Software version	0103	[0103] : Version 1.03
2	Refrigerant type	[410]	[410] : R410A
3	Model and capacity	[H-20]	[H-20] : Cooling/Heating 20 HP For the first few minutes after power on, the capacity of each outdoor unit is displayed. Thereafter, the combined capacity is displayed.
4	Communication address	[51]	[51] : Address 51

After the initial settings have been completed, the information on these items can be checked by making the switch setting that corresponds to No. 517 in the LED display table.

Note

Only item No. 1 "Software Version" appears on the display if there is a wiring failure between the control board and the transmission line power supply board or if the circuit board has failed.

3. Time data storage function

The outdoor unit has a simple clock function that enables the unit to calculate the current time with an internal timer by receiving the time set by the system controller, such as G(B)-50A.

If an error (including a preliminary error) occurs, the error history data and the error detection time are stored into the service memory.

The error detection time stored in the service memory and the current time can be seen on the service LED.

Note

- 1) Use the time displayed on the service LED as a reference.
- 2) The date and the time are set to "00" by default. If a system controller that sets the time, such as G(B)-50A is not connected, the elapsed time and days since the first power on will be displayed.
If the time set on a system controller is received, the count will start from the set date and the time.
- 3) The time is not updated while the power of the indoor unit is turned off. When the power is turned off and then on again, the count will resume from the time before the power was turned off. Thus, the time that differs the actual time will be displayed. (This also applies when a power failure occurs.)

The system controller, such as G(B)-50A, adjusts the time once a day. When the system controller is connected, the time will be automatically updated to the correct current time after the time set by the system controller is received. (The data stored into the memory before the set time is received will not be updated.)

(1) Reading the time data:

- 1) Time display

Example: 12 past 9

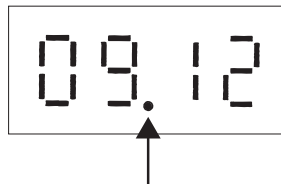

* Disappears if the time data is deviated due to a power failure, or if a system controller that sets the time is not connected.

- 2) Date display

•When the main controller that can set the time is connected

Example: May 10, 2003

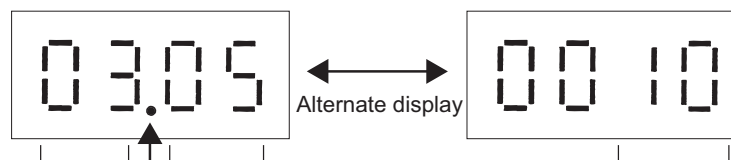

Alternate display of year and month, and date

* Appears between the year and the month, and nothing appears when the date is displayed.

•When the main controller that can set the time is not connected

Example: 52 days after power was turned on

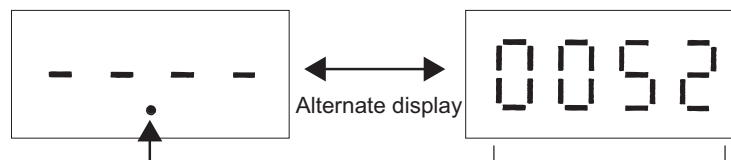

Day count

* Appears between the year and the month, and nothing appears when the date is displayed.

LED monitor display

Current data

No.	SW1 1234567890	Item	Display									Unit ^{*1} (A, B) ⁻¹		Remarks	
			LD1	LD2	LD3	LD4	LD5	LD6	LD7	LD8	OC	OS			
0	0000000000	Relay output display 1 Lighting	Comp in operation									OC	A	A	
		Check (error) display 1 OC/OS error	0000 to 9999 (Address and error codes highlighted)									B	B		
1	1000000000	Check (error) display 2 OC/OS error	0000 to 9999 (Address and error codes highlighted)									A	A	Display of the latest preliminary error If no preliminary errors are detected, "----" appears on the display.	
2	0100000000	Check (error) display 3 (Including IC and BC)	0000 to 9999 (Address and error codes highlighted)									B		If no errors are detected, "----" appears on the display.	
3	1100000000	Relay output display 2 Top Bottom	21S4a		CH11			SV1a					A	A	
4	0010000000	Relay output display 3 Top Bottom			21S4b		SV5b	21S4c	SV9				A	A	Power supply for indoor transmission line
5	1010000000														
6	0110000000														
7	1110000000	Special control	Retry operation	Emergency operation					Communication error between the OC and OS				B	B	Communication error 3-minute re-start delay mode
8	0001000000														
9	1001000000	Communication demand capacity	0000 to 9999									B		If not demanded controlled, "----" [%] appears on the display.	
10	0101000000	Contact point demand capacity	0000 to 9999									B		If not demanded controlled, "----" [%] appears on the display.	

*1 A: The condition of either OC or OS is displayed individually. B: The condition of the entire refrigerant system is displayed.

Current data

No.	SW1	Item	Display								Unit (A, B) ^{*1}		Remarks		
			LD1	LD2	LD3	LD4	LD5	LD6	LD7	LD8	OC	OS			
11	1101000000	External signal (Open input contact point)	Contact point demand	Low-noise mode (Capacity priority)	Snow sensor	Cooling-heating changeover (Cooling)	Cooling-heating changeover (Heating)					A	A		
12	0011000000	External signal (Open input contact point)										A	A	Low-noise mode (Quiet priority)	
13	1011000000														
14	0111000000	Outdoor unit operation status			3-minutes restart mode	Compressor in operation	Preliminary error	Error	3-minutes restart after instantaneous power failure			A	A	Preliminary low pressure error	
15	1111000000	OC/OS identification										A	A		
16	0000100000	Indoor unit check	Top	Unit No. 1	Unit No. 2	Unit No. 3	Unit No. 4	Unit No. 5	Unit No. 6	Unit No. 7	Unit No. 8				The lamp that corresponds to the unit that came to an abnormal stop lights. The lamp goes off when the error is reset. Each unit that comes to an abnormal unit will be given a sequential number in ascending order starting with 1.
17	1000100000		Bottom	Unit No. 9	Unit No. 10	Unit No. 11	Unit No. 12	Unit No. 13	Unit No. 14	Unit No. 15	Unit No. 16				
18	0100100000	Top	Unit No. 17	Unit No. 18	Unit No. 19	Unit No. 20	Unit No. 21	Unit No. 22	Unit No. 23	Unit No. 24					
19	1100100000	Bottom	Unit No. 25	Unit No. 26	Unit No. 27	Unit No. 28	Unit No. 29	Unit No. 30	Unit No. 31	Unit No. 32					
20	0010100000	Top	Unit No. 33	Unit No. 34	Unit No. 35	Unit No. 36	Unit No. 37	Unit No. 38	Unit No. 39	Unit No. 40					
21	1010100000	Bottom	Unit No. 41	Unit No. 42	Unit No. 43	Unit No. 44	Unit No. 45	Unit No. 46	Unit No. 47	Unit No. 48					
22	0110100000	Top	Unit No. 49	Unit No. 50											
23	1110100000	Bottom	Unit No. 1	Unit No. 2	Unit No. 3	Unit No. 4	Unit No. 5	Unit No. 6	Unit No. 7	Unit No. 8					
		Indoor unit Operation mode	Bottom	Unit No. 9	Unit No. 10	Unit No. 11	Unit No. 12	Unit No. 13	Unit No. 14	Unit No. 15	Unit No. 16				
			Top	Unit No. 17	Unit No. 18	Unit No. 19	Unit No. 20	Unit No. 21	Unit No. 22	Unit No. 23	Unit No. 24				
		Bottom	Unit No. 25	Unit No. 26	Unit No. 27	Unit No. 28	Unit No. 29	Unit No. 30	Unit No. 31	Unit No. 32					
		Top	Unit No. 33	Unit No. 34	Unit No. 35	Unit No. 36	Unit No. 37	Unit No. 38	Unit No. 39	Unit No. 40					
		Bottom	Unit No. 41	Unit No. 42	Unit No. 43	Unit No. 44	Unit No. 45	Unit No. 46	Unit No. 47	Unit No. 48					
		Top	Unit No. 49	Unit No. 50											
		Bottom	Unit No. 1	Unit No. 2	Unit No. 3	Unit No. 4	Unit No. 5	Unit No. 6	Unit No. 7	Unit No. 8					

*1 A: The condition of either OC or OS is displayed individually. B: The condition of the entire refrigerant system is displayed.

Current data

No.	SW1	Item	Display										Unit (A, B) ^{*1}		Remarks
			LD1	LD2	LD3	LD4	LD5	LD6	LD7	LD8	OC	OS			
24	1234567890	Indoor unit thermostat	Unit No. 1	Unit No. 2	Unit No. 3	Unit No. 4	Unit No. 5	Unit No. 6	Unit No. 7	Unit No. 8	B	Lit when thermostat is on Unit when thermostat is off			
	0001100000		Unit No. 9	Unit No. 10	Unit No. 11	Unit No. 12	Unit No. 13	Unit No. 14	Unit No. 15	Unit No. 16					
25	1001100000	Top	Unit No. 17	Unit No. 18	Unit No. 19	Unit No. 20	Unit No. 21	Unit No. 22	Unit No. 23	Unit No. 24					
		Bottom	Unit No. 25	Unit No. 26	Unit No. 27	Unit No. 28	Unit No. 29	Unit No. 30	Unit No. 31	Unit No. 32					
26	0101100000	Top	Unit No. 33	Unit No. 34	Unit No. 35	Unit No. 36	Unit No. 37	Unit No. 38	Unit No. 39	Unit No. 40					
		Bottom	Unit No. 41	Unit No. 42	Unit No. 43	Unit No. 44	Unit No. 45	Unit No. 46	Unit No. 47	Unit No. 48					
27	1101100000	Top	Unit No. 49												
		Bottom													
28	0011100000														
29	1011100000														
30	0111100000														
31	1111100000														
32	0000010000														
33	1000010000														
34	0100010000														
35	1100010000														
36	0010010000														
37	1010010000														
38	0110010000														
39	1110010000	Outdoor unit Operation mode	Permissible stop	Standby	Cooling	Heating					B				
40	0001010000														
41	1001010000														
42	0101010000	Outdoor unit control mode	Stop	Thermo OFF	Abnormal stop	Scheduled control	Initial start up	Defrost	Oil balance	Low frequency oil recovery	A	A			
43	1101010000			Refrigerant recovery							A	A			
44	0011010000														

*1 A: The condition of either OC or OS is displayed individually. B: The condition of the entire refrigerant system is displayed.

Current data

No.	SW1	Item	Display								Unit (A, B) ^{*1}		Remarks
			LD1	LD2	LD3	LD4	LD5	LD6	LD7	LD8	OC	OS	
45	1234567890	TH4				-99.9 to 999.9					A	A	The unit is [°C]
46	0111010000	TH3				-99.9 to 999.9					A	A	
47	1111010000	TH7				-99.9 to 999.9					A	A	
48	0000110000	TH6				-99.9 to 999.9					A	A	
49	1000110000	TH2				-99.9 to 999.9					A	A	
50	0100110000	TH5				-99.9 to 999.9					A	A	
51	1100110000												
52	0010110000												
53	1010110000												
54	0110110000												
55	1110110000												
56	0001110000	THS1				-99.9 to 999.9					A	A	The unit is [°C]
57	100110000	THBOX				-99.9 to 999.9					A	A	
58	0101110000	High-pressure sensor data				-99.9 to 999.9					A	A	The unit is [kgf/cm ²]
59	1101110000	Low-pressure sensor data				-99.9 to 999.9					A	A	
60	0011110000												
61	1011110000												
62	0111110000												
63	1111110000												
64	000001000												
65	100001000												
66	0100001000												
67	1100001000												
68	0010001000												
69	1010001000												
70	0110001000												
71	1110001000												

*1 A: The condition of either OC or OS is displayed individually. B: The condition of the entire refrigerant system is displayed.

Current data

No.	SW1	Item	Display								Unit (A, B)*1		Remarks
			LD1	LD2	LD3	LD4	LD5	LD6	LD7	LD8	OC	OS	
72	1234567890												
73	0001001000												
74	1001001000												
75	0101001000												
76	1101001000												
77	0011001000												
78	1011001000	Σ Qj					0000 to 9999				B	B	
79	1111001000	Σ Qjc					0000 to 9999				B	B	
80	0000101000	Σ Qjh					0000 to 9999				B	B	
81	1000101000	Target Tc					-99.9 to 999.9				B		The unit is [°C]
82	0100101000	Target Te					-99.9 to 999.9				B		
83	1100101000	Tc					-99.9 to 999.9				A	A	
84	0010101000	Te					-99.9 to 999.9				A	A	
85	1010101000												
86	0110101000	Total frequencies (OC+OS)					0000 to 9999				B		Control data [Hz]
87	1110101000	Total frequency of each unit					0000 to 9999				A	A	
88	0001101000	COMP frequency					0000 to 9999				A	A	
89	1001101000												
90	0101101000												
91	1101101000	COMP operating fre- quency					0000 to 9999				A	A	The unit is [rps] Output frequency of the inverter depends on the type of compressor and equals the integer multi- ples (x1, x2 etc.) of the operating frequency of the compressor
92	0011101000												
93	1011101000	All AK (OC+OS)					0000 to 9999				B		

*1 A: The condition of either OC or OS is displayed individually. B: The condition of the entire refrigerant system is displayed.

Current data

No.	SW1	Item	Display								Unit (A, B) ^{*1}		Remarks	
			LD1	LD2	LD3	LD4	LD5	LD6	LD7	LD8	OC	OS		
94	0111101000	AK							0000 to 9999			A	A	
95	1111101000	FAN							0000 to 9999			A	A	Fan output [%]
96	0000011000	Fan inverter output frequency							0000 to 9999			A	A	Twice the actual output frequency
97	1000011000													
98	0100011000													
99	1100011000													
100	0010011000													
101	1010011000													
102	0110011000													
103	1110011000	LEV1							0 to 480			A	A	Outdoor LEV opening (Fully open: 480)
104	0001011000	LEV2							60 to 1400			A	A	Outdoor LEV opening (Fully open: 1400)
105	1001011000													
106	0101011000													
107	1101011000													
108	0011011000	COMP operating current (DC)							00.0 to 999.9			A	A	Peak value [A]
109	1011011000													
110	0111011000													
111	1111011000	COMP bus voltage							00.0 to 999.9			A	A	The unit is [V]
112	0000111000													
113	1000111000													
114	0100111000													
115	1100111000													
116	0010111000	Number of times the unit went into the mode to remedy wet vapor suction							0000 to 9999			B		

*1 A: The condition of either OC or OS is displayed individually. B: The condition of the entire refrigerant system is displayed.

Current data

No.	SW1	Item	Display								Unit (A, B) ^{*1}		Remarks	
			LD1	LD2	LD3	LD4	LD5	LD6	LD7	LD8	OC	OS		
117	1234567890	COMP Operation time Upper 4 digits	0000 to 9999								A	A	The unit is [h]	
118	0110111000	COMP Operation time Lower 4 digits	0000 to 9999								A	A		
119	1110111000													
120	0001111000													
121	1001111000	Backup mode	Abnormal pressure rise	High-pressure drop	Low-pressure drop	Abnormal Td rise						A	A	Stays lit for 90 seconds after the completion of backup control
122	0101111000													
123	1101111000	COMP number of start-stop events Upper 4 digits	0000 to 9999								A	A	Count-up at start-up The unit is [Time]	
124	0011111000	COMP number of start-stop events Lower 4 digits	0000 to 9999								A	A		
125	1011111000													
126	0111111000													
127	1111111000													
128	0000000100													
129	1000000100	Integrated operation time of compressor (for rotation purpose)	0000 to 9999								B		The unit is [h]	
130	0100000100													
131	1100000100													
132	0010000100													
133	1010000100													
134	0110000100													
135	1110000100													
136	0001000100													
137	1001000100													
138	0101000100													

*1 A: The condition of either OC or OS is displayed individually. B: The condition of the entire refrigerant system is displayed.

[X LED monitor display on the outdoor unit board]

Current data

No.	SW1	Item	Display								Unit (A, B) ^{*1}		Remarks	
			LD1	LD2	LD3	LD4	LD5	LD6	LD7	LD8	OC	OS		
139	1234567890													
140	1101000100													
141	0011000100													
142	1011000100													
143	0111000100													
144	1111000100													
145	0000100100													
146	1000100100													
147	0100100100													
148	1100100100													
149	0010100100													
150	1010100100													
151	0110100100													
152	1110100100													
153	0001100100													
154	1001100100													
155	0101100100													
156	1101100100													
157	0011100100													
158	1011100100													
159	0111100100													
160	1111100100													
161	0000010100													
162	1000010100													
163	0100010100													
164	1100010100													
165	0010010100													
166	1010010100													

*1 A: The condition of either OC or OS is displayed individually. B: The condition of the entire refrigerant system is displayed.

Current data

No.	SW1	Item	Display								Unit (A, B) *1		Remarks	
			LD1	LD2	LD3	LD4	LD5	LD6	LD7	LD8	OC	OS		
167	1234567890													
168	1110010100													
169	0001010100													
170	1001010100													
171	0101010100													
172	1101010100													
173	0011010100													
174	1011010100													
175	0111010100													
176	1111010100													
177	0000110100													
177	1000110100													

*1 A: The condition of either OC or OS is displayed individually. B: The condition of the entire refrigerant system is displayed.

Current data

No.	SW1	Item	Display										Unit (A, B) ^{*1}		Remarks		
			LD1	LD2	LD3	LD4	LD5	LD6	LD7	LD8	OC	OS					
178	1234567890	Error history 1													B	B	Address and error codes highlighted If no errors are detected, "----" appears on the display. Preliminary error information of the OS does not appear on the OC. Neither preliminary error information of the OC nor error information of the IC appears on the OS.
179	0100110100	Error details of inverter	0000 to 9999												A	A	
180	1100110100	Error history 2	Error details of inverter (0001-0120)												B	B	
181	0010110100	Error details of inverter	0000 to 9999												A	A	
182	1010110100	Error history 3	Error details of inverter (0001-0120)												B	B	
183	0110110100	Error details of inverter	0000 to 9999												A	A	
184	1110110100	Error history 4	Error details of inverter (0001-0120)												B	B	
185	0001110100	Error details of inverter	0000 to 9999												A	A	
186	1001110100	Error history 5	Error details of inverter (0001-0120)												B	B	
187	0101110100	Error details of inverter	0000 to 9999												A	A	
188	1101110100	Error history 6	Error details of inverter (0001-0120)												B	B	
189	0011110100	Error details of inverter	0000 to 9999												A	A	
190	1011110100	Error history 7	Error details of inverter (0001-0120)												B	B	
191	0111110100	Error details of inverter	0000 to 9999												A	A	
192	1111110100	Error history 8	Error details of inverter (0001-0120)												B	B	
193	0000001100	Error details of inverter	0000 to 9999												A	A	
194	1000001100	Error history 9	Error details of inverter (0001-0120)												B	B	
195	0100001100	Error details of inverter	0000 to 9999												A	A	
196	1100001100	Error history 10	Error details of inverter (0001-0120)												B	B	
197	0010001100	Error details of inverter	0000 to 9999												A	A	
198	1010001100	Error history of inverter (At the time of last data backup before error)	0000 to 9999												B	B	
199	0110001100	Error details of inverter	Error details of inverter (0001-0120)												A	A	
200	1110001100	Error history of inverter	Error details of inverter (0001-0120)														

*1 A: The condition of either OC or OS is displayed individually. B: The condition of the entire refrigerant system is displayed.

Error history

No.	SW1 1234567890	Item	Display									Unit (A, B) ^{*1}		Remarks
			LD1	LD2	LD3	LD4	LD5	LD6	LD7	LD8	OC	OS		
201	1001001100	Outdoor unit operation status			3-minutes restart mode	Compressor in operation	Preliminary error	Error	3-minutes restart after instantaneous power failure	Preliminary low pressure error	A	A		
202	0101001100	OC/OS identification	OC/OS-1/OS-2									A	A	
203	1101001100													
204	0011001100													
205	1011001100	Outdoor unit Operation mode	Permissible stop	Standby	Cooling		Heating				A	A		
206	0111001100													
207	1111001100													
208	0000101100	Outdoor unit control mode	Stop	Thermo OFF	Abnormal stop	Scheduled control	Initial start up	Defrost	Oil balance	Low frequency oil recovery	A	A		
209	1000101100			Refrigerant recovery							A	A		
210	0100101100													
211	1100101100	Relay output display 1 Lighting	Comp in operation				72C		OC	Always lit	A	A		
212	0010101100	Relay output display 2 Lighting	21S4a		CH11		SV1a				A	A		
				21S4b	SV5b									
213	1010101100	Relay output display 3 Lighting	Top			SV5c	21S4c		SV9	Lit while power to the indoor units is being supplied	A	A		
		Bottom												
214	0110101100													
215	1110101100													

*1 A: The condition of either OC or OS is displayed individually. B: The condition of the entire refrigerant system is displayed.

Error history

No.	SW1	Item	Display								Unit (A, B) ^{*1}			Remarks
			LD1	LD2	LD3	LD4	LD5	LD6	LD7	LD8	OC	OS		
216	1234567890	TH4				-99.9 to 999.9						A	A	The unit is [°C]
217	0001101100	TH3				-99.9 to 999.9						A	A	
218	1001101100	TH7				-99.9 to 999.9						A	A	
219	0101101100	TH6				-99.9 to 999.9						A	A	
220	1101101100	TH2				-99.9 to 999.9						A	A	
221	0011101100	TH5				-99.9 to 999.9						A	A	
222	1011101100													
223	0111101100													
224	1111101100													
225	0000011100													
226	1000011100													
227	0100011100	THS1				-99.9 to 999.9						A	A	The unit is [°C]
228	1100011100	THBOX				-99.9 to 999.9						A	A	
229	0010011100	High-pressure sensor data				-99.9 to 999.9						A	A	The unit is [kgf/cm ²]
230	1010011100	Low-pressure sensor data				-99.9 to 999.9						A	A	
231	0110011100													
232	1110011100													
233	0001011100													
234	1001011100													
235	0101011100													
236	1101011100													
237	0011011100													
238	1011011100													
239	0111011100													
240	1111011100													
241	0000111100													
242	1000111100													

*1 A: The condition of either OC or OS is displayed individually. B: The condition of the entire refrigerant system is displayed.

Error history

No.	SW1	Item	Display								Unit (A, B)*1		Remarks
			LD1	LD2	LD3	LD4	LD5	LD6	LD7	LD8	OC	OS	
243	1234567890												
244	1100111100												
245	0010111100												
246	1010111100												
247	0110111100												
248	1110111100												
249	0001111100												
249	1001111100	Σ Qj					0000 to 9999				B	B	
250	0101111100	Σ Qjc					0000 to 9999				B	B	
251	1101111100	Σ Qjh					0000 to 9999				B	B	
252	0011111100	Target Tc					-99.9 to 999.9				B		The unit is [°C]
253	1011111100	Target Te					-99.9 to 999.9				B		
254	0111111100	Tc					-99.9 to 999.9				A	A	The unit is [°C]
255	1111111100	Te					-99.9 to 999.9				A	A	
256	0000000010												
257	1000000010	Total frequencies (OC+OS)					0000 to 9999				B		Control data [Hz]
258	0100000010	Total frequency of each unit					0000 to 9999				A	A	
259	1100000010	COMP frequency					0000 to 9999				A	A	
260	0010000010												
261	1010000010												
262	0110000010	COMP operating frequency					0000 to 9999				A	A	The unit is [rps]
263	1110000010												
264	0001000010	All AK (OC+OS)					0000 to 9999				B		
265	1001000010	AK					0000 to 9999				A	A	
266	0101000010	FAN					0000 to 9999				A	A	Fan inverter output [%]
267	1101000010	Fan inverter output frequency					0000 to 9999				A	A	Twice the actual output frequency

*1 A: The condition of either OC or OS is displayed individually. B: The condition of the entire refrigerant system is displayed.

Error history

No.	SW1	Item	Display								Unit (A, B) ^{*1}		Remarks	
			LD1	LD2	LD3	LD4	LD5	LD6	LD7	LD8	OC	OS		
268	1234567890													
269	0011000010													
270	1011000010													
271	0111000010													
272	1111000010													
273	0000100010													
274	1000100010	LEV1					0 to 480					A	A	Outdoor unit LEV opening (Fully open: 480)
275	0100100010	LEV2					60 to 1400					A	A	Outdoor unit LEV opening (Fully open: 1400)
276	1100100010													
277	0010100010													
278	1010100010													
279	0110100010	COMP operating current (DC)					00.0 to 999.9					A	A	
280	1110100010													
281	0001100010													
282	1001100010	COMP bus voltage					00.0 to 999.9					A	A	The unit is [V]
283	0101100010													
284	1101100010													
285	0011100010													
286	1011100010													
287	0111100010													
288	1111100010	COMP Operation time Upper 4 digits					0000 to 9999					A	A	The unit is [h]
289	0000010010	COMP Operation time Lower 4 digits					0000 to 9999					A	A	
290	1000010010													
291	0100010010													
292	1100010010													

*1 A: The condition of either OC or OS is displayed individually. B: The condition of the entire refrigerant system is displayed.

Error history

No.	SW1	Item	Display								Unit (A, B)*1		Remarks	
			LD1	LD2	LD3	LD4	LD5	LD6	LD7	LD8	OC	OS		
293	1010010010													
294	0110010010	COMP number of start-stop events Upper 4 digits				0000 to 9999						A	A	Count-up at start-up The unit is [Time]
295	1110010010	COMP number of start-stop events Lower 4 digits				0000 to 9999						A	A	
296	0001010010													
297	1001010010													
298	0101010010													
299	1101010010													
300	0011010010	Integrated operation time of compressor (for rotation purpose)				0000 to 9999						B		The unit is [h]

*1 A: The condition of either OC or OS is displayed individually. B: The condition of the entire refrigerant system is displayed.

Current data

No.	SW1	Item	Display								Unit (A, B) ^{*1}		Remarks		
			LD1	LD2	LD3	LD4	LD5	LD6	LD7	LD8	OC	OS			
301	1234567890														
302	1011010010	Power supply unit												B	
303	0111010010	Start-up unit												B	
304	1111010010														
305	0000110010														
306	1000110010														
307	0100110010														
308	1100110010														
309	0010110010														
310	1010110010														
311	1110110010														
312	0001110010														
313	1001110010														
314	0101110010														
315	1101110010														
316	0011110010														
317	1011110010														
318	0111110010														
319	1111110010														
320	000001010														
321	100001010														
322	010001010														
323	110001010														
324	0010001010														
325	1010001010														
326	0110001010														
327	1110001010														

*1 A: The condition of either OC or OS is displayed individually. B: The condition of the entire refrigerant system is displayed.

Current data

No.	SW1	Item	Display								Unit (A, B) ^{*1}		Remarks	
			LD1	LD2	LD3	LD4	LD5	LD6	LD7	LD8	OC	OS		
328	1234567890													
329	0001001010													
330	1001001010													
331	0101001010													
332	1101001010													
333	0011001010													
334	1011001010													
335	0111001010													
336	1111001010													
337	0000101010													
338	1000101010													
339	0100101010													
340	1100101010													
341	0010101010													
342	1010101010													
343	0110101010													
344	1110101010													
345	0001101010													
346	1001101010													
347	0101101010													
348	1101101010													
349	0011101010													
350	1011101010													
350	0111101010													

*1 A: The condition of either OC or OS is displayed individually. B: The condition of the entire refrigerant system is displayed.

Data on indoor unit system

No.	SW1	Item	Display								Unit (A, B) ^{*1}		Remarks				
			LD1	LD2	LD3	LD4	LD5	LD6	LD7	LD8	OC	OS					
351	1111101010	IC1 Address/capacity code		0000 to 9999													
352	0000011010	IC2 Address/capacity code		0000 to 9999													
353	1000011010	IC3 Address/capacity code		0000 to 9999													
354	0100011010	IC4 Address/capacity code		0000 to 9999													
355	1100011010	IC5 Address/capacity code		0000 to 9999													
356	0010011010	IC6 Address/capacity code		0000 to 9999													
357	1010011010	IC7 Address/capacity code		0000 to 9999													
358	0110011010	IC8 Address/capacity code		0000 to 9999													
359	1110011010	IC9 Address/capacity code		0000 to 9999													
360	0001011010	IC10 Address/capacity code		0000 to 9999													
361	1001011010	IC11 Address/capacity code		0000 to 9999													
362	0101011010	IC12 Address/capacity code		0000 to 9999													
363	1101011010	IC13 Address/capacity code		0000 to 9999													
364	0011011010	IC14 Address/capacity code		0000 to 9999													
365	1011011010	IC15 Address/capacity code		0000 to 9999													
366	0111011010	IC16 Address/capacity code		0000 to 9999													
367	1111011010	IC17 Address/capacity code		0000 to 9999													

*1 A: The condition of either OC or OS is displayed individually. B: The condition of the entire refrigerant system is displayed.

[X LED monitor display on the outdoor unit board]

Data on indoor unit system

No.	SW1	Item	Display								Unit (A, B) *1		Remarks		
			LD1	LD2	LD3	LD4	LD5	LD6	LD7	LD8	OC	OS			
368	1234567890	IC18 Address/capacity code												Displayed alternately every 5 seconds	
369	0000111010	IC19 Address/capacity code	0000 to 9999												
370	1000111010	IC20 Address/capacity code	0000 to 9999												
371	0100111010	IC21 Address/capacity code	0000 to 9999												
372	1100111010	IC22 Address/capacity code	0000 to 9999												
373	0010111010	IC23 Address/capacity code	0000 to 9999												
374	1010111010	IC24 Address/capacity code	0000 to 9999												
375	0110111010	IC25 Address/capacity code	0000 to 9999												
376	0001111010	IC26 Address/capacity code	0000 to 9999												
377	1001111010	IC27 Address/capacity code	0000 to 9999												
378	0101111010	IC28 Address/capacity code	0000 to 9999												
379	1101111010	IC29 Address/capacity code	0000 to 9999												
380	0011111010	IC30 Address/capacity code	0000 to 9999												
381	1011111010	IC31 Address/capacity code	0000 to 9999												
382	0111111010	IC32 Address/capacity code	0000 to 9999												
383	1111111010	IC33 Address/capacity code	0000 to 9999												
384	000000110	IC34 Address/capacity code	0000 to 9999												
385	100000110	IC35 Address/capacity code	0000 to 9999												
386	010000110	IC36 Address/capacity code	0000 to 9999												
387	110000110	IC37 Address/capacity code	0000 to 9999												
388	001000110	IC38 Address/capacity code	0000 to 9999												
389	101000110	IC39 Address/capacity code	0000 to 9999												
390	011000110	IC40 Address/capacity code	0000 to 9999												
391	111000110	IC41 Address/capacity code	0000 to 9999												
392	001000110	IC42 Address/capacity code	0000 to 9999												
393	1001000110	IC43 Address/capacity code	0000 to 9999												
394	0101000110	IC44 Address/capacity code	0000 to 9999												
395	1101000110	IC45 Address/capacity code	0000 to 9999												

*1 A: The condition of either OC or OS is displayed individually. B: The condition of the entire refrigerant system is displayed.

Data on indoor unit system

No.	SW1	Item	Display								Unit (A, B) *1		Remarks					
			LD1	LD2	LD3	LD4	LD5	LD6	LD7	LD8	OC	OS						
396	1234567890	IC46 Address/capacity code																
397	0011000110	IC47 Address/capacity code		0000 to 9999						0000 to 9999								Displayed alternately every 5 seconds
398	1011000110	IC48 Address/capacity code		0000 to 9999						0000 to 9999								
399	0111000110	IC49 Address/capacity code		0000 to 9999						0000 to 9999								
400	1111000110	IC50 Address/capacity code		0000 to 9999						0000 to 9999								
401	0000100110																	
402	1000100110																	
403	0100100110																	
404	1100100110																	
405	0010100110																	
406	1010100110																	
407	1110100110																	
408	0001100110	IC1 Suction temperature																The unit is [°C]
409	1001100110	IC2 Suction temperature																
410	0101100110	IC3 Suction temperature																
411	1101100110	IC4 Suction temperature																

*1 A: The condition of either OC or OS is displayed individually. B: The condition of the entire refrigerant system is displayed.

Data on indoor unit system

No.	SW1	Item	Display								Unit (A, B) ^{*1}		Remarks			
			LD1	LD2	LD3	LD4	LD5	LD6	LD7	LD8	OC	OS				
412	1234567890	IC5 Suction temperature								-99.9 to 999.9				B		The unit is [°C]
413	0011100110	IC6 Suction temperature								-99.9 to 999.9						
414	1011100110	IC7 Suction temperature								-99.9 to 999.9						
415	0111100110	IC8 Suction temperature								-99.9 to 999.9						
416	1111100110	IC9 Suction temperature								-99.9 to 999.9						
417	0000010110	IC10 Suction temperature								-99.9 to 999.9						
418	1000010110	IC11 Suction temperature								-99.9 to 999.9						
419	0100010110	IC12 Suction temperature								-99.9 to 999.9						
420	1100010110	IC13 Suction temperature								-99.9 to 999.9						
421	0010010110	IC14 Suction temperature								-99.9 to 999.9						
422	1010010110	IC15 Suction temperature								-99.9 to 999.9						
423	0110010110	IC16 Suction temperature								-99.9 to 999.9						
424	1110010110	IC17 Suction temperature								-99.9 to 999.9						
425	0001010110	IC18 Suction temperature								-99.9 to 999.9						
426	1001010110	IC19 Suction temperature								-99.9 to 999.9						
427	0101010110	IC20 Suction temperature								-99.9 to 999.9						
428	1101010110	IC21 Suction temperature								-99.9 to 999.9						
429	0011010110	IC22 Suction temperature								-99.9 to 999.9						
430	1011010110	IC23 Suction temperature								-99.9 to 999.9						
431	0111010110	IC24 Suction temperature								-99.9 to 999.9						
432	1111010110	IC25 Suction temperature								-99.9 to 999.9						
433	0000110110	IC26 Suction temperature								-99.9 to 999.9						
434	1000110110	IC27 Suction temperature								-99.9 to 999.9						
435	0100110110	IC28 Suction temperature								-99.9 to 999.9						

*1 A: The condition of either OC or OS is displayed individually. B: The condition of the entire refrigerant system is displayed.

Data on indoor unit system

No.	SW1	Item	Display								Unit (A, B) *1		Remarks	
			LD1	LD2	LD3	LD4	LD5	LD6	LD7	LD8	OC	OS		
436	1234567890	IC29 Suction temperature												The unit is [°C]
437	0010110110	IC30 Suction temperature												
438	1010110110	IC31 Suction temperature												
439	0110110110	IC32 Suction temperature												
440	1110110110	IC33 Suction temperature												
441	0001110110	IC34 Suction temperature												
442	1001110110	IC35 Suction temperature												
443	0101110110	IC36 Suction temperature												
444	1101110110	IC37 Suction temperature												
445	0011110110	IC38 Suction temperature												
446	1011110110	IC39 Suction temperature												
447	0111110110	IC40 Suction temperature												
448	1111110110	IC41 Suction temperature												
449	0000001110	IC42 Suction temperature												
450	1000001110	IC43 Suction temperature												
451	0100001110	IC44 Suction temperature												
452	1100001110	IC45 Suction temperature												
453	0010001110	IC46 Suction temperature												
454	1010001110	IC47 Suction temperature												
455	0110001110	IC48 Suction temperature												
456	1110001110	IC49 Suction temperature												
457	0001001110	IC50 Suction temperature												
458	1001001110	IC1 Liquid pipe temperature												The unit is [°C]
459	0101001110	IC2 Liquid pipe temperature												
460	1101001110	IC3 Liquid pipe temperature												
461	0011001110	IC4 Liquid pipe temperature												
462	1011001110	IC5 Liquid pipe temperature												
463	0111001110	IC6 Liquid pipe temperature												
463	1111001110	IC6 Liquid pipe temperature												
463	0001001110	IC6 Liquid pipe temperature												

*1 A: The condition of either OC or OS is displayed individually. B: The condition of the entire refrigerant system is displayed.

[X LED monitor display on the outdoor unit board]

Data on indoor unit system

No.	SW1	Item	Display								Unit (A, B) ^{*1}		Remarks	
			LD1	LD2	LD3	LD4	LD5	LD6	LD7	LD8	OC	OS		
464	0000101110	IC7 Liquid pipe temperature												The unit is [°C]
465	1000101110	IC8 Liquid pipe temperature												
466	0100101110	IC9 Liquid pipe temperature												
467	1100101110	IC10 Liquid pipe temperature												
468	0010101110	IC11 Liquid pipe temperature												
469	1010101110	IC12 Liquid pipe temperature												
470	0110101110	IC13 Liquid pipe temperature												
471	1110101110	IC14 Liquid pipe temperature												
472	0001101110	IC15 Liquid pipe temperature												
473	1001101110	IC16 Liquid pipe temperature												
474	0101101110	IC17 Liquid pipe temperature												
475	1101101110	IC18 Liquid pipe temperature												
476	0011101110	IC19 Liquid pipe temperature												
477	1011101110	IC20 Liquid pipe temperature												
478	0111101110	IC21 Liquid pipe temperature												
479	1111101110	IC22 Liquid pipe temperature												
480	0000011110	IC23 Liquid pipe temperature												
481	1000011110	IC24 Liquid pipe temperature												
482	0100011110	IC25 Liquid pipe temperature												
483	1100011110	IC26 Liquid pipe temperature												
484	0010011110	IC27 Liquid pipe temperature												
485	1010011110	IC28 Liquid pipe temperature												
486	0110011110	IC29 Liquid pipe temperature												
487	1110011110	IC30 Liquid pipe temperature												
488	0001011110	IC31 Liquid pipe temperature												
489	1001011110	IC32 Liquid pipe temperature												
490	0101011110	IC33 Liquid pipe temperature												
491	1101011110	IC34 Liquid pipe temperature												

*1 A: The condition of either OC or OS is displayed individually. B: The condition of the entire refrigerant system is displayed.

Data on indoor unit system

No.	SW1	Item	Display								Unit (A, B) *1		Remarks	
			LD1	LD2	LD3	LD4	LD5	LD6	LD7	LD8	OC	OS		
492	1234567890	IC35 Liquid pipe temperature												The unit is [°C]
493	0011011110	IC36 Liquid pipe temperature												
494	1011011110	IC37 Liquid pipe temperature												
495	0111011110	IC38 Liquid pipe temperature												
496	1111011110	IC39 Liquid pipe temperature												
497	0000111110	IC40 Liquid pipe temperature												
498	1000111110	IC41 Liquid pipe temperature												
499	0100111110	IC42 Liquid pipe temperature												
500	1100111110	IC43 Liquid pipe temperature												
501	0010111110	IC44 Liquid pipe temperature												
502	1010111110	IC45 Liquid pipe temperature												
503	0110111110	IC46 Liquid pipe temperature												
504	1110111110	IC47 Liquid pipe temperature												
505	0001111110	IC48 Liquid pipe temperature												
506	1001111110	IC49 Liquid pipe temperature												
507	0101111110	IC50 Liquid pipe temperature												
508	1101111110													
509	0011111110													
510	1011111110													
511	0111111110													

*1 A: The condition of either OC or OS is displayed individually. B: The condition of the entire refrigerant system is displayed.

Setting data

No.	SW1	Item	Display								Unit (A, B) ^{*1}		Remarks	
			LD1	LD2	LD3	LD4	LD5	LD6	LD7	LD8	OC	OS		
512	1234567890	Self-address										A	A	
513	0000000001	IC/FU address												
514	1000000001	RC address											B	
515	0100000001	BC/BS/TU address												
516	1100000001	OS address											B	
517	0010000001	Version/Capacity											A	A
518	1010000001	OC address												B
519	0110000001													
520	0001000001													
521	1001000001													
522	0101000001													

*1 A: The condition of either OC or OS is displayed individually. B: The condition of the entire refrigerant system is displayed.

Data on indoor unit system

No.	SW1	Item	Display								Unit (A, B) ^{*1}		Remarks
			LD1	LD2	LD3	LD4	LD5	LD6	LD7	LD8	OC	OS	
523	1101000001	IC1 Gas pipe temperature				-99.9 to 999.9							The unit is [°C]
524	0011000001	IC2 Gas pipe temperature				-99.9 to 999.9							
525	1011000001	IC3 Gas pipe temperature				-99.9 to 999.9							
526	0111000001	IC4 Gas pipe temperature				-99.9 to 999.9							
527	1111000001	IC5 Gas pipe temperature				-99.9 to 999.9							
528	0000100001	IC6 Gas pipe temperature				-99.9 to 999.9							
529	1000100001	IC7 Gas pipe temperature				-99.9 to 999.9							
530	0100100001	IC8 Gas pipe temperature				-99.9 to 999.9							
531	1100100001	IC9 Gas pipe temperature				-99.9 to 999.9							
532	0010100001	IC10 Gas pipe temperature				-99.9 to 999.9							
533	1010100001	IC11 Gas pipe temperature				-99.9 to 999.9							
534	0110100001	IC12 Gas pipe temperature				-99.9 to 999.9							
535	1110100001	IC13 Gas pipe temperature				-99.9 to 999.9							
536	0001100001	IC14 Gas pipe temperature				-99.9 to 999.9							
537	1001100001	IC15 Gas pipe temperature				-99.9 to 999.9							
538	0101100001	IC16 Gas pipe temperature				-99.9 to 999.9							
539	1101100001	IC17 Gas pipe temperature				-99.9 to 999.9							
540	0011100001	IC18 Gas pipe temperature				-99.9 to 999.9							
541	1011100001	IC19 Gas pipe temperature				-99.9 to 999.9							
542	0111100001	IC20 Gas pipe temperature				-99.9 to 999.9							
543	1111100001	IC21 Gas pipe temperature				-99.9 to 999.9							
544	0000010001	IC22 Gas pipe temperature				-99.9 to 999.9							
545	1000010001	IC23 Gas pipe temperature				-99.9 to 999.9							
546	0100010001	IC24 Gas pipe temperature				-99.9 to 999.9							
547	1100010001	IC25 Gas pipe temperature				-99.9 to 999.9							
548	0010010001	IC26 Gas pipe temperature				-99.9 to 999.9							
549	1010010001	IC27 Gas pipe temperature				-99.9 to 999.9							

*1 A: The condition of either OC or OS is displayed individually. B: The condition of the entire refrigerant system is displayed.

Data on indoor unit system

No.	SW1	Item	Display								Unit (A, B) *1		Remarks
			LD1	LD2	LD3	LD4	LD5	LD6	LD7	LD8	OC	OS	
550	0110010001	IC28 Gas pipe temperature				-99.9 to 999.9						B	The unit is [°C]
551	1110010001	IC29 Gas pipe temperature				-99.9 to 999.9							
552	0001010001	IC30 Gas pipe temperature				-99.9 to 999.9							
553	1001010001	IC31 Gas pipe temperature				-99.9 to 999.9							
554	0101010001	IC32 Gas pipe temperature				-99.9 to 999.9							
555	1101010001	IC33 Gas pipe temperature				-99.9 to 999.9							
556	0011010001	IC34 Gas pipe temperature				-99.9 to 999.9							
557	1011010001	IC35 Gas pipe temperature				-99.9 to 999.9							
558	0111010001	IC36 Gas pipe temperature				-99.9 to 999.9							
559	1111010001	IC37 Gas pipe temperature				-99.9 to 999.9							
560	0000110001	IC38 Gas pipe temperature				-99.9 to 999.9							
561	1000110001	IC39 Gas pipe temperature				-99.9 to 999.9							
562	0100110001	IC40 Gas pipe temperature				-99.9 to 999.9							
563	1100110001	IC41 Gas pipe temperature				-99.9 to 999.9							
564	0010110001	IC42 Gas pipe temperature				-99.9 to 999.9							
565	1010110001	IC43 Gas pipe temperature				-99.9 to 999.9							
566	0110110001	IC44 Gas pipe temperature				-99.9 to 999.9							
567	1110110001	IC45 Gas pipe temperature				-99.9 to 999.9							
568	0001110001	IC46 Gas pipe temperature				-99.9 to 999.9							
569	1001110001	IC47 Gas pipe temperature				-99.9 to 999.9							
570	0101110001	IC48 Gas pipe temperature				-99.9 to 999.9							
571	1101110001	IC49 Gas pipe temperature				-99.9 to 999.9							
572	0011110001	IC50 Gas pipe temperature				-99.9 to 999.9							

*1 A: The condition of either OC or OS is displayed individually. B: The condition of the entire refrigerant system is displayed.

Data on indoor unit system

No.	SW1	Item	Display								Unit (A, B) ^{*1}		Remarks
			LD1	LD2	LD3	LD4	LD5	LD6	LD7	LD8	OC	OS	
573	1011110001	IC1SH											
574	0111110001	IC2SH											
575	1111110001	IC3SH											
576	0000001001	IC4SH											
577	1000001001	IC5SH											
578	0100001001	IC6SH											
579	1100001001	IC7SH											
580	0010001001	IC8SH											
581	1010001001	IC9SH											
582	0110001001	IC10SH											
583	1110001001	IC11SH											
584	0001001001	IC12SH											
585	1001001001	IC13SH											
586	0101001001	IC14SH											
587	1101001001	IC15SH											
588	0011001001	IC16SH											
589	1011001001	IC17SH											
590	0111001001	IC18SH											
591	1111001001	IC19SH											
592	0000101001	IC20SH											
593	1000101001	IC21SH											
594	0100101001	IC22SH											
595	1100101001	IC23SH											
596	0010101001	IC24SH											
597	1010101001	IC25SH											
598	0110101001	IC26SH											
599	1110101001	IC27SH											

*1 A: The condition of either OC or OS is displayed individually. B: The condition of the entire refrigerant system is displayed.

Data on indoor unit system

No.	SW1	Item	Display								Unit (A, B) ^{*1}		Remarks	
			LD1	LD2	LD3	LD4	LD5	LD6	LD7	LD8	OC	OS		
600	1234567890													The unit is [°C]
601	0001101001	IC28SH											B	
602	1001101001	IC29SH												
603	0101101001	IC30SH												
604	1101101001	IC31SH												
605	0011101001	IC32SH												
606	1011101001	IC33SH												
607	0111101001	IC34SH												
608	1111101001	IC35SH												
609	0000011001	IC36SH												
610	1000011001	IC37SH												
611	0100011001	IC38SH												
612	1100011001	IC39SH												
613	0010011001	IC40SH												
614	1010011001	IC41SH												
615	0110011001	IC42SH												
616	1110011001	IC43SH												
617	0001011001	IC44SH												
618	1001011001	IC45SH												
619	0101011001	IC46SH												
620	1101011001	IC47SH												
621	0011011001	IC48SH												
622	1011011001	IC49SH												
623	0111011001	IC50SH												

*1 A: The condition of either OC or OS is displayed individually. B: The condition of the entire refrigerant system is displayed.

Data on indoor unit system

No.	SW1	Item	Display								Unit (A, B) ^{*1}		Remarks	
			LD1	LD2	LD3	LD4	LD5	LD6	LD7	LD8	OC	OS		
623	1111011001	IC1SC				-99.9 to 999.9						OC	OS	The unit is [°C]
624	0000111001	IC2SC				-99.9 to 999.9								
625	1000111001	IC3SC				-99.9 to 999.9								
626	0100111001	IC4SC				-99.9 to 999.9								
627	1100111001	IC5SC				-99.9 to 999.9								
628	0010111001	IC6SC				-99.9 to 999.9								
629	1010111001	IC7SC				-99.9 to 999.9								
630	0110111001	IC8SC				-99.9 to 999.9								
631	1110111001	IC9SC				-99.9 to 999.9								
632	0001111001	IC10SC				-99.9 to 999.9								
633	1001111001	IC11SC				-99.9 to 999.9								
634	0101111001	IC12SC				-99.9 to 999.9								
635	1101111001	IC13SC				-99.9 to 999.9								
636	0011111001	IC14SC				-99.9 to 999.9								
637	1011111001	IC15SC				-99.9 to 999.9								
638	0111111001	IC16SC				-99.9 to 999.9								
639	1111111001	IC17SC				-99.9 to 999.9								
640	000000101	IC18SC				-99.9 to 999.9								
641	100000101	IC19SC				-99.9 to 999.9								
642	010000101	IC20SC				-99.9 to 999.9								
643	110000101	IC21SC				-99.9 to 999.9								
644	001000101	IC22SC				-99.9 to 999.9								
645	101000101	IC23SC				-99.9 to 999.9								
646	011000101	IC24SC				-99.9 to 999.9								
647	111000101	IC25SC				-99.9 to 999.9								
648	0001000101	IC26SC				-99.9 to 999.9								
649	1001000101	IC27SC				-99.9 to 999.9								

*1 A: The condition of either OC or OS is displayed individually. B: The condition of the entire refrigerant system is displayed.

Data on indoor unit system

No.	SW1	Item	Display								Unit (A, B)*1		Remarks	
			LD1	LD2	LD3	LD4	LD5	LD6	LD7	LD8	OC	OS		
650	0101000101	IC28SC												The unit is [°C]
651	1101000101	IC29SC												
652	0011000101	IC30SC												
653	1011000101	IC31SC												
654	0111000101	IC32SC												
655	1111000101	IC33SC												
656	0000100101	IC34SC												
657	1000100101	IC35SC												
658	0100100101	IC36SC												
659	1100100101	IC37SC												
660	0010100101	IC38SC												
661	1010100101	IC39SC												
662	0110100101	IC40SC												
663	1110100101	IC41SC												
664	0001100101	IC42SC												
665	1001100101	IC43SC												
666	0101100101	IC44SC												
667	1101100101	IC45SC												
668	0011100101	IC46SC												
669	1011100101	IC47SC												
670	0111100101	IC48SC												
671	1111100101	IC49SC												
672	0000010101	IC50SC												
673	1000010101													
674	0100010101													
675	1100010101													

*1 A: The condition of either OC or OS is displayed individually. B: The condition of the entire refrigerant system is displayed.

Setting data

No.	SW1 1234567890	Item	Display								Unit (A, B) ^{*1}		Remarks
			LD1	LD2	LD3	LD4	LD5	LD6	LD7	LD8	OC	OS	
676	0010010101	INV board SW version	0.00 to 99.99								A	A	
677	1010010101												
678	0110010101												
679	1110010101	Fan board SW version	0.00 to 99.99								A	A	
680	0001010101												
681	1001010101												
682	0101010101												
683	1101010101												
684	0011010101												
685	1011010101												
686	0111010101												
687	1111010101												

*1 A: The condition of either OC or OS is displayed individually. B: The condition of the entire refrigerant system is displayed.

Setting data

No.	SW1	Item	Display								Unit (A, B)*1		Remarks				
			LD1	LD2	LD3	LD4	LD5	LD6	LD7	LD8	OC	OS					
688	1234567890	Current time												00:00 to 23:59	A	A	Hour: minute
689	0000110101	Current time -2												00.00 to 99.12/1 to 31			Year and month, and date alternate display
690	1000110101	Time of error detection 1												00:00 to 23:59			Hour: minute
691	0100110101	Time of error detection 1-2												00.00 to 99.12/1 to 31			Year and month, and date alternate display
692	1100110101	Time of error detection 2												00:00 to 23:59			Hour: minute
693	0010110101	Time of error detection 2-2												00.00 to 99.12/1 to 31			Year and month, and date alternate display
694	1010110101	Time of error detection 3												00:00 to 23:59			Hour: minute
695	0110110101	Time of error detection 3-2												00.00 to 99.12/1 to 31			Year and month, and date alternate display
696	1110110101	Time of error detection 4												00:00 to 23:59			Hour: minute
697	0001110101	Time of error detection 4-2												00.00 to 99.12/1 to 31			Year and month, and date alternate display
698	1001110101	Time of error detection 5												00:00 to 23:59			Hour: minute
699	0101110101	Time of error detection 5-2												00.00 to 99.12/1 to 31			Year and month, and date alternate display
700	1101110101	Time of error detection 6												00:00 to 23:59			Hour: minute
701	0011110101	Time of error detection 6-2												00.00 to 99.12/1 to 31			Year and month, and date alternate display

*1 A: The condition of either OC or OS is displayed individually. B: The condition of the entire refrigerant system is displayed.

Setting data

No.	SW1	Item	Display								Unit (A, B)*1		Remarks		
			LD1	LD2	LD3	LD4	LD5	LD6	LD7	LD8	OC	OS			
702	1234567890	Time of error detection 7												Hour: minute	
703	0111110101	Time of error detection 7-2					00:00 to 23:59								Year and month, and date alternate display
704	1111110101	Time of error detection 8					00:00 to 23:59								Hour: minute
705	0000001101	Time of error detection 8-2					00:00 to 99.12/1 to 31								Year and month, and date alternate display
706	1000001101	Time of error detection 9					00:00 to 23:59								Hour: minute
707	0100001101	Time of error detection 9-2					00:00 to 99.12/1 to 31								Year and month, and date alternate display
708	1100001101	Time of error detection 10					00:00 to 23:59								Hour: minute
709	0010001101	Time of error detection 10-2					00:00 to 99.12/1 to 31								Year and month, and date alternate display
710	1010001101	Time of last data backup before error					00:00 to 23:59								Hour: minute
711	0110001101	Time of last data backup before error -2					00:00 to 99.12/1 to 31								Year and month, and date alternate display
712	1110001101														
713	0001001101														
	1001001101														

*1 A: The condition of either OC or OS is displayed individually. B: The condition of the entire refrigerant system is displayed.

Data on indoor unit system

No.	SW1	Item	Display										Unit (A, B)*1		Remarks	
			LD1	LD2	LD3	LD4	LD5	LD6	LD7	LD8	OC	OS				
714	0101001101	IC1 LEV opening														
715	1101001101	IC2 LEV opening														
716	0011001101	IC3 LEV opening														
717	1011001101	IC4 LEV opening														
718	0111001101	IC5 LEV opening														
719	1111001101	IC6 LEV opening														
720	0000101101	IC7 LEV opening														
721	1000101101	IC8 LEV opening														
722	0100101101	IC9 LEV opening														
723	1100101101	IC10 LEV opening														
724	0010101101	IC11 LEV opening														
725	1010101101	IC12 LEV opening														
726	0110101101	IC13 LEV opening														
727	1110101101	IC14 LEV opening														
728	0001101101	IC15 LEV opening														
729	1001101101	IC16 LEV opening														
730	0101101101	IC17 LEV opening														
731	1101101101	IC18 LEV opening														
732	0011101101	IC19 LEV opening														
733	1011101101	IC20 LEV opening														
734	0111101101	IC21 LEV opening														
735	1111101101	IC22 LEV opening														
736	000011101	IC23 LEV opening														
737	100011101	IC24 LEV opening														
738	010001101	IC25 LEV opening														
739	110001101	IC26 LEV opening														
740	001001101	IC27 LEV opening														

*1 A: The condition of either OC or OS is displayed individually. B: The condition of the entire refrigerant system is displayed.

Data on indoor unit system

No.	SW1	Item	Display								Unit (A, B)*1		Remarks	
			LD1	LD2	LD3	LD4	LD5	LD6	LD7	LD8	OC	OS		
741	1234567890	IC28 LEV opening												Fully open: 2000
742	1010011101	IC29 LEV opening												
743	0110011101	IC30 LEV opening												
744	1110011101	IC31 LEV opening												
745	0001011101	IC32 LEV opening												
746	1001011101	IC33 LEV opening												
747	0101011101	IC34 LEV opening												
748	1101011101	IC35 LEV opening												
749	0011011101	IC36 LEV opening												
750	1011011101	IC37 LEV opening												
751	0111011101	IC38 LEV opening												
752	1111011101	IC39 LEV opening												
753	0000111101	IC40 LEV opening												
754	1000111101	IC41 LEV opening												
755	0100111101	IC42 LEV opening												
756	1100111101	IC43 LEV opening												
757	0010111101	IC44 LEV opening												
758	1010111101	IC45 LEV opening												
759	0110111101	IC46 LEV opening												
760	1110111101	IC47 LEV opening												
761	0001111101	IC48 LEV opening												
762	1001111101	IC49 LEV opening												
763	0101111101	IC50 LEV opening												
764	1101111101	IC1 Operation mode												
765	0011111101	IC2 Operation mode												
766	1011111101	IC3 Operation mode												
767	0111111101	IC4 Operation mode												
768	1111111101	IC5 Operation mode												

0000 : Stop 0001 : Ventilation 0002 : Cooling 0003 : Heating 0004 : Dry

*1 A: The condition of either OC or OS is displayed individually. B: The condition of the entire refrigerant system is displayed.

Data on indoor unit system

No.	SW1	Item	Display								Unit (A, B) ^{*1}		Remarks		
			LD1	LD2	LD3	LD4	LD5	LD6	LD7	LD8	OC	OS			
769	1234567890	IC6 Operation mode													
770	1000000011	IC7 Operation mode													
771	0100000011	IC8 Operation mode													
772	1100000011	IC9 Operation mode													
773	0010000011	IC10 Operation mode													
774	1010000011	IC11 Operation mode													
775	0110000011	IC12 Operation mode													
776	1110000011	IC13 Operation mode													
777	0001000011	IC14 Operation mode													
778	1001000011	IC15 Operation mode													
779	0101000011	IC16 Operation mode													
780	1101000011	IC17 Operation mode													
781	0011000011	IC18 Operation mode													
782	1011000011	IC19 Operation mode													
783	0111000011	IC20 Operation mode													
784	1111000011	IC21 Operation mode													
785	0000100011	IC22 Operation mode													
786	1000100011	IC23 Operation mode													
787	0100100011	IC24 Operation mode													
788	1100100011	IC25 Operation mode													
789	0010100011	IC26 Operation mode													
790	1010100011	IC27 Operation mode													
791	0110100011	IC28 Operation mode													
792	1110100011	IC29 Operation mode													
793	0001100011	IC30 Operation mode													
794	1001100011	IC31 Operation mode													
795	0101100011	IC32 Operation mode													
796	1101100011	IC33 Operation mode													

0000 : Stop 0001 : Ventilation 0002 : Cooling 0003 : Heating 0004 : Dry

*1 A: The condition of either OC or OS is displayed individually. B: The condition of the entire refrigerant system is displayed.

Data on indoor unit system

No.	SW1	Item	Display								Unit (A, B)*1		Remarks	
			LD1	LD2	LD3	LD4	LD5	LD6	LD7	LD8	OC	OS		
825	1234567890	IC12 filter				0000 to 9999							B	Hours since last maintenance [h]
826	0101110011	IC13 filter				0000 to 9999								
827	1101110011	IC14 filter				0000 to 9999								
828	0011110011	IC15 filter				0000 to 9999								
829	1011110011	IC16 filter				0000 to 9999								
830	0111110011	IC17 filter				0000 to 9999								
831	1111110011	IC18 filter				0000 to 9999								
832	0000001011	IC19 filter				0000 to 9999								
833	1000001011	IC20 filter				0000 to 9999								
834	0100001011	IC21 filter				0000 to 9999								
835	1100001011	IC22 filter				0000 to 9999								
836	0010001011	IC23 filter				0000 to 9999								
837	1010001011	IC24 filter				0000 to 9999								
838	0110001011	IC25 filter				0000 to 9999								
839	1110001011	IC26 filter				0000 to 9999								
840	0001001011	IC27 filter				0000 to 9999								
841	1001001011	IC28 filter				0000 to 9999								
842	0101001011	IC29 filter				0000 to 9999								
843	1101001011	IC30 filter				0000 to 9999								
844	0011001011	IC31 filter				0000 to 9999								
845	1011001011	IC32 filter				0000 to 9999								
846	0111001001	IC33 filter				0000 to 9999								
847	1111001011	IC34 filter				0000 to 9999								
848	0000101011	IC35 filter				0000 to 9999								
849	1000101011	IC36 filter				0000 to 9999								
850	0100101011	IC37 filter				0000 to 9999								
851	1100101011	IC38 filter				0000 to 9999								
852	0010101011	IC39 filter				0000 to 9999								

*1 A: The condition of either OC or OS is displayed individually. B: The condition of the entire refrigerant system is displayed.

Data on indoor unit system

No.	SW1	Item	Display								Unit (A, B)*1		Remarks	
			LD1	LD2	LD3	LD4	LD5	LD6	LD7	LD8	OC	OS		
853	1234567890	IC40 filter												
854	1010101011	IC41 filter												
855	0110101011	IC42 filter												
856	1110101011	IC43 filter												
857	0001101011	IC44 filter												
858	1001101011	IC45 filter												
859	0101101011	IC46 filter												
860	1101101011	IC47 filter												
861	0011101011	IC48 filter												
862	1011101011	IC49 filter												
863	0111101011	IC50 filter												

*1 A: The condition of either OC or OS is displayed individually. B: The condition of the entire refrigerant system is displayed.

Other types of data

No.	SW1	Item	Display								Unit (A, B)*1		Remarks	
			LD1	LD2	LD3	LD4	LD5	LD6	LD7	LD8	OC	OS		
864	1234567890													
865	0000011011													
866	1000011011													
867	0100011011													
868	1100011011													
869	0010011011													
870	1010011011													
871	1110011011	U-phase current effective value 1							-99.9 to 999.9			A	A	The unit is [A]
872	0001011011	W-phase current effective value 1							-99.9 to 999.9			A	A	
873	1001011011	Power factor phase angle 1							-99.9 to 999.9			A	A	The unit is [deg]
874	0101011011													
875	1101011011													
876	0011011011													
877	1011011011													
878	0111011011													
879	1111011011													
880	0000111011	Control board Reset counter							0 to 254			A	A	The unit is [time]
881	1000111011	INV board Reset counter							0 to 254			A	A	
882	0100111011													
883	1100111011													
884	0010111011	Fan board Reset counter							0 to 254			A	A	The unit is [time]
885	1010111011													
886	0110111011													

*1 A: The condition of either OC or OS is displayed individually. B: The condition of the entire refrigerant system is displayed.

[X LED monitor display on the outdoor unit board]

Other types of data

No.	SW1	Item	Display								Unit (A, B) ^{*1}			Remarks
			LD1	LD2	LD3	LD4	LD5	LD6	LD7	LD8	OC	OS		
887	1234567890													
888	1110111011													
889	0001111011													
889	1001111011													
890	0101111011													
891	1101111011													
892	0011111011													
893	1011111011													
894	0111111011													
895	1111111011													
896	000000111													
897	100000111													
898	010000111													
899	110000111													
900	001000111													
901	101000111													
902	011000111													
903	111000111													
904	0001000111													
905	1001000111													
906	0101000111													
907	1101000111													
1020	0011111111													
1021	1011111111													
1022	0111111111													
1023	1111111111													

*1 A: The condition of either OC or OS is displayed individually. B: The condition of the entire refrigerant system is displayed.

**Service Handbook PUHY-P72, P96, P120Y(T)HMU-A
PUHY-P144, P168, P192, P216, P240Y(T)SHMU-A
PUHY-P264, P288, P312, P336, P360Y(T)SHMU-A**

