

SERVICE MANUAL

Series PKA Wall Mounted R410A

Indoor unit
[Model Name]

PKA-A24KA7

PKA-A30KA7

PKA-A36KA7

[Service Ref.]

PKA-A24KA7.TH

PKA-A30KA7.TH

PKA-A36KA7.TH

Notes:

- This manual describes service data of the indoor units only.
- RoHS compliant products have <G> mark on the spec name plate.

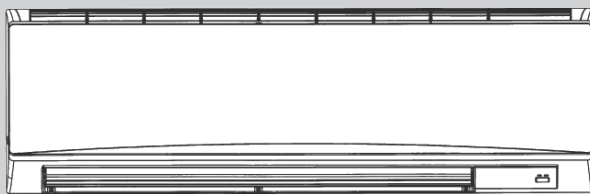

INDOOR UNIT



IR WIRELESS REMOTE
CONTROLLER
(Option)

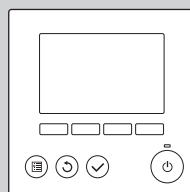

WIRED REMOTE
CONTROLLER
(Option)

CONTENTS

1. REFERENCE MANUAL.....	2
2. SAFETY PRECAUTION.....	3
3. PARTS NAMES AND FUNCTIONS.....	5
4. SPECIFICATIONS.....	10
5. NOISE CRITERION CURVES.....	11
6. OUTLINES AND DIMENSIONS.....	12
7. WIRING DIAGRAM.....	13
8. REFRIGERANT SYSTEM DIAGRAM.....	14
9. TROUBLESHOOTING.....	15
10. FUNCTION SETTING.....	29
11. SPECIAL FUNCTION.....	30
12. DISASSEMBLY PROCEDURE.....	34

PARTS CATALOG (OCB639)

OUTDOOR UNIT SERVICE MANUAL

Model Name	Service Ref.	Service Manual No.
PUZ-A24/30NHA7 PUZ-A36NKA7 PUZ-A24/30NHA7-BS PUZ-A36NKA7-BS	PUZ-A24/30NHA7 PUZ-A36NKA7 PUZ-A24/30NHA7-BS PUZ-A36NKA7-BS	OCH636 OCB636
PUY-A24/30NHA7 PUY-A36NKA7 PUY-A24/30NHA7-BS PUY-A36NKA7-BS	PUY-A24/30NHA7 PUY-A36NKA7 PUY-A24/30NHA7-BS PUY-A36NKA7-BS	
PUZ-HA30/36NHA5	PUZ-HA30/36NHA5	OCH607/OCB607

■ Remote controller (Optional parts)

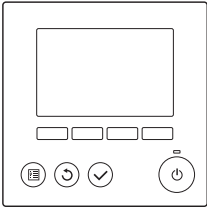
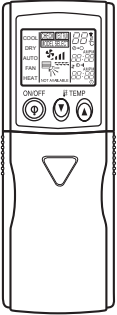
Wired remote controller	IR wireless remote controller
	

2-1. ALWAYS OBSERVE FOR SAFETY

Before obtaining access to terminal, all supply circuits must be disconnected.

2-2. CAUTIONS RELATED TO NEW REFRIGERANT

Caution for units utilising refrigerant R410A

Use new refrigerant pipes.

Make sure that the inside and outside of refrigerant piping is clean and it has no contaminants such as sulfur, oxides, dirt, shaving particles, etc, which are hazards to refrigerant cycle. In addition, use pipes with specified thickness.

Contamination inside refrigerant piping can cause deterioration of refrigerant oil, etc.

Store the piping indoors, and both ends of the piping sealed until just before brazing. (Leave elbow joints, etc. in their packaging.)

If dirt, dust or moisture enters into refrigerant cycle, that can cause deterioration of refrigerant oil or malfunction of compressor.

The refrigerant oil applied to flare and flange connections must be ester oil, ether oil or alkylbenzene oil in a small amount.

If large amount of mineral oil enters, that can cause deterioration of refrigerant oil, etc.

Charge refrigerant from liquid phase of gas cylinder.

If the refrigerant is charged from gas phase, composition change may occur in refrigerant and the efficiency will be lowered.

Do not use refrigerant other than R410A.

If other refrigerant (R22, etc.) is used, chlorine in refrigerant can cause deterioration of refrigerant oil, etc.

Use a vacuum pump with a reverse flow check valve.

Vacuum pump oil may flow back into refrigerant cycle and that can cause deterioration of refrigerant oil, etc.

Use the following tools specifically designed for use with R410A refrigerant.

The following tools are necessary to use R410A refrigerant.

Tools for R410A	
Gauge manifold	Flare tool
Charge hose	Size adjustment gauge
Gas leak detector	Vacuum pump adaptor
Torque wrench	Electronic refrigerant charging scale

Handle tools with care.

If dirt, dust or moisture enters into refrigerant cycle, that can cause deterioration of refrigerant oil or malfunction of compressor.

Do not use a charging cylinder.

If a charging cylinder is used, the composition of refrigerant will change and the efficiency will be lowered.

Ventilate the room if refrigerant leaks during operation. If refrigerant comes into contact with a flame, poisonous gases will be released.

Use the specified refrigerant only.

Never use any refrigerant other than that specified. Doing so may cause a burst, an explosion, or fire when the unit is being used, serviced, or disposed of. Correct refrigerant is specified in the manuals and on the spec labels provided with our products. We will not be held responsible for mechanical failure, system malfunction, unit breakdown or accidents caused by failure to follow the instructions.

[1] Cautions for service

- (1) Perform service after recovering the refrigerant left in unit completely.
- (2) Do not release refrigerant in the air.
- (3) After completing service, charge the cycle with specified amount of refrigerant.
- (4) If moisture or foreign matter might have entered the refrigerant piping during service, ensure to remove them.

[2] Additional refrigerant charge

When charging directly from cylinder

- (1) Check that cylinder for R410A on the market is a syphon type.
- (2) Charging should be performed with the cylinder of syphon stood vertically. (Refrigerant is charged from liquid phase.)

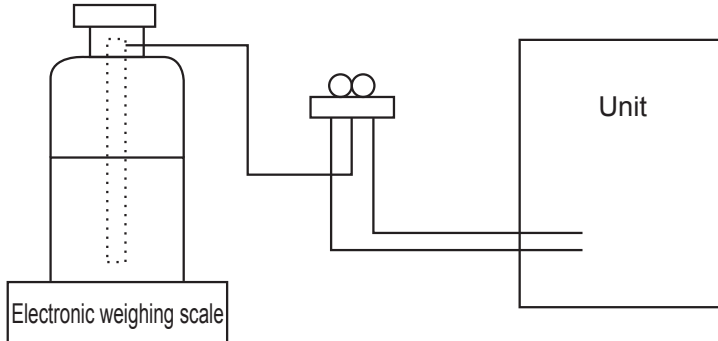

[3] Service tools

Use the below service tools as exclusive tools for R410A refrigerant.

No.	Tool name	Specifications
①	Gauge manifold	<ul style="list-style-type: none"> · Only for R410A · Use the existing fitting specifications. (UNF1/2) · Use high-tension side pressure of 768.7 PSIG [5.3 MPa.G] or over.
②	Charge hose	<ul style="list-style-type: none"> · Only for R410A · Use pressure performance of 738.2 PSIG [5.09MPa.G] or over.
③	Electronic scale	—
④	Gas leak detector	· Use the detector for R134a, R407C or R410A.
⑤	Adaptor for reverse flow check	· Attach on vacuum pump.
⑥	Refrigerant charge base	—
⑦	Refrigerant cylinder	<ul style="list-style-type: none"> · Only for R410A · Top of cylinder (Pink) · Cylinder with syphon
⑧	Refrigerant recovery equipment	—

3

PARTS NAMES AND FUNCTIONS

3-1. Indoor unit

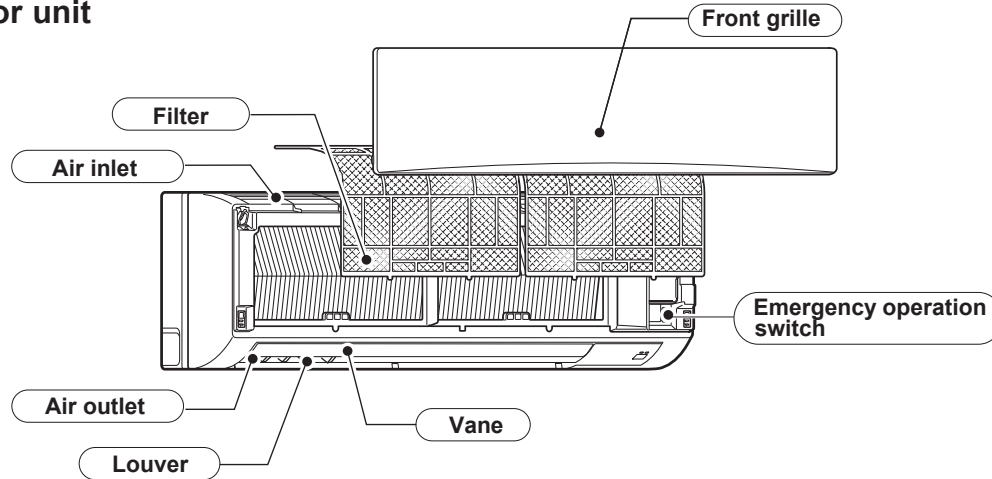

3-2. Wired remote controller (Option)

Controller interface

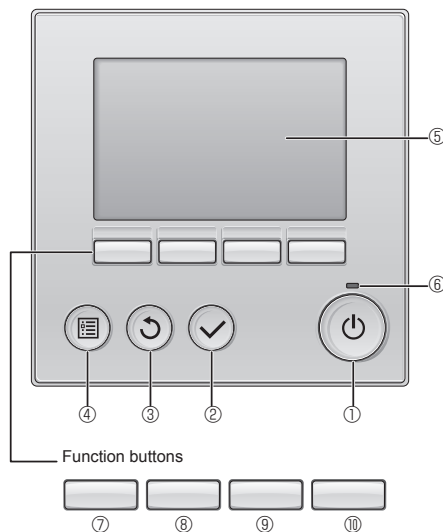

The functions of the function buttons change depending on the screen.

Refer to the button function guide that appears at the bottom of the LCD for the functions they serve on a given screen.

When the system is centrally controlled, the button function guide that corresponds to the locked button will not appear.

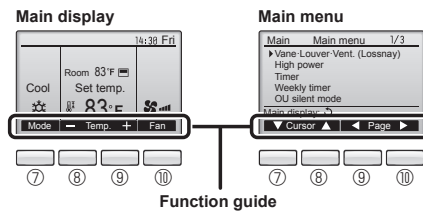

① [ON/OFF] button

Press to turn ON/OFF the indoor unit.

② [SELECT] button

Press to save the setting.

③ [RETURN] button

Press to return to the previous screen.

④ [MENU] button

Press to bring up the Main menu.

⑤ Backlit LCD

Operation settings will appear.

When the backlight is off, pressing any button turns the backlight on and it will stay lit for a certain period of time depending on the screen.

When the backlight is off, pressing any button turns the backlight on and does not perform its function. (except for the [ON/OFF] button)

⑥ ON/OFF lamp

This lamp lights up in green while the unit is in operation. It blinks while the remote controller is starting up or when there is an error.

⑦ Function button [F1]

Main display: Press to change the operation mode.

Main menu: Press to move the cursor down.

⑧ Function button [F2]

Main display: Press to decrease temperature.

Main menu: Press to move the cursor up.

⑨ Function button [F3]

Main display: Press to increase temperature.

Main menu: Press to go to the previous page.

⑩ Function button [F4]

Main display: Press to change the fan speed.

Main menu: Press to go to the next page.

Display

The main display can be displayed in 2 different modes: "Full" and "Basic". The initial setting is "Full". To switch to the "Basic" mode, change the setting on the Main display setting. (Refer to operation manual included with remote controller.)

<Full mode>

* All icons are displayed for explanation.

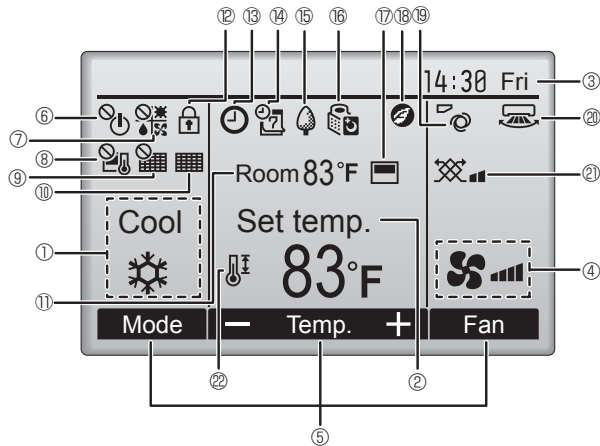

<Basic mode>

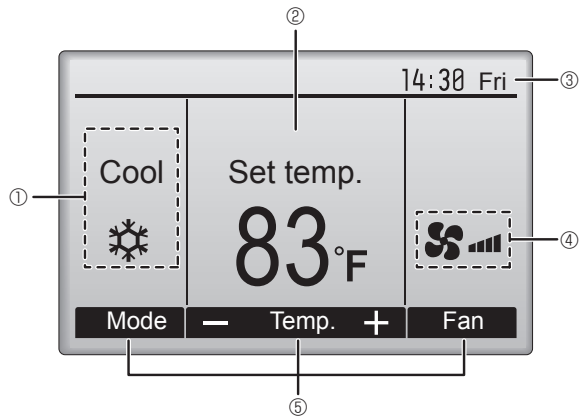

① Operation mode

Indoor unit operation mode appears here.

② Preset temperature

Preset temperature appears here.

③ Clock (See the Installation Manual.)

Current time appears here.

④ Fan speed

Fan speed setting appears here.

⑤ Button function guide

Functions of the corresponding buttons appear here.



Appears when the ON/OFF operation is centrally controlled.



Appears when the operation mode is centrally controlled.



Appears when the preset temperature is centrally controlled.



Appears when the filter reset function is centrally controlled.



Appears when filter needs maintenance.

⑪ Room temperature (See the Installation Manual.)

Current room temperature appears here.



Appears when the buttons are locked.



Appears when the ON/OFF timer, Night setback, or Auto-OFF timer function is enabled.



Appears when the timer is disabled by the centralized control system.



Appears when the Weekly timer is enabled.



Appears while the units are operated in the energy-save mode. (Will not appear on some models of indoor units)



Appears while the outdoor units are operated in the silent mode.



Appears when the built-in thermistor on the remote controller is activated to monitor the room temperature (⑪).



Appears when the thermistor on the indoor unit is activated to monitor the room temperature.



Appears when the units are operated in the energy-save mode with 3D i-see Sensor.



Indicates the vane setting.



Indicates the louver setting. (This indication is not available for this model.)



Indicates the ventilation setting.



Appears when the preset temperature range is restricted.

Most settings (except ON/OFF, mode, fan speed, temperature) can be made from the Menu screen. (Refer to operation manual included with remote controller.)

Menu structure

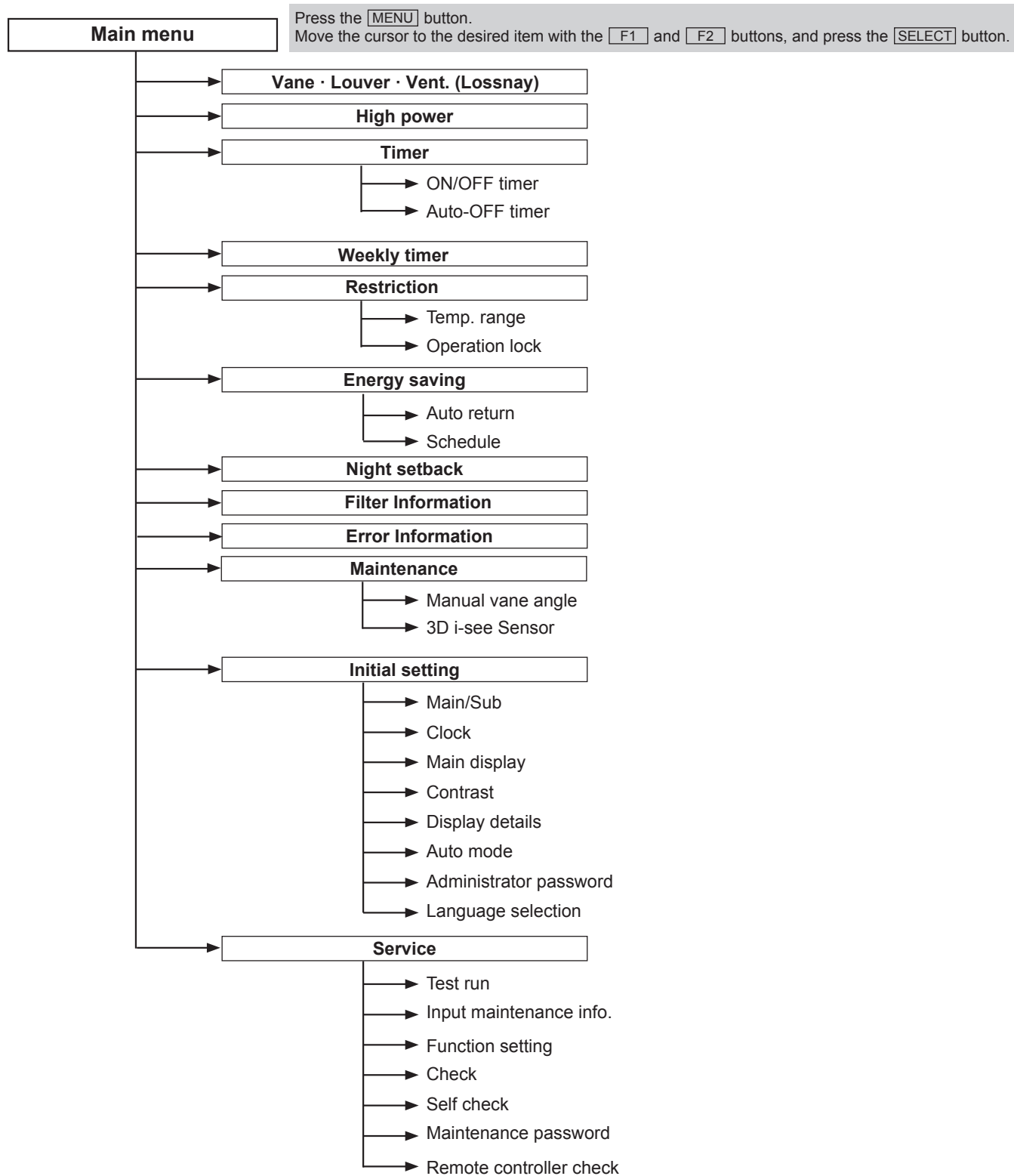

Not all functions are available on all models of indoor units.

Main menu list

Setting and display items		Setting details
Vane · Louver · Vent. (Lossnay)		<p>Use to set the vane angle.</p> <ul style="list-style-type: none"> • Select a desired vane setting from 5 different settings. <p>Use to turn ON/OFF the louver.</p> <ul style="list-style-type: none"> • Select a desired setting from "ON" and "OFF." <p>Use to set the amount of ventilation.</p> <ul style="list-style-type: none"> • Select a desired setting from "Off," "Low," and "High."
High power		<p>Use to reach the comfortable room temperature quickly.</p> <ul style="list-style-type: none"> • Units can be operated in the High-power mode for up to 30 minutes.
Timer	ON/OFF timer*	<p>Use to set the operation ON/OFF times.</p> <ul style="list-style-type: none"> • Time can be set in 5-minute increments.
	Auto-OFF timer	<p>Use to set the Auto-OFF time.</p> <ul style="list-style-type: none"> • Time can be set to a value from 30 to 240 in 10-minute increments.
Weekly timer*		<p>Use to set the weekly operation ON/OFF times.</p> <ul style="list-style-type: none"> • Up to 8 operation patterns can be set for each day. (Not valid when the ON/OFF timer is enabled.)
Restriction	Temp. range	<p>Use to restrict the preset temperature range.</p> <ul style="list-style-type: none"> • Different temperature ranges can be set for different operation modes.
	Operation lock	<p>Use to lock selected functions.</p> <ul style="list-style-type: none"> • The locked functions cannot be operated.
Energy saving	Auto return	<p>Use to get the units to operate at the preset temperature after performing energy-save operation for a specified time period.</p> <ul style="list-style-type: none"> • Time can be set to a value from 30 and 120 in 10-minute increments. (This function will not be valid when the preset temperature ranges are restricted.)
	Schedule*	<p>Set the start/stop times to operate the units in the energy-save mode for each day of the week, and set the energy-saving rate.</p> <ul style="list-style-type: none"> • Up to 4 energy-save operation patterns can be set for each day. • Time can be set in 5-minute increments. • Energy-saving rate can be set to a value from 0% or 50 to 90% in 10% increments.
Night setback*		<p>Use to make Night setback settings.</p> <ul style="list-style-type: none"> • Select "Yes" to enable the setting, and "No" to disable the setting. The temperature range and the start/stop times can be set.
Filter information		<p>Use to check the filter status.</p> <ul style="list-style-type: none"> • The filter sign can be reset.
Error information		<p>Use to check error information when an error occurs.</p> <ul style="list-style-type: none"> • Check code, error source, refrigerant address, unit model, manufacturing number, contact information (dealer's phone number) can be displayed. (The unit model, manufacturing number, and contact information need to be registered in advance to be displayed.)
Maintenance	Manual vane angle	<p>Use to set the vane angle for each vane to a fixed position.</p>
	3D i-see Sensor	<p>Use to set the following functions for 3D i-see Sensor.</p> <ul style="list-style-type: none"> • Air distribution • Energy saving option • Seasonal airflow
Initial setting	Main/Sub	<p>When connecting 2 remote controllers, one of them needs to be designated as a sub controller.</p>
	Clock	<p>Use to set the current time.</p>
	Main display	<p>Use to switch between "Full" and "Basic" modes for the Main display.</p> <ul style="list-style-type: none"> • The initial setting is "Full."
	Contrast	<p>Use to adjust screen contrast.</p>
	Display details	<p>Make the settings for the remote controller related items as necessary.</p> <p>Clock: The initial settings are "Yes" and "24h" format.</p> <p>Temperature: Set either Celsius (°C) or Fahrenheit (°F).</p> <p>Room temp. : Set Show or Hide.</p> <p>Auto mode: Set the Auto mode display or Only Auto display.</p>
	Auto mode	<p>Whether or not to use the Auto mode can be selected by using the button.</p> <p>This setting is valid only when indoor units with the Auto mode function are connected.</p>
	Administrator password	<p>The administrator password is required to make the settings for the following items.</p> <ul style="list-style-type: none"> • Timer setting • Energy-save setting • Weekly timer setting • Restriction setting • Outdoor unit silent mode setting • Night set back
	Language selection	<p>Use to select the desired language.</p>
Service	Test run	<p>Select "Test run" from the Service menu to bring up the Test run menu.</p> <ul style="list-style-type: none"> • Test run • Drain pump test run
	Input maintenance	<p>Select "Input maintenance Info." from the Service menu to bring up the Maintenance information screen.</p> <p>The following settings can be made from the Maintenance Information screen.</p> <ul style="list-style-type: none"> • Model name input • Serial No. input • Dealer information input
	Function setting	<p>Make the settings for the indoor unit functions via the remote controller as necessary.</p>
	Check	<p>Error history: Display the error history and execute "delete error history".</p> <p>Refrigerant leak check: Refrigerant leaks can be judged.</p> <p>Smooth maintenance: The indoor and outdoor maintenance data can be displayed.</p> <p>Request code: Details of the operation data including each thermistor temperature and error history can be checked.</p>
	Self check	<p>Error history of each unit can be checked via the remote controller.</p>
	Maintenance password	<p>Use to change the maintenance password.</p>
Remote controller check		<p>When the remote controller does not work properly, use the remote controller checking function to trouble-shoot the problem.</p>

* Clock setting is required.

3-3. IR wireless remote controller (Option)

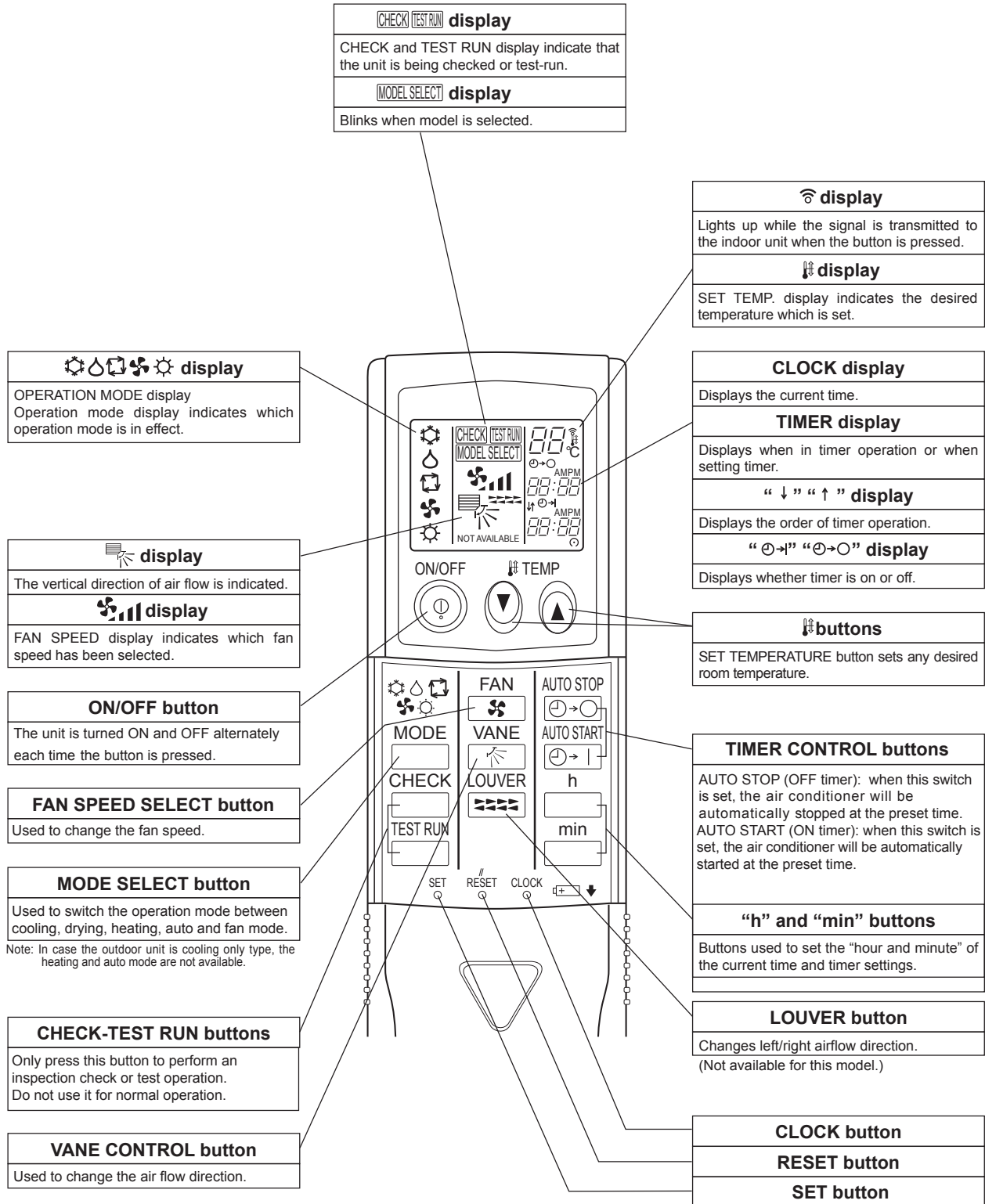

4

SPECIFICATIONS

Service Ref.			PKA-A24KA7.TH	
INDOOR UNIT	Power supply(phase, cycle, voltage)		1 phase, 60Hz, 208/230V	
	Max. Fuse Size	A	15	
	Min.Circuit Ampacity	A	1	
	External finish		White Munsell 1.0Y 9.2/0.2	
	Heat exchanger		Plate fin coil	
	Fan	Fan(drive) × No.		Line flow fan (direct) × 1
		Fan motor output	kW	0.056
		Fan motor	F.L.A	0.36
		Airflow(Low-Middle-High)	CFM (m ³ /min)	Dry: 635-705-775 (18-20-22) Wet: 570-635-700 (16-18-20)
		External static pressure	Pa (mmAq)	0(direct blow)
	Operation control & Thermostat			Remote controller & built-in
	Noise level(Low-Middle-High)		dB	39-42-45
	Field drain pipe I.D.		inch (mm)	5/8 (16)
	Dimensions	W	inch (mm)	46-1/16 (1170)
		D	inch (mm)	11-5/8 (295)
H		inch (mm)	14-3/8 (365)	
Weight		lb (kg)	46 (21)	

Service Ref.			PKA-A30KA7.TH	
INDOOR UNIT	Power supply(phase, cycle, voltage)		1 phase, 60Hz, 208/230V	
	Max. Fuse Size	A	15	
	Min.Circuit Ampacity	A	1	
	External finish		White Munsell 1.0Y 9.2/0.2	
	Heat exchanger		Plate fin coil	
	Fan	Fan(drive) × No.		Line flow fan (direct) × 1
		Fan motor output	kW	0.056
		Fan motor	F.L.A	0.36
		Airflow(Low-Middle-High)	CFM (m ³ /min)	Dry: 635-705-775 (18-20-22) Wet: 570-635-700 (16-18-20)
		External static pressure	Pa (mmAq)	0 (direct blow)
	Operation control & Thermostat			Remote controller & built-in
	Noise level(Low-Middle-High)		dB	39-42-45
	Field drain pipe I.D.		inch (mm)	5/8 (16)
	Dimensions	W	inch (mm)	46-1/16 (1170)
		D	inch (mm)	11-5/8 (295)
H		inch (mm)	14-3/8 (365)	
Weight		lb (kg)	46 (21)	

Service Ref.			PKA-A36KA7.TH	
INDOOR UNIT	Power supply(phase, cycle, voltage)		1 phase, 60Hz, 208/230V	
	Max. Fuse Size	A	15	
	Min.Circuit Ampacity	A	1	
	External finish		White Munsell 1.0Y 9.2/0.2	
	Heat exchanger		Plate fin coil	
	Fan	Fan(drive) × No.		Line flow fan (direct) × 1
		Fan motor output	kW	0.056
		Fan motor	F.L.A	0.57
		Airflow(Low-Middle-High)	CFM (m ³ /min)	Dry: 705-810-920 (20-23-26) Wet: 635-730-830 (18-21-23)
		External static pressure	Pa (mmAq)	0 (direct blow)
	Operation control & Thermostat			Remote controller & built-in
	Noise level(Low-Middle-High)		dB	43-46-49
	Field drain pipe I.D.		inch (mm)	5/8 (16)
	Dimensions	W	inch (mm)	46-1/16 (1170)
		D	inch (mm)	11-5/8 (295)
H		inch (mm)	14-3/8 (365)	
Weight		lb (kg)	46 (21)	

5

NOISE CRITERION CURVES

PKA-A24KA7.TH
PKA-A30KA7.TH

NOTCH	SPL(dB)	LINE
High	45	○—○
Low	39	●—●

PKA-A36KA7.TH

NOTCH	SPL(dB)	LINE
High	49	○—○
Low	43	●—●

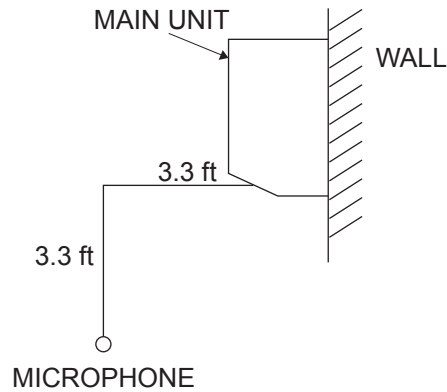
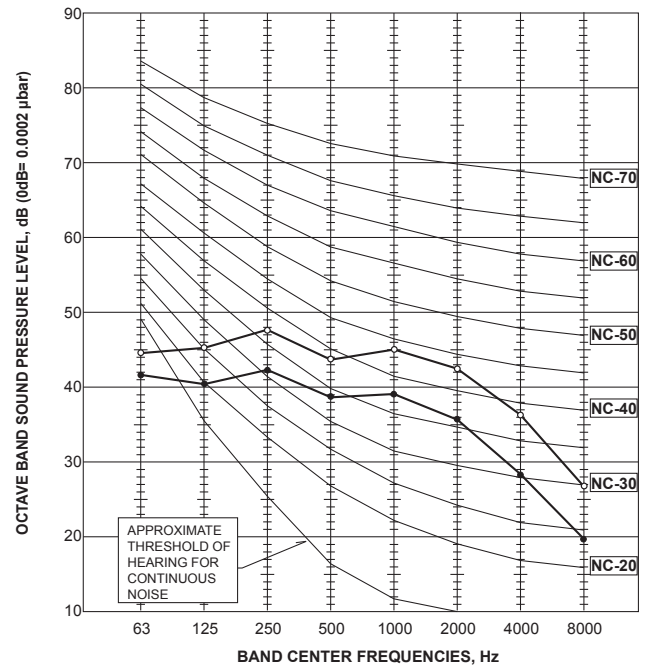
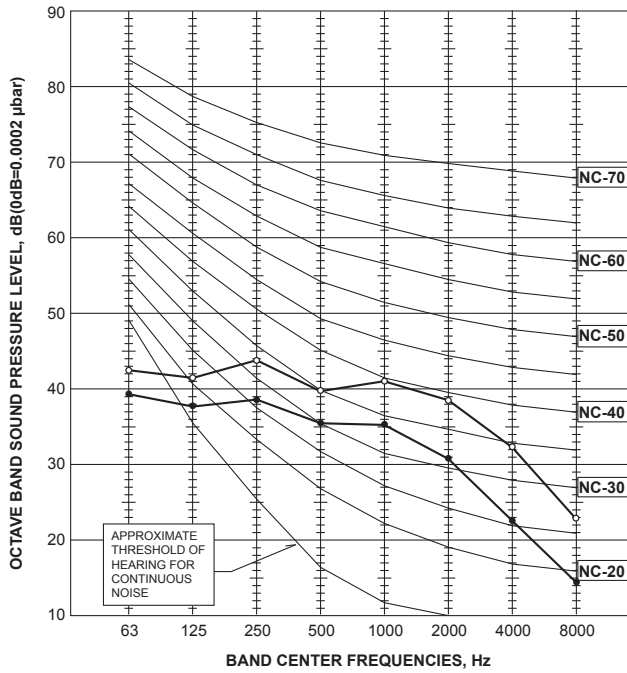

PKA-A24KA7.TH

PKA-A30KA7.TH

PKA-A36KA7.TH

Unit: inch (mm)

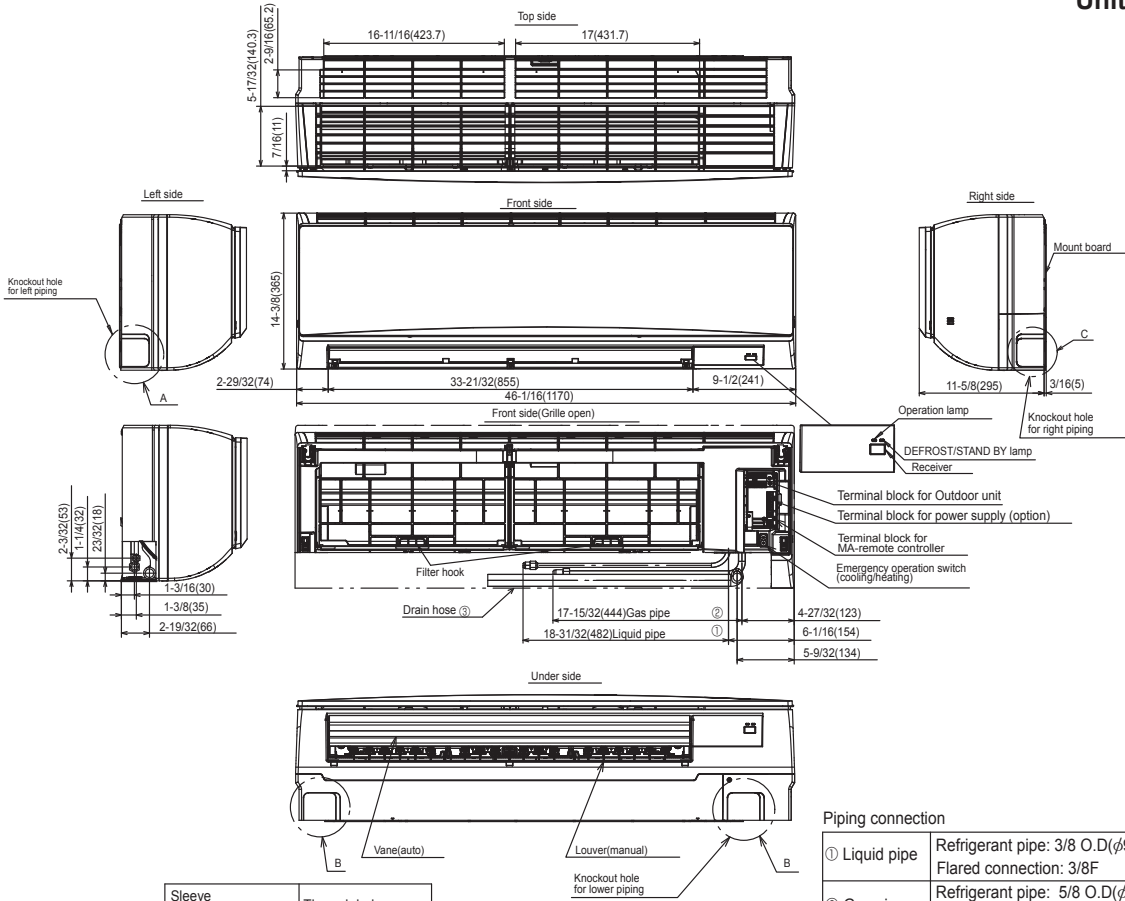

Sleeve (purchased locally)	Through hole
φ2-15/16 (φ75)	φ2-15/16~φ3-5/32 (φ75~φ80)

Piping connection	
① Liquid pipe	Refrigerant pipe: 3/8 O.D(φ9.52) Flared connection: 3/8F
② Gas pipe	Refrigerant pipe: 5/8 O.D(φ15.88) Flared connection: 5/8F
③ Drain hose	5/8(φ16) O.D Effective length: 23-1/32 (585)

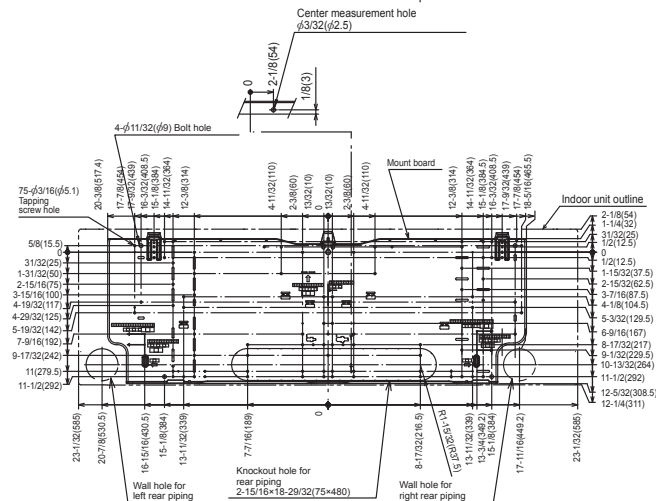
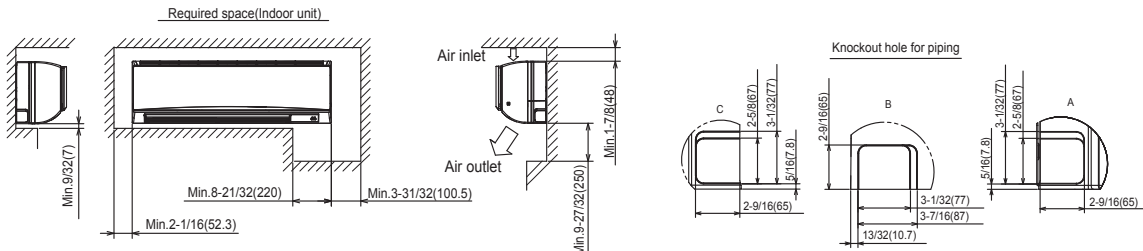

PKA-A24KA7.TH PKA-A30KA7.TH PKA-A36KA7.TH

[LEGEND]

SYMBOL	NAME	SYMBOL	NAME
I.B	INDOOR CONTROLLER BOARD	M	VANE MOTOR
CN2L	CONNECTOR (LOSSNAY)	MS	FAN MOTOR
CN32	CONNECTOR (REMOTE SWITCH)	S.W	SWITCH BOARD
CN41	CONNECTOR (HA TERMINAL-A)	SWE2	EMERGENCY OPERATION
CN51	CONNECTOR (CENTRALLY CONTROL)	TB4	TERMINAL BLOCK (INDOOR/OUTDOOR CONNECTING LINE)
CN90	CONNECTOR (REMOTE OPERATION ADAPTER)	TB5	TERMINAL BLOCK (REMOTE CONTROLLER TRANSMISSION LINE)
CN105	CONNECTOR	TH1	ROOM TEMP. THERMISTOR (32°F/15KΩ, 77°F/5.4KΩ DETECT)
CN152	CONNECTOR (BACK-UP HEATING)	TH2	PIPE TEMP. THERMISTOR/LIQUID (32°F/15KΩ, 77°F/5.4KΩ DETECT)
FUSE	FUSE(T3.15AL250V)	TH5	COND./EVA. TEMP. THERMISTOR (32°F/15KΩ, 77°F/5.4KΩ DETECT)
LED1	POWER SUPPLY (I.B)	W.B	PCB FOR IR WIRELESS REMOTE CONTROLLER
LED2	POWER SUPPLY (R.B)	LED1	LED (OPERATION INDICATION : GREEN)
LED3	TRANSMISSION (INDOOR-OUTDOOR)	LED2	LED (PREPARATION FOR HEATING: ORANGE)
SW1	SWITCH (MODEL SELECTION) Refer to <Table 1>	REC1	RECEIVING UNIT
SW2	SWITCH (CAPACITY CODE) Refer to <Table 2>		
SWE	CONNECTOR (EMERGENCY OPERATION)		
R.B	WIRED REMOTE CONTROLLER BOARD		
TB6	TERMINAL BLOCK (REMOTE CONTROLLER TRANSMISSION LINE)		

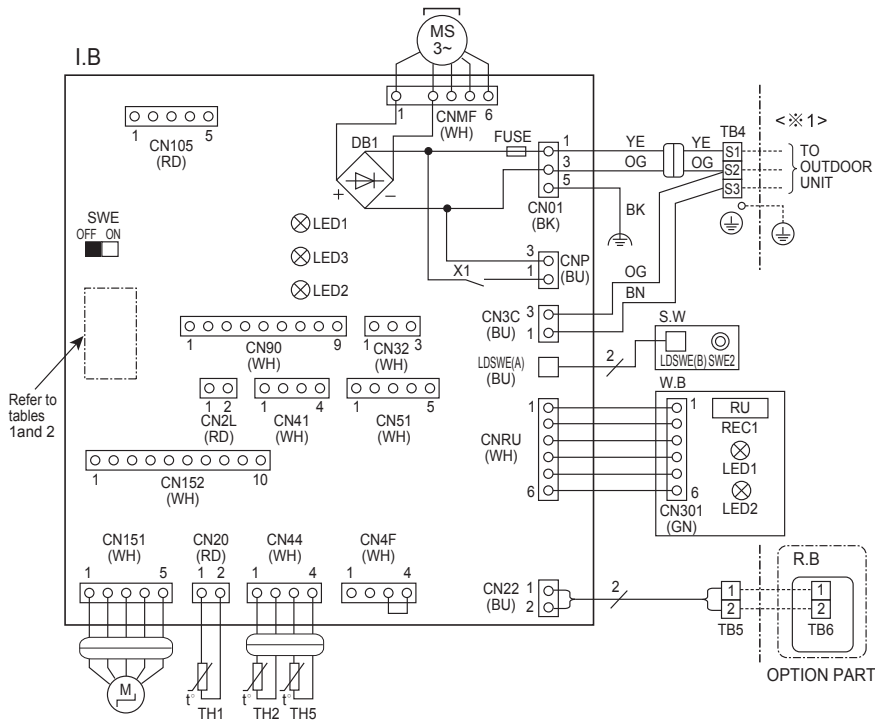

<Table 1>
SW1 (MODEL SELECTION)

SETTING
1 2 3 4 5
ON/OFF

<Table 2>
SW2 (CAPACITY CODE)

MODELS	SETTING	MODELS	SETTING	MODELS	SETTING
PKA-A24KA	1 2 3 4 5	PKA-A30KA	1 2 3 4 5	PKA-A36KA	1 2 3 4 5
	ON/OFF		ON/OFF		ON/OFF

The black square (■) indicates a switch position.

Notes:

- Symbols used in wiring diagram above are, :Connector, :Terminal (block).
- Indoor and outdoor connecting wires have polarities, make sure to match terminal numbers (S1, S2, S3) for correct wirings.
- Since the outdoor side electric wiring may change, be sure to check the outdoor unit electric wiring diagram for servicing.
- This diagram shows the wiring of indoor and outdoor connecting wires.(specification of 208V/230V), adopting superimposed system of power and signal.

- For power supply system of this unit, refer to the caution label located near this diagram.

※1: Use copper supply wires.
Utilisez des fils d'alimentation en cuivre.

PKA-A24KA7.TH

PKA-A30KA7.TH

PKA-A36KA7.TH

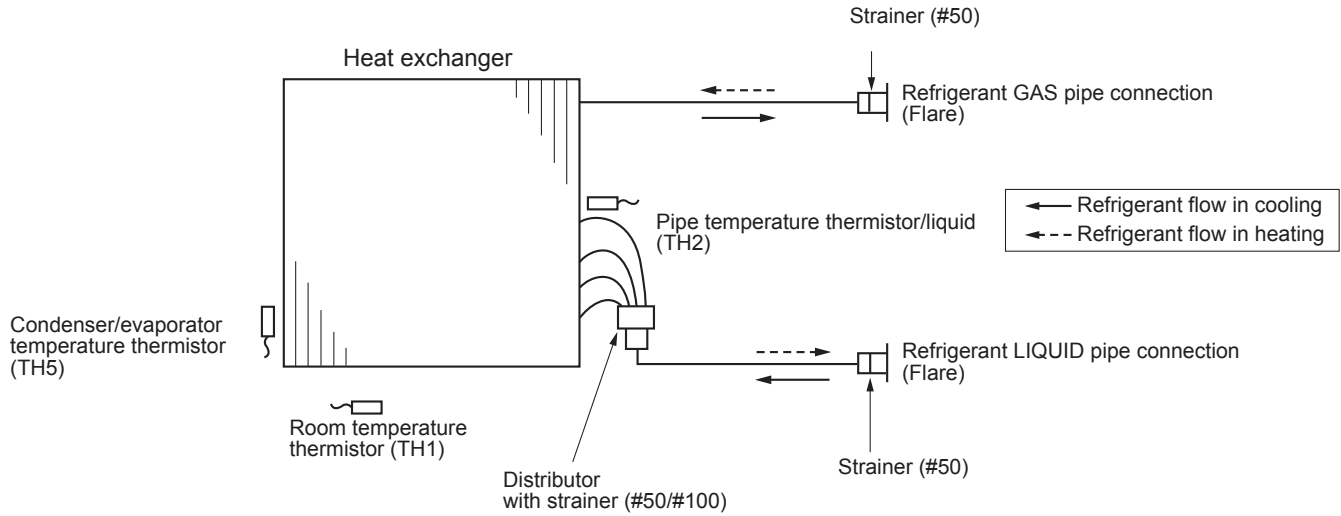

9-1. TROUBLESHOOTING

<Check code displayed by self-diagnosis and actions to be taken for service (summary)>

Present and past check codes are logged, and they can be displayed on the wired remote controller and control board of outdoor unit. Actions to be taken for service, which depends on whether or not the trouble is reoccurring in the field, are summarized in the table below. Check the contents below before investigating details.

Unit conditions at service	Check code	Actions to be taken for service (summary)
The trouble is reoccurring.	Displayed	Judge what is wrong and take a corrective action according to "9-3. SELF-DIAGNOSIS ACTION TABLE".
	Not displayed	Conduct troubleshooting and ascertain the cause of the trouble according to "9-4. TROUBLESHOOTING BY INFERIOR PHENOMENA".
The trouble is not reoccurring.	Logged	<ul style="list-style-type: none"> ① Consider the temporary defects such as the work of protection devices in the refrigerant circuit including compressor, poor connection of wiring, noise, etc. Re-check the symptom, and check the installation environment, refrigerant amount, weather when the trouble occurred, matters related to wiring, etc. ② Reset error code logs and restart the unit after finishing service. ③ There is no abnormality in electrical component, controller board, remote controller, etc.
	Not logged	<ul style="list-style-type: none"> ① Re-check the abnormal symptom. ② Conduct trouble shooting and ascertain the cause of the trouble according to "9-4. TROUBLESHOOTING BY INFERIOR PHENOMENA". ③ Continue to operate unit for the time being if the cause is not ascertained. ④ There is no abnormality concerning of parts such as electrical component, controller board, remote controller, etc.

9-2. MALFUNCTION-DIAGNOSIS METHOD BY REMOTE CONTROLLER

<In case of trouble during operation>



When a malfunction occurs to air conditioner, both indoor unit and outdoor unit will stop and operation lamp blinks to inform unusual stop.

<Malfunction-diagnosis method at maintenance service>

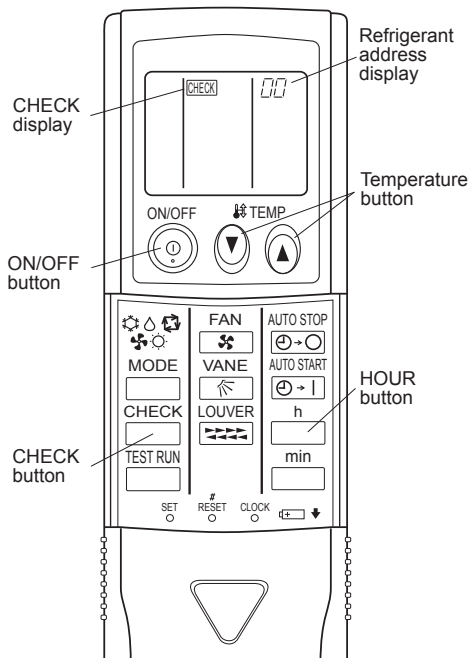
■ IR wireless remote controller



[Procedure]

1. Press the CHECK button twice.
 - "CHECK" lights, and refrigerant address "00" blinks.
 - Check that the remote controller's display has stopped before continuing.
2. Press the TEMP   buttons.
 - Select the refrigerant address of the indoor unit for the self-diagnosis.
 - Note: Set refrigerant address using the outdoor unit's DIP switch (SW1). (For more information, see the outdoor unit installation manual.)
3. Point the remote controller at the sensor on the indoor unit and press the HOUR button.
 - If an air conditioner error occurs, the indoor unit's sensor emits an intermittent buzzer sound, the operation lamp blinks, and the check code is output. (It takes 3 seconds at most for check code to appear.)
4. Point the remote controller at the sensor on the indoor unit and press the ON/OFF button.
 - The check mode is cancelled.

• Refer to the following tables for details on the check codes.

[Output pattern A]

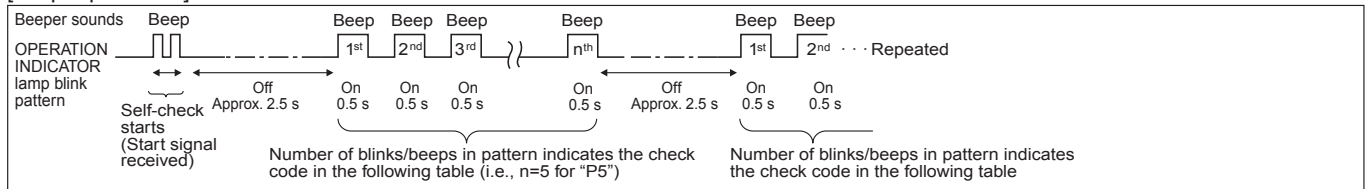

[Output pattern B]

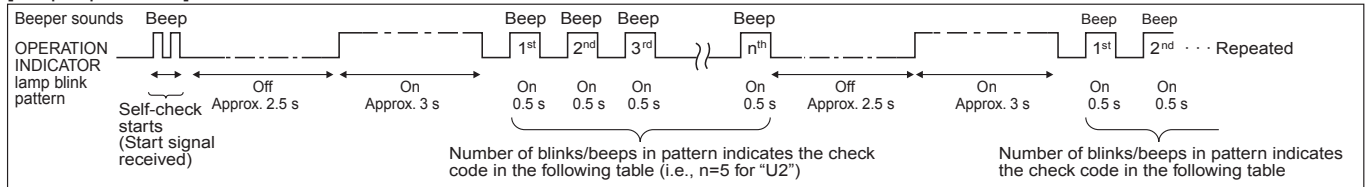

[Output pattern A] Errors detected by indoor unit

IR wireless remote controller		Wired remote controller	
Beeper sounds/OPERATION INDICATOR lamp blinks (Number of times)	① Check code	Symptom	Remark
1	P1	Intake sensor error	
2	P2	Pipe (TH2) sensor error	
	P9	Pipe (TH5) sensor error	
3	E6, E7	Indoor/outdoor unit communication error	
4	P4	Float switch connector (CN4F) open	
5	P5	Drain pump error	
	PA	Forced compressor stop(due to water leakage abnormality)	
6	P6	Freezing/Overheating protection operation	
7	EE	Communication error between indoor and outdoor units	
8	P8	Pipe temperature error	
9	E4, E5	Remote controller signal receiving error	
10	-	-	
11	PB (Pb)	Indoor fan motor error	
12	FB (Fb)	Indoor unit control system error (memory error, etc.)	
14	PL	Abnormality of refrigerant circuit	
-	E0, E3	Remote controller transmission error	
-	E1, E2	Remote controller control board error	

[Output pattern B] Errors detected by unit other than indoor unit (outdoor unit, etc.)

IR wireless remote controller		Wired remote controller	
Beeper sounds/OPERATION INDICATOR lamp blinks (Number of times)	① Check code	Symptom	Remark
1	E9	Indoor/outdoor unit communication error (Transmitting error) (Outdoor unit)	For details, check the LED display of the outdoor controller board. As for outdoor unit, refer to outdoor unit's service manual.
2	UP	Compressor overcurrent interruption	
3	U3, U4	Open/short of outdoor unit thermistors	
4	UF	Compressor overcurrent interruption (When compressor locked)	
5	U2	Abnormal high discharging temperature/49C operated/insufficient refrigerant	
6	U1, Ud	Abnormal high pressure (63H operated)/Overheating protection operation	
7	U5	Abnormal temperature of heatsink	
8	U8	Outdoor unit fan protection stop	
9	U6	Compressor overcurrent interruption/Abnormal of power module	
10	U7	Abnormality of superheat due to low discharge temperature	
11	U9, UH	Abnormality such as overvoltage or undervoltage and abnormal synchronous signal to main circuit/Current sensor error	
12	-	-	
13	-	-	
14	Others	Other errors (Refer to the technical manual for the outdoor unit.)	

Notes:

1. If the beeper does not sound again after the initial 2 beeps to confirm the self-check start signal was received and the OPERATION INDICATOR lamp does not come on, there are no error records.
2. If the beeper sounds 3 times continuously "beep, beep, beep (0.4 + 0.4 + 0.4 seconds)" after the initial 2 beeps to confirm the self-check start signal was received, the specified refrigerant address is incorrect.

- On IR wireless remote controller
The continuous buzzer sounds from receiving section of indoor unit.
Blink of operation lamp
 - On wired remote controller
- ① Check code displayed in the LCD. (Refer to the previous page, ① check code.)

• If the unit cannot be operated properly after the test run, refer to the following table to find out the cause.

Symptom		LED 1, 2 (PCB in outdoor unit)	Cause
Wired remote controller			
PLEASE WAIT	For about 2 minutes after power-on	After LED 1, 2 are lighted, LED 2 is turned off, then only LED 1 is lighted. (Correct operation)	•For about 2 minutes following power-on, operation of the remote controller is not possible due to system start-up. (Correct operation)
PLEASE WAIT → Check code	Subsequent to about 2 minutes after power-on	Only LED 1 is lighted. → LED 1, 2 blink.	•Connector for the outdoor unit's protection device is not connected. •Reverse or open phase wiring for the outdoor unit's power terminal block (L1, L2, GR)
Display messages do not appear even when operation switch is turned ON (operation lamp does not light up).		Only LED 1 is lighted. → LED 1 blinks twice, LED 2 blinks once.	•Incorrect wiring between indoor and outdoor units (incorrect polarity of S1, S2, S3) •Remote controller wire short

On the IR wireless remote controller with condition above, following phenomena take place.

- No signals from the remote controller can be received.
- OPE lamp is blinking.
- The buzzer makes a short ping sound.

Note:

Operation is not possible for about 30 seconds after cancellation of function selection. (Correct operation)

For description of each LED (LED1, 2, 3) provided on the indoor controller, refer to the following table.

LED1 (power for microprocessor)	Indicates whether control power is supplied. Make sure that this LED is always lit.
LED2 (power for wired remote controller)	Indicates whether power is supplied to the wired remote controller. This LED lights only in the case of the indoor unit which is connected to the outdoor unit refrigerant addresses "0".
LED3 (communication between indoor and outdoor units)	Indicates state of communication between the indoor and outdoor units. Make sure that this LED is always blinking.

9-3. SELF-DIAGNOSIS ACTION TABLE

Note:

Errors to be detected in outdoor unit, such as codes starting with F, U or E (excluding E0 to E7), are not covered in this document. Please refer to the outdoor unit service manual for the details.

Check code	Abnormal point and detection method	Cause	Countermeasure
P1	<p>Room temperature thermistor (TH1)</p> <p>① The unit is in 3-minute resume prevention mode if short/open of thermistor is detected. Abnormal if the unit does not reset normally after 3 minutes. (The unit returns to normal operation, if it has been reset normally.)</p> <p>② Constantly detected during cooling, drying, and heating operation. Short: 194°F [90°C] or more Open: -40°F [-40°C] or less</p>	<p>① Defective thermistor characteristics</p> <p>② Contact failure of connector (CN20) on the indoor controller board (Insert failure)</p> <p>③ Breaking of wire or contact failure of thermistor wiring</p> <p>④ Defective indoor controller board</p>	<p>①-③ Check resistance value of thermistor. 32°F [0°C]....15.0 kΩ 50°F [10°C].....9.6 kΩ 68°F [20°C].....6.3 kΩ 86°F [30°C].....4.3 kΩ 104°F [40°C].....3.0 kΩ</p> <p>If you put force on (draw or bend) the lead wire with measuring resistance value of thermistor, breaking of wire or contact failure can be detected.</p> <p>② Check contact failure of connector (CN20) on the indoor controller board. Refer to "9-7. TEST POINT DIAGRAM". Turn the power on again and check restart after inserting connector again.</p> <p>④ Check room temperature display on remote controller. Replace indoor controller board if there is abnormal difference with actual room temperature.</p> <p>Turn the power off, and on again to operate after check.</p>
P2	<p>Pipe temperature thermistor/liquid (TH2)</p> <p>① The unit is in 3-minute resume prevention mode if short/open of thermistor is detected. Abnormal if the unit does not reset normally after 3 minutes. (The unit returns to normal operation, if it has been reset normally.)</p> <p>② Constantly detected during cooling, drying, and heating (except defrosting) operation Short: 194°F [90°C] or more Open: -40°F [-40°C] or less</p> <p>Note: When all of the following conditions are satisfied, the error is not detected: 1) During cooling operation, or for 3 minutes after cooling operation is stopped. 2) Up to 16 minutes from 10 seconds after cooling operation is started. 3) Outside temperature < -22°F [-30°C]</p>	<p>① Defective thermistor characteristics</p> <p>② Contact failure of connector (CN44) on the indoor controller board (Insert failure)</p> <p>③ Breaking of wire or contact failure of thermistor wiring</p> <p>④ Defective refrigerant circuit is causing thermistor temperature of 194°F [90°C] or more, or -40°F [-40°C] or less.</p> <p>⑤ Defective indoor controller board</p>	<p>①-③ Check resistance value of thermistor. For characteristics, refer to (P1) above.</p> <p>② Check contact failure of connector (CN44) on the indoor controller board. Refer to "9-7. TEST POINT DIAGRAM". Turn the power on and check restart after inserting connector again.</p> <p>④ Check pipe <liquid> temperature with remote controller in test run mode. If pipe <liquid> temperature is extremely low (in cooling mode) or high (in heating mode), refrigerant circuit may have defective.</p> <p>⑤ Check pipe <liquid> temperature with remote controller in test run mode. If there is extremely difference with actual pipe <liquid> temperature, replace indoor controller board.</p> <p>Turn the power off, and on again to operate after check.</p>
P4	<p>Contact failure of drain float switch (CN4F)</p> <ul style="list-style-type: none"> Extract when the connector of drain float switch is disconnected. (③ and ④ of connector CN4F is not short-circuited.) Constantly detected during operation 	<p>① Contact failure of connector (Insert failure)</p> <p>② Defective indoor controller board</p>	<p>① Check contact failure of float switch connector. Turn the power on again and check after inserting connector again.</p> <p>② Operate with connector (CN4F) short-circuited. Replace indoor controller board if abnormality reappears.</p>
P5	<p>Drain over flow protection operation</p> <p>① Suspensive abnormality, if drain float switch is detected to be underwater for 1 minute and 30 seconds continuously with drain pump on. Compressor and indoor fan will be turned off.</p> <p>② Drain pump is abnormal if the condition above is detected during suspensive abnormality.</p> <p>③ Constantly detected during drain pump operation</p>	<p>① Malfunction of drain pump</p> <p>② Defective drain Clogged drain pump Clogged drain pipe</p> <p>③ Defective drain float switch Catch of drain float switch or malfunction of moving parts cause drain float switch to be detected under water (Switch On)</p> <p>④ Defective indoor-controller board</p>	<p>① Check if drain-up machine works.</p> <p>② Check drain function.</p> <p>③ Remove drain float switch connector CN4F and check if it is short (Switch On) with the moving part of float switch UP, or OPEN with the moving part of float switch down. Replace float switch if it is short with the moving part of float switch down.</p> <p>④ Replace indoor controller board if it is short-circuited between ③-④ of the drain float switch connector CN4F and abnormality reappears.</p> <p>It is not abnormal if there is no problem about the above-mentioned ①-④. Turn the power off, and on again to operate after check.</p>

Check code	Abnormal point and detection method	Cause	Countermeasure
P6	<p>Freezing/overheating protection is working</p> <p>① Freezing protection (Cooling mode) • In case when outside temperature > -4°F [-20°C] The unit is in 6-minute resume prevention mode if pipe <liquid or condenser/evaporator> temperature stays under -5°F [-15°C] for 3 minutes, 3 minutes after the compressor started. Abnormal if it stays under -5°F [-15°C] for 3 minutes again within 16 minutes after 6-minute resume prevention mode.</p> <p>• In case when outside temperature ≤ -4°F [-20°C] The unit is in 6-minute resume prevention mode if pipe <liquid or condenser/evaporator> temperature stays under -31°F [-35°C] for 3 minutes, 3 minutes after the compressor started. Abnormal if it stays under -31°F [-35°C] for 3 minutes again within 16 minutes after 6-minute resume prevention mode.</p> <p>② Overheating protection (Heating mode) The unit is in 6-minute resume prevention mode if pipe <liquid or condenser/evaporator> temperature is detected as over 158°F [70°C] after the compressor started. Abnormal if the temperature of over 158°F [70°C] is detected again within 30 minutes after 6-minute resume prevention mode.</p>	<p>(Cooling or drying mode)</p> <p>① Clogged filter (reduced airflow) ② Short cycle of air path ③ Low-load (low temperature) operation out of the tolerance range ④ Defective indoor fan motor • Fan motor is defective. • Indoor controller board is defective. ⑤ Defective outdoor fan control ⑥ Overcharge of refrigerant ⑦ Defective refrigerant circuit (clogs)</p> <p>(Heating mode)</p> <p>① Clogged filter (reduced airflow) ② Short cycle of air path ③ Over-load (high temperature) operation out of the tolerance range ④ Defective indoor fan motor • Fan motor is defective. • Indoor controller board is defective. ⑤ Defective outdoor fan control ⑥ Overcharge of refrigerant ⑦ Defective refrigerant circuit (clogs) ⑧ Bypass circuit of outdoor unit is defective.</p>	<p>(Cooling or drying mode)</p> <p>① Check clogs of the filter. ② Remove shields.</p> <p>④ Refer to "9-6. HOW TO CHECK THE PARTS".</p> <p>⑤ Check outdoor fan motor. ⑥⑦ Check operating condition of refrigerant circuit.</p> <p>(Heating mode)</p> <p>① Check clogs of the filter. ② Remove shields.</p> <p>④ Refer to "9-6. HOW TO CHECK THE PARTS".</p> <p>⑤ Check outdoor fan motor. ⑥-⑧ Check operating condition of refrigerant circuit.</p>
P8	<p>Pipe temperature <Cooling mode> Detected as abnormal when the pipe temperature is not in the cooling range 3 minutes after compressor start and 6 minutes after the liquid or condenser/evaporator pipe is out of cooling range. Note 1: It takes at least 9 minutes to detect. Note 2: Abnormality P8 is not detected in drying mode. Cooling range: -5.4°F [-3°C] ≥ (TH-TH1) TH: Lower temperature between liquid pipe temperature (TH2) and condenser/evaporator temperature (TH5) TH1: Intake temperature</p> <p><Heating mode> When 10 seconds have passed after the compressor starts operation and the hot adjustment mode has finished, the unit is detected as abnormal when condenser/evaporator pipe temperature is not in heating range within 20 minutes.</p> <p>Note 3: It takes at least 27 minutes to detect abnormality. Note 4: It excludes the period of defrosting. (Detection restarts when defrosting mode is over.) Heating range: 5.4°F [3°C] ≤ (TH5-TH1)</p>	<p>① Slight temperature difference between indoor room temperature and pipe <liquid or condenser/evaporator> temperature thermistor • Shortage of refrigerant • Disconnected holder of pipe <liquid or condenser/evaporator> thermistor • Defective refrigerant circuit</p> <p>② Converse connection of extension pipe (on plural units connection) ③ Converse wiring of indoor/outdoor unit connecting wire (on plural units connection) ④ Defective detection of indoor room temperature and pipe <condenser/evaporator> temperature thermistor ⑤ Stop valve is not opened completely.</p>	<p>①-④ Check pipe <liquid or condenser/evaporator> temperature with room temperature display on remote controller and outdoor controller circuit board. Pipe <liquid or condenser/evaporator> temperature display is indicated by setting SW2 of outdoor controller circuit board as follows.</p> <p>(Conduct temperature check with outdoor controller circuit board after connecting 'A-Control Service Tool(PAC-SK52ST)').</p> <p>②③ Check converse connection of extension pipe or converse wiring of indoor/outdoor unit connecting wire.</p>

Check code	Abnormal point and detection method	Cause	Countermeasure
P9	<p>Condenser/evaporator temperature thermistor (TH5)</p> <p>① The unit is in 3-minute resume protection mode if short/open of thermistor is detected. Abnormal if the unit does not get back to normal within 3 minutes. (The unit returns to normal operation, if it has been reset normally.)</p> <p>② Constantly detected during cooling, drying, and heating operation (except defrosting) Short: 194°F [90°C] or more Open: -40°F [-40°C] or less</p> <p>Note: When all of the following conditions are satisfied, the error is not detected: 1) During cooling operation, or for 3 minutes after cooling operation is stopped. 2) Up to 16 minutes from 10 seconds after cooling operation is started. 3) Outside temperature < -22°F [-30°C]</p>	<p>① Defective thermistor characteristics</p> <p>② Contact failure of connector (CN44) on the indoor controller board (Insert failure)</p> <p>③ Breaking of wire or contact failure of thermistor wiring</p> <p>④ Temperature of thermistor is 194°F [90°C] or more or -40°F [-40°C] or less caused by defective refrigerant circuit.</p> <p>⑤ Defective indoor controller board</p>	<p>①-③ Check resistance value of thermistor. For characteristics, refer to (P1) above.</p> <p>② Check contact failure of connector (CN44) on the indoor controller board. Refer to "9-7. TEST POINT DIAGRAM". Turn the power on and check restart after inserting connector again.</p> <p>④ Operate in test run mode and check pipe <condenser/evaporator> temperature with outdoor controller circuit board. If pipe <condenser/evaporator> temperature is extremely low (in cooling mode) or high (in heating mode), refrigerant circuit may have defect.</p> <p>⑤ Operate in test run mode and check pipe <condenser/evaporator> temperature with outdoor control circuit board. If there is extreme difference with actual pipe <condenser/evaporator> temperature, replace indoor controller board. There is no abnormality if none of above comes within the unit. Turn the power off and on again to operate.</p> <p>(In case of checking pipe temperature with outdoor controller circuit board, be sure to connect A-control service tool (PAC-SK52ST).)</p>
PA	<p>Forced compressor stop (due to water leakage abnormality)</p> <p>① The unit has a water leakage abnormality when the following conditions, a) and b), are satisfied while the above-mentioned detection is performed.</p> <p>a) The intake temperature subtracted with liquid pipe temperature detects to be less than 14°F [-10°C] for a total of 30 minutes. (When the drain sensor is detected to be NOT soaked in the water, the detection record of a) and b) will be cleared.)</p> <p>b) Drain float switch detects to be in the water for more than 15 minutes.</p> <p>Note: Once the water leakage abnormality is detected, abnormality state will not be released until the main power is reset.</p>	<p>① Drain pump trouble</p> <p>② Drain defective · Drain pump clogging · Drain pipe clogging</p> <p>③ Open circuit of float switch</p> <p>④ Contact failure of float switch connector</p> <p>⑤ Dew condensation on float switch · Drain water descends along lead wire. · Drain water is waving due to filter clogging.</p> <p>⑥ Extension piping connection difference at twin, triple or quadruple system</p> <p>⑦ Miswiring of indoor/outdoor connecting at twin, triple or quadruple system</p> <p>⑧ Room temperature thermistor/ liquid pipe temperature thermistor detection is defective.</p>	<p>① Check the drain pump.</p> <p>② Check whether water can be drained.</p> <p>③ Check the resistance of the float switch.</p> <p>④ Check the connector contact failure.</p> <p>⑤ Check the float switch leadwire mounted. Check the filter clogging.</p> <p>⑥ Check the piping connection.</p> <p>⑦ Check the indoor/outdoor connecting wires.</p> <p>⑧ Check the room temperature display of remote controller. Check the indoor liquid pipe temperature display of outdoor controller board.</p>
PB (Pb)	<p>Fan motor trouble</p>	<p>① Defective fan motor</p> <p>② Defective indoor controller board</p>	<p>①② Refer to "9-6-2. DC fan motor (fan motor/indoor controller circuit board)".</p>
E0 or E4	<p>Remote controller transmission error(E0)/signal receiving error(E4)</p> <p>① Abnormal if main or sub remote controller cannot receive any transmission normally from indoor unit of refrigerant address "0" for 3 minutes. (Check code: E0)</p> <p>② Abnormal if sub remote controller could not receive any signal for 2 minutes. (Check code: E0)</p> <p>① Abnormal if indoor controller board can not receive any data normally from remote controller board or from other indoor controller board for 3 minutes. (Check code: E4)</p> <p>② Indoor controller board cannot receive any signal from remote controller for 2 minutes. (Check code: E4)</p>	<p>① Contact failure at transmission wire of remote controller</p> <p>② All remote controllers are set as "sub" remote controller. In this case, E0 is displayed on remote controller, and E4 is displayed at LED (LED1, LED2) on the outdoor controller circuit board.</p> <p>③ Miswiring of remote controller</p> <p>④ Defective transmitting receiving circuit of remote controller</p> <p>⑤ Defective transmitting receiving circuit of indoor controller board of refrigerant addresses "0".</p> <p>⑥ Noise has entered into the transmission wire of remote controller.</p>	<p>① Check disconnection or looseness of indoor unit or transmission wire of remote controller.</p> <p>② Set one of the remote controllers "main" if there is no problem with the action above.</p> <p>③ Check wiring of remote controller. · Total wiring length: max. 500 m (Do not use cable x 3 or more.) · The number of connecting indoor units: max. 16 units · The number of connecting remote controller: max. 2 units</p> <p>If the cause of trouble is not in above ①-③, ④ Diagnose remote controllers. a) When "RC OK" is displayed, Remote controllers have no problem. Turn the power off, and on again to check. If abnormality generates again, replace indoor controller board. b) When "RC NG" is displayed, Replace remote controller. c) When "RC E3" or "ERC 00-66" is displayed, noise may be causing abnormality.</p> <p>Note: If the unit is not normal after replacing indoor controller board in group control, indoor controller board of address "0" may be abnormal.</p>

Check code	Abnormal point and detection method	Cause	Countermeasure
E3 or E5	<p>Remote controller transmission error(E3)/signal receiving error(E5)</p> <p>① Abnormal if remote controller could not find blank of transmission path for 6 seconds and could not transmit. (Check code: E3)</p> <p>② Remote controller receives transmitted data at the same time and compares the received and transmitted data. Abnormal if these data are judged to be different 30 continuous times. (Check code: E3)</p> <p>① Abnormal if indoor controller board could not find blank of transmission path. (Check code: E5)</p> <p>② Indoor controller board receives transmitted data at the same time and compares the received and transmitted data. Abnormal if these data are judged to be different 30 continuous times. (Check code: E5)</p>	<p>① 2 remote controllers are set as "main." (In case of 2 remote controllers)</p> <p>② Remote controller is connected with 2 indoor units or more.</p> <p>③ Repetition of refrigerant address</p> <p>④ Defective transmitting receiving circuit of remote controller</p> <p>⑤ Defective transmitting receiving circuit of indoor controller board</p> <p>⑥ Noise has entered into transmission wire of remote controller.</p>	<p>① Set a remote controller to main, and the other to sub.</p> <p>② Remote controller is connected with only one indoor unit.</p> <p>③ The address changes to a separate setting.</p> <p>④–⑥ Diagnose remote controller.</p> <p>a) When "RC OK" is displayed, remote controllers have no problem. Turn the power off, and on again to check.</p> <p>When becoming abnormal again, replace indoor controller board.</p> <p>b) When "RC NG" is displayed, replace remote controller.</p> <p>c) When "RC E3" or "ERC 00-66" is displayed, noise may be causing abnormality.</p>
E6	<p>Indoor/outdoor unit communication error (Signal receiving error)</p> <p>① Abnormal if indoor controller board cannot receive any signal normally for 6 minutes after turning the power on.</p> <p>② Abnormal if indoor controller board cannot receive any signal normally for 3 minutes.</p> <p>③ Consider the unit abnormal under the following condition: When 2 or more indoor units are connected to an outdoor unit, indoor controller board cannot receive a signal for 3 minutes from outdoor controller circuit board, a signal which allows outdoor controller circuit board to transmit signals.</p>	<p>① Contact failure, short circuit or, miswiring (converse wiring) of indoor/outdoor unit connecting wire</p> <p>② Defective transmitting receiving circuit of indoor controller board</p> <p>③ Defective transmitting receiving circuit of indoor controller board</p> <p>④ Noise has entered into indoor/outdoor unit connecting wire.</p>	<p>Check LED display on the outdoor control circuit board. (Connect A-control service tool, PAC-SK52ST.) Refer to outdoor unit service manual.</p> <p>① Check disconnection or looseness of indoor/ outdoor unit connecting wire of indoor unit or outdoor unit. Check all the units in case of twin triple indoor unit system.</p> <p>②–④ Turn the power off, and on again to check. If abnormality generates again, replace indoor controller board or outdoor controller circuit board.</p> <p>Note: Other indoor controller board may have defect in the case of twin triple indoor unit system.</p>
E7	<p>Indoor/outdoor unit communication error (Transmitting error)</p> <p>Abnormal if "1" receiving is detected 30 times continuously though indoor controller board has transmitted "0".</p>	<p>① Defective transmitting receiving circuit of indoor controller board</p> <p>② Noise has entered into power supply.</p> <p>③ Noise has entered into outdoor control wire.</p>	<p>①–③ Turn the power off, and on again to check. If abnormality generates again, replace indoor controller board.</p>
FB (Fb)	<p>Indoor controller board</p> <p>Abnormal if data cannot be read normally from the nonvolatile memory of the indoor controller board.</p>	<p>① Defective indoor controller board</p>	<p>① Replace indoor controller board.</p>
E1 or E2	<p>Remote controller control board</p> <p>① Abnormal if data cannot be read normally from the nonvolatile memory of the remote controller control board. (Check code: E1)</p> <p>② Abnormal if the clock function of remote controller cannot be operated normally. (Check code: E2)</p>	<p>① Defective remote controller</p>	<p>① Replace remote controller.</p>
PL	<p>Abnormal refrigerant circuit</p> <p>During Cooling, Dry, or Auto Cooling operation, the following conditions are regarded as failures when detected for 1 second.</p> <p>a)The compressor continues to run for 30 or more seconds.</p> <p>b)The liquid pipe temperature or the condenser/evaporator temperature is 167°F [75°C] or more.</p> <p><u>These detected errors will not be cancelled until the power source is reset.</u></p>	<p>① Abnormal operation of 4-way valve</p> <p>② Disconnection of or leakage in refrigerant pipes</p> <p>③ Air into refrigerant piping</p> <p>④ Abnormal operation (no rotation) of indoor fan</p> <ul style="list-style-type: none"> · Defective fan motor · Defective indoor control board <p>⑤ Defective refrigerant circuit (clogging)</p>	<p>① <u>When this error occurs, be sure to replace the 4-way valve.</u></p> <p>② Check refrigerant pipes for disconnection or leakage.</p> <p>③ After the recovery of refrigerant, vacuum dry the whole refrigerant circuit.</p> <p>④ Refer to "9-6-2. DC fan motor (fan motor/ indoor controller circuit board)".</p> <p>⑤ Check refrigerant circuit for operation.</p> <p><u>To avoid entry of moisture or air into refrigerant circuit which could cause abnormal high pressure, purge air in refrigerant circuit or replace refrigerant.</u></p>

9-4. TROUBLESHOOTING BY INFERIOR PHENOMENA

Note: Refer to the manual of outdoor unit for the detail of remote controller.

Phenomena	Cause	Countermeasure
(1) Upward/downward vane performance failure	<ul style="list-style-type: none"> ① The vane is not downward during defrosting and heat preparation and when the thermostat is OFF in HEAT mode. (Working of COOL protection function) ② Vane motor does not rotate. <ul style="list-style-type: none"> • Defective vane motor • Breaking of wire or connection failure of connector ③ Upward/downward vane does not work. <ul style="list-style-type: none"> • The vane is set to fixed position. 	<ul style="list-style-type: none"> ① Normal operation (The vane is set to horizontal regardless of remote control.) ② Check ② (left). <ul style="list-style-type: none"> • Check the vane motor. (Refer to "9-6. HOW TO CHECK THE PARTS".) • Check for breaking of wire or connection failure of connector. ③ Normal operation (Each connector on vane motor side is disconnected or setting the fixed vanes by wired remote controller.)
(2) Receiver for IR wireless remote controller	<ul style="list-style-type: none"> ① Weak batteries of IR wireless remote controller ② Contact failure of connector (CNB) on IR wireless remote controller board (Insert failure) ③ Contact failure of connector (CN90) on indoor controller board (Insert failure) ④ Contact failure of connector between IR wireless remote controller board and indoor controller board 	<ul style="list-style-type: none"> ① Replace batteries of IR wireless remote controller. ②-④ Check contact failure of each connector. If no problems are found of connector, replace indoor controller board. When the same trouble occurs even if indoor controller board is replaced, replace IR wireless remote controller board.

9-5. EMERGENCY OPERATION

9-5-1. When IR wireless remote controller fails or its battery is exhausted

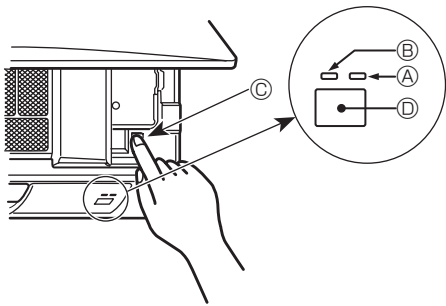

When the remote controller cannot be used

When the batteries of the remote controller run out or the remote controller malfunctions, the emergency operation can be done using the emergency buttons.

- Ⓐ DEFROST/STAND BY lamp (ORANGE)
- Ⓑ Operation lamp (GREEN)
- Ⓒ Emergency operation switch (cooling/heating)
- Ⓓ Receiver

- Each press of the emergency operation switch will toggle the operation mode.
- Check "COOL/HEAT" with the operation monitor display. (The display will appear orange for 5 seconds after pressing the emergency operation switch.)

[Heat pump type]



[Cooling Only type]



Operation Monitor Display

	GREEN	ORANGE	
STOP	○	○	The orange lamp follows the switch operation as indicated at the left for 5 seconds, and then it will return to the normal display.
COOL	●	○	
HEAT	●	●	

○ OFF ● ON

Details of emergency mode are as shown below.

Operation Mode	COOL	HEAT
Set Temperature	75°F [24°C]	75°F [24°C]
Fan Speed	High	High
Airflow Direction Up and Down	Horizontal	Downward

9-5-2. When wired remote controller or indoor unit microprocessor fails

1. When the wired remote control or the indoor unit microcomputer has failed, but all other components work properly, if you set the switch (SWE) on the indoor controller board ON, the indoor unit will begin Emergency Operation.

When Emergency Operation is activated, the indoor unit operates as follows:

- (1) Indoor fan is running at high speed.

Note on the IR wireless remote control:

When the remote control does not function, it is possible to activate Emergency Operation by using the indoor unit Emergency Operation switch.

However, if the indoor unit microprocessor has failed, it is necessary to proceed with points 2 and 3 below as in the case of the wired remote control.

2. When you activate Emergency Operation of the cooling or heating, you have to set the switch (SWE) on the indoor controller board and activate Emergency Operation of the outdoor unit.

For details on how to activate Emergency Operation of the outdoor unit, refer to the outdoor unit wiring diagram.

3. Before you activate Emergency Operation, check the following points:

- (1) Emergency operation cannot be activated when:

- the outdoor unit malfunctions.
- the indoor fan malfunctions.
- when it has detected the malfunction of drain pump during self-diagnosing.

- (2) Emergency Operation becomes continuous only by switching the power source on/off.

ON/OFF on the remote control or temperature control etc. does not function.

- (3) Avoid operating for a long time when the outdoor unit begins defrosting while Emergency Operation of the heating is activated, because it will start to blow cold air.

- (4) Emergency cooling should be limited to 10 hours maximum (The indoor unit heat exchanger may freeze).

- (5) After Emergency Operation has been deactivated, set the switches etc. to their original positions.

- (6) Movement of the vanes does not work in Emergency Operation, therefore you have to slowly set them manually to the appropriate position.

9-6. HOW TO CHECK THE PARTS

PKA-A24KA7.TH PKA-A30KA7H.TH PKA-A36KA7.TH

Parts name	Check points														
Room temperature thermistor (TH1) Pipe temperature thermistor/liquid (TH2) Condenser/evaporator temperature thermistor (TH5)	<p>Disconnect the connector then measure the resistance using a tester. (At the ambient temperature 50 to 86°F [10 to 30°C])</p> <table border="1"> <thead> <tr> <th>Normal</th> <th>Abnormal</th> </tr> </thead> <tbody> <tr> <td>4.3 to 9.6 kΩ</td> <td>Open or short</td> </tr> </tbody> </table> <p>Refer to "9-6-1. Thermistor".</p>	Normal	Abnormal	4.3 to 9.6 kΩ	Open or short										
Normal	Abnormal														
4.3 to 9.6 kΩ	Open or short														
Vane motor (MV)	<p>Measure the resistance between the terminals using a tester. (Coil temperature 68°F)</p> <table border="1"> <thead> <tr> <th colspan="4">Normal</th> <th>Abnormal</th> </tr> </thead> <tbody> <tr> <td>①-② Brown-Red</td> <td>①-③ Brown-Orange</td> <td>①-④ Brown-Yellow</td> <td>①-⑤ Brown-Green</td> <td rowspan="2">Open or short</td> </tr> <tr> <td colspan="4">250 Ω ± 7%</td> </tr> </tbody> </table>	Normal				Abnormal	①-② Brown-Red	①-③ Brown-Orange	①-④ Brown-Yellow	①-⑤ Brown-Green	Open or short	250 Ω ± 7%			
Normal				Abnormal											
①-② Brown-Red	①-③ Brown-Orange	①-④ Brown-Yellow	①-⑤ Brown-Green	Open or short											
250 Ω ± 7%															
Fan motor (MF)	Refer to "9-6-2. DC Fan Motor (fan motor/indoor controller circuit board)".														

9-6-1. Thermistor

<Thermistor characteristic graph>

Thermistor for lower temperature

Room temperature thermistor (TH1)
Pipe temperature thermistor/liquid (TH2)
Condenser/evaporator temperature thermistor (TH5)

Thermistor $R_0=15 \text{ k}\Omega \pm 3\%$
Fixed number of $B=3480 \pm 2\%$

$$t(^{\circ}\text{C})R_t=15\exp \left\{ 3480 \left(\frac{1}{273+t} - \frac{1}{273} \right) \right\}$$

$$T(^{\circ}\text{F})R_t=15\exp \left\{ 3480 \left(\frac{1}{273+\frac{T-32}{1.8}} - \frac{1}{273} \right) \right\}$$

32°F [0°C]	15 kΩ
50°F [10°C]	9.6 kΩ
68°F [20°C]	6.3 kΩ
77°F [25°C]	5.4 kΩ
86°F [30°C]	4.3 kΩ
104°F [40°C]	3.0 kΩ

<Thermistor for lower temperature>

Temperature (°C)	Temperature (°F)	Resistance (kΩ)
-20	-4	45
-10	14	35
0	32	25
10	50	18
20	68	12
30	86	8
40	104	6
50	122	4.3

9-6-2. DC Fan Motor (fan motor/indoor controller circuit board)

Check method of DC fan motor (fan motor/indoor controller circuit board)

① Notes

- High voltage is applied to the connector (CNMF) for the fan motor. Pay attention to the service.
- Do not pull out the connector (CNMF) for the motor with the power supply on.
(It causes trouble of the indoor controller circuit board and fan motor.)

② Self check

Symptom : The indoor fan cannot rotate.

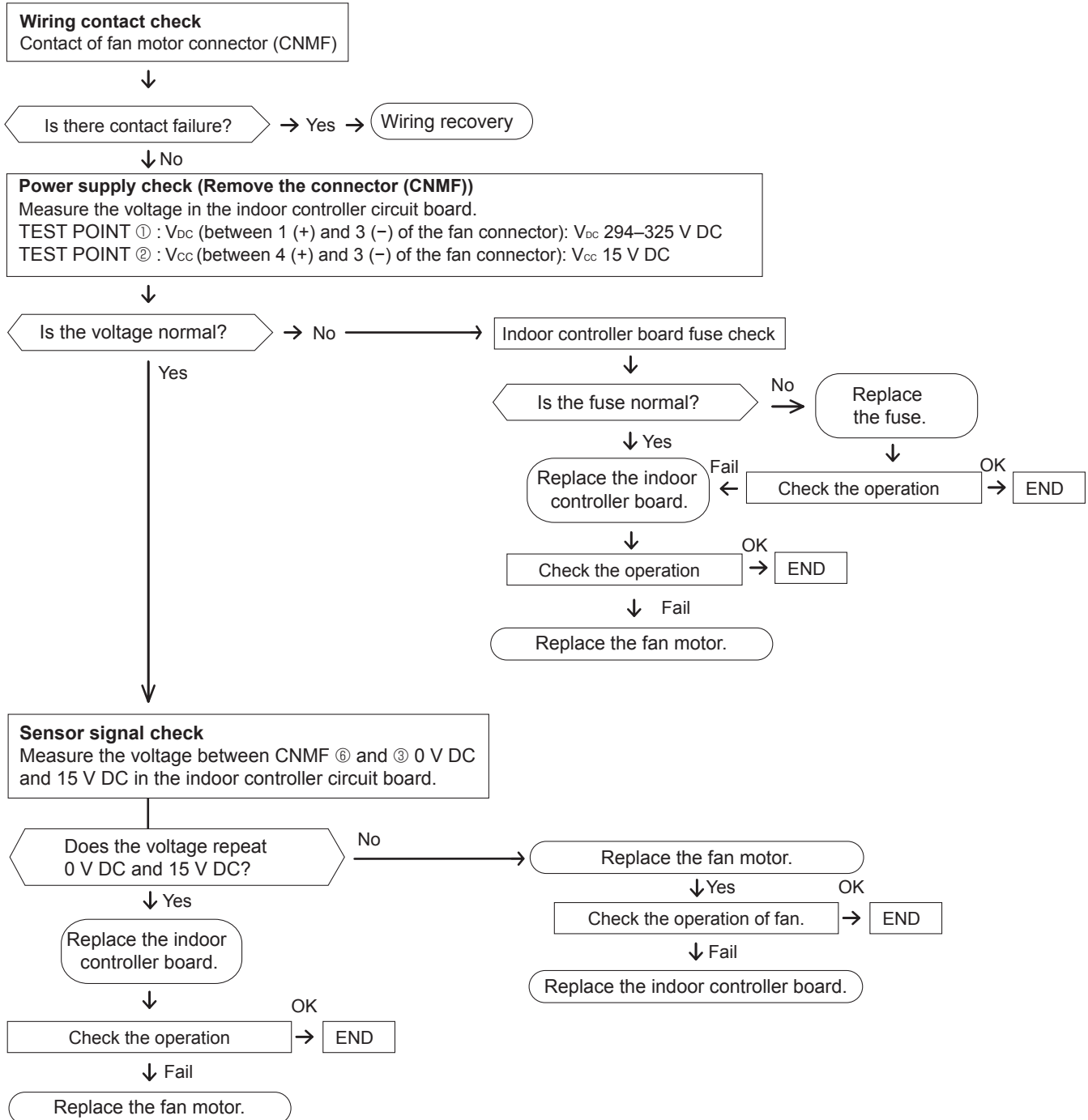

9-8. FUNCTIONS OF DIP SWITCH AND JUMPER WIRE

Each function is controlled by the DIP switch and the jumper wire on indoor controller board.

PKA-A24KA7.TH PKA-A30KA7.TH PKA-A36KA7.TH

The black square (■) indicates a switch position.

Jumper wire	Functions	Setting by the DIP switch and jumper wire	Remarks																																												
SW1	Model settings	<table border="1"> <thead> <tr> <th>MODEL</th> <th>SETTING</th> </tr> </thead> <tbody> <tr> <td>PKA-A-KA7</td> <td> <table border="1"> <tr> <td>1</td><td>2</td><td>3</td><td>4</td><td>5</td> <td>ON</td> </tr> <tr> <td>■</td><td>■</td><td>■</td><td>■</td><td>■</td> <td>OFF</td> </tr> </table> </td> </tr> </tbody> </table>	MODEL	SETTING	PKA-A-KA7	<table border="1"> <tr> <td>1</td><td>2</td><td>3</td><td>4</td><td>5</td> <td>ON</td> </tr> <tr> <td>■</td><td>■</td><td>■</td><td>■</td><td>■</td> <td>OFF</td> </tr> </table>	1	2	3	4	5	ON	■	■	■	■	■	OFF																													
MODEL	SETTING																																														
PKA-A-KA7	<table border="1"> <tr> <td>1</td><td>2</td><td>3</td><td>4</td><td>5</td> <td>ON</td> </tr> <tr> <td>■</td><td>■</td><td>■</td><td>■</td><td>■</td> <td>OFF</td> </tr> </table>	1	2	3	4	5	ON	■	■	■	■	■	OFF																																		
1	2	3	4	5	ON																																										
■	■	■	■	■	OFF																																										
SW2	Capacity settings	<table border="1"> <thead> <tr> <th>MODEL</th> <th>SETTING</th> </tr> </thead> <tbody> <tr> <td>PKA-A24KA7</td> <td> <table border="1"> <tr> <td>1</td><td>2</td><td>3</td><td>4</td><td>5</td> <td>ON</td> </tr> <tr> <td>■</td><td>■</td><td>■</td><td>■</td><td>■</td> <td>OFF</td> </tr> </table> </td> </tr> <tr> <td>PKA-A30KA7</td> <td> <table border="1"> <tr> <td>1</td><td>2</td><td>3</td><td>4</td><td>5</td> <td>ON</td> </tr> <tr> <td>■</td><td>■</td><td>■</td><td>■</td><td>■</td> <td>OFF</td> </tr> </table> </td> </tr> <tr> <td>PKA-A36KA7</td> <td> <table border="1"> <tr> <td>1</td><td>2</td><td>3</td><td>4</td><td>5</td> <td>ON</td> </tr> <tr> <td>■</td><td>■</td><td>■</td><td>■</td><td>■</td> <td>OFF</td> </tr> </table> </td> </tr> </tbody> </table>	MODEL	SETTING	PKA-A24KA7	<table border="1"> <tr> <td>1</td><td>2</td><td>3</td><td>4</td><td>5</td> <td>ON</td> </tr> <tr> <td>■</td><td>■</td><td>■</td><td>■</td><td>■</td> <td>OFF</td> </tr> </table>	1	2	3	4	5	ON	■	■	■	■	■	OFF	PKA-A30KA7	<table border="1"> <tr> <td>1</td><td>2</td><td>3</td><td>4</td><td>5</td> <td>ON</td> </tr> <tr> <td>■</td><td>■</td><td>■</td><td>■</td><td>■</td> <td>OFF</td> </tr> </table>	1	2	3	4	5	ON	■	■	■	■	■	OFF	PKA-A36KA7	<table border="1"> <tr> <td>1</td><td>2</td><td>3</td><td>4</td><td>5</td> <td>ON</td> </tr> <tr> <td>■</td><td>■</td><td>■</td><td>■</td><td>■</td> <td>OFF</td> </tr> </table>	1	2	3	4	5	ON	■	■	■	■	■	OFF	
MODEL	SETTING																																														
PKA-A24KA7	<table border="1"> <tr> <td>1</td><td>2</td><td>3</td><td>4</td><td>5</td> <td>ON</td> </tr> <tr> <td>■</td><td>■</td><td>■</td><td>■</td><td>■</td> <td>OFF</td> </tr> </table>	1	2	3	4	5	ON	■	■	■	■	■	OFF																																		
1	2	3	4	5	ON																																										
■	■	■	■	■	OFF																																										
PKA-A30KA7	<table border="1"> <tr> <td>1</td><td>2</td><td>3</td><td>4</td><td>5</td> <td>ON</td> </tr> <tr> <td>■</td><td>■</td><td>■</td><td>■</td><td>■</td> <td>OFF</td> </tr> </table>	1	2	3	4	5	ON	■	■	■	■	■	OFF																																		
1	2	3	4	5	ON																																										
■	■	■	■	■	OFF																																										
PKA-A36KA7	<table border="1"> <tr> <td>1</td><td>2</td><td>3</td><td>4</td><td>5</td> <td>ON</td> </tr> <tr> <td>■</td><td>■</td><td>■</td><td>■</td><td>■</td> <td>OFF</td> </tr> </table>	1	2	3	4	5	ON	■	■	■	■	■	OFF																																		
1	2	3	4	5	ON																																										
■	■	■	■	■	OFF																																										
J41 J42	Pair number setting with wireless remote controller	<table border="1"> <thead> <tr> <th rowspan="2">Wireless remote controller setting</th> <th colspan="2">Control PCB setting</th> </tr> <tr> <th>J41</th> <th>J42</th> </tr> </thead> <tbody> <tr> <td>0</td> <td>○</td> <td>○</td> </tr> <tr> <td>1</td> <td>×</td> <td>○</td> </tr> <tr> <td>2</td> <td>○</td> <td>×</td> </tr> <tr> <td>3-9</td> <td>×</td> <td>×</td> </tr> </tbody> </table> <p>Jumper wire (○: Short ×: Open)</p>	Wireless remote controller setting	Control PCB setting		J41	J42	0	○	○	1	×	○	2	○	×	3-9	×	×	<p><Initial setting> Wireless remote controller: 0 Control PCB: ○ (for both J41 and J42) 4 pair number settings are supported. The pair number settings of the wireless remote controller and indoor control PCB (J41/J42) are given in the table on the left. ('×' in the table indicates the jumper wire is disconnected.)</p>																											
Wireless remote controller setting	Control PCB setting																																														
	J41	J42																																													
0	○	○																																													
1	×	○																																													
2	○	×																																													
3-9	×	×																																													
JP3	Indoor controller board type setting	<table border="1"> <thead> <tr> <th>Indoor controller board type</th> <th>JP3</th> </tr> </thead> <tbody> <tr> <td>For product</td> <td>○</td> </tr> <tr> <td>Spare parts</td> <td>○</td> </tr> </tbody> </table>	Indoor controller board type	JP3	For product	○	Spare parts	○	<p>○ : With JP3 × : Without JP3</p>																																						
Indoor controller board type	JP3																																														
For product	○																																														
Spare parts	○																																														

10-1. UNIT FUNCTION SETTING BY THE REMOTE CONTROLLER

Each function can be set as necessary using the remote controller. The setting of function for each unit can only be done by the remote controller.

(1) Functions available when setting the unit number to 00
Refer to the service manual that comes with each outdoor unit.

(2) Functions available when setting the unit number to 01–03 or AL (07 in case of wireless remote controller)

Function	Settings	Mode No.	Setting No.	Initial setting	Setting
Filter sign	100 Hr	07	1	○	
	2500 Hr		2		
	No filter sign indicator		3		
Fan speed	Silent	08	1	-	
	Standard		2	○	
	High ceiling		3	-	

11-1. Rotation Function (and back-up function, 2nd stage cut-in function)

This function is only available when using wired remote controller.

11-1-1. Operation

(1) Rotation function (and Back-up function)

• Outline of functions

- Main and sub units operate alternately according to the interval of rotation setting.
 Note: Main and sub unit should be set by refrigerant address. (Outdoor DIP switch setting)
 Refrigerant address "00" → Main unit
 Refrigerant address "01" → Sub unit
- When error occurs to one unit, another unit will start operation. (Back-up function)

• System constraint

- This function is available only by the grouping control system (INDOOR UNIT: OUTDOOR UNIT=1:1) of 2 refrigerant groups. (Refer to Fig. 1)
- Main indoor unit should be connected for wired remote controller and the transmission line (TB5) for main and sub unit should also be connected. (Refer to Fig. 1)
 (This function cannot be set by wireless remote controller.)
- Set refrigerant address of each unit. (DIP switch on the outdoor unit ... Refrigerant address 00/01)

Operation pattern

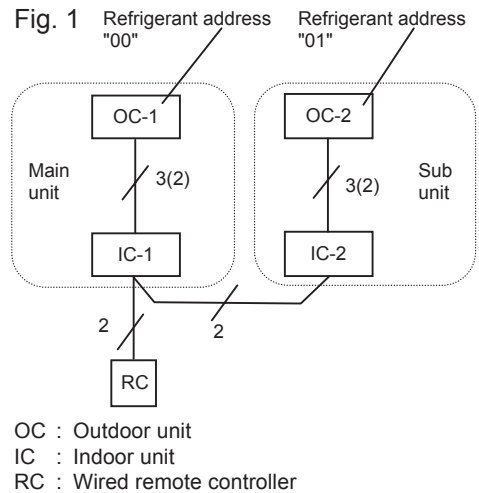
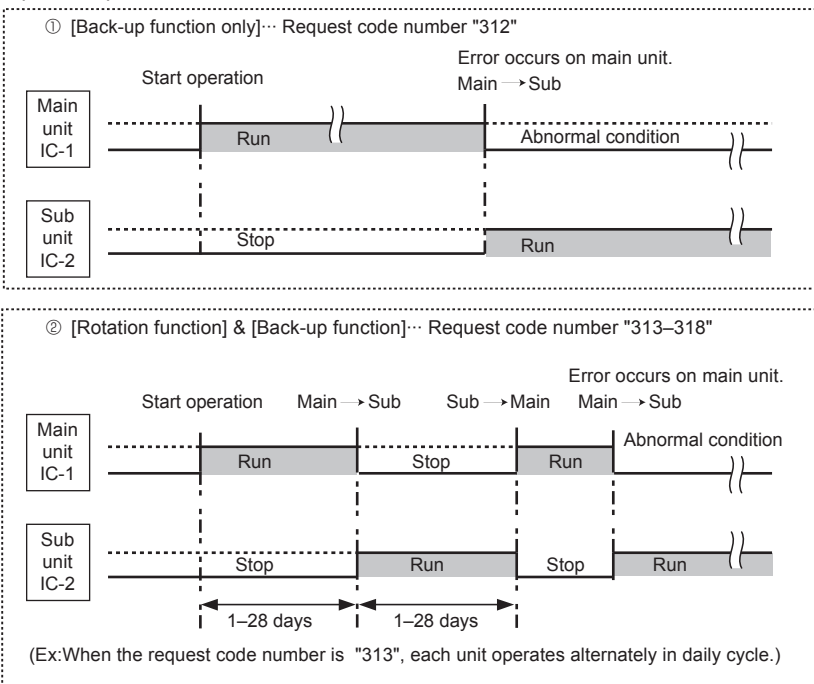

- Note:
- When the unit is restarted to operate after turning off the power or OFF operation, the unit which was operating will start operation.
 - To operate the main unit, refer to "11-1-2. How to set rotation function (Back-up function, 2nd stage cut-in function)", and set the request code No. which is not the same as the current one, and set again the former request code No.

(2) 2nd stage cut-in function

• Outline of functions

- When the 1st unit can NOT supply with sufficient capacity for exceptionally high-demand conditions and the actual room temperature reaches set point *, the 2nd unit starts operation in conjunction with the 1st unit.
- Once the actual room temperature goes down to 7.2°F [4°C] below set point*, the 2nd unit stops operation automatically.
 (* set point = set temperature by R/C (remote controller) + 7.2, 10.8, 14.4°F [4, 6, 8°C] (selectable))
- Number of operating units is determined according to the room temperature and set point.
- When room temperature becomes higher than set point, standby unit starts. (2 units operation)
- When room temperature falls below set point -7.2°F [-4°C], standby unit stops. (1 unit operation)

• **System constraint**

- This function is available only in cooling mode.

Ex.) Set temp. by R/C = 68°F [20°C]
 Set point = 79°F [26°C]
 When request code number is "323".

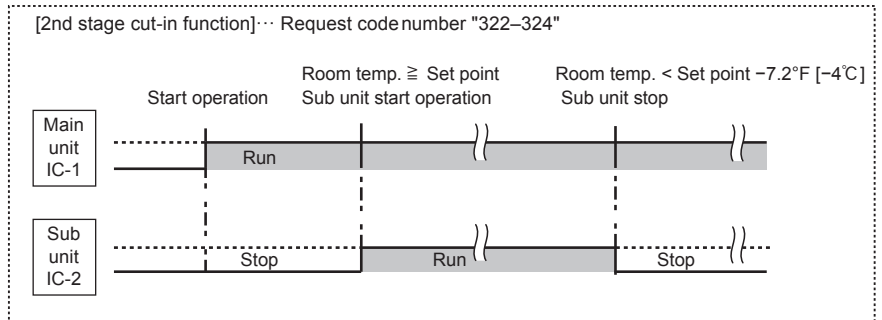
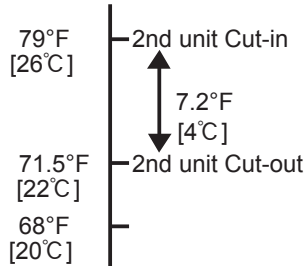

11-1-2. How to set rotation function (Back-up function, 2nd stage cut-in function)

You can set these functions by wired remote controller. (Maintenance monitor)

NOTE

Both main and sub unit should be set in same setting.
 Every time replacing indoor controller board for servicing, the function should be set again.

(1) Request Code List

Rotation setting

Setting No. (Request code)	Setting contents	Initial setting
No.1 (310)	Monitoring the request code of current setting	
No.2 (311)	Rotation and Back-up OFF (Normal group control operation)	⊙
No.3 (312)	Back-up function only	
No.4 (313)	Rotation ON (Alternating interval = 1 day) and back up function	
No.5 (314)	Rotation ON (Alternating interval = 3 day) and back up function	
No.6 (315)	Rotation ON (Alternating interval = 5 day) and back up function	
No.7 (316)	Rotation ON (Alternating interval = 7 day) and back up function	
No.8 (317)	Rotation ON (Alternating interval = 14 day) and back up function	
No.9 (318)	Rotation ON (Alternating interval = 28 day) and back up function	

2nd stage cut-in setting

Setting No. (Request code)	Setting contents	Initial setting
No.1 (320)	Monitoring the request code of current setting	
No.2 (321)	Cut-in function OFF	⊙
No.3 (322)	Cut-in Function ON (Set point = Set temp.+ 7.2°F [4°C])	
No.4 (323)	Cut-in Function ON (Set point = Set temp.+ 10.8°F [6°C])	
No.5 (324)	Cut-in Function ON (Set point = Set temp.+ 14.4°F [8°C])	

(2) Rotation and back up operation

PAR-3xMAA ("x" represents 0 or later)

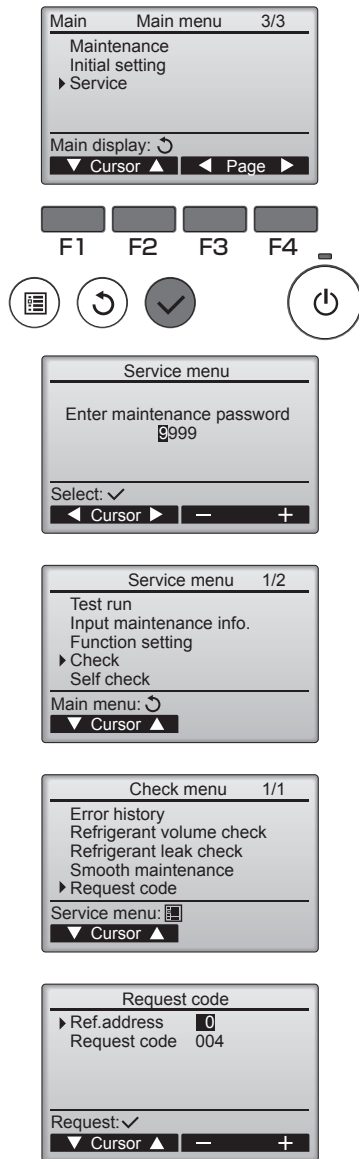

① Press the button.

② Select "Service" with the [Cursor] buttons (and) or the [Page] buttons (and), and press the button.

③ Enter the current maintenance password (4 numerical digits).
• Move cursor to the digit you want to change with the or button.
• Set each number (0 through 9) with the or button.
(Note: The initial maintenance password is "9999".)

④ Then, press the button.

⑤ Select "Check" with the or button, and press the button.

⑥ Select "Request code" with the or button, and press the button.

⑦ Set the Refrigerant address and Request code.
• Select the item to be changed with the or button.
• Select the required setting with the or button.

⑧ Press the or button to set the Refrigerant address "0".

⑨ Press the or button to set the desired request code No.

- Rotation & Back up operation: Enter one request code from 311–318.
- 2nd stage cut-in operation: Enter one request code from 321–324.

⑩ Press the button. Data will be collected and displayed.

⑪ Press the or button to set the Refrigerant address "1".
Set above ⑨–⑩.

⑫ To return to the Main menu, press the button.

11-2. BACK-UP HEATING FUNCTION

11-2-1. Operation

The back-up heater turns ON when both of the following conditions have been satisfied:

A) When the room temperature has not risen after the heater ON delay time has passed.

Note: The heater ON delay time starts when the condition of “set temperature – room temperature > 1°F [0.5°C]” has been satisfied.

B) Set temperature – room temperature \geq 3°F [1.5°C]

The back-up heater turns OFF when the following condition has been satisfied:

• Set temperature – room temperature \geq 1°F [0.5°C]

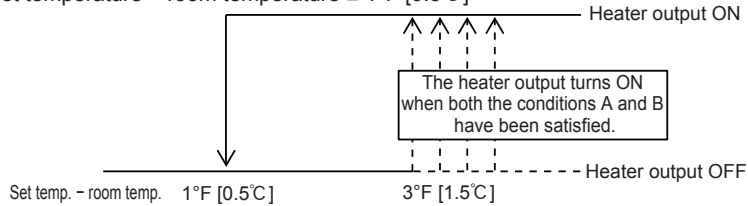

11-2-2. How to change the heater ON delay time

You can set these function by wired remote controller.

Note that the change can be made only by the wired remote controller PAR-32MAA.

Notes:

1. Both main and sub unit should be set in the same setting.
2. Every time replacing indoor controller board for serving, the function should be set again.
3. Stop the air-conditioner operation before changing the heater ON delay time.

Request code list

Setting No. (Request code)	Setting contents	Initial setting
No.1 (390)	Monitoring the request code of current setting	
No.2 (391)	10 minutes	
No.3 (392)	15 minutes	
No.4 (393)	20 minutes	○
No.5 (394)	25 minutes	

11-2-3. How to connect

When connecting to the connector CN152 of the indoor unit, use [PAC-SE59RA-E](#) (optional parts).

Note: For a twin indoor unit system, connect to the CN152 of the indoor unit that the remote controller is connected to.

PKA-A24KA7.TH PKA-A30KA7.TH PKA-A36KA7.TH

Be careful when removing heavy parts.

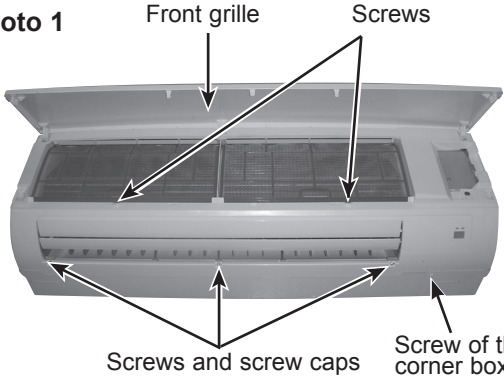
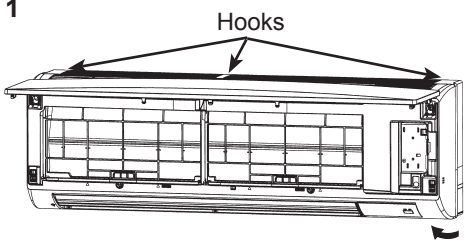
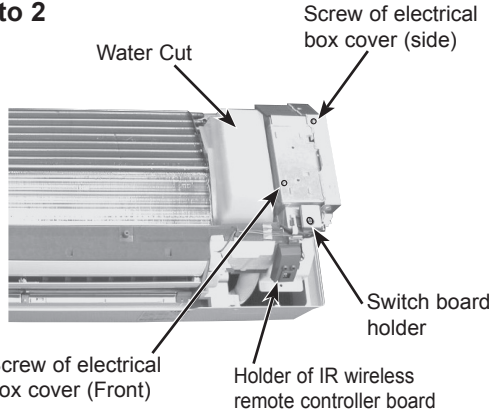
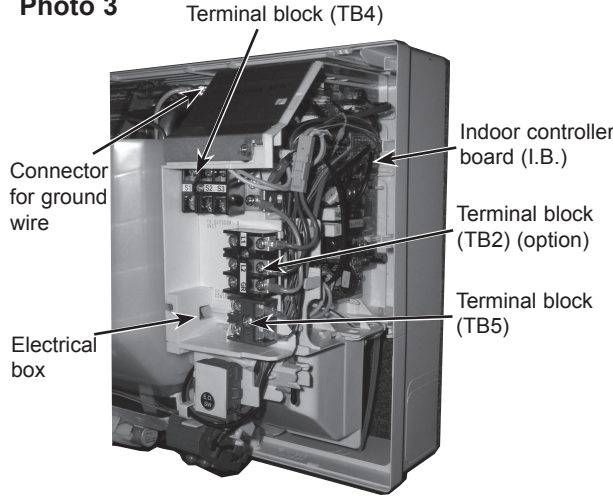
OPERATION PROCEDURE	PHOTOS & ILLUSTRATIONS
<p>1. Removing the panel</p> <ol style="list-style-type: none"> (1) Press and unlock the knobs on both sides of the front grille and lift the front grille until it is level. Pull the hinges forward to remove the front grille. (See Photo 1) (2) Remove 3 screw caps of the panel. Remove 5 screws. (See Photo 1) (3) Unfix 3 hooks. (See Figure 1) (4) Hold the lower part of both ends of the panel and pull it slightly toward you, and then remove the panel by pushing it upward. (5) Remove the screw of the corner box. (See Photo 1) Remove the corner box. 	<p>Photo 1</p>  <p>Figure 1</p> 
<p>2. Removing the indoor controller board and the wireless controller board</p> <ol style="list-style-type: none"> (1) Remove the panel and the corner box. (Refer to step 1) (2) Remove the front and side electrical box covers (each 1 screw). (See Photo 2) (3) Disconnect the connectors on the indoor controller board. (See Photo 3) (4) Remove the switch board holder and open the cover. (5) Pull out the indoor controller board toward you then remove the indoor controller board and switch board. (See Photo 3) (6) Remove the holder of IR wireless remote controller board. (7) Disconnect the connector of IR wireless remote controller board and remove the IR wireless remote controller board from the holder. 	<p>Photo 2</p>  <p>Photo 3</p> 

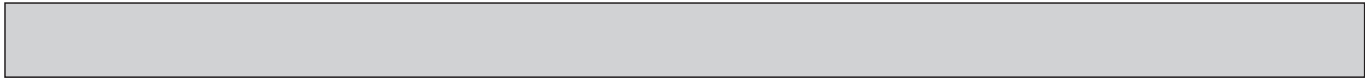

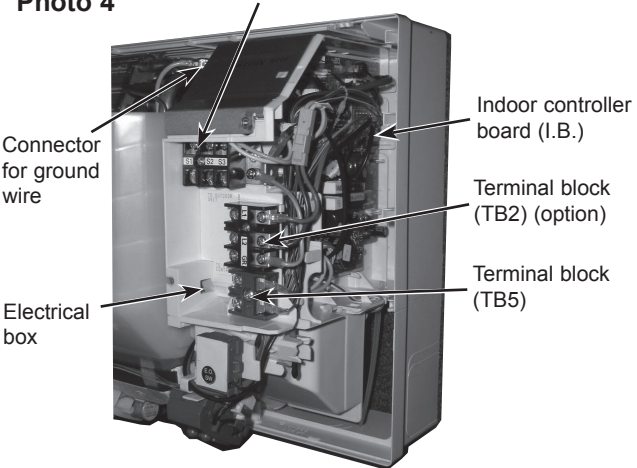
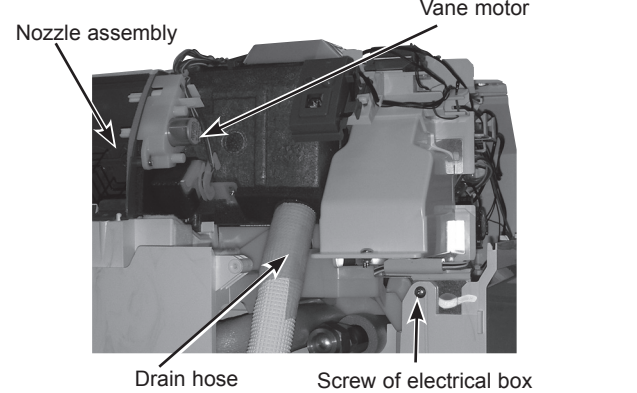
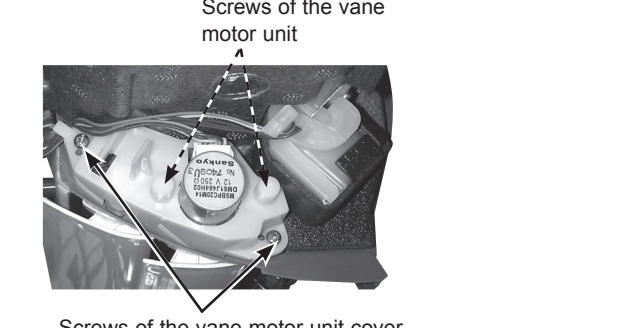
OPERATION PROCEDURE	PHOTOS
<p>3. Removing the electrical box</p> <ol style="list-style-type: none">(1) Remove the panel and the corner box. (Refer to step 1)(2) Remove the front and side electrical box covers (each 1 screw).(3) Remove the indoor / outdoor connecting wire from terminal block (TB4).(4) Disconnect the connectors on the indoor controller board.(5) Disconnect the connector for ground wire.(6) Remove the screw on lower side of the electrical box. (See Photo 5)(7) Push up the upper fixture catch to remove the box, then remove it from the box fixture.	<p>Photo 4</p>  <p>Terminal block (TB4)</p> <p>Indoor controller board (I.B.)</p> <p>Connector for ground wire</p> <p>Electrical box</p> <p>Terminal block (TB2) (option)</p> <p>Terminal block (TB5)</p>
<p>4. Removing the nozzle assembly (with vane and vane motor) and drain hose</p> <ol style="list-style-type: none">(1) Remove the panel and corner box. (Refer to step 1)(2) Remove the electrical box covers. (Refer to step 2)(3) Disconnect the vane motor connector (CN151) on the indoor controller board.(4) Pull out the drain hose from the nozzle assembly, and remove nozzle assembly. (See Photo 5)	<p>Photo 5 (see the bottom)</p>  <p>Nozzle assembly</p> <p>Vane motor</p> <p>Drain hose</p> <p>Screw of electrical box</p>
<p>5. Removing the vane motor</p> <ol style="list-style-type: none">(1) Remove the nozzle assembly. (Refer to step 4)(2) Remove 2 screws of the vane motor unit cover, and pull out the vane motor unit.(3) Remove 2 screws of the vane motor unit.(4) Remove the vane motor from the vane motor unit.(5) Disconnect the connector from the vane motor.	<p>Photo 6</p>  <p>Screws of the vane motor unit</p> <p>Screws of the vane motor unit cover</p>

OPERATION PROCEDURE

6. Removing the indoor fan motor and the line flow fan

- (1) Remove the panel and the corner box. (Refer to step 1)
- (2) Remove the electrical box (Refer to step 2) and the nozzle assembly (Refer to step 3).
- (3) Remove the water cut. (See Photo 2)
- (4) Remove the screw fixing the line flow fan. (See Photo 8)
- (5) Remove 5 screws fixing the motor bed. (See Photo 7)
- (6) Remove the lead wire of pipe thermistor from the hook of motor bed. (See Photo 7)
- (7) Remove the screw fixing motor band. (See Photo 7)
- (8) Remove the motor bed together with fan motor and motor band.
- (9) Remove 3 screws fixing the left side of the heat exchanger. (See Photo 9)
- (10) Lift the heat exchanger, and pull out the line flow fan to the lower-left.

Photo 9

Screws of the left side of the heat exchanger

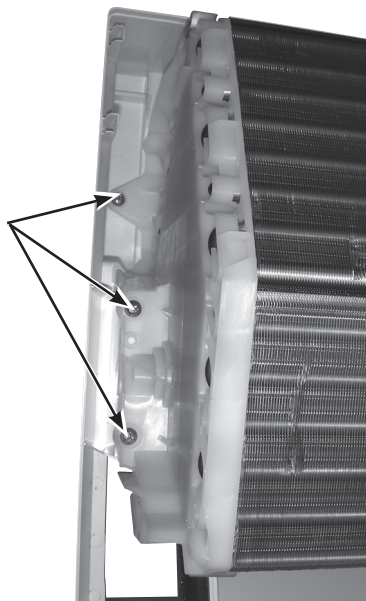

PHOTOS

Photo 7

Screw of the motor band

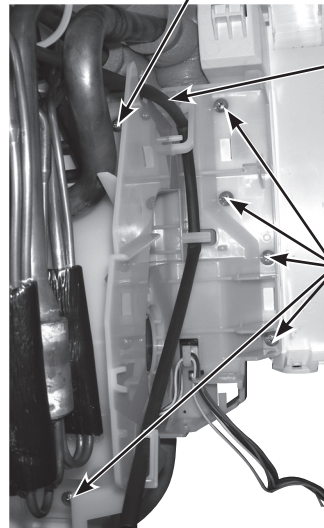

Lead wire of pipe thermistor

Screws of the motor bed

Photo 8

Screw of the line flow fan



7. Removing the pipe temperature thermistor/liquid (TH2) and the condenser/evaporator temperature thermistor (TH5)

- (1) Remove the panel and the corner box. (Refer to step 1)
- (2) Remove the electrical box covers. (Refer to step 2)
- (3) Remove the water cut. (See Photo 2)
- (4) Remove the pipe temperature thermistor/liquid and the condenser/evaporator temperature thermistor.
- (5) Disconnect the connector (CN44) on the indoor controller board.

Photo 10

Condenser/evaporator temperature thermistor (TH5)

Pipe temperature thermistor/liquid (TH2)

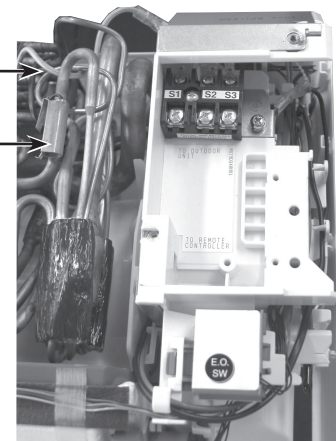

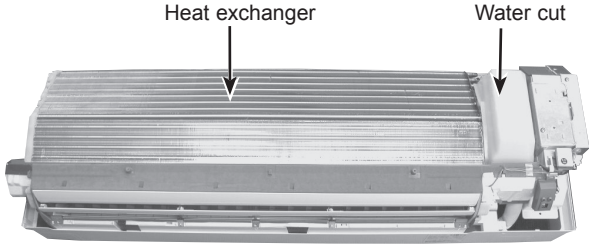
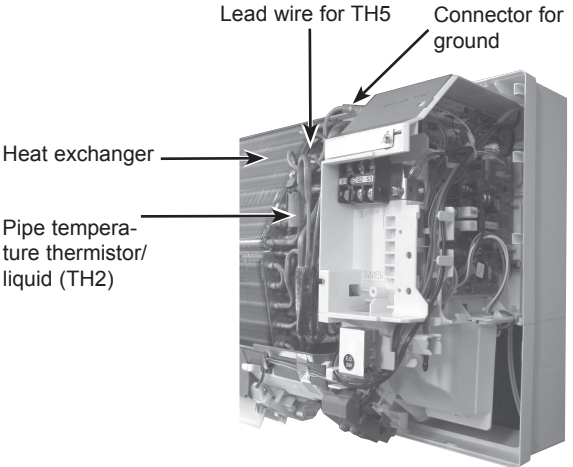
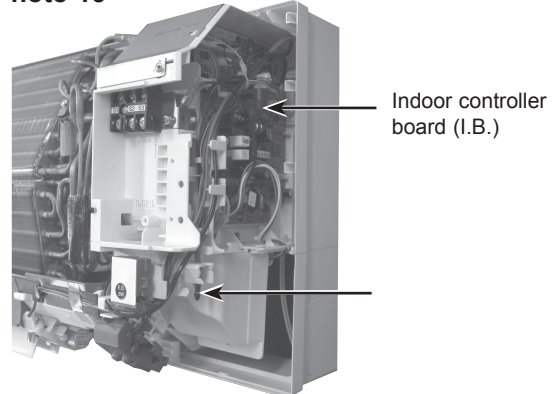

OPERATION PROCEDURE	PHOTOS
<p>8. Removing the heat exchanger</p> <ol style="list-style-type: none">(1) Remove the panel and the corner box. (Refer to step 1)(2) Remove the electrical box (Refer to step 3) and the nozzle assembly (Refer to step 4).(3) Remove the water cut.(4) Remove the pipe thermistors from each holder.(5) Disconnect the connector for ground wire.(6) Remove 3 screws fixing the left side of the heat exchanger. (See Photo 9)(7) Remove the heat exchanger.	<p>Photo 11</p>  <p>Photo 12</p> 
<p>9. Removing the room temperature thermistor</p> <ol style="list-style-type: none">(1) Remove the panel and corner box. (Refer to step 1)(2) Remove the electrical box covers.(3) Remove the room temperature thermistor.(4) Disconnect the connector (CN20) on the indoor controller board.	<p>Photo 13</p> 

Mr. SLIM

mitsubishi electric corporation

HEAD OFFICE : TOKYO BUILDING, 2-7-3, MARUNOUCHI, CHIYODA-KU, TOKYO 100-8310, JAPAN
