

April 2012

No. OCH500

REVISED EDITION-A

TECHNICAL & SERVICE MANUAL

CITY MULTI Series Ceiling Suspended R410A / R22

 Indoor unit
[Model names] [Service Ref.]

PCFY-P15NKMU-E	PCFY-P15NKMU-E.TH PCFY-P15NKMU-ER1.TH
PCFY-P24NKMU-E	PCFY-P24NKMU-E.TH PCFY-P24NKMU-ER1.TH
PCFY-P30NKMU-E	PCFY-P30NKMU-E.TH PCFY-P30NKMU-ER1.TH
PCFY-P36NKMU-E	PCFY-P36NKMU-E.TH PCFY-P36NKMU-ER1.TH

Revision:

- PCFY-P15/24/30/36NKMU-ER1 have been added in REVISED EDITION-A.
- Some descriptions have been modified.

- Please void OCH500.

Note:

- This manual describes only service data of the indoor units.
- RoHS compliant products have <G> mark on the spec name plate.

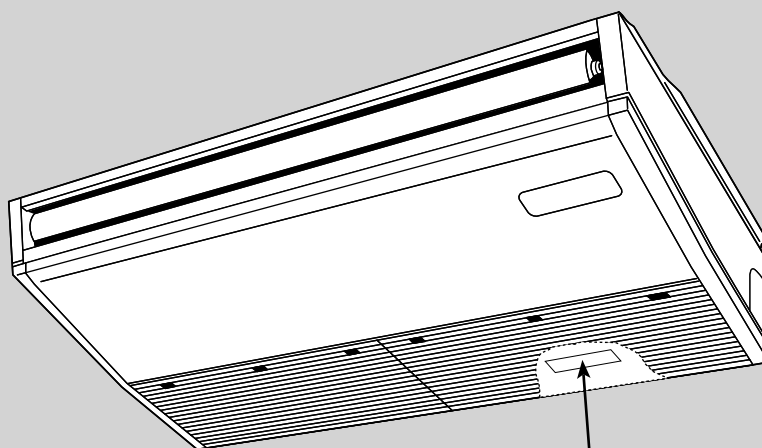

INDOOR UNIT

 Model name
indication

CONTENTS

1. TECHNICAL CHANGES.....	2
2. PART NAMES AND FUNCTIONS	2
3. SPECIFICATION	4
4. OUTLINES AND DIMENSIONS.....	8
5. WIRING DIAGRAM.....	11
6. REFRIGERANT SYSTEM DIAGRAM.....	13
7. MICROPROCESSOR CONTROL.....	14
8. TROUBLESHOOTING	21
9. DISASSEMBLY PROCEDURE.....	30

PARTS CATALOG (OCB500)

CITY MULTI

Use the specified refrigerant only

Never use any refrigerant other than that specified.

Doing so may cause a burst, an explosion, or fire when the unit is being used, serviced, or disposed of.

Correct refrigerant is specified in the manuals and on the spec labels provided with our products.

We will not be held responsible for mechanical failure, system malfunction, unit breakdown or accidents caused by failure to follow the instructions.

1

TECHNICAL CHANGES

PCFY-P15NKMU-E → PCFY-P15NKMU-ER1

PCFY-P24NKMU-E → PCFY-P24NKMU-ER1

PCFY-P30NKMU-E → PCFY-P30NKMU-ER1

PCFY-P36NKMU-E → PCFY-P36NKMU-ER1

INDOOR CONTROLLER BOARD (I.B.) has been changed (S/W version up).

2

PART NAMES AND FUNCTIONS

• Indoor unit

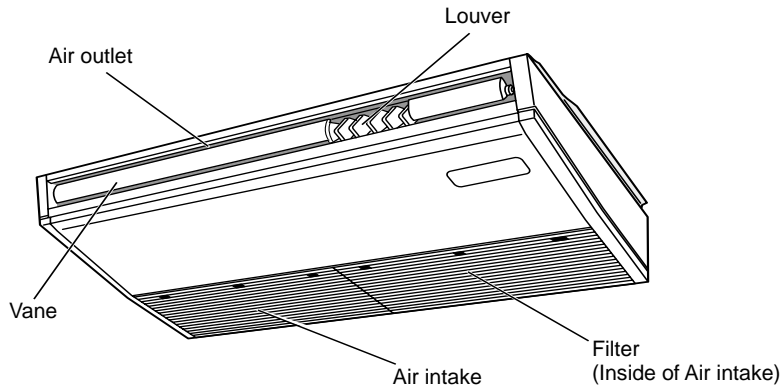

• Wired remote controller

Note:

The phrase "Wired remote controller" in this manual refers only to the PAR-21MAA.

If you need any information for the other remote controller, please refer to either the installation manual or initial setting manual which are included in remote controller's box.

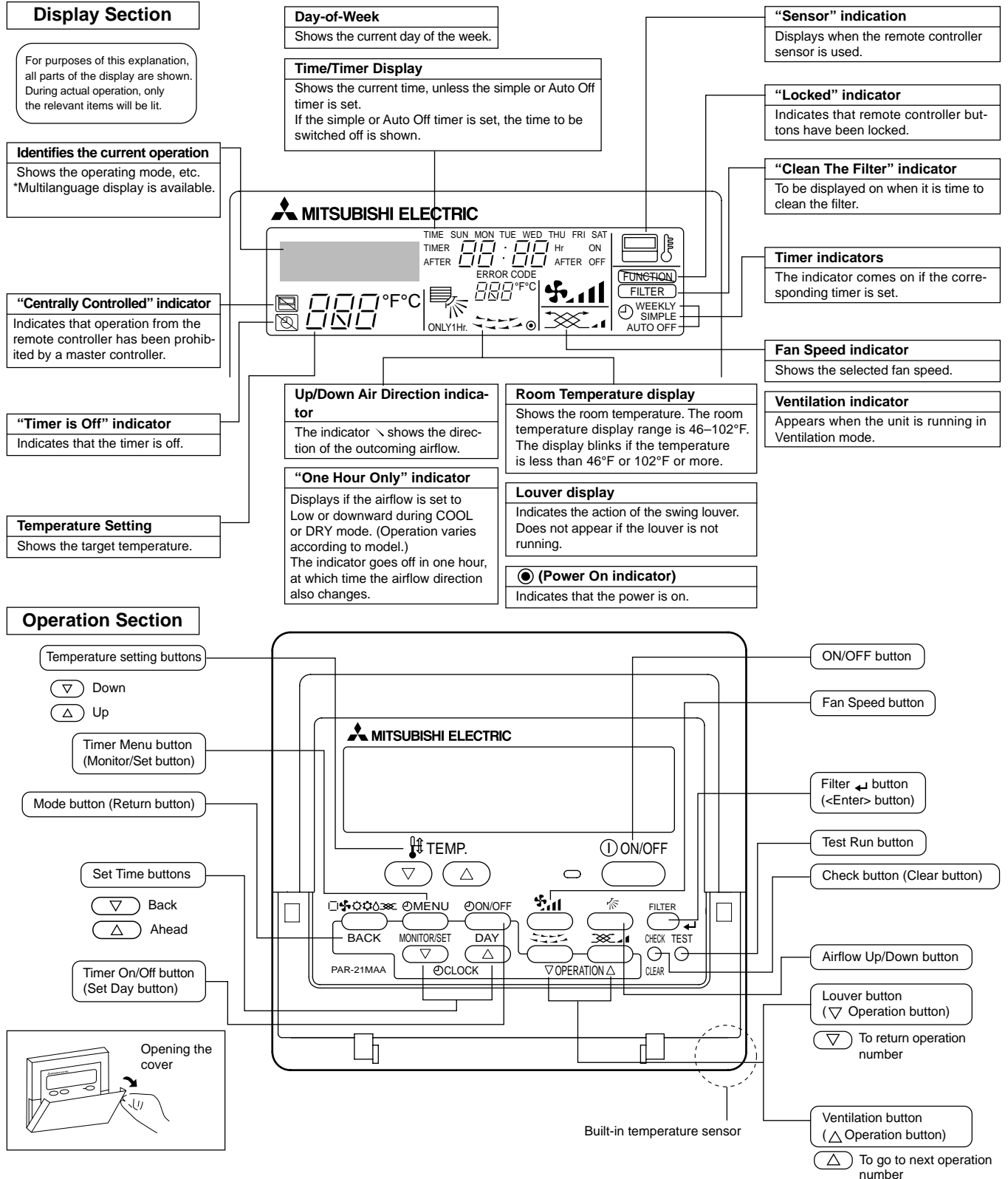

3-1. SPECIFICATIONS

Service ref.	PCFY-P15NKMU-E.TH PCFY-P15NKMU-ER1.TH		PCFY-P24NKMU-E.TH PCFY-P24NKMU-ER1.TH		PCFY-P30NKMU-E.TH PCFY-P30NKMU-ER1.TH		PCFY-P36NKMU-E.TH PCFY-P36NKMU-ER1.TH			
Power source	1-phase 208/230V 60Hz									
Cooling capacity (Nominal)	*1	kW	4.4	7.0	8.8	10.6				
	*1	Btu/h	15,000	24,000	30,000	36,000				
		Power input	kW	0.03	0.04	0.09	0.11			
		Current input	A	0.35	0.41	0.83	0.97			
Heating capacity (Nominal)	*2	kW	5.0	7.9	10.0	11.7				
	*2	Btu/h	17,000	27,000	34,000	40,000				
		Power input	kW	0.03	0.04	0.09	0.11			
		Current input	A	0.35	0.41	0.83	0.97			
External finish	MUNSELL (6.4Y 8.9/0.4)									
External dimensions H x W x D	mm	230x960x680		230x1280x680		230x1600x680				
	in.	9-1/16x37-13/16x26-3/4		9-1/16x50-3/8x26-3/4		9-1/16x63x26-3/4				
Net weight	kg (lb)	24 (53)		32 (71)		36 (79)		38 (84)		
Heat exchanger	Cross fin (Aluminum fin and copper tube)									
FAN	Type x quantity		Sirocco fan x 2		Sirocco fan x 3		Sirocco fan x 4			
	External static press.	Pa	0							
		mmH ₂ O	0							
	Motor type		DC motor							
	Motor output	kW	0.090	0.095	0.160					
	Driving mechanism		Direct-driven by motor							
	Airflow rate (Low-Mid2-Mid1-High)	m ³ /min	10-11-12-13		14-15-16-18		20-22-25-28		21-24-27-31	
		L/s	167-183-200-217		233-250-267-300		333-367-417-467		350-400-450-517	
cfm		353-388-424-459		494-530-565-636		703-777-883-989		742-847-953-1095		
Noise level (Low-Mid2-Mid1-High) (measured in anechoic room)	dB <A>	29-32-34-36		31-33-35-37		34-37-40-43		36-39-42-44		
Insulation material	Polyethylene sheet									
Air filter	PP honeycomb									
Protection device	Fuse									
Refrigerant control device	LEV									
Connectable outdoor unit	R410A, R22 CITY MULTI									
Diameter of refrigerant pipe	Liquid (R410A) (R22)	mm(in.)	ø6.35 (ø1/4) Flare	ø9.52 (ø3/8) Flare	ø9.52 (ø3/8) Flare	ø9.52 (ø3/8) Flare	ø9.52 (ø3/8) Flare			
		mm(in.)	ø6.35 (ø1/4) Flare	ø9.52 (ø3/8) Flare	ø9.52 (ø3/8) Flare	ø9.52 (ø3/8) Flare	ø9.52 (ø3/8) Flare			
	Gas (R410A) (R22)	mm(in.)	ø12.7 (ø1/2) Flare	ø15.88 (ø5/8) Flare	ø15.88 (ø5/8) Flare	ø15.88 (ø5/8) Flare	ø15.88 (ø5/8) Flare			
		mm(in.)	ø12.7 (ø1/2) Flare	ø15.88 (ø5/8) Flare	ø15.88 (ø5/8) Flare	ø15.88 (ø5/8) Flare	ø19.05 (ø3/4) Flare*3			
Field drain pipe size	mm(in.)	O.D. 26mm (1)								
Standard attachment	Document	Installation Manual, Instruction Book								
	Accessory	Drain joint socket								
Optional parts	Drain pump kit	PAC-SH83DM-E		PAC-SH84DM-E						
	High efficiency filter	PAC-SH88KF-E		PAC-SH89KF-E		PAC-SH90KF-E				
	External heater adapter	PAC-YU25HT								
	i-see Sensor	PAC-SH91MK-E								
	Wireless remote controller with i-see Sensor	PAR-SA92MW-E								
Wireless remote controller kit	PAR-SL93B-E									
Remarks	Installation	Details on foundation work, insulation work, electrical wiring, power source switch, and other items shall be referred to the Installation Manual.								
Note :	*1 Nominal cooling conditions	*2 Nominal heating conditions		*3 Connect the joint (purchased locally) for R22			Unit converter			
	Indoor : 80°FDB/67°FWB (26.7°CDB/19.4°CWB)	70°FDB(21°CDB)					kcal/h = kW x 860			
Outdoor : 95°FDB (35°CDB)	47°FDB/43°FWB (8.3°CDB/6.1°CWB)					Btu/h = kW x 3,412				
Pipe length : 25 ft. (7.6 m)	25 ft. (7.6 m)					cfm = m ³ /min x 35.31				
Level difference : 0 ft (0 m)	0 ft (0 m)					lb = kg/0.4536				
* Due to continuing improvement, above specification may be subject to change without notice.							*Above specification data is subject to rounding variation.			

3-2. ELECTRICAL PARTS SPECIFICATIONS

Service Ref. Parts name	Symbol	PCFY-P15NKMU-E.TH PCFY-P15NKMU-ER1.TH	PCFY-P24NKMU-E.TH PCFY-P24NKMU-ER1.TH	PCFY-P30NKMU-E.TH PCFY-P30NKMU-ER1.TH PCFY-P36NKMU-E.TH PCFY-P36NKMU-ER1.TH
Room temperature thermistor	TH21	Resistance 30°F/15.8kΩ, 50°F/9.6kΩ, 70°F/6.0kΩ, 80°F/4.8kΩ, 90°F/3.9kΩ, 100°F/3.2kΩ		
Liquid pipe thermistor	TH22	Resistance 30°F/15.8kΩ, 50°F/9.6kΩ, 70°F/6.0kΩ, 80°F/4.8kΩ, 90°F/3.9kΩ, 100°F/3.2kΩ		
Gas pipe thermistor	TH23	Resistance 30°F/15.8kΩ, 50°F/9.6kΩ, 70°F/6.0kΩ, 80°F/4.8kΩ, 90°F/3.9kΩ, 100°F/3.2kΩ		
Fuse (Indoor controller board)	FUSE	250V 6.3A		
Fan motor	MF	8-pole OUTPUT 90W	8-pole OUTPUT 95W	8-pole OUTPUT 160W
Vane motor	MV	MSBPC20 DC12V 300Ω/phase		
Drain-pump (Option)	DP	INPUT 10.8W 24ℓ/Hr		
Drain float switch	FS	Open / Short detection DC 5V		
Linear expansion valve	LEV	DC12V Stepping motor drive Port dimension ø3.2 (0~2000pulse) EFM-40YGME	DC12V Stepping motor drive Port dimension ø5.2 (0~2000pulse) EFM-80YGME	
Power supply terminal block	TB2	(L1, L2, GR) Rated to 330V 30A*		
Transmission terminal block	TB5	(M1, M2, S) Rated to 250V 20A *		
MA remote controller terminal block	TB15	(1, 2) Rated to 250V 10A *		

*Note : Refer to WIRING DIAGRAM for the supplied voltage.

3-3. SOUND LEVEL

PCFY-P•NKMU-E.TH

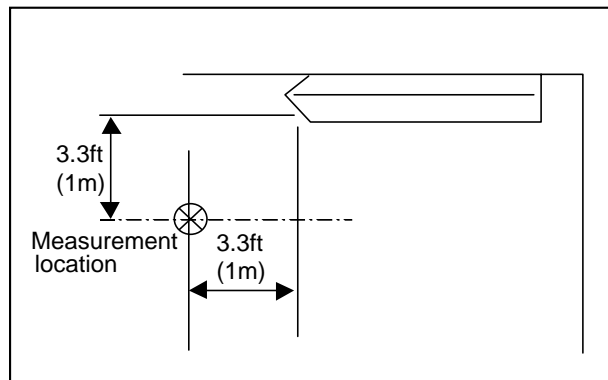

* Measured in anechoic room.

Sound level at anechoic room : Low-Mid2-Mid1-High

Service Ref.	Sound level dB (A)
PCFY-P15NKMU-E.TH PCFY-P15NKMU-ER1.TH	29-32-34-36
PCFY-P24NKMU-E.TH PCFY-P24NKMU-ER1.TH	31-33-35-37
PCFY-P30NKMU-E.TH PCFY-P30NKMU-ER1.TH	34-37-40-43
PCFY-P36NKMU-E.TH PCFY-P36NKMU-ER1.TH	36-39-42-44

3-4. NC CURVES

PCFY-P15NKMU-E.TH
PCFY-P15NKMU-ER1.TH

External static pressure : 0Pa
 Power source : 208V, 230V, 60Hz

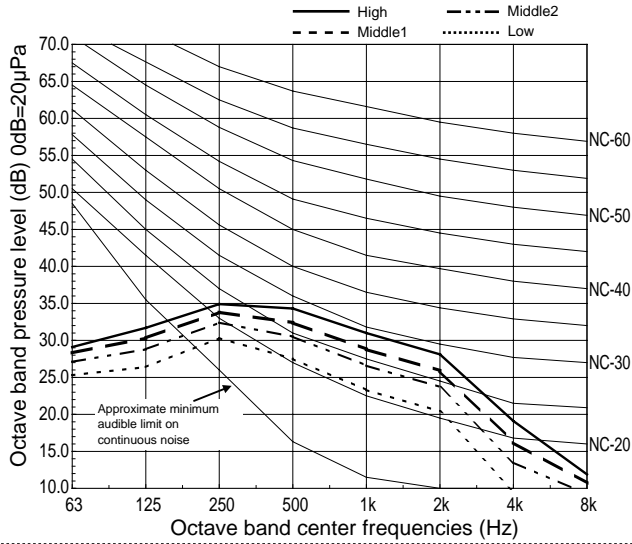

PCFY-P24NKMU-E.TH
PCFY-P24NKMU-ER1.TH

External static pressure : 0Pa
 Power source : 208V, 230V, 60Hz

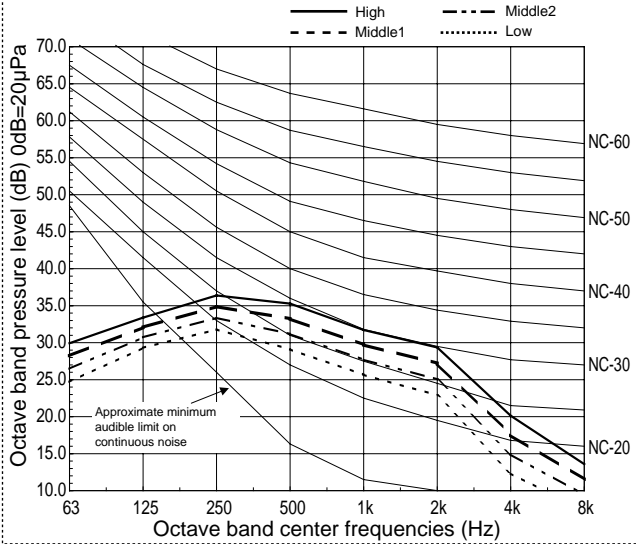

PCFY-P30NKMU-E.TH
PCFY-P30NKMU-ER1.TH

External static pressure : 0Pa
 Power source : 208V, 230V, 60Hz

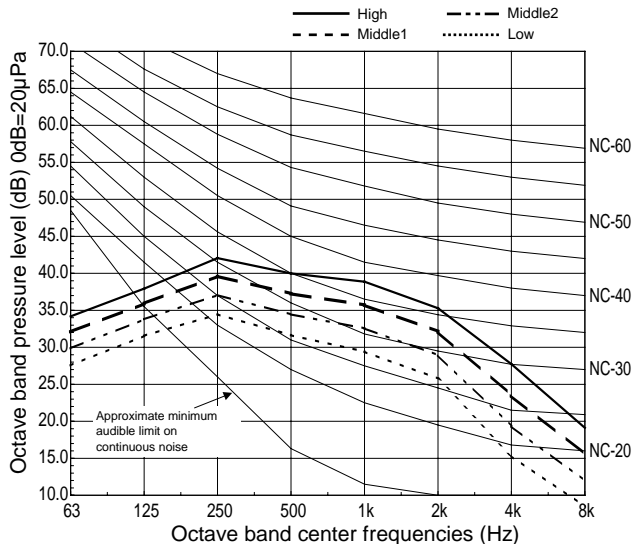

PCFY-P36NKMU-E.TH
PCFY-P36NKMU-ER1.TH

External static pressure : 0Pa
 Power source : 208V, 230V, 60Hz

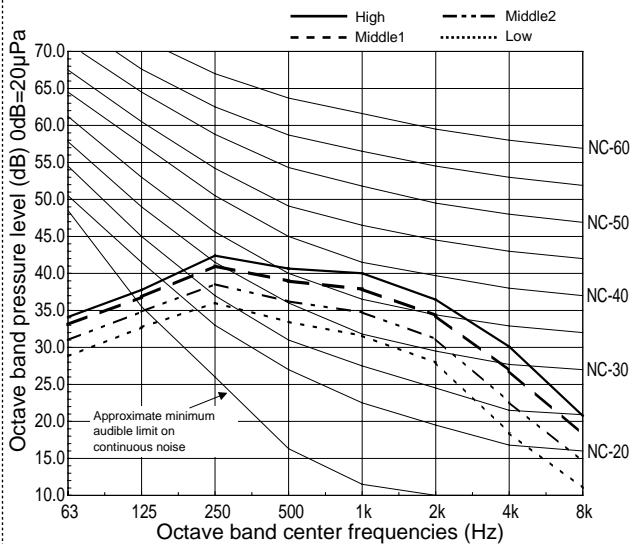

3-5. FRESH AIR INTAKE AMOUNT & STATIC PRESSURE CHARACTERISTICS

■ PCFY-P15NKMU-E.TH PCFY-P15NKMU-ER1.TH

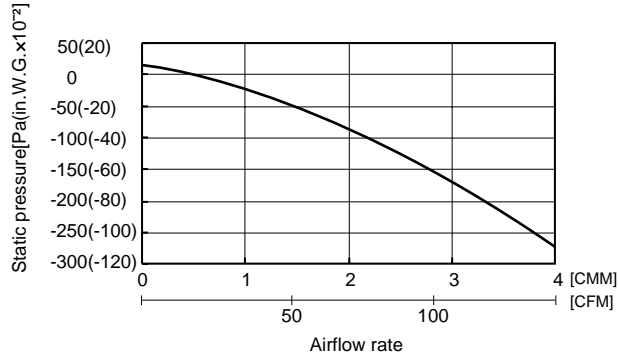

How to read curves

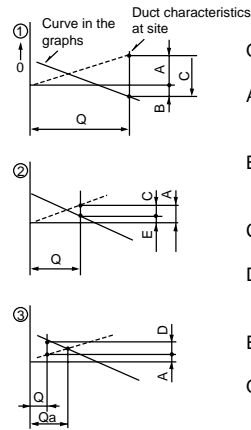

- Q...Designed amount of fresh air intake <CMM(CFM)>
- A...Static pressure loss of fresh air intake duct system with airflow amount Q <Pa(in.W.G.x10⁻²)>
- B...Forced static pressure at air conditioner inlet with airflow amount Q <Pa(in.W.G.x10⁻²)>
- C...Static pressure of booster fan with airflow amount Q <Pa(in.W.G.x10⁻²)>
- D...Static pressure loss increase amount of fresh air intake duct system for airflow amount Q <Pa(in.W.G.x10⁻²)>
- E...Static pressure of indoor unit with airflow amount Q <Pa(in.W.G.x10⁻²)>
- Qa...Estimated amount of fresh air intake without D <CMM(CFM)>

■ PCFY-P24NKMU-E.TH PCFY-P24NKMU-ER1.TH

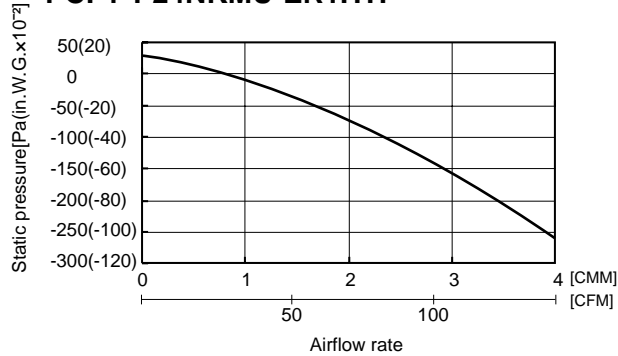

■ PCFY-P30, 36NKMU-E.TH PCFY-P30, 36NKMU-ER1.TH

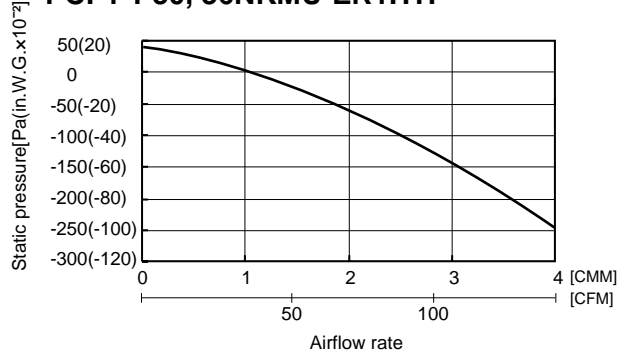

PCFY-P15NKMU-E.TH
PCFY-P30NKMU-E.TH

PCFY-P24NKMU-E.TH
PCFY-P36NKMU-E.TH

[LEGEND]

SYMBOL	NAME	SYMBOL	NAME
I. B	INDOOR CONTROLLER BOARD	TH22	THERMISTOR
CN24	CONNECTOR EXTERNAL HEATER	TH23	THERMISTOR
CN27	CONNECTOR DAMPER	A. B	ADDRESS BOARD
CN32	CONNECTOR REMOTE SWITCH	SWA	SWITCH
CN51	CONNECTOR CENTRALLY CONTROL	SWC	SWITCH
CN52	CONNECTOR REMOTE INDICATION	SW1	SWITCH
FUSE	FUSE (T6.3AL250V)	SW11	SWITCH
SW2	SWITCH CAPACITY CODE ※see table 1	SW12	SWITCH
SW3	SWITCH MODE SELECTION ※see table 1	SW14	SWITCH
SW4	SWITCH MODEL SELECTION	OPTION PARTS	
SWE	SWITCH DRAIN PUMP (TEST MODE)	W.B	PCB FOR WIRELESS REMOTE CONTROLLER
X1	AUX. RELAY DRAIN PUMP (OPTION PART)	BZ	BUZZER
LEV	LINEAR EXPANSION VALVE	LED1	LED (OPERATION INDICATION : GREEN)
MF	FAN MOTOR	LED2	LED (PREPARATION FOR HEATING : ORANGE)
MV	VANE MOTOR	RU	RECEIVING UNIT
TB2	TERMINAL BLOCK POWER SUPPLY	SW1	EMERGENCY OPERATION (HEAT / DOWN)
TB5	TERMINAL BLOCK TRANSMISSION	SW2	EMERGENCY OPERATION (COOL / UP)
TB15	TERMINAL BLOCK MA-REMOTE CONTROLLER	DP	DRAIN PUMP
TH21	THERMISTOR ROOM TEMP. DETECTION (32°F/15KΩ, 77°F/5.4KΩ Detect)	FS	DRAIN FLOAT SWITCH
		MT	I-SEE SENSOR MOTOR

LED on indoor board for service

Mark	Meaning	Function
LED1	Main power supply	Main Power supply (Indoor unit) power on → lamp is lit
LED2	Power supply for MA-Remote controller	Power supply for MA-Remote controller on → lamp is lit

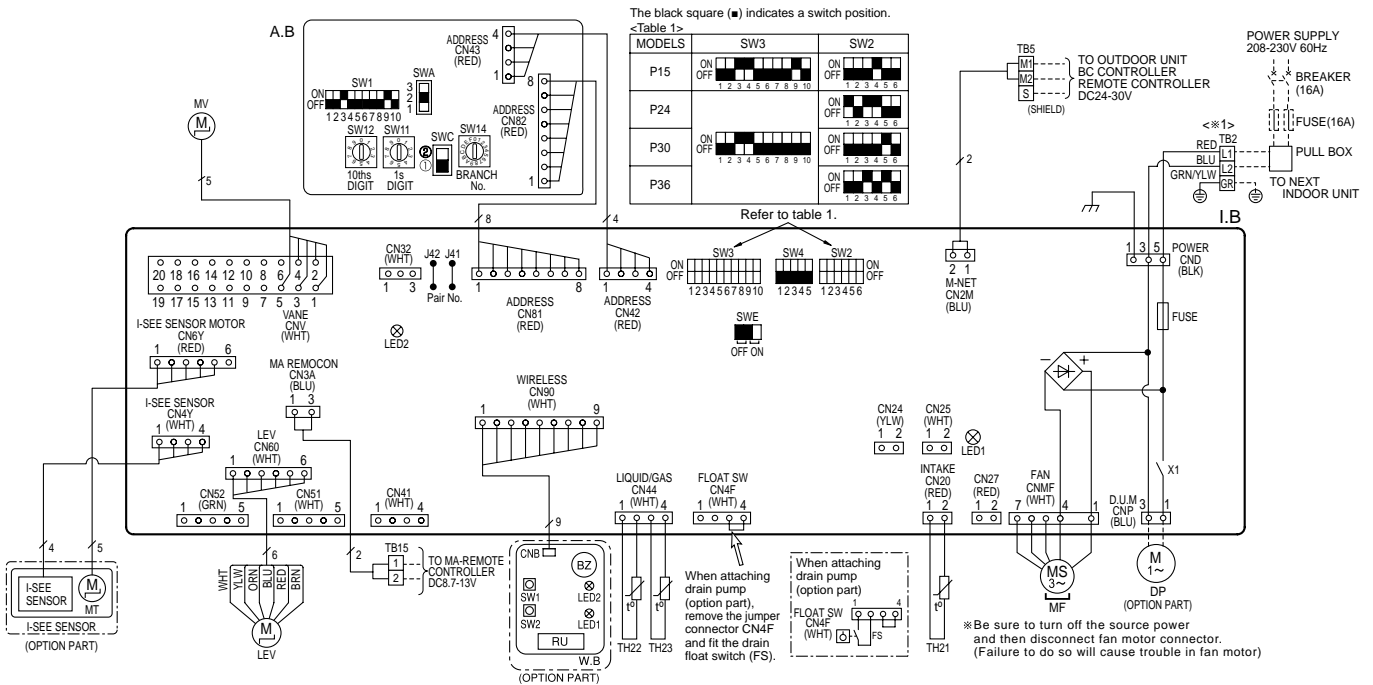

NOTES:

1. At servicing for outdoor unit, always follow the wiring diagram of outdoor unit.
2. In case of using MA-Remote controller, please connect to TB15. (Remote controller wire is non-polar.)
3. In case of using M-NET, please connect to TB5. (Transmission line is non-polar.)
4. Symbol [S] of TB5 is the shield wire connection.
5. Symbols used in wiring diagram above are, []: terminal block, []: connector.
6. The setting of the SW2 dip switches differs in the capacity. For the detail, refer to table 1.

<※1>Use copper supply wires.

6

REFRIGERANT SYSTEM DIAGRAM

PCFY-P15NKMU-E.TH
 PCFY-P30NKMU-E.TH
 PCFY-P15NKMU-ER1.TH
 PCFY-P30NKMU-ER1.TH

PCFY-P24NKMU-E.TH
 PCFY-P36NKMU-E.TH
 PCFY-P24NKMU-ER1.TH
 PCFY-P36NKMU-ER1.TH

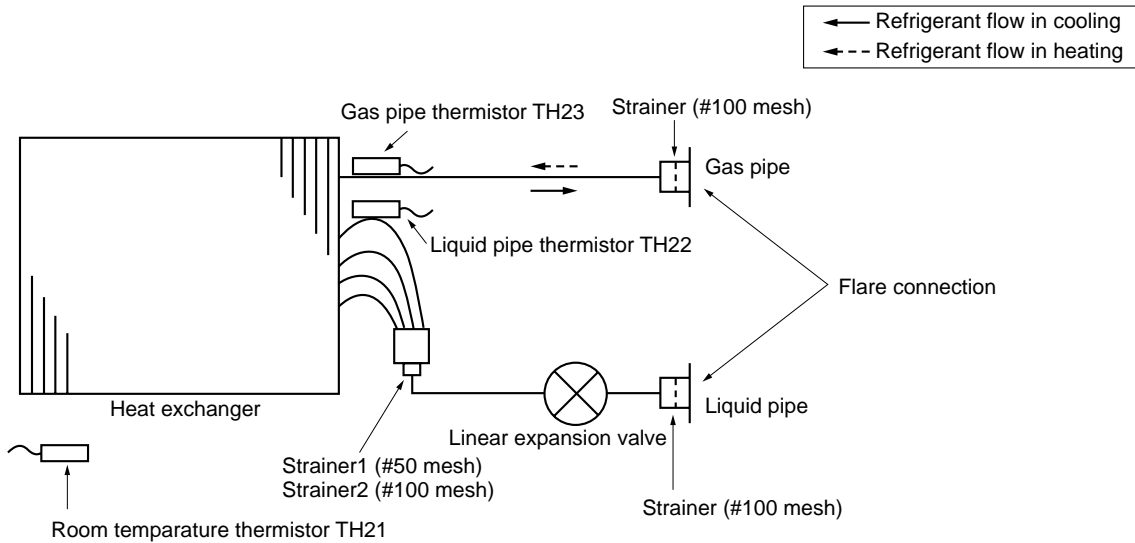

Unit : mm (inch)

Item	Service Ref.	PCFY-P15NKMU-E.TH PCFY-P15NKMU-ER1.TH	PCFY-P24NKMU-E.TH PCFY-P30NKMU-E.TH PCFY-P36NKMU-E.TH PCFY-P24NKMU-ER1.TH PCFY-P30NKMU-ER1.TH PCFY-P36NKMU-ER1.TH
	Gas pipe		ø12.7 (1/2)
Liquid pipe		ø6.35 (1/4)	ø9.52 (3/8)

INDOOR UNIT CONTROL

7-1. COOL OPERATION

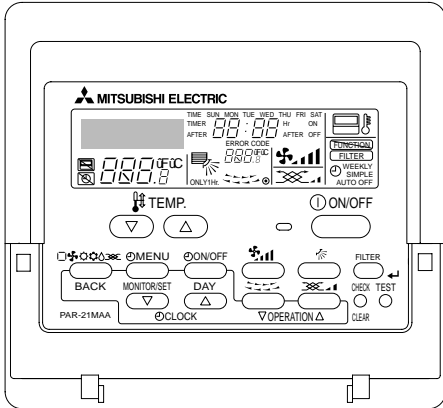

<How to operate>

- ① Press POWER ON/OFF button.
- ② Press the operation MODE button to display COOL.
- ③ Press the TEMP. button to set the desired temperature.

NOTE: The set temperature changes 2°F when the ∇ or Δ button is pressed one time. Cooling 67 to 87°F

Control modes	Control details	Remarks				
1. Thermostat function	<p>1-1. Thermostat function (Function to prevent restarting for 3 minutes)</p> <ul style="list-style-type: none"> • Room temperature \geq desired temperature + 2°F ...Thermo ON • Room temperature \leq desired temperature ...Thermo OFF 					
	<p>1-2. Anti-freezing control</p> <p>Detected condition : When the liquid pipe temp. (TH22) is 32°F or less in 16 minutes from compressors start up, anti-freezing control starts and the thermo OFF.</p> <p>Released condition : The timer which prevents reactivating is set for 3 minutes, and anti-freezing control is cancelled when any one of the following conditions is satisfied.</p> <ol style="list-style-type: none"> ① Liquid pipe temp. (TH22) turns 50°F or above. ② The condition of the thermo OFF has become complete by thermostat, etc. ③ The operation modes became mode other than COOL. ④ The operation stopped. 					
2. Fan	<p>By the remote controller setting (switch of 4 speeds+Auto)</p> <table border="1" style="margin-left: auto; margin-right: auto;"> <thead> <tr> <th>Type</th> <th>Fan speed notch</th> </tr> </thead> <tbody> <tr> <td>4 speeds + Auto type</td> <td>[Low], [Med2], [Med1], [High], [Auto]</td> </tr> </tbody> </table> <p>When [Auto] is set, fan speed is changed depending on the value of: Room temperature - Desired temperature</p>	Type	Fan speed notch	4 speeds + Auto type	[Low], [Med2], [Med1], [High], [Auto]	
Type	Fan speed notch					
4 speeds + Auto type	[Low], [Med2], [Med1], [High], [Auto]					



Control modes	Control details	Remarks
3. Drain pump	<p>3-1. Drain pump control</p> <ul style="list-style-type: none"> • Drain pump is always ON during the COOL and DRY mode operation. (Regardless of the thermo ON/OFF) • When the operation mode has changed from the COOL or DRY to the others (including Stop), the drain pump will be kept on for 3 minutes, then turns OFF. <p>Float switch control</p> <ul style="list-style-type: none"> • Float switch control judges whether the sensor is in the air or in the water by turning the float switch ON/OFF. In the water: Detected that the float switch is ON for 15 seconds. In the air : Detected that the float switch is OFF for 15 seconds. 	
4. Vane (up/down vane change)	<p>(1) Initial setting: Start at COOL mode and horizontal vane.</p> <p>(2) Vane position: Horizontal → Downward A → Downward B → Downward C → Downward D → Swing → Auto</p> <p>(3) Restriction of the downward vane setting When setting the downward vane A, B, C or D in [Med1], [Med2], [Low] or [Auto] of the fan speed notch, the vane changes to horizontal position after 1 hour have passed.</p>	<p>• "ONLY 1 Hr" appears on the wired remote controller.</p>

7-2. DRY OPERATION

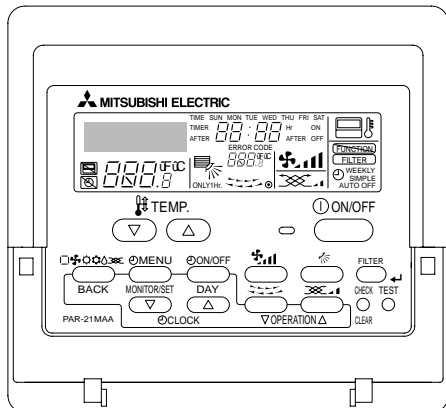

<How to operate>

- ① Press POWER ON/OFF button.
- ② Press the operation MODE button to display DRY.
- ③ Press the TEMP. button to set the desired temperature.

NOTE: The set temperature changes 2°F when the ∇ or \triangle button is pressed one time. Dry 67 to 87°F

Control modes	Control details	Remarks																															
1. Thermostat function	<p>1-1. Thermostat (Function to prevent restarting for 3 minutes) Setting the Dry thermo by the thermostat signal and the room temperature (TH21). Dry thermo ON Room temperature \geq desired temperature + 2°F Dry thermo OFF Room temperature \geq desired temperature</p> <table border="1"> <thead> <tr> <th rowspan="2">Room temperature</th> <th colspan="2">3 min. passed since starting operation</th> <th rowspan="2">Dry thermo ON time (min)</th> <th rowspan="2">Dry thermo OFF time (min)</th> </tr> <tr> <th>Thermostat signal</th> <th>Room temperature (T1)</th> </tr> </thead> <tbody> <tr> <td rowspan="4">Over 64°F</td> <td rowspan="4">ON</td> <td>T1 \geq 83°F</td> <td>9</td> <td>3</td> </tr> <tr> <td>83°F > T1 \geq 79°F</td> <td>7</td> <td>3</td> </tr> <tr> <td>79°F > T1 \geq 75°F</td> <td>5</td> <td>3</td> </tr> <tr> <td>75°F > T1</td> <td>3</td> <td>3</td> </tr> <tr> <td></td> <td>OFF</td> <td>Unconditional</td> <td>3</td> <td>10</td> </tr> <tr> <td>Less than 64°F</td> <td colspan="4">Dry thermo OFF</td> </tr> </tbody> </table>	Room temperature	3 min. passed since starting operation		Dry thermo ON time (min)	Dry thermo OFF time (min)	Thermostat signal	Room temperature (T1)	Over 64°F	ON	T1 \geq 83°F	9	3	83°F > T1 \geq 79°F	7	3	79°F > T1 \geq 75°F	5	3	75°F > T1	3	3		OFF	Unconditional	3	10	Less than 64°F	Dry thermo OFF				
	Room temperature		3 min. passed since starting operation				Dry thermo ON time (min)	Dry thermo OFF time (min)																									
Thermostat signal		Room temperature (T1)																															
Over 64°F	ON	T1 \geq 83°F	9	3																													
		83°F > T1 \geq 79°F	7	3																													
		79°F > T1 \geq 75°F	5	3																													
		75°F > T1	3	3																													
	OFF	Unconditional	3	10																													
Less than 64°F	Dry thermo OFF																																
	<p>1-2. Freeze prevention control No control function</p>																																
2. Fan	<p>Indoor fan operation controlled depending on the compressor conditions.</p> <table border="1"> <thead> <tr> <th>Dry thermo</th> <th colspan="2">Fan speed notch</th> </tr> </thead> <tbody> <tr> <td>ON</td> <td colspan="2">[Low]</td> </tr> <tr> <td rowspan="2">OFF</td> <td>Excluding the following</td> <td>Stop</td> </tr> <tr> <td>Room temp. < 64°F</td> <td>[Low]</td> </tr> </tbody> </table> <p>Note: Remote controller setting is not acceptable.</p>	Dry thermo	Fan speed notch		ON	[Low]		OFF	Excluding the following	Stop	Room temp. < 64°F	[Low]																					
Dry thermo	Fan speed notch																																
ON	[Low]																																
OFF	Excluding the following	Stop																															
	Room temp. < 64°F	[Low]																															
3. Drain pump	Same control as COOL operation																																
4. Vane (up/down vane change)	Same control as COOL operation																																

7-3. FAN OPERATION

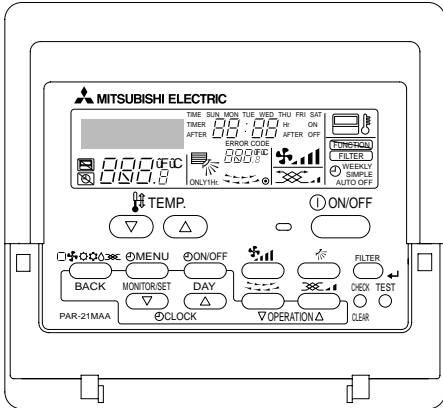

<How to operate>

- ① Press POWER ON/OFF button.
- ② Press the operation MODE button to display FAN.

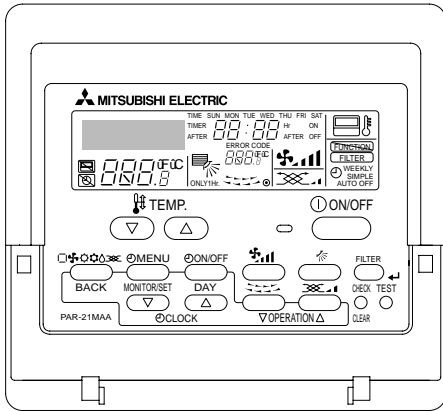

Control modes	Control details	Remarks				
1. Fan	<p>Set by remote controller.</p> <table border="1"> <thead> <tr> <th>Type</th> <th>Fan speed notch</th> </tr> </thead> <tbody> <tr> <td>4 speeds + Auto type</td> <td>[Low], [Med2], [Med1], [High], [Auto]</td> </tr> </tbody> </table> <p>When [Auto] is set, fan speed becomes [Low].</p>	Type	Fan speed notch	4 speeds + Auto type	[Low], [Med2], [Med1], [High], [Auto]	
Type	Fan speed notch					
4 speeds + Auto type	[Low], [Med2], [Med1], [High], [Auto]					
2. Drain pump	<p>2-1. Drain pump control The drain pump turns ON for the specified amount of time when any of the following conditions is met:</p> <ul style="list-style-type: none"> ① ON for 3 minutes after the operation mode is switched from COOL or DRY to another operation mode (FAN). ② ON for 6 minutes after the float switch is submerged in the water when the float switch control judges the sensor is in the water. 					
	<p>2-2. Float switch control</p> <ul style="list-style-type: none"> • Float switch control judges whether the sensor is in the air or in the water by turning the float switch ON/OFF. In the water : Detected that the float switch is ON for 15 seconds. In the air : Detected that the float switch is OFF for 15 seconds. 	<ul style="list-style-type: none"> • Same control as COOL operation 				
3. Vane (up/down vane change)	Same as the control performed during the COOL operation, but with no restriction on the vane's downward blow setting					

7-4. HEAT OPERATION



<How to operate>

- ① Press POWER ON/OFF button.
- ② Press the operation MODE button to display HEAT.
- ③ Press the TEMP. button to set the desired temperature.

NOTE: The set temperature changes 2°F when the  or  button is pressed one time. Heating 63 to 83°F.

<Display in HEAT operation>

[DEFROST]

The [DEFROST] symbol is only displayed during the defrost operation.

[STANDBY]

The [STANDBY] symbol is only displayed during the hot adjust mode.

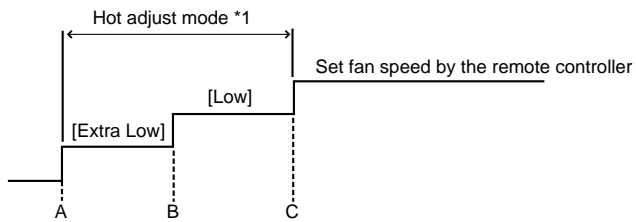
Control modes	Control details	Remarks				
1. Thermostat function	1-1. Thermostat function (Function to prevent restarting for 3 minutes) <ul style="list-style-type: none"> • Room temperature \leq desired temperature -2°F ...Thermo ON • Room temperature \leq desired temperature ...Thermo OFF 					
2. Fan	By the remote controller setting (switch of 4 speeds+Auto) <table border="1" style="margin: 10px auto;"> <thead> <tr> <th>Type</th> <th>Fan speed notch</th> </tr> </thead> <tbody> <tr> <td>4 speeds + Auto type</td> <td>[Low], [Med2], [Med1], [High], [Auto]</td> </tr> </tbody> </table> When [Auto] is set, fan speed is changed depending on the value of: Desired temperature - Room temperature Give priority to under - mentioned controlled mode <ol style="list-style-type: none"> 2-1. Hot adjust mode 2-2. Residual heat exclusion mode 2-3. Thermo OFF mode (When the compressor off by the thermostat) 2-4. Cool air prevention mode (Defrosting mode) 	Type	Fan speed notch	4 speeds + Auto type	[Low], [Med2], [Med1], [High], [Auto]	
Type	Fan speed notch					
4 speeds + Auto type	[Low], [Med2], [Med1], [High], [Auto]					
	2-1. Hot adjust mode The fan controller becomes the hot adjuster mode for the following conditions. <ol style="list-style-type: none"> ① When starting the HEAT operation ② When the thermostat function changes from OFF to ON. ③ When release the HEAT defrosting operation  <p>A: Hot adjust mode starts. B: 5 minutes have passed since the condition A or the indoor liquid pipe temperature turned 95°F or more. C: 2 minutes have passed since the condition B. (Terminating the hot adjust mode)</p>	*1 "STAND BY" will be displayed during the hot adjust mode.				
	2-2. Residual heat exclusion mode When the condition changes the auxiliary heater ON to OFF (thermostat or operation stop, etc), the indoor fan operates in [Low] mode for 1 minute.	· This control is same for the model without auxiliary heater.				

To be continued on the next page.

From the preceding page

Control modes	Control details	Remarks
2. Fan	2-3. Thermo OFF mode When the thermostat function changes to OFF, the indoor fan operates in [Extra low].	
	2-4. Heat defrosting mode The indoor fan stops.	
3. Drain pump	3-1. Drain pump control The drain pump turns ON for the specified amount of time when any of the following conditions is met: ① ON for 3 minutes after the operation mode is switched from COOL or DRY to another operation mode (FAN). ② ON for 6 minutes after the float switch is submerged in the water when the float switch control judges the sensor is in the water.	
	3-2. Float switch control • Float switch control judges whether the sensor is in the air or in the water by turning the float switch ON/OFF. In the water: Detected that the float switch is ON for 15 seconds. In the air : Detected that the float switch is OFF for 15 seconds.	• Same control as COOL operation
4. Vane control (Up/down vane change)	(1) Initial setting: OFF → HEAT...[last setting] When the last setting is [Swing] ... [Downward D] When changing the mode from exception of HEAT to HEAT operation ...[Downward D] (2) Vane position: Horizontal →Downward A →Downward B →Downward C→Downward D→Swing→Auto  (3) Restriction of vane position ① The vane is horizontally fixed for the following modes. (The control by the remote controller is temporally invalidated and control by the unit.) •Thermo OFF •Hot adjust [Extra low] mode •Heat defrost mode	

7-5. AUTO OPERATION [AUTOMATIC COOL/HEAT CHANGE OVER OPERATION]

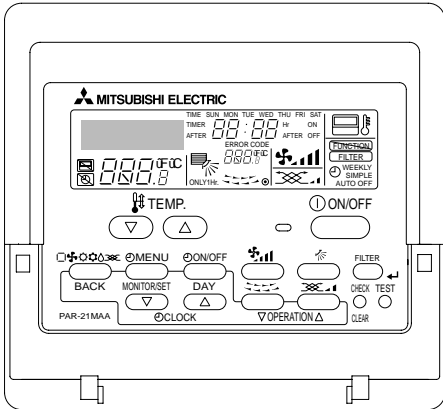

<How to operate>

- ① Press POWER ON/OFF button.
- ② Press the operation MODE button to display AUTO.
- ③ Press the TEMP. button to set the desired temperature.

NOTE: The set temperature changes 2°F when the ∇ or Δ button is pressed one time. Automatic 67 to 83°F

Control modes	Control details	Remarks
1. Initial value of operation mode	HEAT mode for room temperature < Desired temperature COOL mode for room temperature \geq Desired temperature	
2. Mode change	(1) HEAT mode \rightarrow COOL mode Room temperature \geq Desired temperature + 3°F. or 3 min. has passed (2) COOL mode \rightarrow HEAT mode Room temperature \geq Desired temperature - 3°F. or 3 min. has passed	
3. COOL mode	Same control as cool operation	
4. HEAT mode	Same control as heat operation	

7-6. WHEN UNIT IS STOPPED

Control modes	Control details	Remarks
1. Drain pump	1-1. Drain pump control The drain pump turns ON for the specified amount of time when any of the following conditions is met: ① ON for 3 minutes after the operation mode is switched from COOL or DRY to another operation mode (FAN). ② ON for 6 minutes after the float switch is submerged in the water when the float switch control judges the sensor is in the water.	
	1-2. Float switch control • Float switch control judges whether the sensor is in the air or in the water by turning the float switch ON/OFF. In the water : Detected that the float switch is ON for 15 seconds. In the air : Detected that the float switch is OFF for 15 seconds.	• Same control as COOL operation

8-1. HOW TO CHECK THE PARTS

PCFY-P15NKMU-E.TH

PCFY-P24NKMU-E.TH

PCFY-P30NKMU-E.TH

PCFY-P36NKMU-E.TH

PCFY-P15NKMU-ER1.TH

PCFY-P24NKMU-ER1.TH

PCFY-P30NKMU-ER1.TH

PCFY-P36NKMU-ER1.TH

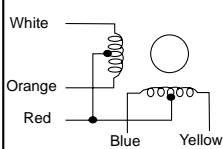
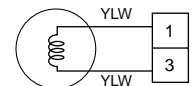
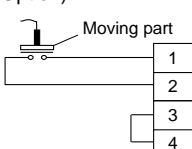
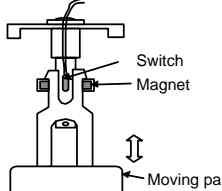
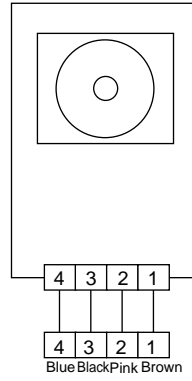
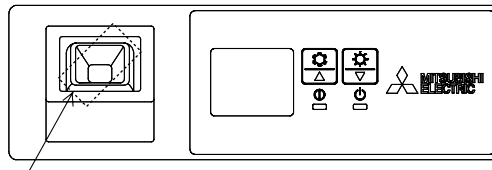
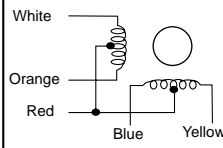
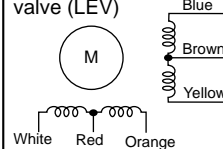
Parts name	Check points														
Room temperature thermistor (TH21) Liquid pipe thermistor (TH22) Gas pipe thermistor (TH23)	Disconnect the connector then measure the resistance with a tester. (At the ambient temperature 50°F~86°F) <table border="1" style="margin-left: 20px;"> <tr> <th>Normal</th> <th>Abnormal</th> </tr> <tr> <td>4.3kΩ~9.6kΩ</td> <td>Open or short</td> </tr> </table> (Refer to the next page for a detail.)	Normal	Abnormal	4.3kΩ~9.6kΩ	Open or short										
Normal	Abnormal														
4.3kΩ~9.6kΩ	Open or short														
Vane motor (MV) 	Measure the resistance between the terminals with a tester. (At the ambient temperature of 68°F~86°F) <table border="1" style="margin-left: 20px;"> <tr> <th>Connector</th> <th>Normal</th> <th>Abnormal</th> </tr> <tr> <td>Red - Yellow</td> <td rowspan="4">300Ω</td> <td rowspan="4">Open or short</td> </tr> <tr> <td>Red - Blue</td> </tr> <tr> <td>Red - Orange</td> </tr> <tr> <td>Red - White</td> </tr> </table>	Connector	Normal	Abnormal	Red - Yellow	300Ω	Open or short	Red - Blue	Red - Orange	Red - White					
Connector	Normal	Abnormal													
Red - Yellow	300Ω	Open or short													
Red - Blue															
Red - Orange															
Red - White															
Drain pump (DP) (Option) 	Measure the resistance between the terminals with a tester. (Winding temperature 68°F) <table border="1" style="margin-left: 20px;"> <tr> <th>Normal</th> <th>Abnormal</th> </tr> <tr> <td>290Ω</td> <td>Open or short</td> </tr> </table>	Normal	Abnormal	290Ω	Open or short										
Normal	Abnormal														
290Ω	Open or short														
Drain float switch (FS) (Option) 	Measure the resistance between the terminals with a tester. <table border="1" style="margin-left: 20px;"> <tr> <th>State of moving part</th> <th>Normal</th> <th>Abnormal</th> </tr> <tr> <td>UP</td> <td>Short</td> <td>Other than short</td> </tr> <tr> <td>DOWN</td> <td>Open</td> <td>Other than open</td> </tr> </table> 	State of moving part	Normal	Abnormal	UP	Short	Other than short	DOWN	Open	Other than open					
State of moving part	Normal	Abnormal													
UP	Short	Other than short													
DOWN	Open	Other than open													
i-see sensor (Option) 	① Turn on the indoor unit with the black plastic tape on the outside of i-see sensor controller board. ② i-see sensor rotates then pull out the connector of motor for i-see sensor. ③ With electricity being turned on, measure the power voltage between connectors with tester.  <p style="text-align: center;">Black plastic tape</p> i-see sensor (At the ambient temperature of 50°F~104°F) <table border="1" style="margin-left: 20px;"> <tr> <th>i-see sensor connector</th> <th>Normal</th> <th>Abnormal</th> </tr> <tr> <td>②(-)---④(+)</td> <td>DC 1.857V~ 3.132V</td> <td>Other than the normal</td> </tr> <tr> <td>①(+)-②(-)</td> <td>DC 0.939V~ 1.506V</td> <td>Other than the normal</td> </tr> </table> <p>NOTE : Be careful of handling such a static electricity.</p>	i-see sensor connector	Normal	Abnormal	②(-)---④(+)	DC 1.857V~ 3.132V	Other than the normal	①(+)-②(-)	DC 0.939V~ 1.506V	Other than the normal					
i-see sensor connector	Normal	Abnormal													
②(-)---④(+)	DC 1.857V~ 3.132V	Other than the normal													
①(+)-②(-)	DC 0.939V~ 1.506V	Other than the normal													
Vane motor for i-see sensor (Option) 	Measure the resistance between the terminals with a tester. (At the ambient temperature of 68°F~86°F) <table border="1" style="margin-left: 20px;"> <tr> <th>Connector</th> <th>Normal</th> <th>Abnormal</th> </tr> <tr> <td>Red - Yellow</td> <td rowspan="4">250Ω</td> <td rowspan="4">Open or short</td> </tr> <tr> <td>Red - Blue</td> </tr> <tr> <td>Red - Orange</td> </tr> <tr> <td>Red - White</td> </tr> </table>	Connector	Normal	Abnormal	Red - Yellow	250Ω	Open or short	Red - Blue	Red - Orange	Red - White					
Connector	Normal	Abnormal													
Red - Yellow	250Ω	Open or short													
Red - Blue															
Red - Orange															
Red - White															
Linear expansion valve (LEV) 	Disconnect the connector then measure the resistance valve with a tester. <table border="1" style="margin-left: 20px;"> <tr> <th colspan="4">Normal</th> <th>Abnormal</th> </tr> <tr> <td>White-Red</td> <td>Yellow-Brown</td> <td>Orange-Red</td> <td>Blue-Brown</td> <td rowspan="2">Open or short</td> </tr> <tr> <td colspan="4">200Ω ±10%</td> </tr> </table> Refer to 8-1-2.	Normal				Abnormal	White-Red	Yellow-Brown	Orange-Red	Blue-Brown	Open or short	200Ω ±10%			
Normal				Abnormal											
White-Red	Yellow-Brown	Orange-Red	Blue-Brown	Open or short											
200Ω ±10%															

8-1-1. Thermistor

<Thermistor characteristic graph>

Thermistor for lower temperature

Room temperature thermistor (TH21)
Liquid pipe temperature thermistor (TH22)
Gas pipe temperature thermistor (TH23)

Thermistor $R_0=15k\Omega \pm 3\%$
Fixed number of $B=3480 \pm 2\%$

$$R_t = 15 \exp \left\{ 3480 \left(\frac{1}{273 + (t - 32)/1.8} - \frac{1}{273} \right) \right\}$$

30°F	15.8kΩ
50°F	9.6kΩ
70°F	6.0kΩ
80°F	4.8kΩ
90°F	3.9kΩ
100°F	3.2kΩ

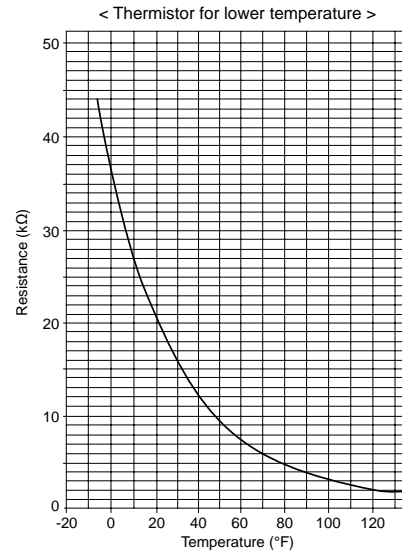

8-1-2. Linear expansion valve

① Operation summary of the linear expansion valve

- Linear expansion valve open/close through stepping motor after receiving the pulse signal from the indoor controller board.
- Valve position can be changed in proportion to the number of pulse signals.

<Connection between the indoor controller board and the linear expansion valve>

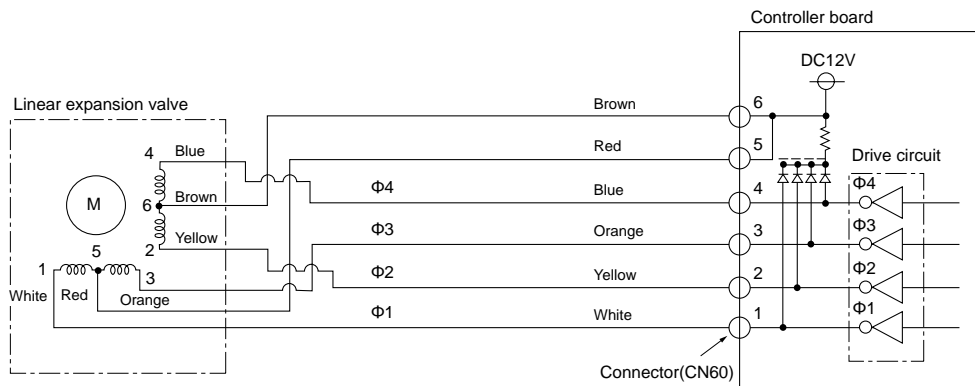

<Output pulse signal and the valve operation>

Output (Phase)	Output			
	1	2	3	4
Φ1	ON	OFF	OFF	ON
Φ2	ON	ON	OFF	OFF
Φ3	OFF	ON	ON	OFF
Φ4	OFF	OFF	ON	ON

Closing a valve : 1 → 2 → 3 → 4 → 1
 Opening a valve : 4 → 3 → 2 → 1 → 4
 The output pulse shifts in above order.

Note:

- When linear expansion valve operation stops, all output phase become OFF.
- At phase interruption or when phase does not shift in order, motor does not rotate smoothly and motor will lock and vibrate.
- When the switch is turned on, 2200 pulse closing valve signal will be sent till it goes to point ㉞ in order to define the valve position.
- When the valve moves smoothly, there is no sound or vibration occurring from the linear expansion valves, however, when the pulse number moves from ㉞ to ㉞ or when the valve is locked, more sound can be heard than in a normal situation.
- Sound can be detected by placing the ear against the screw driver handle while putting the screw driver tip to the linear expansion valve.

② Linear expansion valve operation

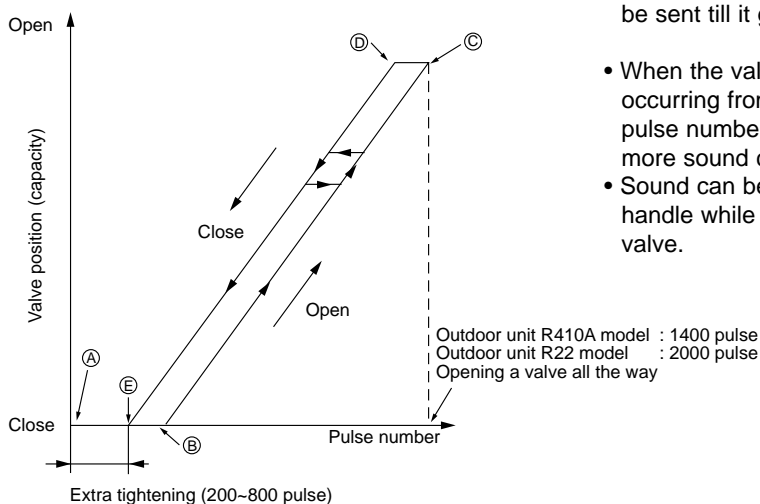

③ Troubleshooting

Symptom	Check points	Countermeasures
Operation circuit failure of the micro processor	Disconnect the connector on the controller board, then connect LED for checking. 1kΩ LED	Exchange the indoor controller board at drive circuit failure.
Linear expansion valve mechanism is locked.	Motor will idle and make a ticking noise when the motor is operated while the linear expansion valve is locked. This ticking sound is the sign of the abnormality.	Exchange the linear expansion valve.
Short or breakage of the motor coil of the linear expansion valve	Measure the resistance between each coil (white-red, yellow-brown, orange-red, blue-brown) using a tester. It is normal if the resistance is in the range of 200Ω ±10%.	Exchange the linear expansion valve.
Valve does not close completely.	To check the linear expansion valve, operate the indoor unit in fan mode and at the same time operate other indoor units in cooling mode, then check the pipe temperature <liquid pipe temperature> of the indoor unit by the outdoor multi controller board operation monitor. During fan operation, linear expansion valve is closed completely and if there is any leaking, detecting temperature of the thermistor will go lower. If the detected temperature is much lower than the temperature indicated in the remote controller, it means the valve is not closed all the way. Thermistor (Liquid pipe) Linear expansion valve	If large amount of refrigerant is leaked, exchange the linear expansion valve.
Wrong connection of the connector or contact failure	Check the color of lead wire and missing terminal of the connector.	Disconnect the connector at the controller board, then check the continuity.

8-1-3. DC Fan motor (fan motor/indoor controller circuit board)

Check method of DC fan motor (fan motor/indoor controller circuit board)

① Notes



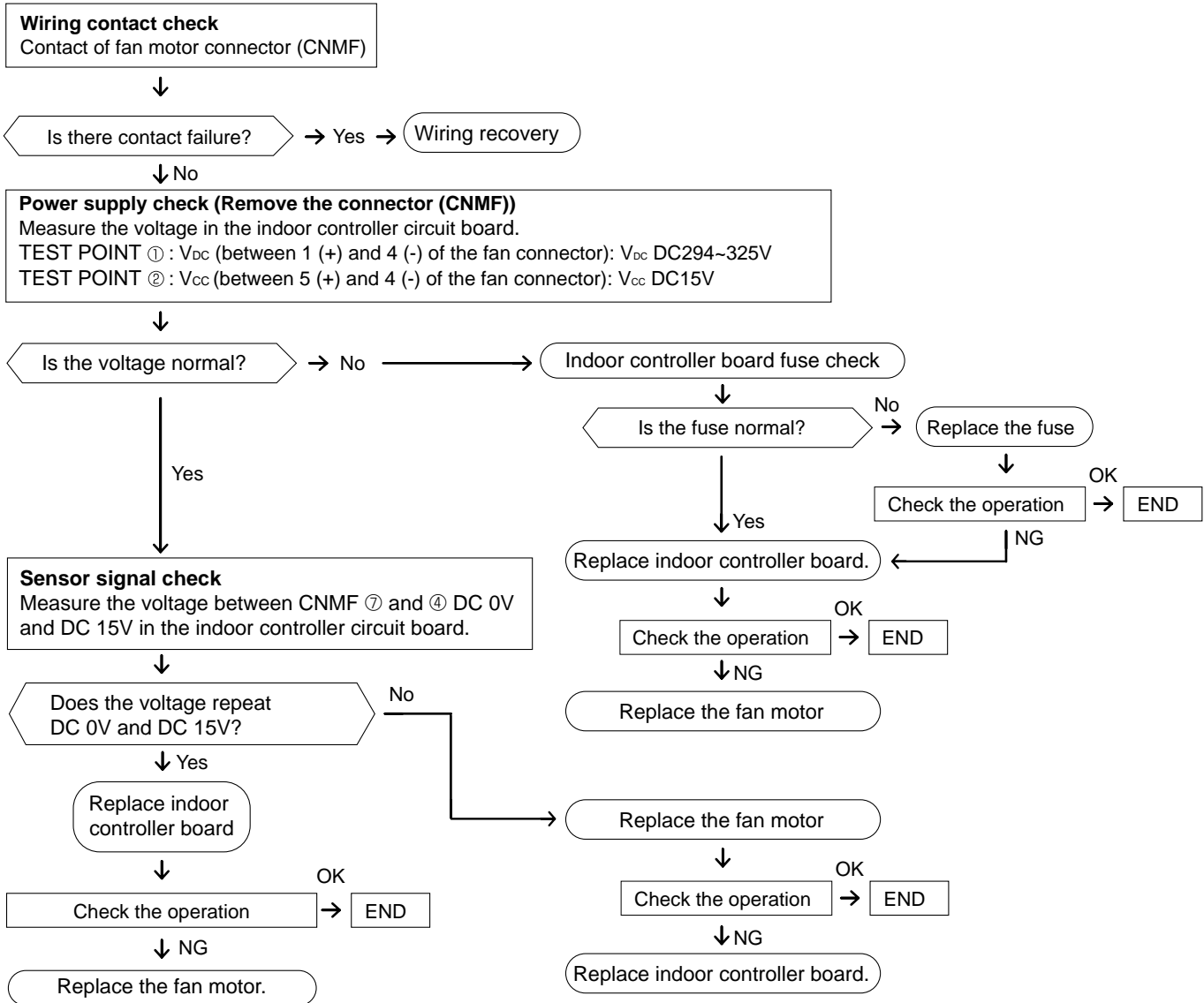

- High voltage is applied to the connector (CNMF) for the fan motor. Pay attention to the service.
- Do not pull out the connector (CNMF) for the motor with the power supply on.
(It causes trouble of the indoor controller circuit board and fan motor.)

② Self check

Symptom : The indoor fan cannot turn around.

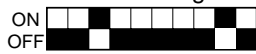
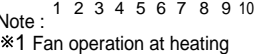
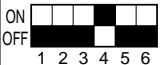

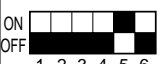

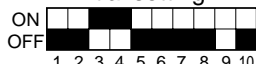
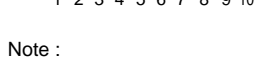
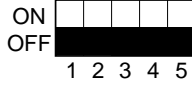
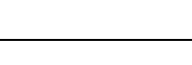

8-2. FUNCTION OF DIP SWITCH

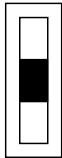
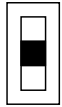

Switch	Pole	Function	Operation by switch		Effective timing	Remarks															
			ON	OFF																	
SW1 Function setting	1	Thermistor <Room temperature detection> position	Built-in remote controller	Indoor unit	Under suspension	<div style="border: 1px solid black; padding: 2px;">Address board</div> <p><Initial setting></p> <p>ON </p> <p>OFF </p> <p>Note : 1 2 3 4 5 6 7 8 9 10</p> <p>※1 Fan operation at heating mode</p> <p>※2 Thermo ON operation at heating mode</p> <p>※3</p> <table border="1" style="font-size: small;"> <tr> <td>SW1-7</td> <td>SW1-8</td> <td></td> </tr> <tr> <td>OFF</td> <td>OFF</td> <td>Extra low</td> </tr> <tr> <td>ON</td> <td>OFF</td> <td>Low</td> </tr> <tr> <td>OFF</td> <td>ON</td> <td>Setting airflow</td> </tr> <tr> <td>ON</td> <td>ON</td> <td>Stop</td> </tr> </table>	SW1-7	SW1-8		OFF	OFF	Extra low	ON	OFF	Low	OFF	ON	Setting airflow	ON	ON	Stop
	SW1-7	SW1-8																			
	OFF	OFF	Extra low																		
	ON	OFF	Low																		
	OFF	ON	Setting airflow																		
	ON	ON	Stop																		
	2	Filter clogging detection	Provided	Not provided																	
	3	Filter cleaning	2,500 hr	100 hr																	
	4	Fresh air intake	Effective	Not effective																	
	5	Switching remote display	Thermo ON signal display	Indicating fan operation ON/OFF																	
6	Humidifier control	Always operated while the heat in ON※1	Operated depends on the condition ※2																		
7	Airflow set in case of Heat thermo OFF at heating mode	Low ※3	Extra low ※3																		
8		Setting air flow ※3	Depends on SW1-7																		
9	Auto restart function	Effective	Not effective																		
10	Power ON/OFF by breaker	Effective	Not effective																		
SW2 Capacity code setting	1~6	Capacity	SW 2	Capacity	SW 2	<div style="border: 1px solid black; padding: 2px;">Indoor controller board</div> <p>Set while the unit is off.</p> <p><Initial setting></p> <p>Set for each capacity.</p>															
		P15		P24																	
		P30		P36																	
SW3 Function setting	1	Heat pump/Cooling only	Cooling only	Heat pump	Under suspension	<div style="border: 1px solid black; padding: 2px;">Indoor controller board</div> <p>Set while the unit is off.</p> <p><Initial setting></p> <p>ON </p> <p>OFF </p> <p>Note :</p> <p>※4 SW3-5</p> <p>※5 Please do not use SW3-9 and SW3-10. <SW9 setting> P15: ON P24,P30,P36: OFF</p> <p>※6 Each angle can be used only 1 hour when fan speed setting Low and Middle 1,2</p>															
	2	Louver	Available	Not available																	
	3	Vane	Available	Not available																	
	4	Vane swing function in heating (wave-flow)	Available	Not available																	
	5	Vane horizontal angle	Second setting ※4	First setting ※4																	
	6	Vane cooling limit angle setting	Horizontal	Setting A,B,C,D																	
	7	Changing the opening of linear expansion valve	Effective	Not effective																	
	8	4-deg up (Heating mode)	Not effective	Effective																	
	9	Superheat setting temperature ※5	—	—																	
	10	Sub cool setting temperature ※5	—	—																	
SW4 Model Selection	1~5	In case of replacing the indoor controller board, make sure to set the switch to the initial setting, which is shown below.			Before power supply ON	<div style="border: 1px solid black; padding: 2px;">Indoor controller board</div>															
		ON 	OFF 																		

Note : ※4 SW3-5

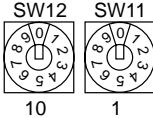
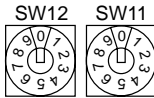
SW3-5	Vane setting	Initial setting	Setting	Vane position
OFF	Set up ①	●	Standard	Standard
ON	Set up ②		Less draft	Upward position than the standard

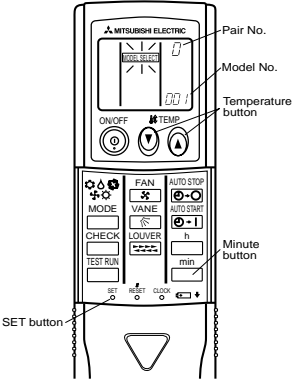
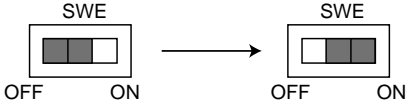

Switch	Pole	Operation by switch	Effective timing	Remarks																
SWA Ceiling height selector	1~3	<p>(High ceiling) 3</p> <p>(Standard) 2</p> <p>(Silent) 1</p>  <p>* Ceiling height can be changed depending on SWA setting.</p> <table border="1" data-bbox="523 466 1011 579"> <thead> <tr> <th>SWA</th> <th>①</th> <th>②</th> <th>③</th> </tr> <tr> <td></td> <td>Silent</td> <td>Standard</td> <td>High ceiling</td> </tr> </thead> <tbody> <tr> <td>P15, P24</td> <td>8.2ft.(2.5m)</td> <td>8.9ft.(2.7m)</td> <td>11.5ft.(3.5m)</td> </tr> <tr> <td>P30, P36</td> <td>8.5ft.(2.6m)</td> <td>9.8ft.(3.0m)</td> <td>13.8ft.(4.2m)</td> </tr> </tbody> </table>	SWA	①	②	③		Silent	Standard	High ceiling	P15, P24	8.2ft.(2.5m)	8.9ft.(2.7m)	11.5ft.(3.5m)	P30, P36	8.5ft.(2.6m)	9.8ft.(3.0m)	13.8ft.(4.2m)	Under operation or suspension	<p>Address board</p> <p><Initial setting></p> 
SWA	①	②	③																	
	Silent	Standard	High ceiling																	
P15, P24	8.2ft.(2.5m)	8.9ft.(2.7m)	11.5ft.(3.5m)																	
P30, P36	8.5ft.(2.6m)	9.8ft.(3.0m)	13.8ft.(4.2m)																	
SWC Option selector	2	<p>② オブ (Option)</p> <p>① 標 (Standard)</p>  <p>* In this model it is not necessary to change SWC to the option side.</p>		<p>Address board</p> <p><Initial setting></p> 																
SW11 1s digit address setting SW12 10ths digit address setting	Rotary switch	<p>SW12 SW11</p>  <p>How to set address Example : If address is "3", remain SW12 (for over 10) at "0", and match SW11 (for 1 to 9) with "3".</p>		<p>Address board</p> <p>Address can be set while the unit is stopped.</p> <p><Initial setting></p> 																
SW14 Branch No. setting	Rotary switch	<p>SW14</p>  <p>How to set branch number SW14 (Series R2 only) Match the indoor unit's refrigerant pipe with the BC controller's end connection number Remain other than series R2 at "0".</p>	Before power supply ON	<p>Address board</p> <p><Initial setting></p> 																

Switch	Pole	Operation by switch	Effective timing	Remarks																											
J41, J42 Wireless remote controller Pair No.	Jumper	<ul style="list-style-type: none"> To operate each indoor unit by each remote controller when installed 2 indoor units or more are near, Pair No. setting is necessary. ① Pair No. setting is available with the 4 patterns (Setting patterns A to D). ② Make setting for J41, J42 of indoor controller board and the Pair No. of wireless remote controller. You may not set it when operating it by 1 remote controller. ① Setting for indoor unit Jumper wire J41, J42 on the indoor controller board are cut according to the table below. ② Wireless remote controller pair number: Setting operation <ol style="list-style-type: none"> Press the SET button (using a pointed implement). Check that the remote controller's display has stopped before continuing. MODEL SELECT flashes, and the model No. (3 digits) appears (steadily-lit). Press the MINUTE button twice. The pair number appears flashing. Press the temperature (M) (A) buttons to select the pair number to set. Press the SET button (using a pointed implement). The set pair number is displayed (steadily-lit) for 3 seconds, then disappears. <table border="1" style="margin: 10px auto;"> <thead> <tr> <th rowspan="2">Setting pattern</th> <th colspan="2">Indoor controller Jumper wire</th> <th rowspan="2">Pair No. of wireless remote controller *</th> <th rowspan="2"></th> </tr> <tr> <th>J41</th> <th>J42</th> </tr> </thead> <tbody> <tr> <td>A</td> <td>—</td> <td>—</td> <td>0</td> <td>Factory setting</td> </tr> <tr> <td>B</td> <td>Cut</td> <td>—</td> <td>1</td> <td>—</td> </tr> <tr> <td>C</td> <td>—</td> <td>Cut</td> <td>2</td> <td>—</td> </tr> <tr> <td>D</td> <td>Cut</td> <td>Cut</td> <td>3</td> <td>—</td> </tr> </tbody> </table> <p>* Pair No.4-9 of wireless remote controller is setting pattern D.</p>	Setting pattern	Indoor controller Jumper wire		Pair No. of wireless remote controller *		J41	J42	A	—	—	0	Factory setting	B	Cut	—	1	—	C	—	Cut	2	—	D	Cut	Cut	3	—	Under operation or suspension	<p><Initial setting> Pattern A</p> 
Setting pattern	Indoor controller Jumper wire			Pair No. of wireless remote controller *																											
	J41	J42																													
A	—	—	0	Factory setting																											
B	Cut	—	1	—																											
C	—	Cut	2	—																											
D	Cut	Cut	3	—																											
SWE Test run for Drain pump (Option)	Connector	<p>Drain pump and fan are activated simultaneously after the connector SWE is set to ON and turn on the power.</p>  <p>The connector SWE is set to OFF after test run.</p>	Under operation	<p><Initial setting></p> 																											

8-3. TEST POINT DIAGRAM

8-3-1. Indoor controller board

PCFY-P15NKMU-E.TH
PCFY-P15NKMU-ER1.TH

PCFY-P24NKMU-E.TH
PCFY-P24NKMU-ER1.TH

PCFY-P30NKMU-E.TH
PCFY-P30NKMU-ER1.TH

PCFY-P36NKMU-E.TH
PCFY-P36NKMU-ER1.TH

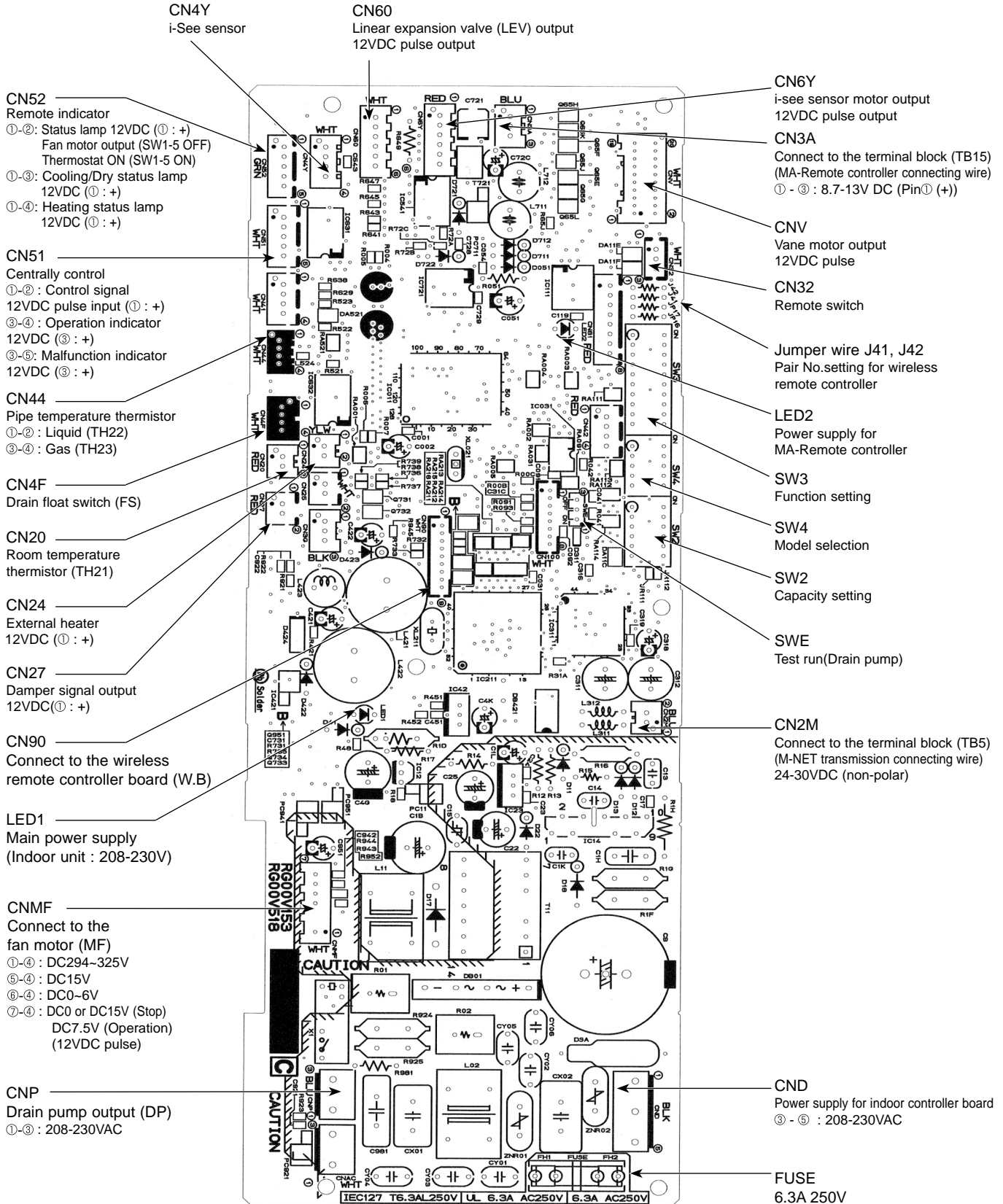

8-3-2. Address board

PCFY-P15NKMU-E.TH

PCFY-P24NKMU-E.TH

PCFY-P30NKMU-E.TH

PCFY-P36NKMU-E.TH

PCFY-P15NKMU-ER1.TH

PCFY-P24NKMU-ER1.TH

PCFY-P30NKMU-ER1.TH

PCFY-P36NKMU-ER1.TH

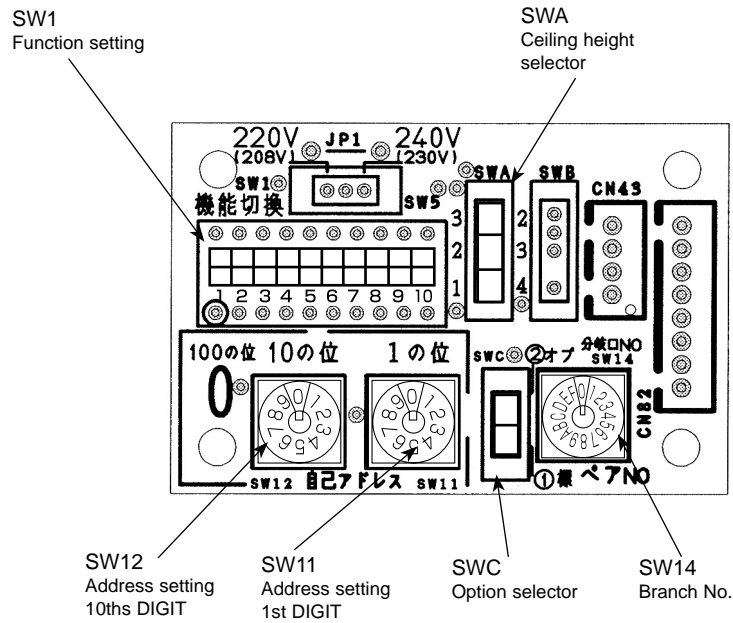

PCFY-P15NKMU-E.TH
 PCFY-P30NKMU-E.TH
 PCFY-P15NKMU-ER1.TH
 PCFY-P30NKMU-ER1.TH

PCFY-P24NKUM-E.TH
 PCFY-P36NKMU-E.TH
 PCFY-P24NKUM-ER1.TH
 PCFY-P36NKMU-ER1.TH

Be careful when removing heavy parts.

(Photo: PCFY-P36NKMU-E.TH)

OPERATING PROCEDURE

PHOTOS & ILLUSTRATIONS

1. Removing the air intake grille

- (1) Slide the air intake grille holding knobs (at 2 or 3 locations) to the rear to open the air intake grille. (See Figure 1)
- (2) While the air intake grille left open, push the stoppers on the rear hinges (at 2 or 3 locations) to pull out the air intake grille. (See Figure 2)

Figure 2

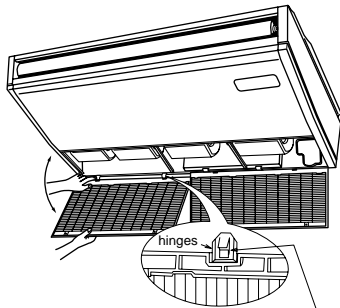

Pull out the air intake grille

Figure 1

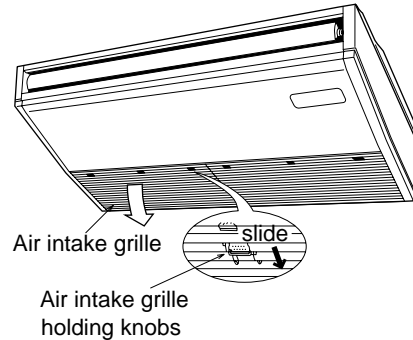

Air intake grille
 Air intake grille holding knobs

2. Removing the indoor controller board and the electrical box

- (1) Remove the air intake grille. (See Figure 1, 2)
- (2) Remove the screw from the beam and remove the beam. (See Photo 1)
- (3) Remove 2 screws from the electrical cover, and remove the electrical cover.
- (4) Remove 2 screws from the electrical box and pull the electrical box downward. Temporarily secure the electrical box using 2 hooks in the back of electrical box.
- (5) Disconnect the connectors on the indoor controller board.

[Removing the electrical box]

- (6) Disconnect the wires from the terminal blocks and pull out the electrical box. (See Photo 2)

[Removing the indoor controller board]

- (6) Remove the 6 supports from the indoor controller board and remove the indoor controller board. (See Photo 3)

Photo 1

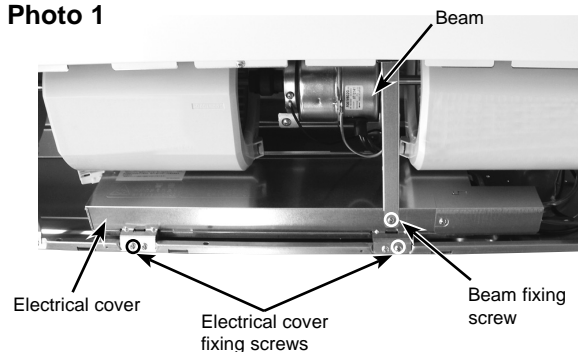

Photo 2

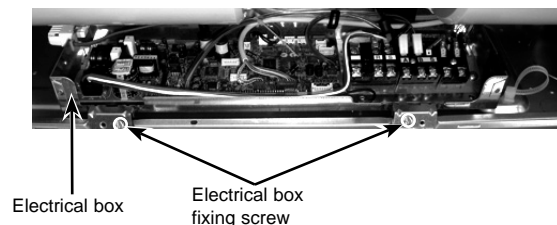
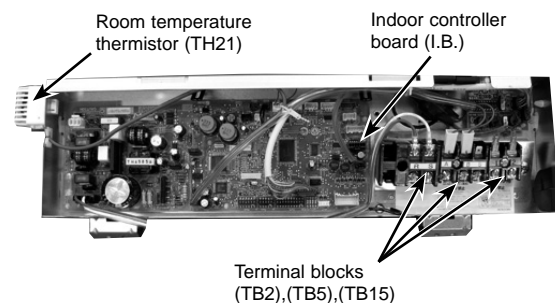

Photo 3



OPERATING PROCEDURE

3. Removing the room temperature thermistor (TH21)

- (1) Remove the air intake grille. (See Figure 1, 2)
- (2) Remove the screw from the beam and remove the beam. (See Photo 1)
- (3) Remove 2 screws from the electrical cover, and remove the electrical cover.
- (4) Remove 2 screws from the electrical box and pull the electrical box downward.
Temporarily secure the electrical box using 2 hooks in the back of electrical box.
- (5) Disconnect the connector CN20 (red) from the indoor controller board.
- (6) Remove the sensor holder from the electrical box and remove the thermistor from the holder.

4. Removing the fan motor and right side fan

- (1) Remove the air intake grille. (See Figure 1, 2)
- (2) Remove the screw from the beam and remove the beam. (See Photo 1)
- (3) Remove 2 screws from the electrical cover, and remove the electrical cover.
- (4) Remove 2 screws from the electrical box and pull the electrical box downward.
- (5) Temporarily secure the electrical box using 2 hooks in the back of electrical box.
- (6) Remove the lower casing while pressing the 4 catches of the casing (right side of the fan motor). (See Photo 6)
- (7) Loosen the 2 set screws (2 hexagon set screws) of connecting joint and slide the fan motor to the left. (See Photo 5)
- (8) Remove the screw for motor earth wire. (See Photo 5)
- (9) Remove the motor piece (left and right, each 1 screw). (See Photo 5)
- (10) Remove the fan motor and right side fan together.
- (11) Loosen the set screw (hexagon set screw) of fan and remove the fan from the shaft. (See Photo 7, 8)

Photo 8

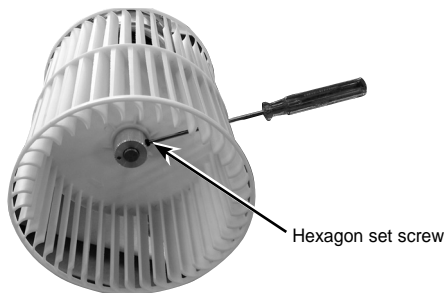

PHOTOS & ILLUSTRATIONS

Photo 4

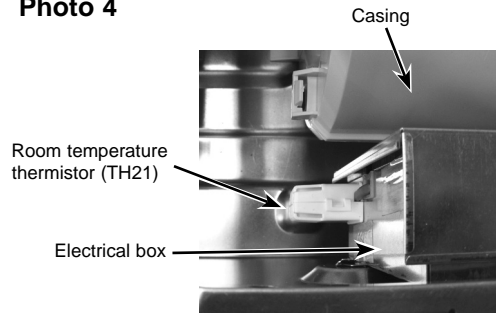

Photo 5

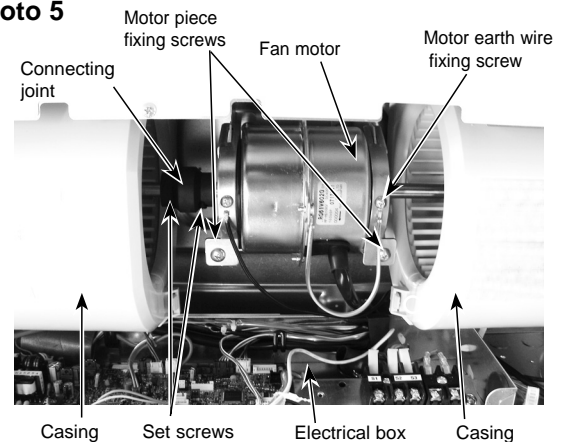

Photo 6

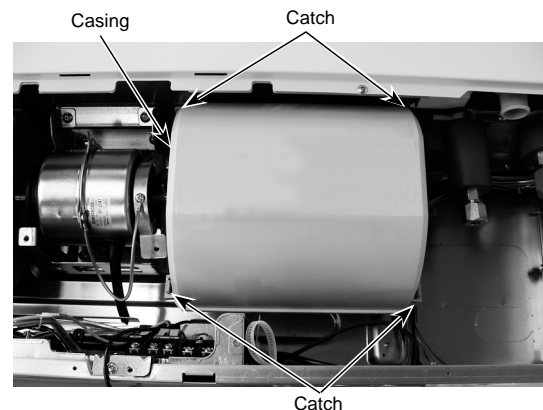
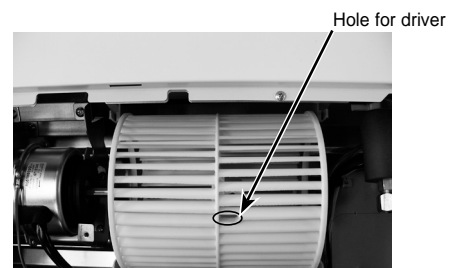

Photo 7



OPERATING PROCEDURE

PHOTOS & ILLUSTRATIONS

5. Removing the fan (3 connection)

- (1) Remove the air intake grille. (See Figure 1, 2)
- (2) Remove the screw from the beam and remove the beam. (See Photo 1)
- (3) Remove 2 screws from the electrical cover, and remove the electrical cover.
- (4) Remove 2 screws from the electrical box and pull the electrical box downward. Temporarily secure the electrical box using 2 hooks in the back of electrical box.
- (5) Remove 2 screws from the left side beam and remove the beam. (See Photo 9)
- (6) Loosen 2 set screws (2 hexagon set screws) of connecting joint. (See Photo 5)
- (7) Remove 3 lower casings while pressing each 4 catches of the casing. (See Photo 6)
- (8) Remove the 4 screws from the bearing support. (See Photo 10)
- (9) Slide the connecting joint to the left and remove the fans and shaft together. (See Photo 11)
- (10) Remove the fan from the shaft. (See Photo 7, 8)

Photo 9

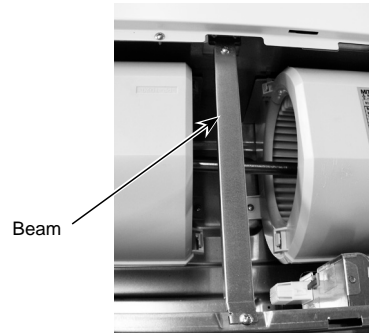

Photo 10

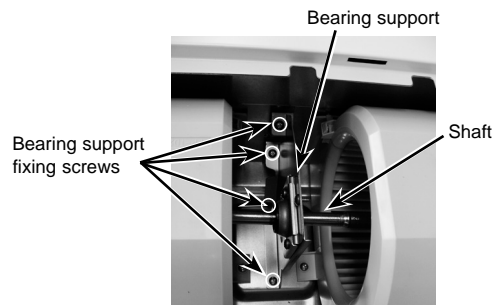
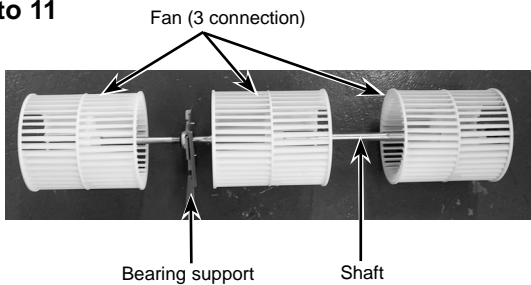

Photo 11



6. Removing the side panel

- (1) Remove the air intake grille. (See Figure 1, 2)
- (2) Remove the screw from the side panel, and remove the side panel by sliding the panel to the front.
- (3) Unhook the side panel support hanger, and then slide the side panel forward to remove it.

Figure 3

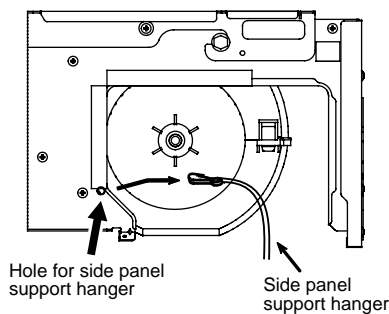
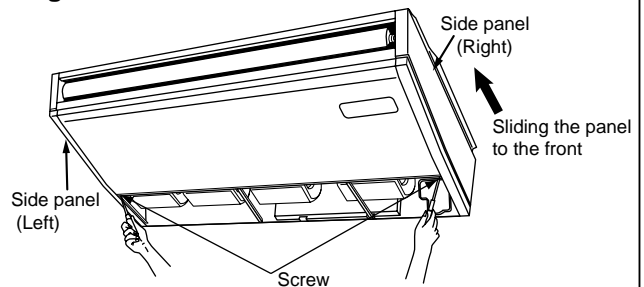

OPERATING PROCEDURE

7. Removing the vane motor

- (1) Remove the air intake. (See Figure 1, 2)
- (2) Remove the right side panel. (See Figure 3)
- (3) Remove the connector of vane motor.
- (4) Remove 2 screws of vane motor cover , then remove vane motor.

8. Removing the under panel

- (1) Remove the air intake grille. (See Figure 1, 2)
- (2) Remove the left and right side panels. (See Figure 3)
- (3) Remove the beam. (See Photo 1)
- (4) Remove the electrical cover. (See Photo 1)
- (5) Pull the electrical box downward. (See Photo 2)
- (6) (Wireless remote controller receiver type only)
Disconnect the connector CNB from the PCB for wireless remote controller and remove the clamp and strap for wires.
- (7) Remove 8 screws from the under panel.
- (8) Move the under panel forward by about 7/16 in. (10mm) and remove the under panel.

9. Removing the drain pan

- (1) Remove the air intake grille. (See Figure 1, 2)
- (2) Remove the side panel (right and left). (See Figure 3)
- (3) Remove the under panel. (See Photo 13)
Remove the screws of the right and left side drain pan. (See Photo 14)
- (4) Remove 2 insulation in centre of the drain pan, and after removing 2 screws with washer, remove the drain pan. (See Photo 15, 16)

(Note)

Please be aware that there might be some drainage left in the drain pan when you remove the drain pan.

Photo 16

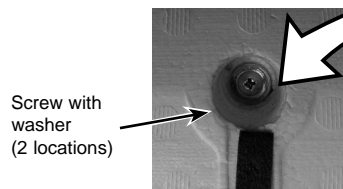

PHOTOS & ILLUSTRATIONS

Photo 12

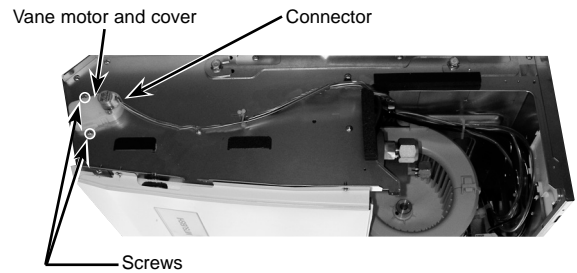

Photo 13

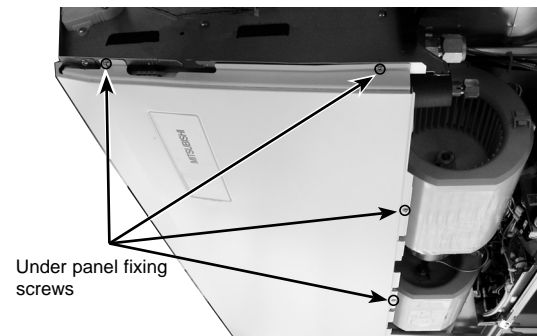

Photo 14

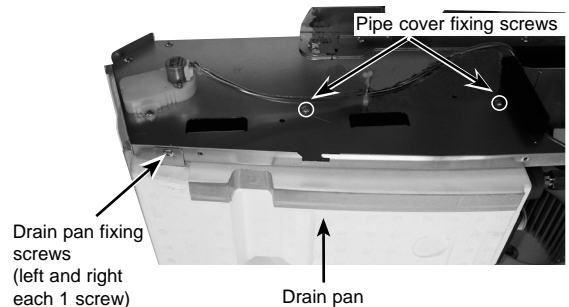
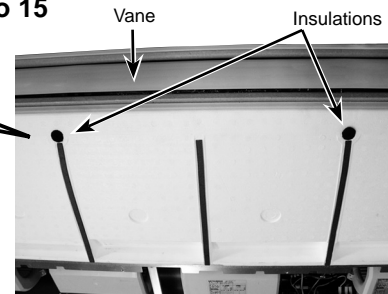

Photo 15



OPERATING PROCEDURE

PHOTOS & ILLUSTRATIONS

10. Removing the pipe thermistors/Liquid (TH22) and Gas (TH23)

- (1) Remove the air intake grille. (See Figure 1, 2)
- (2) Remove the left and right side panels. (See Figure 3)
- (3) Remove the under panel. (See Photo 13)
- (4) Remove the drain pan. (See Photo 14, 15, 16)
- (5) Disconnect the connector CN44 (white) from the indoor controller board.
- (6) Remove 6 screws from the pipe cover and remove the pipe cover. (See Photo 14, 17)
- (7) Remove the fastener for wires and remove the thermistors (liquid and gas) from each holder. (See Photo 18)

Photo 17

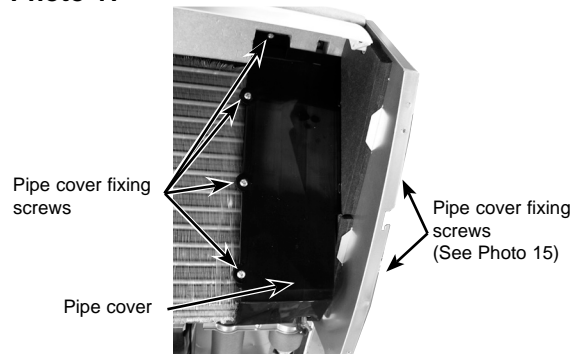
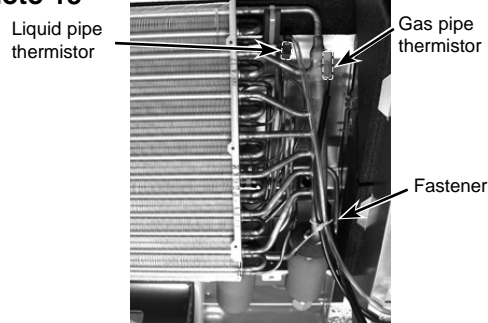

Photo 18



11. Removing the guide vane

- (1) Remove the intake grille. (See Figure 1, 2)
- (2) Remove the side panel (right and left). (See Figure 3)
- (3) Remove the under panel. (See Photo 13)
- (4) Remove the drain pan. (See Photo 14, 15, 16)
- (5) Remove the screw from the guide vane, then remove the guide vane.

Photo 19

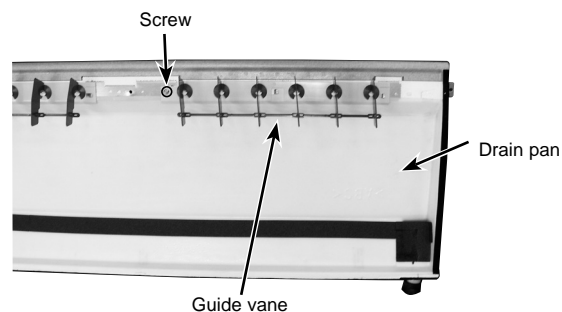

12. Removing the Auto vane

- (1) Remove the intake grille. (See Figure 1, 2)
- (2) Remove the right side panel. (See Figure 3)
- (3) Remove the vane motor and cover. (See Photo 12)
- (4) Slide the auto vane to the vane motor side.
- (5) Remove 2 axes from each vane support pushing the vane support to the vane sleeve side.

Photo 20

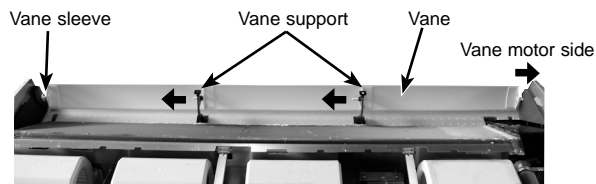

OPERATING PROCEDURE

13. Removing the heat exchanger and LEV

- (1) Remove the air intake grille. (See Figure 1, 2)
- (2) Remove the beam. (See Photo 1)
- (3) Remove the electrical cover. (See Photo 1)
- (4) Pull the electrical box downward. (See Photo 2)
- (5) Disconnect the connector CN60 (white) from the indoor controller board.
- (6) Remove the left and right side panels. (See Figure 3)
- (7) Remove the under panel. (See Photo 13)
- (8) Remove the drain pan. (See Photo 14, 15, 16)
- (9) Remove the pipe cover. (See Photo 17)
- (10) Remove the pipe thermistors (TH22 and TH23) from each holder. (See Photo 18)
- (11) Remove the pipe band fixing screw and remove the pipe band. (See Photo 21)
- (12) Remove 3 screws from the heat exchanger and remove the heat exchanger with LEV.

PHOTOS & ILLUSTRATIONS

Photo 21

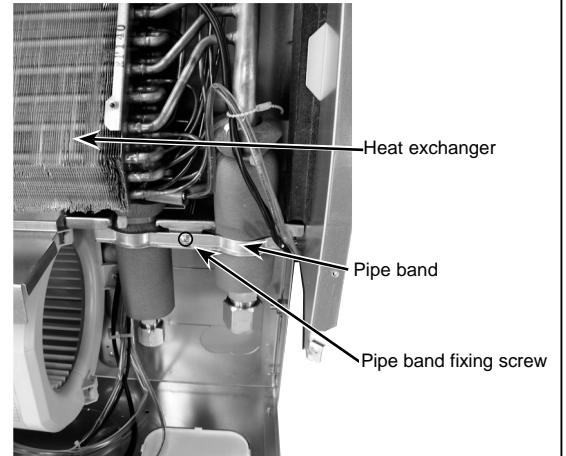
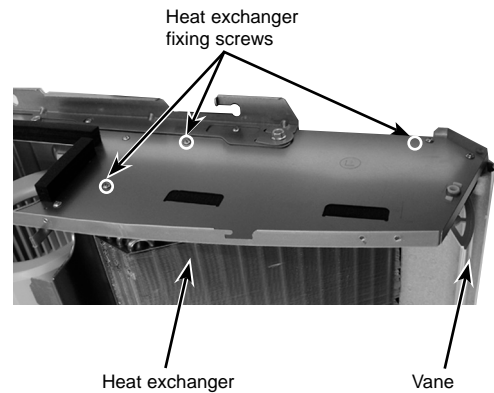

Photo 22



CITY MULTI™

MITSUBISHI ELECTRIC CORPORATION

HEAD OFFICE : TOKYO BLDG., 2-7-3, MARUNOUCHI, CHIYODA-KU TOKYO 100-8310, JAPAN
