

# SERVICE MANUAL

## Series PCA Ceiling Suspended R410A

Indoor unit [Model Name]	[Service Ref.]
PCA-A24KA7	<b>PCA-A24KA7.TH</b>
PCA-A30KA7	<b>PCA-A30KA7.TH</b>
PCA-A36KA7	<b>PCA-A36KA7.TH</b>
PCA-A42KA7	<b>PCA-A42KA7.TH</b>

Notes:

- This manual describes only service data of the indoor units.
- RoHS compliant products have <G> mark on the spec name plate.

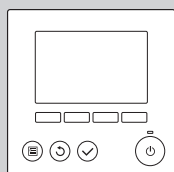
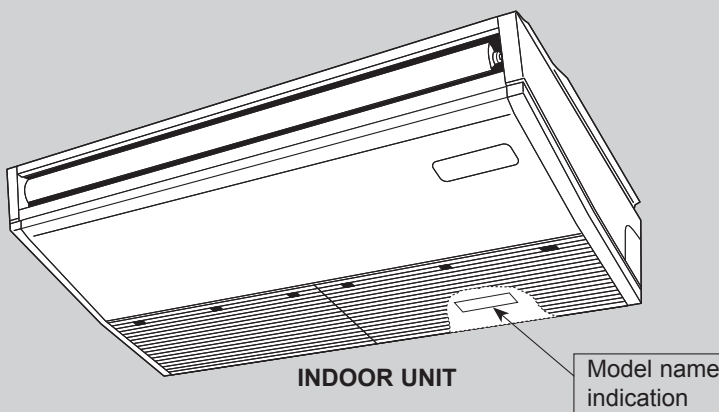

WIRED REMOTE  
CONTROLLER  
(Option)

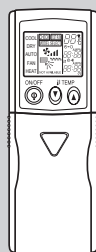

IR WIRELESS REMOTE  
CONTROLLER (Option)

### CONTENTS

1. REFERENCE MANUAL.....	2
2. SAFETY PRECAUTION.....	3
3. PARTS NAMES AND FUNCTIONS.....	5
4. SPECIFICATIONS.....	10
5. NOISE CRITERION CURVES.....	12
6. OUTLINES AND DIMENSIONS.....	13
7. WIRING DIAGRAM.....	15
8. REFRIGERANT SYSTEM DIAGRAM.....	16
9. TROUBLESHOOTING.....	17
10. FUNCTION SETTING.....	31
11. SPECIAL FUNCTION.....	32
12. DISASSEMBLY PROCEDURE.....	36

### PARTS CATALOG (OCB638)



## OUTDOOR UNIT SERVICE MANUAL

Model Name	Service Ref.	Service Manual No.
PUZ-A24/30NHA7 PUZ-A36/42NKA7 PUZ-A24/30NHA7-BS PUZ-A36/42NKA7-BS	PUZ-A24/30NHA7 PUZ-A36/42NKA7 PUZ-A24/30NHA7-BS PUZ-A36/42NKA7-BS	OCH636 OCB636
PUY-A24/30NHA7 PUY-A36/42NKA7 PUY-A24/30NHA7-BS PUY-A36/42NKA7-BS	PUY-A24/30NHA7 PUY-A36/42NKA7 PUY-A24/30NHA7-BS PUY-A36/42NKA7-BS	
PUZ-HA30/36NHA5	PUZ-HA30/36NHA5	OCH607/OCB607
PUZ-HA42NKA	PUZ-HA42NKA	OCH567/OCB567
MXZ-3C24NAHZ2	MXZ-3C24NAHZ2 - [U1]	OBH702 OBB702
MXZ-4C36NA2 MXZ-5C42NA2	MXZ-4C36NA2 - [U1] MXZ-5C42NA2 - [U1]	
MXZ-3C30NAHZ2	MXZ-3C30NAHZ2 - [U1]	

■ Remote controller (Optional parts)

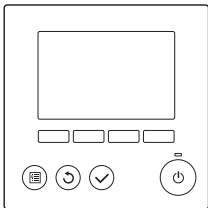
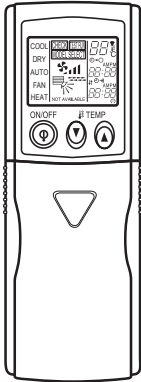
Wired remote controller	IR wireless remote controller
	

## 2-1. ALWAYS OBSERVE FOR SAFETY

Before obtaining access to terminal, all supply circuits must be disconnected.

## 2-2. CAUTIONS RELATED TO NEW REFRIGERANT

Caution for units utilising refrigerant R410A

**Use new refrigerant pipes.**

**Make sure that the inside and outside of refrigerant piping is clean and it has no contaminants such as sulfur, oxides, dirt, shaving particles, etc, which are hazards to refrigerant cycle. In addition, use pipes with specified thickness.**

Contamination inside refrigerant piping can cause deterioration of refrigerant oil, etc.

**Store the piping indoors, and both ends of the piping sealed until just before brazing. (Leave elbow joints, etc. in their packaging.)**

If dirt, dust or moisture enters into refrigerant cycle, that can cause deterioration of refrigerant oil or malfunction of compressor.

**The refrigerant oil applied to flare and flange connections must be ester oil, ether oil or alkylbenzene oil in a small amount.**

If large amount of mineral oil enters, that can cause deterioration of refrigerant oil, etc.

**Charge refrigerant from liquid phase of gas cylinder.**

If the refrigerant is charged from gas phase, composition change may occur in refrigerant and the efficiency will be lowered.

**Do not use refrigerant other than R410A.**

If other refrigerant (R22, etc.) is used, chlorine in refrigerant can cause deterioration of refrigerant oil, etc.

**Use a vacuum pump with a reverse flow check valve.**

Vacuum pump oil may flow back into refrigerant cycle and that can cause deterioration of refrigerant oil, etc.

**Use the following tools specifically designed for use with R410A refrigerant.**

The following tools are necessary to use R410A refrigerant.

Tools for R410A	
Gauge manifold	Flare tool
Charge hose	Size adjustment gauge
Gas leak detector	Vacuum pump adaptor
Torque wrench	Electronic refrigerant charging scale

**Handle tools with care.**

If dirt, dust or moisture enters into refrigerant cycle, that can cause deterioration of refrigerant oil or malfunction of compressor.

**Do not use a charging cylinder.**

If a charging cylinder is used, the composition of refrigerant will change and the efficiency will be lowered.

**Ventilate the room if refrigerant leaks during operation. If refrigerant comes into contact with a flame, poisonous gases will be released.**

**Use the specified refrigerant only.**

**Never use any refrigerant other than that specified.** Doing so may cause a burst, an explosion, or fire when the unit is being used, serviced, or disposed of. Correct refrigerant is specified in the manuals and on the spec labels provided with our products. We will not be held responsible for mechanical failure, system malfunction, unit breakdown or accidents caused by failure to follow the instructions.

## [1] Cautions for service

- (1) Perform service after recovering the refrigerant left in unit completely.
- (2) Do not release refrigerant in the air.
- (3) After completing service, charge the cycle with specified amount of refrigerant.
- (4) If moisture or foreign matter might have entered the refrigerant piping during service, ensure to remove them.

## [2] Additional refrigerant charge

### When charging directly from cylinder

- (1) Check that cylinder for R410A on the market is a syphon type.
- (2) Charging should be performed with the cylinder of syphon stood vertically. (Refrigerant is charged from liquid phase.)

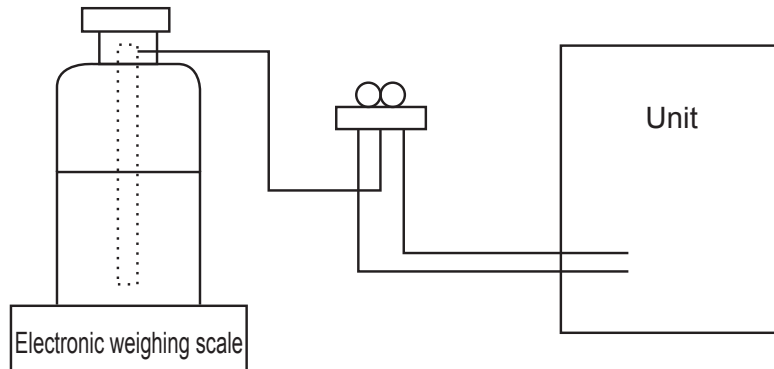

## [3] Service tools

Use the below service tools as exclusive tools for R410A refrigerant.

No.	Tool name	Specifications
①	Gauge manifold	<ul style="list-style-type: none"> <li>· Only for R410A</li> <li>· Use the existing fitting specifications. (UNF1/2)</li> <li>· Use high-tension side pressure of 768.7 PSIG [5.3 MPa.G] or over.</li> </ul>
②	Charge hose	<ul style="list-style-type: none"> <li>· Only for R410A</li> <li>· Use pressure performance of 738.2 PSIG [5.09MPa.G] or over.</li> </ul>
③	Electronic scale	—
④	Gas leak detector	· Use the detector for R134a, R407C or R410A.
⑤	Adaptor for reverse flow check	· Attach on vacuum pump.
⑥	Refrigerant charge base	—
⑦	Refrigerant cylinder	<ul style="list-style-type: none"> <li>· Only for R410A</li> <li>· Top of cylinder (Pink)</li> <li>· Cylinder with syphon</li> </ul>
⑧	Refrigerant recovery equipment	—

# 3

# PARTS NAMES AND FUNCTIONS

## 3-1. Indoor Unit

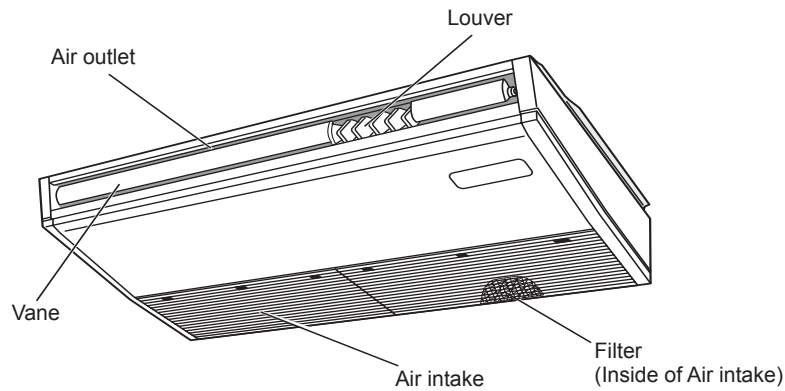

## 3-2. Wired remote controller (Option)

### Controller interface

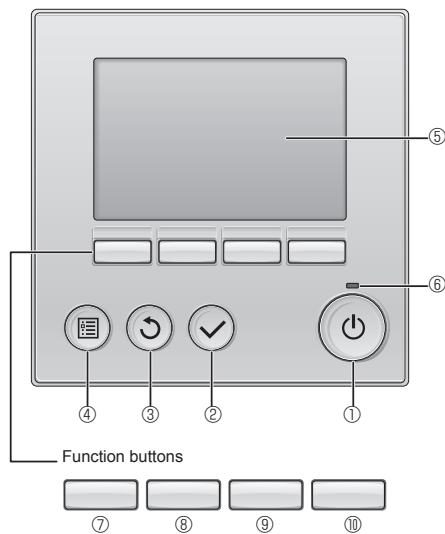

The functions of the function buttons change depending on the screen.

Refer to the button function guide that appears at the bottom of the LCD for the functions they serve on a given screen.

When the system is centrally controlled, the button function guide that corresponds to the locked button will not appear.

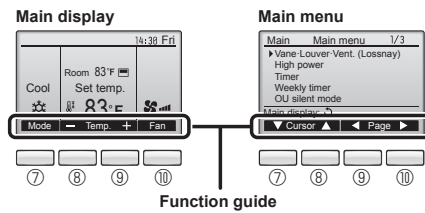

- ① [ON/OFF] button**  
Press to turn ON/OFF the indoor unit.
  - ② [SELECT] button**  
Press to save the setting.
  - ③ [RETURN] button**  
Press to return to the previous screen.
  - ④ [MENU] button**  
Press to bring up the Main menu.
  - ⑤ Backlit LCD**  
Operation settings will appear.  
When the backlight is off, pressing any button turns the backlight on and it will stay lit for a certain period of time depending on the screen.
- When the backlight is off, pressing any button turns the backlight on and does not perform its function. (except for the [ON/OFF] button)

- ⑥ ON/OFF lamp**  
This lamp lights up in green while the unit is in operation. It blinks while the remote controller is starting up or when there is an error.
- ⑦ Function button [F1]**  
Main display: Press to change the operation mode.  
Main menu: Press to move the cursor down.
- ⑧ Function button [F2]**  
Main display: Press to decrease temperature.  
Main menu: Press to move the cursor up.
- ⑨ Function button [F3]**  
Main display: Press to increase temperature.  
Main menu: Press to go to the previous page.
- ⑩ Function button [F4]**  
Main display: Press to change the fan speed.  
Main menu: Press to go to the next page.

## Display

The main display can be displayed in 2 different modes: "Full" and "Basic". The initial setting is "Full". To switch to the "Basic" mode, change the setting on the Main display setting. (Refer to operation manual included with remote controller.)

<Full mode>

\* All icons are displayed for explanation.

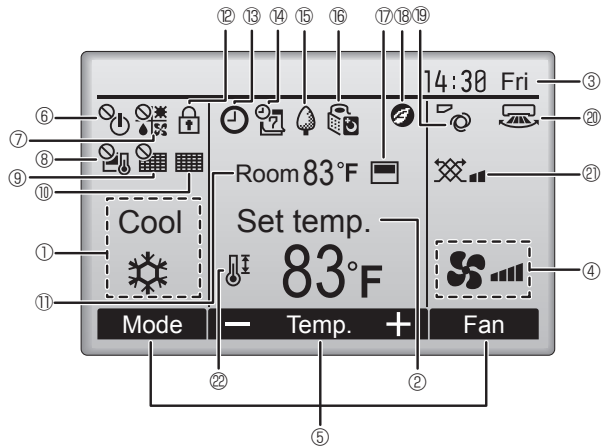

<Basic mode>

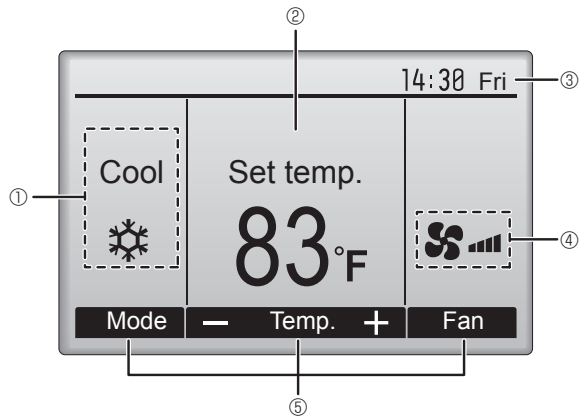

### ① Operation mode

Indoor unit operation mode appears here.

### ② Preset temperature

Preset temperature appears here.

### ③ Clock (See the Installation Manual.)

Current time appears here.

### ④ Fan speed

Fan speed setting appears here.

### ⑤ Button function guide

Functions of the corresponding buttons appear here.



Appears when the ON/OFF operation is centrally controlled.



Appears when the operation mode is centrally controlled.



Appears when the preset temperature is centrally controlled.



Appears when the filter reset function is centrally controlled.



Appears when filter needs maintenance.

### ⑪ Room temperature (See the Installation Manual.)

Current room temperature appears here.



Appears when the buttons are locked.



Appears when the ON/OFF timer, Night setback, or Auto-OFF timer function is enabled.



Appears when the timer is disabled by the centralized control system.



Appears when the Weekly timer is enabled.



Appears while the units are operated in the energy-save mode. (Will not appear on some models of indoor units)



Appears while the outdoor units are operated in the silent mode.



Appears when the built-in thermistor on the remote controller is activated to monitor the room temperature (⑪).



Appears when the thermistor on the indoor unit is activated to monitor the room temperature.



Appears when the units are operated in the energy-save mode with 3D i-see Sensor.



Indicates the vane setting.



Indicates the louver setting. (This indication is not available for this model.)



Indicates the ventilation setting.



Appears when the preset temperature range is restricted.

Most settings (except ON/OFF, mode, fan speed, temperature) can be made from the Menu screen. (Refer to operation manual included with remote controller.)

## Menu structure

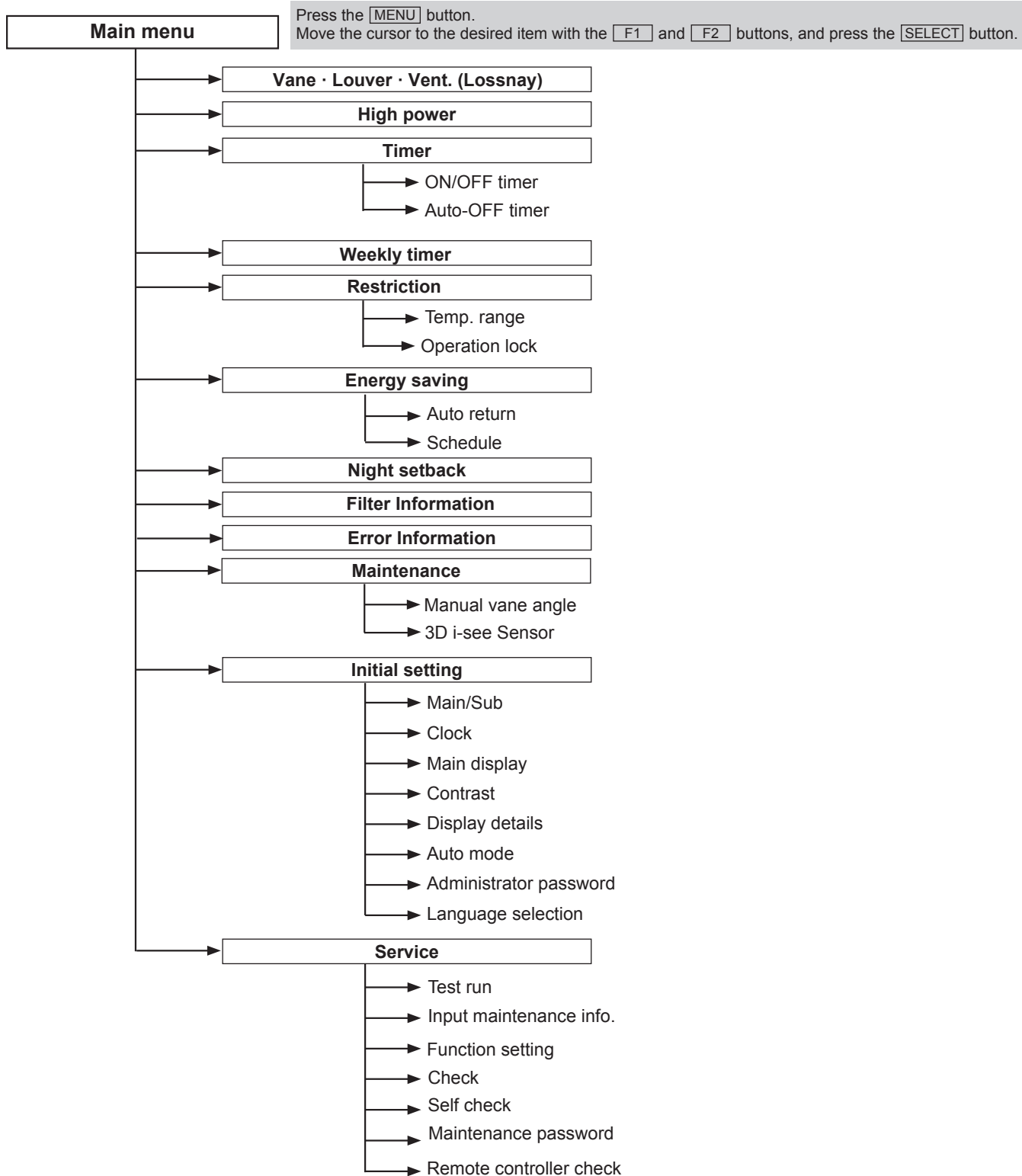

**Not all functions are available on all models of indoor units.**

## Main menu list

Setting and display items		Setting details
Vane · Louver · Vent. (Lossnay)		<p><b>Use to set the vane angle.</b></p> <ul style="list-style-type: none"> <li>Select a desired vane setting from 5 different settings.</li> </ul> <p><b>Use to turn ON/OFF the louver.</b></p> <ul style="list-style-type: none"> <li>Select a desired setting from "ON" and "OFF."</li> </ul> <p><b>Use to set the amount of ventilation.</b></p> <ul style="list-style-type: none"> <li>Select a desired setting from "Off," "Low," and "High."</li> </ul>
High power**		<p><b>Use to reach the comfortable room temperature quickly.</b></p> <ul style="list-style-type: none"> <li>Units can be operated in the High-power mode for up to 30 minutes.</li> </ul>
Timer	ON/OFF timer*	<p><b>Use to set the operation ON/OFF times.</b></p> <ul style="list-style-type: none"> <li>Time can be set in 5-minute increments.</li> </ul>
	Auto-OFF timer	<p><b>Use to set the Auto-OFF time.</b></p> <ul style="list-style-type: none"> <li>Time can be set to a value from 30 to 240 in 10-minute increments.</li> </ul>
Weekly timer*		<p><b>Use to set the weekly operation ON/OFF times.</b></p> <ul style="list-style-type: none"> <li>Up to 8 operation patterns can be set for each day. (Not valid when the ON/OFF timer is enabled.)</li> </ul>
Restriction	Temp. range	<p><b>Use to restrict the preset temperature range.</b></p> <ul style="list-style-type: none"> <li>Different temperature ranges can be set for different operation modes.</li> </ul>
	Operation lock	<p><b>Use to lock selected functions.</b></p> <ul style="list-style-type: none"> <li>The locked functions cannot be operated.</li> </ul>
Energy saving	Auto return	<p><b>Use to get the units to operate at the preset temperature after performing energy-save operation for a specified time period.</b></p> <ul style="list-style-type: none"> <li>Time can be set to a value from 30 and 120 in 10-minute increments.</li> <li>(This function will not be valid when the preset temperature ranges are restricted.)</li> </ul>
	Schedule*	<p><b>Set the start/stop times to operate the units in the energy-save mode for each day of the week, and set the energy-saving rate.</b></p> <ul style="list-style-type: none"> <li>Up to 4 energy-save operation patterns can be set for each day.</li> <li>Time can be set in 5-minute increments.</li> <li>Energy-saving rate can be set to a value from 0% or 50 to 90% in 10% increments.</li> </ul>
Night setback*		<p><b>Use to make Night setback settings.</b></p> <ul style="list-style-type: none"> <li>Select "Yes" to enable the setting, and "No" to disable the setting. The temperature range and the start/stop times can be set.</li> </ul>
Filter information		<p><b>Use to check the filter status.</b></p> <ul style="list-style-type: none"> <li>The filter sign can be reset.</li> </ul>
Error information		<p><b>Use to check error information when an error occurs.</b></p> <ul style="list-style-type: none"> <li>Check code, error source, refrigerant address, unit model, manufacturing number, contact information (dealer's phone number) can be displayed.</li> <li>(The unit model, manufacturing number, and contact information need to be registered in advance to be displayed.)</li> </ul>
Maintenance	Manual vane angle**	<p><b>Use to set the vane angle for each vane to a fixed position.</b></p>
	3D i-see Sensor	<p><b>Use to set the following functions for 3D i-see Sensor.</b></p> <ul style="list-style-type: none"> <li>Air distribution</li> <li>Energy saving option</li> <li>Seasonal airflow</li> </ul>
Initial setting	Main/Sub	<p><b>When connecting 2 remote controllers, one of them needs to be designated as a sub controller.</b></p>
	Clock	<p><b>Use to set the current time.</b></p>
	Main display	<p><b>Use to switch between "Full" and "Basic" modes for the Main display.</b></p> <ul style="list-style-type: none"> <li>The initial setting is "Full."</li> </ul>
	Contrast	<p><b>Use to adjust screen contrast.</b></p>
	Display details	<p><b>Make the settings for the remote controller related items as necessary.</b></p> <p><b>Clock:</b> The initial settings are "Yes" and "24h" format.</p> <p><b>Temperature:</b> Set either Celsius (°C) or Fahrenheit (°F).</p> <p><b>Room temp. :</b> Set Show or Hide.</p> <p><b>Auto mode:</b> Set the Auto mode display or Only Auto display.</p>
	Auto mode	<p><b>Whether or not to use the Auto mode can be selected by using the button.</b></p> <p><b>This setting is valid only when indoor units with the Auto mode function are connected.</b></p>
	Administrator password	<p><b>The administrator password is required to make the settings for the following items.</b></p> <ul style="list-style-type: none"> <li>Timer setting</li> <li>Energy-save setting</li> <li>Weekly timer setting</li> <li>Restriction setting</li> <li>Outdoor unit silent mode setting</li> <li>Night set back</li> </ul>
	Language selection	<p><b>Use to select the desired language.</b></p>
Service	Test run	<p><b>Select "Test run" from the Service menu to bring up the Test run menu.</b></p> <ul style="list-style-type: none"> <li>Test run</li> <li>Drain pump test run</li> </ul>
	Input maintenance	<p><b>Select "Input maintenance Info." from the Service menu to bring up the Maintenance information screen.</b></p> <p><b>The following settings can be made from the Maintenance Information screen.</b></p> <ul style="list-style-type: none"> <li>Model name input</li> <li>Serial No. input</li> <li>Dealer information input</li> </ul>
	Function setting	<p><b>Make the settings for the indoor unit functions via the remote controller as necessary.</b></p>
	Check	<p><b>Error history:</b> Display the error history and execute "delete error history".</p> <p><b>Refrigerant leak check:</b> Refrigerant leaks can be judged.</p> <p><b>Smooth maintenance:</b> The indoor and outdoor maintenance data can be displayed.</p> <p><b>Request code:</b> Details of the operation data including each thermistor temperature and error history can be checked.</p>
	Self check	<p><b>Error history of each unit can be checked via the remote controller.</b></p>
	Maintenance password	<p><b>Use to change the maintenance password.</b></p>
Remote controller check	<p><b>When the remote controller does not work properly, use the remote controller checking function to trouble-shoot the problem.</b></p>	

\* Clock setting is required.

\*\* The function is not available for MXZ model.

### 3-3. IR wireless remote controller (Option)

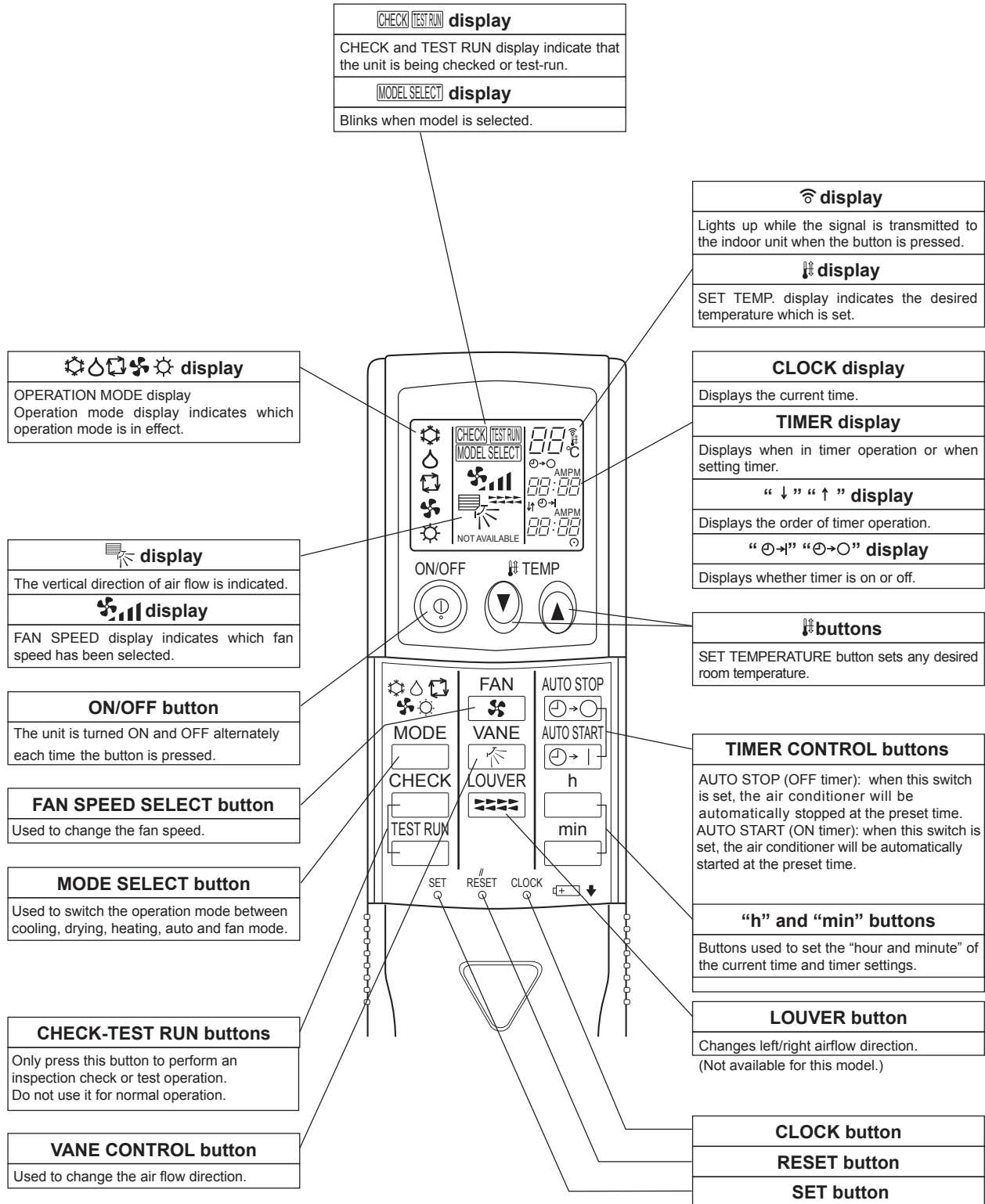

# 4

# SPECIFICATIONS

Service Ref.			PCA-A24KA7.TH
Power supply(phase, cycle, voltage)			1 phase, 60 Hz, 208/230 V
Max. Fuse Size			15
Min.Circuit Ampacity			1
External finish			White Munsell 6.4Y 8.9/0.4
Heat exchanger			Plate fin coil
INDOOR UNIT	Fan		Sirocco fan (direct) × 3
	Fan(drive) × No.		
	Fan motor output		kW
	Fan motor		F.L.A
	Airflow(Low-Medium2-Medium1-High)		CFM (m³/min)
External static pressure			Pa (mmAq)
Operation control & Thermostat			Remote controller & built-in
Noise level(Low-Medium2-Medium1-High)			dB
Field drain pipe O.D.			inch (mm)
Dimensions	W	inch (mm)	50-3/8 (1,280)
	D	inch (mm)	26-3/4 (680)
	H	inch (mm)	9-1/16 (230)
Weight			lb (kg)

Service Ref.			PCA-A30KA7.TH
Power supply(phase, cycle, voltage)			1 phase, 60 Hz, 208/230 V
Max. Fuse Size			15
Min.Circuit Ampacity			1
External finish			White Munsell 6.4Y 8.9/0.4
Heat exchanger			Plate fin coil
INDOOR UNIT	Fan		Sirocco fan (direct) × 3
	Fan(drive) × No.		
	Fan motor output		kW
	Fan motor		F.L.A
	Airflow(Low-Medium2-Medium1-High)		CFM (m³/min)
External static pressure			Pa (mmAq)
Operation control & Thermostat			Remote controller & built-in
Noise level(Low-Medium2-Medium1-High)			dB
Field drain pipe O.D.			inch (mm)
Dimensions	W	inch (mm)	50-3/8 (1,280)
	D	inch (mm)	26-3/4 (680)
	H	inch (mm)	9-1/16 (230)
Weight			lb (kg)

Service Ref.			PCA-A36KA7.TH
Power supply(phase, cycle, voltage)			1 phase, 60 Hz, 208/230 V
Max. Fuse Size			15
Min.Circuit Ampacity			2
External finish			White Munsell 6.4Y 8.9/0.4
Heat exchanger			Plate fin coil
INDOOR UNIT	Fan		Sirocco fan (direct) × 4
	Fan(drive) × No.		
	Fan motor output		kW
	Fan motor		F.L.A
	Airflow(Low-Medium2-Medium1-High)		CFM (m³/min)
External static pressure			Pa (mmAq)
Operation control & Thermostat			Remote controller & built-in
Noise level(Low-Medium2-Medium1-High)			dB
Field drain pipe O.D.			inch (mm)
Dimensions	W	inch (mm)	63 (1,600)
	D	inch (mm)	26-3/4 (680)
	H	inch (mm)	9-1/16 (230)
Weight			lb (kg)

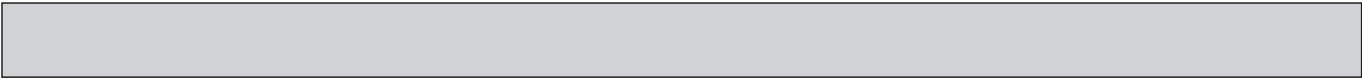

Service Ref.			PCA-A42KA7.TH
INDOOR UNIT	Power supply(phase, cycle, voltage)		1 phase, 60 Hz, 208/230 V
	Max. Fuse Size	A	15
	Min.Circuit Ampacity	A	2
	External finish		White Munsell 6.4Y 8.9/0.4
	Heat exchanger		Plate fin coil
	Fan	Fan(drive) × No.	Sirocco fan (direct) × 4
		Fan motor output	kW 0.160
		Fan motor	F.L.A 0.97
		Airflow(Low-Medium2-Medium1-High)	CFM (m³/min) Dry: 810-885-955-1025 (23-25-27-29) Wet: 740-810-885-955 (21-23-25-27)
		External static pressure	Pa (mmAq) 0 (direct blow)
	Operation control & Thermostat		Remote controller & built-in
	Noise level(Low-Medium2-Medium1-High)		dB 39-41-43-45
	Field drain pipe O.D.		inch (mm) 1-1/32 (26)
	Dimensions	W	inch (mm) 63 (1,600)
		D	inch (mm) 26-3/4 (680)
H		inch (mm) 9-1/16 (230)	
Weight		lb (kg) 86 (39)	

PCA-A24KA7.TH

NOTCH	SPL(dB)	LINE
High	40	○—○
Medium1	37	△—△
Medium2	35	●—●
Low	33	▲—▲

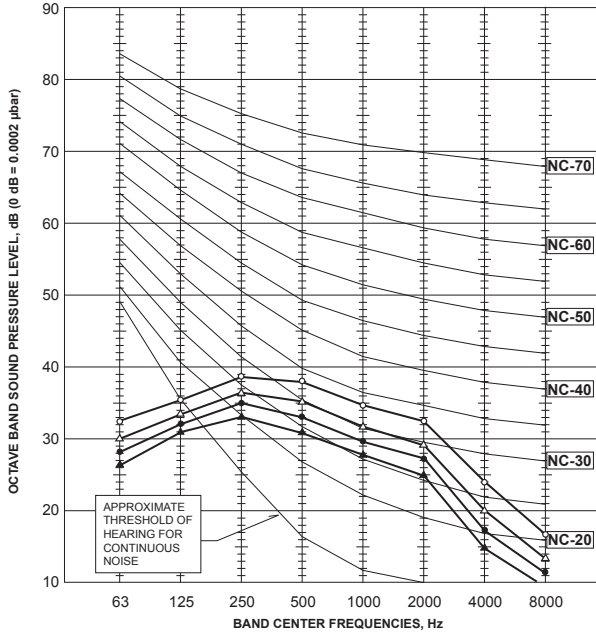

PCA-A30KA7.TH

NOTCH	SPL(dB)	LINE
High	41	○—○
Medium1	39	△—△
Medium2	37	●—●
Low	35	▲—▲

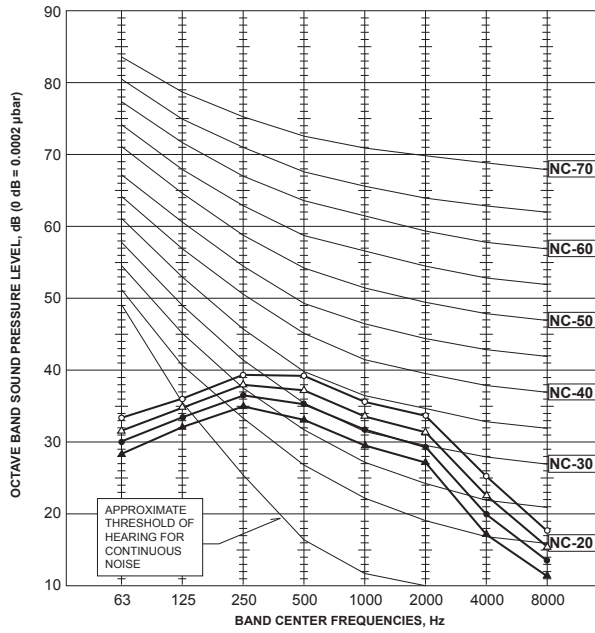

PCA-A36KA7.TH

NOTCH	SPL(dB)	LINE
High	43	○—○
Medium1	41	△—△
Medium2	39	●—●
Low	37	▲—▲

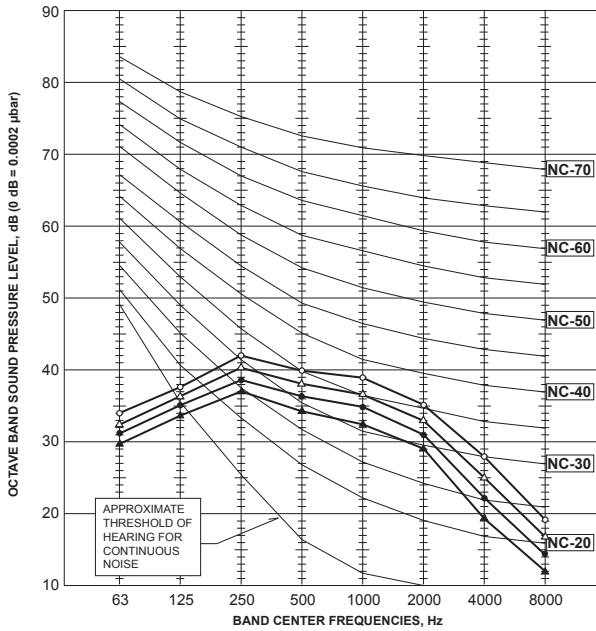

PCA-A42KA7.TH

NOTCH	SPL(dB)	LINE
High	45	○—○
Medium1	43	△—△
Medium2	41	●—●
Low	39	▲—▲

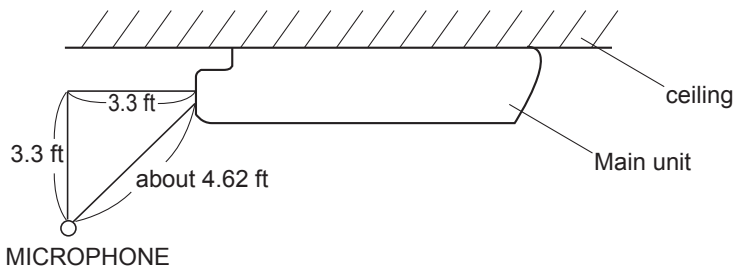
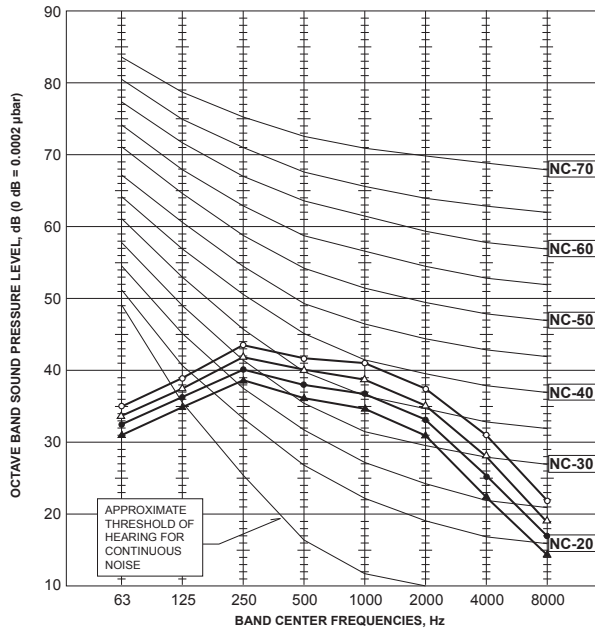

PCA-A24KA7.TH

PCA-A30KA7.TH

Unit: inch (mm)

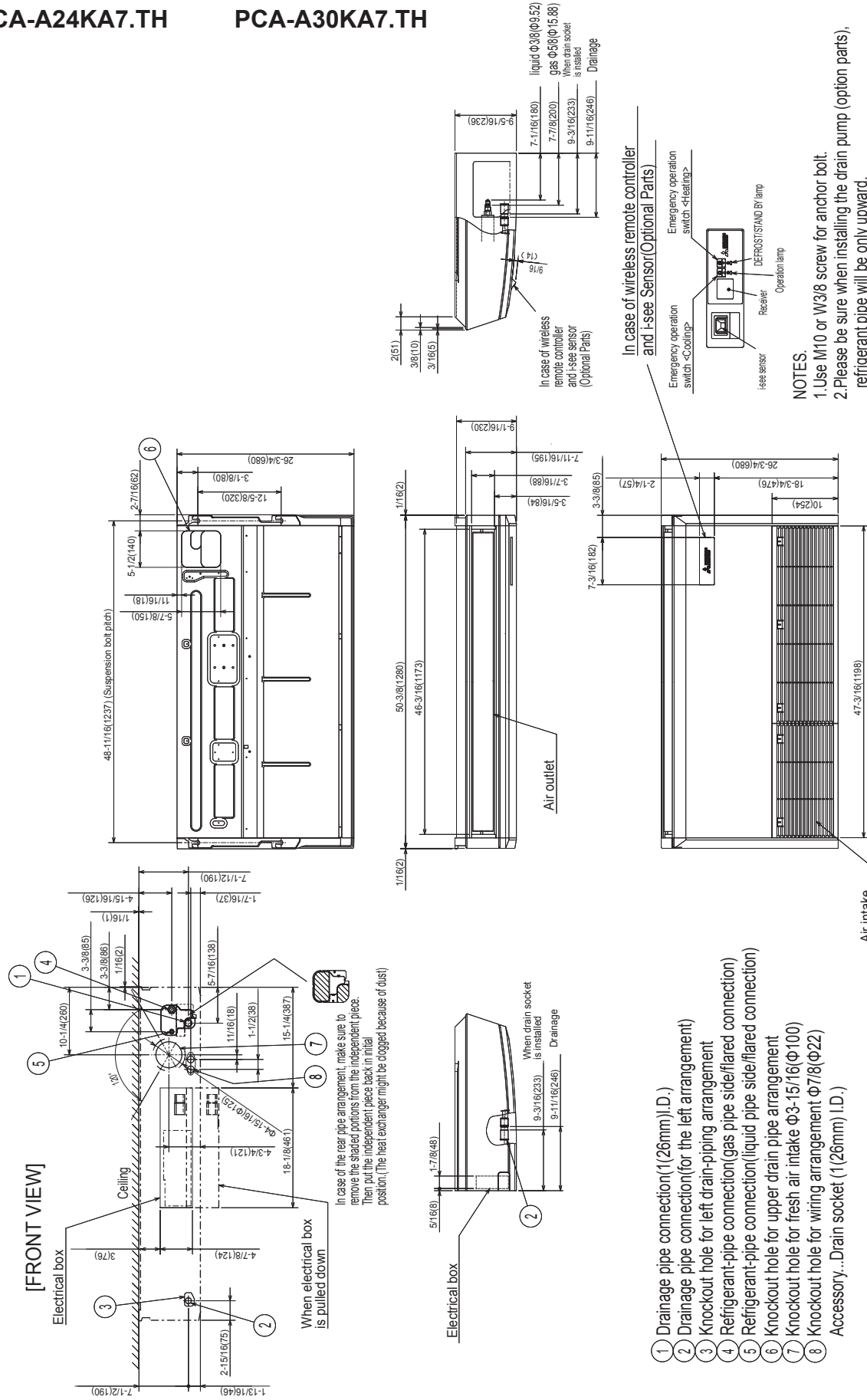





PCA-A24KA7.TH

PCA-A30KA7.TH

PCA-A36KA7.TH

PCA-A42KA7.TH

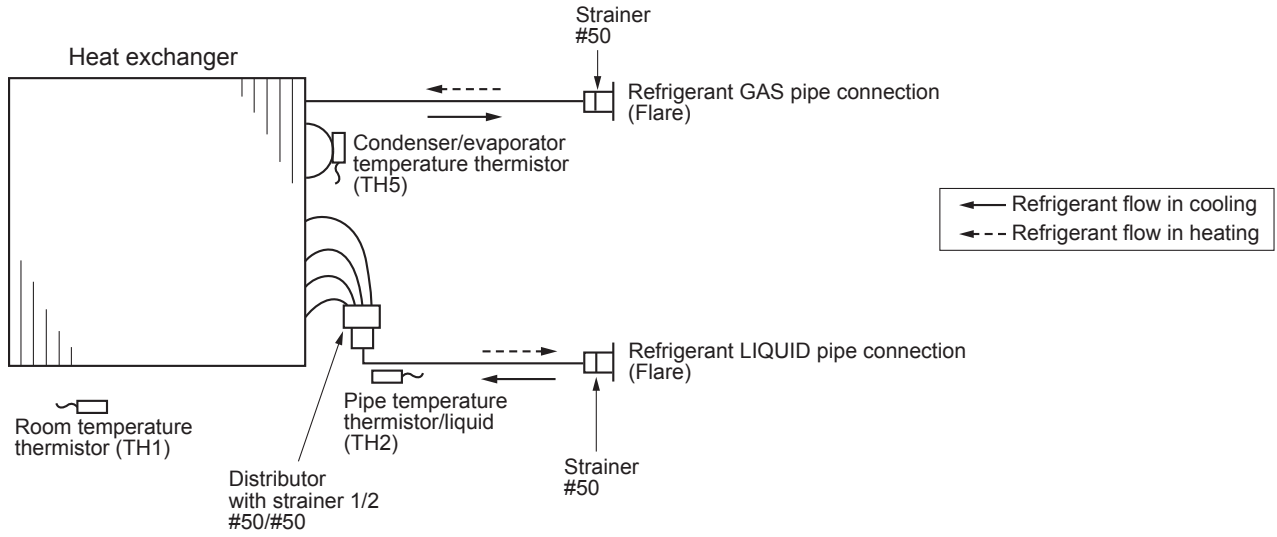

### 9-1. TROUBLESHOOTING

#### <Check code displayed by self-diagnosis and actions to be taken for service (summary)>

Present and past check codes are logged, and they can be displayed on the wired remote controller and control board of outdoor unit. Actions to be taken for service, which depends on whether or not the trouble is reoccurring in the field, are summarized in the table below. Check the contents below before investigating details.

Unit conditions at service	Check code	Actions to be taken for service (summary)
The trouble is reoccurring.	Displayed	Judge what is wrong and take a corrective action according to "9-3. SELF-DIAGNOSIS ACTION TABLE".
	Not displayed	Conduct troubleshooting and ascertain the cause of the trouble according to "9-4. TROUBLESHOOTING BY INFERIOR PHENOMENA".
The trouble is not reoccurring.	Logged	<ul style="list-style-type: none"> <li>①Consider the temporary defects such as the work of protection devices in the refrigerant circuit including compressor, poor connection of wiring, noise, etc. Re-check the symptom, and check the installation environment, refrigerant amount, weather when the trouble occurred, matters related to wiring, etc.</li> <li>②Reset check code logs and restart the unit after finishing service.</li> <li>③There is no abnormality in electrical component, controller board, remote controller, etc.</li> </ul>
	Not logged	<ul style="list-style-type: none"> <li>①Re-check the abnormal symptom.</li> <li>②Conduct troubleshooting and ascertain the cause of the trouble according to "9-4. TROUBLESHOOTING BY INFERIOR PHENOMENA".</li> <li>③Continue to operate unit for the time being if the cause is not ascertained.</li> <li>④There is no abnormality concerning of parts such as electrical component, controller board, remote controller, etc.</li> </ul>

## 9-2. MALFUNCTION-DIAGNOSIS METHOD BY REMOTE CONTROLLER

### <In case of trouble during operation>



When a malfunction occurs to air conditioner, both indoor unit and outdoor unit will stop and operation lamp blinks to inform unusual stop.

### <Malfunction-diagnosis method at maintenance service>

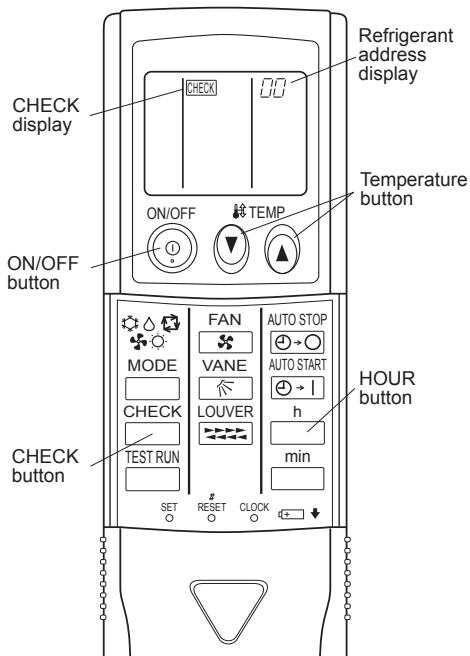
#### ■ IR wireless remote controller



#### [Procedure]

1. Press the CHECK button twice.
  - "CHECK" lights, and refrigerant address "00" blinks.
  - Check that the remote controller's display has stopped before continuing.
2. Press the TEMP   buttons.
  - Select the refrigerant address of the indoor unit for the self-diagnosis.
  - Note: Set refrigerant address using the outdoor unit's DIP switch (SW1). (For more information, see the outdoor unit installation manual.)
3. Point the remote controller at the sensor on the indoor unit and press the HOUR button.
  - If an air conditioner error occurs, the indoor unit's sensor emits an intermittent buzzer sound, the operation lamp blinks, and the check code is output. (It takes 3 seconds at most for check code to appear.)
4. Point the remote controller at the sensor on the indoor unit and press the ON/OFF button.
  - The check mode is cancelled.

• Refer to the following tables for details on the check codes.

[Output pattern A]

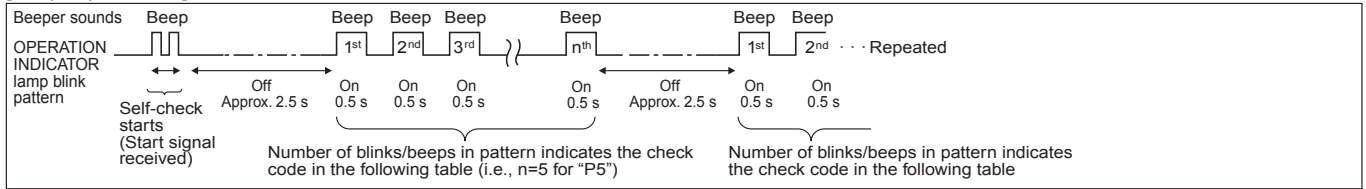

[Output pattern B]

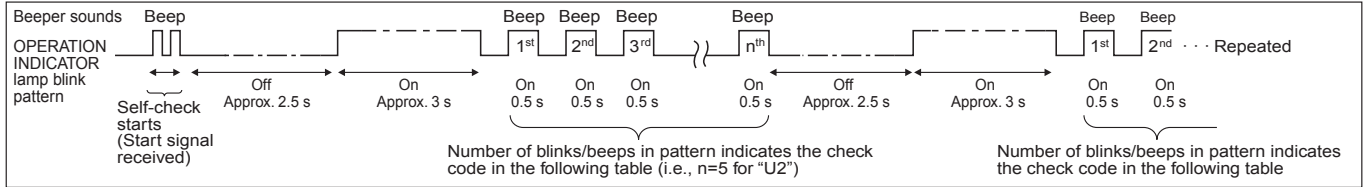

[Output pattern A] Errors detected by indoor unit

IR wireless remote controller Beeper sounds/OPERATION INDICATOR lamp blinks (Number of times)	Wired remote controller	Symptom	Remark
	① Check code		
1	P1	Intake sensor error	
2	P2	Pipe (TH2) sensor error	
	P9	Pipe (TH5) sensor error	
3	E6, E7	Indoor/outdoor unit communication error	
4	P4	Float switch connector (CN4F) open	
5	P5	Drain pump error	
	PA	Forced compressor stop(due to water leakage abnormality)	
6	P6	Freezing/Overheating protection operation	
7	EE	Communication error between indoor and outdoor units	
8	P8	Pipe temperature error	
9	E4, E5	Remote controller signal receiving error	
10	-	-	
11	PB (Pb)	Indoor unit fan motor error	
12	FB (Fb)	Indoor unit control system error (memory error, etc.)	
14	PL	Abnormality of refrigerant circuit	
-	E0, E3	Remote controller transmission error	
-	E1, E2	Remote controller control board error	

[Output pattern B] Errors detected by unit other than indoor unit (outdoor unit, etc.)

IR wireless remote controller Beeper sounds/OPERATION INDICATOR lamp blinks (Number of times)	Wired remote controller	Symptom	Remark
	① Check code		
1	E9	Indoor/outdoor unit communication error (Transmitting error) (Outdoor unit)	For details, check the LED display of the outdoor controller board. As for outdoor unit, refer to outdoor unit's service manual.
2	UP	Compressor overcurrent interruption	
3	U3, U4	Open/short of outdoor unit thermistors	
4	UF	Compressor overcurrent interruption (When compressor locked)	
5	U2	Abnormal high discharging temperature/49C operated/insufficient refrigerant	
6	U1, Ud	Abnormal high pressure (63H operated)/Overheating protection operation	
7	U5	Abnormal temperature of heatsink	
8	U8	Outdoor unit fan protection stop	
9	U6	Compressor overcurrent interruption/Abnormal of power module	
10	U7	Abnormality of superheat due to low discharge temperature	
11	U9, UH	Abnormality such as overvoltage or voltage shortage and abnormal synchronous signal to main circuit/Current sensor error	
12	-	-	
13	-	-	
14	Others	Other errors (Refer to the technical manual for the outdoor unit.)	

Notes:

1. If the beeper does not sound again after the initial 2 beeps to confirm the self-check start signal was received and the OPERATION INDICATOR lamp does not come on, there are no error records.
2. If the beeper sounds 3 times continuously "beep, beep, beep (0.4 + 0.4 + 0.4 seconds)" after the initial 2 beeps to confirm the self-check start signal was received, the specified refrigerant address is incorrect.

- On IR wireless remote controller  
The continuous buzzer sounds from receiving section of indoor unit.  
Blink of operation lamp
  - On wired remote controller
- ① Check code displayed in the LCD. (Refer to the previous page, ① check code.)

• If the unit cannot be operated properly after the test run, refer to the following table to find out the cause.

Symptom		LED 1, 2 (PCB in outdoor unit)	Cause
Wired remote controller			
PLEASE WAIT	For about 2 minutes after power-on	After LED 1, 2 are lighted, LED 2 is turned off, then only LED 1 is lighted. (Correct operation)	• For about 2 minutes following power-on, operation of the remote controller is not possible due to system start-up. (Correct operation)
PLEASE WAIT → Check code	Subsequent to about 2 minutes after power-on	Only LED 1 is lighted. → LED 1, 2 blink.	• Connector for the outdoor unit's protection device is not connected. • Reverse or open phase wiring for the outdoor unit's power terminal block (L1, L2, GR)
Display messages do not appear even when operation switch is turned ON (operation lamp does not light up).		Only LED 1 is lighted. → LED 1 blinks twice, LED 2 blinks once.	• Incorrect wiring between indoor and outdoor units (incorrect polarity of S1, S2, S3) • Remote controller wire short

On the IR wireless remote controller with condition above, following phenomena take place.

- No signals from the remote controller can be received.
- OPE lamp is blinking.
- The buzzer makes a short ping sound.

**Note:**

**Operation is not possible for about 30 seconds after cancellation of function selection. (Correct operation)**

For description of each LED (LED1, 2, 3) provided on the indoor controller, refer to the following table.

LED1 (power for microprocessor)	Indicates whether control power is supplied. Make sure that this LED is always lit.
LED2 (power for wired remote controller)	Indicates whether power is supplied to the wired remote controller. This LED lights only in the case of the indoor unit which is connected to the outdoor unit refrigerant addresses "0".
LED3 (communication between indoor and outdoor units)	Indicates state of communication between the indoor and outdoor units. Make sure that this LED is always blinking.

### 9-3. SELF-DIAGNOSIS ACTION TABLE

Note:

Errors to be detected in outdoor unit, such as codes starting with F, U or E (excluding E0 to E7), are not covered in this document. Please refer to the outdoor unit service manual for the details.

Check code	Abnormal point and detection method	Cause	Countermeasure
P1	<p><b>Room temperature thermistor (TH1)</b></p> <p>① The unit is in 3-minute resume prevention mode if short/open of thermistor is detected. Abnormal if the unit does not reset normally after 3 minutes. (The unit returns to normal operation, if it has been reset normally.)</p> <p>② Constantly detected during cooling, drying, and heating operation. Short: 194°F [90°C] or more Open: -40°F [-40°C] or less</p>	<p>① Defective thermistor characteristics</p> <p>② Contact failure of connector (CN20) on the indoor controller board (Insert failure)</p> <p>③ Breaking of wire or contact failure of thermistor wiring</p> <p>④ Defective indoor controller board</p>	<p>①-③ Check resistance value of thermistor. 32°F [0°C].....15.0 kΩ 50°F [10°C].....9.6 kΩ 68°F [20°C].....6.3 kΩ 86°F [30°C].....4.3 kΩ 104°F [40°C].....3.0 kΩ</p> <p>If you put force on (draw or bend) the lead wire with measuring resistance value of thermistor, breaking of wire or contact failure can be detected.</p> <p>② Check contact failure of connector (CN20) on the indoor controller board. Refer to "9-7. TEST POINT DIAGRAM". Turn the power on again and check restart after inserting connector again.</p> <p>④ Check room temperature display on remote controller. Replace indoor controller board if there is abnormal difference with actual room temperature.</p> <p>Turn the power off, and on again to operate after check.</p>
P2	<p><b>Pipe temperature thermistor/liquid (TH2)</b></p> <p>① The unit is in 3-minute resume prevention mode if short/open of thermistor is detected. Abnormal if the unit does not reset normally after 3 minutes. (The unit returns to normal operation, if it has been reset normally.)</p> <p>② Constantly detected during cooling, drying, and heating (except defrosting) operation Short: 194°F [90°C] or more Open: -40°F [-40°C] or less</p> <p>Note: When all of the following conditions are satisfied, the error is not detected: 1) During cooling operation, or for 3 minutes after cooling operation is stopped. 2) Up to 16 minutes from 10 seconds after cooling operation is started. 3) Outside temperature &lt; -22°F [-30°C]</p>	<p>① Defective thermistor characteristics</p> <p>② Contact failure of connector (CN44) on the indoor controller board (Insert failure)</p> <p>③ Breaking of wire or contact failure of thermistor wiring</p> <p>④ Defective refrigerant circuit is causing thermistor temperature of 194°F [90°C] or more, or -40°F [-40°C] or less.</p> <p>⑤ Defective indoor controller board</p>	<p>①-③ Check resistance value of thermistor. For characteristics, refer to (P1) above.</p> <p>② Check contact failure of connector (CN44) on the indoor controller board. Refer to "9-7. TEST POINT DIAGRAM". Turn the power on and check restart after inserting connector again.</p> <p>④ Check pipe &lt;liquid&gt; temperature with remote controller in test run mode. If pipe &lt;liquid&gt; temperature is extremely low (in cooling mode) or high (in heating mode), refrigerant circuit may have defective.</p> <p>⑤ Check pipe &lt;liquid&gt; temperature with remote controller in test run mode. If there is extremely difference with actual pipe &lt;liquid&gt; temperature, replace indoor controller board.</p> <p>Turn the power off, and on again to operate after check.</p>
P4	<p><b>Contact failure of drain float switch (CN4F)</b></p> <ul style="list-style-type: none"> <li>Extract when the connector of drain float switch is disconnected. (③ and ④ of connector CN4F is not short-circuited.)</li> <li>Constantly detected during operation</li> </ul>	<p>① Contact failure of connector (Insert failure)</p> <p>② Defective indoor controller board</p>	<p>① Check contact failure of float switch connector. Turn the power on again and check after inserting connector again.</p> <p>② Operate with connector (CN4F) short-circuited. Replace indoor controller board if abnormality reappears.</p>
P5	<p><b>Drain over flow protection operation</b></p> <p>① Suspensive abnormality, if drain float switch is detected to be underwater for 1 minute and 30 seconds continuously with drain pump on. Compressor and indoor fan will be turned off.</p> <p>② Drain pump is abnormal if the condition above is detected during suspensive abnormality.</p> <p>③ Constantly detected during drain pump operation</p>	<p>① Malfunction of drain pump</p> <p>② Defective drain Clogged drain pump Clogged drain pipe</p> <p>③ Defective drain float switch Catch of drain float switch or malfunction of moving parts cause drain float switch to be detected under water (Switch On)</p> <p>④ Defective indoor-controller board</p>	<p>① Check if drain-up machine works.</p> <p>② Check drain function.</p> <p>③ Remove drain float switch connector CN4F and check if it is short (Switch On) with the moving part of float switch UP, or OPEN with the moving part of float switch down. Replace float switch if it is short with the moving part of float switch down.</p> <p>④ Replace indoor controller board if it is short-circuited between ③-④ of the drain float switch connector CN4F and abnormality reappears.</p> <p>It is not abnormal if there is no problem about the above-mentioned ①-④. Turn the power off, and on again to operate after check.</p>

Check code	Abnormal point and detection method	Cause	Countermeasure
P6	<p><b>Freezing/overheating protection is working</b></p> <p>① Freezing protection (Cooling mode)            • In case when outside temperature &gt; -4°F [-20°C]            The unit is in 6-minute resume prevention mode if pipe &lt;liquid or condenser/evaporator&gt; temperature stays under -5°F [-15°C] for 3 minutes, 3 minutes after the compressor started. Abnormal if it stays under -5°F [-15°C] for 3 minutes again within 16 minutes after 6-minute resume prevention mode.</p> <p>• In case when outside temperature ≤ -4°F [-20°C]            The unit is in 6-minute resume prevention mode if pipe &lt;liquid or condenser/evaporator&gt; temperature stays under -31°F [-35°C] for 3 minutes, 3 minutes after the compressor started. Abnormal if it stays under -31°F [-35°C] for 3 minutes again within 16 minutes after 6-minute resume prevention mode.</p> <p>② Overheating protection (Heating mode)            The unit is in 6-minute resume prevention mode if pipe &lt;liquid or condenser/evaporator&gt; temperature is detected as over 158°F [70°C] after the compressor started. Abnormal if the temperature of over 158°F [70°C] is detected again within 30 minutes after 6-minute resume prevention mode.</p>	<p>(Cooling or drying mode)</p> <p>① Clogged filter (reduced airflow)            ② Short cycle of air path            ③ Low-load (low temperature) operation out of the tolerance range            ④ Defective indoor fan motor            • Fan motor is defective.            • Indoor controller board is defective.            ⑤ Defective outdoor fan control            ⑥ Overcharge of refrigerant            ⑦ Defective refrigerant circuit (clogs)</p> <p>(Heating mode)</p> <p>① Clogged filter (reduced airflow)            ② Short cycle of air path            ③ Over-load (high temperature) operation out of the tolerance range            ④ Defective indoor fan motor            • Fan motor is defective.            • Indoor controller board is defective.            ⑤ Defective outdoor fan control            ⑥ Overcharge of refrigerant            ⑦ Defective refrigerant circuit (clogs)            ⑧ Bypass circuit of outdoor unit is defective.</p>	<p>(Cooling or drying mode)</p> <p>① Check clogs of the filter.            ② Remove shields.</p> <p>④ Refer to "9-6. HOW TO CHECK THE PARTS".</p> <p>⑤ Check outdoor fan motor.            ⑥⑦ Check operating condition of refrigerant circuit.</p> <p>(Heating mode)</p> <p>① Check clogs of the filter.            ② Remove shields.</p> <p>④ Refer to "9-6. HOW TO CHECK THE PARTS".</p> <p>⑤ Check outdoor fan motor.            ⑥-⑧ Check operating condition of refrigerant circuit.</p>
P8	<p><b>Pipe temperature</b>            &lt;Cooling mode&gt;            Detected as abnormal when the pipe temperature is not in the cooling range 3 minutes after compressor start and 6 minutes after the liquid or condenser/evaporator pipe is out of cooling range.            Note 1: It takes at least 9 minutes to detect.            Note 2: Abnormality P8 is not detected in drying mode.            Cooling range: -5.4°F [-3°C] ≥ (TH-TH1)            TH: Lower temperature between liquid pipe temperature (TH2) and condenser/evaporator temperature (TH5)            TH1: Intake temperature</p> <p>&lt;Heating mode&gt;            When 10 seconds have passed after the compressor starts operation and the hot adjustment mode has finished, the unit is detected as abnormal when condenser/evaporator pipe temperature is not in heating range within 20 minutes.</p> <p>Note 3: It takes at least 27 minutes to detect abnormality.            Note 4: It excludes the period of defrosting. (Detection restarts when defrosting mode is over.)            Heating range: 5.4°F [3°C] ≤ (TH5-TH1)</p>	<p>① Slight temperature difference between indoor room temperature and pipe &lt;liquid or condenser/evaporator&gt; temperature thermistor            • Shortage of refrigerant            • Disconnected holder of pipe &lt;liquid or condenser/evaporator&gt; thermistor            • Defective refrigerant circuit</p> <p>② Converse connection of extension pipe (on plural units connection)            ③ Converse wiring of indoor/outdoor unit connecting wire (on plural units connection)            ④ Defective detection of indoor room temperature and pipe &lt;condenser/evaporator&gt; temperature thermistor            ⑤ Stop valve is not opened completely.</p>	<p>①-④ Check pipe &lt;liquid or condenser/evaporator&gt; temperature with room temperature display on remote controller and outdoor controller circuit board.            Pipe &lt;liquid or condenser/evaporator&gt; temperature display is indicated by setting SW2 of outdoor controller circuit board as follows.</p> <p>( Conduct temperature check with outdoor controller circuit board after connecting 'A-Control Service Tool(PAC-SK52ST)' )</p> <p>②③ Check converse connection of extension pipe or converse wiring of indoor/outdoor unit connecting wire.</p>

Check code	Abnormal point and detection method	Cause	Countermeasure
P9	<p><b>Condenser/evaporator temperature thermistor (TH5)</b></p> <p>① The unit is in 3-minute resume protection mode if short/open of thermistor is detected. Abnormal if the unit does not get back to normal within 3 minutes. (The unit returns to normal operation, if it has been reset normally.)</p> <p>② Constantly detected during cooling, drying, and heating operation (except defrosting) Short: 194°F [90°C] or more Open: -40°F [-40°C] or less</p> <p>Note: When all of the following conditions are satisfied, the error is not detected: 1) During cooling operation, or for 3 minutes after cooling operation is stopped. 2) Up to 16 minutes from 10 seconds after cooling operation is started. 3) Outside temperature &lt; -22°F [-30°C]</p>	<p>① Defective thermistor characteristics</p> <p>② Contact failure of connector (CN44) on the indoor controller board (Insert failure)</p> <p>③ Breaking of wire or contact failure of thermistor wiring</p> <p>④ Temperature of thermistor is 194°F [90°C] or more or -40°F [-40°C] or less caused by defective refrigerant circuit.</p> <p>⑤ Defective indoor controller board</p>	<p>①-③ Check resistance value of thermistor. For characteristics, refer to (P1) above.</p> <p>② Check contact failure of connector (CN44) on the indoor controller board. Refer to "9-7. TEST POINT DIAGRAM". Turn the power on and check restart after inserting connector again.</p> <p>④ Operate in test run mode and check pipe &lt;condenser/evaporator&gt; temperature with outdoor controller circuit board. If pipe &lt;condenser/evaporator&gt; temperature is extremely low (in cooling mode) or high (in heating mode), refrigerant circuit may have defect.</p> <p>⑤ Operate in test run mode and check pipe &lt;condenser/evaporator&gt; temperature with outdoor control circuit board. If there is extreme difference with actual pipe &lt;condenser/evaporator&gt; temperature, replace indoor controller board. There is no abnormality if none of above comes within the unit. Turn the power off and on again to operate.</p> <p>( In case of checking pipe temperature with outdoor controller circuit board, be sure to connect A-control service tool (PAC-SK52ST). )</p>
PA	<p><b>Forced compressor stop (due to water leakage abnormality)</b></p> <p>① The unit has a water leakage abnormality when the following conditions, a) and b), are satisfied while the above-mentioned detection is performed.</p> <p>a) The intake temperature subtracted with liquid pipe temperature detects to be less than 14°F [-10°C] for a total of 30 minutes. (When the drain sensor is detected to be NOT soaked in the water, the detection record of a) and b) will be cleared.)</p> <p>b) Drain float switch detects to be in the water for more than 15 minutes.</p> <p>Note: Once the water leakage abnormality is detected, abnormality state will not be released until the main power is reset.</p>	<p>① Drain pump trouble</p> <p>② Drain defective</p> <ul style="list-style-type: none"> <li>- Drain pump clogging</li> <li>- Drain pipe clogging</li> </ul> <p>③ Open circuit of float switch</p> <p>④ Contact failure of float switch connector</p> <p>⑤ Dew condensation on float switch</p> <ul style="list-style-type: none"> <li>- Drain water descends along lead wire.</li> <li>- Drain water is waving due to filter clogging.</li> </ul> <p>⑥ Extension piping connection difference at twin, triple or quadruple system</p> <p>⑦ Miswiring of indoor/outdoor connecting at twin, triple or quadruple system</p> <p>⑧ Room temperature thermistor/ liquid pipe temperature thermistor detection is defective.</p>	<p>① Check the drain pump.</p> <p>② Check whether water can be drained.</p> <p>③ Check the resistance of the float switch.</p> <p>④ Check the connector contact failure.</p> <p>⑤ Check the float switch leadwire mounted. Check the filter clogging.</p> <p>⑥ Check the piping connection.</p> <p>⑦ Check the indoor/outdoor connecting wires.</p> <p>⑧ Check the room temperature display of remote controller. Check the indoor liquid pipe temperature display of outdoor controller board.</p>
PB (Pb)	<p><b>Fan motor trouble</b></p>	<p>① Defective fan motor</p> <p>② Defective indoor controller board</p>	<p>①② Refer to "9-6-2. DC fan motor (fan motor/indoor controller circuit board)".</p>
E0 or E4	<p><b>Remote controller transmission error(E0)/signal receiving error(E4)</b></p> <p>① Abnormal if main or sub remote controller cannot receive any transmission normally from indoor unit of refrigerant address "0" for 3 minutes. (Check code: E0)</p> <p>② Abnormal if sub remote controller could not receive any signal for 2 minutes. (Check code: E0)</p> <p>① Abnormal if indoor controller board can not receive any data normally from remote controller board or from other indoor controller board for 3 minutes. (Check code: E4)</p> <p>② Indoor controller board cannot receive any signal from remote controller for 2 minutes. (Check code: E4)</p>	<p>① Contact failure at transmission wire of remote controller</p> <p>② All remote controllers are set as "sub" remote controller. In this case, E0 is displayed on remote controller, and E4 is displayed at LED (LED1, LED2) on the outdoor controller circuit board.</p> <p>③ Miswiring of remote controller</p> <p>④ Defective transmitting receiving circuit of remote controller</p> <p>⑤ Defective transmitting receiving circuit of indoor controller board of refrigerant addresses "0".</p> <p>⑥ Noise has entered into the transmission wire of remote controller.</p>	<p>① Check disconnection or looseness of indoor unit or transmission wire of remote controller.</p> <p>② Set one of the remote controllers "main" if there is no problem with the action above.</p> <p>③ Check wiring of remote controller.</p> <ul style="list-style-type: none"> <li>• Total wiring length: max. 500 m (Do not use cable × 3 or more.)</li> <li>• The number of connecting indoor units: max. 16 units</li> <li>• The number of connecting remote controller: max. 2 units</li> </ul> <p>If the cause of trouble is not in above ①-③,</p> <p>④ Diagnose remote controllers.</p> <p>a) When "RC OK" is displayed, Remote controllers have no problem. Turn the power off, and on again to check. If abnormality generates again, replace indoor controller board.</p> <p>b) When "RC NG" is displayed, Replace remote controller.</p> <p>c) When "RC E3" or "ERC 00-66" is displayed, noise may be causing abnormality.</p> <p>Note: If the unit is not normal after replacing indoor controller board in group control, indoor controller board of address "0" may be abnormal.</p>

Check code	Abnormal point and detection method	Cause	Countermeasure
E3 or E5	<p><b>Remote controller transmission error(E3)/signal receiving error(E5)</b></p> <p>① Abnormal if remote controller could not find blank of transmission path for 6 seconds and could not transmit. (Check code: E3)</p> <p>② Remote controller receives transmitted data at the same time and compares the received and transmitted data. Abnormal if these data are judged to be different 30 continuous times. (Check code: E3)</p> <p>① Abnormal if indoor controller board could not find blank of transmission path. (Check code: E5)</p> <p>② Indoor controller board receives transmitted data at the same time and compares the received and transmitted data. Abnormal if these data are judged to be different 30 continuous times. (Check code: E5)</p>	<p>① 2 remote controllers are set as "main." (In case of 2 remote controllers)</p> <p>② Remote controller is connected with 2 indoor units or more.</p> <p>③ Repetition of refrigerant address</p> <p>④ Defective transmitting receiving circuit of remote controller</p> <p>⑤ Defective transmitting receiving circuit of indoor controller board</p> <p>⑥ Noise has entered into transmission wire of remote controller.</p>	<p>① Set a remote controller to main, and the other to sub.</p> <p>② Remote controller is connected with only one indoor unit.</p> <p>③ The address changes to a separate setting.</p> <p>④—⑥ Diagnose remote controller.</p> <p>a) When "RC OK" is displayed, remote controllers have no problem. Turn the power off, and on again to check. When becoming abnormal again, replace indoor controller board.</p> <p>b) When "RC NG" is displayed, replace remote controller.</p> <p>c) When "RC E3" or "ERC 00-66" is displayed, noise may be causing abnormality.</p>
E6	<p><b>Indoor/outdoor unit communication error (Signal receiving error)</b></p> <p>① Abnormal if indoor controller board cannot receive any signal normally for 6 minutes after turning the power on.</p> <p>② Abnormal if indoor controller board cannot receive any signal normally for 3 minutes.</p> <p>③ Consider the unit abnormal under the following condition: When 2 or more indoor units are connected to an outdoor unit, indoor controller board cannot receive a signal for 3 minutes from outdoor controller circuit board, a signal which allows outdoor controller circuit board to transmit signals.</p>	<p>① Contact failure, short circuit or, miswiring (converse wiring) of indoor/outdoor unit connecting wire</p> <p>② Defective transmitting receiving circuit of indoor controller board</p> <p>③ Defective transmitting receiving circuit of indoor controller board</p> <p>④ Noise has entered into indoor/outdoor unit connecting wire.</p>	<p>Check LED display on the outdoor control circuit board. (Connect A-control service tool, PAC-SK52ST.) Refer to outdoor unit service manual.</p> <p>① Check disconnection or looseness of indoor/ outdoor unit connecting wire of indoor unit or outdoor unit. Check all the units in case of twin triple indoor unit system.</p> <p>②—④ Turn the power off, and on again to check. If abnormality generates again, replace indoor controller board or outdoor controller circuit board.</p> <p>Note: Other indoor controller board may have defect in the case of twin triple indoor unit system.</p>
E7	<p><b>Indoor/outdoor unit communication error (Transmitting error)</b></p> <p>Abnormal if "1" receiving is detected 30 times continuously though indoor controller board has transmitted "0".</p>	<p>① Defective transmitting receiving circuit of indoor controller board</p> <p>② Noise has entered into power supply.</p> <p>③ Noise has entered into outdoor control wire.</p>	<p>①—③ Turn the power off, and on again to check. If abnormality generates again, replace indoor controller board.</p>
FB (Fb)	<p><b>Indoor controller board</b></p> <p>Abnormal if data cannot be read normally from the nonvolatile memory of the indoor controller board.</p>	<p>① Defective indoor controller board</p>	<p>① Replace indoor controller board.</p>
E1 or E2	<p><b>Remote controller control board</b></p> <p>① Abnormal if data cannot be read normally from the nonvolatile memory of the remote controller control board. (Check code: E1)</p> <p>② Abnormal if the clock function of remote controller cannot be operated normally. (Check code: E2)</p>	<p>① Defective remote controller</p>	<p>① Replace remote controller.</p>
PL	<p><b>Abnormal refrigerant circuit</b></p> <p>During Cooling, Dry, or Auto Cooling operation, the following conditions are regarded as failures when detected for 1 second.</p> <p>a)The compressor continues to run for 30 or more seconds.</p> <p>b)The liquid pipe temperature or the condenser/evaporator temperature is 167°F [75°C] or more.</p> <p><b><u>These detected errors will not be cancelled until the power source is reset.</u></b></p>	<p>① Abnormal operation of 4-way valve</p> <p>② Disconnection of or leakage in refrigerant pipes</p> <p>③ Air into refrigerant piping</p> <p>④ Abnormal operation (no rotation) of indoor fan</p> <ul style="list-style-type: none"> <li>· Defective fan motor</li> <li>· Defective indoor control board</li> </ul> <p>⑤ Defective refrigerant circuit (clogging)</p>	<p>① <b><u>When this error occurs, be sure to replace the 4-way valve.</u></b></p> <p>② Check refrigerant pipes for disconnection or leakage.</p> <p>③ After the recovery of refrigerant, vacuum dry the whole refrigerant circuit.</p> <p>④ Refer to "9-6-2. DC fan motor (fan motor/ indoor controller circuit board)".</p> <p>⑤ Check refrigerant circuit for operation.</p> <p><b><u>To avoid entry of moisture or air into refrigerant circuit which could cause abnormal high pressure, purge air in refrigerant circuit or replace refrigerant.</u></b></p>

## 9-4. TROUBLESHOOTING BY INFERIOR PHENOMENA

Note: Refer to the manual of outdoor unit for the detail of remote controller.

Phenomena	Cause	Countermeasure
<b>(1)Upward/downward vane performance failure</b>	① The vane is not downward during defrosting and heat preparation and when the thermostat is OFF in HEAT mode. (Working of COOL protection function) ② Vane motor does not rotate. • Defective vane motor • Breaking of wire or connection failure of connector  ③ Upward/downward vane does not work. • The vane is set to fixed position.	① Normal operation (The vane is set to horizontal regardless of remote control.)  ② Check ② (left). • Check the vane motor. (Refer to “9-6. HOW TO CHECK THE PARTS”.) • Check for breaking of wire or connection failure of connector.  ③ Normal operation (Each connector on vane motor side is disconnected or setting the fixed vanes by wired remote controller.)
<b>(2)Receiver for IR wireless remote controller</b>	① Weak batteries of IR wireless remote controller  ② Contact failure of connector (CNB) on IR wireless remote controller board (Insert failure) ③ Contact failure of connector (CN90) on indoor controller board (Insert failure) ④ Contact failure of connector between IR wireless remote controller board and indoor controller board	① Replace batteries of IR wireless remote controller.  ②-④ Check contact failure of each connector. If no problems are found of connector, replace indoor controller board. When the same trouble occurs even if indoor controller board is replaced, replace IR wireless remote controller board.

## 9-5. EMERGENCY OPERATION

### 9-5-1. When IR wireless remote controller fails or its battery is exhausted

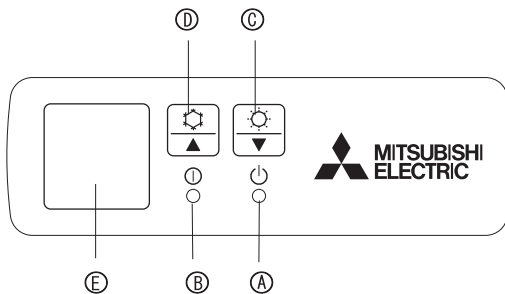

#### When the remote controller cannot be used

When the batteries of the remote controller run out or the remote controller malfunctions, the Emergency Operation can be done using the emergency buttons on the grille.

- Ⓐ DEFROST/STAND BY lamp
- Ⓑ Operation lamp
- Ⓒ Emergency operation switch (heating)
- Ⓓ Emergency operation switch (cooling)
- Ⓔ Receiver

#### Starting operation

- To operate the cooling mode, press the ❄️ button Ⓓ for more than 2 seconds.
- To operate the heating mode, press the ☀️ button Ⓒ for more than 2 seconds.

Note: Lighting of the Operation lamp Ⓑ means the start of operation.

#### • Details of emergency mode are as shown below.

Operation mode	COOL	HEAT
Set temperature	75°F [24°C]	75°F [24°C]
Fan speed	High	High
Airflow direction	Horizontal	Downward 5

#### Stopping operation

- To stop operation, press the ❄️ button Ⓓ or the ☀️ button Ⓒ.

### 9-5-2. When wired remote controller or indoor unit microprocessor fails

1. When the wired remote control or the indoor unit microprocessor has failed, but all other components work properly, if you set the switch (SWE) on the indoor controller board ON, the indoor unit will begin Emergency Operation.

When Emergency Operation is activated, the indoor unit operates as follows:

(1) Indoor fan is running at high speed. (2) Drain pump is working. (option)

Note on the IR wireless remote control:

When the remote control does not function, it is possible to activate Emergency Operation by using the indoor unit Emergency Operation switch (SW1, SW2 of the IR wireless signalreceiver board).

However, if the indoor unit microprocessor has failed, it is necessary to proceed with points (2) and (3) below as in the case of the wired remote controller.

2. When you activate Emergency Operation of the cooling or heating, you have to set the switch (SWE) on the indoor controller board and activate Emergency Operation of the outdoor unit.

For details on how to activate Emergency Operation of the outdoor unit, refer to the outdoor unit wiring diagram.

3. Before you activate Emergency Operation, check the following points:

(1) Emergency operation cannot be activated when:

- the outdoor unit malfunctions. • the indoor fan malfunctions.
- when it has detected the malfunction of drain pump during self-diagnosing.

(2) Emergency operation becomes continuous only by switching the power source on/off.

ON/OFF on the remote control or temperature control, etc. does not function.

(3) Avoid operating for a long time when the outdoor unit begins defrosting while Emergency Operation of the heating is activated because it will start to blow cold air.

(4) Emergency cooling should be limited to 10 hours maximum (The indoor unit heat exchanger may freeze).

(5) After Emergency Operation has been deactivated, set the switches etc. to their original positions.

(6) Movement of the vanes does not work in Emergency Operation, therefore you have to slowly set them manually to the appropriate position.

## 9-6. HOW TO CHECK THE PARTS

PCA-A24KA7.TH

PCA-A30KA7.TH

PCA-A36KA7.TH

PCA-A42KA7.TH

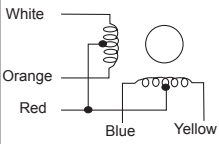
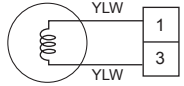
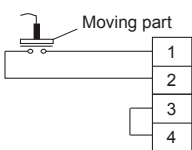
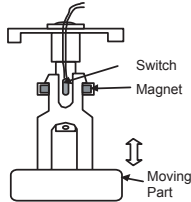
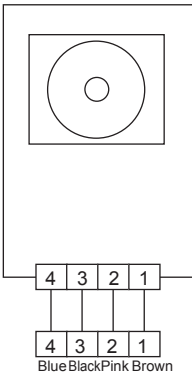
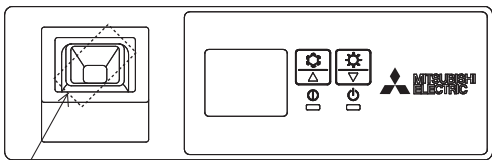
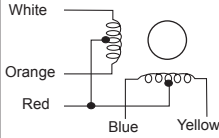
Parts name	Check points										
Room temperature thermistor (TH1) Pipe temperature thermistor/liquid (TH2) Condenser/evaporator temperature thermistor (TH5)	Disconnect the connector then measure the resistance with a tester. (At the ambient temperature 50 to 86°F [10 to 30°C]) <table border="1" style="margin-left: 20px;"> <thead> <tr> <th>Normal</th> <th>Abnormal</th> </tr> </thead> <tbody> <tr> <td>4.3 to 9.6kΩ</td> <td>Open or short</td> </tr> </tbody> </table> (Refer to "9-6-1. Thermistor".)	Normal	Abnormal	4.3 to 9.6kΩ	Open or short						
Normal	Abnormal										
4.3 to 9.6kΩ	Open or short										
Vane motor (MV) 	Measure the resistance between the terminals with a tester. (At the ambient temperature of 68 to 86°F [20 to 30°C]) <table border="1" style="margin-left: 20px;"> <thead> <tr> <th>Connector</th> <th>Normal</th> <th>Abnormal</th> </tr> </thead> <tbody> <tr> <td>Red - Yellow</td> <td rowspan="5">300 Ω</td> <td rowspan="5">Open or short</td> </tr> <tr> <td>Red - Blue</td> </tr> <tr> <td>Red - Orange</td> </tr> <tr> <td>Red - White</td> </tr> <tr> <td>Red - Yellow</td> </tr> </tbody> </table>	Connector	Normal	Abnormal	Red - Yellow	300 Ω	Open or short	Red - Blue	Red - Orange	Red - White	Red - Yellow
Connector	Normal	Abnormal									
Red - Yellow	300 Ω	Open or short									
Red - Blue											
Red - Orange											
Red - White											
Red - Yellow											
Drain pump (DP) (Option) 	Measure the resistance between the terminals with a tester. (Winding temperature 68°F [20°C]) <table border="1" style="margin-left: 20px;"> <thead> <tr> <th>Normal</th> <th>Abnormal</th> </tr> </thead> <tbody> <tr> <td>290 Ω</td> <td>Open or short</td> </tr> </tbody> </table>	Normal	Abnormal	290 Ω	Open or short						
Normal	Abnormal										
290 Ω	Open or short										
Drain float switch (FS) (Option) 	Measure the resistance between the terminals with a tester. <table border="1" style="margin-left: 20px;"> <thead> <tr> <th>State of moving part</th> <th>Normal</th> <th>Abnormal</th> </tr> </thead> <tbody> <tr> <td>UP</td> <td>Short</td> <td>Other than short</td> </tr> <tr> <td>DOWN</td> <td>Open</td> <td>Other than open</td> </tr> </tbody> </table> 	State of moving part	Normal	Abnormal	UP	Short	Other than short	DOWN	Open	Other than open	
State of moving part	Normal	Abnormal									
UP	Short	Other than short									
DOWN	Open	Other than open									
i-see Sensor (Option) 	① Turn on the indoor unit with the black plastic tape on the outside of i-see Sensor controller board. ② i-see Sensor rotates then pull out the connector of motor for i-see Sensor. ③ With electricity being turned on, measure the power voltage between connectors with tester. <div style="text-align: center;">  <p>Black plastic tape</p> </div> i-see Sensor (At the ambient temperature of 50 to 104°F [10 to 60°C]) <table border="1" style="margin-left: 20px;"> <thead> <tr> <th>i-see Sensor connector</th> <th>Normal</th> <th>Abnormal</th> </tr> </thead> <tbody> <tr> <td>②(-)-④(+)</td> <td>1.857 to 3.132 V DC</td> <td>Other than the normal</td> </tr> <tr> <td>①(+)-②(-)</td> <td>0.939 to 1.506 V DC</td> <td>Other than the normal</td> </tr> </tbody> </table> <p><b>NOTE</b> : Be careful not to discharge static electricity into electronic device.</p>	i-see Sensor connector	Normal	Abnormal	②(-)-④(+)	1.857 to 3.132 V DC	Other than the normal	①(+)-②(-)	0.939 to 1.506 V DC	Other than the normal	
i-see Sensor connector	Normal	Abnormal									
②(-)-④(+)	1.857 to 3.132 V DC	Other than the normal									
①(+)-②(-)	0.939 to 1.506 V DC	Other than the normal									
Vane motor for i-see Sensor (Option) 	Measure the resistance between the terminals with a tester. (At the ambient temperature of 68 to 86°F [20 to 30°C]) <table border="1" style="margin-left: 20px;"> <thead> <tr> <th>Connector</th> <th>Normal</th> <th>Abnormal</th> </tr> </thead> <tbody> <tr> <td>Red - Yellow</td> <td rowspan="5">250 Ω</td> <td rowspan="5">Open or short</td> </tr> <tr> <td>Red - Blue</td> </tr> <tr> <td>Red - Orange</td> </tr> <tr> <td>Red - White</td> </tr> <tr> <td>Red - Yellow</td> </tr> </tbody> </table>	Connector	Normal	Abnormal	Red - Yellow	250 Ω	Open or short	Red - Blue	Red - Orange	Red - White	Red - Yellow
Connector	Normal	Abnormal									
Red - Yellow	250 Ω	Open or short									
Red - Blue											
Red - Orange											
Red - White											
Red - Yellow											

## 9-6-1. Thermistor

<Thermistor characteristic graph>

Thermistor for lower temperature

Room temperature thermistor (TH1)  
Pipe temperature thermistor/liquid (TH2)  
Condenser/evaporator temperature thermistor (TH5)

Thermistor  $R_0=15\text{ k}\Omega \pm 3\%$   
Fixed number of  $B=3480 \pm 2\%$

$$t(^{\circ}\text{C})R_t=15\text{exp} \left\{ 3480 \left( \frac{1}{273+t} - \frac{1}{273} \right) \right\}$$

$$T(^{\circ}\text{F})R_t=15\text{exp} \left\{ 3480 \left( \frac{1}{273+\frac{T-32}{1.8}} - \frac{1}{273} \right) \right\}$$

32°F [0°C]	15 kΩ
50°F [10°C]	9.6 kΩ
68°F [20°C]	6.3 kΩ
77°F [25°C]	5.4 kΩ
86°F [30°C]	4.3 kΩ
104°F [40°C]	3.0 kΩ

<Thermistor for lower temperature>

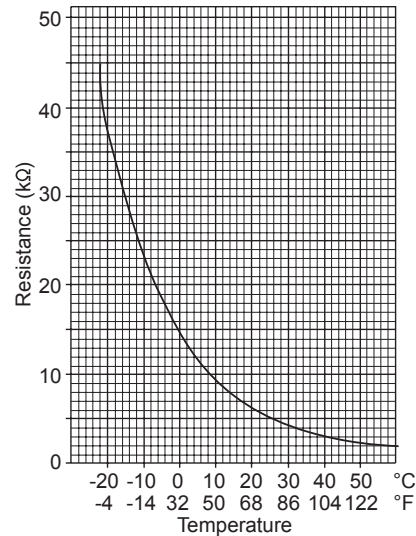

## 9-6-2. DC Fan Motor (fan motor/indoor controller circuit board)

### Check method of DC fan motor (fan motor/indoor controller circuit board)

#### ① Notes

- High voltage is applied to the connector (CNMF) for the fan motor. Pay attention to the service.
- Do not pull out the connector (CNMF) for the motor with the power supply on.  
(It causes trouble of the indoor controller circuit board and fan motor.)

#### ② Self check

Symptom : The indoor fan cannot rotate.

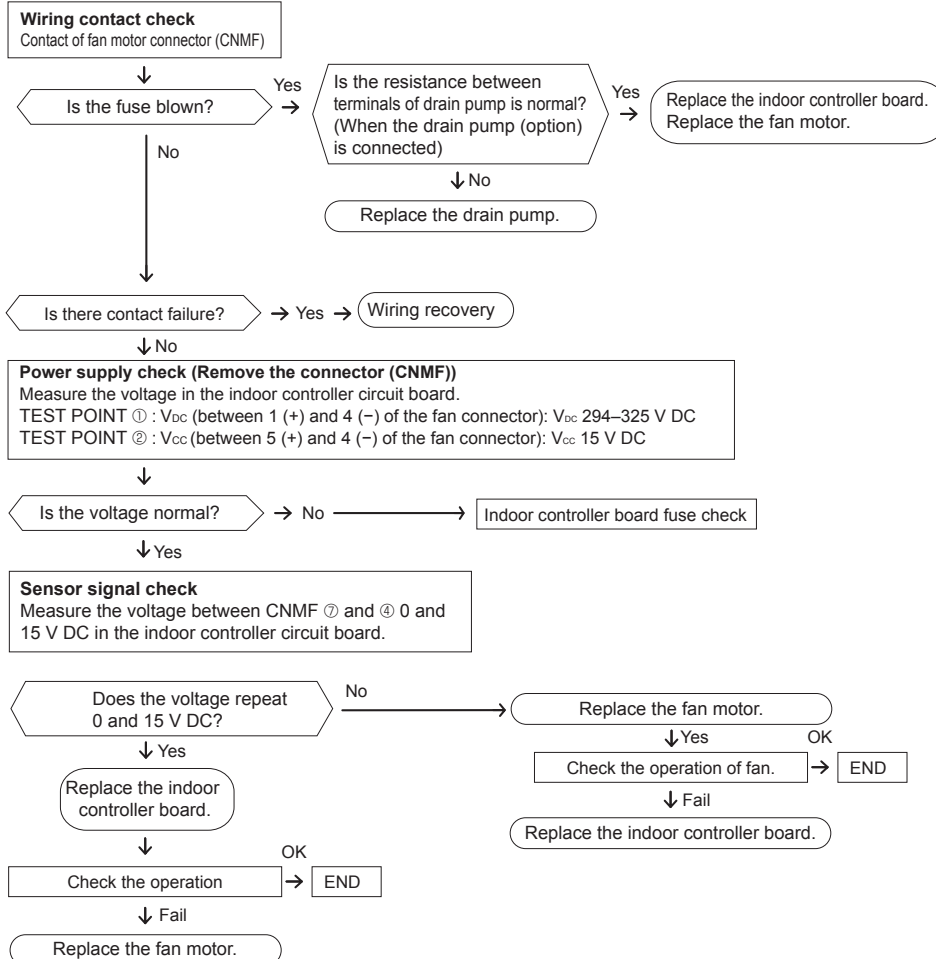

## 9-7. TEST POINT DIAGRAM

Indoor controller board

PCA-A24KA7.TH

PCA-A30KA7.TH

PCA-A36KA7.TH

PCA-A42KA7.TH

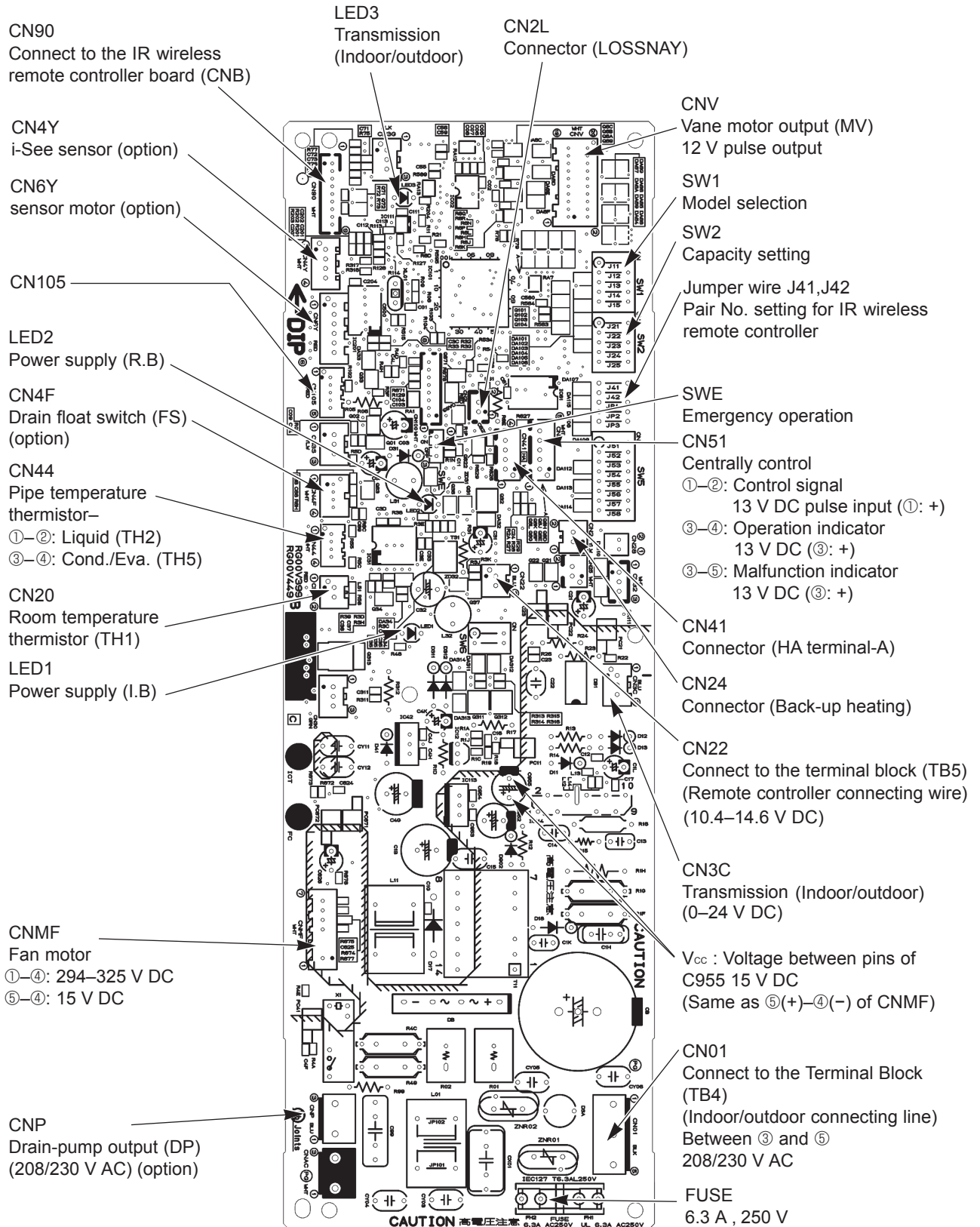

## 9-8. FUNCTIONS OF DIP SWITCH AND JUMPER WIRE

Each function is controlled by the DIP switch and the jumper wire on indoor controller board.

PCA-A24KA7.TH

PCA-A30KA7.TH

PCA-A36KA7.TH

PCA-A42KA7.TH

The black square (■) indicates a switch position.

Jumper wire (○: Short ×: Open)

Jumper wire	Functions	Setting by the DIP switch and jumper wire	Remarks																																																										
SW1	Model settings	<p>For service board</p> <table border="1"> <thead> <tr> <th>MODEL</th> <th>SETTING</th> </tr> </thead> <tbody> <tr> <td>PCA-A·KA7</td> <td> <table border="1"> <tr> <td>1</td><td>2</td><td>3</td><td>4</td><td>5</td> <td>ON</td> </tr> <tr> <td>■</td><td>■</td><td>■</td><td>■</td><td>□</td> <td>OFF</td> </tr> </table> </td> </tr> </tbody> </table>	MODEL	SETTING	PCA-A·KA7	<table border="1"> <tr> <td>1</td><td>2</td><td>3</td><td>4</td><td>5</td> <td>ON</td> </tr> <tr> <td>■</td><td>■</td><td>■</td><td>■</td><td>□</td> <td>OFF</td> </tr> </table>	1	2	3	4	5	ON	■	■	■	■	□	OFF																																											
MODEL	SETTING																																																												
PCA-A·KA7	<table border="1"> <tr> <td>1</td><td>2</td><td>3</td><td>4</td><td>5</td> <td>ON</td> </tr> <tr> <td>■</td><td>■</td><td>■</td><td>■</td><td>□</td> <td>OFF</td> </tr> </table>	1	2	3	4	5	ON	■	■	■	■	□	OFF																																																
1	2	3	4	5	ON																																																								
■	■	■	■	□	OFF																																																								
SW2	Capacity settings	<table border="1"> <thead> <tr> <th>MODEL</th> <th>Service board</th> </tr> </thead> <tbody> <tr> <td>PCA-A24KA7</td> <td> <table border="1"> <tr> <td>1</td><td>2</td><td>3</td><td>4</td><td>5</td> <td>ON</td> </tr> <tr> <td>■</td><td>■</td><td>■</td><td>■</td><td>□</td> <td>OFF</td> </tr> </table> </td> </tr> <tr> <td>PCA-A30KA7</td> <td> <table border="1"> <tr> <td>1</td><td>2</td><td>3</td><td>4</td><td>5</td> <td>ON</td> </tr> <tr> <td>■</td><td>■</td><td>■</td><td>■</td><td>□</td> <td>OFF</td> </tr> </table> </td> </tr> <tr> <td>PCA-A36KA7</td> <td> <table border="1"> <tr> <td>1</td><td>2</td><td>3</td><td>4</td><td>5</td> <td>ON</td> </tr> <tr> <td>■</td><td>■</td><td>■</td><td>■</td><td>□</td> <td>OFF</td> </tr> </table> </td> </tr> <tr> <td>PCA-A42KA7</td> <td> <table border="1"> <tr> <td>1</td><td>2</td><td>3</td><td>4</td><td>5</td> <td>ON</td> </tr> <tr> <td>■</td><td>■</td><td>■</td><td>■</td><td>□</td> <td>OFF</td> </tr> </table> </td> </tr> </tbody> </table>	MODEL	Service board	PCA-A24KA7	<table border="1"> <tr> <td>1</td><td>2</td><td>3</td><td>4</td><td>5</td> <td>ON</td> </tr> <tr> <td>■</td><td>■</td><td>■</td><td>■</td><td>□</td> <td>OFF</td> </tr> </table>	1	2	3	4	5	ON	■	■	■	■	□	OFF	PCA-A30KA7	<table border="1"> <tr> <td>1</td><td>2</td><td>3</td><td>4</td><td>5</td> <td>ON</td> </tr> <tr> <td>■</td><td>■</td><td>■</td><td>■</td><td>□</td> <td>OFF</td> </tr> </table>	1	2	3	4	5	ON	■	■	■	■	□	OFF	PCA-A36KA7	<table border="1"> <tr> <td>1</td><td>2</td><td>3</td><td>4</td><td>5</td> <td>ON</td> </tr> <tr> <td>■</td><td>■</td><td>■</td><td>■</td><td>□</td> <td>OFF</td> </tr> </table>	1	2	3	4	5	ON	■	■	■	■	□	OFF	PCA-A42KA7	<table border="1"> <tr> <td>1</td><td>2</td><td>3</td><td>4</td><td>5</td> <td>ON</td> </tr> <tr> <td>■</td><td>■</td><td>■</td><td>■</td><td>□</td> <td>OFF</td> </tr> </table>	1	2	3	4	5	ON	■	■	■	■	□	OFF	
MODEL	Service board																																																												
PCA-A24KA7	<table border="1"> <tr> <td>1</td><td>2</td><td>3</td><td>4</td><td>5</td> <td>ON</td> </tr> <tr> <td>■</td><td>■</td><td>■</td><td>■</td><td>□</td> <td>OFF</td> </tr> </table>	1	2	3	4	5	ON	■	■	■	■	□	OFF																																																
1	2	3	4	5	ON																																																								
■	■	■	■	□	OFF																																																								
PCA-A30KA7	<table border="1"> <tr> <td>1</td><td>2</td><td>3</td><td>4</td><td>5</td> <td>ON</td> </tr> <tr> <td>■</td><td>■</td><td>■</td><td>■</td><td>□</td> <td>OFF</td> </tr> </table>	1	2	3	4	5	ON	■	■	■	■	□	OFF																																																
1	2	3	4	5	ON																																																								
■	■	■	■	□	OFF																																																								
PCA-A36KA7	<table border="1"> <tr> <td>1</td><td>2</td><td>3</td><td>4</td><td>5</td> <td>ON</td> </tr> <tr> <td>■</td><td>■</td><td>■</td><td>■</td><td>□</td> <td>OFF</td> </tr> </table>	1	2	3	4	5	ON	■	■	■	■	□	OFF																																																
1	2	3	4	5	ON																																																								
■	■	■	■	□	OFF																																																								
PCA-A42KA7	<table border="1"> <tr> <td>1</td><td>2</td><td>3</td><td>4</td><td>5</td> <td>ON</td> </tr> <tr> <td>■</td><td>■</td><td>■</td><td>■</td><td>□</td> <td>OFF</td> </tr> </table>	1	2	3	4	5	ON	■	■	■	■	□	OFF																																																
1	2	3	4	5	ON																																																								
■	■	■	■	□	OFF																																																								
J41 J42	Pair number setting with IR wireless remote controller	<table border="1"> <thead> <tr> <th rowspan="2">Wireless remote controller setting</th> <th colspan="2">Control PCB setting</th> </tr> <tr> <th>J41</th> <th>J42</th> </tr> </thead> <tbody> <tr> <td>0</td> <td>○</td> <td>○</td> </tr> <tr> <td>1</td> <td>×</td> <td>○</td> </tr> <tr> <td>2</td> <td>○</td> <td>×</td> </tr> <tr> <td>3-9</td> <td>×</td> <td>×</td> </tr> </tbody> </table>	Wireless remote controller setting	Control PCB setting		J41	J42	0	○	○	1	×	○	2	○	×	3-9	×	×	<p>&lt;Initial setting&gt;                      IR wireless remote controller: 0                      Control PCB: ○ (for both J41 and J42)                      4 pair number settings are supported.                      The pair number settings of the wireless remote controller and indoor control PCB (J41/J42) are given in the table on the left.                      ('×' in the table indicates the jumper line is disconnected.)</p>																																									
Wireless remote controller setting	Control PCB setting																																																												
	J41	J42																																																											
0	○	○																																																											
1	×	○																																																											
2	○	×																																																											
3-9	×	×																																																											
JP1	Unit type setting	<table border="1"> <thead> <tr> <th>Model</th> <th>JP1</th> </tr> </thead> <tbody> <tr> <td>Without TH5</td> <td>○</td> </tr> <tr> <td>With TH5</td> <td>×</td> </tr> </tbody> </table>	Model	JP1	Without TH5	○	With TH5	×	There is no jumper (JP1) because these models have the cond./eva. temperature thermistor (TH5).																																																				
Model	JP1																																																												
Without TH5	○																																																												
With TH5	×																																																												
JP3	Indoor controller board type setting	<table border="1"> <thead> <tr> <th>Indoor controller board type</th> <th>JP3</th> </tr> </thead> <tbody> <tr> <td>For product</td> <td>○</td> </tr> <tr> <td>Spare parts</td> <td>○</td> </tr> </tbody> </table>	Indoor controller board type	JP3	For product	○	Spare parts	○	○: with JP3 ×: without JP3																																																				
Indoor controller board type	JP3																																																												
For product	○																																																												
Spare parts	○																																																												

**10-1. UNIT FUNCTION SETTING BY THE REMOTE CONTROLLER**

Each function can be set as necessary using the remote controller. The setting of function for each unit can only be done by the remote controller.

(1) Functions available when setting the unit number to 00  
Refer to the service manual that comes with each outdoor unit.

(2) Functions available when setting the unit number to 01–03 or AL (07 in case of wireless remote controller)

Function	Settings	Mode No.	Setting No.	Initial setting	Setting
Filter sign	100 Hr	07	1		
	2500 Hr		2	○	
	No filter sign indicator		3		
Fan speed	Silent	08	1		
	Standard		2	○	
	High ceiling		3		
Up/down vane setting	No vanes	11	1		
	Equipped with vanes (vaner angle setup ①)		2	○	
	Equipped with vanes (vaner angle setup ②)		3		

## 11-1. Rotation Function (and back-up function, 2nd stage cut-in function)

This function is only available when using wired remote controller.

### 11-1-1. Operation

#### (1) Rotation function (and Back-up function)

##### • Outline of functions

- Main and sub units operate alternately according to the interval of rotation setting.  
Note: Main and sub unit should be set by refrigerant address. (Outdoor DIP switch setting)  
Refrigerant address "00" → Main unit  
Refrigerantant address "01" → Sub unit
- When error occurs to one unit, another unit will start operation. (Back-up function)

##### • System constraint

- This function is available only by the grouping control system (INDOOR UNIT: OUTDOOR UNIT=1:1) of 2 refrigerant groups. (Refer to Fig. 1)
- Main indoor unit should be connected for wired remote controller and the transmission line (TB5) for main and sub unit should also be connected. (Refer to Fig. 1)  
(This function cannot be set by IR wireless remote controller.)
- Set refrigerant address of each unit. (DIP switch on the outdoor unit ... Refrigerant address 00/01)

#### Operation pattern

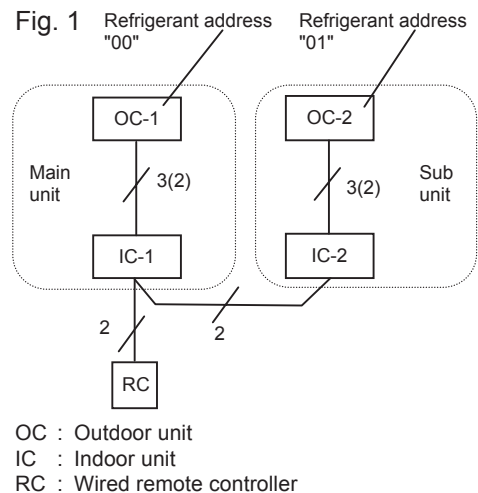
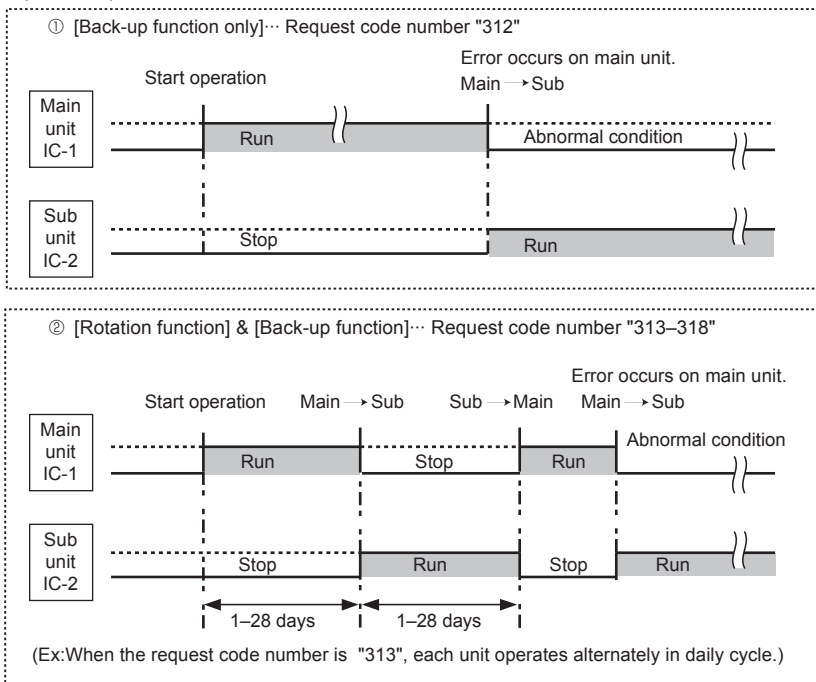

#### Note:

- When the unit is restarted to operate after turning off the power or OFF operation, the unit which was operating will start operation.
- To operate the main unit, refer to "11-1-2. How to set rotation function (Back-up function, 2nd stage cut-in function)", and set the request code No. which is not the same as the current one, and set again the former request code No.

#### (2) 2nd stage cut-in function

##### • Outline of functions

- When the 1st unit can NOT supply with sufficient capacity for exceptionally high-demand conditions and the actual room temperature reaches set point \*, the 2nd unit starts operation in conjunction with the 1st unit.
- Once the actual room temperature goes down to 7.2°F [4°C] below set point\*, the 2nd unit stops operation automatically.  
(\* set point = set temperature by R/C (remote controller) + 7.2, 10.8, 14.4°F [4, 6, 8°C] (selectable))
- Number of operating units is determined according to the room temperature and set point.
- When room temperature becomes higher than set point, standby unit starts. (2 units operation)
- When room temperature falls below set point -7.2°F [-4°C], standby unit stops. (1 unit operation)

• **System constraint**

· This function is available only in cooling mode.

Ex.) Set temp. by R/C = 68°F [20°C]  
 Set point = 79°F [26°C]  
 When request code number is "323".

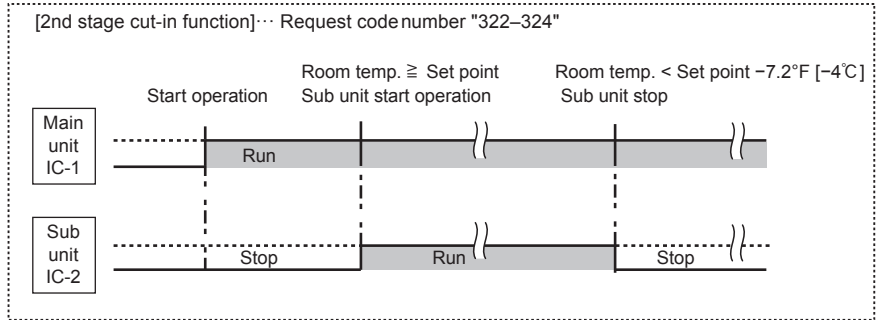
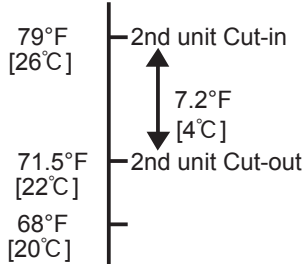

**11-1-2. How to set rotation function (Back-up function, 2nd stage cut-in function)**

You can set these functions by wired remote controller. (Maintenance monitor)

**NOTE**

Both main and sub unit should be set in same setting.  
 Every time replacing indoor controller board for servicing, the function should be set again.

**(1) Request Code List**

Rotation setting

Setting No. (Request code)	Setting contents	Initial setting
No.1 (310)	Monitoring the request code of current setting	
No.2 (311)	Rotation and Back-up OFF (Normal group control operation)	⊙
No.3 (312)	Back-up function only	
No.4 (313)	Rotation ON (Alternating interval = 1day) and back up function	
No.5 (314)	Rotation ON (Alternating interval = 3day) and back up function	
No.6 (315)	Rotation ON (Alternating interval = 5day) and back up function	
No.7 (316)	Rotation ON (Alternating interval = 7day) and back up function	
No.8 (317)	Rotation ON (Alternating interval = 14day) and back up function	
No.9 (318)	Rotation ON (Alternating interval = 28day) and back up function	









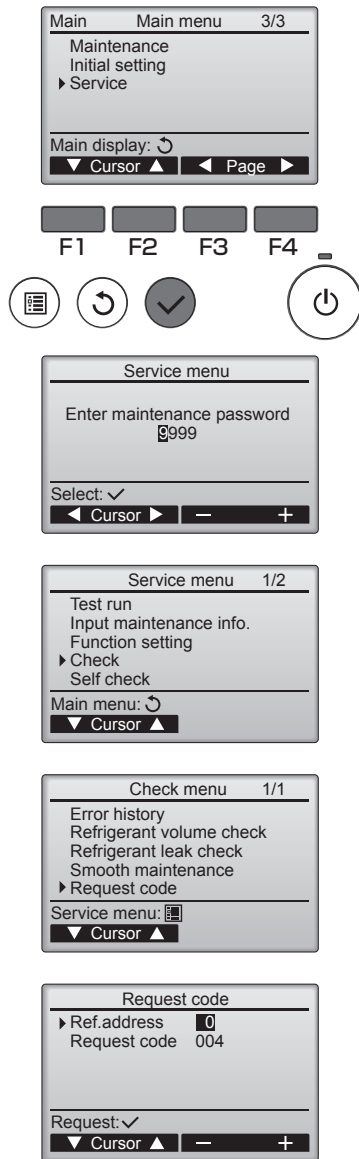



















2nd stage cut-in setting

Setting No. (Request code)	Setting contents	Initial setting
No.1 (320)	Monitoring the request code of current setting	
No.2 (321)	Cut-in function OFF	⊙
No.3 (322)	Cut-in Function ON(Set point = Set temp.+ 7.2°F [4°C])	
No.4 (323)	Cut-in Function ON(Set point = Set temp.+ 10.8°F [6°C])	
No.5 (324)	Cut-in Function ON(Set point = Set temp.+ 14.4°F [8°C])	

## (2) Rotation and back up operation

### PAR-3xMAA ("x" represents 0 or later)



- ① Press the  button.
- ② Select "Service" with the [Cursor] buttons (  and  ) or the [Page] buttons (  and  ), and press the  button.
- ③ Enter the current maintenance password (4 numerical digits).
  - Move cursor to the digit you want to change with the  or  button.
  - Set each number (0 through 9) with the  or  button.  
(Note: The initial maintenance password is "9999".)
- ④ Then, press the  button.
- ⑤ Select "Check" with the  or  button, and press the  button.
- ⑥ Select "Request code" with the  or  button, and press the  button.
- ⑦ Set the Refrigerant address and Request code.
  - Select the item to be changed with the  or  button.
  - Select the required setting with the  or  button.
- ⑧ Press the  or  button to set the Refrigerant address "0".
- ⑨ Press the  or  button to set the desired request code No.
  - Rotation & Back up operation: Enter one request code from 311–318.
  - 2nd stage cut-in operation: Enter one request code from 321–324.
- ⑩ Press the  button. Data will be collected and displayed.
- ⑪ Press the  or  button to set the Refrigerant address "1".  
Set above ⑨–⑩.
- ⑫ To return to the Main menu, press the  button.

## 11-2. BACK-UP HEATING FUNCTION

### 11-2-1. Operation

The back-up heater turns ON when both of the following conditions have been satisfied:

A) When the room temperature has not risen after the heater ON delay time has passed.

Note: The heater ON delay time starts when the condition of “set temperature – room temperature > 1°F [0.5°C]” has been satisfied.

B) Set temperature – room temperature  $\geq$  3°F [1.5°C]

The back-up heater turns OFF when the following condition has been satisfied:

• Set temperature – room temperature  $\geq$  1°F [0.5°C]

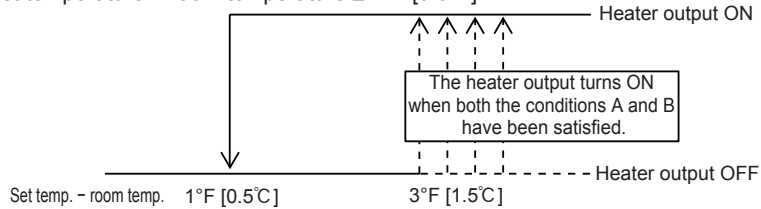

### 11-2-2. How to change the heater ON delay time

You can set these function by wired remote controller.

Note that the change can be made only by the wired remote controller PAR-32MAA.

Notes:

1. Both main and sub unit should be set in the same setting.
2. Every time replacing indoor controller board for serving, the function should be set again.
3. Stop the air-conditioner operation before changing the heater ON delay time.

### Request code list

Setting No. (Request code)	Setting contents	Initial setting
No.1 (390)	Monitoring the request code of current setting	
No.2 (391)	10 minutes	
No.3 (392)	15 minutes	
No.4 (393)	20 minutes	○
No.5 (394)	25 minutes	

### 11-2-3. How to connect

When connecting to the connector CN24 of the indoor unit, use PAC-SE56RA-E (optional parts).

Note: For a twin indoor unit system, connect to the CN24 of the indoor unit that the remote controller is connected to.

PCA-A24KA7.TH  
PCA-A36KA7.TH

PCA-A30KA7.TH  
PCA-A42KA7.TH

Be careful when removing heavy parts.  
(Photo: PCA-A36KA7)

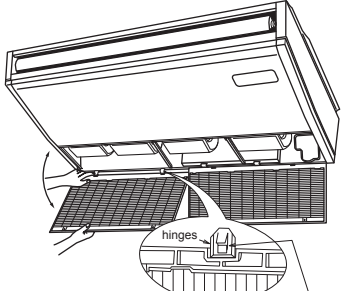
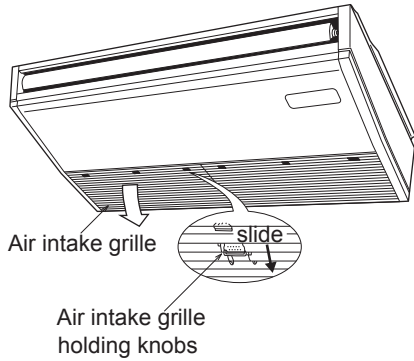
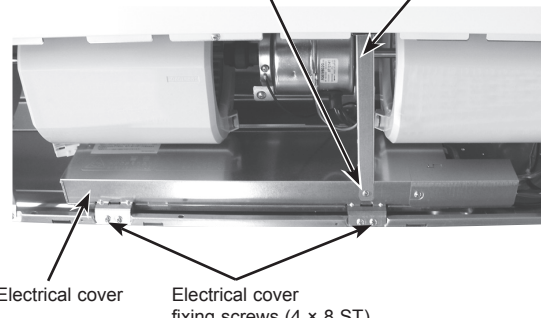
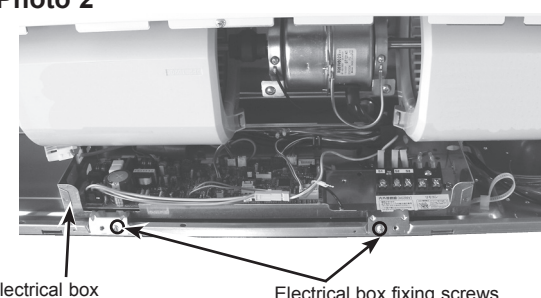
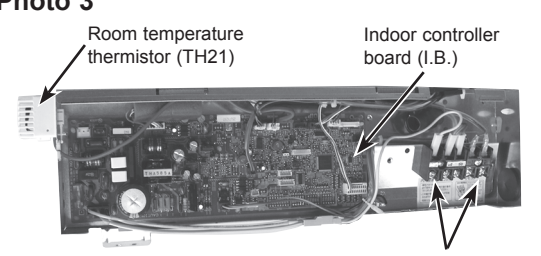
OPERATING PROCEDURE	PHOTOS & ILLUSTRATIONS
<p><b>1. Removing the air intake grille</b></p> <p>(1) Slide the air intake grille holding knobs (at 2 or 3 locations) to the rear to open the air intake grille. (See Figure 1)</p> <p>(2) While the air intake grille left open, push the stoppers on the rear hinges (at 2 or 3 locations) to pull out the air intake grille. (See Figure 2)</p> <p><b>Figure 2</b></p>  <p>Pull out the air intake grille</p>	<p><b>Figure 1</b></p>  <p>Air intake grille</p> <p>slide</p> <p>Air intake grille holding knobs</p>
<p><b>2. Removing the indoor controller board and the electrical box</b></p> <p>(1) Remove the air intake grille. (See Figure 1, 2)</p> <p>(2) Remove the beam by removing 1 screw (4 × 8 PT) (See Photo 1)</p> <p>(3) Remove 2 screws from the electrical cover, and remove the electrical cover.</p> <p>(4) Remove 2 screws from the electrical box and pull the electrical box downward. Temporarily secure the electrical box using 2 hooks in the back of electrical box.</p> <p>(5) Disconnect the connectors on the indoor controller board.</p> <p>[Removing the electrical box]</p> <p>(6) Disconnect the wires from the terminal blocks and pull out the electrical box. (See Photo 2)</p> <p>[Removing the indoor controller board]</p> <p>(6) Remove the 6 supports from the indoor controller board and remove the indoor controller board. (See Photo 3)</p>	<p><b>Photo 1</b></p>  <p>Beam fixing screw (4 × 8 PT)</p> <p>Beam</p> <p>Electrical cover</p> <p>Electrical cover fixing screws (4 × 8 ST)</p> <p><b>Photo 2</b></p>  <p>Electrical box</p> <p>Electrical box fixing screws</p> <p><b>Photo 3</b></p>  <p>Room temperature thermistor (TH21)</p> <p>Indoor controller board (I.B.)</p> <p>Terminal blocks (TB4) (TB5)</p>

## OPERATING PROCEDURE

### 3. Removing the room temperature thermistor (TH1)

- (1) Remove the air intake grille. (See Figure 1, 2)
- (2) Remove the beam by removing 1 screw (4 × 8 PT) (See Photo 1)
- (3) Remove 2 screws from the electrical cover, and remove the electrical cover.
- (4) Remove 2 screws from the electrical box and pull the electrical box downward.  
Temporarily secure the electrical box using 2 hooks in the back of electrical box.
- (5) Disconnect the connector CN20 (red) from the indoor controller board.
- (6) Remove the sensor holder from the electrical box and remove the thermistor from the holder.

### 4. Removing the fan motor and right side fan

- (1) Remove the air intake grille. (See Figure 1, 2)
- (2) Remove the beam by removing 1 screw (4 × 8 PT) (See Photo 1)
- (3) Remove 2 screws from the electrical cover, and remove the electrical cover.
- (4) Remove 2 screws from the electrical box and pull the electrical box downward.
- (5) Temporarily secure the electrical box using 2 hooks in the back of electrical box.
- (6) Remove the lower casing while pressing the 4 catches of the casing (right side of the fan motor). (See Photo 6)
- (7) Loosen the 2 set screws (2 hexagon set screws) of fan joint assy and slide the fan motor to the left. (See Photo 5)
- (8) Remove the screw for motor earth wire. (See Photo 5)
- (9) Remove the motor piece (left and right, each 1 screw). (See Photo 5)
- (10) Remove the fan motor and right side fan together.
- (11) Loosen the set screw (hexagon set screw) of fan and remove the fan from the shaft. (See Photo 7, 8)

Photo 8

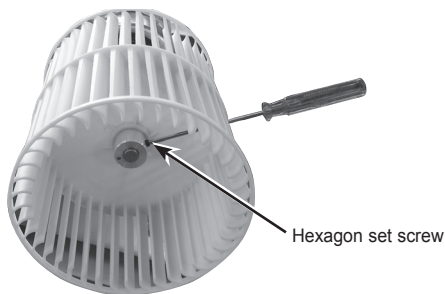

## PHOTOS

Photo 4

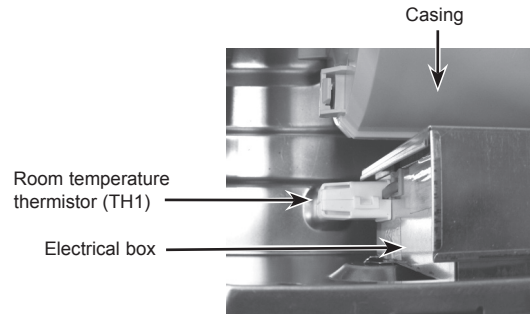

Photo 5

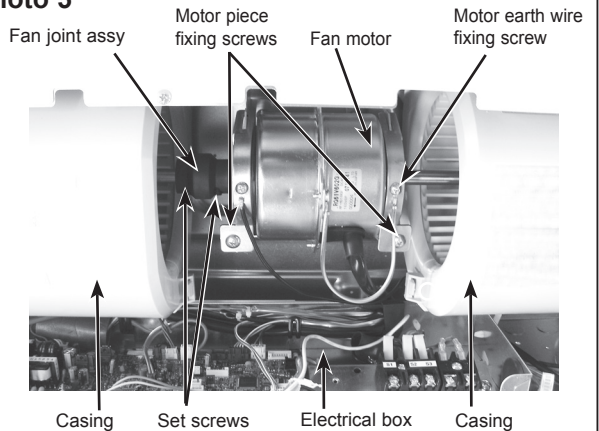

Photo 6

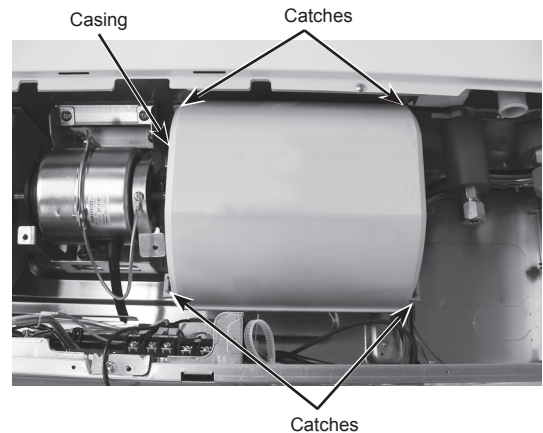
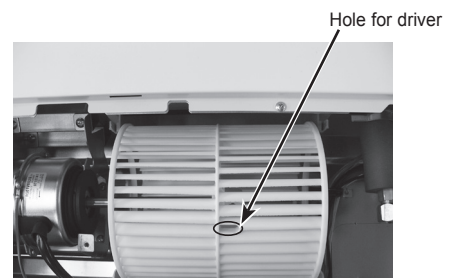

Photo 7



## OPERATING PROCEDURE

### 5. Removing the fan (3 connection)

- (1) Remove the air intake grille. (See Figure 1, 2)
- (2) Remove the beam by removing 1 screw (4 × 8 PT) (See Photo 1)
- (3) Remove 2 screws from the electrical cover, and remove the electrical cover.
- (4) Remove 2 screws from the electrical box and pull the electrical box downward.  
Temporarily secure the electrical box using 2 hooks in the back of electrical box.
- (5) Remove 2 screws from the left side beam and remove the beam. (See Photo 9)
- (6) Loosen 2 set screws (2 hexagon set screws) of connecting joint. (See Photo 5)
- (7) Remove 3 lower casings while pressing each 4 catches of the casing. (See Photo 6)
- (8) Remove the 4 screws from the bearing support. (See Photo 10)
- (9) Slide the connecting joint to the left and remove the fans and shaft together. (See Photo 11)
- (10) Remove the fans from the shaft. (See Photo 7,8 )

Photo 11

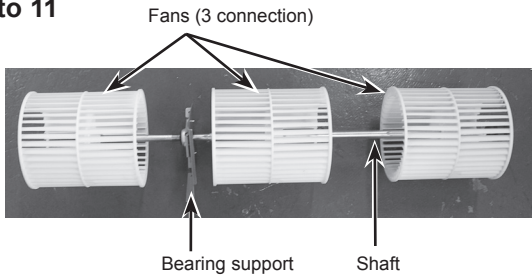

## PHOTOS & ILLUSTRATIONS

Photo 9

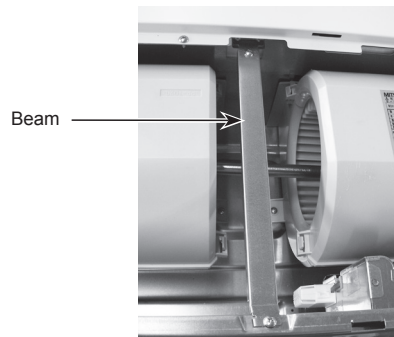
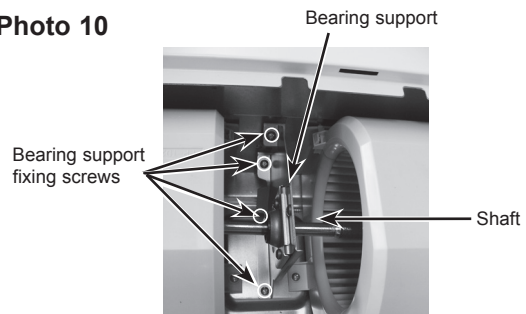

Photo 10



### 6. Removing the side panel

- (1) Remove the air intake grille. (See Figure 1, 2)
- (2) Remove the screws from the side panel, and remove the side panel by sliding the panel to the front.
- (3) Unhook the side panel support hanger, and then slide the side panel forward to remove it.

Figure 3

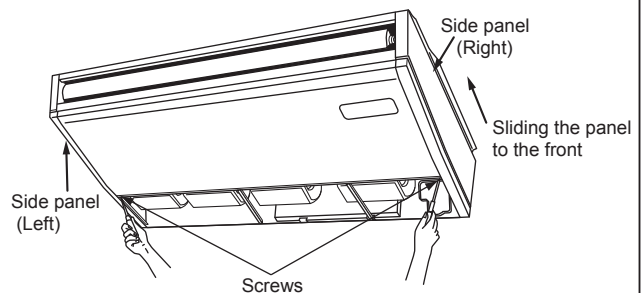
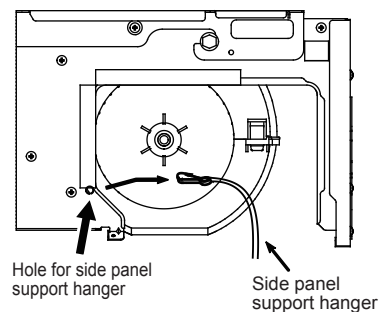

Figure 4



## OPERATING PROCEDURE

### 7. Removing the vane motor

- (1) Remove the air intake. (See Figure 1, 2)
- (2) Remove the right side panel. (See Figure 3, 4)
- (3) Remove the connector of vane motor.
- (4) Remove 2 screws of vane motor cover, then remove vane motor.

Photo 12

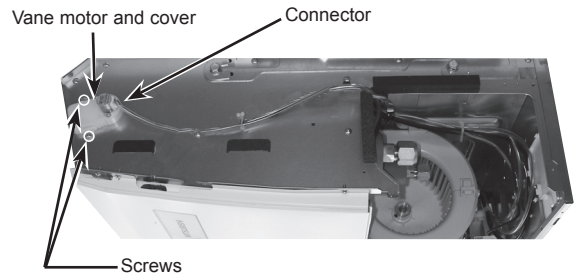

### 8. Removing the under panel

- (1) Remove the air intake grille. (See Figure 1, 2)
- (2) Remove the left and right side panels. (See Figure 3, 4)
- (3) Remove the beam. (See Photo 1)
- (4) Remove the electrical cover. (See Photo 1)
- (5) Pull the electrical box downward. (See Photo 2)
- (6) (Wireless remote controller receiver type only)  
Disconnect the connector CNB from the PCB for wireless remote controller and remove the clamp and strap for wires.
- (7) Remove 8 screws from the under panel.
- (8) Move the under panel forward by about 7/16 in. (10 mm) and remove the under panel.

Photo 13

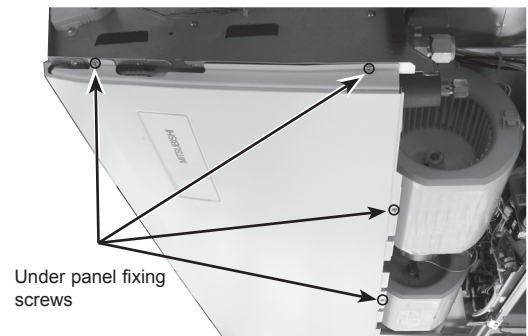

### 9. Removing the drain pan

- (1) Remove the air intake grille. (See Figure 1,2)
- (2) Remove the side panel (right and left). (See Figure 3, 4)
- (3) Remove the under panel. (See Photo 13)  
Remove the screws of the right and left side drain pan. (See Photo 14)
- (4) Remove 2 insulation in centre of the drain pan, and after removing 2 screws with washer, remove the drain pan. (See Photo 15,16)

Note: Please be aware that there might be some drainage left in the drain pan when you remove the drain pan.

Photo 14

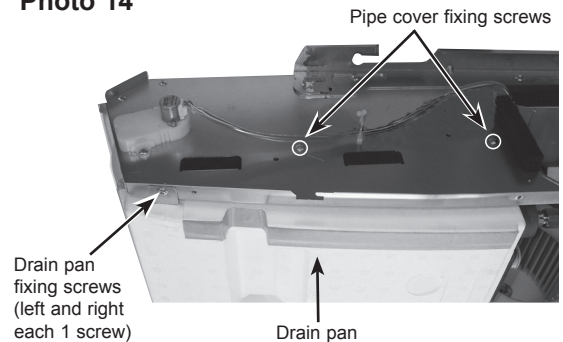

Photo 15

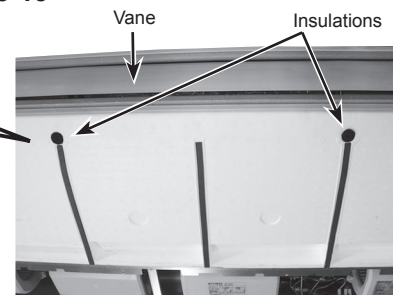
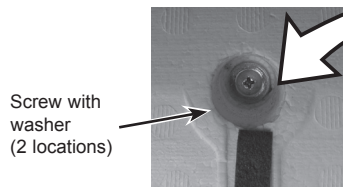

Photo 16



## OPERATING PROCEDURE

### 10. Removing the pipe temperature thermistor/liquid (TH2) and the condenser/evaporator temperature thermistor (TH5)

- (1) Remove the air intake grille. (See Figure 1, 2)
- (2) Remove the left and right side panels. (See Figure 3, 4)
- (3) Remove the under panel. (See Photo 13)
- (4) Remove the drain pan. (See Photo 14, 15, 16)
- (5) Disconnect the connector CN44 (white) from the indoor controller board.
- (6) Remove 6 screws from the pipe cover and remove the pipe cover. (See Photo 14, 17)
- (7) Remove the fastener for wires and remove the thermistors (TH2 and TH5) from each holder. (See Photo 18)

## PHOTOS

Photo 17

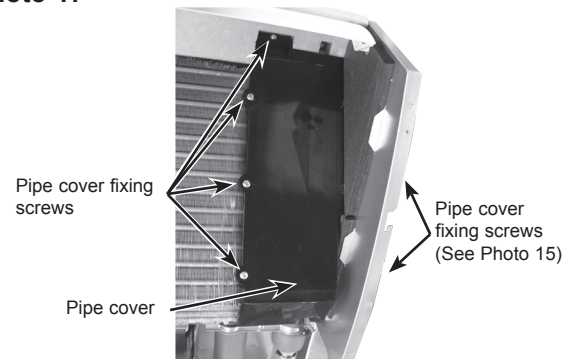
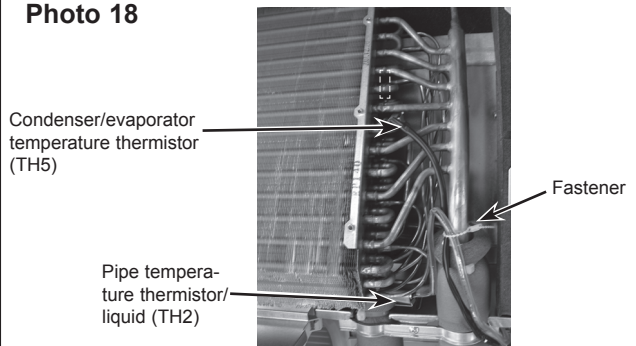

Photo 18



### 11. Removing the guide vane

- (1) Remove the intake grille. (See Figure 1, 2)
- (2) Remove the side panel (right and left). (See Figure 3, 4)
- (3) Remove the under panel. (See Photo 13)
- (4) Remove the drain pan. (See Photo 14, 15, 16)
- (5) Remove the screw from the guide vane, then remove the guide vane.

Photo 19

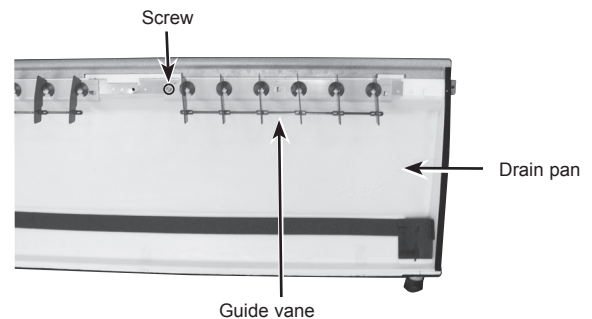

### 12. Removing the Auto vane

- (1) Remove the intake grille. (See Figure 1, 2)
- (2) Remove the right side panel. (See Figure 3, 4)
- (3) Remove the vane motor and cover. (See Photo 12)
- (4) Slide the auto vane to the vane motor side.
- (5) Remove 2 axes from each vane support pushing the vane support to the vane sleeve side.

Photo 20

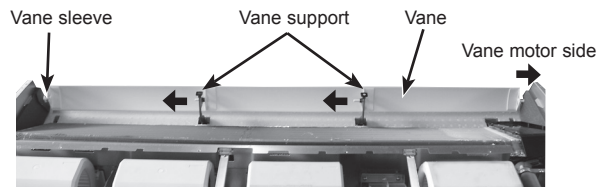

## OPERATING PROCEDURE

### 13. Removing the heat exchanger

- (1) Remove the air intake grille. (See Figure 1, 2)
- (2) Remove the left and right side panels. (See Figure 3, 4)
- (3) Remove the under panel. (See Photo 13)
- (4) Remove the drain pan. (See Photo 14, 15, 16)
- (5) Remove the pipe cover. (See Photo 17)
- (6) Remove the pipe thermistors (TH2 and TH5) from each holder. (See Photo 18)
- (7) Remove the pipe band fixing screw and remove the pipe band. (See Photo 21)
- (8) Remove 3 screws from the heat exchanger and remove the heat exchanger. (See Photo 22)

#### <Caution>

To avoid falling of the heat exchanger, be sure to hold the heat exchanger by hand. For safety reasons, this procedure must be performed by two persons.

## PHOTOS

Photo 21

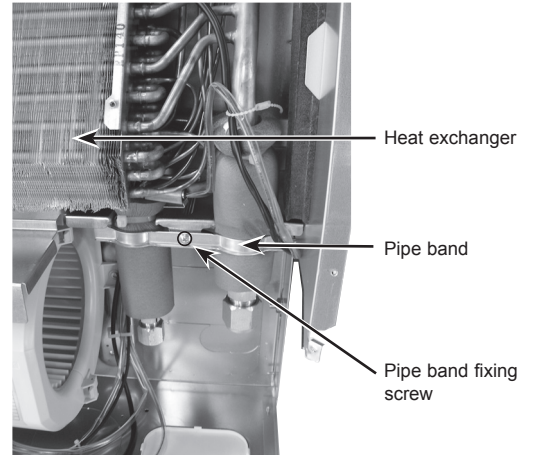
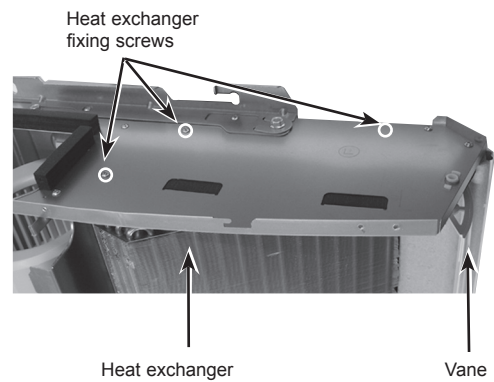

Photo 22



**Mr. SLIM**

**mitsubishi electric corporation**

HEAD OFFICE : TOKYO BUILDING, 2-7-3, MARUNOUCHI, CHIYODA-KU, TOKYO 100-8310, JAPAN

---