

# Service Manual

Applicable Model	Model Code
CE-BD84CM-MT	22031010000086
UR-BD84CM-ST	22031010000072

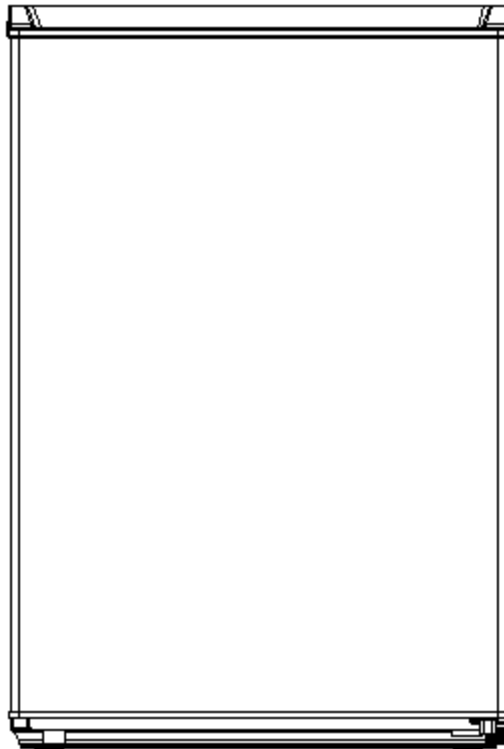

(The picture is only for reference, and specific appearance and configuration are subject to the real product)

Prepared by	R&D: Zhou Jiangjun
Reviewed by	QA: Wang Tao SVC: Chen Lei
Approved by	R&D: Tang Tao SVC: Guang Taoshuai



**Warning**

### **Important Safety Notice**

The Maintenance Manual is only for the use of maintenance personnel with certain experience and background in electrical, electronic and mechanical field.

Any attempt to repair main devices may lead to personal injury and property loss.

Manufacturers or distributors are not responsible for the content of the Manual and interpretation thereof.

### **Midea Refrigerators**

Technical Maintenance Manual

Copyright @2016

All rights reserved. Replication of all or part of the Manual in any forms shall not be allowed without written approval by the Overseas Sales Corporation of Midea Refrigerators.

# Contents

<b>1.SAFETY WARNING CODE .....</b>	<b>5</b>
1.1 WARNING FOR OPERATION SAFETY .....	5
1.2 SAFETY INSTRUCTION FOR REFRIGERANT .....	8
<b>2.DESCRPTION FOR PRODUCT FEATURES .....</b>	<b>9</b>
<b>3.INSTALLATION AND COMMISSIONING .....</b>	<b>10</b>
3.1 HANDLING .....	10
3.2 DISASSEMBLY (NONE).....	10
3.3 INSTALLATION LOCATION .....	10
3.4 LEVELING OF THE REFRIGERATOR.....	11
3.5 CHANGE THE DOOR OPENING DIRECTION.....	11
3.6 INSTALLATION OF HANDLE(NONE) .....	12
3.7 INSTALLATION OF DOOR LOCK(NONE) .....	12
3.8 ADJUSTMENT TO LEVEL THE DOOR(NONE) .....	12
3.9 ADJUSTMENT TO SHELVES(NONE) .....	12
<b>4.TERMS .....</b>	<b>13</b>
4.1 DEFINITION OF MODEL(NONE) .....	13
4.2 LOCATION OF NAMEPLATE.....	13
<b>5.PRODUCT SPECIFICATION .....</b>	<b>14</b>
5.1 TYPE SPECIFICATION(NONE) .....	14
5.2 ELECTRICAL PARAMETERS.....	14
5.3 REFRIGERATING TEMPERATURE.....	14
5.4 DEFROSTING PARTS(NONE) .....	14
5.5 CIRCUIT DIAGRAM.....	15
<b>6.INTERNAL VIEW AND DIMENSION .....</b>	<b>16</b>
6.1 MAIN PARTS AND THEIR NAMES.....	16
6.2 EXTERNAL DIMENSION .....	16
<b>7.REFRIGERATING PIPING SYSTEM AND CIRCULATING ROUTE OF COOLING AIR ..</b>	<b>17</b>
7.1 REFRIGERATING PIPING SYSTEM .....	17
7.2 CIRCULATING ROUTE OF COOLING AIR(NONE).....	18
<b>8. DISMANTLING OF PARTS .....</b>	<b>19</b>
8.1 PARTS ON THE DOOR .....	19
8.2 PARTS INSIDE THE REFRIGERATOR.....	19
8.3 LIGHT SYSTEM.....	19
8.4 AIR DUCT COMPONENTS REFRIGERATING CHAMBER.....	20
8.5 AIR DUCT COMPONENTS IN FREEZING CHAMBER AND FAN MOTOR.....	20

8.6EVAPORATOR AND TEMPERATURE SENSING SYSTEM .....	20
8.6COMPRESSOR CASE .....	21
8.7DISPLAY AND MAIN CONTROL PANEL(NONE) .....	22
8.8 BAR COUNTER(NONE) .....	22
8.9 WATER DISPENSER(NONE) .....	23
8.10 ICE MAKER(NONE) .....	23
<b>9. FUNCTION AND OPERATION .....</b>	<b>23</b>
9.1OPERATION PANEL .....	23
9.2TEMPERATURE CONTROL.....	23
9.3GIVE AN ALARM(NONE) .....	24
9.4FAILURE CODE AND SOLUTIONS(NONE).....	24
9.5DEFROST FUNCTION .....	24
9.6COMPRESSOR FAN CONTROL(NONE) .....	24
9.7TEST MODE (NONE).....	24
9.8SELF-DIAGNOSIS (NONE).....	24
<b>10.CIRCUIT DESCRIPTION .....</b>	<b>25</b>
10.1 POWER SUPPLY(NONE).....	25
10.2 TEST CIRCUIT FOR DOOR SWITCH(NONE).....	25
10.3 TEMPERATURE TEST CIRCUIT(NONE) .....	25
10.4FREEZER CHAMBER FAN MOTOR CIRCUIT (NONE).....	25
10.5REFRIGERATING CHAMBER FAN MOTOR CIRCUIT (NONE) .....	25
10.6CONDENSATION FAN CIRCUIT (NONE) .....	25
10.5 FAN MOTOR CIRCUIT OF THE VENTILATION DOOR(NONE) .....	25
10.6RESISTANCE VALUE OF THE SENSOR (R/T) (NONE).....	25
<b>11.TROUBLESHOOTING METHOD.....</b>	<b>25</b>
11.1 NOT COOLING .....	25
11.2 NOT WORKING OF COMPRESSOR .....	26
11.3 -THERMOSTAT MALFUNCTION-UNDERCOOLING.....	27
11.4 LIGHT IS NOT ON .....	27
11.5 NOISE .....	28
<b>12. FIGURES AND DETAILS OF REPAIR</b>	
<b>PARTS(DOCUMENTSAREPROVIDEDSEPARATELY) .....</b>	<b>29</b>
12.1FIGURES .....	29
12.2LIST OF PARTS AND COMPONENTS.....	29
<b>13APPENDIX:.....</b>	<b>29</b>
13.1ELECTRICAL SCHEMATIC DIAGRAM(NONE) .....	29
13.2REFRIGERATOR MAINTENANCE TOOLING AND EQUIPMENT AND MATERIAL .....	29

## 1.Safety Warning Code

### 1.1 Warning for operation safety

## Important Safety Instructions

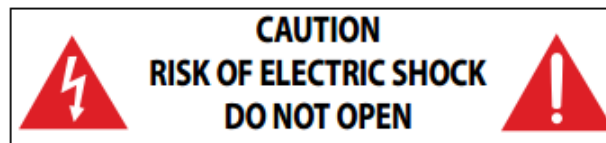

This symbol indicates that dangerous voltage constituting a risk of electric shock is present within your freezer.



This symbol indicates that there are important operating and maintenance instructions in the literature accompanying your freezer.

### **WARNING**

- 1 Read these instructions.
- 2 Keep these instructions.
- 3 Heed all warnings.
- 4 Follow all instructions.
- 5 Do not use this appliance near water.
- 6 Clean only with a damp cloth.
- 7 Do not block any ventilation openings.
- 8 Install in accordance with the manufacturer's instructions.
- 9 Do not install near any heat sources, such as radiators, heat registers, stoves, or other apparatus that produce heat.
- 10 Do not defeat the safety purpose of the polarized or grounding-type plug. A polarized plug has two blades with one wider than the other. A grounding type plug has two blades and a third grounding prong. The wide blade or the third prong are provided for your safety. If the provided plug does not fit into your outlet, consult an electrician for replacement of the obsolete outlet.
- 11 Protect the power cord from being walked on or pinched, particularly at plugs, convenience receptacles, and the point where they exit from the appliance.
- 12 Do not attempt to modify or extend the power cord of this appliance.
- 13 Unplug this appliance during lightning storms or when it will not be used for long periods of time.
- 14 Make sure that the available AC power matches the voltage requirements of this appliance.

- 15 Do not handle the plug with wet hands. This could result in an electric shock.
- 16 Unplug the power cord by holding the plug, never by pulling the cord.
- 17 Do not turn the appliance on or off by plugging or unplugging the power cord.
- 18 Refer all servicing to qualified service personnel. Servicing is required when the appliance has been damaged in any way, such as the power-supply cord or plug is damaged, liquid has been spilled or objects have fallen into the appliance, the appliance has been exposed to rain or moisture, does not operate normally, or has been dropped.
- 19 To reduce the risk of fire or electric shock, do not expose this appliance to rain, moisture, dripping, or splashing, and no objects filled with liquids should be placed on top of it.
- 20 Do not use extension cords or ungrounded (two prong) adapters.
- 21 This appliance is not intended for use by persons (including children) with reduced physical, sensory or mental capabilities, or lack of experience and knowledge, unless they have been given supervision or instruction concerning use of the appliance by a person responsible for their safety.
- 22 Children should be supervised to ensure that they do not play with the appliance.
- 23 If the supply cord is damaged, it must be replaced by the manufacturer, its service agent, or similarly qualified person, in order to avoid a hazard.
- 24 Take off the doors and leave the shelves in place so that children may not easily climb inside.



## WARNING

### Electric Shock Hazard

**Failure to follow these instructions can result in electric shock, fire, or death.**

- 1 **WARNING**–Keep ventilation openings, in both the freezer and the built-in structure, clear of obstruction.
- 2 **WARNING**–Do not touch the interior of the freezer with wet hands. This could result in frost bite.
- 3 **WARNING**–Do not use mechanical devices or other means to accelerate the defrosting process, other than those recommended by the manufacturer.
- 4 **WARNING**–Do not damage the refrigerant circuit.

- 5 **WARNING**—Do not damage the refrigerant tubing when handling, moving, or using the freezer.
- 6 **WARNING–DANGER**—Never allow children to play with, operate, or crawl inside the freezer.  
Risk of child entrapment. Before you throw away your old freezer:
  - 1) Take off the doors
  - 2) Leave the shelves in place so that children may not easily climb inside
- 7 Unplug the freezer before carrying out user maintenance on it.
- 8 This freezer can be used by children age eight years and older and persons with reduced physical or mental capabilities or lack of experience and knowledge if they are given supervision or instruction concerning the use of the freezer in a safe way and understand the hazards involved. Children should not play with the freezer. Cleaning and maintenance should not be performed by children without supervision.
- 5 **WARNING**—Do not damage the refrigerant tubing when handling, moving, or using the freezer.
- 6 **WARNING–DANGER**—Never allow children to play with, operate, or crawl inside the freezer.  
Risk of child entrapment. Before you throw away your old freezer:
  - 1) Take off the doors
  - 2) Leave the shelves in place so that children may not easily climb inside
- 7 Unplug the freezer before carrying out user maintenance on it.
- 8 This freezer can be used by children age eight years and older and persons with reduced physical or mental capabilities or lack of experience and knowledge if they are given supervision or instruction concerning the use of the freezer in a safe way and understand the hazards involved. Children should not play with the freezer. Cleaning and maintenance should not be performed by children without supervision.
- 9 If a component part is damaged, it must be replaced by the manufacturer, its service agent, or similar qualified persons in order to avoid a hazard.
- 10 Please dispose of the freezer according to local regulations as the freezer contains flammable gas and refrigerant.
- 11 Follow local regulations regarding disposal of the freezer due to flammable refrigerant and gas. All refrigeration products contain refrigerants, which under the guidelines of federal law must be removed before disposal. It is the consumer's responsibility to comply with federal and local regulations when disposing of this product.

- 12** This freezer is intended to be used in household and similar environments.
- 13** Do not store or use gasoline or any flammable liquids inside or in the vicinity of this freezer.
- 14** Do not use extension cords or ungrounded (two-prong) adapters with this freezer. If the power cord is too short, have a qualified electrician install an outlet near the freezer. Use of an extension cord can negatively affect the freezer's performance.

### Grounding requirement

This freezer must be grounded. This freezer is equipped with a cord having a grounding wire with a grounding plug. The plug must be inserted into an outlet that is properly installed and grounded.

Improper use of the grounding plug can result in a risk of electric shock. Consult a qualified electrician or service person if the grounding instructions are not completely understood, or if doubt exists as to whether the freezer is properly grounded.

### 1.2 Safety instruction for refrigerant

**⚠ WARNING**  **Explosion Hazard.**

Keep flammable materials and vapors, such as gasoline, away from freezer. Failure to do so can result in fire, explosion, or death.

DANGER—Risk of Fire or Explosion. Flammable Refrigerant Used. To Be Repaired Only By Trained Service Personnel. Do Not Use Mechanical Devices. Do Not Puncture Refrigerant Tubing.  
 CAUTION—Risk of Fire or Explosion. Flammable Refrigerant Used. Consult Repair Manual/Owner's Guide Before Attempting To Service This Product. All Safety Precautions Must be Followed.  
 CAUTION—Risk of Fire or Explosion. Dispose of Properly In Accordance With Federal Or Local Regulations. Flammable Refrigerant Used.  
 CAUTION—Risk of Fire or Explosion Due To Puncture Of Refrigerant Tubing; Follow Handling Instructions Carefully. Flammable Refrigerant Used.



## 2. Description for product features

This product is provided with following features:

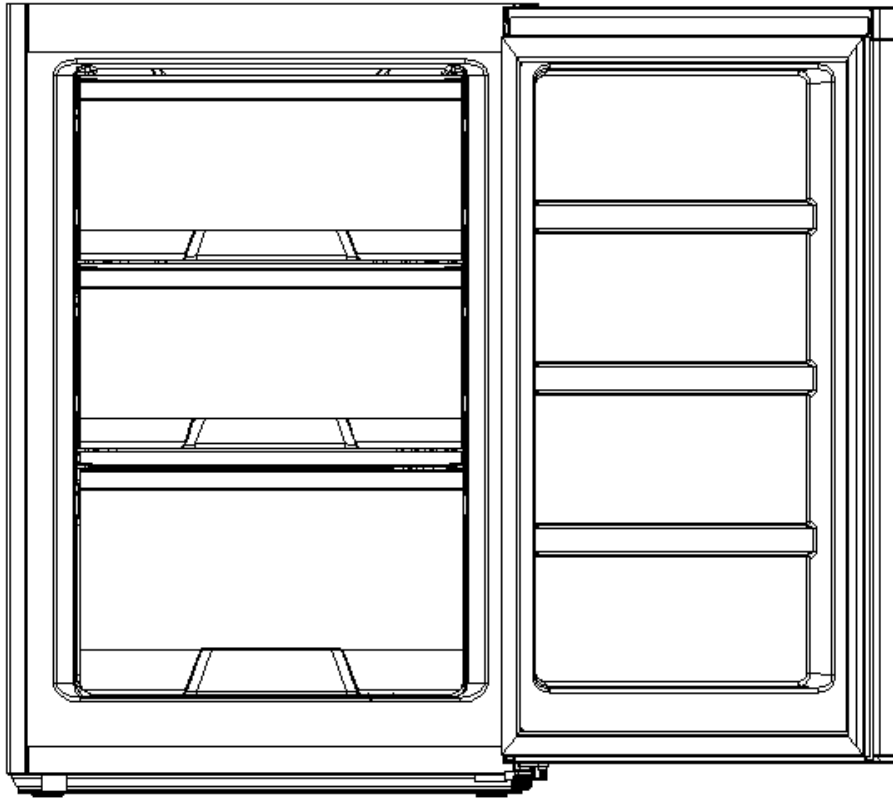

(The picture is only for reference, and specific appearance and configuration are subject to the real product)

- 1) Mechanical temperature control
- 2) Freezer room around the wire tube evaporator, cooling evenly and quickly;
- 3) Large drawers design, increase storage space
- 4) Change the door opening direction

### 3. Installation and commissioning

#### 3.1 Handling

<ol style="list-style-type: none"> <li>1) Protect the refrigerator in moving it. Same as shown in left photo, please move it by hand cart with cushion.</li> <li>2) Remove all packing materials and bottom cushion, then move into house for placement.</li> <li>3) After moving it to appropriate location, wait for 2 hours before power on.</li> </ol>	
--	--

#### 3.2 Disassembly (None)

The refrigerator door needs to be dismantled if it cannot enter the room in the whole.

#### 3.3 Installation location

<p>Location that is easy for ventilation shall be chosen to facilitate heat dissipation, enhance its performance and reduce the energy consumption.</p>	
---	--

### 3.4 Leveling of the refrigerator

If the refrigerator cannot be placed steadily, adjust the footing to level it.

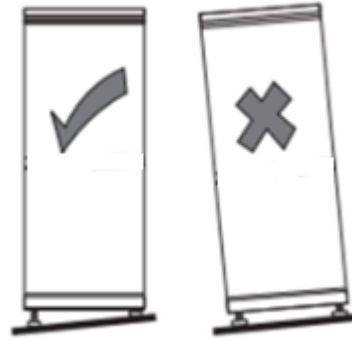

### 3.5 Change the door opening direction

1) Remove the hinge cover.  
Unscrew screws.  
Remove the upper hinge.

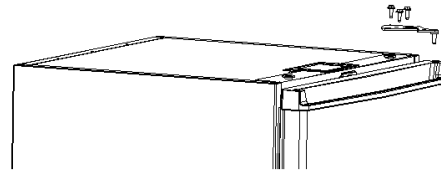

2) Remove the door.  
Unscrew screws and levelling feet.  
Remove the lower hinge adjust feet assembly.

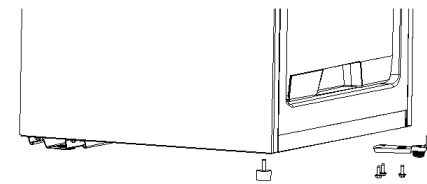

3) Fix the levelling feet, lower hinge adjust feet assembly and screws in the opposite side.

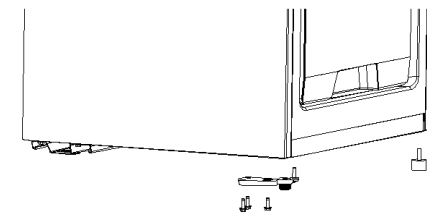

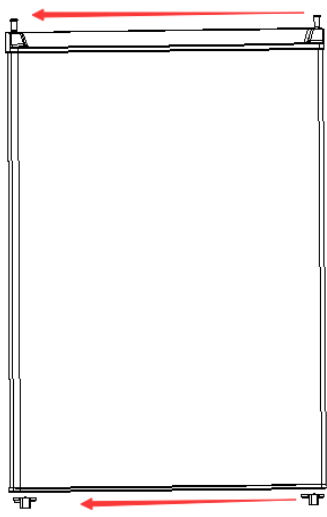
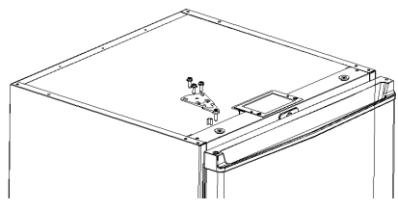
<p>4) Place the door stopper and axle sleeve in the opposite side.</p>	
<p>5) Place the F door. Place and fix the upper hinge. Fix the hinge cover.</p>	

**3.6 Installation of handle(None)**

**3.7 Installation of door lock(None)**

**3.8 Adjustment to level the door(None)**

**3.9 Adjustment to shelves(None)**

## **4.Terms**

### **4.1 Definition of model(None)**

### **4.2 Location of nameplate**

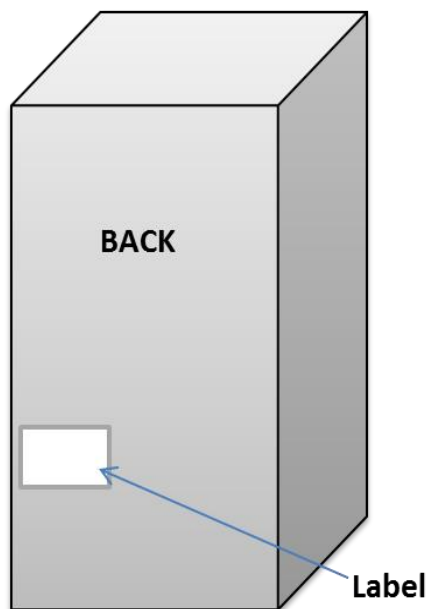

(The picture is only for reference, and specific appearance and configuration are subject to the real product)

## 5. Product specification

### 5.1 Typespecification(None)

### 5.2 Electrical parameters

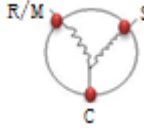
Product Name			CE-BD84CM-MT	UR-BD84CM-ST
Product Code			22031010000086	22031010000072
Name	Item	Type	Specification	Specification
Compressor	Compressor	/	SZ59E1HL	FZ40E1J
	Starter	PTC	8EA19C1/QP2-15/QP2-15	QP2-4R7
	Overload protector	OLP	4TM117NFBYY/DRB12 N61A1	DRB17N61A1
	Capacitor	/	/	/
	Winding resistance of compressor wiring terminal		Rmc: $43.6 \pm 7\% \Omega$ Rsc: $15.6 \Omega \pm 7\% \Omega$ Rms=Rmc+Rsc	Rmc: $14.4 \pm 7\% \Omega$ Rsc: $9.5 \pm 7\% \Omega$ Rms=Rmc+Rsc
Motor	Fan motor of the freezing chamber	/	/	/
	Ventilation door of the refrigerating chamber	/	/	/
	Condensation fan	/	/	/
Lights inside the refrigerator	Lights inside the freezing chamber	/	/	/
	Lights inside the refrigerating chamber	/	/	/
	Switch of the refrigerator door	/	/	/

### 5.3Refrigerating temperature

Temperature tolerance  $\leq 2^{\circ}\text{C}$

Compartment	The highest ( $^{\circ}\text{C}$ )	Lowest ( $^{\circ}\text{C}$ )
Freezing	-15	-23
Refrigerating	/	/
Variable temperature	/	/

### 5.4Defrosting parts(None)

Defrosting period	Initial defrosting period	Normal defrosting period
	/	/

Defrosting sensor	/	/
Defrosting temperature controller	/	/
Thermal fuse	/	/
Defrosting heater in freezing chamber	/	/

5.5 Circuit diagram

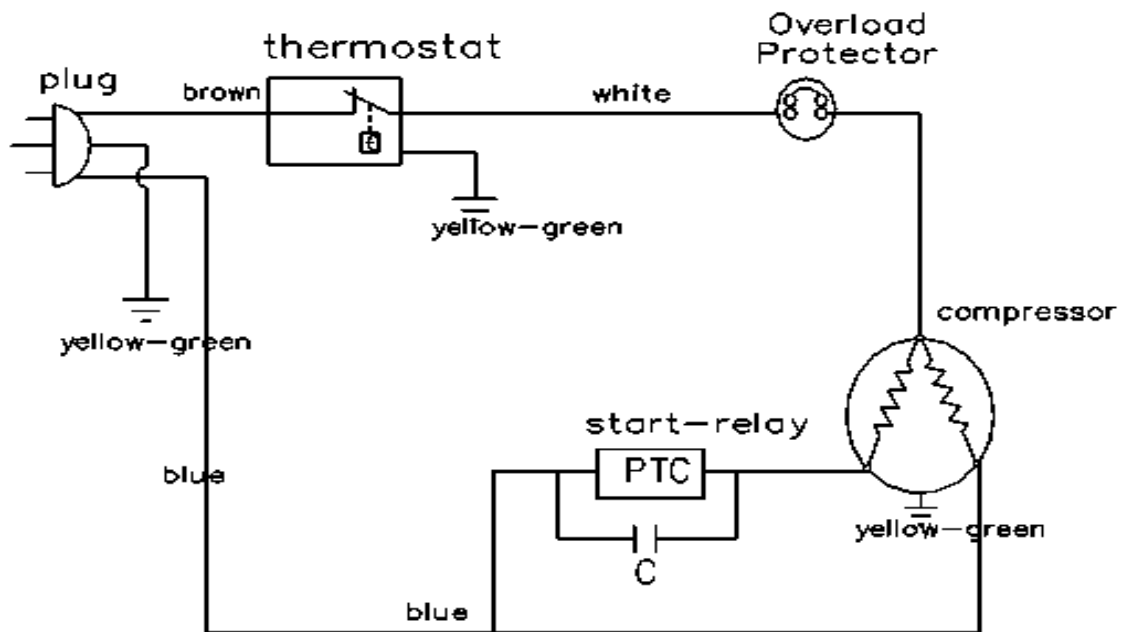

## 6. Internal view and dimension

### 6.1 Main parts and their names

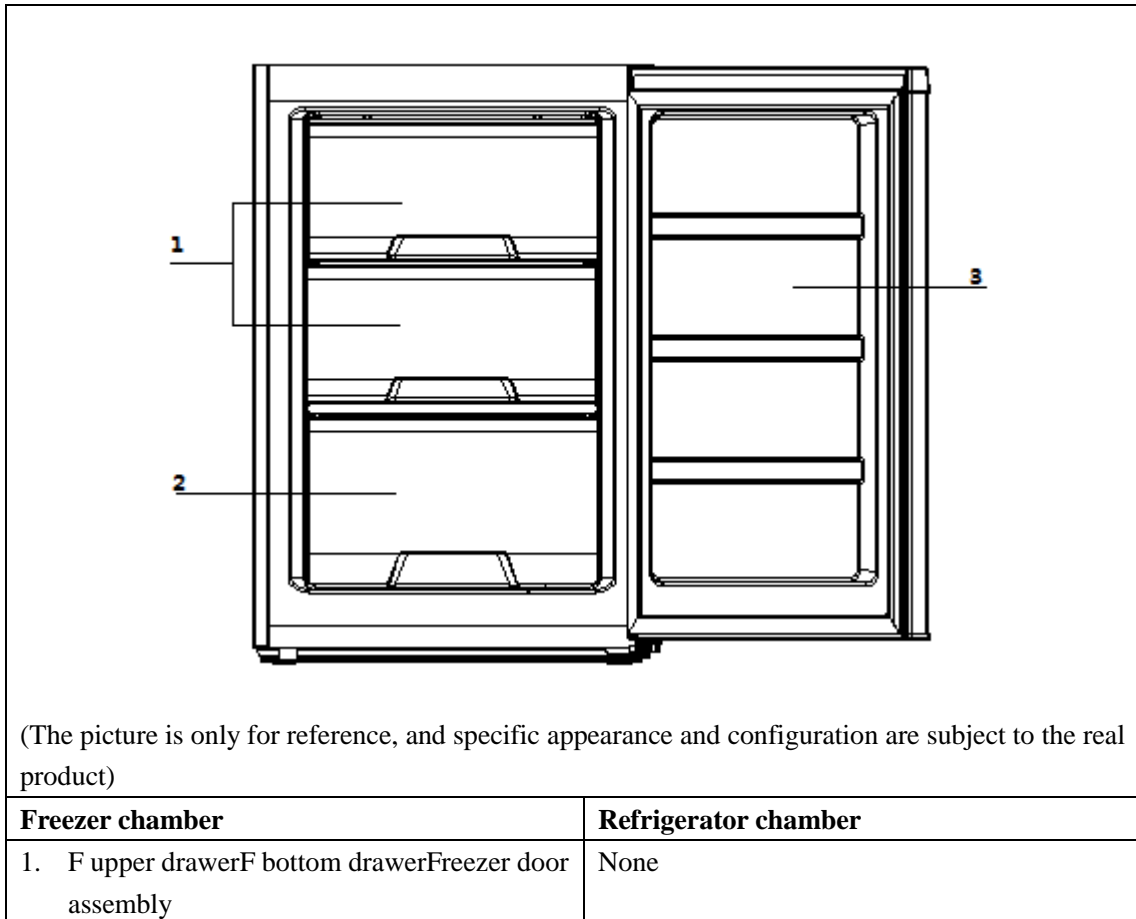

### 6.2 External dimension

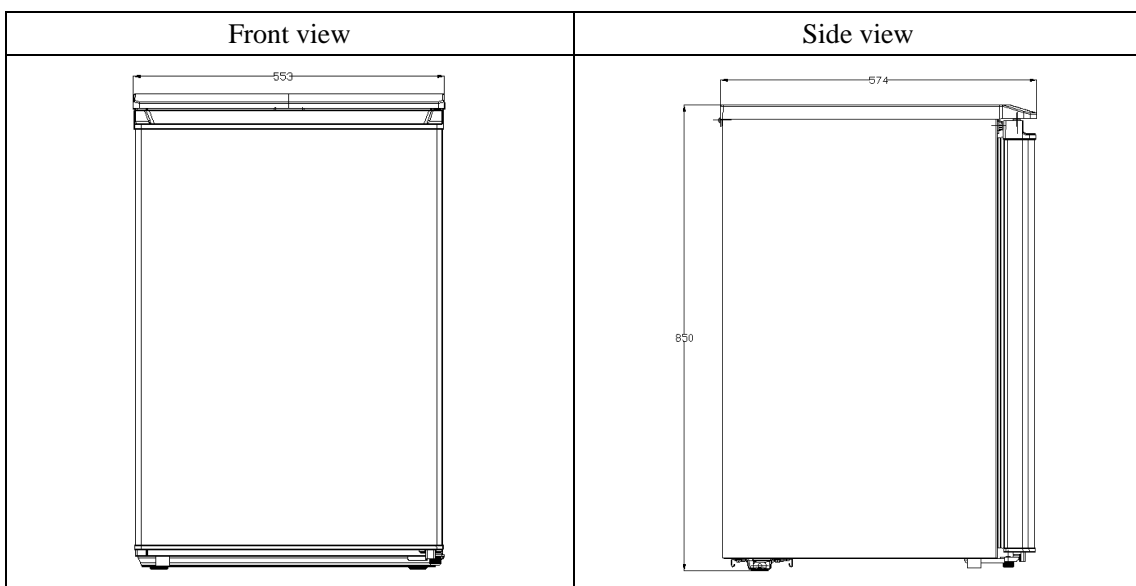

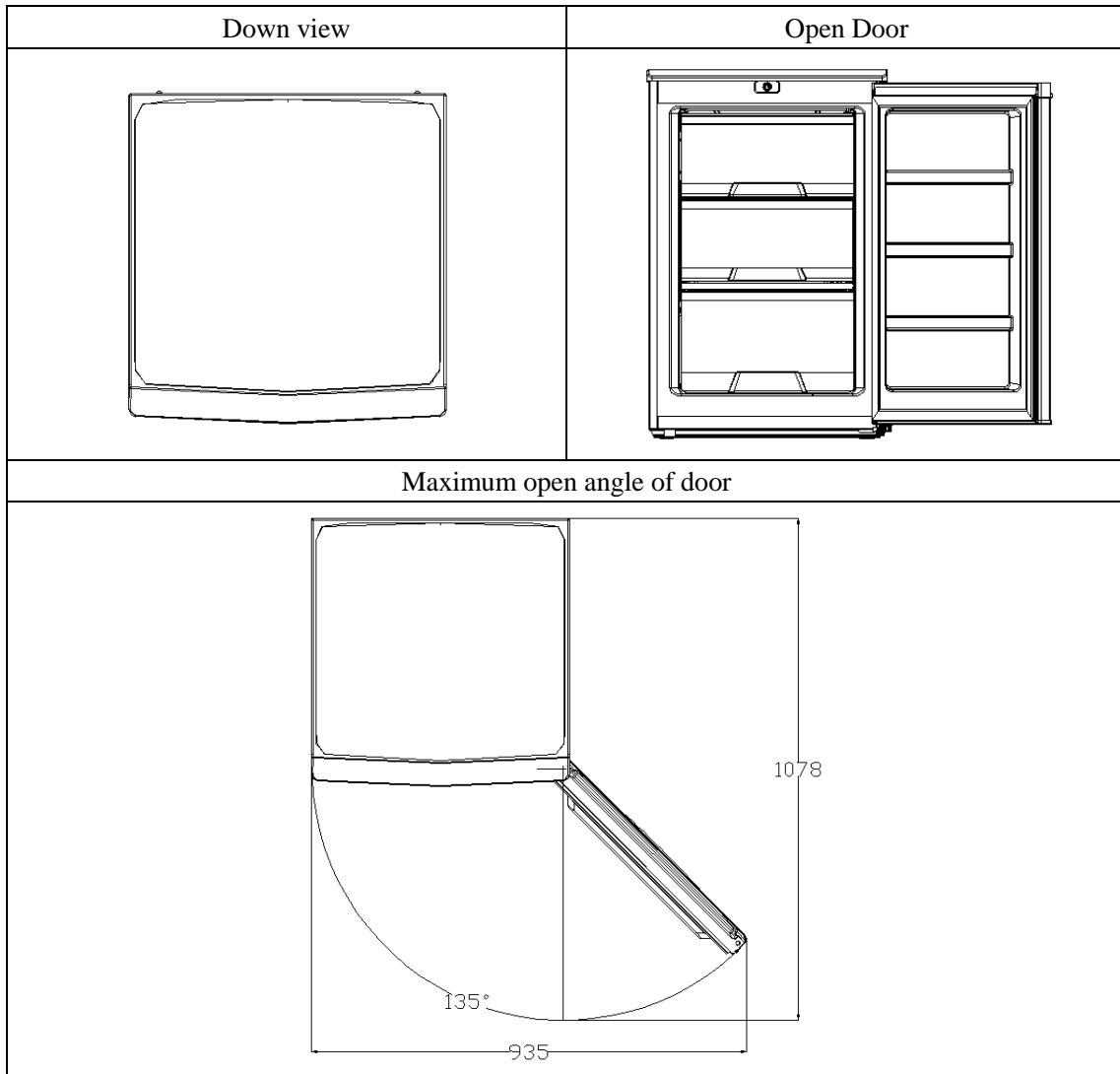

(The picture is only for reference, and specific appearance and configuration are subject to the real product)

## **7.Refrigerating piping system and circulating route of cooling air**

### **7.1 Refrigerating piping system**

1Compressor →2Left condenser →3Anti-condensation tube →4Right condenser →5Dry filter →6Capillary tube →7Evaporator →8Return pipe

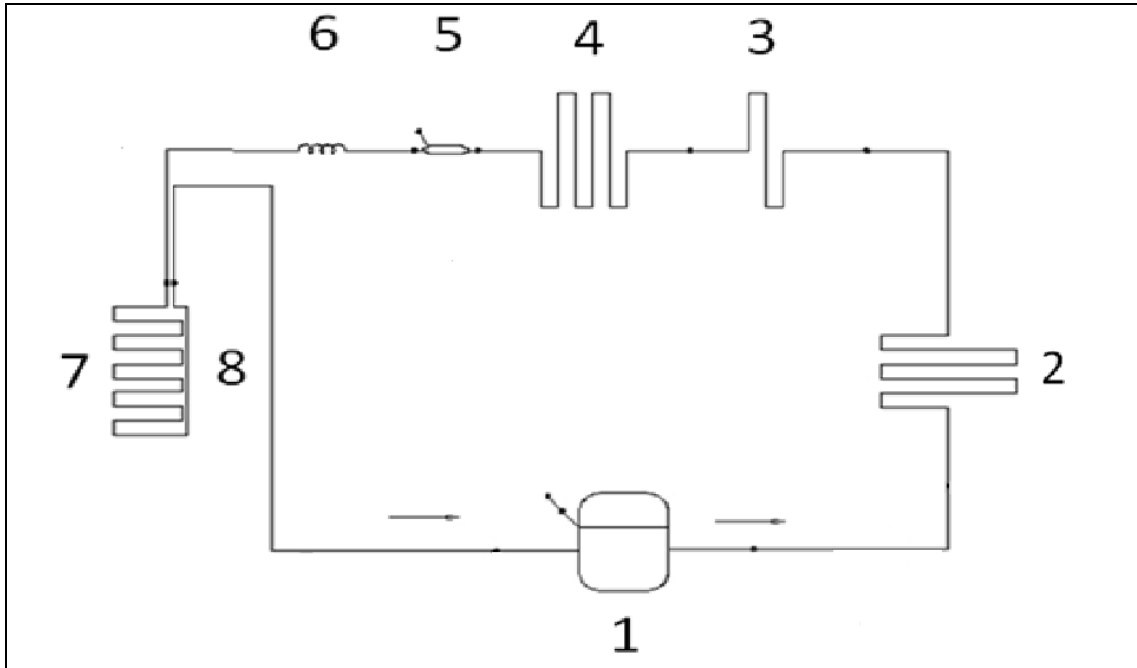

(The picture is only for reference, and specific appearance and configuration are subject to the real product)

### 7.2 Circulating route of cooling air (None)

## 8. Dismantling of parts

### 8.1 Parts on the door

<b>Door seal</b>	
<p>Door seal is installed into door liner groove.</p> <ol style="list-style-type: none"> <li>1) Open the refrigerator door;</li> <li>2) Take the door seal ① out of door liner;</li> </ol>	
<b>Door tray</b>	None
<b>Guardrail</b>	None

### 8.2 Parts inside the refrigerator

<b>Shelves</b>	None
<b>Drawer</b>	None
<ol style="list-style-type: none"> <li>1) Pull the drawer out completely;</li> <li>2) Lift it up slightly and take it out from the refrigerator.</li> </ol>	

### 8.3 Light system

<b>Light</b>	None
<b>Light switch</b>	None

Pilot light	None
Fresh light	None

#### 8.4 Air duct components refrigerating chamber

Air duct components refrigerating chamber	None
---	------

#### 8.5 Air duct components in freezing chamber and fan motor

Disassembly and installation of Air duct	None
Fan motor of air duct	None

#### 8.6 Evaporator and temperature sensing system

<b>Evaporator in freezing chamber</b>	not replace
<b>Components on the evaporator</b>	
<b>Defrost thermostat</b>	None
<b>Fuse</b>	
<b>Defrost sensor</b>	None
Defrost heater	None
Evaporator in refrigerating chamber	None
Components on the evaporator	None
<b>Sensor</b>	
Sensor in freezing chamber	None
Sensor in refrigerating chamber	None
Sensor in Variable temperature chamber	None
ambient temperature sensor	None
<b>Thermostat</b>	
1) Remove the screws on the temperature-control box, Remove the knob	

<p>2) Loosen the nut</p>	
<p>3) Pull out the thermostat box</p>	
<p>4) Remove the thermostat and wire from the box</p>	

### 8.6 Compressor case

#### Piping system in the compressor case

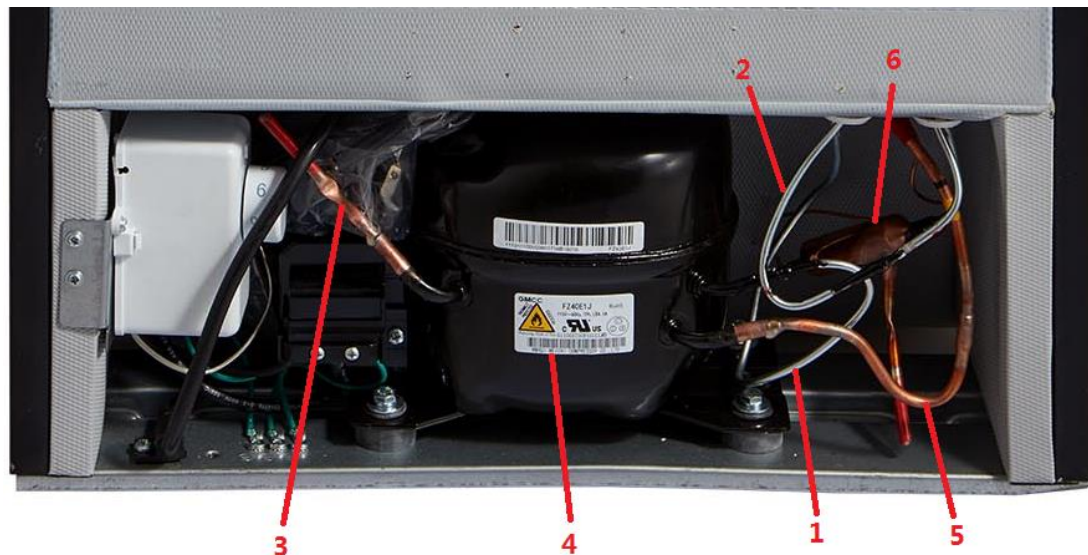

1. Condenser

2. anti-dew tupe assembly



3. processing tubes

4. compressor

5. suction transition tube

6. dry filter

#### Starter and protector of the compressor

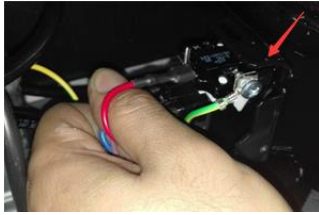
<p><b>1. Remove the screws</b>                  1) Two screws outside                  2) One screw inside</p>	
<p><b>2. Remove the clipping strip</b>                  Slowly pull it out</p>	
<p><b>3. Remove the protective cover</b>                  1) Pry the protective cover slowly from the upper part,                  2) Pull it out and remove it.</p>	
<p><b>4. Remove the starter and protector</b>                  Unplug the starter and protector (you can use a screwdriver to pry it slowly)</p>	
<p><b>5. The reverse process can complete installation.</b></p>	<p>/</p>

**8.7 Display and main control panel(None)**

Display control board	None
Main control board	None

**8.8 Bar counter(None)**

Disassembly and installation of bar counter	None
Disassembly and installation bar doorseal	None

### 8.9 Water dispenser(None)

Disassembly and installation of water valve	None
Disassembly and installation of water tank	None

### 8.10 Ice maker(None)

Disassembly and installation of ice maker	None
Disassembly and installation of water system	None
Disassembly and installation ice machine sensor	None

## 9. Function and operation

### 9.1 Operation panel

Direct cooling mechanical refrigerator, through the thermostat knob to adjust the stalls.



### 9.2 Temperature control

Turn the temperature control knob to 6 gear, the internal temperature of the refrigerator becomes lower.

Turn the temperature control knob to 1 gear, the internal temperature of the refrigerator becomes higher.

NOTE: Please adjusting and using between "6 gear " and "1 gear "

**9.3 Give an alarm (None)**

**9.4 Failure code and solutions (None)**

**9.5 Defrost function**

Manual defrost

**9.6 Compressor fan control (None)**

**9.7 Test mode (None)**

**9.8 Self-diagnosis (None)**

## 10. Circuit description

10.1 Power Supply (None)

10.2 Test circuit for door switch (None)

10.3 Temperature test circuit (None)

10.4 Freezer chamber fan motor circuit (None)

10.5 Refrigerating chamber fan motor circuit (None)

10.6 Condensation fan circuit (None)

10.5 Fan motor circuit of the ventilation door (None)

10.6 Resistance value of the sensor (R/T) (None)

## 11. Troubleshooting Method

### 11.1 Not cooling

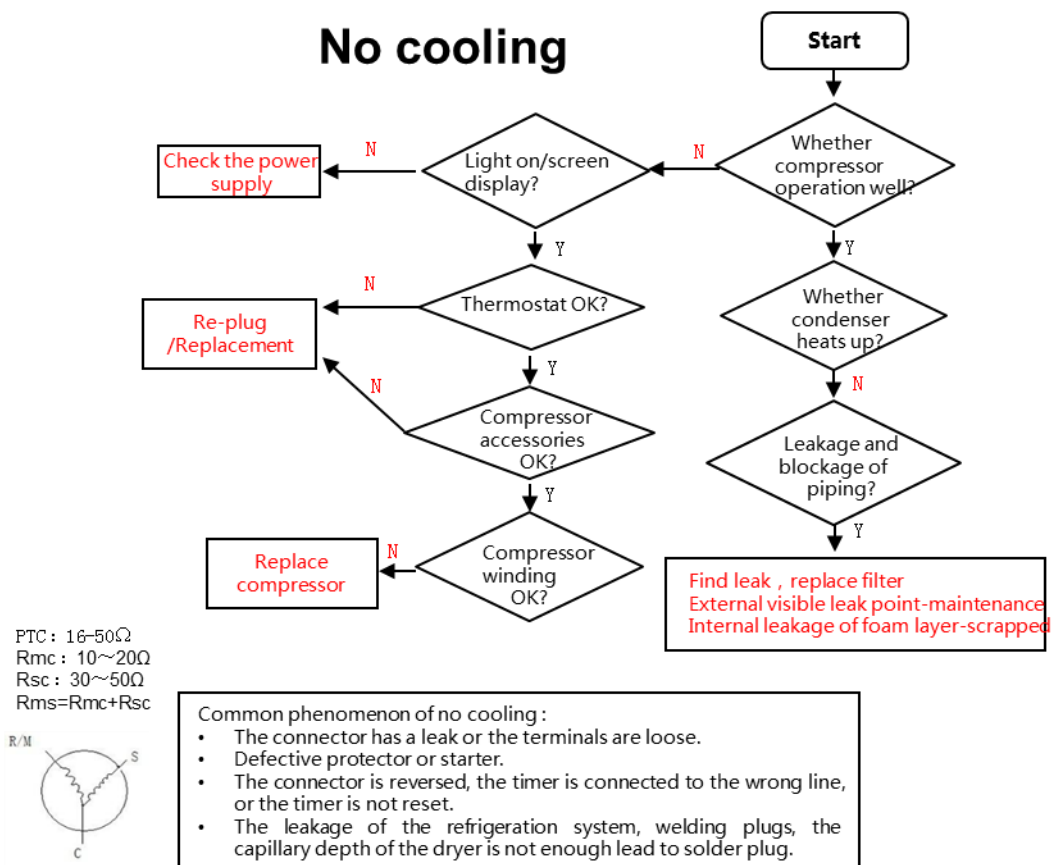

11.2 Not working of compressor

### No working of compressor

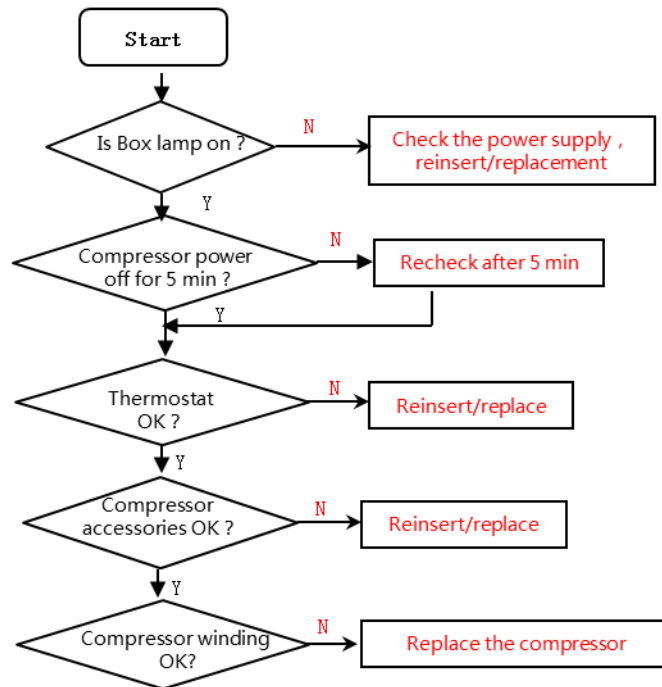

11.3 -Thermostat malfunction-Undercooling

### Thermostat malfunction-Undercooling

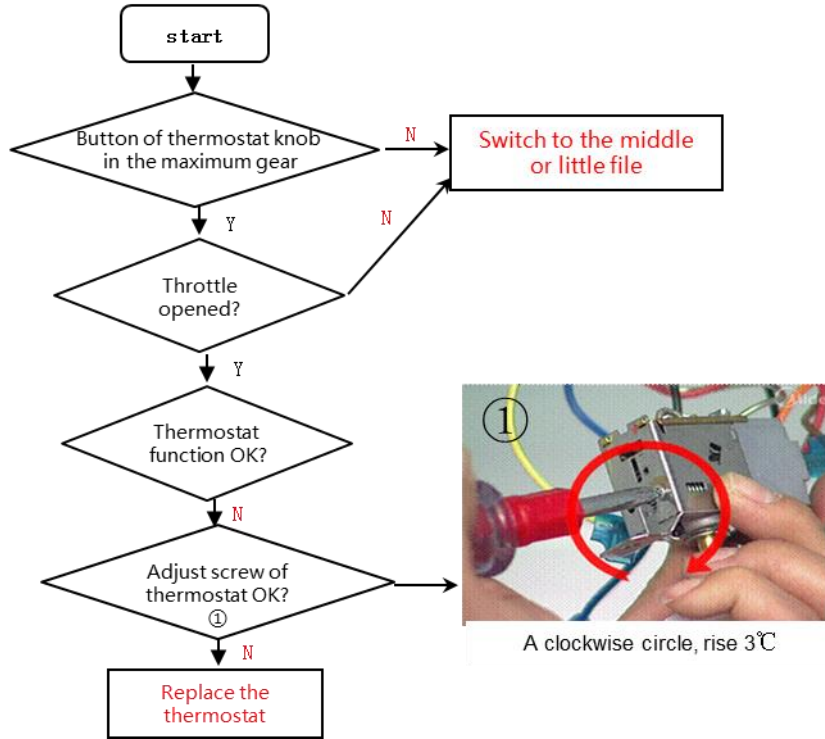

11.4 Light is not on

### Light is not on

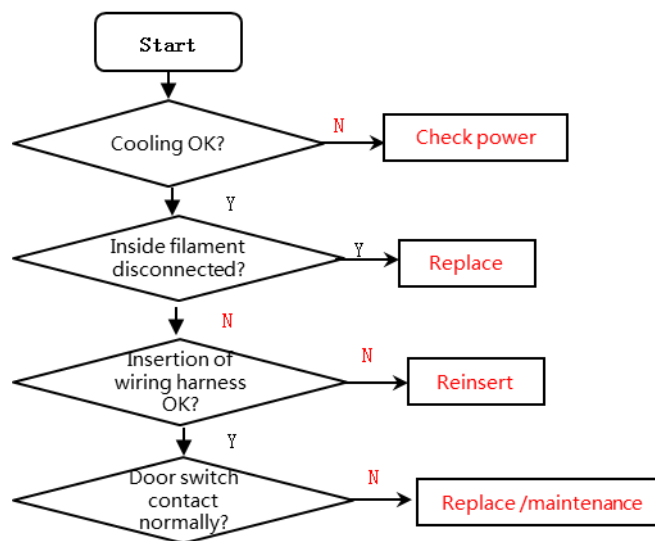

11.5 Noise

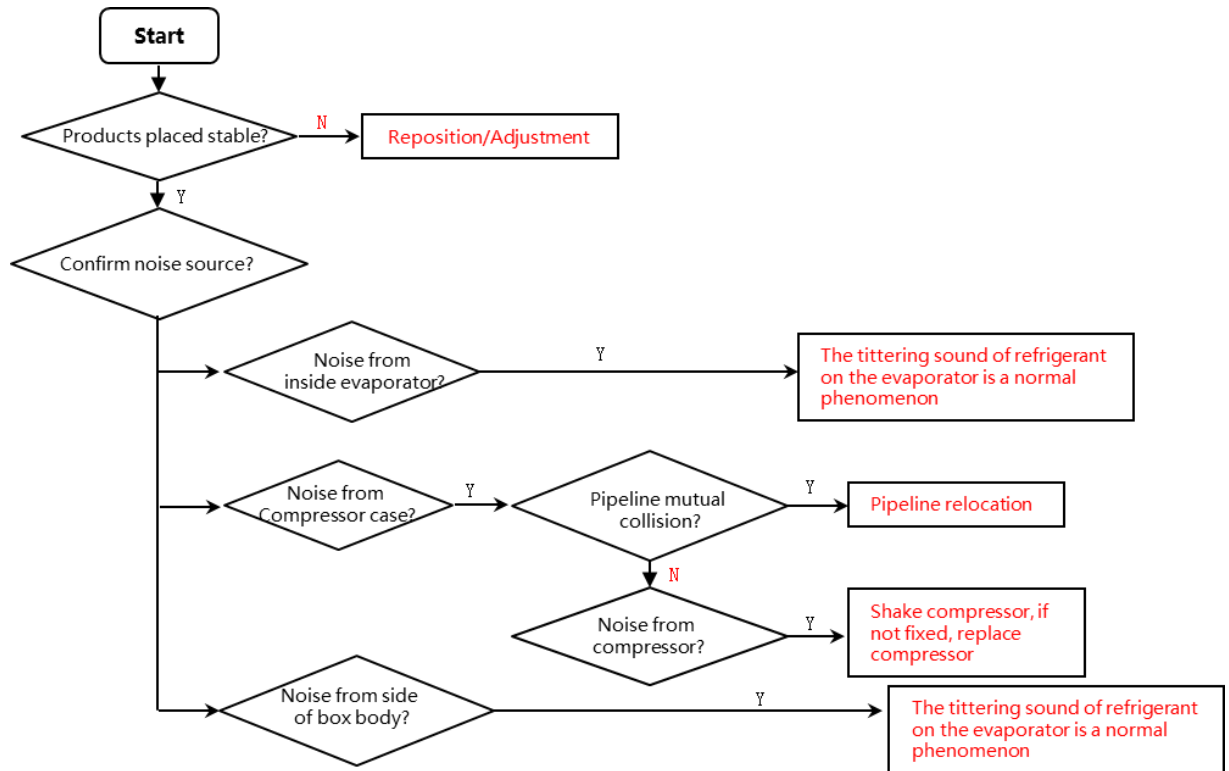

**12. Figures and details of repair parts(Documentsareprovidedseparately)**

12.1 Figures

12.2 List of parts and components



**13 Appendix:**





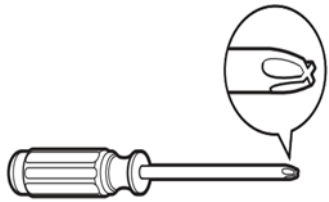
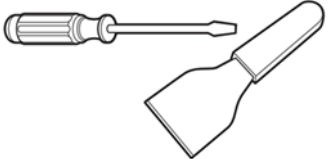
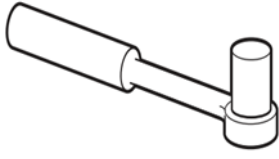

13.1 Electrical Schematic Diagram(**None**)

(Model: \*\*\*)

13.2 Refrigerator maintenance tooling and equipment and material



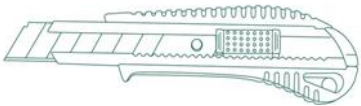



**1) Tooling**

No.	Name	Photo	Main Usage
1	Phillips screwdriver		Screw assembly and disassembly
2	slotted screwdriver/scrapper		Screw and rivet assembly and disassembly
3	Socket spanner 5/16"		Hinge and compressor screw assembly and disassembly
4	Sucker		Display panel and air duct cover disassembly

5	Allen wrench (2.8~4mm)		Handle assembly and disassembly
6	Vise grip pliers		sealing process tube
7	Pipe cutter, Flaring device		Pipe cutting, flaring
8	Capillary tube scissors		Shear capillary
9	Nipper pliers		assistive tool
10	Knife		assistive tool
11	Multi meter		Measurement with resistance, voltage, current and so on.





**2) Equipment**

No.	Name	Photo	Main Usage
-----	------	-------	------------

1	Vacuum pump with gauge		vacuum pumping
2	Electronic scale		weighing refrigerant/gas
3	High pressure nitrogen with piezometer		pipe and cooling system(condenser, evaporator, etc) impurities clean
4	Soldering gun		heating and welding
5	Quick coupling		connection process pipeline vacuum or charge refrigerant will be used.
6	hand leak detector		welding point leakage detect, if no, use soap-suds

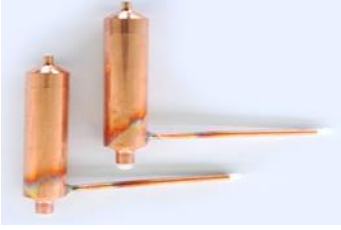
**3) material**

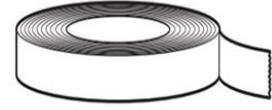
No.	Name	Photo	Main Usage
1	Process pipeline		Charge the refrigerant

2	Dry filter		Involving a system failure to be replaced
3	Copper welding rod (20%Ag) Silver solder		Copper-Copper tubes welding Not Copper-Copper tubes welding copper-aluminum welding rod is needed
4	Refrigerant/gas		Add refrigerant to the system
5	Sealing tape		door fixing for reversible door option
6	Soap-suds		Welding point leakage detect

## Midea Refrigerators

If you need to get detailed technical information from the manufacturer, please contact:

[xxx@midea.com](mailto:xxx@midea.com)

**Refrigeration Division**

**Overseas Sales Company**

Address: No. 176, Jinxiu Avenue, Economic-Technological Development Area, Hefei, Anhui,  
China