



# PARTS & SERVICE MANUAL

## Sandwich Warmers

Models SW & 2TSW

---



*Show without 4" Legs*

P/N: L340150  
REV: 5.15.09

Lincoln Foodservice Products, LLC  
1111 North Hadley Road  
Fort Wayne, Indiana 46804  
Telephone: 260.459.8200  
Fax: 260.436.0735  
Technical Support: 260.459.8200  
lincolnfp.com

## DIMENSIONS (inches/cm)

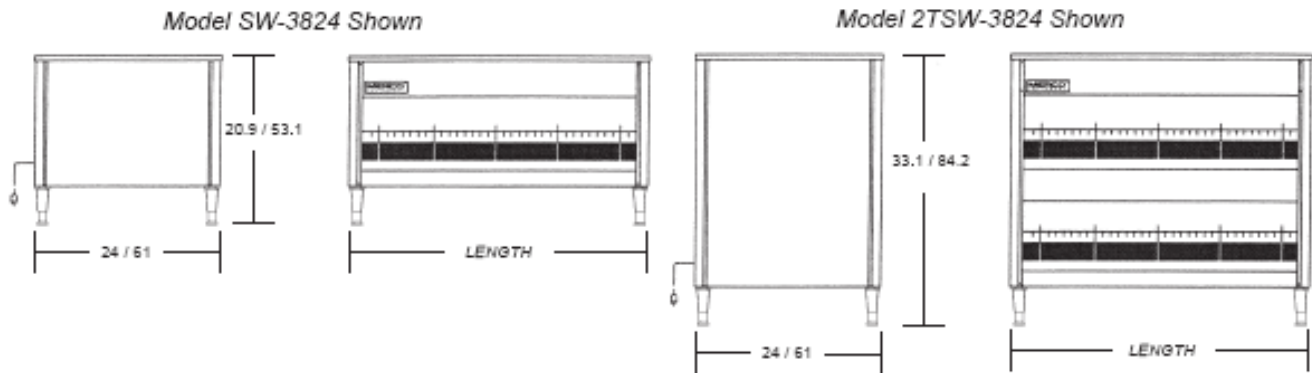

## SPECIFICATIONS (Standard Models)

Model #	VOLTAGE/AMPS			Watts	Length Inches/cm	Net Wt.** Lbs/kg	Ship Wt.** Lbs/kg	Ship Vol.** Cu ft/cu m
	120V	120/208V	120/240V					
SW-2624	7.7	N/A	N/A	920	26/66.0	70/31.8	100/45.4	9.5/0.27
SW-3824	11.8	7.7	6.9	1420	38/96.05	110/49.9	150/68.1	13.5/0.38
SW-5024	15.0	9.7	8.8	1800	50/127.0	150/68.1	190/86.3	17.4/0.49
SW-6224	18.8	12.1	10.9	2260	62/157.5	200/90.8	250/113.5	21.3/0.60
2TSW-2624	15.3	8.0	N/A	1840	26/66.0	100/45.4	130/59.0	15.0/0.42
2TSW-3824	23.7	15.4	13.8	2840	38/96.5	150/68.1	190/86.3	21.1/0.60
2TSW-5024	N/A	19.4	17.5	3600	50/127.0	200/90.8	250/113.5	27.3/0.77
2TSW-6224	N/A	24.3	21.8	4520	62/157.5	250/113.5	320/145.3	33.5/0.95
2TSW-3224	18.8	12.1	11.0	2620	32/81.3	140/63.5	180/81.6	13.2/0.37
2TSW-4424	N/A	17.0	15.3	3180	44/111.8	170/77.1	220/99.8	18.2/0.52
2TSW-7424	N/A	28.2	25.2	5340	74/188.0	240/108.9	320/145.0	30.6/0.87
2TSW-8024	N/A	32.0	28.7	6040	80/203.2	270/122.5	360/163.3	33.1/0.94

\*Measurements are approximate.

NOTE: Not all units are available in all voltages.

## LEG ATTACHMENT

Attach 4" Appliance Legs by threading the stud provided on the leg into the corner gussets on the underside of the unit. Turn the adjustable feet on the appliance leg to level unit. These legs must be installed to allow heat to dissipate. *Legs must be attached to meet NSF regulations.*

## OPERATION

- #1 On/Off Switch controls lights.
- #2 Controls the upper tubular heating element(s) and lower heating shelf.
- #3 Illuminated Pilot Light indicates that tubular heating element(s) are on.
- #4 Controls warming shelf.
- #5 Illuminated Pilot Light indicates that the shelf is on.

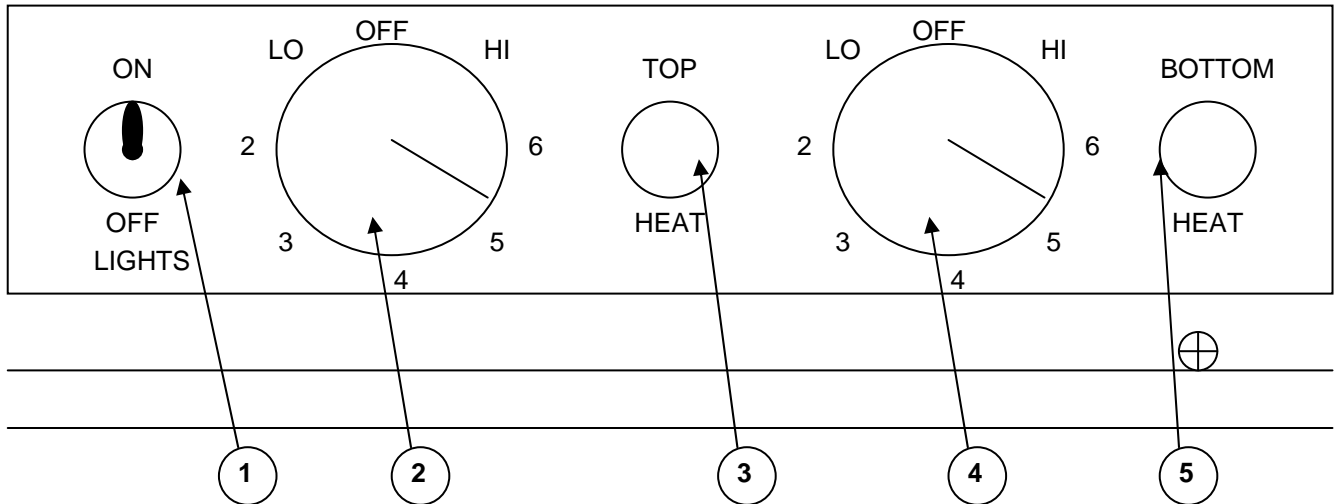

The factory recommends setting the heat control knobs (2 & 4) between the numbers four (4) and six (6) on the control panel depending on the ambient temperature.

# WIRING DIAGRAMS

## 2TSW-3824

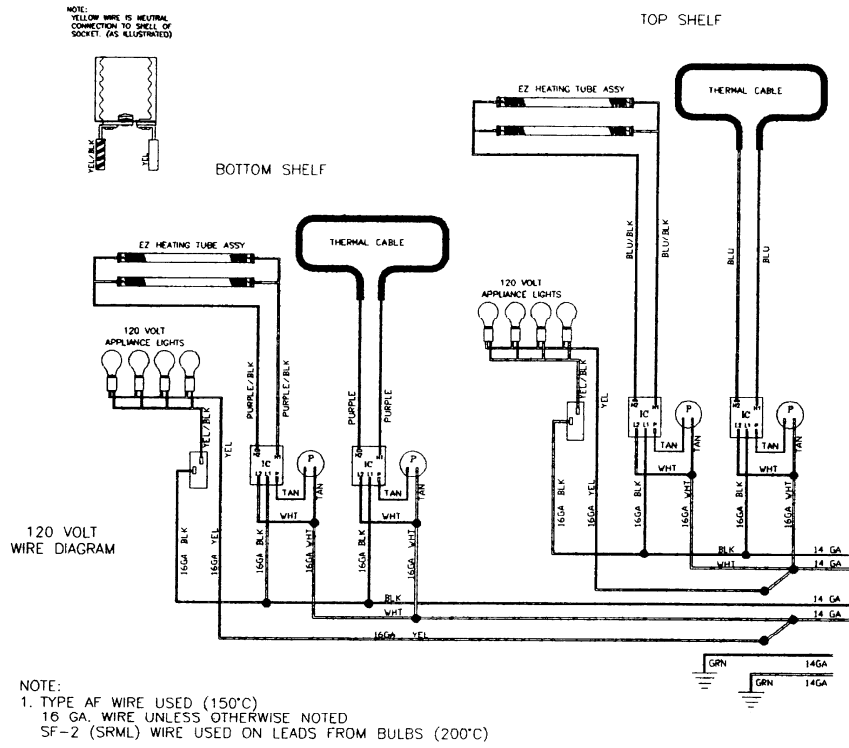

## 2TSW-2624 2TSW-3224

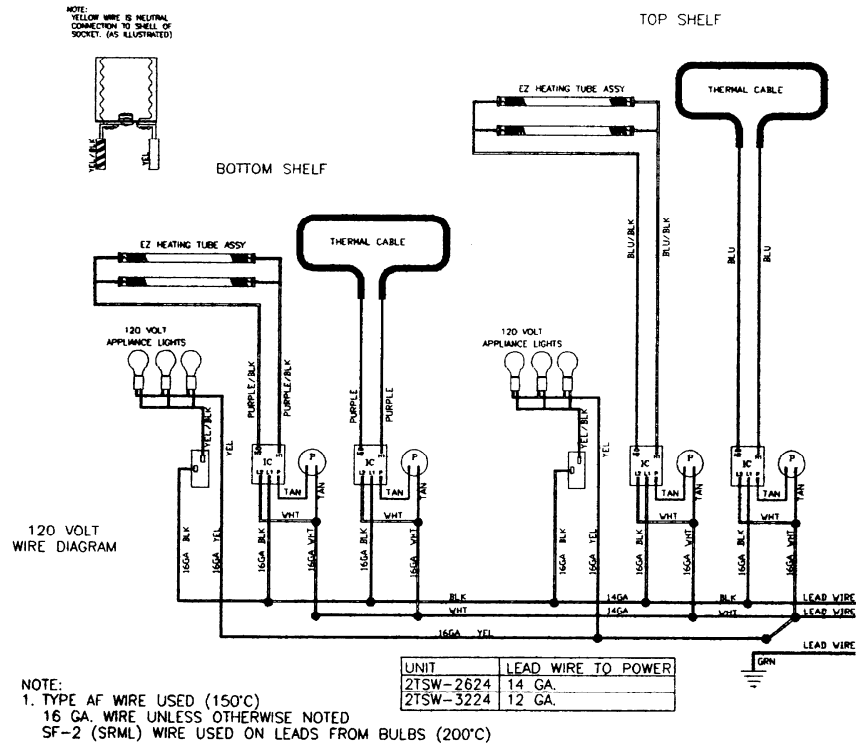

# WIRING DIAGRAMS (CONT'D)

## 2TSW-7424, 208V 2TSW-8024, 208 & 240V

NOTE:  
YELLOW WIRE IS NEUTRAL  
CONNECTION TO SHELL OF  
SOCKET (AS ILLUSTRATED)

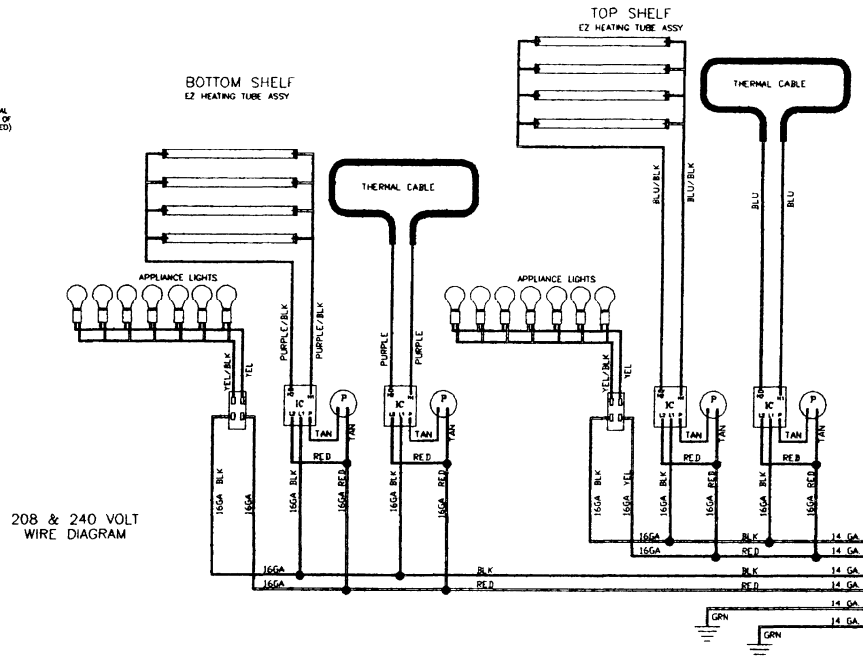

NOTE:  
1. TYPE AF (MIN. 150") WIRE USED  
16 GA. WIRE UNLESS OTHERWISE NOTED  
SF-2 (SRML) WIRE USED ON LEADS FROM BULBS (200°C)

## 2TSW-3224, 208 & 240V 2TSW-3824, 208 & 240V 2TSW-4424, 208 & 240V 2TSW-5024, 208 & 240V 2TSW-6224, 208 & 240V 2TSW-7424, 240V

NOTE:  
YELLOW WIRE IS NEUTRAL  
CONNECTION TO SHELL OF  
SOCKET (AS ILLUSTRATED)

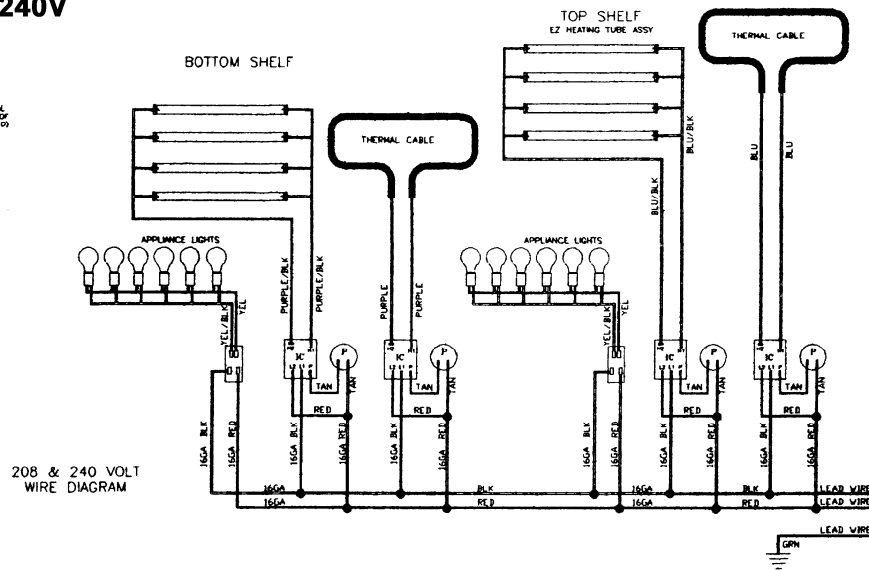

NOTE:  
1. TYPE AF (MIN. 150") WIRE USED  
16 GA. WIRE UNLESS OTHERWISE NOTED

UNIT	LEAD WIRE TO POWER
2TSW-3224	14 GA
2TSW-3824	14 GA
2TSW-4424	14 GA
2TSW-5024	14 GA
2TSW-6224	12 GA
2TSW-7424	12 GA

# WIRING DIAGRAMS (CONT'D)

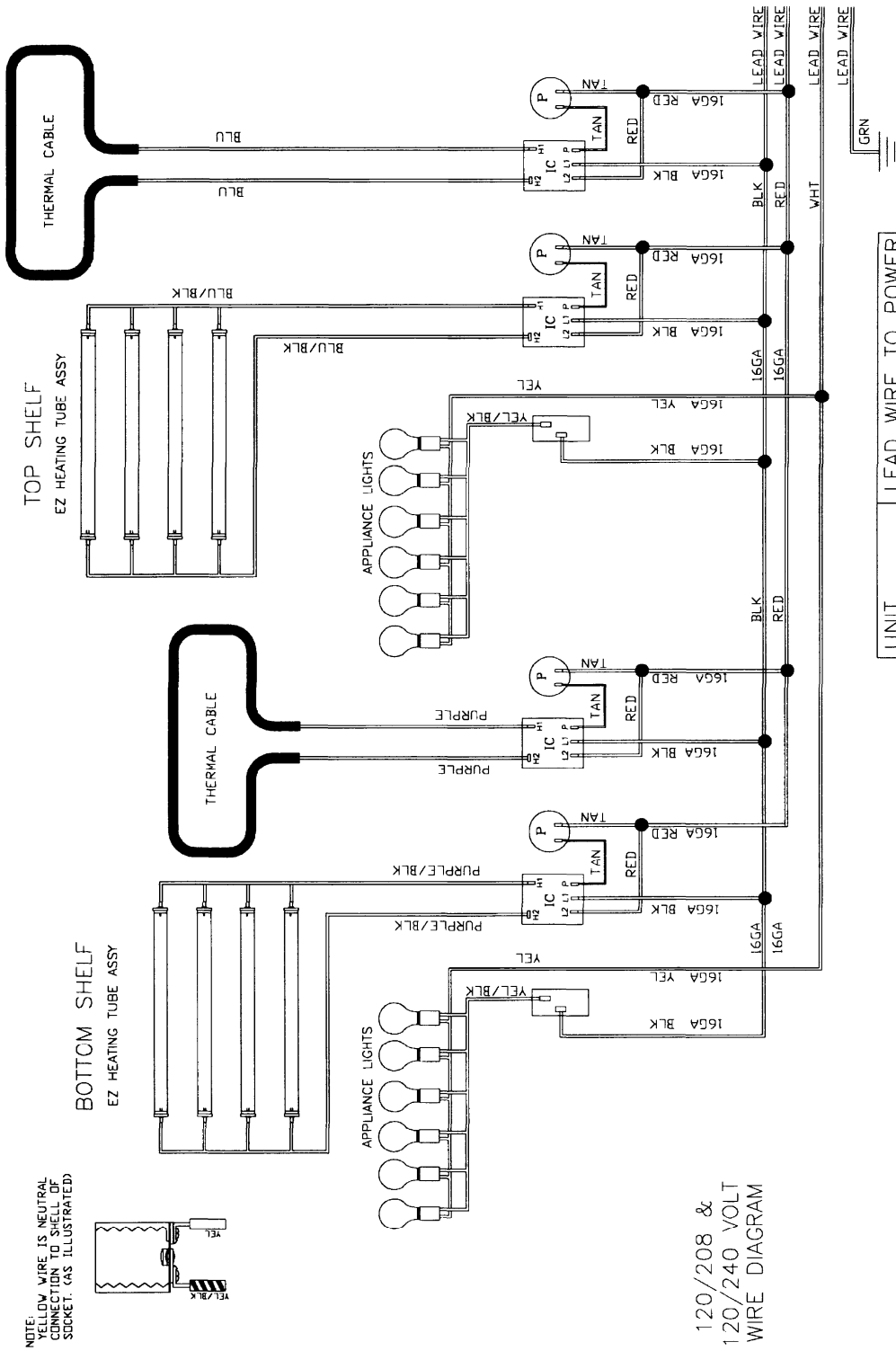

# WIRING DIAGRAMS (CONT'D)

NOTE:  
YELLOW WIRE IS NEUTRAL  
CONNECTION TO SHELL OF  
SOCKET. (AS ILLUSTRATED)

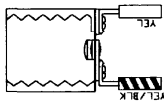

EZ HEATING TUBE ASSY

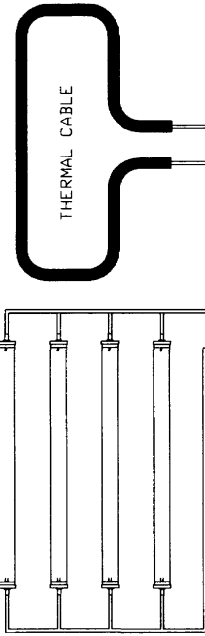

THERMAL CABLE

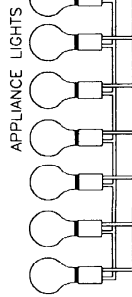

UNIT	LEAD WIRE TO POWER
SW-3224	16 GA
SW-3824	16 GA
SW-4424	120/208V 14 GA 120/240V 16 GA
SW-5024	14 GA
SW-6224	14 GA
SW-7424	14 GA
SW-8024	14 GA

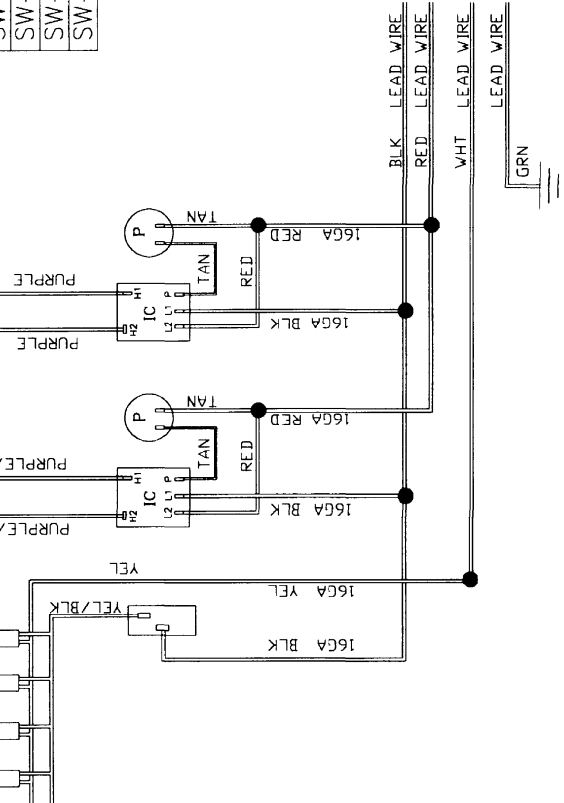

120/208 &  
120/240 VOLT  
WIRE DIAGRAM

NOTE:  
1. TYPE AF (MIN. 150') WIRE USED  
16 GA. WIRE UNLESS OTHERWISE NOTED  
SF-2 (SRML) WIRE USED ON LEADS FROM BULBS (200°C)

# WIRING DIAGRAMS (CONT'D)

NOTE:  
YELLOW WIRE IS NEUTRAL  
CONNECTION TO SHELL OF  
SOCKET. (AS ILLUSTRATED)

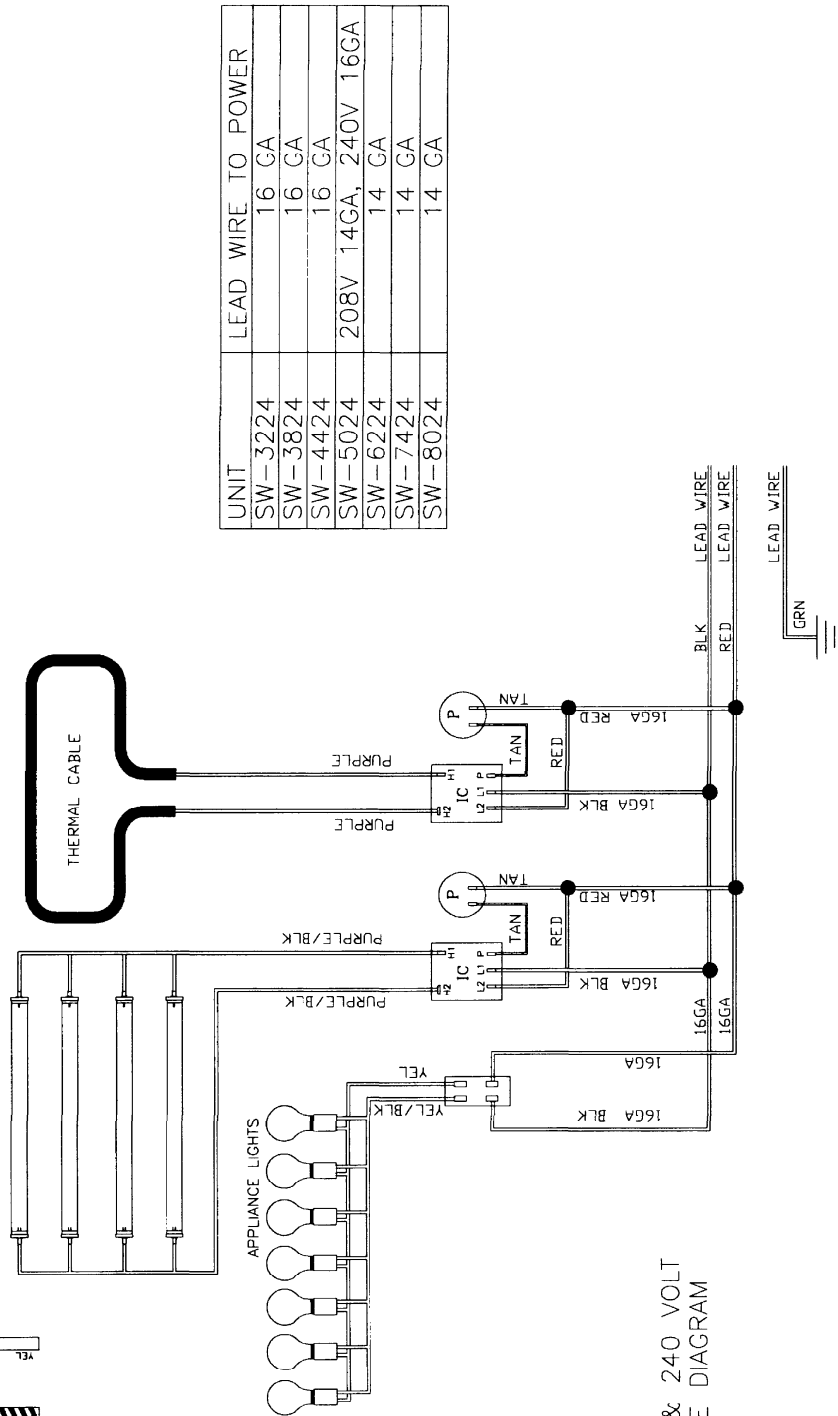
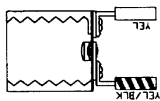

208 & 240 VOLT  
WIRE DIAGRAM

SW-3224, SW-3824, SW-4424, SW-5024,  
SW-6224, SW-7424, SW-8024, 208 VOLT &  
240 Volt Wiring Diagram

NOTE:  
1. TYPE AF (MIN. 150') WIRE USED  
16 GA. WIRE UNLESS OTHERWISE NOTED

# WIRING DIAGRAMS (CONT'D)

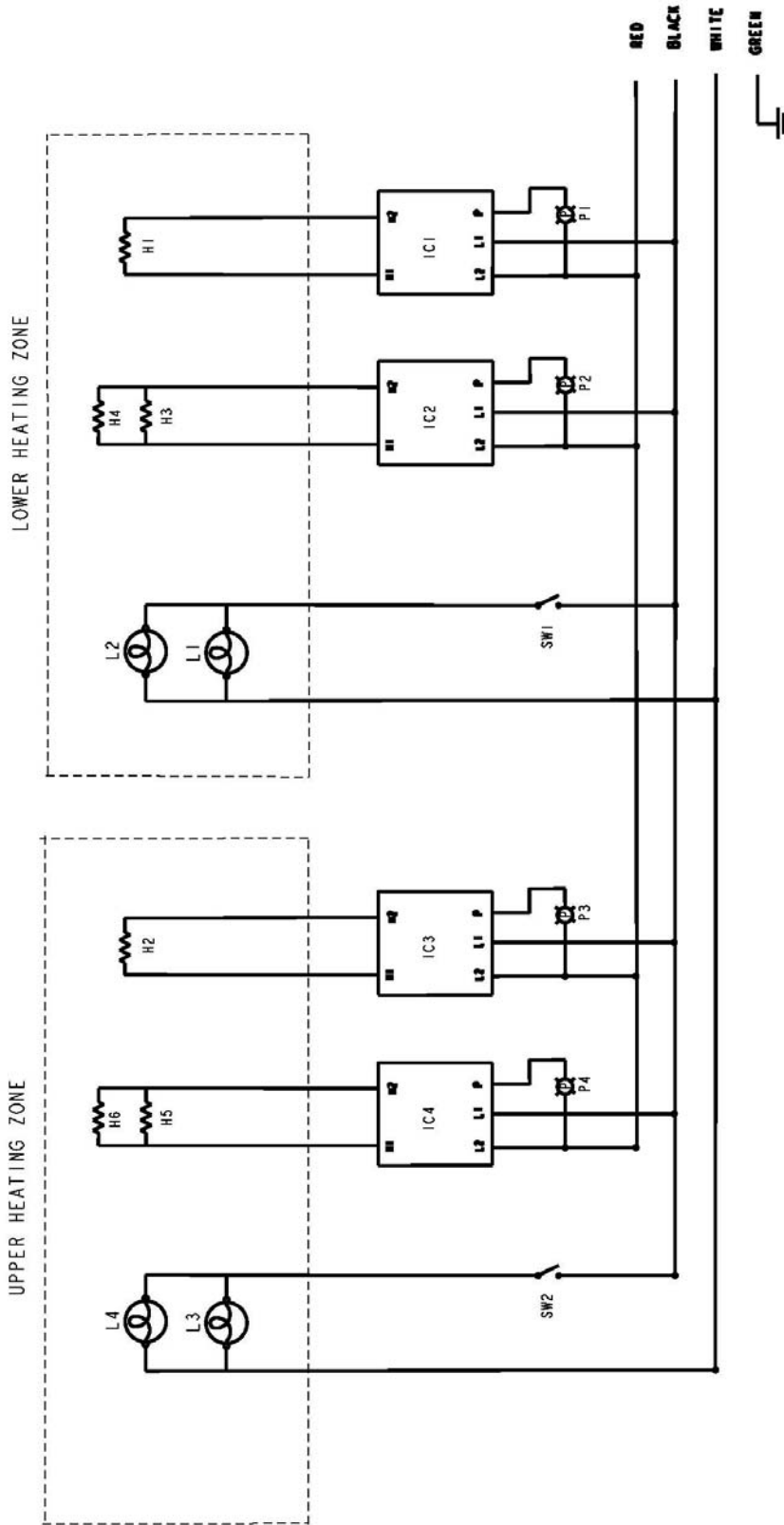

IC1, IC2, IC3, IC4 - INFINITE CONTRL 240V 15A  
 H1, H2 - THERMAL CABLE, 208V 200W  
 H3, H4, H5, H6 - E2 HEAT TUBE ASSY 240V 300W  
 L1, L2, L3, L4 - LAMP, INCANDESCENT 130V 60W  
 SW1, SW2 - SPST TOGGLE SWITCH 250V 12A

20000063A

**2TSW - 3824  
PARTS LIST  
120V**

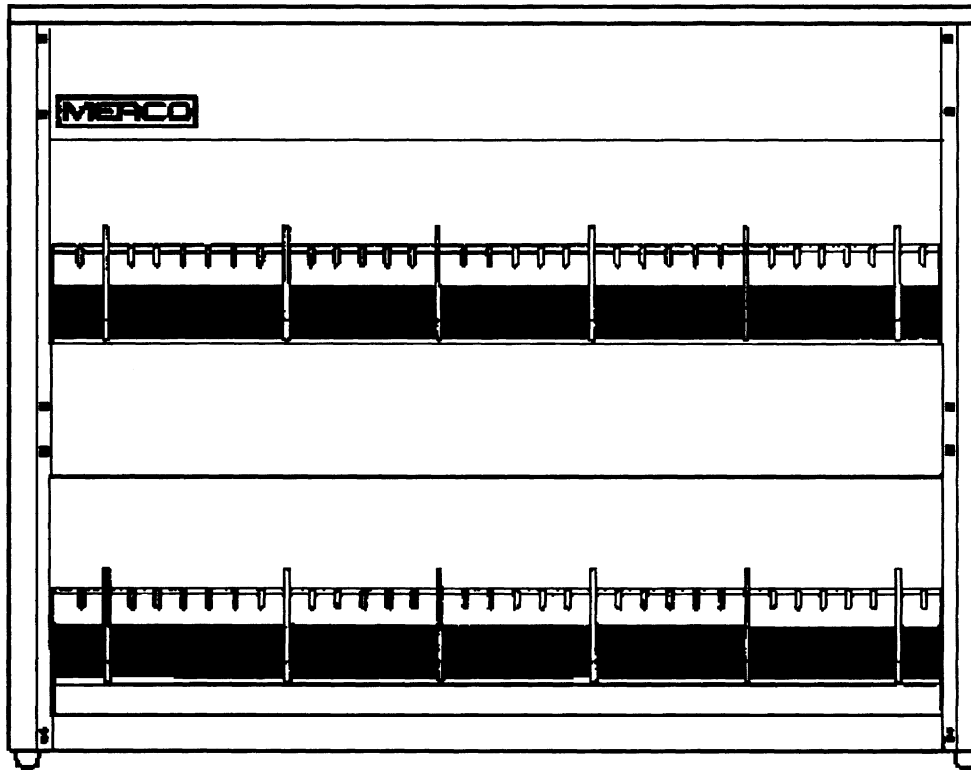

PART NO.	DESCRIPTION	QTY
000171	BUSHING, HEYCO	1
000320	KNOB, W/POINTER	4
000360	KNOB, 1/4-20, FEMALE INSERT, BLK	8
000374	LAMP, 120V, 60W, CLEAR COATED	8
000466	WIRENUT, CERAMIC, HI-7	
000672	SOCKET, EZ, QUARTZLINE	8
000716	SWITCH, TOGGLE, 15A, 125V	2
050377	CONTROL, INF, 120V, W/TERM	4
050463	SOCKET, ASSY, TWIN	2
<del>070003</del>	<del>FOOT, RUBBER, W/SCREW</del>	<del>4</del>
072051	CORDSET, 120V, 30A W/SLV	1
080003	LIGHT, PILOT, W/2 FAST ON TERM	4
110556	TUBE, LWEZT-36, 120V, 440W	4
111595	CABLE, THERMAL, 120V, 300W, 14'	2
313210	SUPPORT, DIV, ROD (2T) SW 3824	4
314520	DIVIDER, BAR (2T) SW	12

*NOTE: Rubber Foot (070003) is no longer available. Units now require 4" legs (10004733) to meet NSF standards.*

**SW - 2624 STYLE FL  
PARTS LIST  
120V**

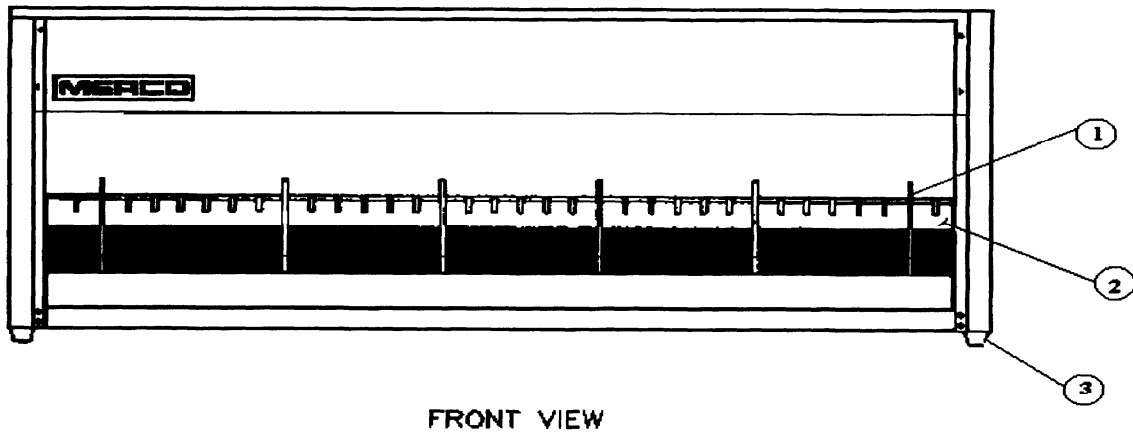

ITEM	PART NO.	DESCRIPTION	QTY
	000174	BUSHING, HEYCO	1
	000320	KNOB, W/POINTER	2
	000360	KNOB, 1/4-20, FEMALE INSERT, BLK	2
	000374	LAMP, 120V, 60W, CLEAR COATED	4
	000466	WIRENUT, CERAMIC, HI-7	
	000672	SOCKET, EZ, QUARTZLINE	4
	000716	SWITCH, TOGGLE, 15A, 125V	1
	050377	CONTROL, INF, 120V, W/TERM	2
	050463	SOCKET, ASSY, TWIN	1
<del>3</del>	<del>070003</del>	<del>FOOT, RUBBER, W/SCREW</del>	<del>4</del>
	072036	CORDSET, 120V, 15A W/SLV	1
	080003	LIGHT, PILOT, W/2 FAST ON TERM	2
	110548	TUBE, LWEZT-24, 120V, 300W	2
	111598	CABLE, THERMAL, 120V, 200W, 9.5'	1
	000869	GUARD, WIRE NW-24	2

*NOTE: Rubber Foot (070003) is no longer available. Units now require 4" legs (10004733) to meet NSF standards.*

**SW - 3824 STYLE FL  
PARTS LIST  
120V**

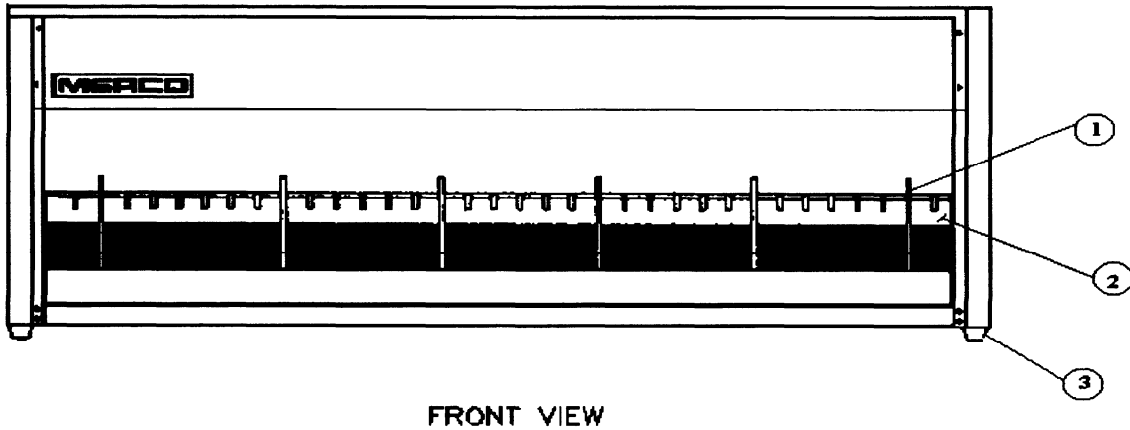

ITEM	PART NO.	DESCRIPTION	QTY
	000171	BUSHING, HEYCO	1
	000320	KNOB, W/POINTER	2
	000360	KNOB, 1/4-20, FEMALE INSERT, BLK	2
	000374	LAMP, 120V, 60W, CLEAR COATED	4
	000466	WIRENUT, CERAMIC, HI-7	
	000672	SOCKET, EZ, QUARTZLINE	4
	000716	SWITCH, TOGGLE, 15A, 125V	1
	050377	CONTROL, INF, 120V, W/TERM	2
	050463	SOCKET, ASSY, TWIN	1
<del>3</del>	<del>070003</del>	<del>FOOT, RUBBER, W/SCREW</del>	<del>4</del>
	072051	CORDSET, 120V, 30A W/SLV	1
	080003	LIGHT, PILOT, W/2 FAST ON TERM	2
	110556	TUBE, LWEZT-36, 120V, 440W	2
	111595	CABLE, THERMAL, 120V, 300W, 14'	1
2	313210	SUPPORT, DIV, ROD (2T) SW 3824	2
1	314520	DIVIDER, BAR (2T) SW	6

*NOTE: Rubber Foot (070003) is no longer available. Units now require 4" legs (10004733) to meet NSF standards.*

**SW - 3824 STYLE FL  
PARTS LIST  
208 V**

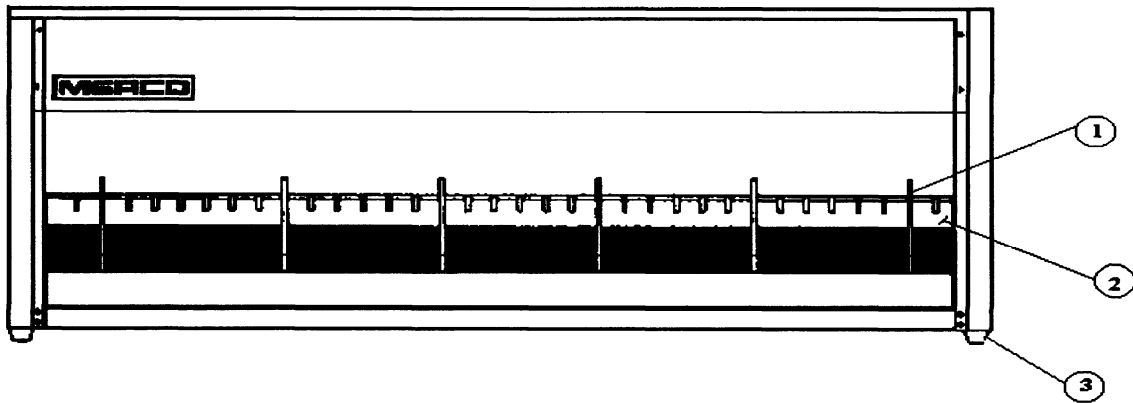

FRONT VIEW

ITEM	PART NO.	DESCRIPTION	QTY
	000170	BUSHING, HEYCO	1
	000320	KNOB, W/POINTER	2
	000360	KNOB, 1/4-20, FEMALE INSERT, BLK	4
	000378	LAMP, 240V, 40W, CLEAR COATED	4
	000466	WIRENUT, CERAMIC, HI-7	
	000672	SOCKET, EZ, QUARTZLINE	4
	000711	SWITCH, TOGGLE, 10A, 240V	1
	050378	CONTROL, INF, 240V, W/TERM	2
	050463	SOCKET, ASSY, TWIN	2
<del>3</del>	<del>070003</del>	<del>FOOT, RUBBER, W/SCREW</del>	<del>4</del>
	072037	CORDSET, 240V, 15A W/SLV	1
	080003	LIGHT, PILOT, W/2 FAST ON TERM	2
	110557	TUBE, LWEZT-36, 208V, 440W	2
	111596	CABLE, THERMAL, 208V, 300W, 14'	1
2	313210	SUPPORT, DIV, ROD (2T) SW 3824	2
1	314520	DIVIDER, BAR (2T) SW	6

*NOTE: Rubber Foot (070003) is no longer available. Units now require 4" legs (10004733) to meet NSF standards.*

**SW - 5024 STYLE FL  
PARTS LIST  
120/208 V**

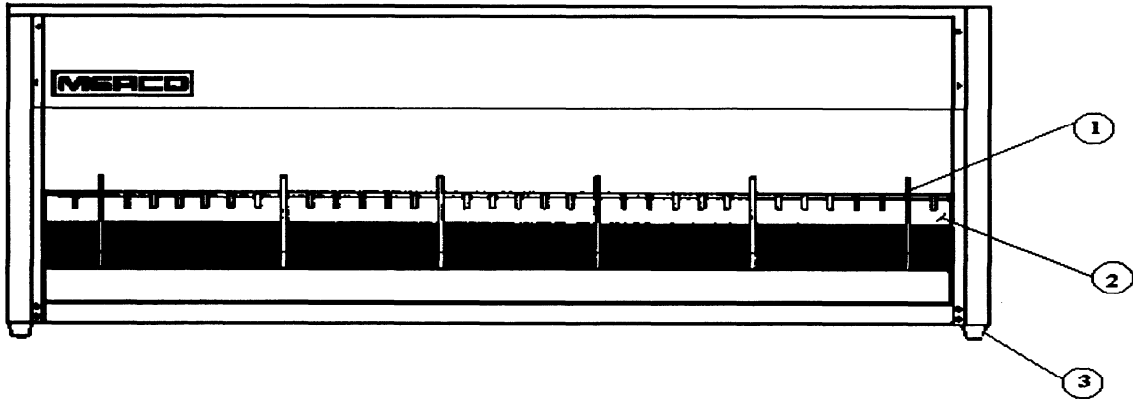

FRONT VIEW

ITEM	PART NO.	DESCRIPTION	QTY
	000174	BUSHING, HEYCO	1
	000320	KNOB, W/POINTER	2
	000360	KNOB, 1/4-20, FEMALE INSERT, BLK	4
	000374	LAMP, 120V, 60W, CLEAR COATED	5
	000466	WIRENUT, CERAMIC, HI-7	
	000672	SOCKET, EZ, QUARTZLINE	4
	000711	SWITCH, TOGGLE, 15A, 240V	1
	000872	GUARD, WIRE, NW-48X	2
	050378	CONTROL, INF, 240V, W/TERM	2
	050461	SOCKET ASSY, SINGLE, LFW	1
	050463	SOCKET, ASSY, TWIN	2
<del>3</del>	<del>070003</del>	<del>FOOT, RUBBER, W/SCREW</del>	<del>4</del>
	072048	CORDSET, 120/240V, 20A W/SLV	1
	080003	LIGHT, PILOT, W/2 FAST ON TERM	2
	110581	TUBE, LWEZT-48, 208V, 550W	2
	111606	CABLE, THERMAL, 208V, 400W, 18' 9"	1
2	313225	SUPPORT, DIV, ROD (2T) SW 5024	2
1	314520	DIVIDER, BAR (2T) SW	8

NOTE: Rubber Foot (070003) is no longer available. Units now require 4" legs (10004733) to meet NSF standards.

**SW - 5024 STYLE FL  
PARTS LIST  
208 V**

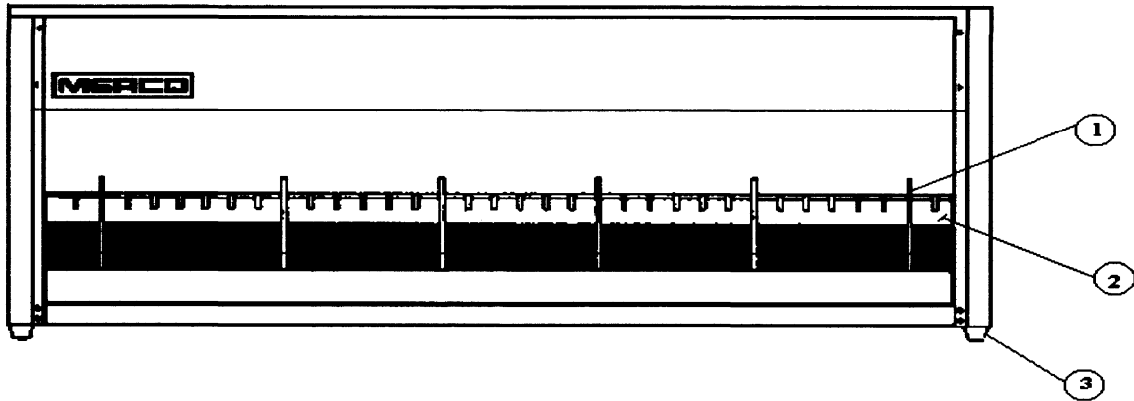

FRONT VIEW

ITEM	PART NO.	DESCRIPTION	QTY
	000174	BUSHING, HEYCO	1
	000320	KNOB, W/POINTER	2
	000360	KNOB, 1/4-20, FEMALE INSERT, BLK	4
	000378	LAMP, 240V, 60W, CLEAR COATED	5
	000466	WIRENUT, CERAMIC, HI-7	
	000672	SOCKET, EZ, QUARTZLINE	4
	000711	SWITCH, TOGGLE, 15A, 240V	1
	000872	GUARD, WIRE, NW-48X	2
	050378	CONTROL, INF, 240V, W/TERM	2
	050461	SOCKET ASSY, SINGLE, LFW	1
	050463	SOCKET, ASSY, TWIN	2
<del>3</del>	<del>070003</del>	<del>FOOT, RUBBER, W/SCREW</del>	<del>4</del>
	072037	CORDSET, 240V, 15A W/SLV	1
	080003	LIGHT, PILOT, W/2 FAST ON TERM	2
	110581	TUBE, LWEZT-48, 208V, 550W	2
	111606	CABLE, THERMAL, 208V, 400W, 18' 9"	1
2	313225	SUPPORT, DIV, ROD (2T) SW 5024	2
1	314520	DIVIDER, BAR (2T) SW	8

*NOTE: Rubber Foot (070003) is no longer available. Units now require 4" legs (10004733) to meet NSF standards.*

**SW - 6224 STYLE FL  
PARTS LIST  
120 V**

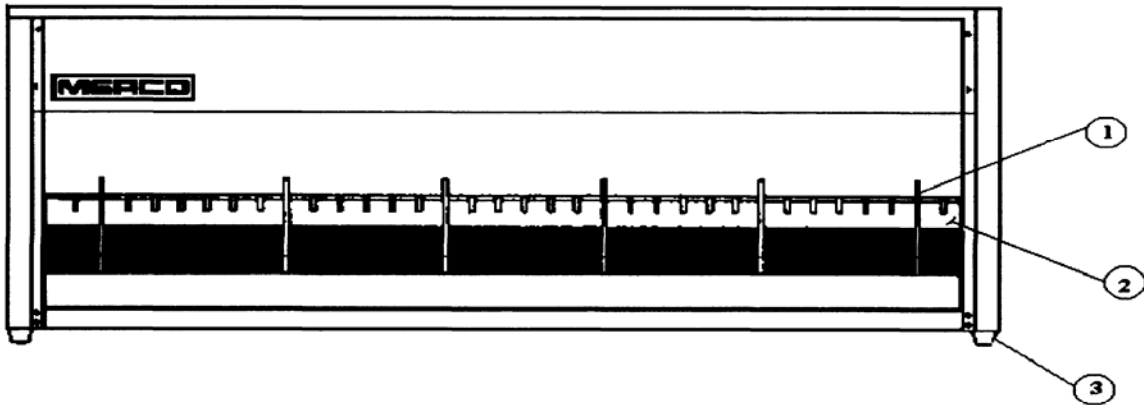

FRONT VIEW

ITEM	PART NO.	DESCRIPTION	QTY
	000174	BUSHING, HEYCO	1
	000320	KNOB, W/POINTER	2
	000360	KNOB, 1/4-20, FEMALE INSERT, BLK	4
	000374	LAMP, 120V, 60W, CLEAR COATED	5
	000466	WIRENUT, CERAMIC, HI-7	
	000672	SOCKET, EZ, QUARTZLINE	8
	000716	SWITCH, TOGGLE, 15A, 120V	1
	000872	GUARD, WIRE, NW-48X	2
	110575	TUBE, LWEZT-30, 120V, 350W	4
	050377	CONTROL, INF, 120V, W/TERM	2
	050461	SOCKET ASSY, SINGLE, LFW	1
	050463	SOCKET, ASSY, TWIN	3
<del>3</del>	<del>070003</del>	<del>FOOT, RUBBER, W/SCREW</del>	<del>4</del>
	072051	CORDSET, 120V, 30A W/SLV	1
	080003	LIGHT, PILOT, W/2 FAST ON TERM	2
1	314520	DIVIDER, BAR (2T) SW	9
2	313230	SUPPORT, DIV, ROD (2T) SW 6224	2
	040625	CABLE, THERMAL, 120V, 500W, 22' 9"	1

*NOTE: Rubber Foot (070003) is no longer available. Units now require 4" legs (10004733) to meet NSF standards.*

**SW - 6224 STYLE FL  
PARTS LIST  
120/208 V**

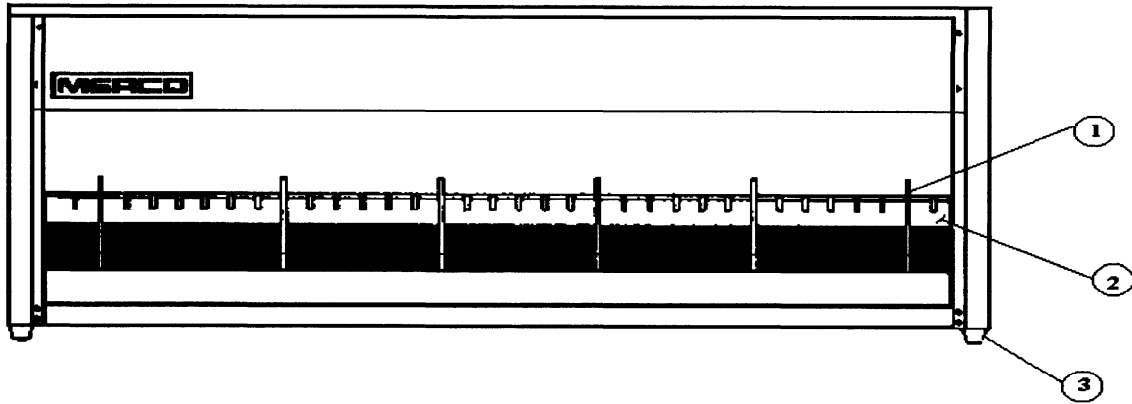

FRONT VIEW

ITEM	PART NO.	DESCRIPTION	QTY
	000174	BUSHING, HEYCO	1
	000320	KNOB, W/POINTER	2
	000360	KNOB, 1/4-20, FEMALE INSERT, BLK	4
	000374	LAMP, 120V, 60W, CLEAR COATED	5
	000466	WIRENUT, CERAMIC, HI-7	
	000672	SOCKET, EZ, QUARTZLINE	6
	000716	SWITCH, TOGGLE, 15A, 120V	1
	000872	GUARD, WIRE, NW-48X	2
	110955	TUBE, LWEZT-30, 208V, 350W	2
	050378	CONTROL, INF, 240V, W/TERM	2
	050461	SOCKET ASSY, SINGLE, LFW	1
	050463	SOCKET, ASSY, TWIN	3
<del>3</del>	<del>070003</del>	<del>FOOT, RUBBER, W/SCREW</del>	<del>4</del>
	072048	CORDSET, 120/240V, 20A W/SLV	1
	080003	LIGHT, PILOT, W/2 FAST ON TERM	2
1	314520	DIVIDER, BAR (2T) SW	9
2	313230	SUPPORT, DIV, ROD (2T) SW 6224	2
	111607	CABLE, THERMAL, 208V, 500W, 22' 9"	1

*NOTE: Rubber Foot (070003) is no longer available. Units now require 4" legs (10004733) to meet NSF standards.*

**SW - 6224 STYLE FL  
PARTS LIST  
208 V**

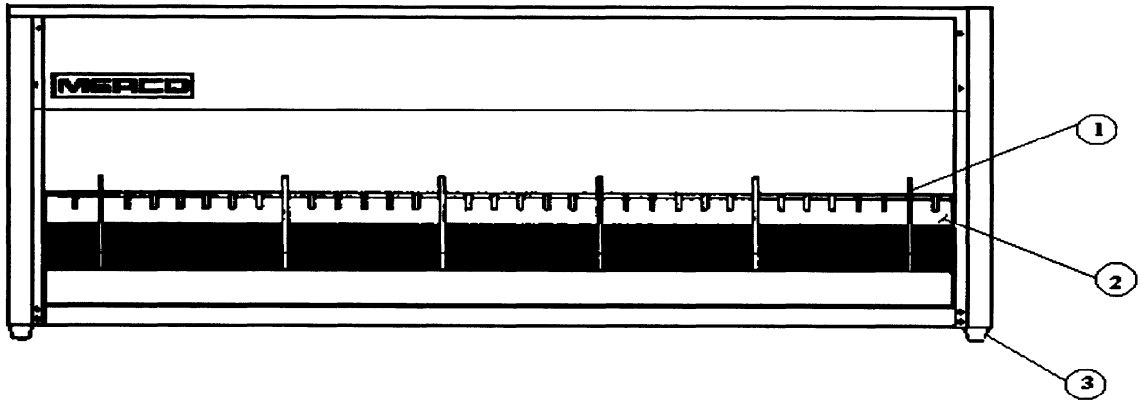

FRONT VIEW

ITEM	PART NO.	DESCRIPTION	QTY
	000174	BUSHING, HEYCO	1
	000320	KNOB, W/POINTER	2
	000360	KNOB, 1/4-20, FEMALE INSERT, BLK	4
	000378	LAMP, 240V, 60W, CLEAR COATED	5
	000466	WIRENUT, CERAMIC, HI-7	
	000672	SOCKET, EZ, QUARTZLINE	6
	000711	SWITCH, TOGGLE, 10A, 240V	1
	000872	GUARD, WIRE, NW-48X	2
	030400	TUBE, LWEZT-30, 208V, 350W	2
	050378	CONTROL, INF, 240V, W/TERM	2
	050461	SOCKET ASSY, SINGLE, LFW	1
	050463	SOCKET, ASSY, TWIN	3
<del>3</del>	<del>070003</del>	<del>FOOT, RUBBER, W/SCREW</del>	<del>4</del>
	072037	CORDSET, 240V, 20A W/SLV	1
	080003	LIGHT, PILOT, W/2 FAST ON TERM	2
1	314520	DIVIDER, BAR (2T) SW	9
2	313230	SUPPORT, DIV, ROD (2T) SW 6224	2
	111607	CABLE, THERMAL, 208V, 500W, 22' 9"	1

*NOTE: Rubber Foot (070003) is no longer available. Units now require 4" legs (10004733) to meet NSF standards.*

## EZ TUBE INSTALLATION AND REPLACEMENT INSTRUCTIONS



**CAUTION:**

Prior to replacing a heat tube, make sure the contact is clean. If it is burnt or dirty, replace the socket.

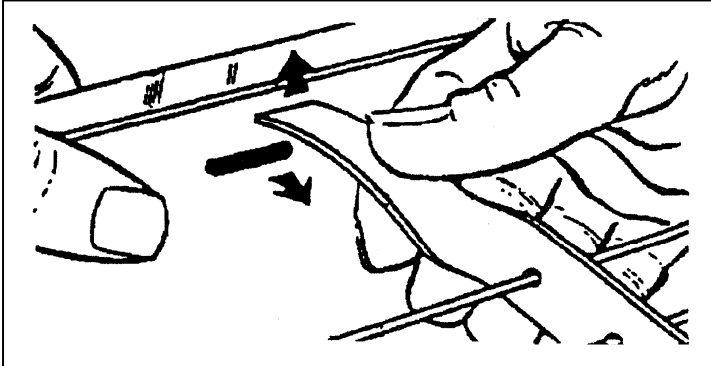

1. Remove the tube guard by pushing against the face of the warmer with left thumb and “bowing” the cross brace upward with your right hand. Pull the brace free. Remove the lengthwise brace.

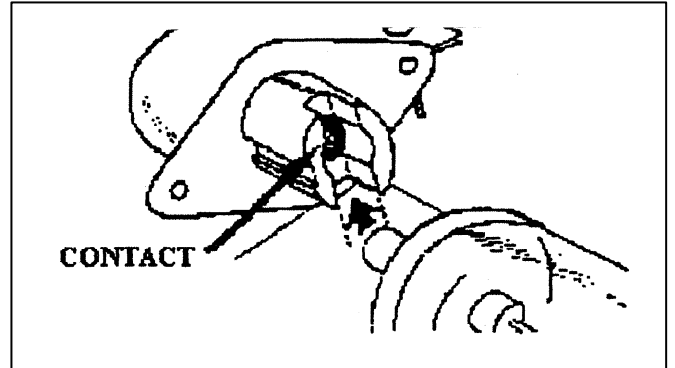

2. Place the left tip of the tube under the white socket (receptacle of the terminal). Raise the tube into the slot and apply enough inward pressure to compress the terminal slightly.

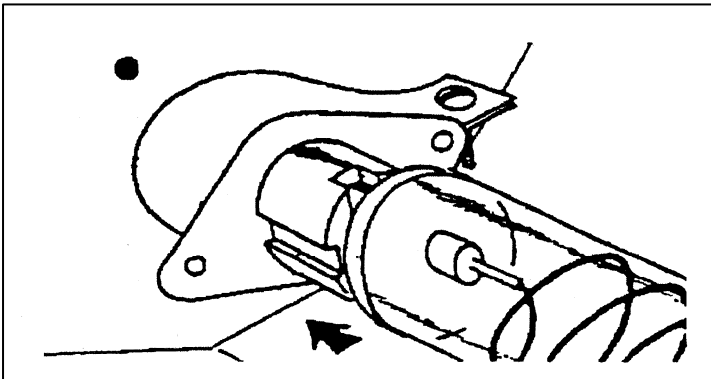

3. While keeping the tube compressed into the left terminal of the socket, position the right end of the tube directly beneath the right socket.

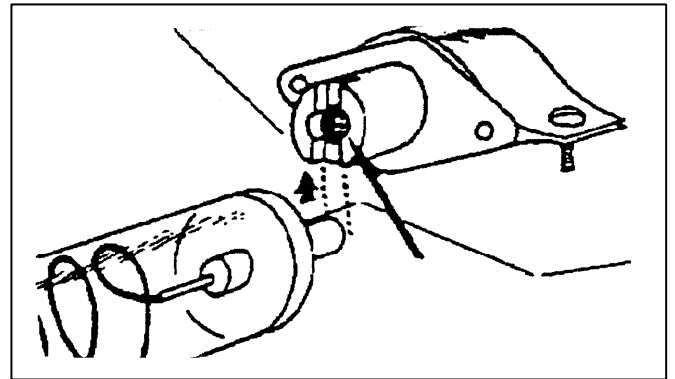

4. Raise the tube into direct alignment with the center of the right terminal. Release grip slowly allowing the compressed left socket (terminal) to lock tube into position.



**NOTE:**

These instructions are based on the unit laying on a work surface upside down.



**CAUTION:**

Be sure the tube is centered in the socket terminals before placing the warmer in the upright position and turning on power.

