

# Winston

## Hot Foods Merchandiser

### Parts Identification Manual



2345 Carton Drive  
Louisville, KY 40299 USA  
(800) 234-5286  
(502) 495-5400

# WINSTON HOT FOODS MERCHANDISER

## Table of Contents

Photo Reference ..... 1 - 4

Parts Descriptions & Order Numbers ..... 5 - 6

Wiring Diagram ..... 7

### How To Use This Manual

Use Photo Reference (pages 1 - 4) to identify parts. Match Photo Reference numbers with Parts Descriptions and Order Numbers (pages 5 - 6). To use Wiring Diagrams (Appendixes A - D), match model to corresponding Appendix (page 7).

# WINSTON HOT FOODS MERCHANDISER

## Parts Identification

**NOTE:** See page 5 - 6  
for Parts Descriptions  
and Order Numbers

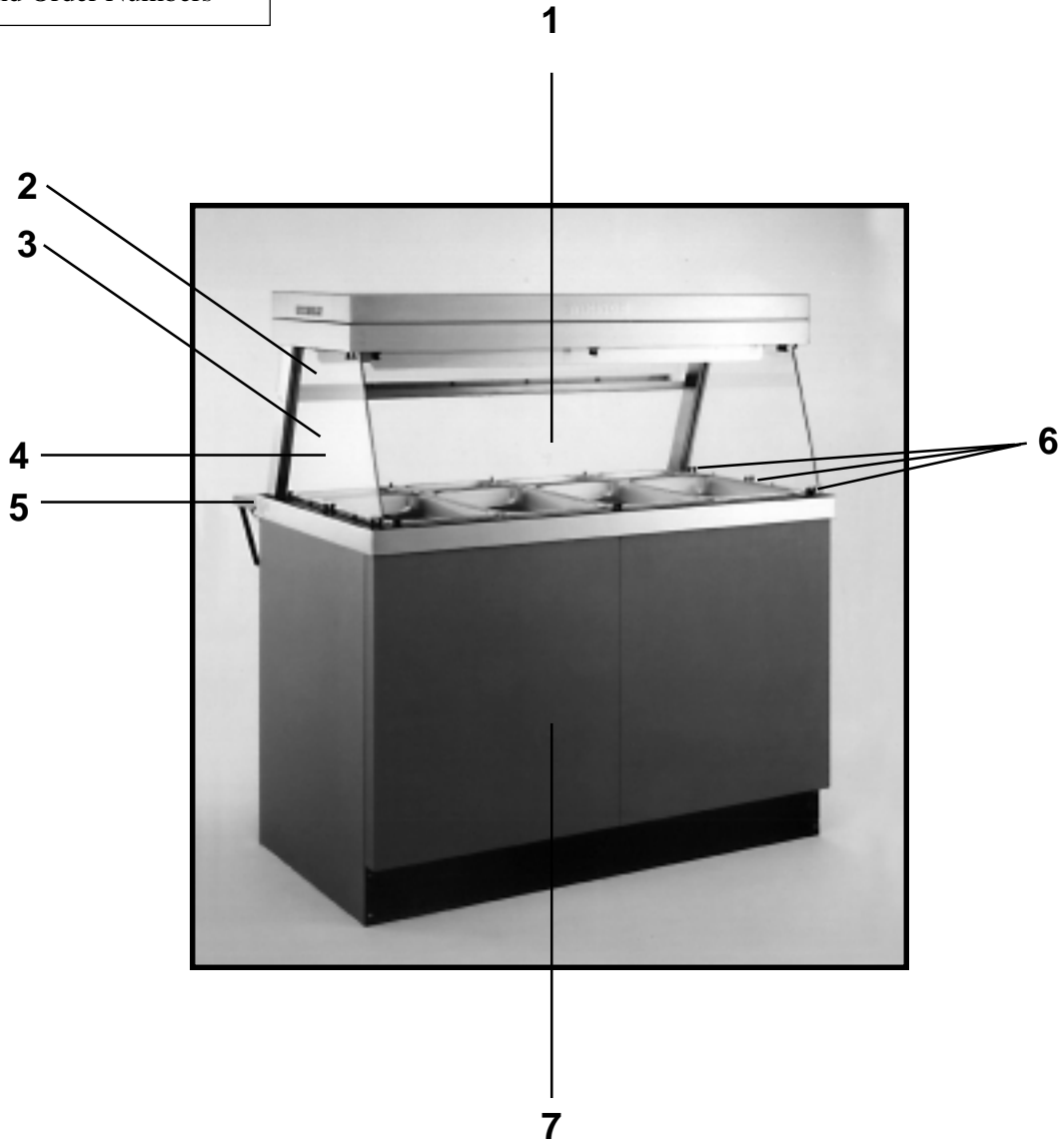

To order parts, contact your Winston representative or call the International office:  
**Winston Products Co.**  
**(800) 234-5286 USA & Canada/USA TEL: (502) 495-5400/USA FAX: (502) 495-5458**

# WINSTON HOT FOODS MERCHANDISER

## Parts Identification

**NOTE:** See page 5 - 6  
for Parts Descriptions  
and Order Numbers

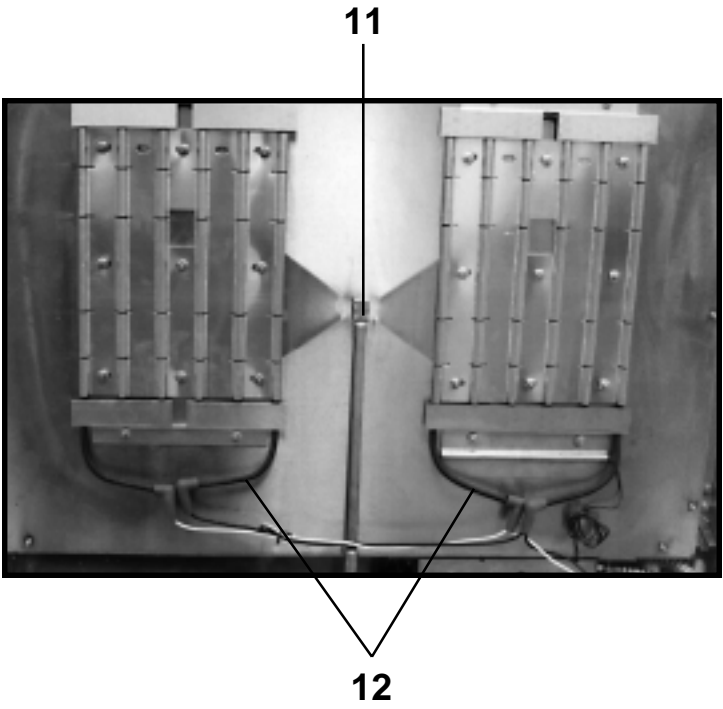
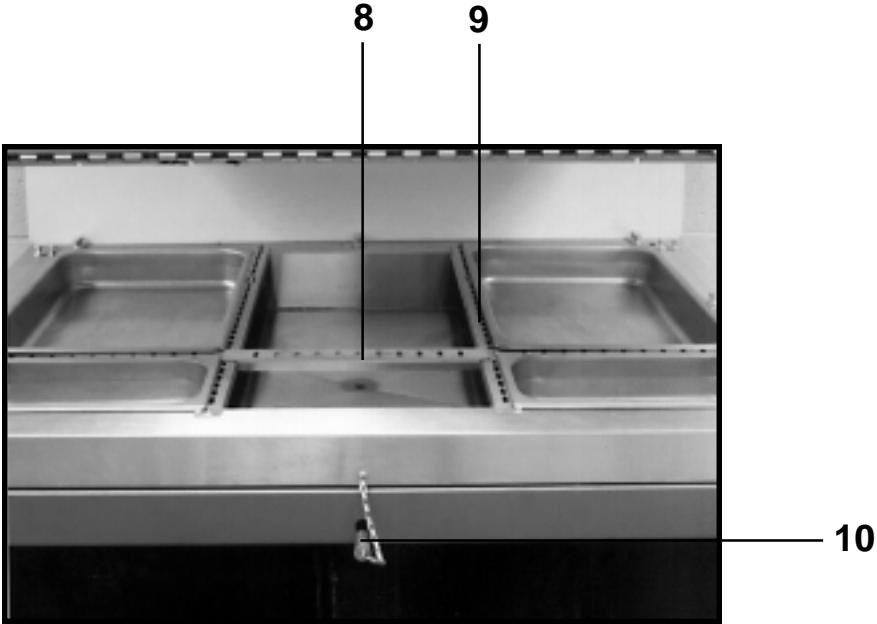

To order parts, contact your Winston representative or call the International office:  
**Winston Products Co.**  
**(800) 234-5286 USA & Canada/USA TEL: (502) 495-5400/USA FAX: (502) 495-5458**

# WINSTON HOT FOODS MERCHANDISER

## Parts Identification

**NOTE:** See page 5 - 6  
for Parts Descriptions  
and Order Numbers

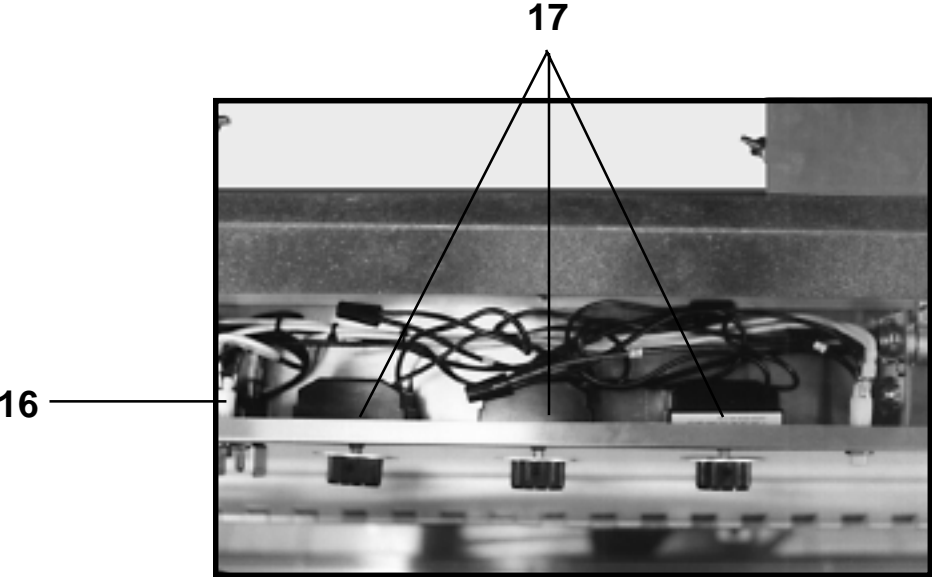
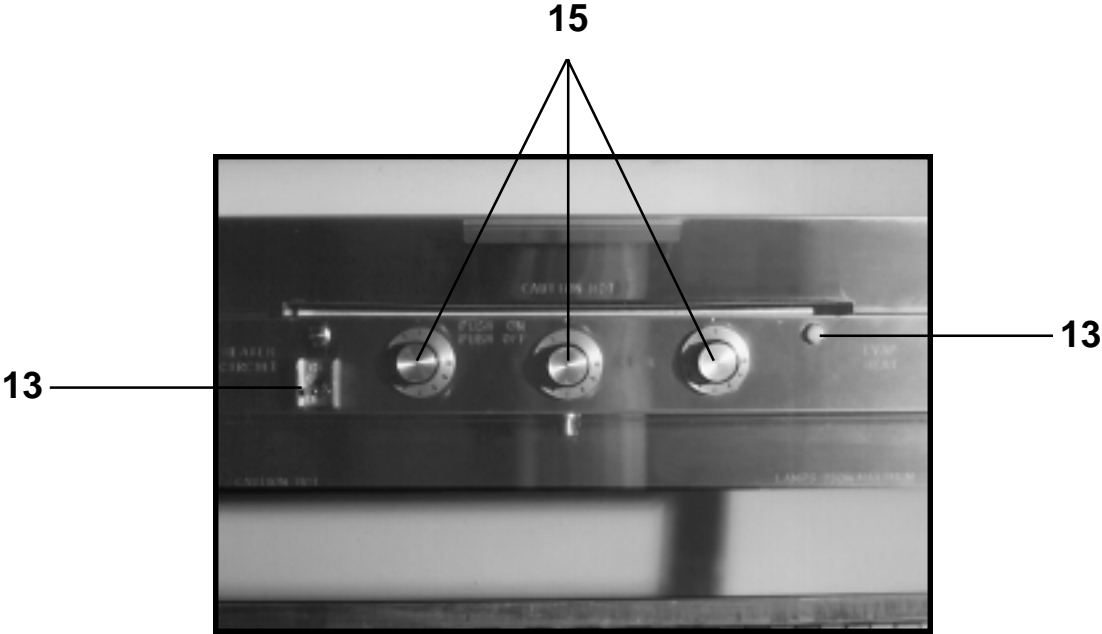

To order parts, contact your Winston representative or call the International office:  
**Winston Products Co.**  
**(800) 234-5286 USA & Canada/USA TEL: (502) 495-5400/USA FAX: (502) 495-5458**

# WINSTON HOT FOODS MERCHANDISER

## Parts Identification

**NOTE:** See page 5 - 6  
for Parts Descriptions  
and Order Numbers

18

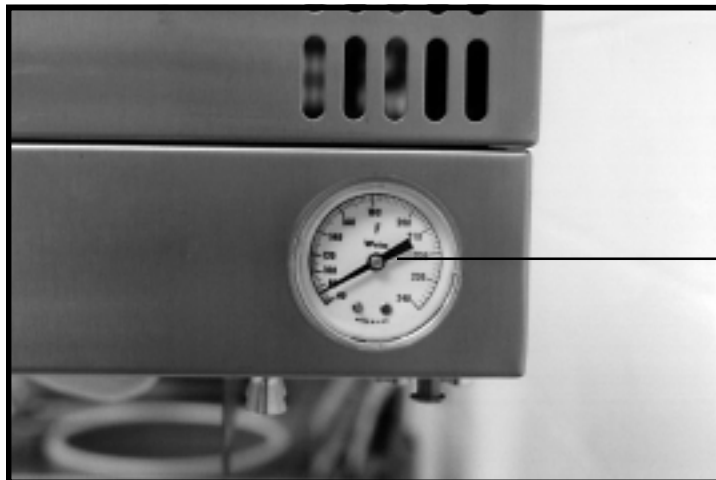
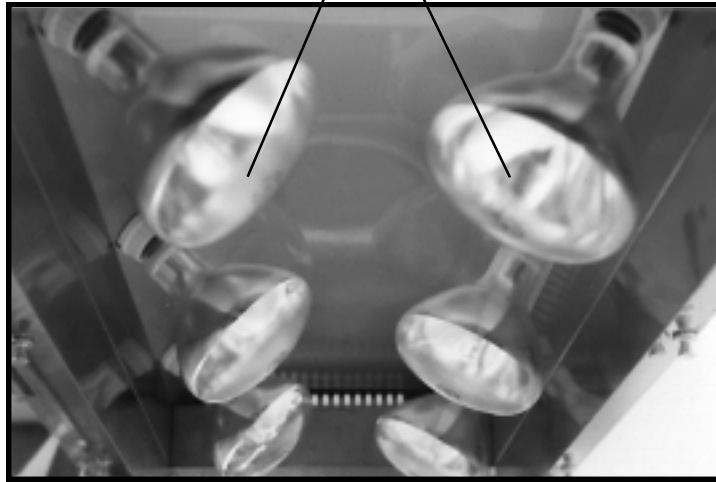

19

To order parts, contact your Winston representative or call the International office:  
**Winston Products Co.**  
**(800) 234-5286 USA & Canada/USA TEL: (502) 495-5400/USA FAX: (502) 495-5458**

# WINSTON HOT FOODS MERCHANDISER

## Parts Identification

Photo Reference Number	Part Description	Order Number
1	<b>Front Glass (2 Pan)</b> <b>Front Glass (3 Pan)</b> <b>Front Glass (4 Pan)</b> <b>Front Glass (5 Pan)</b>	<b>HPS1612</b> <b>HPS1611</b> <b>HPS1610</b> <b>HPS1840</b>
2	<b>Back Glass (2 Pan)</b> <b>Back Glass (3 Pan)</b> <b>Back Glass (4 Pan)</b> <b>Back Glass (5 Pan)</b>	<b>HPS1613</b> <b>HPS1614</b> <b>HPS1615</b> <b>HPS1839</b>
3	<b>Door Assembly (2 Pan)</b> <b>Door Assembly (3 Pan)</b> <b>Door Assembly (4 Pan-Left Side)</b> <b>Door Assembly (4 Pan-Right Side)</b> <b>Door Assembly (5 Pan-Left Side)</b> <b>Door Assembly (5 Pan-Right Side)</b> <i>Note: 4 &amp; 5 Pan models equipped w/ split doors</i>	<b>HPS1597</b> <b>HPS1596</b> <b>HPS2234</b> <b>HPS2235</b> <b>HPS2236</b> <b>HPS2237</b>
4	<b>Side Glass (All Models)</b>	<b>HPS1609</b>
5	<b>SS Serving Shelf (2 Pan)</b> <b>SS Serving Shelf (3 Pan)</b> <b>SS Serving Shelf (4 Pan)</b> <b>SS Serving Shelf (5 Pan)</b>	<b>HPS1381</b> <b>HPS1382</b> <b>HPS1383</b> <b>HPS1794</b>
6	<b>Glass Tabs</b>	<b>HPS1535/6</b>
7	<b>Floor Base Ass. (Mandarin Red) (2 Pan)</b> <b>Floor Base Ass. (Mandarin Red) (3 Pan)</b> <b>Floor Base Ass. (Mandarin Red) (4 Pan)</b> <b>Floor Base Ass. (Mandarin Red) (5 Pan)</b>	<b>HPS1370</b> <b>HPS1373</b> <b>HPS1376</b> <b>HPS1793</b>

To order parts, contact your Winston representative or call the International office:

**Winston Products Co.**

**(800) 234-5286 USA & Canada/USA TEL: (502) 495-5400/USA FAX: (502) 495-5458**

# WINSTON HOT FOODS MERCHANDISER

## Parts Identification

Photo Reference Number	Part Description	Order Number
8	Short Adapter	HPS1513
9	Long Adapter (2, 3, 4 Pan) Long Adapter (5 Pan)	HPS1515 HPS1968
10	Drain Cap	HPS1654
11	Drain Pipe	HPS1833
12	Water Heaters	HPS1437
13	Switch Guard	HPS1086
14	Evaporator Heat Lamp	HPS1103
15	Dimmer Switch Dials	HPS1250
16	Power Switch	HPS1529
17	Dimmer Switches	HPS1528
18	Heat Lamps (250 W, 120 Volt Infra-Red)	<i>Ref. Only</i>
19	Thermometer	HPS1827
<div style="border: 1px solid black; padding: 5px; width: fit-content; margin: 0 auto;"> <p><b>NOTE:</b> See pages 1 - 4 for Photo Reference</p> </div>		

To order parts, contact your Winston representative or call the International office:

**Winston Products Co.**

**(800) 234-5286 USA & Canada/USA TEL: (502) 495-5400/USA FAX: (502) 495-5458**

# WINSTON HOT FOODS MERCHANDISER

## Wiring Schematic

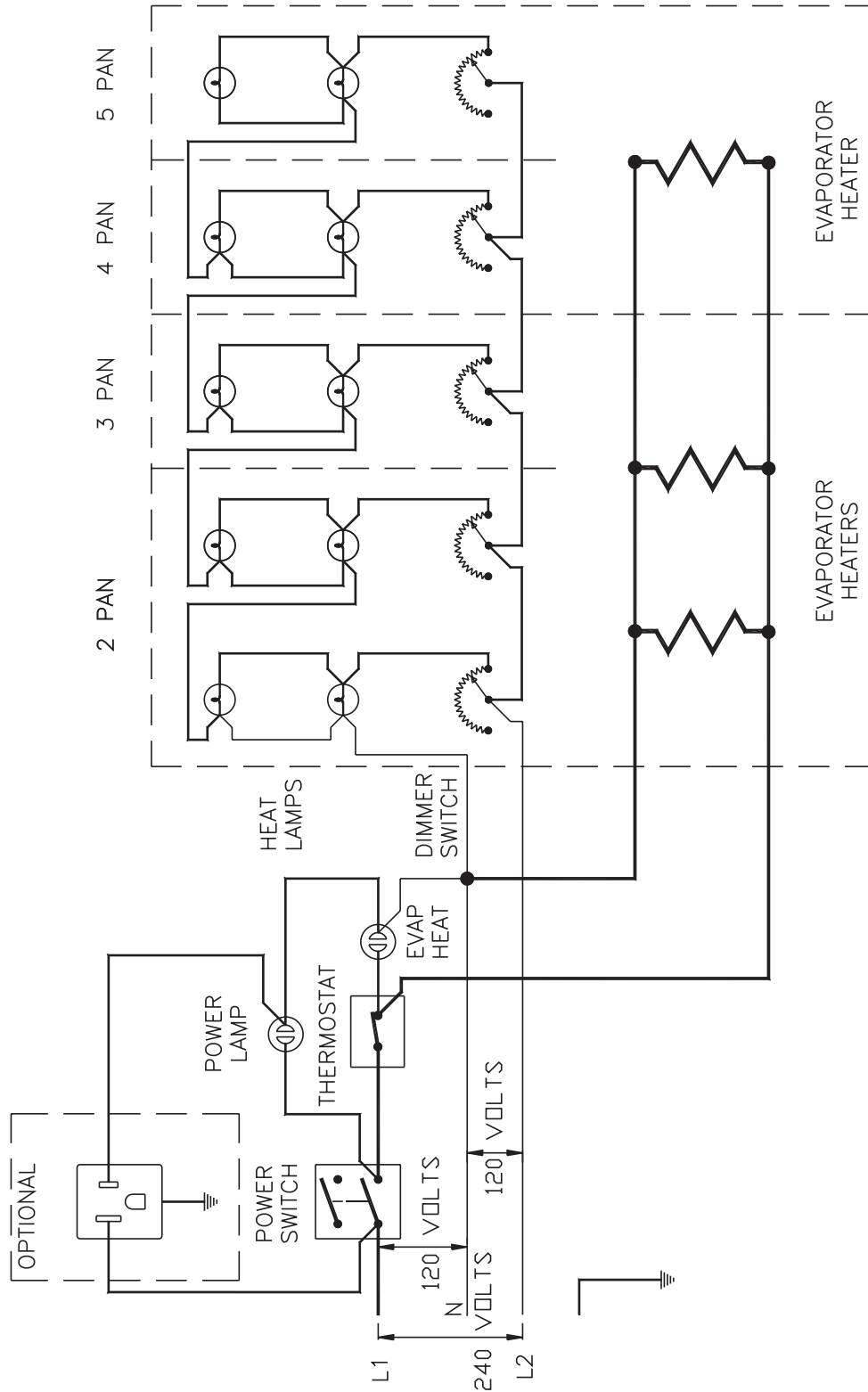

To order parts, contact your Winston representative or call the International office:

**Winston Products Co.**

**(800) 234-5286 USA & Canada/USA TEL: (502) 495-5400/USA FAX: (502) 495-5458**