



Installation & Operations Manual for

Endless TEM/TEL-SC Model
Glass Door Merchandisers With
Self-Contained Refrigeration Systems

Featuring LAE Electronic Controller

TABLE OF CONTENTS

INTRODUCTION	3
WARNING LABELS AND SAFETY INSTRUCTIONS	4
PRE-INSTALLATION INSTRUCTIONS	5
Inspection for Shipping Damage	5
INSTALLATION INSTRUCTIONS	5
General Instructions	5
Store Conditions	6
Location	6
Dimensional Data	7
Leveling	8
Joining multiple sections	8
Kickplate Installation	9
Removing and Replacing the Ends	9
Plumbing	10
Electrical	10
Piping	10
ELECTRONIC REFRIGERATION CONTROL	11-13
STARTING PROCEDURE	13
FINAL CHECK LIST	14
DOOR FRAMES AND DOORS	14
Door Plastic (Gasket Retainer) Replacement	14
Door Gasket Replacement	14
LED Driver Replacement	14
Door Heater Replacement	14
SERVICE INSTRUCTIONS	15
MASTER-BILT PART NUMBERS	16
SALE AND DISPOSAL	17
TEM WIRING DIAGRAMS	18
TEL WIRING DIAGRAMS	19

INTRODUCTION

Thank you for purchasing a Master-Bilt cabinet. This manual contains important instructions for installing, using and servicing a Master-Bilt **TEL/TEM** Self-Contain Endless Case. A parts list is included in with this manual. Read all these documents carefully before installing or servicing your equipment.



Read this manual before installing your cabinet. Keep the manual and refer to it before doing any service on the equipment. Failure to do so could result in personal injury or damage to the cabinet.



Improper or faulty hook-up of electrical components of the refrigeration units can result in severe injury or death.

All electrical wiring hook-ups must be done in accordance with all applicable local, regional or national standards.



Installation and service of the refrigeration and electrical components of the cabinet must be performed by a refrigeration mechanic and/or a licensed electrician.

The portions of this manual covering refrigeration and electrical components contain technical instructions intended only for persons qualified to perform refrigeration and electrical work.

This manual cannot cover every installation, use or service situation. If you need additional information, call or write us:

Customer Service Department
Master-Bilt Products
Highway 15 North
New Albany, MS 38652
Phone (800) 684-8988
Fax (866) 882-7629

WARNING LABELS AND SAFETY INSTRUCTIONS



This symbol is the safety-alert symbol. When you see this symbol on your cabinet or in this manual, be alert to the potential for personal injury or damage to your equipment.

Be sure you understand all safety messages and always follow recommended precautions and safe operating practices.



NOTICE TO EMPLOYERS

You must make sure that everyone who installs, uses or services your cabinet is thoroughly familiar with all safety information and procedures.

Important safety information is presented in this section and throughout this section and throughout the manual. The following signal words are used in the warnings and safety messages:

DANGER: Severe injury or death will occur if you ignore the message.

WARNING: Severe injury or death can occur if you ignore the message.

CAUTION: Minor injury or damage to your cabinet can occur if you ignore the message.

NOTICE: This is important installation, operation or service information. If you ignore the message, you may damage your cabinet.

The warning and safety labels shown throughout this manual are placed on your Master-Bilt Products cabinet at the factory. Follow all warning label instructions. If any warning or safety labels become lost or damaged, call your customer service department at (800) 684-8988 for replacements.

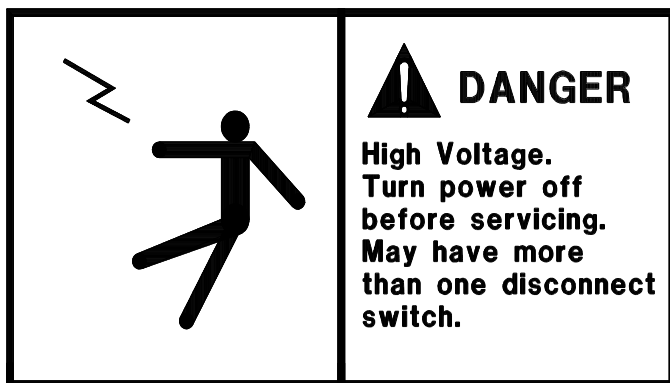

This label is located on top of the electrical control panel and on the wiring channel.

PRE-INSTALLATION INSTRUCTIONS

INSPECTION FOR SHIPPING DAMAGE

You are responsible for filing all freight claims with the delivering truck line. Inspect all cartons and crates for damage as soon as they arrive. If damage is noted to shipping crates or cartons or if a shortage is found, note this on the bill of lading (all copies) prior to signing.

If damage is discovered when the cabinet is uncrated, immediately call the delivering truck line and follow up the call with a written report indicating concealed damage to your shipment. Ask for an immediate inspection of your concealed damage item. Crating material must be retained to show the inspector from the truck line.

INSTALLATION INSTRUCTIONS

GENERAL INSTRUCTIONS

1. Be sure the equipment is properly installed by competent service people.
2. Keep the equipment clean and sanitary so it will meet your local sanitation codes. Wipe up all spills, clean with water and a mild detergent, then rinse with clean water.
3. Rotate your stock so that older stock does not accumulate. This is especially important for ice cream. A "First-In, First-Out" rotation practice will keep the products in good sellable condition.
4. Do not place product in the case when it is soft or partially thawed. Also, product should not be put in the case for at least 6 hours after it is started.
5. Stock cases as quickly as possible, exposing only small quantities to store temperatures for short periods of time.
6. When replacing burned fluorescent bulb/LED light bar, be sure that the electrical power to the lighting circuit is turned off.



To comply with N.S.F. requirements, this cabinet must be sealed to the floor with NSF listed silicone sealant. Before moving cabinet into place, route cabinet plumbing with P-trap to store drain line or install optional condensate pan.

STORE CONDITIONS

The Master-Bilt **TEL/TEM** Self-Contain cases are designed to operate in the controlled environment of an air conditioned store. The store temperature should be at or below 75 F and a relative humidity of 55% or less. At higher temperature or humidity conditions, the performance of these cases may be affected and the capacity diminished. It is not uncommon in a newly constructed store for the temperature and humidity to be above design conditions. These excessive conditions may produce sweating in the case until the store is operational and the ambient environment is more desirable.

LOCATION

The Master-Bilt **TEL/TEM** Self-Contain should not be positioned where it is directly exposed to rays of the sun or near a direct source of radiant heat or air flow.

Cabinet should not be built into an enclosed area. If this case is to be located against a wall there should be at least a 4" space between the wall and the back of the case, with 4" open space at top and one or both ends. This space will allow for the circulation of air behind the case which will prevent condensation on the exterior surfaces.

Make sure that the floor that will support this equipment is of adequate strength to prohibit sagging. After confirming the dimensions of case with the blueprint measure off and mark on the floor the exact location of the cases for the entire lineup. Snap chalk lines where the base skids of the case are to be located as shown in **Figure 1**.

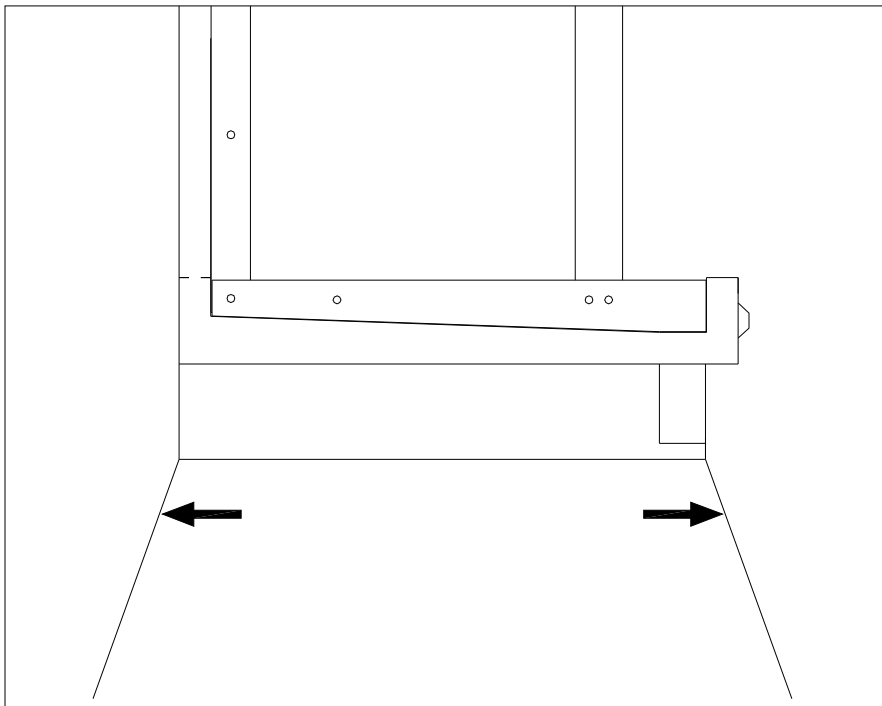
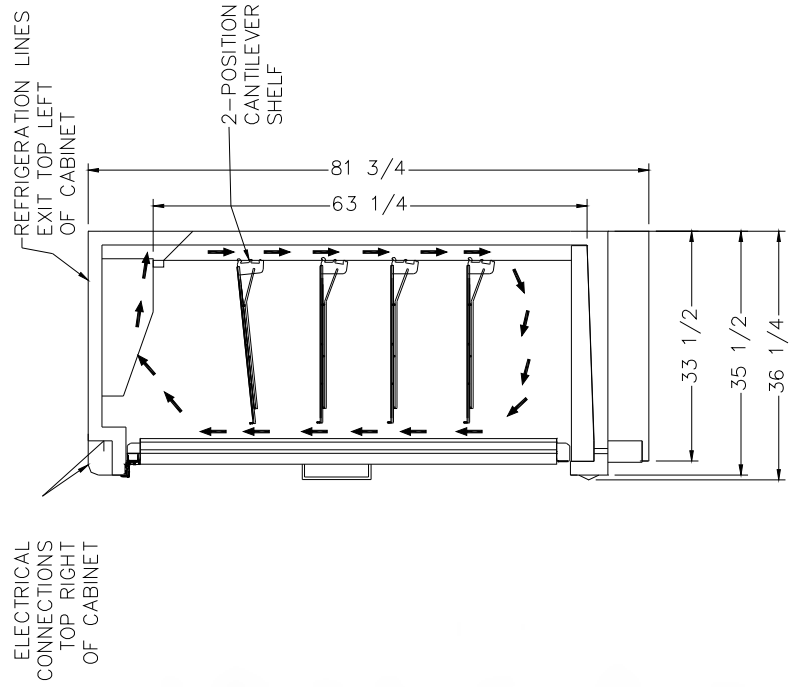
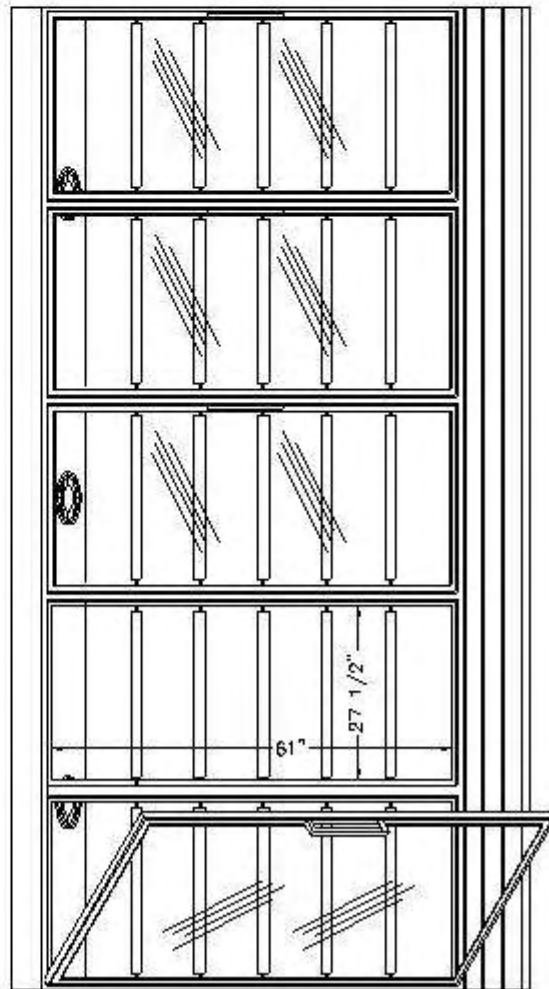
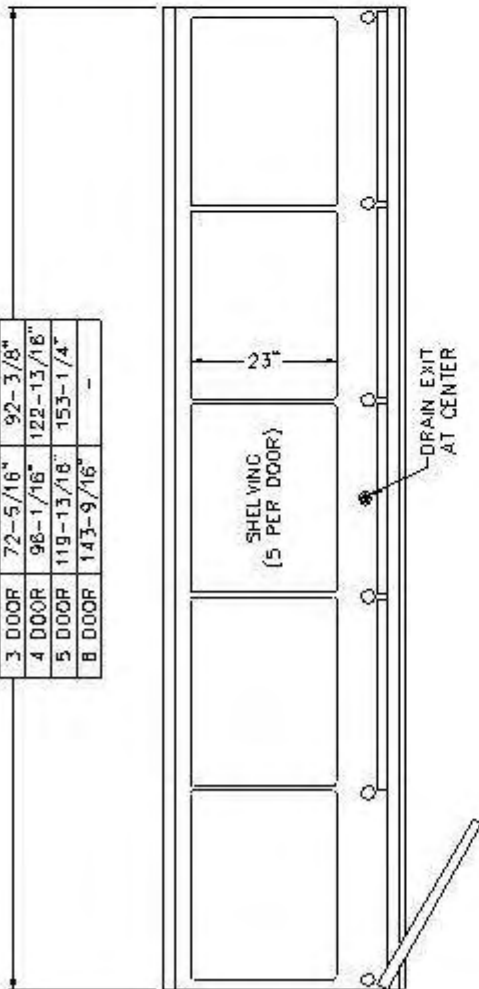

Figure 1 – Chalk lines at front and back edges of skids

MODEL	24" DOORS	30" DOORS
2 DOOR	—	81-15/16"
3 DOOR	72-5/16"	92-3/8"
4 DOOR	96-1/16"	122-13/16"
5 DOOR	119-13/16"	153-1/4"
6 DOOR	143-9/16"	—



LEVELING

It is very important that this equipment be perfectly level. This will allow for proper and complete drainage of the evaporator coil and for proper case alignment. A perfectly level area is generally not available where the equipment is to be installed. Mark the location of all case joining points front and back. Use a transit to locate the highest point on the chalk lines. This point will be a reference point for determining shim-pack heights. Using the reference point, mark the difference directly on the floor to each joining point front and back. Shim each joining point to equal the reference point as required. Tape all shims in place. If the installation is an entire lineup install the case that will be positioned at the highest point first. Check that the equipment in the lineup is level as the installation proceeds.

JOINING MULTIPLE SECTIONS

Remove the case from its shipping skid. Set the first case into its desired position with required shims in preparation for joining it with its adjacent case.

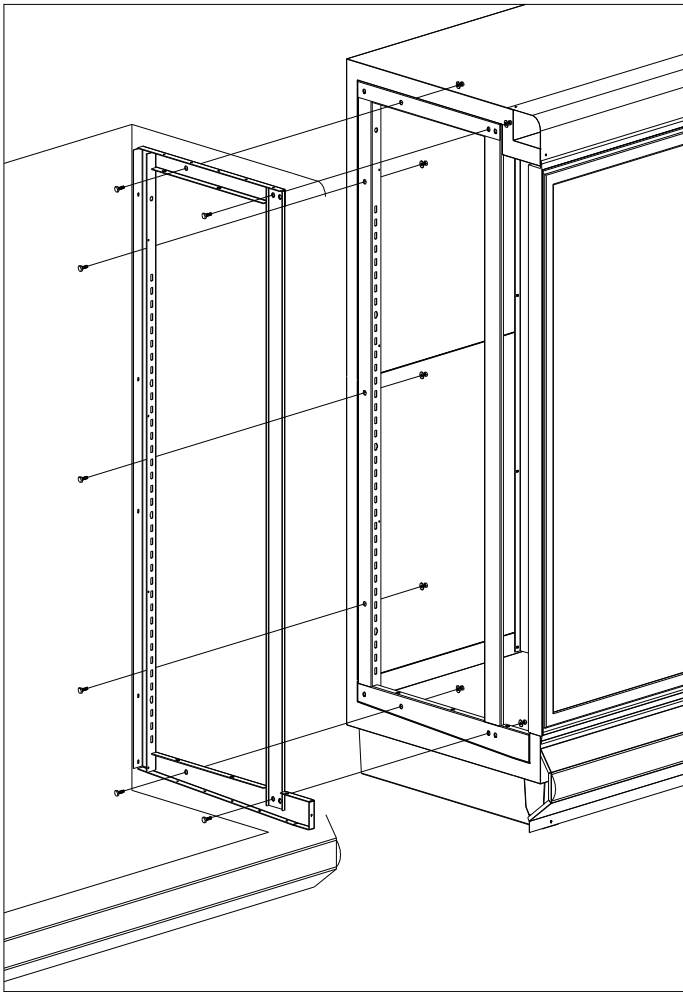

Figure 2 – Case joining detail

Bolt the included sex bolts through the door frame to secure the door frames together as shown in **Figure 3**. Make sure that the tee molding strip is inserted between the door frames before bolting together. Repeat the above process for all other cases in the lineup.

Cases joined together require an application of butyl caulking to provide an air-tight seal. Apply a generous bead to all exposed foam edges at the end of the case. Inspect the bead to make sure there are no gaps and that there is sufficient material to provide a complete seal. The cases are now ready to be joined together. Remove the second case from its shipping skid and move it into position against the end of the first case. Properly level the second case with the appropriate shims.

Bolt the cases together through the seven holes that are provided in the end frame as shown in **Figure 2**. Tighten the bolts until all seams are fully closed. Do not over tighten.

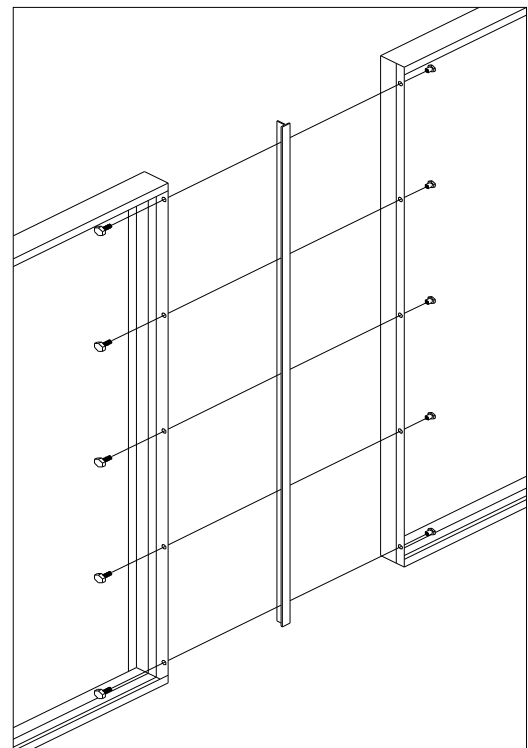

Figure 3 – Door frame joining detail

INSTALLING THE KICKPLATE

Install the kickplate by slipping the top flange of the kickplate into the kickplate retaining clip that is mounted on the front of the case. Secure the bottom of the kickplate by screwing through the pre-drilled holes into the front of the skids using the supplied #10x3/4" sheet metal screws. Refer to **Figure 4** for the placement of the kickplate.

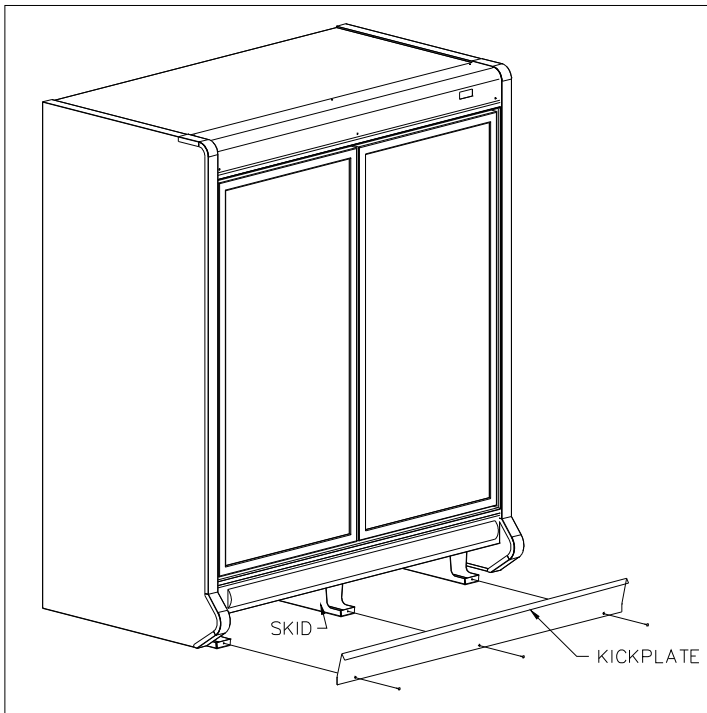

Figure 4 – Kickplate detail

REMOVING AND REPLACING THE ENDS

The ends of a **TEL/TEM** Self-Contain are bolted to the ends of the cabinet itself. There are seven attachment points on each end as shown in **Figure 5**. Each attachment point uses a 5/16" hex head bolt and washer. The bolts are fed through the holes in the end frames and into threaded retainers in the end panel. Care should be taken not to overtighten the bolts as this could lead to stripping of the threaded retainer. Consult the factory if it is necessary to remove or replace the end of a **TEL/TEM** Self-Contain.

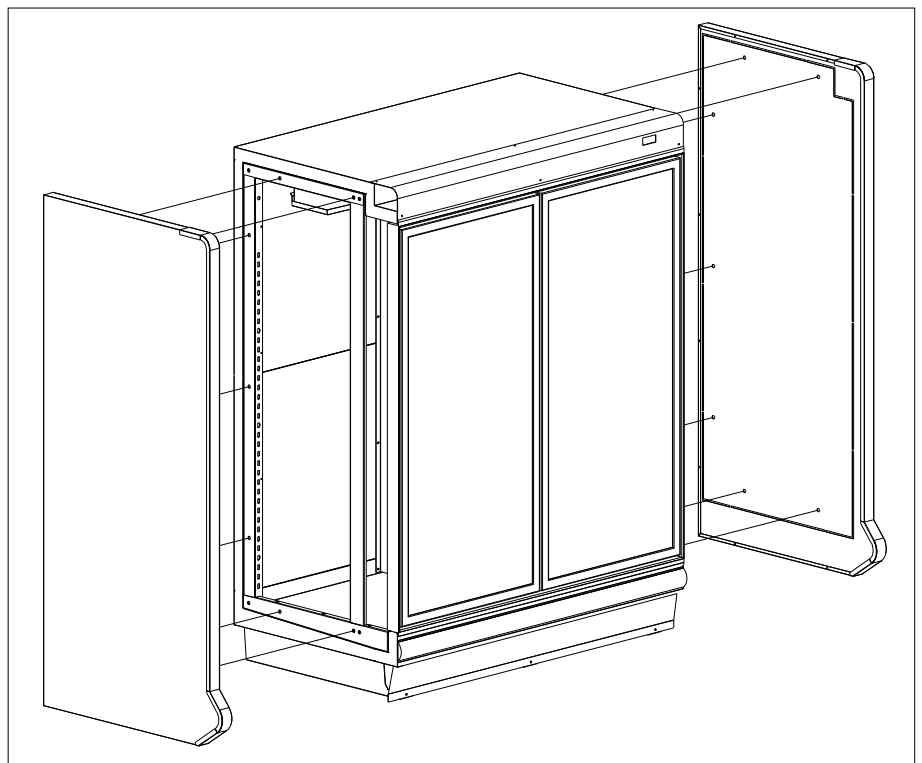

Figure 5 – End panel detail

PLUMBING

The **TEL/TEM** Self-Contain is equipped with a condensate drain that is piped out the middle front of the cabinet. This drain line is 1" PVC pipe that must be have a P-trap installed. It is very important that this trap be installed as it will result in diminished performance of the case without it. There is also a 1" cleanout drain in the middle front of the bottom the cabinet. The kick plate will need to be removed to see the piping for the cleanout drain.

1. Always install drains in accordance with local codes.
2. Use largest possible size pipe for drains, one inch minimum is recommended.
3. Provide as much downhill slope as possible.
4. Prevent drains from freezing. Do not install drains in contact with un-insulated suction lines.



NOTICE TO STORE OWNERS / MANAGERS

Moisture or liquid around or under the cabinet is a potential slip/fall hazard for persons walking by or working in the general area of the cabinet. Any cabinet malfunction or housekeeping problem that creates a slip/fall hazard around or under the cabinet should be corrected immediately.

If moisture or liquid is observed around or under a Master-Bilt cabinet, an immediate investigation should be made by qualified personnel to determine the source of the moisture or liquid. The investigation should determine if the cabinet is malfunctioning or if there is a drain pipe leaking.

ELECTRICAL



WARNING

Before servicing electrical components in the case or the doors or door frames make sure all power to case is off. Always use a qualified technician.

It is very important that full voltage and overcurrent protection requirements for condensing units, defrost heaters, fans, door and frame heaters, etc. be provided at installation. Wire sizing must be adequate to maintain full voltage under amperage loads specified in the charts are in this manual.

PIPING

All **TEL/TEM** Self-Contain cases utilize quick-connect fittings on both the case and condensing unit. These systems come pre-charged flexible hose and sealed for easy installation. Suction and liquid lines are also provided with quick-connect fittings for connection in the field. These lines serve as a guide to the placement of the condensing unit on top of the case. Locate the unit so that all connections can be easily made, being especially careful not to "kink" the lines. All suction lines should be well-insulated to minimize heat absorption and control condensate which could form on the suction line. If tubular insulation is used, the ends, joints, and any other open areas (including slits necessary to fit the tubing over installed piping) should be sealed with insulation glue. Leak check all joints with an electronic leak detector or halide torch. If leaks are found relieve the pressure and make repairs as necessary and recheck. All openings for wiring should be sealed with NSF listed sealant to prevent air leaks and unwanted condensation.

MASTER-BILT ELECTRONIC REFRIGERATION CONTROL

OPERATION



Display Lay-out

INDICATIONS

- Thermostat output
- Fan output
- RL3** Auxiliary output
- II°** Activation of 2nd parameter set
- Alarm

- Info / Setpoint button.
- Manual defrost / Decrease button.

- Increase / manual activation button.
- Exit / Stand-by button.

OPERATION

DISPLAY

During normal operation, the display shows either the temperature measured or one of the following indications:

DEF	Defrost in progress	HI	Room high temperature alarm
REC	Recovery after defrost	LO	Room low temperature alarm
OFF	Controller in stand-by	E1	Probe T1 failure
CL	Condenser clean warning	E2	Probe T2 failure
DO	Door open alarm		

Compressor / Solenoid valve When power is first turned on to the control, the LED indicator for the relay output will go through the start-up delay. After a one-minute delay the Solenoid valve will click on. The LED indicator stays on while compressor relay is energized. Display will show actual box temperature. Picture above is the display layout. The compressor will be cycled off when the actual box temperature reaches its set point. The cooling relay output indicator will be off.

Fan The fans will run constantly for TEM cooler application and off during a defrost for the TEL freezer application. The Evaporator fan will also cut off when the evaporator temp is above the fan stop temperature setting.

When the TEL freezer is in defrost mode; the fan is off until the end of the defrost and the 2 minute drip time has passed. There is 2 minute delay after a defrost before the fan comes on. If the Evaporator temperature is 35 °F or below the controller will override the fan delay. FAN LED indicator is on while FAN relay is energized.





Defrost The control uses time defrost with 4 defrosts per day for the TEL freezer and off cycle defrost for the TEM cooler. The TEL time defrost scheme can be re-set for special applications. During defrost the display will show DEF and REC for recovering after the defrost. The control begins timing the defrost when power is turned on. Four defrost per day means it will occur every 6 hours. To have defrost occur at 8am, 2pm, 8pm, and 2am then power up at one of these four times.

MANUAL DEFROST

Defrosting may also be induced manually by keeping the defrost button for 5 seconds. Once defrost has started, the defrost will go through a defrost and drip time pull down cycle.

HOW TO CHANGE THE SETPOINT











SETPOINT (display and modification of desired temperature value)

- Press button  for at least half second, to display the setpoint value.
- By keeping button  pressed, use button  or  to set the desired value (adjustment is within the minimum **SPL** and the maximum **SPH** limit).
- When button  is released, the new value is stored.

STAND-BY

Button , when pressed for 3 seconds, allows the controller to be put on a standby or output control to be resumed (with **SB=YES** only).

CONFIGURATION PARAMETERS

- The setup menu is accessed by pressing button + for 5 seconds.
- With button  or  select the parameter to be modified.
- Press button  to display the value.
- By keeping button  pressed, use button  or  to set the desired value.
- When button  is released, the newly programmed value is stored and the following parameter is displayed.
- To exit from the setup, press button  or wait for 30 seconds.

LIST OF PARAMETERS

Here is a list of the parameters the value of which can be changed in the programming mode, as well as their ranges.

Display Symbol	Parameters	Range	Factory Setting	Factory Setting
			TEM	TEL
SP	Temperature Set Point	SPL...SPH	35°F	-10°F
HYS	Temperature Differential	1...10°F	5°	7°
SPL	Minimum Temperature limit setpoint	-50°...SPH	20	-30
SPH	Maximum Temperature limit setpoint	SPL...120°	50	20
DFR	Number of Defrost Cycle per 24hr	0...24	Air	4
DLI	Defrost Termination Temperature	-50...120°	Off Cycle	55°F
ALA	Low Temperature Alarm	-50...120°	0°F	-35°F
AHA	High Temperature alarm	-50...120°	55°F	32°F
ATD	Temperature Alarm Delay	0...255 min	30min	30min
DTO	Maximum Defrost Duration	1...120min	30min	30min

**This is a standard setting; climates with extreme humidity may require more defrost times or longer fail safe settings*

***for any other parameters and setting please consult factory for more details and instructions**

INSTALLATION

- Insert the controller through a hole measuring 71x29 mm.
- Make sure that electrical connections comply with the paragraph "wiring diagrams". To reduce the effects of electromagnetic disturbance, keep the sensor and signal cables well separate from the power wires.
- Fix the controller to the panel by means of the suitable clips, by pressingly gently; if fitted, check that the rubber gasket adheres to the panel perfectly, in order to prevent debris and moisture infiltration to the back of the instrument.
- Place the probe T1 inside the room in a point that truly represents the temperature of the stored product.
- Place the probe T2 on the evaporator where there is the maximum formation of frost.

SENSOR PROBE TEMPERATURE AND RESISTANCE

NTC10K Temperature - Resistance

Temp (°C)	Temp (°F)	R-low (Kohm)	R-center (Kohm)	R-high (Kohm)
-30	-22	109.522	113.347	117.294
-25	-13	84.823	87.559	90.374
-20	-4	66.270	68.237	70.255
-15	5	52.229	53.650	55.104
-10	14	41.477	42.506	43.557
-5	23	33.147	33.892	34.651
0	32	26.678	27.219	27.767
5	41	21.630	22.021	22.417
10	50	17.643	17.926	18.210
15	59	14.472	14.674	14.877
20	68	11.938	12.081	12.224

STARTING PROCEDURE

1. Check the temperature holding range against the control setting.
2. Check the defrost control system to see that all ice is removed from the coil during each defrost cycle.
3. Check pressures.
4. Check EPR Valve for proper pressure when applicable.
5. Condensing Unit Low Pressure Control
 - a. TEL Cut in 20 lbs: diff. 18 lbs.
 - b. TEM cut in 35 lbs: diff 25lbs.
6. Condensing Unit Low Pressure Control
 - a. TEL 400 lbs.
 - b. TEM 380 lbs.

FINAL CHECK LIST

- A. *Check high-low pressure control settings.*
- B. *Check operating pressure.*
- C. *Check electrical requirements of unit to supply voltage.*
- D. *Check setting of thermostatic expansion valve for proper operation. Approx. 10°F superheat.*
- E. *Check sight glass for proper refrigerant charge.*
- F. *Check condensing unit for vibrating or rubbing tubing. Dampen and clamp as required.*
- G. *All valves should be completely open counter-clockwise.*
- H. *Check packing nuts on all service valves.*
- I. *Replace all service valve caps and latch unit covers.*
- J. *Check refrigeration line for proper P-traps and proper locations.*
- K. *Check drain for proper P-traps and proper locations.*

DOOR PLASTIC (GASKET RETAINER) REPLACEMENT

Starting in corner, gently pull the rubber gasket away from the door plastic. With gasket removed, insert a flat-head screwdriver under the outside edge of the plastic, and gently pry up. At either end of the plastic run the screwdriver the complete length and width of the door rail. With the outside edge of the plastic released, push the plastic towards the glass to remove. To replace, insert the edge of the plastic into the inside door rail groove. Snap the outside edge of the plastic cover over the outside edge of the door rail.

DOOR GASKET REPLACEMENT

Remove the old gasket by starting in the corner, gently pulling gasket away from the plastic. To replace the gasket, remove the top and bottom door plastic, and slide the gasket up the two verticals. Slide the top and bottom plastic onto the gasket, and replace the top and bottom plastic on the door rail. Tuck in the corners of the gasket with a flat-head screwdriver.

LED DRIVER REPLACEMENT, TEL/TEM

For a **TEL/TEM**, the LED Drivers are located inside the door mullions and can be accessed from the front of the door frame. Remove the door that hinges on the mullion where the ballast will be replaced. From the front of frame, remove contact plate & retainer by inserting a flat-head screwdriver under back edge of black contact plate retainer, and gently pull to unsnap retainer from the mullion. Repeat for the other side, and remove the contact plate. With the ballast now exposed, remove the screw on the top end of the ballast. Loosen the screw on the bottom of the driver.

Disconnect all lead wires by separating the connectors. If cut, leave enough lead wire to re-connect the new driver with a wire nut. Insert the bottom of the new ballast in the punched tabs and re-install the top screw in the top end of the driver. Tighten both screws. Re-connect new driver's lead wires following the wiring diagrams provided.

DOOR HEATER REPLACEMENT

Remove door gasket and plastic. Remove the center side access plate located on the side of the door. The wiring for the door is done in the center side of the hinge rail. To remove the heater, unplug the solid lead wires: Black or Red, White, and Green/Yellow (ground). If the glass is heated, unplug the Black and White solid wires from the glass. Heater wire lies in track on the back outside edge of door. Pull the heater out. Reverse instructions to replace the door heater. Plug in Black or Red lead wire from hinge pin to Black or Red lead wire from heater, White lead wire from hinge pin to White heater lead, and Green/Yellow lead from hinge pin to ground.

Note: If glass is heated, plug in Black and White lead wires coming off heater loom to Black and White lead wires from glass. Replace side access plate. Replace the door plastic and gasket.

SERVICE INSTRUCTIONS (Trouble Shooting Guide)

1. High head pressure and high back pressure:
 - A. Condenser coil clogged or restricted.
 - B. Condenser fan motor defective.

2. Low back pressure and low head pressure:
 - A. Restriction in system.
 - B. Refrigerant undercharged.
 - C. Leak in system.

3. Pressures normal – cabinet warm:
 - A. Coil blocked with frost or ice (see #4).
 - B. Refrigerant undercharged.
 - C. Control set too warm.
 - D. Air screen disturbance.

4. Coil blocked with frost or ice:

<ol style="list-style-type: none">A. Defective temperature control.B. Time clock not operating properly.C. Improper time clock setting.D. Ambient conditions above 75°F/55% RH.E. Defrost heater not operating.	<ol style="list-style-type: none">E. P-trap in drain not installed.F. Doors aren't sealing when closed.G. Air screen disturbance.H. Evaporator fan motor defective.I. Low voltage.
---	--

5. Compressor starts and runs – but cycles on overload:
 - A. Low voltage.
 - B. Dropped phase (3 phase).
 - C. Overload protector defective.
 - D. High head pressure (see#1).

6. Compressor will not start – hums, but cycles on overload:
 - A. Low voltage.
 - B. Relay defective.
 - C. Overload defective.
 - D. High head pressure (see #1).

7. Special service situations:

If moisture or liquid is observed around or under a Master-Bilt cabinet, an immediate investigation should be made by qualified personnel to determine the source of moisture or liquid. The investigation made should determine if the cabinet is malfunctioning or if there is a simple housekeeping problem.

Moisture or liquid around or under a cabinet is a potential slip/fall hazard for persons walking by or working in the general area of the cabinet.

Any cabinet malfunction or housekeeping problem that creates a slip/fall hazard around or under a cabinet should be corrected immediately.

MASTER-BILT PART NUMBERS

The table below gives Master-Bilt part numbers for use when ordering replacement parts for your **TEL/TEM** cases.

Description	TEL (Low Temp)	TEM (Med Temp)
Evaporator Coil	<i>Consult Factory</i>	
Expansion Valve	09-09634 Sporlan SBFSE-A-ZP	09-09631 Sporlan SBFVE-A-C
Defrost Heater	<i>Consult Factory</i>	N/A
Drain Line Heater	17-09063 230V / 6 ½ Watts	N/A
Heater Safety	19-01307	N/A
Electronic Control	19-14278	19-14243
Control Display	19-14273	N/A
Box Sensor	19-14244	19-14244
Evaporator Sensor	19-14245	N/A
Evaporator Fan Motor	13-13182	13-13181
Evaporator Fan Blade	15-13106	15-13106
Evaporator Fan Guard	25-01324	25-01324
Standard Shelf Wire Cantilever	33-01798 (30" Black) 33-01797 (30" White) 33-01605 (24" Black) 33-01474 (24" White)	33-01798 (30" Black) 33-01797 (30" White) 33-01605 (24" Black) 33-01474 (24" White)
Door Frame	<i>Consult Factory</i>	
Standard Door (Black)	31-03013 (30") 31-03017 (24")	31-03073 (30") 31-02973 (24")
LED Driver	23-01823	23-01823
LED Mullion light bar	23-01816	23-01816
Lamp Left Side light bar	23-01825	23-01825
Lamp Right Side light bar	23-01824	23-01824
Door Gasket	37-01385 (30") 37-01386 (24")	37-01385 (30") 37-01386 (24")
Torque-Master (Black)	35-01839	35-01839
Torque Rod	35-01840	35-01840
Top Hinge Pin	35-01842	35-01842
Door Frame Heaters	<i>Consult Factory</i>	
Condensing Unit	MHLZ007FB (2 & 3 doors) MHLZ008FB (4doors) MHLZ009FB (5doors)	MHHZ007FB
Pre-Charged Flexible Hose	09-10171 Liquid (3&4 doors) 09-10172 Suction (3&4 doors) 09-10171 Liquid (5 doors) 09-10174 Suction (5 doors)	09-10171 Liquid 09-10172 Suction

SALE AND DISPOSAL

OWNER RESPONSIBILITY

If you sell or give away your Master-Bilt cabinet you must make sure that all safety labels and the Installation - Service Manual are included with it. If you need replacement labels or manuals, Master-Bilt will provide them free. Contact the customer service department at Master-Bilt at (800) 684-8988.

The customer service department at Master-Bilt should be contacted at the time of sale or disposal of your cabinet so records may be kept of its new location.

If you sell or give away your Master-Bilt cabinet and you evacuate the refrigerant charge before shipment, Master-Bilt recommends that the refrigerant charge be properly recovered in compliance with section 608 of the Clean Air Act effective November 1995 and in accordance with all applicable local, regional, or national standards.

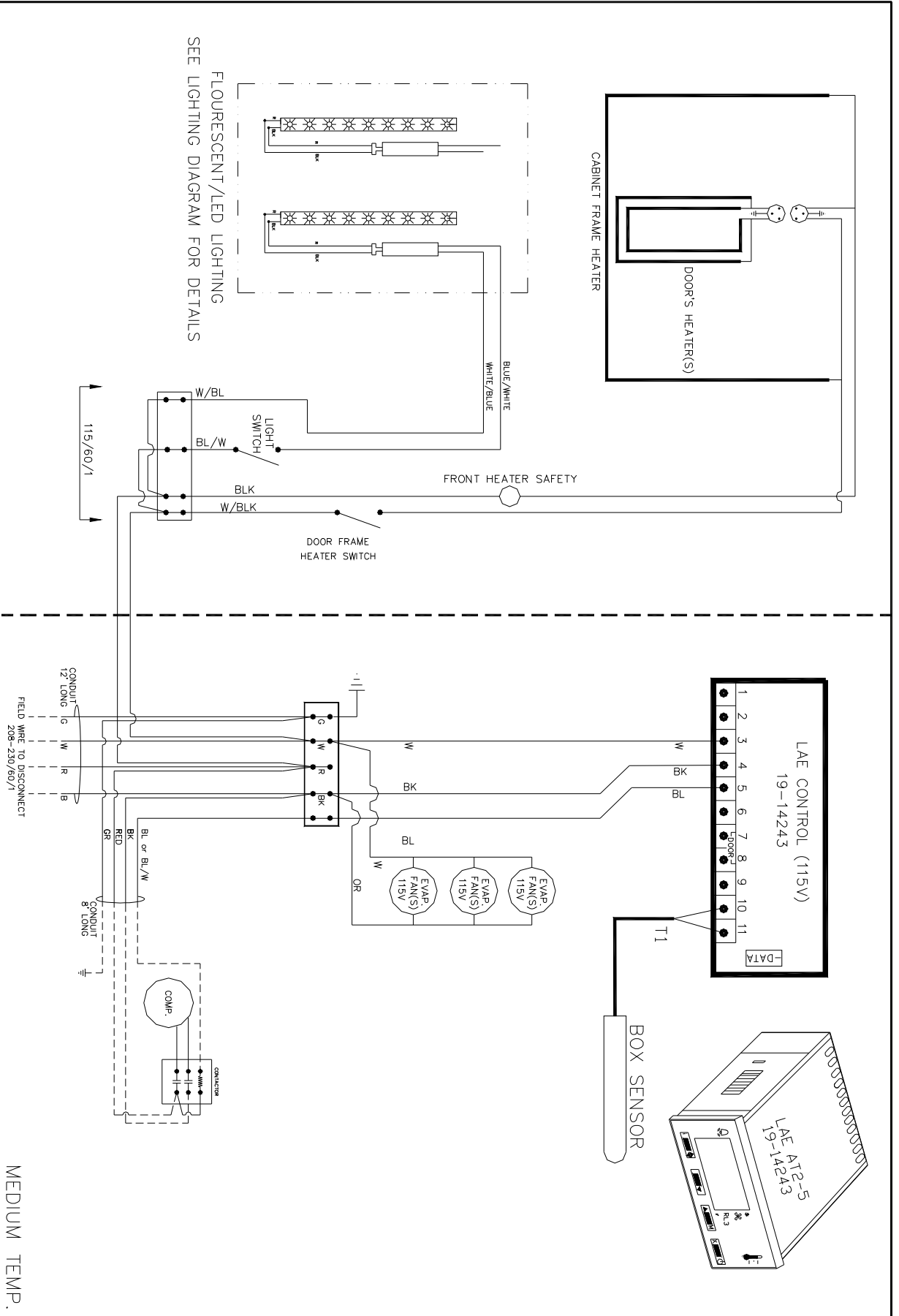

FLUORESCENT/LED LIGHTING
SEE LIGHTING DIAGRAM FOR DETAILS

MEDIUM TEMP.

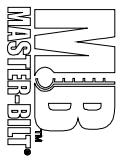

TEM-2SC, TEM-3SC, TEM-4SC, TEM-5SC, TEM-6SC
WIRING DIAGRAM (LAE_AT2 CONTROLLER)

7/20/12

SELF-CONTAIN

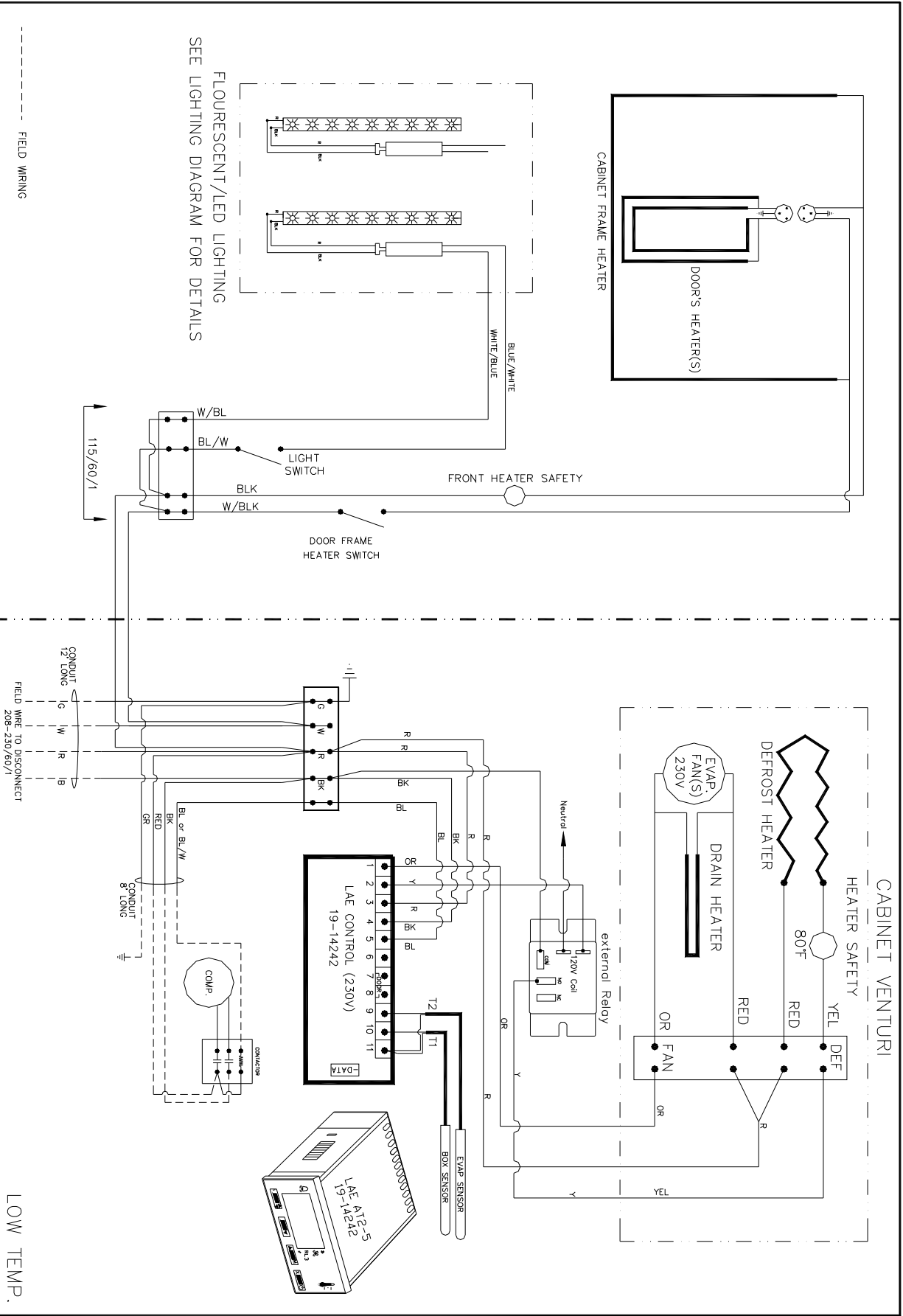

FLUORESCENT/LED LIGHTING
SEE LIGHTING DIAGRAM FOR DETAILS

FIELD WIRING

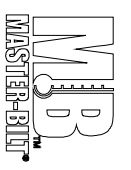

TEL-2SC, TEL-3SC, TEL-4SC, TEL-5SC
WIRING DIAGRAM (LAE_AT2-5 CONTROLLER)

SELF-CONTAIN

7/20/12

LOW TEMP.