



Internal Use Only

<http://biz.lgservice.com>

# Multi Air Conditioner SVC MANUAL(General)

**MODEL : Multi-Inverter Type**

## **CAUTION**

Before Servicing the unit, read the safety precautions in General SVC manual.  
Only for authorized service personnel.

# CONTENTS

<b>Part 1</b>	<b>General Information</b> .....	2
	1. Safety Precautions.....	3
	2. Model Line Up.....	6
	3. Nomenclature.....	7
<b>Part 2</b>	<b>Functions &amp; Controls</b> .....	8
	1. List of Functions & Controls.....	9
	2. Air Flow.....	12
	3. Air Purifying.....	14
	4. Installation Functions.....	15
	5. Reliability.....	18
	6. Convenience Functions & Controls.....	19
<b>Part 3</b>	<b>Control logic</b> .....	24
	1. Compressor.....	25
	2. Step(frequency) control.....	26
	3. Reversing valve operaton.....	27
	4. Discharge pipe control.....	28
	5. Input Current Control.....	29
	6. Outdoor Fan Control.....	30
	7. Defrost Control.....	31
	8. LEV Control.....	32
	9. Oil restoration operation.....	34
	10. Compressor warm-up control logic.....	34
	11. Heat sink control.....	35
<b>Part 4</b>	<b>Test Run</b> .....	36
	1. Check before Test Run.....	37
	2. Test Run Flow chart.....	38
	3. Test Runing.....	39
<b>Part 5</b>	<b>Trouble Shooting Guide</b> .....	40
	1. Self-diagnosis Function.....	41
	2. Pump Down.....	43
	3. Evacuation.....	44
	4. Gas Charging.....	45
	5. Cycle Part.....	46
	6. Electronic Parts.....	47

---



# Part 1 General Information

1. Safety Precautions .....	3
2. Model Line Up .....	6
3. Nomenclature.....	7



## 1. Safety Precautions

To prevent injury to the user or other people and property damage, the following instructions must be followed.







- Incorrect operation due to ignoring instruction will cause harm or damage. The seriousness is classified by the following indications.





 <b>WARNING</b>	This symbol indicates the possibility of death or serious injury.
 <b>CAUTION</b>	This symbol indicates the possibility of injury or damage to properties only.







- Meanings of symbols used in this manual are as shown below.

	<b>Be sure not to do.</b>
	<b>Be sure to follow the instruction.</b>
	<b>Dangerous Voltage</b>





### 1.1 Cautions in Repair





 <b>WARNING</b>	
Be sure to disconnect the power cable plug from the plug socket before disassembling the equipment for a repair. Internal components and circuit boards are at main potential when the equipment is connected to the power cables. This voltage is extremely dangerous and may cause death or severe injury if come in contact with it.	
Do not touch the discharging refrigerant gas during the repair work. The discharging refrigerant gas. The refrigerant gas can cause frostbite.	
Release the refrigerant gas completely at a well-ventilated place first. Otherwise, when the pipe is disconnected, refrigerant gas or refrigerating machine oil discharges and it Can cause injury.	
When the refrigerant gas leaks during work, execute ventilation. If the refrigerant gas touches to a fire, poisonous gas generates. A case of leakage of the refrigerant and the closed room full with gas is dangerous because a shortage of oxygen occurs. Be sure to execute ventilation.	
When removing the front panel or cabinet, execute short-circuit and discharge between high voltage capacitor terminals. If discharge is not executed, an electric shock is caused by high voltage resulted in a death or injury.	
Do not turn the air-conditioner ON or OFF by plugging or unplugging the power plug. There is risk of fire or electrical shock.	

<p>Do not use a defective or underrated circuit breaker. Use the correctly rated breaker and fuse. Otherwise there is a risk of fire or electric shock.</p>	
<p>Install the panel and the cover of control box securely. Otherwise there is risk of fire or electric shock due to dust, water etc.</p>	
<p>Indoor/outdoor wiring connections must be secured tightly and the cable should be routed properly so that there is no force pulling the cable from the connection terminals. Improper or loose connections can cause heat generation or fire.</p>	
<p>Do not touch, operate, or repair the product with wet hands. Holding the plug by hand when taking out. Otherwise there is risk of electric shock or fire.</p>	

 <b>CAUTION</b>	
<p>Do not turn on the breaker under condition that front panel and cabinet are removed.</p>	
<p>Be sure to earth the air conditioner with an earthing conductor connected to the earthing terminal.</p>	
<p>Conduct repair works after checking that the refrigerating cycle section has cooled down sufficiently. Otherwise, working on the unit, the hot refrigerating cycle section can cause burns.</p>	
<p>Do not tilt the unit when removing panels. Otherwise, the water inside the unit can spill and wet floor.</p>	
<p>Do not use the welder in a well-ventilated place. Using the welder in an enclosed room can cause oxygen deficiency.</p>	
<p>Be sure to turn off power switch before connect or disconnect connector, or parts damage may be occurred.</p>	





## 1.2 Inspections after Repair

<b>⚠ WARNING</b>	
Check to see if the power cable plug is not dirty or loose. If the plug is dust or loose it can cause an electrical shock or fire.	
Do not use a joined power cable or extension cable, or share the same power outlet with other electrical appliances. otherwise, it can cause an electrical shock, excessive heat generation or fire.	
Do not insert hands or other objects through the air inlet or outlet while the product is operating. There are sharp and moving parts that could cause personal injury.	
Do not block the inlet or outlet of air flow. It may cause product failure	

<b>⚠ CAUTION</b>	
Check to see if the parts are mounted correctly and wires are connected. Improper installation and connections can cause an electric shock or an injury.	
Check the installation platform or frame has corroded. Corroded installation platform or frame can cause the unit to fall, resulting in injury.	
Be sure to check the earth wire is correctly connected.	
After the work has finished, be sure to do an insulation test to check the resistance is 2[Mohm] or more between the charge section and the non-charge metal section (Earth position). If the resistance value is low, a disaster such as a leak or electric shock is caused at user's side.	
Check the drainage of the indoor unit after the repair. If drainage is faulty the water to enter the room and wet floor.	





## 2. Model Line Up

### 2.1 Indoor units

Category	Type	Chassis	Model names			
			Capacity, kW(kBtu/h Class)			
			2.64 (9)	3.52 (12)	5.28 (18)	
Wall mounted	LIBERO		SB	AMNW09GDBL0 [LMAN096HV]	AMNW12GDBL0 [LMAN126HV]	
			SC			AMNW18GDCL0 [LMAN186HV]
ART COOL			SE	AMNW09GDER1 [LMAN095HVT]	AMNW12GDER1 [LMAN125HVT]	
			S8			AMNW18GD8R1 [LMAN185HVT]
Ceiling cassette			TR		AMNW12GTRA0 [LMCN125HV]	
			TQ			AMNW18GTQA0 [LMCN185HV]
Ceiling concealed duct	Low static pressure (Slim)		B1	AMNW09GB1A0 [LMDN095HV]	AMNW12GB1A0 [LMDN125HV]	
			B2			AMNW18GB2A0 [LMDN185HV]

### 2.2 Outdoor units

#### MULTI F™

Heat pump	A2UW183FA2 [LMU187HV]	A3UW243FA2 [LMU247HV]	A4UW363FA1 [LMU366HV]	A4UW363FA2 [LMU369HV]
No. of connectable indoor units	Max.2	Max.3	Max.4	Max.4
Total capacity index of connectable indoor units	24	33	48	48
Power supply	1Ø, 208~230V, 60Hz			
Chassis				

### 3. Nomenclature

#### 3.1 Indoor Unit(Global)

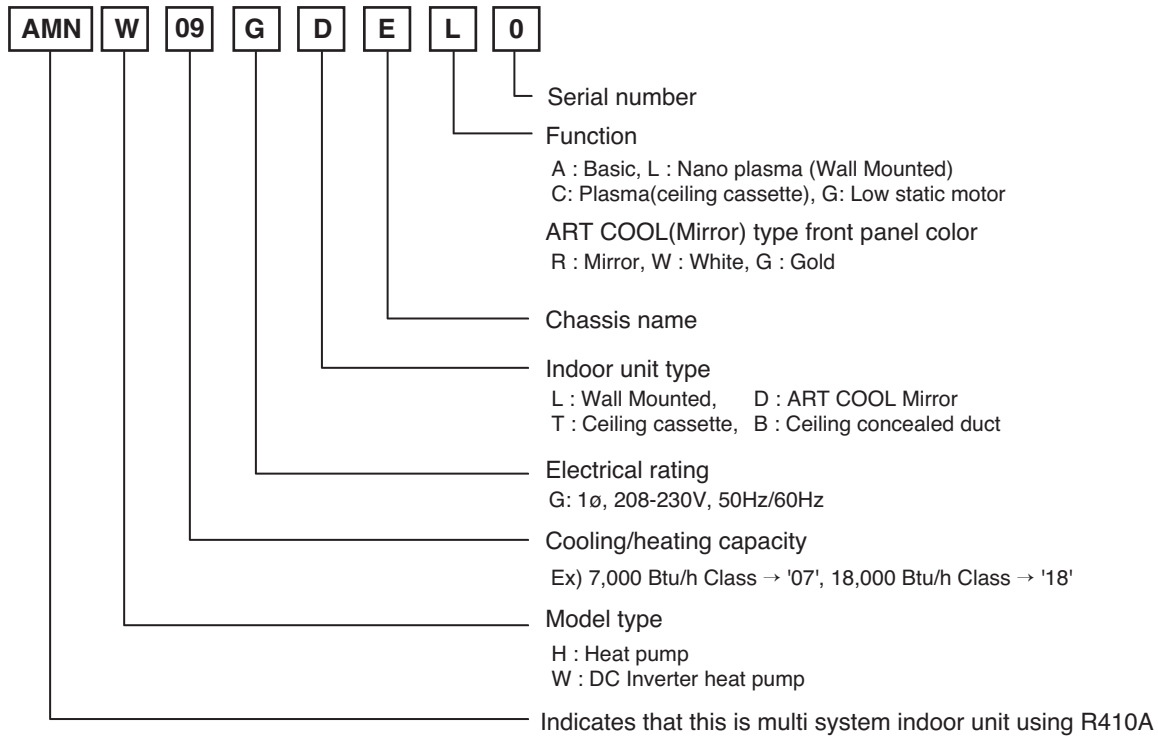

#### 3.2 Outdoor Unit(Global)

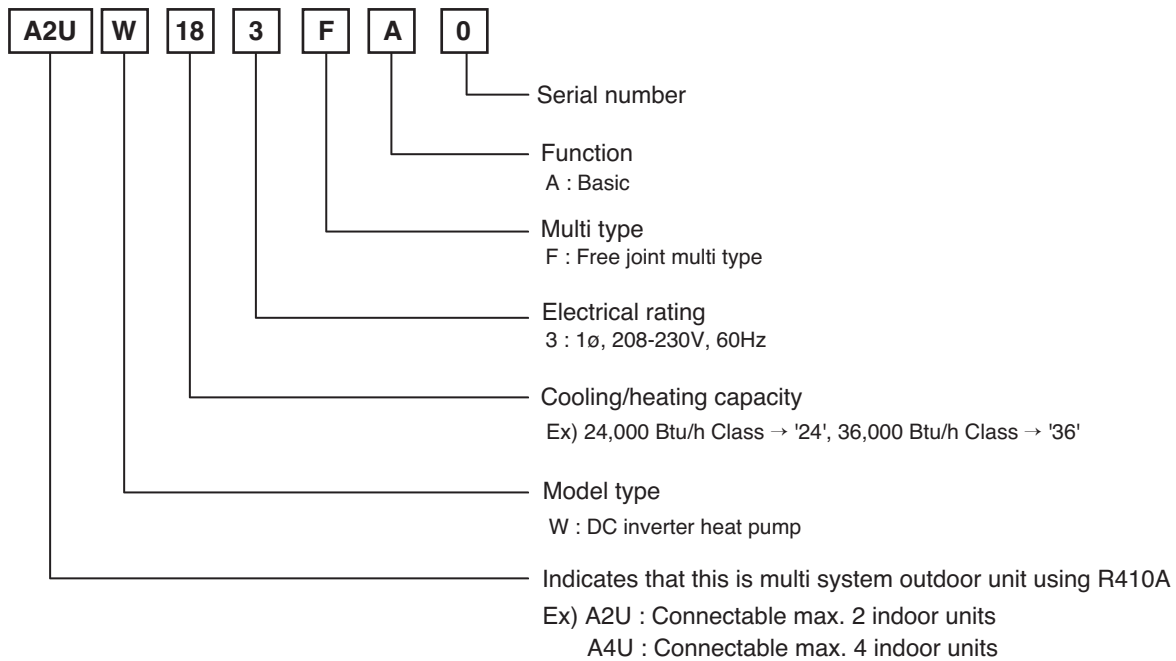

---

# Part 2 Functions & Controls

<b>1. List of Functions &amp; Controls</b> .....	9
<b>2. Air flow</b> .....	12
2.1 Auto swing (left & right) .....	12
2.2 Auto swing (up & down) .....	12
2.3 Chaos swing (up/down).....	12
2.4 Air flow step.....	13
2.5 Chaos wind (auto wind).....	13
2.6 Jet Cool Mode Operation .....	13
2.7 Swirl wind Swing .....	13
<b>3. Air purifying</b> .....	14
3.1 PLASMA Air Purifying System .....	14
<b>4. Installation Functions</b> .....	15
4.1 E.S.P. (External Static Pressure) Setting .....	15
4.2 How to Set E.S.P? .....	16
4.3 High Ceiling operation.....	17
<b>5. Reliability</b> .....	18
5.1 Hot start.....	18
5.2 Self-diagnosis Function.....	18
5.3 Soft dry operation.....	18
<b>6. Convenience Functions &amp; Controls</b> .....	19
6.1 Auto cleaning operation .....	19
6.2 Auto Operation (Fuzzy Operation) .....	20
6.3 Auto restart Opeartion.....	21
6.4 Child Lock Function.....	22
6.5 Forced operation .....	22
6.6 Sleep Timer Operation .....	23
6.7 Timer(On/Off) .....	23
6.8 Defrost Control (Heating) .....	23

## 1. List of Functions & Controls

### 1.1 Description of Functions/Controls

Category	Function	Description	Remark
Airflow	Auto swing (left & right)	Horizontal Airflow Direction control	Optional
	Auto swing (up & down)	Vertical Airflow Direction control	Optional
	Chaos swing (up & down)	Vertical Airflow Direction control	Optional
	Airflow steps (fan/cool/heat)	Indoor Fan speed Control	
	Chaos wind (auto wind)	Indoor Fan speed Control by chaos pattern	Optional
	Jet cool (Power wind)	Powerful cooling mode	
	Swirl wind Swing	Distribute & stir the Air inside.	Optional
Air purifying	Deodorizing filter	Air filtration using Deodorizing filter	
	Plasma air purifier	Air filtration using plasma filter	Optional
	Pre-filter (washable/anti-fungus)	Air filtration using pre-filter	
Installation	Drain pump	Drain water pump	Optional
	E.S.P. control	Changeable External Static Pressure	Optional
	Electric heater (operation)	Electric heater	Optional
	High ceiling operation	Function to Control the Air Volume by Ceiling Height	Optional
Reliability	Hot start	To prevent cold wind blow on heating mode start	
	Self diagnosis	Error code displays	
	Soft dry operation	Dehumidification	
Convenience	Auto changeover	Cooling mode is automatically changed to heating mode and vice verse	Optional
	Auto clean	After cooling operation, this function makes the evaporator dry	Optional
	Auto operation (artificial intelligence)	Air volume & set temp. are automatically selected for comfort on Cooling/Heating mode	Optional
	Auto restart operation	When power returns after a power failure, unit restarts in the previous operating mode	
	Child lock	Protect the unit operation without approval	Optional
	Forced operation	Operation without remote controller	
	Group control	Where several products are linked, one specific control device can control a specific number of products.	Optional
	Sleep mode	Air volume & set temp. are automatically changed for comfortable sleep	
	Timer (on/off)	Operation by Timer setting	
	Timer (weekly)	Operation by weekly reservation	
	Two thermistor control	Option to control temperature by referring thermistor in the Indoor unit or the LCD wired remote.	Optional
Individual control	Standard wired remote controller	Standard wired remote controller	Optional
	Deluxe wired remote controller	Deluxe wired remote controller	Optional
	Simple wired remote controller	Simple wired remote controller	Optional
	Wired remote Controller (for hotel use)	Wired remote controller (for hotel use)	Optional
	Wireless remote controller (simple)	Wireless remote controller (simple)	Optional
	Wireless LCD remote control	Wireless LCD remote control	Optional
CAC network function	General central controller (Non LGAP)	General central controller	Optional
	Dry contact	Dry contact	Optional

Category	Function	Description	Remark
CAC network function	Network Solution (LGAP)	Network Solution (LGAP)	Optional
	PDI (Power Distribution Indicator)	PDI (power distribution indicator)	Optional
	PI 485	Network control using PI 485 (Internet)	Optional
Special function & kit	Zone control	control the operation of the Air conditioning unit where each zone	Optional
	Low ambient operation	For operation at low temp.	
	Space Control	Vanes angle can be controlled by pair.	Optional
	Auto Elevation	Grille is automatically down to clean	Optional
Functions for outdoor	Defrost / Deicing	Condenser frost prevention	
	High pressure switch	Detect high pressure for safety	Optional
	Low pressure switch	Detect low pressure for safety	Optional
	Phase protection	Misconnection prevention for three phase	Optional
	Restart delay (3-minutes)	For overload prevention	Optional
	Self diagnosis	Error code displays	
	Soft start	Soft start for compressor	Optional
	Test function	Test operation	

Notes: The Exploded View part has the particular Function table for each model.

## 1.2 List of functions

Category	Function	Wall Mounted (LIBERO)	ART COOL Mirror	Ceiling Cassette 4-way	Ceiling Concealed Duct (Low static)
Air flow	Air supply outlet	1	1	4	1
	Airflow direction control(left & right)	Auto	Auto	X	-
	Airflow direction control(up & down)	Auto	Auto	Auto	-
	Auto swing(left & right)	O	O	X	-
	Auto swing(up & down)	O	x	O	-
	Airflow steps(fan/cool/heat)	5/6/6	3/4/3	4 / 5 / 4	3 / 3 / 3
	Chaos swing	X	O	X	-
	Chaos wind(auto wind)	O	X	O	X
	Jet cool/heat(Power wind)	O/O	O/X	O/X	O/X
Air purifying	Swirl wind	X	X	O	X
	Deodorizing filter	O	O	X	X
	Allergy free filter	O	X	X	X
	Plasma air purifier	O	O	Option	X
Installation	Prefilter(washable / anti-fungus)	O	O	O	O
	Drain pump	-	-	O	O
	E.S.P. control	-	-	-	O
	Electric heater(operation)	-	-	X	X
Reliability	High ceiling operation	-	-	O	-
	Hot start	O	O	O	O
	Self diagnosis	O	O	O	O
	Soft dry operation	O	O	O	O
Convenience	Auto changeover	X	X	X	X
	Auto cleaning	O	O	X	X
	Auto operation(artificial intelligence)	O	O	O	O
	Auto restart operation	O	O	O	O
	Child lock	O	-	O	O
	Energy-Saving Cooling Mode	O	X	X	X
	Forced operation	O	O	O	X
	Group control	-	-	O	O
	Sleep mode	O	O	O	X
	Timer(on/off)	O	O	O	X
	Timer(weekly)	O	-	O	X
Individual control	Two thermistor control	O	-	O	O
	Wide wired remote controller	Accessory	Accessory	Accessory	Accessory
	Deluxe wired remote controller	X	X	X	X
	Simple wired remote controller	Accessory	Accessory	Accessory	O
	Simple wired remote controller(for hotel use)	Accessory	Accessory	Accessory	Accessory
	Wireless remote controller(simple)	X	X	X	X
CAC network function	Wireless LCD remote control	X	X	X	X
	Wireless LCD remote control(Ez)	O	O	O	Accessory
	General central controller (Non LGAP)	X	X	X	X
	Dry contact	Accessory	Accessory	Accessory	Accessory
	Dry contact(temperature setting)	Accessory	Accessory	Accessory	Accessory
	Central control(LGAP)	O	O	O	O
Special function kit	PDI(power distribution indicator)	Accessory	Accessory	Accessory	Accessory
	PI 485	Accessory	Accessory	Accessory	Accessory
Others	CTIE	X	X	-	X
	Zone control	X	X	-	X
	Thermistor	-	-	-	-

\* Some of functions are slightly different depending upon models, refer individual function table on "PART 2. indoor units".

\*\* For ceiling concealed duct models, auto-run function of dry contact is not applicable.

O : Applied      X : Not applied      - : No relation

Option : Model name & price are different according to options, and assembled in factory with main unit.

Accessory : Installed at field, ordered and purchased separately by the corresponding model name, supplied with separate package.

## 2. Air flow

### 2.1 Auto swing (left & right)

- By the horizontal airflow direction control key input, the left/right louver automatically operates with the auto swing or it is fixed to the desired direction.

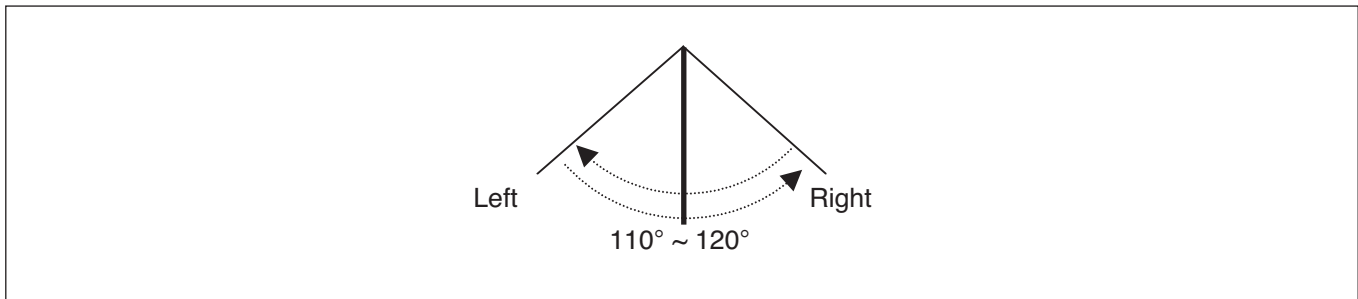

### 2.2 Auto swing (up & down)

- By the auto swing key input, the upper/lower vane automatically operates with the auto swing or it is fixed to the desired direction.

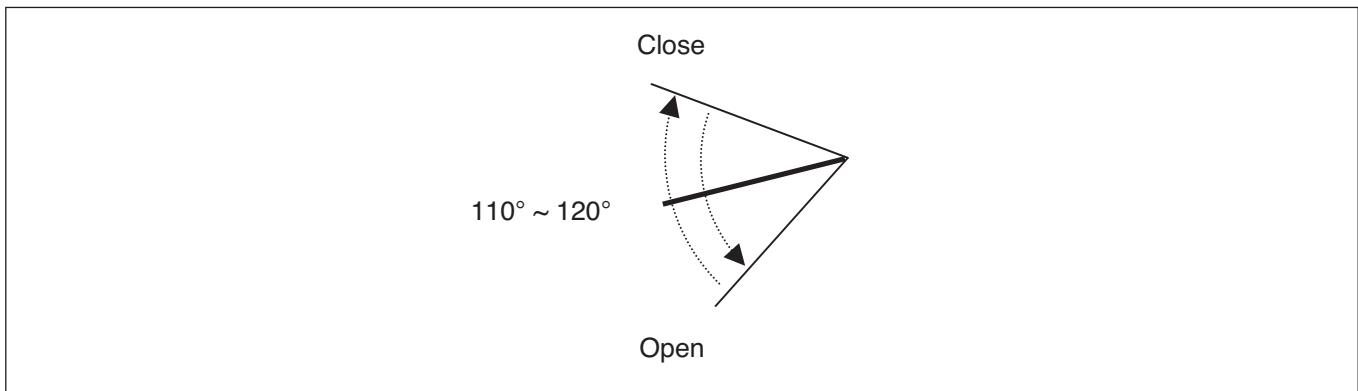

### 2.3 Chaos swing (up/down)

- By the Chaos swing key input, the upper/lower vane automatically operates with the chaos swing or it is fixed to the desired direction.

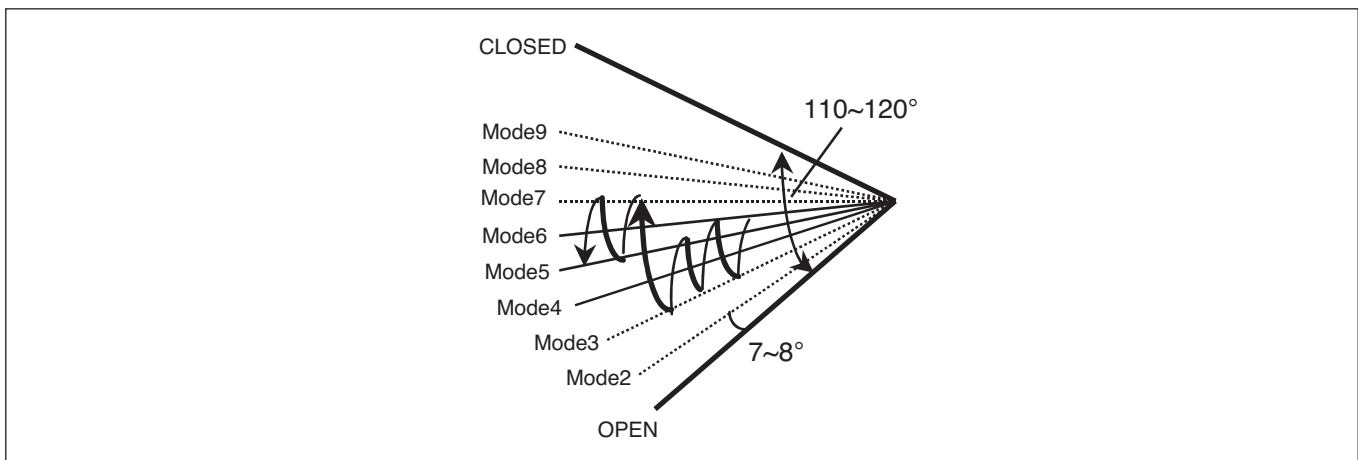

**NOTE:** Some Models are different by swing width and swing pattern.

## 2.4 Air flow step

- Indoor fan motor control have 6 steps.
- Air volume is controlled "SH", "H", "Med", "Low" by remote controller.
- "LL" step is selected automatically in Hot start operation.

Step	Discription
LL	Very low, In heating mode
L	Low
M	Med
H	High
SH	Super high
Auto	Chaos wind

## 2.5 Chaos wind (auto wind)

- When "Auto" step selected and then operated, the high, medium, or low speed of the airflow mode is operated for 2~15 sec. randomly by the Chaos Simulation

## 2.6 Jet Cool Mode Operation

- While in heating mode or Fuzzy operation, the Jet Cool key cannot be input. When it is input while in the other mode operation (cooling, dehumidification, ventilation), the Jet Cool mode is operated.
- In the Jet Cool mode, the indoor fan is operated at super-high speed for 30 min. at cooling mode operation.
- In the Jet Cool mode operation, the room temperature is controlled to the setting temperature, 18°C.
- When the sleep timer mode is input while in the Jet Cool mode operation, the Jet Cool mode has the priority.
- When the Jet Cool key is input, the upper/lower vanes are reset to those of the initial cooling mode and then operated in order that the air outflow could reach further.

## 2.7 Swirl wind Swing

- It is the function for comfort cooling/heating operation.
- The diagonal two louvers are opened the more larger than the other louvers. After one minute, it is opposite.

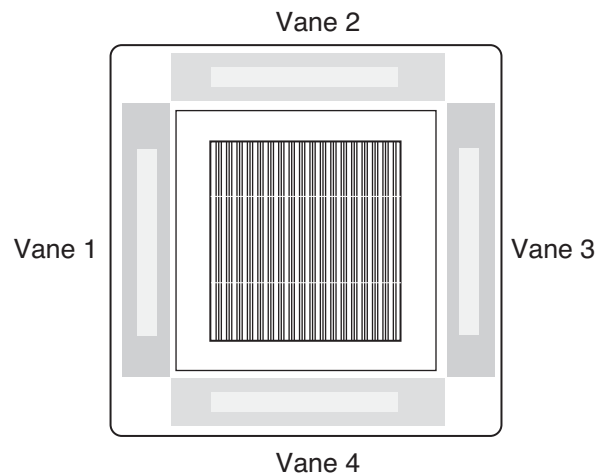

- Comparison of Air Flow Types

4-Open (conventional)

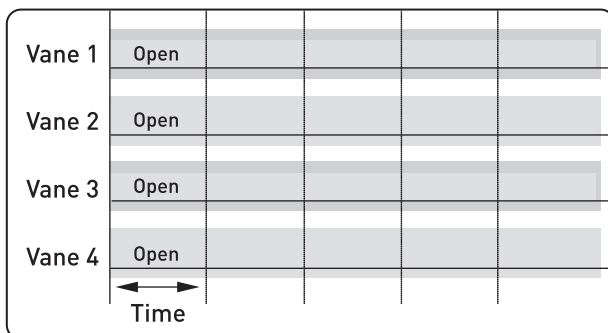

Swirl Swing (New)

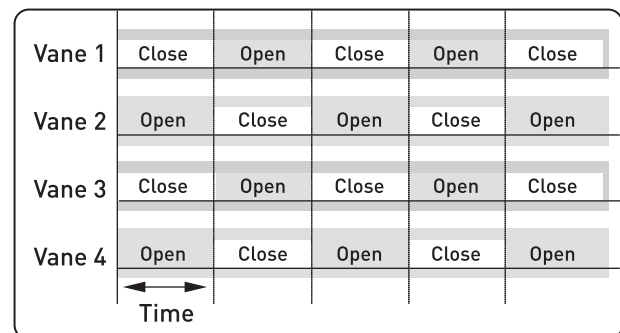

### 3. Air purifying

#### 3.1 PLASMA Air Purifying System

The PLASMA Air Purifying System not only removes microscopic contaminants and dust, but also removes house mites, pollen, and pet fur to help prevent allergic diseases like asthma. This filter that can be used over and over again by simply washing with water.

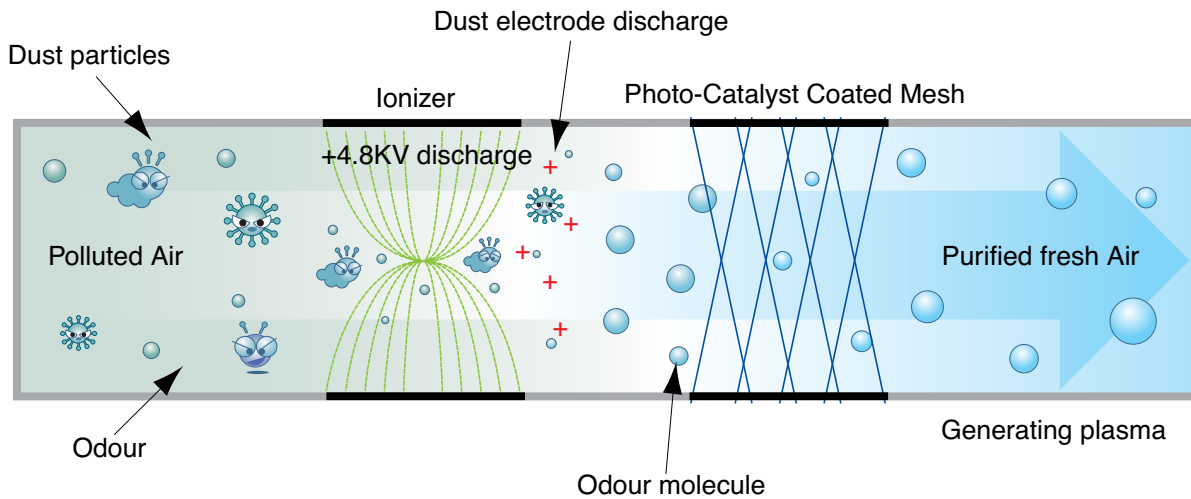

## 4. Installation Functions

### 4.1 External pressure setting for EZ Tuning

 EZ Tuning (E.S.P. Control) provide required constant air flow rate irrespective of E.S.P. charge.

(1) Open the rear cover of the wired remote-controller to set the mode.

(2) Select one of three selectable modes as follows.

#### Group control switch

1. For individual control/Master use
2. For group control/Slave use

#### Ceiling height selection switch

1. Position V-L:
  - Minimum E.S.P. setting & Fan speed is varied according to the state of dampers by micom.
2. Position F-H:
  - Maximum E.S.P. setting & Fan speed doesn't vary according to the opening & closing of dampers.
3. Position V-H:
  - Maximum E.S.P. setting & Fan speed is varied according to the state of dampers by micom.

#### Product selection switch

1. Cooling Only product
2. Heat Pump product

#### Indoor temperature sensor selection switch

1. Use the temperature sensor on the remote controller.
2. Use the temperature sensor on the product.
3. Use the sensors on the product and remote controller.

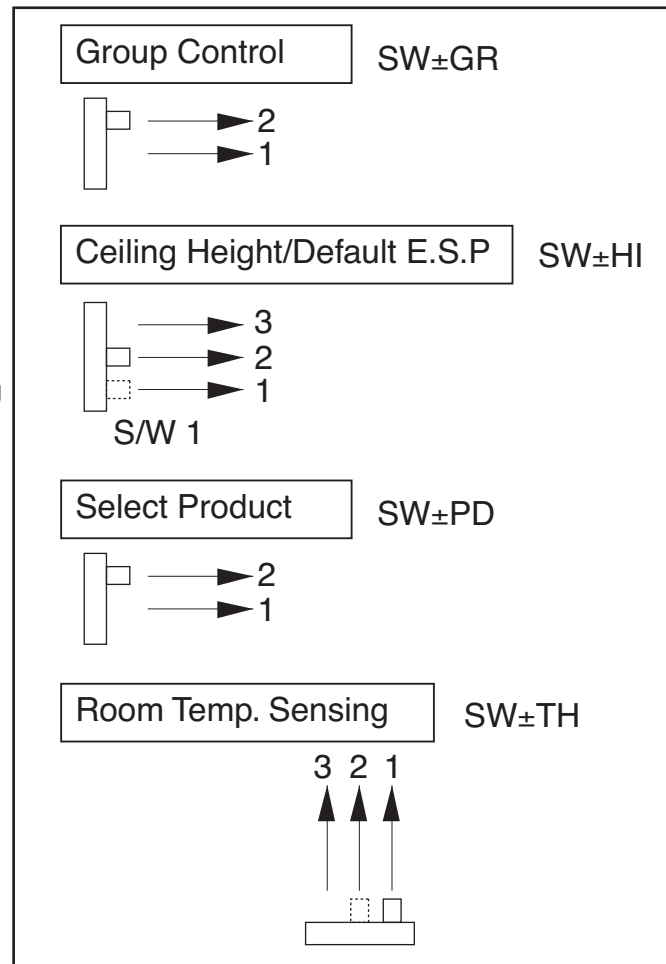

- When changing the product selection switch and group control switch, the power must be reconnected to reflect the changes.
- The central control could operate inappropriately depends on indoor unit type, when the remote controller is set as slave.

## 4.2 How to Set E.S.P?

This Function can be controled with new wired remote controller

### Procedure of RPM change:

Ex) External static pressure is 29Pa for model name "AMNW12GB1A0[LMDN125HV]".

- To protect the unit, compressor is designed to be off during E.S.P. setting.
- E.S.P function is setting the volume of each fan speed.  
It is for the convenience of installation.  
It is recommended that you should not use this function while using the remote controller.

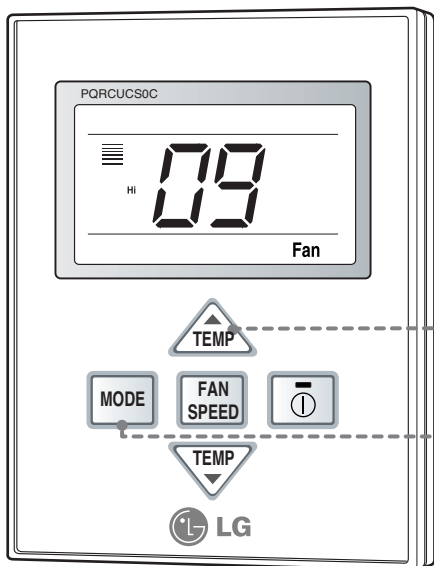

**1** Press the mode button and the temperature increasing button(▲) same time for three seconds.

**2** Set the volume of each fan speed(Low, Medium, Hi) by using the temperature control button. Press the fan speed button to select the fan speed.  
The value of E.S.P can be adjusted from 1 to 255.

**3** If you press the On/Off button while setting the ESP function, it will be canceled. (The picture on the left side is the example of setting the Hi wind to ESP 09.)

**4** Press the mode button and the temperature increasing button (s) same time for three seconds. Then the ESP setting will be activated after the temperature display flashes three times.

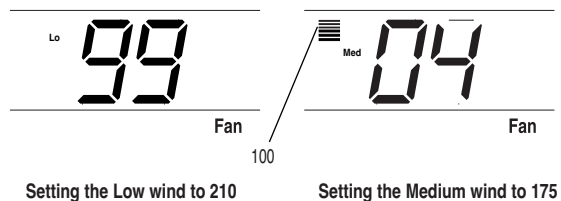

\* The E.S.P value is set at the proper value at the factory.  
So it is highly recommended that you should not change the E.S.P value at your discretion.

**E.S.P. setting value (reference)**

Static pressure(mmAq)		0	1	2	3	4
Model name	Step(Hi/Mid/Lo)	Setting value				
AMNW09GB1A0 [LMDN095HV]	8.5 CMM(300CFM)	75	84	94	104	114
	7.5 CMM(265CFM)	69	77	88	99	110
	6.5 CMM(230CFM)	62	71	83	95	106
AMNW12GB1A0 [LMDN125HV]	9.5 CMM(335CFM)	82	90	99	109	118
	8.5 CMM(300CFM)	75	84	94	104	114
	7.5 CMM(265CFM)	69	77	88	99	110
AMNW18GB2A0 [LMDN185HV]	15 CMM(530CFM)	90	97	105	114	122
	13.5 CMM(477CFM)	82	90	99	109	119
	11.5 CMM(406CFM)	75	84	93	103	114

**[ Notes ]**

1. To get the desired Airflow & E.S.P. combination from the table set the matching value from the table. Value other than that in table will not give the combinations of airflow & E.S.P. which are mentioned in the table.
2. Table data is based at 230V. According to the fluctuation of voltage, air flow rate varies.

**4.3 High Ceiling operation**

Function to Control the Air Volume by Ceiling Height Control of the air intensity has been made possible by employing a height-control algorithm for the interior fan.

According to the height of the installation, it provides variability of indoor fan motor rpm. If the height of installation is low then you can adjust low rpm of indoor fan motor. On the other hand if the height of the installation is high you can adjust high rpm of indoor fan motor. Selection of speed can be done by slide switch at the back of the LCD wired remote.

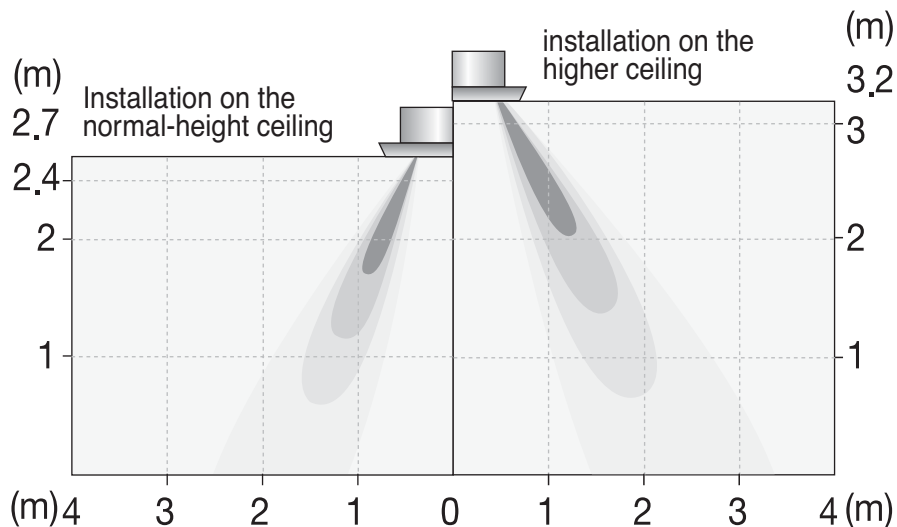

## 5. Reliability

### 5.1 Hot start

- When heating is started, the indoor fan is stopped or very slow to prevent the cold air carry out
- When the temp. of heat exchanger reach 30°C(model by model), indoor fan is started.

### 5.2 Self-diagnosis Function

- The air conditioner installed can self-diagnosed its error status and then transmits the result to the central control. Therefore, a rapid countermeasure against failure of the air conditioner allows easy management and increases the usage life of air conditioner.
- Refer to trouble shooting guide.

### 5.3 Soft dry operation

- When the dehumidification operation input by the remote control is received, the intake air temperature is detected and the setting temp is automatically set according to the intake air temperature.

Intake air Temp.	Setting Temp.
78°F(26°C) ≤ intake air temp.	77°F(25°C)
76°F(24°C) ≤ intake air temp. < 78°F(26°C)	intake air temp. -2°F(-1°C)
72°F(22°C) ≤ intake air temp. < 76°F(24°C)	intake air temp. 1°F(-0.5°C)
64°F(18°C) ≤ intake air temp. < 72°F(22°C)	intake air temp.
intake air temp. < 64°F(18°C)	64°F(18°C)

- While compressor off, the indoor fan repeats low airflow speed and stop.
- While the intake air temp is between compressor on temp. and compressor off temp., 10-min dehumidification operation and 4-min compressor off repeat.

Compressor ON Temp. → Setting Temp+1°F(0.5°C)

Compressor OFF Temp. → Setting Temp-1°F(0.5°C)

- In 10-min dehumidification operation, the indoor fan operates with the low airflow speed.

## 6. Convenience Functions & Controls

### 6.1 Auto cleaning operation

- Function used to perform Self Cleaning to prevent the Unit from Fungus and bad odor.
- Used after the Cooling Operation before turning the unit off, clean the Evaporator and keep it dry for the next operation.
- The function is easy to operate as it is accessed through the Remote controller.

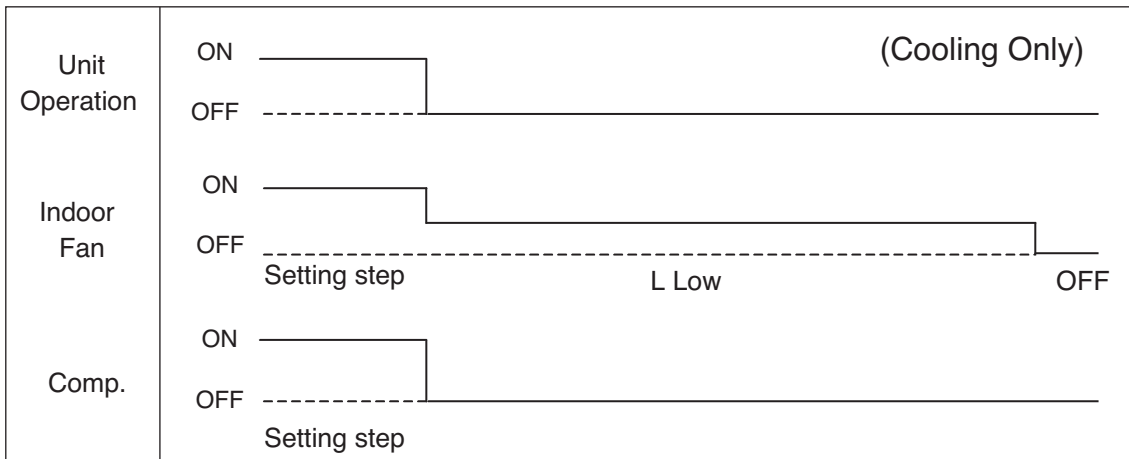
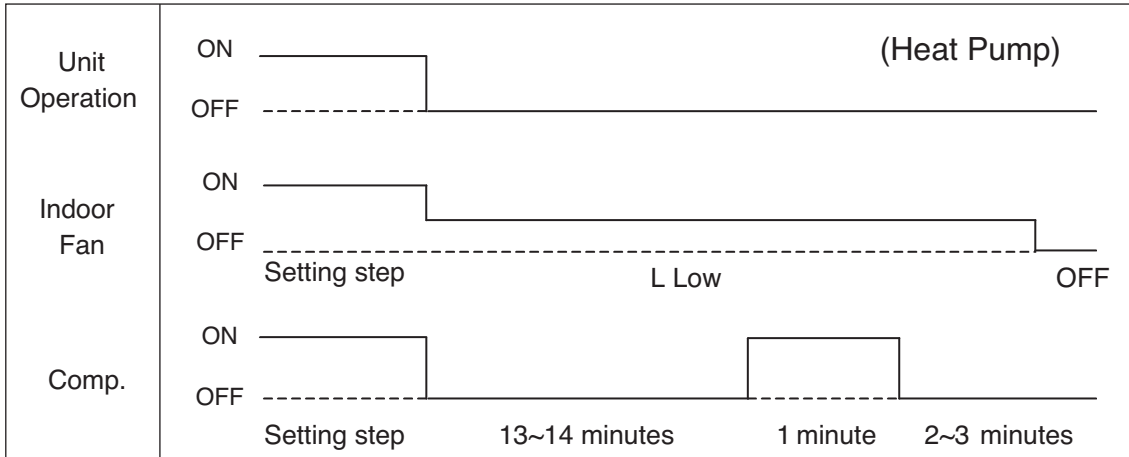

## 6.2 Auto Operation (Fuzzy Operation)

- When any of operation mode is not selected like the moment of the power on or when 3 hrs has passed since the operation off, the operation mode is selected.
- When determining the operation mode, the compressor, the outdoor fan, and the 4 way valve are off and only the indoor fan is operated for 15 seconds. Then an operation mode is selected according to the intake air temp at that moment as follows.  
76°F(24~25°C) ≤ Intake Air Temp → Fuzzy Operation for Cooling  
70°F(21°C) ≤ Intake Air Temp < 76°F(24~25°C) → Fuzzy Operation for Dehumidification  
Intake Air Temp < 70°F(21°C) → Fuzzy Operation for Heating
- If any of the operation modes among cooling / dehumidification / heating mode operations is carried out for 10 sec or longer before Fuzzy operation, the mode before Fuzzy operation is operated.

### 6.2.1 Fuzzy Operation for Cooling

- According to the setting temperature selected by Fuzzy rule, when the intake air temp is 0.5°C or more below the setting temp, the compressor is turned off. When 0.5°C or more above the setting temp, the compressor is turned on.  
Compressor ON Temp → Setting Temp + 1°F(0.5°C)  
Compressor OFF Temp → Setting Temp + 1°F(0.5°C)
- At the beginning of Fuzzy mode operation, the setting temperature is automatically selected according to the intake air temp at that time.  
78°F(26°C) ≤ Intake Air Temp → 76°F(24~25°C)  
76°F(24~25°C) ≤ Intake Air Temp < 78°F(26°C) → Intake Air Temp + 2°F(1°C)  
72°F(22°C) ≤ Intake Air Temp < 76°F(24~25°C) → Intake Air Temp + 1°F(0.5°C)  
64°F(18°C) ≤ Intake Air Temp < 72°F(22°C) → Intake Air Temp  
Intake Air Temp < 64°F(18°C) → 64°F(18°C)
- When the Fuzzy key (Temperature Control key) is input after the initial setting temperature is selected, the Fuzzy key value and the intake air temperature at that time are compared to select the setting temperature automatically according to the Fuzzy rule.
- While in Fuzzy operation, the airflow speed of the indoor fan is automatically selected according to the temperature.

### 6.2.2 Fuzzy Operation for Dehumidification

- According to the setting temperature selected by Fuzzy rule, when the intake air temp is 1°F(0.5°C) or more below the setting temp, the compressor is turned off. When 1°F(0.5°C) or more above the setting temp, the compressor is turned on.  
Compressor ON Temp → Setting Temp + 1°F(0.5°C)  
Compressor OFF Temp → Setting Temp + 1°F(0.5°C)
- At the beginning of Fuzzy mode operation, the setting temperature is automatically selected according to the intake air temp at that time.  
78°F(26°C) ≤ Intake Air Temp → 76°F(24~25°C)  
76°F(24~25°C) ≤ Intake Air Temp < 78°F(26°C) → Intake Air Temp + 2°F(1°C)  
72°F(22°C) ≤ Intake Air Temp < 76°F(24~25°C) → Intake Air Temp + 1°F(0.5°C)  
64°F(18°C) ≤ Intake Air Temp < 72°F(22°C) → Intake Air Temp  
Intake Air Temp < 64°F(18°C) → 64°F(18°C)
- When the Fuzzy key (Temperature Control key) is input after the initial setting temperature is selected, the Fuzzy key value and the intake air temperature at that time are compared to select the setting temperature automatically according to the Fuzzy rule.
- While in Fuzzy operation, the airflow speed of the indoor fan repeats the low airflow speed or pause as in dehumidification operation.

### 6.2.3 Fuzzy Operation for Heating

- According to the setting temperature selected by Fuzzy rule, when the intake air temp is 3.5°F(3°C) or more above the setting temp, the compressor is turned off. When below the setting temp, the compressor is turned on.  
Compressor ON Temp → Setting Temp  
Compressor OFF Temp → Setting Temp + 3.5°F(3°C)
- At the beginning of Fuzzy mode operation, the setting temperature is automatically selected according to the intake air temp at that time.  
68°F(20°C) ≤ Intake Air Temp → Intake Air Temp + 1°F(0.5°C)  
Intake Air Temp < 68°F(20°C) → 68°F(20°C)
- When the Fuzzy key (Temperature Control key) is input after the initial setting temperature is selected, the Fuzzy key value and the intake air temperature at that time are compared to select the setting temperature automatically according to the Fuzzy rule.
- While in Fuzzy operation, the airflow speed of the indoor fan is set to the high or the medium according to the intake air temperature and the setting temperature.

**Notes:** The Temp. of Comp. Turn ON and OFF is different in heating mode and fuzzy operation for heating. Please, refer page 11

### 6.3 Auto restart Operation

- Whenever there is electricity failure to the unit, and after resumption of the power, unit will start in the same mode prior to the power failure. Memorized condition are on / off condition, operating mode (cooling/ heating), set temperature and fan speed. The unit will memorize the above conditions and start with same memorized condition.

## 6.4 Child Lock Function

This is a function to prevent tampering of settings by children or others.

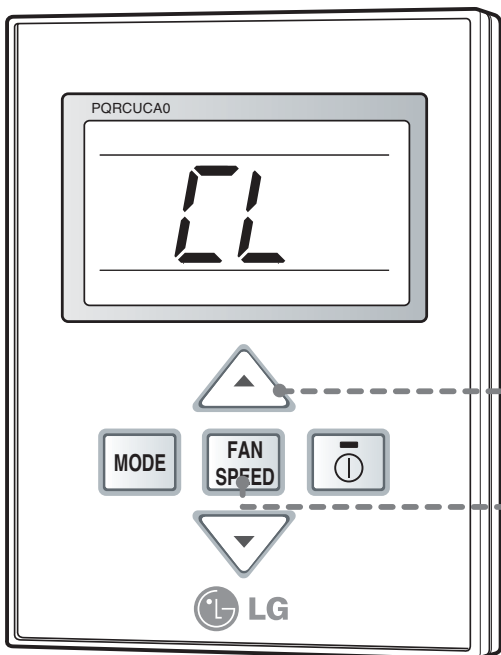

**1** You can use the child lock function by pressing both temperature increasing button and fan speed button for three seconds. In the initial setting of the child lock function, "CL" will be displayed on the display panel and then it will come back to the original mode. Now a click of another button will not be recognized and the "CL" is being shown on the display panel for three seconds due to child lock.

**2** If you want to cancel the child lock mode, press the temperature increasing button and the fan speed button again for three seconds.

## 6.5 Forced operation

- To operate the appliance by force in case when the remote control is lost, the forced operation selection switch is on the main unit of the appliance, and operate the appliance in the standard conditions.
- The operating condition is set according to the outdoor temp. and intake air temperature as follows.

Indoor temp.	Operating Mode	Setting temp.	Setting speed of indoor fan
over 76°F(24~25°C)	Cooling	72°F(22°C)	High speed
70~76°F(21~24°C)	Healthy Dehumidification	72°F(22°C)	
below 70°F(21°C)	Heating	72°F(22°C)	

- The unit select the last operation mode in 3 hours.
- Operating procedures when the remote control can't be used is as follows :
  - The operation will be started if the ON/OFF button is pressed.
  - If you want to stop operation, re-press the button.

## 6.6 Sleep Timer Operation

- When the sleep time is reached after <1,2,3,4,5,6,7,0(cancel) hr> is input by the remote control while in appliance operation, the operation of the appliance stops.
- While the appliance is on pause, the sleep timer mode cannot be input.
- While in cooling mode operation, 30 min later since the start of the sleep timer, the setting temperature increases by 1°C. After another 30 min elapse, it increases by 1°C again.
- When the sleep timer mode is input while in cooling cycle mode, the airflow speed of the indoor fan is set to the low.
- When the sleep timer mode is input while in heating cycle mode, the airflow speed of the indoor fan is set to the medium.

## 6.7 Timer(On/Off)

### 6.7.1 On-Timer Operation

- When the set time is reached after the time is input by the remote control, the appliance starts to operate.
- The timer LED is on when the on-timer is input. It is off when the time set by the timer is reached.
- If the appliance is operating at the time set by the timer, the operation continues.  
While in Fuzzy operation, the airflow speed of the indoor fan is automatically selected according to the temperature.

### 6.7.2 Off-Timer Operation

- When the set time is reached after the time is input by the remote control, the appliance stops operating.
- The timer LED is on when the off-timer is input. It is off when the time set by the timer is reached.
- If the appliance is on pause at the time set by the timer, the pause continues.

## 6.8 Defrost Control (Heating)

- Defrost operation is controlled by timer and sensing temperature of outdoor pipe.
- The first defrost starts only when the outdoor pipe temperature falls below -6°C after starting of heating operation and more than 4 minutes operation of compressor.
- Defrost ends after 12 minutes passed from starting of defrost operation when the outdoor rises over 15°C even before 12 minutes.
- The second defrost starts only when the outdoor pipe temperature falls below - 6°C after from ending of the first defrost and more than 4 minutes operation of compressor.

---

## 3. Control logic

1. Compressor .....	25
2. Step(frequency) control .....	26
3. Reversing valve operaton.....	27
4. Discharge pipe control.....	28
5. Input Current Control .....	29
6. Outdoor Fan Control .....	30
7. Defrost Control .....	31
8. LEV Control.....	32
9. Oil restoration operation.....	34
10. Compressor warm-up control logic.....	34
11. Heat sink control.....	35

## 1. Compressor

Basic principle is to control the rpm of the motor by changing the working frequency of the compressor. Three phase voltage is supplied to the motor and the time for which the voltage will supplied is controlled by IPM (intelligent power module).

Switching speed of IPM defines the variable frequency input to the motor.

$$\text{RPM} = \frac{120 f}{P}$$

RPM → Revolutions/Minute

F → Frequency

P → Number of poles

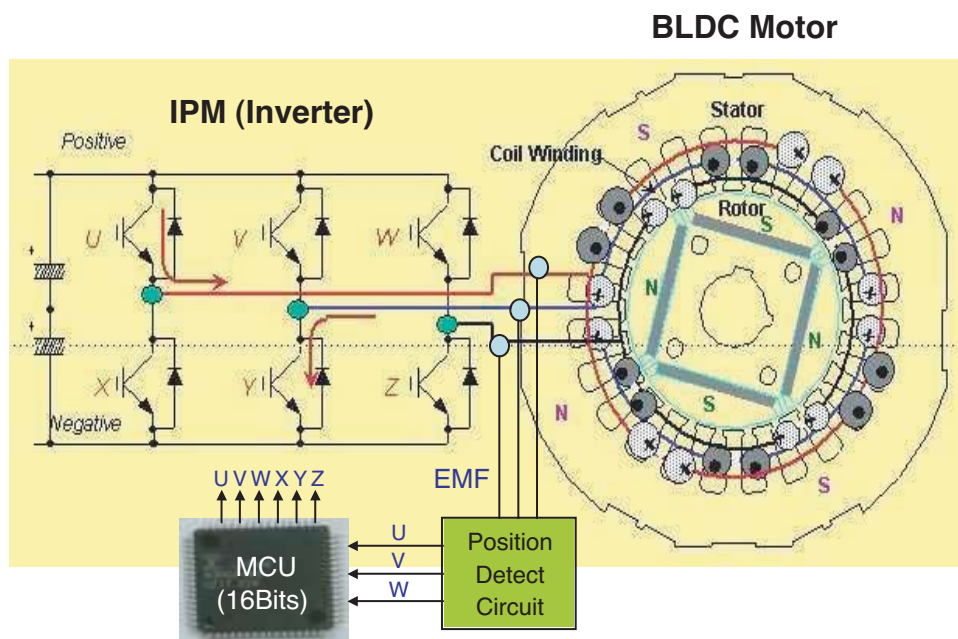

## 2. Step(frequency) control

### 2.1 Frequency control

Frequency that corresponds to each rooms capacity will be determined according to the difference in the temperature of each room and the temperature set by the remote controller.

There are various factors determining the frequency.

1. Indoor unit capacity value.
2. Temperature compensation factor
3. Initial frequency setting

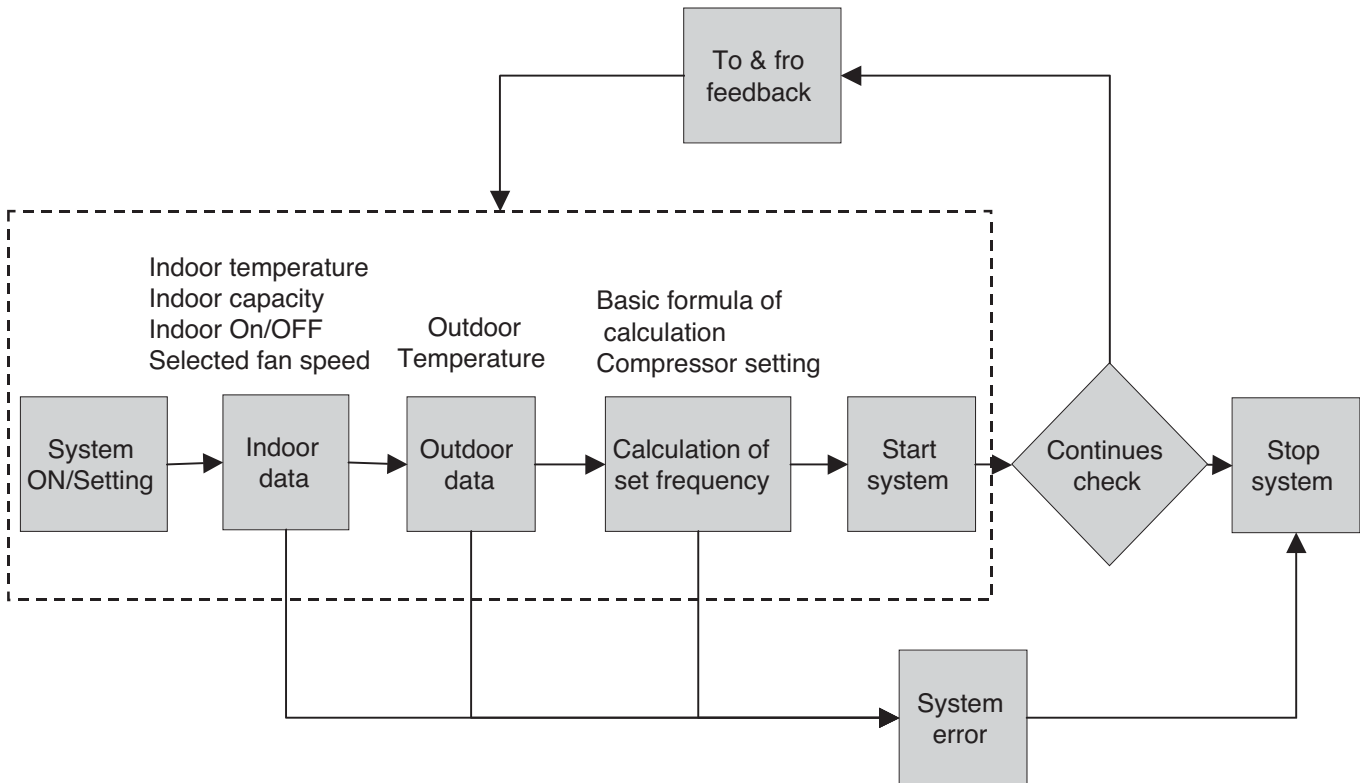

### 2.2 Primary step setting

: Capacity steps of compressor are decided by  $\sum Q_j$  (Summation of capacity code), TAO(Outdoor temp.), TAI(Indoor temp.), DTAI (Step Compensation of temperature difference Indoor Temp. and Setting Temp).

$$\text{Comp Step} = (\text{Step base} + \text{Long piping compensation}) \times \Delta\text{Step TAO} \times \Delta\text{Step TAI} \times \Delta\text{Step DTAI}$$

Step base	Standard frequency step by $\sum Q_j$ (Summation of capacity code)
Long piping	Comp. Step compensation by setting long piping
$\Delta\text{Step TAO}$	step compensation by TAO (Outdoor temp.)
$\Delta\text{Step TAI}$	step compensation by TAI (Indoor temp.)
$\Delta\text{Step DTAI}$	Step Compensation of temperature difference Indoor Temp. and Setting Temp.

\* Target frequency step (Step base) exceeds maximum step, the Step base value follows the maximum step value.

\* The compressor get the minimum step in case Step base value is lower than the minimum step of operating capacity.

### 3. Reversing valve operation

1. At the starting (outdoor is powered on, indoor is not) reversing valve continues OFF (cooling).
2. For the cooling and defrosting operation :valve OFF, for the heating operation :valve ON
3. Method of changing mode from heating to defrosting : As defrosting starts Inverter compressor Hz is lowered to 30Hz for 5 sec and the valve is OFF for the defrost mode. (refer “working process of each component in defrosting and returning to heating mode ”)
- 4 . Method of changing mode from defrosting to heating : As the defrosting is finished inverter compressor frequency is lowered to 30Hz for 10 sec. And the valve is ON for the heating mode.
5. If the operating mode is changed to heating from cooling, “3 min. restarting rule” is applied, and reversing valve position is changed within 30 sec. after compressor turns OFF.
6. If the compressor is stopped during heating mode by remote controller operation or error mode, reversing valve position is changed to OFF in 30 sec. after compressor turns OFF.
7. If the compressor is stopped during heating mode by Thermistor signal, reversing valve will remain in heating position.

## 4. Discharge pipe control

- 1) There can be two situations
  - a) Sensor is failed (error code for sensor failure will be generated)
  - b) Abnormal high temperature discharge temperature (error code for high discharge will be generated)
 Both cases unit will stop.

**Compressor working**

- 1. If discharge pipe temperature < T1 No limitation on compressor frequency
- 2.  $T2 \leq$  discharge pipe temperature < Toff (Hysteresis control) Compressor frequency down by 5 pulse & Expansion valve up by 10 pulse in every 1 min. If LEV is in the starting control it will follow starting control first.
- 3. discharge pipe temperature  $\geq$  Toff then compressor will be OFF System will stop if this situation occurs 5 times in 1 hour and error code will be generated also self diagnosis will start.

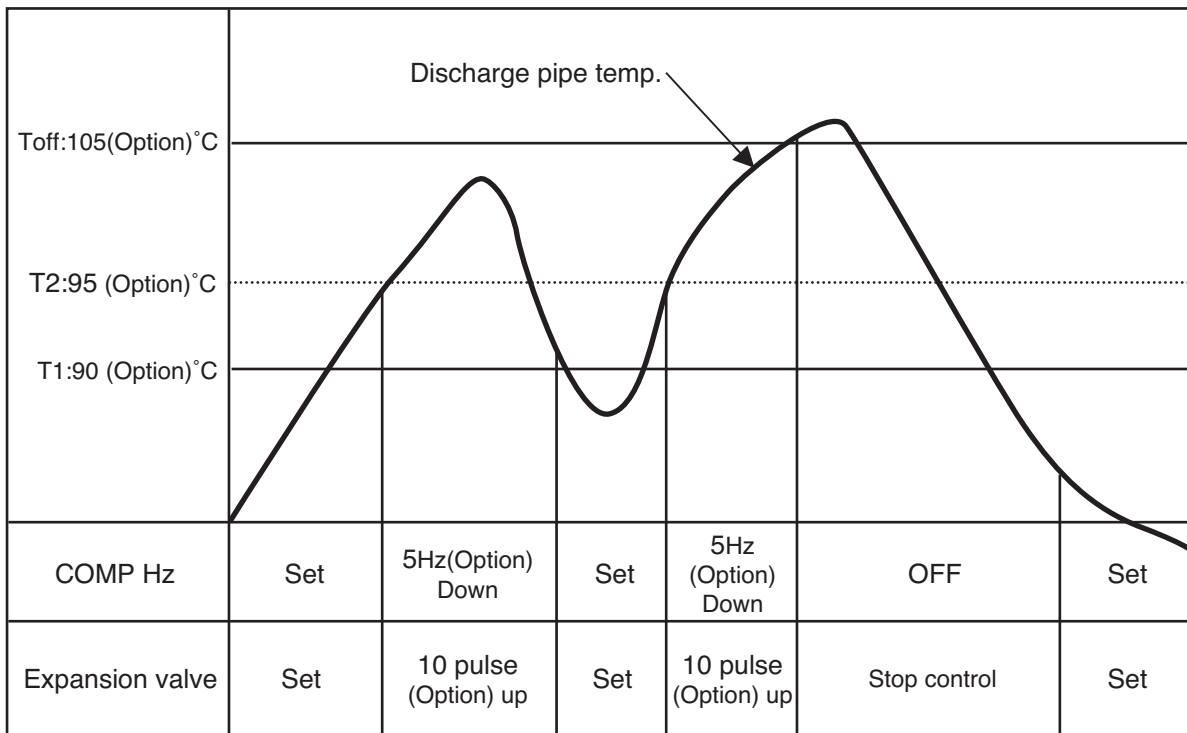

## 5. Input Current Control

### 5.1 Function

Controlling total current to protect power semiconductor devices from burn-out by the low current (including connecting mistake) and over current.

#### Operating process

1. Detection : check the output DC voltage of Current Transformer(CT).

### 5.2 Operating process

#### CT 1 detection :

- 1) If total current exceeds CT1+1 value, reduce inverter operation by 1 step.
  - Step down 5Hz(Optional) from current step.
  - If new Hz is below minimum Hz of operation (cooling & heating), then turn off the compressor.
- 2) After step down, still if the total current exceed CT1 for more than 5 sec. then step down inverter operation by 1 more step.
- 3) If the current continue below CT1 for more than 1 min., return the to setting step Hz.

#### CT 2 detection :

- 1) If total current exceeds CT2 turn off compressor. And after 3 min turn on the compressor and check the current again.
- 2) If CT2 occurs 5 times in 1 hour, stop the operation and shows Self-Diagnosis Error Mode 22

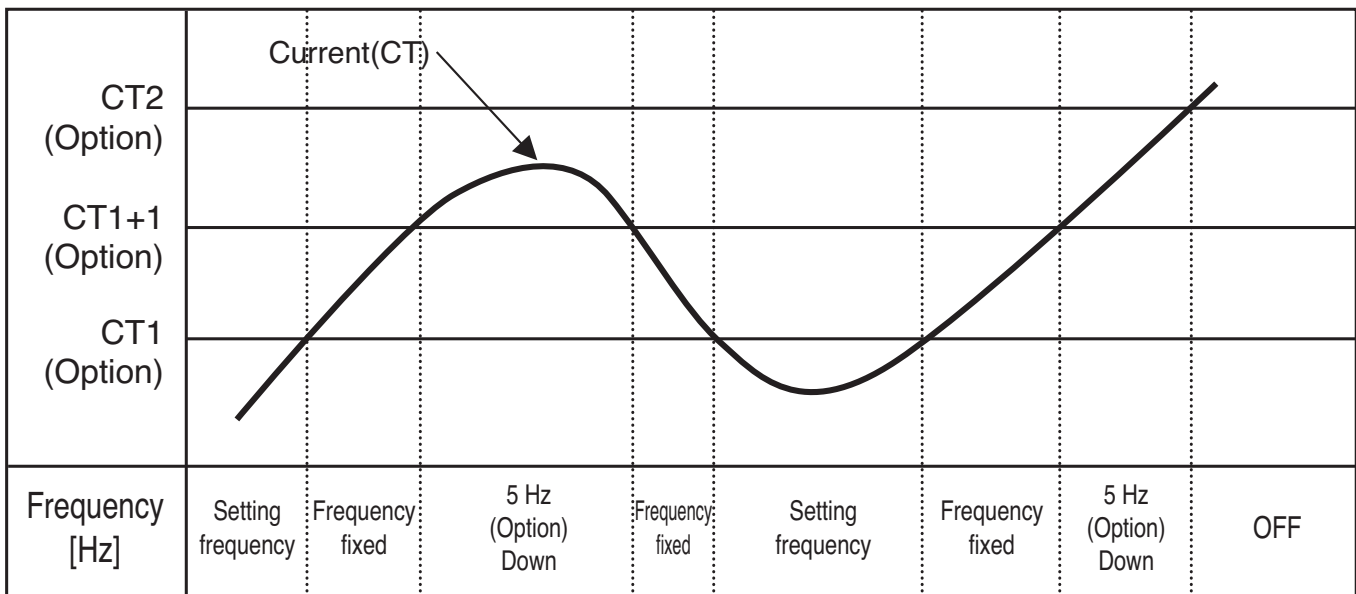

## 6. Outdoor Fan Control

### 6.1 Function

Working of outdoor fan are different in different models. Some models are single fan some are two fan type.

### 6.2 Operating process

Control logic of outdoor fan depends on outdoor temperature

#### 1. AC motor fan control

##### COOLING

FAN1	OUTDOOR TEMP.	FAN2
Step_Fan + 1	41°C	Step_Fan + 2
	38°C	Step_Fan + 1
Step_Fan	28°C	Step_Fan
Step_Fan - 1	22°C	Step_Fan - 1
	10°C	Step_Fan - 2
		Step_Fan - 3

##### HEATING

FAN1	OUTDOOR TEMP.	FAN2
Step_Fan - 1	20°C	Step_Fan - 2
	14°C	Step_Fan - 1
Step_Fan	4°C	Step_Fan
Step_Fan + 1	-3°C	Step_Fan + 1
		Step_Fan + 2

#### 2. DC motor fan control

##### COOLING

OUTDOOR TEMP.	FAN
45°C	3
41°C	2
38°C	1
28°C	0
24°C	-2
18°C	-4
14°C	-6
9°C	-7
2°C	-8
-3°C	-9
	-11

##### HEATING

OUTDOOR TEMP.	FAN
26°C	-6
22°C	-4
18°C	-3
14°C	-2
10°C	-1
4°C	0
0°C	1
-4°C	2
-8°C	3
	4

# 7. Defrost Control

## 7.1 Function

:These are about the control of compressor, fan of outdoor unit, reversing valve, LEV.

## 7.2 Starting to the defrosting operation

- A) Defrost operation will be start when all the conditions below are matched simultaneously  
 Accumulation time of operation and the period after completion of defrost = 35min (Outdoor air temperature  $-3^{\circ}\text{C}$ )
- B) Outdoor piping temperature is below than  $-6$  (Option) $^{\circ}\text{C}$  for starting defrosting operation.

## 7.3 Completion of defrost operation

Send signal of defrost completion in case of meeting one of the condition as below.

- 1. Defrosting time 7 minutes
- 2. Piping temperature maintain 10 seconds (Option ) in condition of more than  $15^{\circ}\text{C}$  (Option).

## 7.4 Defrosting Control Algorithm

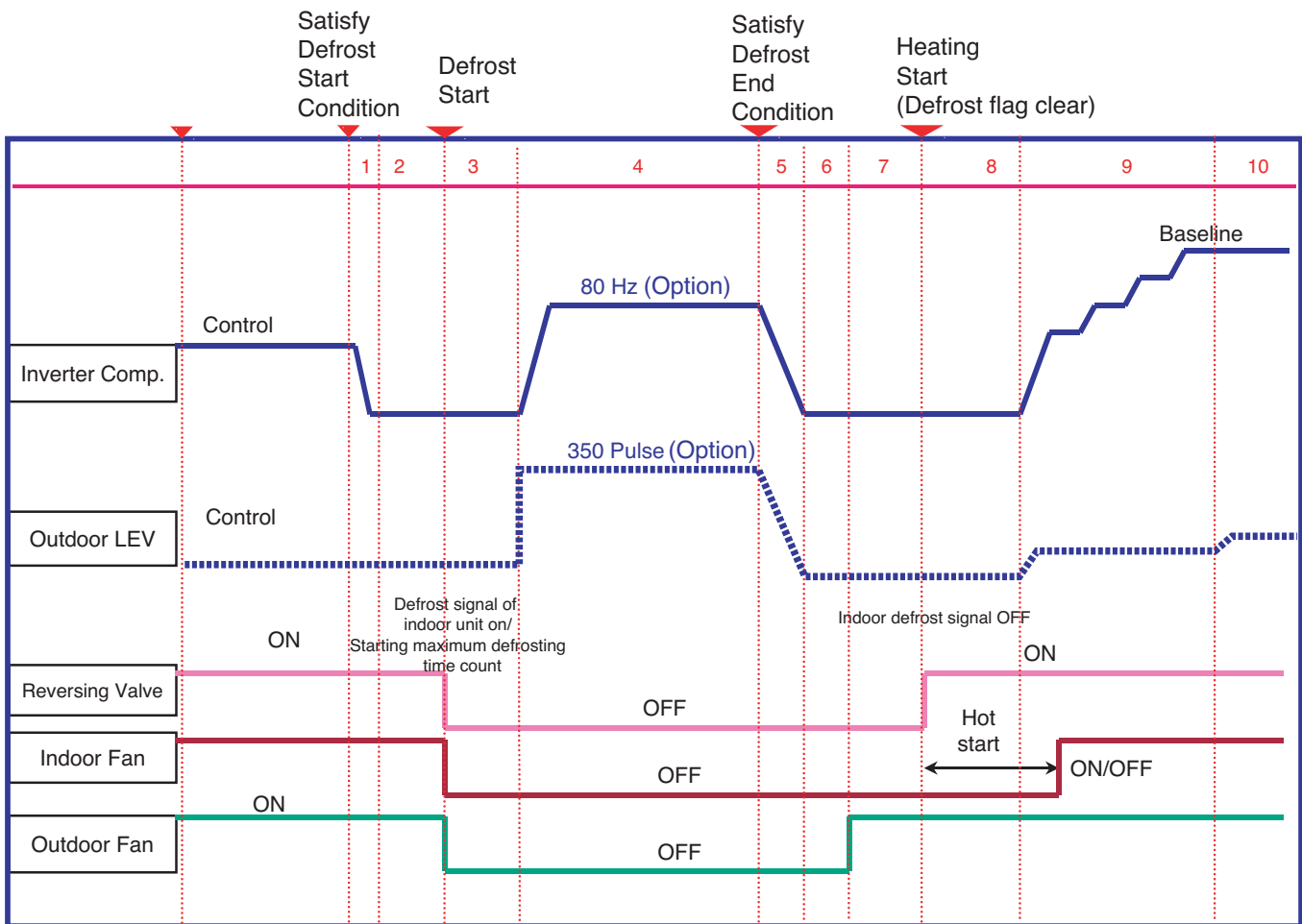

## 8. LEV Control

### 8.1 Control of LEV opening

1. LEV openings have a controllable ranges 70 (option) to 460 (option) pulse in both condition of cooling and heating.
2. Products do not be operated before initializing of LEV when starting.
3. Time constant control period of LEV is every 2 minutes except below conditions.
  - Control LEV every 1 minutes for 10 minutes after starting.
  - When indoor capacity changed, Control LEV every 1 minutes for 10 minutes after starting
  - Control LEV every 1 minutes for 10 minutes after starting in case of the special situation such as defrost completion, oil recovery, oil equalizing control, oil supplying, current transformer limitation, limitation of discharge temperature, low ambient operation control.

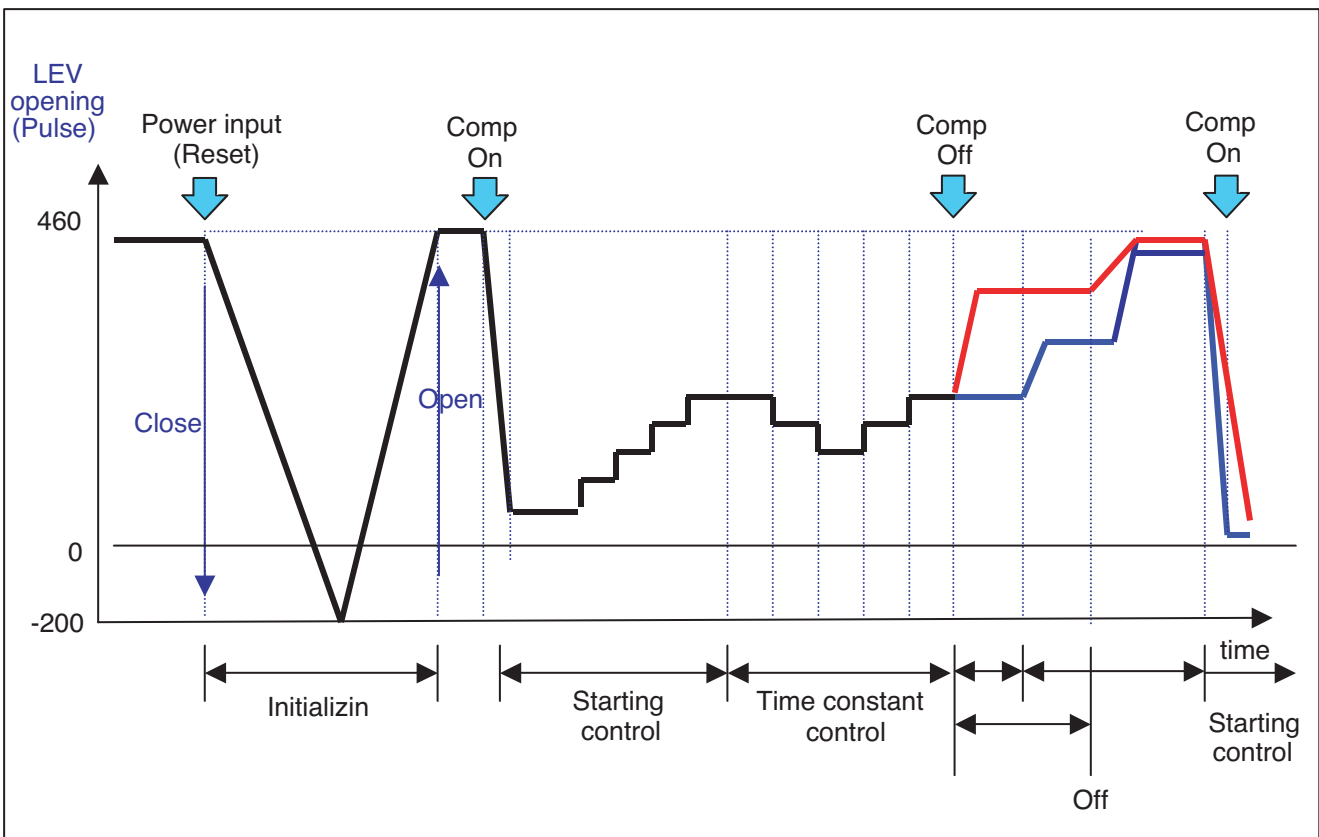

- Heating and cooling
- Heating
- Cooling

## 8.2 Starting control

- 1) Only 1 LEV will be operate as below and others are closed fully.
- 2) Starting control does not use the time when the system operate with partial load after (example) after finishing starting control for 1 indoor unit, another indoor unit is ON additionally is operated with target opening of LEV.
- 3) The indoor units which are in the middle of starting control are continuing starting control with the opening of its opening.
- 4) Urgent control by indoor piping temperature
  1. LEV open 4 pulse with every 10 sec when the indoor piping temperature is below 2°C
  2. When the temperature reaches 4°C, system return to the starting control pulse value.

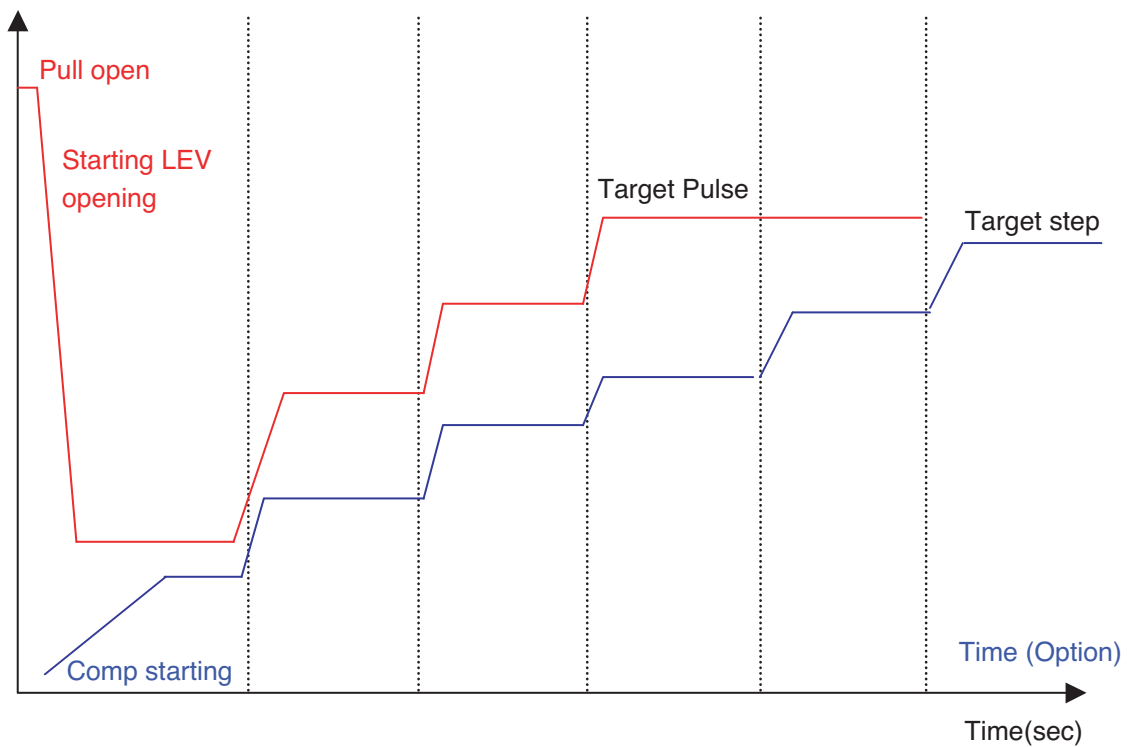

## 9. Oil restoration operation

- 1) When the accumulated compressor running time is over 3 hr.(option), oil restoring operation is made for 3 minutes. If it's on the way of compressor starting, it's made after the starting.
- 2) Accumulated running time is cleared after the defrosting and oil restoring operation.

### Operating process :

- 1) Fully open all the indoor's LEV.
- 2) After the LEV opening, change the compressor step to 70 Hz(option)
- 3) Reversing valve will be same as in defrosting process.
- 4) Outdoor fan operates in low speed.
- 5) During this operation, if operating frequency should be changed by safety control. then follow safety control first. If compressor should be OFF by that, stop operation.
- 6) The LEV openings after this operation is 120% of the opening at the point of starting.

## 10. Compressor warm-up control logic (at low temperatures)

A function protecting inverter compressor from damages, by increasing oil viscosity in low outdoor temperature. For the control, compressor operates in low frequencies.

Operating condition :in case of the following 3 conditions are fulfilled at the same time

- Outdoor temperature ,D-pipe temperature, Heat sink temperature: below 0°C

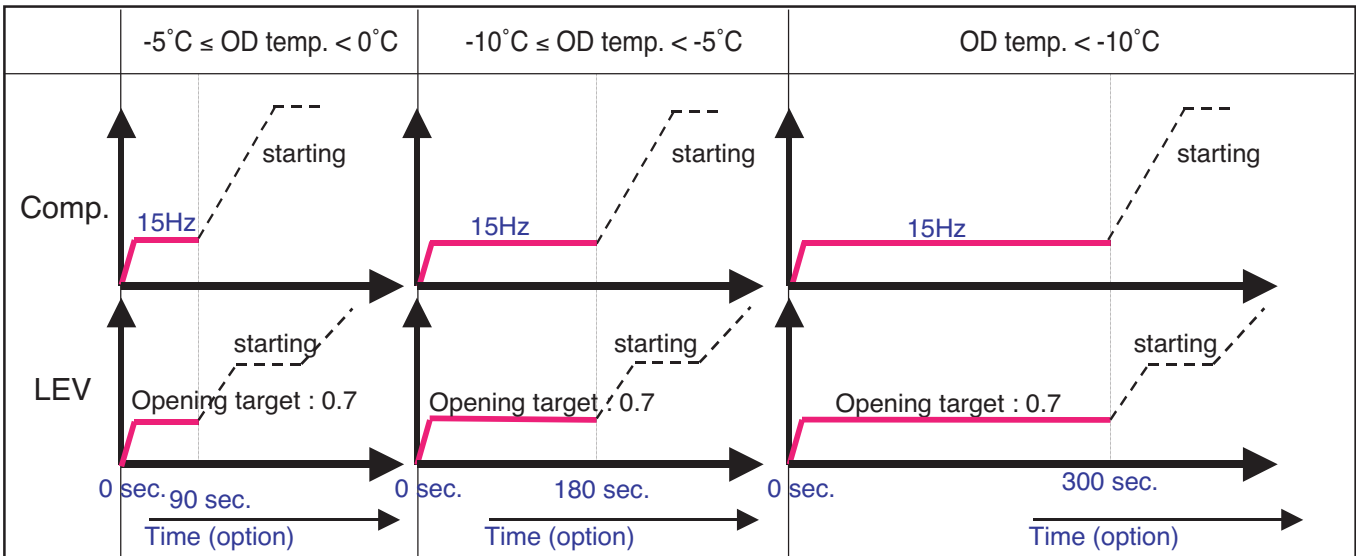

## 11. Heat sink control

### 11.1 Function

: Power module failure protection by checking the temperature of heat sink.  
There is a temperature sensor for checking the heat sink temperature.

### 11.2 Heat sink sensor failure error

Short Check : if temperature  $\geq 130^{\circ}\text{C}$

Open Check : if temperature  $< -30^{\circ}\text{C}$

System will go in self diagnosis (error 65) is displayed and product stops.

### 11.3 Heat sink temperature control

a) Heat sink temperature  $< T_2$  : No limitation on compressor frequency

b)  $T_2 \leq$  heat sink temperature  $< T_{\text{off}}$  : Compressor frequency down by 5 Hz

c) Heat sink temperature  $\geq T_{\text{off}}$  : Compressor will be off.

System will stop if this situation occurs 5 times in 1 hour and error code will be generated also self diagnosis will start.  
If high temperature situation occurs 5 times in 1 hr system counts 1 error and after that 4 times if this situation occurs system stops and give error code.

If the temperature reached  $T_{\text{off}}$  condition system will count 5 times after that and system will stop with error code.

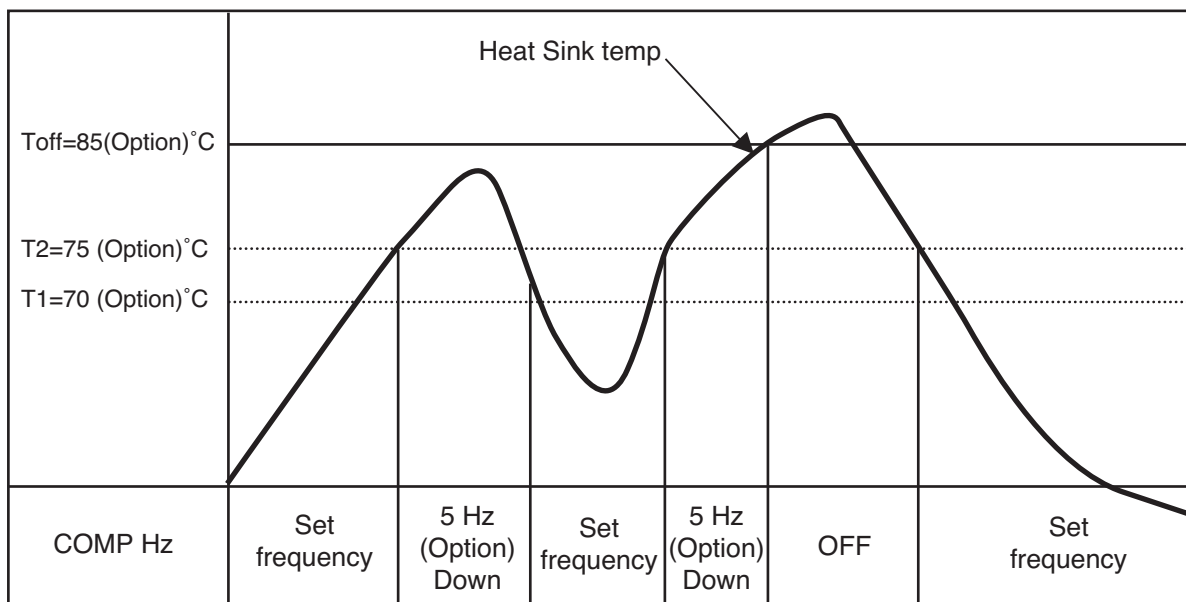

---

## 4. Test Run

1. Check before Test Run.....	37
2. Test Run Flow chart .....	38
3. Test Running.....	39

## 1. Check before Test Run

1	Check to see whether there is any refrigerant leakage, and check whether the power or transmission cable is connected properly.
2	<p>Check liquid pipe and gas pipe valves are fully opened.</p> <p><b>NOTE:</b> Be sure to tighten caps.</p>
3	<p>Confirm that 500 V megger shows 2.0 MΩ or more between power supply terminal block and ground. Do not operate in the case of 2.0 MΩ or less.</p> <p><b>NOTE:</b> Never carry out mega ohm check over terminal control board. Otherwise the control board may break.</p> <p>Immediately after mounting the unit or after leaving it turned off for an extended length of time, the resistance of the insulation between the power supply terminal board and the ground may decrease to approx. 2.0 MΩ as a result of refrigerant accumulation in the internal compressor.</p> <p>If the insulation resistance is less than 2.0 MΩ, turn on the main power supply.</p>

## 2. Test Run Flow chart

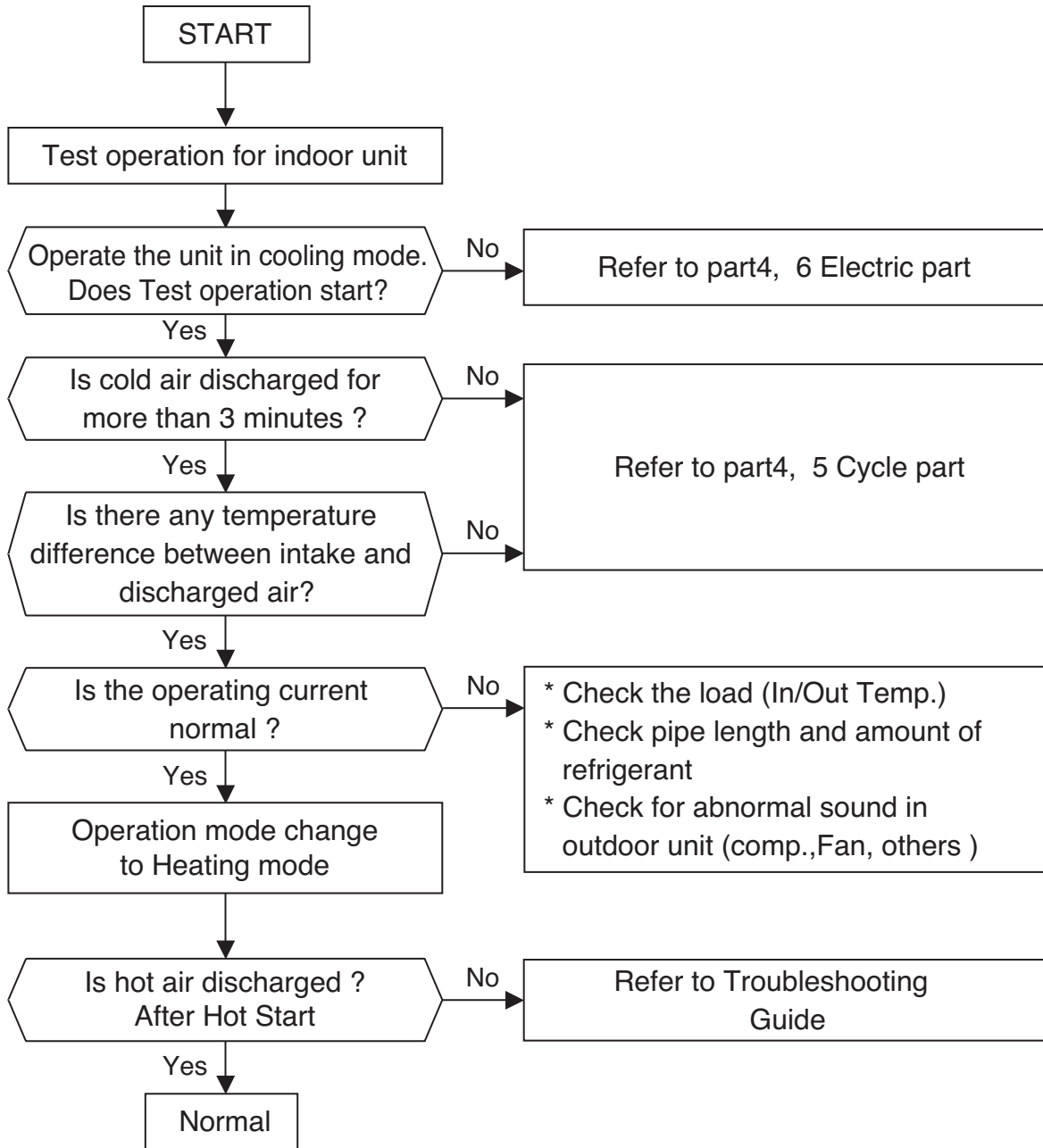

- Each indoor unit should be tested.
- If the unit has accessory, it should be tested.

## 3. Test Runing

### 3.1 PRECAUTIONS IN TEST RUN

- The initial power supply must provide at least 90% of the rated voltage. Otherwise, the air conditioner should not be operated.

#### CAUTION:

- ① For test run, carry out the cooling operation first even during winter season. If heating operation is carried out first, it leads to the trouble of compressor.
  - ② Carry out the test run more than 5 minutes without stopping.  
(Test run will be cancelled 18 minutes later automatically)
- The test run is started by pressing the room temperature checking button and down timer button for 3 seconds at the same time.
  - To cancel the test run, press any button.

### 3.2 CHECK THE FOLLOWING ITEMS WHEN INSTALLATION IS COMPLETE

- After completing work, be sure to measure and record trial run properties, and store measured data, etc.
- Measuring data are room temperature, outside temperature, suction temperature, blow out temperature, air velocity, air volume, voltage, current, presence of abnormal vibration and noise, operating pressure, piping temperature.
  - As to the structure and appearance, check following items.

- |   |   |
|---|---|
| <input type="checkbox"/> Is the circulation of air adequate?                                | <input type="checkbox"/> Does the remote controller works properly? |
| <input type="checkbox"/> Is the drainage OK?  | <input type="checkbox"/> Is there any error on wiring?              |
| <input type="checkbox"/> Is the heat insulation complete<br>(refrigerant and drain piping)? | <input type="checkbox"/> Aren't terminal screws loosened?           |
| <input type="checkbox"/> Is there any leakage of refrigerant?                               |   |

M4.....118N.cm{12kgf.cm}    M5.....196N.cm{20kgf.cm}  
M6.....245N.cm{25kgf.cm}    M8.....588N.cm{60kgf.cm}

---

## 5. Trouble Shooting

1. Self-diagnosis Function.....	41
2. Pump Down.....	43
3. Evacuation .....	44
4. Gas Charging.....	45
5. Cycle Part.....	46
6. Electronic Parts .....	47

## 1. Self-diagnosis Function

### 1.1 Error Indicator (Indoor)

#### Standard/Artcool Mirror Type Display

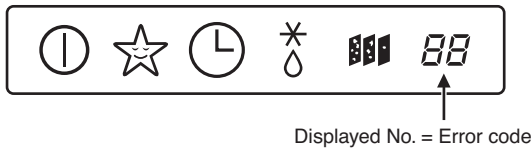

#### Ceiling Cassette Type Display

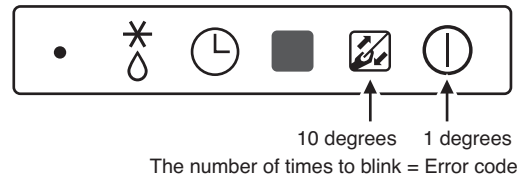

#### Standard Libero Type Display

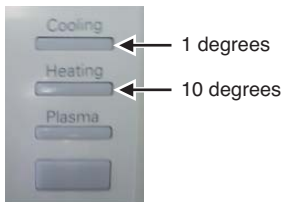

The number of times to blink = Error code

#### Error Indicator

- The function is to self-diagnosis airconditioner and express the troubles identifiably if there is any trouble.
- Error mark is ON/OFF for the operation LED of evaporator body in the same manner as the following table.
- If more than two troubles occur simultaneously, primarily the highest trouble fo error code is expressed.
- After error occurrence, if error is released, error LED is also released simultaneously.
- To operate again on the occurrence of error code, be sure to turn off the power and then turn on.
- Having or not of error code is different from Model.

#### Indoor Error

Error code	Description	Indoor Status
00	No Error	ON
01	Indoor Room themistor error	OFF
02	Indoor in-piping sensor error	OFF
03	Remote controller error	OFF
04	Drain Pump error	OFF
05	Communcation error between in and out	OFF
06	Indoor Out-Piping sensor error	OFF
07	Differnt mode operation	OFF
09	EEPROM Check Sum Error	OFF
10	Indoor BLDC Fan Lock	OFF

## 5. Trouble Shooting

### 1.3 Error Indicator (Outdoor)

Outdoor Error

Ex) Error 21 (DC Peak)

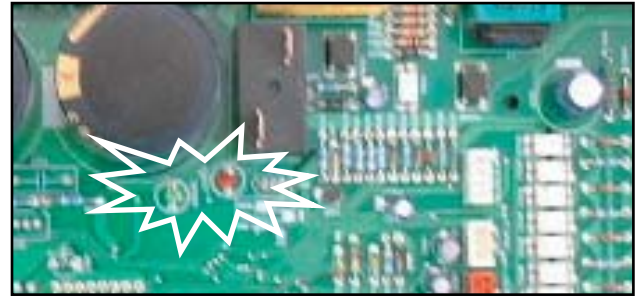
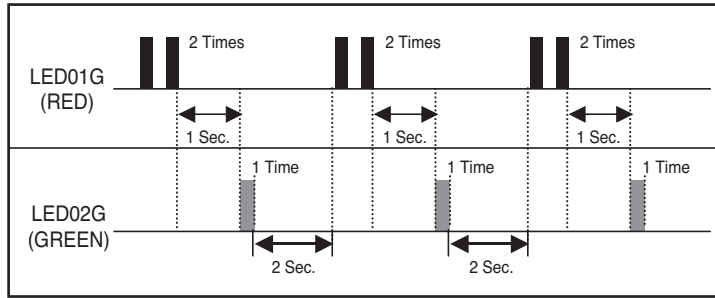

Error Code	Contents	LED01G/M (Red)	LED02G/M (Green)	Case of Error	Outdoor Status
21	DC Peak (IPM Fault)	2times ●	1time ●	Over Rated Current	Off
22	CT 2(Max CT)	2times ●	2times ●	Input Over Current	Off
23	DC Link Low Volt.	2times ●	3times ●	DC Link Volt is below 140Vdc	Off
24	L_P/H_P Switch	2times ●	4times ●	Low/High Press Switch Open	Off
25	Low Voltage/Over Voltage	2times ●	5times ●	Abnormal AC Volt Input	Off
26	DC Compressor Position Error	2times ●	6times ●	Compressor Starting Fall Error	Off
27	PSC/PFC Fault Error	2times ●	7times ●	Inverter PCB input current is over100A(peak) for 2us	Off
28	DC Link High Volt	2times ●	8times ●	Off	Off
29	COMP Over Current	2times ●	9times ●	Over Inverter Compressor Current	Off
32	D-Pipe High (INV)	3times ●	2times ●	Off	Off
40	CT Sensor (Open / Short)	4times ●	○	CT Circuit Malfunction	Off
41	INV. D-Pipe Th Error	4times ●	1time ●	Open/Short	Off
44	Outdoor Air Th Error	4times ●	4times ●	Open/Short	Off
45	Cond. Pipe Th Error	4times ●	5times ●	Open/Short	Off
46	Suction Pipe Error	4times ●	6times ●	Open/Short	Off
51	Capacity Over	5times ●	1time ●	Over combination	Off
52	Signal Error(DSP Board <-> Main Board)	5times ●	2times ●	Communication Poorly	Off
53	Signal Error (Indoor <-> Outdoor)	5times ●	3times ●	Communication Poorly	Off
60	EEPROM Check Sum Error	6times ●	○	Check Sum Mismatching	Off
61	Cond. Pipe Th High	6times ●	1time ●	Cond. Temp. High	Off
62	Heatsink Th High	6times ●	2times ●	Heatsink Temp. High	Off
65	Heatsink Th Error	6times ●	5times ●	Open/Short	Off
67	Outdoor BLDC Fan Lock	6times ●	7times ●	Outdoor Fan is not operating	Off
73	PFC Fault Error(S/W)	7times ●	3times ●	Over Current of Outdoor Unit PFC	Off

## 2. Pumping Down

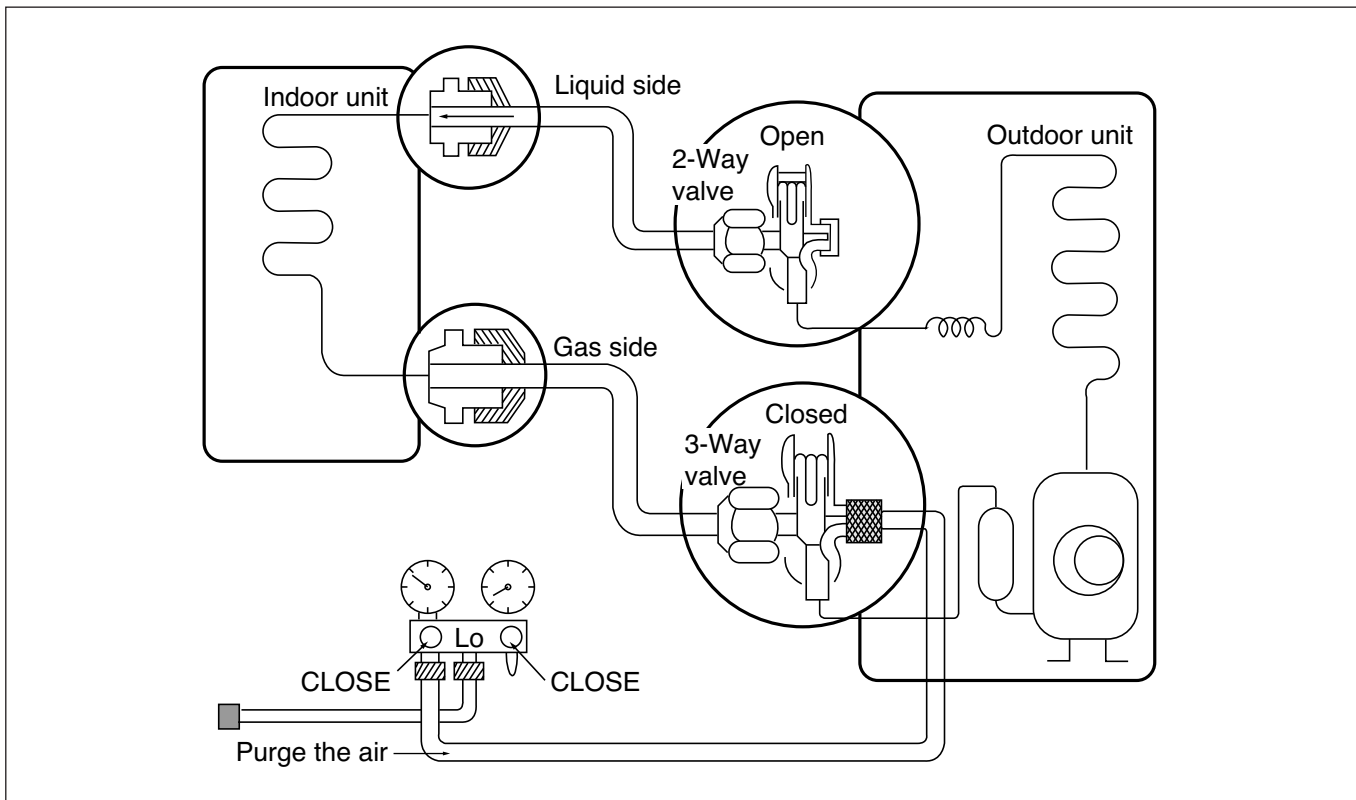

### • Procedure

- (1) **Confirm that both the 2-way and 3-way valves are set to the open position.**
  - Remove the valve stem caps and confirm that the valve stems are in the raised position.
  - Be sure to use a hexagonal wrench to operate the valve stems.
- (2) **Operate the unit for 10 to 15 minutes.**
- (3) **Stop operation and wait for 3 minutes, then connect the charge set to the service port of the 3-way valve.**
  - Connect the charge hose with the push pin to the service port.
- (4) **Air purging of the charge hose.**
  - Open the low-pressure valve on the charge set slightly to air purge from the charge hose.
- (5) **Set the 2-way valve to the closed position.**
- (6) **Operate the air conditioner at the cooling cycle and stop it when the gauge indicates 1kg/cm<sup>2</sup>g.**
- (7) **Immediately set the 3-way valve to the closed position.**
  - Do this quickly so that the gauge ends up indicating 3 to 5kg/cm<sup>2</sup>g.
- (8) **Disconnect the charge set, and mount the 2-way and 3-way valve's stem nuts and the service port nut.**
  - Use torque wrench to tighten the service port nut to a torque of 1.8 kg.m.
  - Be sure to check for gas leakage.

### 3. Evacuation (All amount of refrigerant leaked)

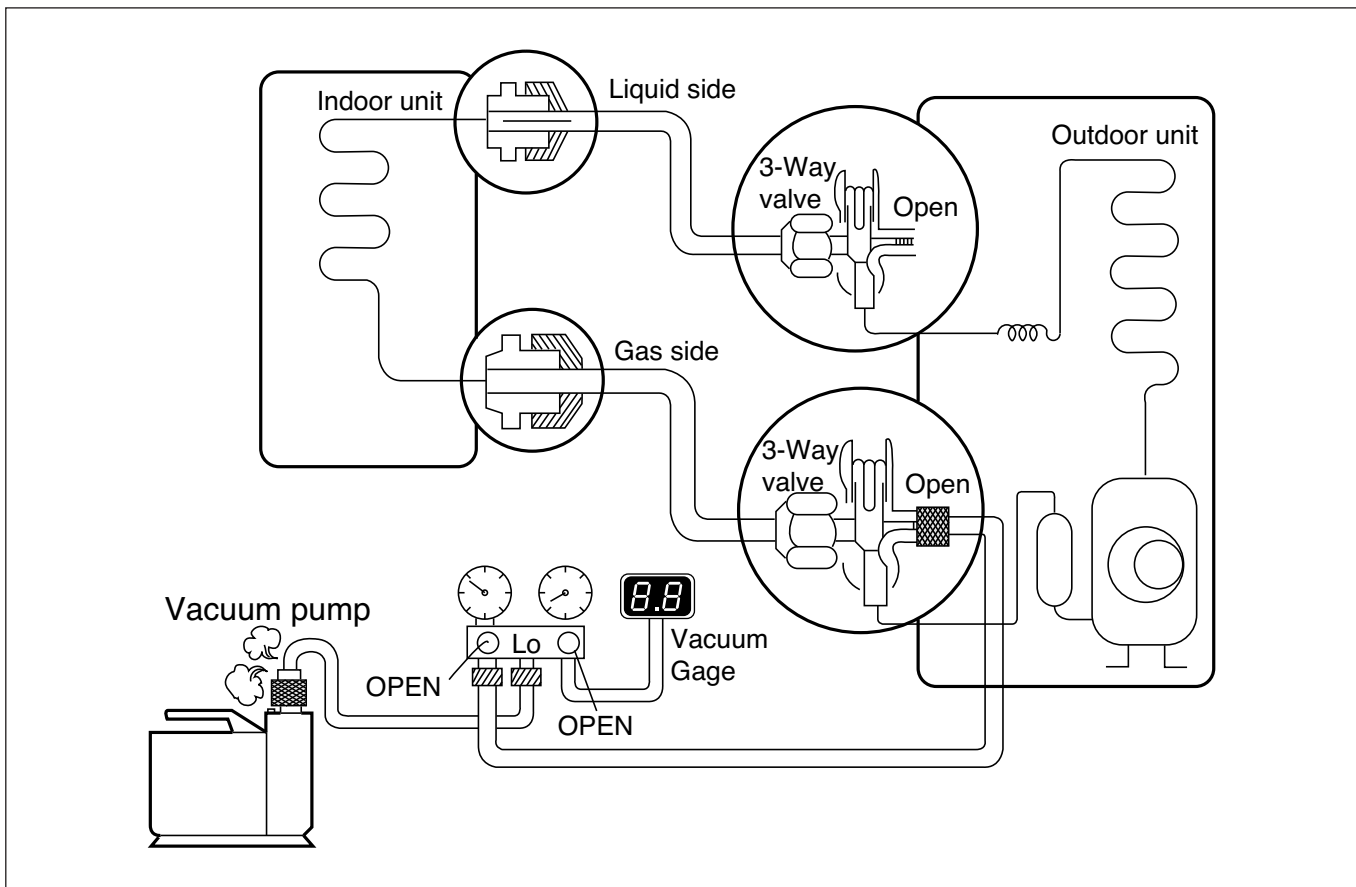

#### • Procedure

- (1) Connect the vacuum pump to the center hose of charge set center hose
- (2) Evacuation for approximately one hour.
  - Confirm that the gauge needle has moved toward 0.8Torr.
- (3) Close the valve (Lo side) on the charge set, turn off the vacuum pump, and confirm that the gauge needle does not move (approximately 5 minutes after turning off the vacuum pump).
- (4) Disconnect the charge hose from the vacuum pump.
  - Vacuum pump oil.  
If the vacuum pump oil becomes dirty or depleted, replenish as needed.

## 4. Gas Charging (After Evacuation)

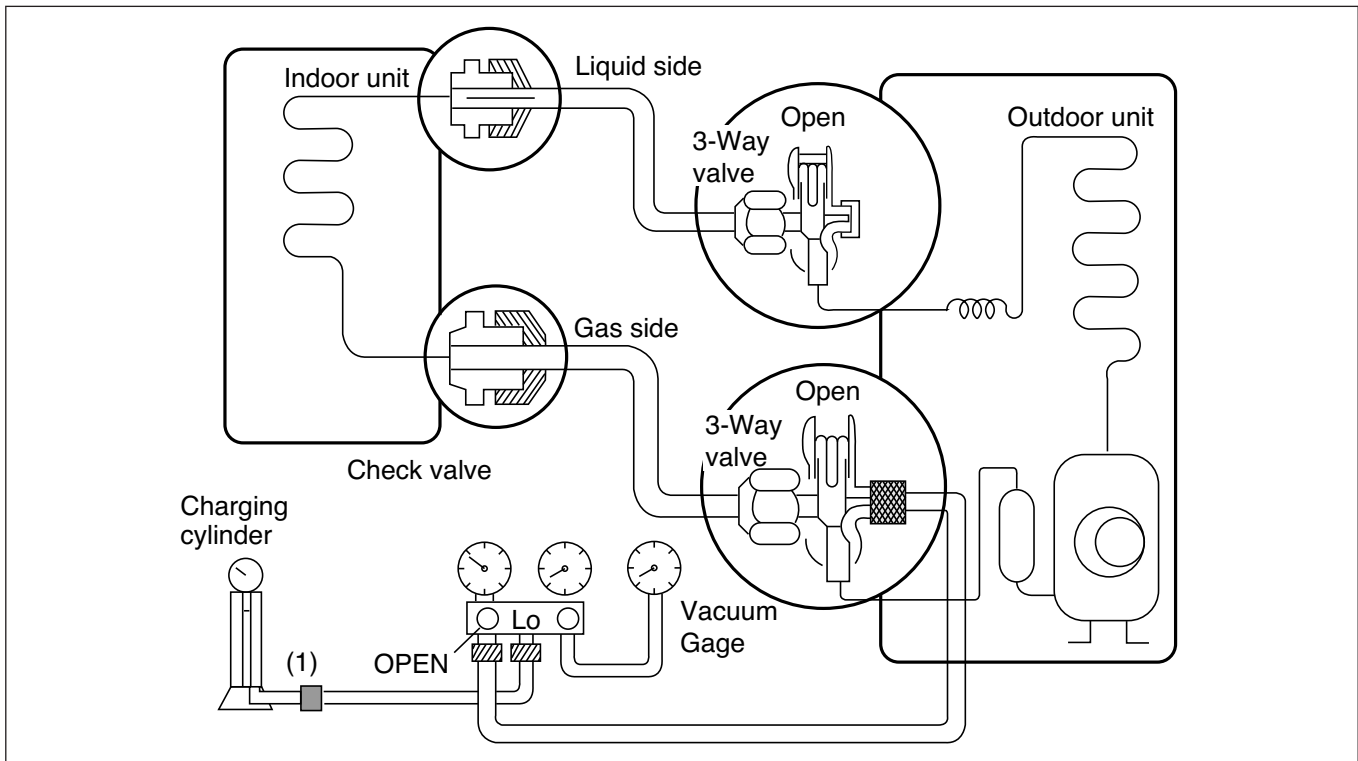

### • Procedure

#### (1) Connect the charge hose to the charging cylinder.

- Connect the charge hose which you dis-connected from the vacuum pump to the valve at the bottom of the cylinder.
- If you are using a gas cylinder, also use a scale and reverse the cylinder so that the system can be charged with liquid.

#### (2) Purge the air from the charge hose.

- Open the valve at the bottom of the cylinder and press the check valve on the charge set to purge the air. (Be careful of the liquid refrigerant). The procedure is the same if using a gas cylinder.

#### (3) Open the valve (Lo side on the charge set and charge the system with liquid refrigerant.

- If the system can not be charged with the specified amount of refrigerant, it can be charged with a little at a time (approximately 150g each time) while operating the air conditioner in the cooling cycle; however, one time is not sufficient, wait approximately 1 minute and then repeat the procedure (pumping down-pin).

This is different from previous procedures.

Because you are charging with liquid refrigerant from the gas side, absolutely do not attempt to charge with larger amounts of liquid refrigerant while operating the air conditioner.

#### (4) Immediately disconnect the charge hose from the 3-way valve's service port.

- Stopping partway will allow the gas to be discharged.
- If the system has been charged with liquid refrigerant while operating the air conditioner turn off the air conditioner before disconnecting the hose.

#### (5) Mount the valve stem nuts and the service port nut.

- Use torque wrench to tighten the service port nut to a torque of 1.8 kg.m.
- Be sure to check for gas leakage.

## 5. Cycle Part

### Trouble analysis

1. Check temperature difference between intake and discharge air, and check for the operating current too.

Case	Symptom	Supposed Caused
Case 1	Temp. difference : approx. 0°C Current : less than 80% of rated current	All amount of refrigerant leaked out. Check refrigeration cycle.
Case 2	Temp. difference : approx. 8°C Current : less than 80% of rated current	Refrigerant leakage Clog of refrigeration cycle Defective Compressor.
Case 3	Temp. difference : less than 8°C Current : over the rated current	Excessive amount of refrigerant
Case 4	Temp. difference : over 8°C	Normal

### NOTICE

Temperature difference between intake and discharge air depends on room air humidity. When the room air humidity is relatively higher, temperature difference is smaller. When the room air humidity is relatively lower temperature difference is larger.

2. Check temperature and pressure of refrigeration cycle in cooling mode.

Suction pressure (Compared with the normal value)	Temperature of Discharge Air (Compared with the normal valve)	Cause of Trouble	Description
Higher	High	Defective compressor Defective 4-way reverse valve	Current is low.
	Normal	Excessive amount of refrigerant	High pressure does not quickly rise at the beginning of operation.
Lower	Higher	Insufficient amount of refrigerant (Leakage) Clogging	Current is low.

### NOTICE

- The suction pressure is usually 8.5~9.5kg/cm<sup>2</sup>G(Cooling) at normal condition.(R410A)
- The temperature can be measured by attaching the thermometer to the low pressure tubing and wrap it with putty.

## 6. Electronic Parts

### 6.1 The Product doesn't operate at all

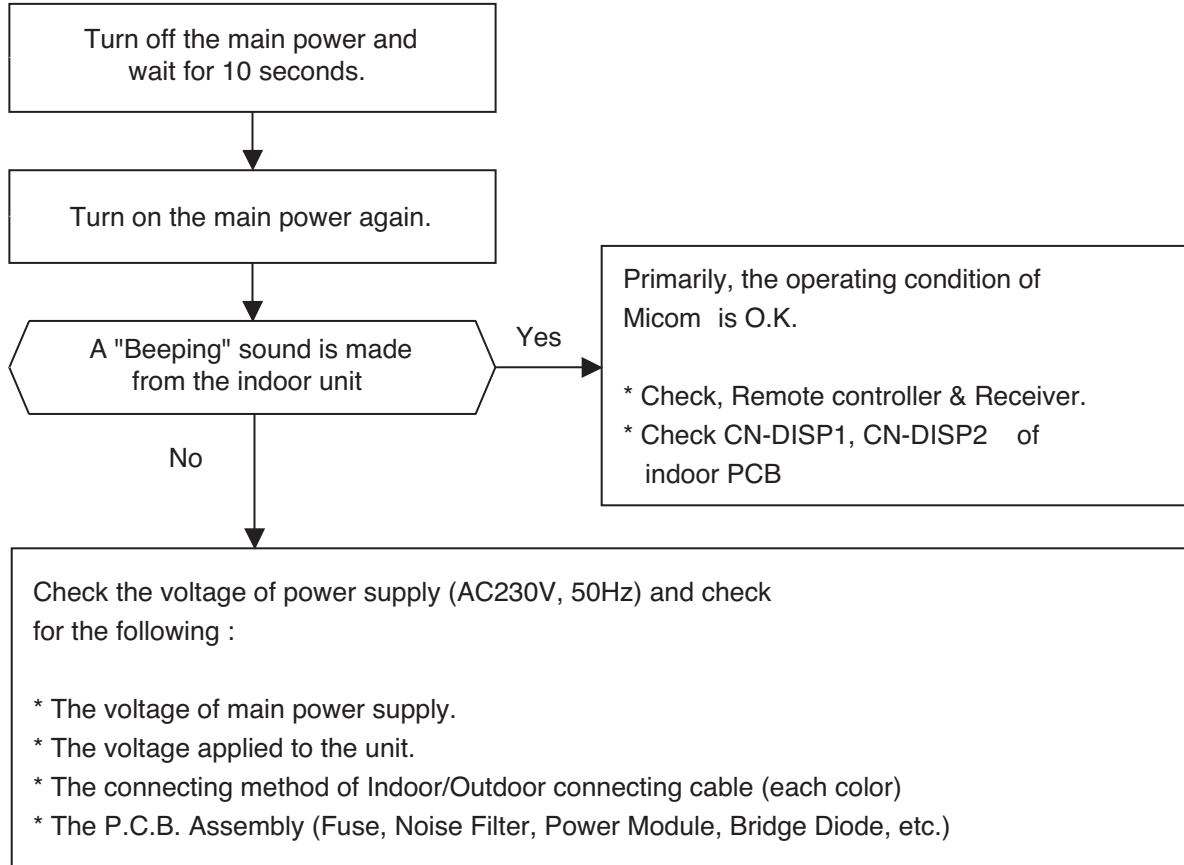

The operation check of the Indoor P.C.B. Ass'y		
Procedure	Specification	Remedy
1) The input voltage of power module.	1) AC230V $\pm$ 30V : Check the rated voltage	1) Check the power outlet.
2) The output voltage of power module.	2) 12V $\pm$ 3V	2) Replace P.C.B Ass'y
4) IC04D(7805)	4) DC5V	4) Replace P.C.B Ass'y
5) IC01A(KIA7036)	5) The voltage of micom pin 19 : DC4.5V $\uparrow$	5) Replace P.C.B Ass'y

## 6.2 The Product doesn't operate with the remote controller

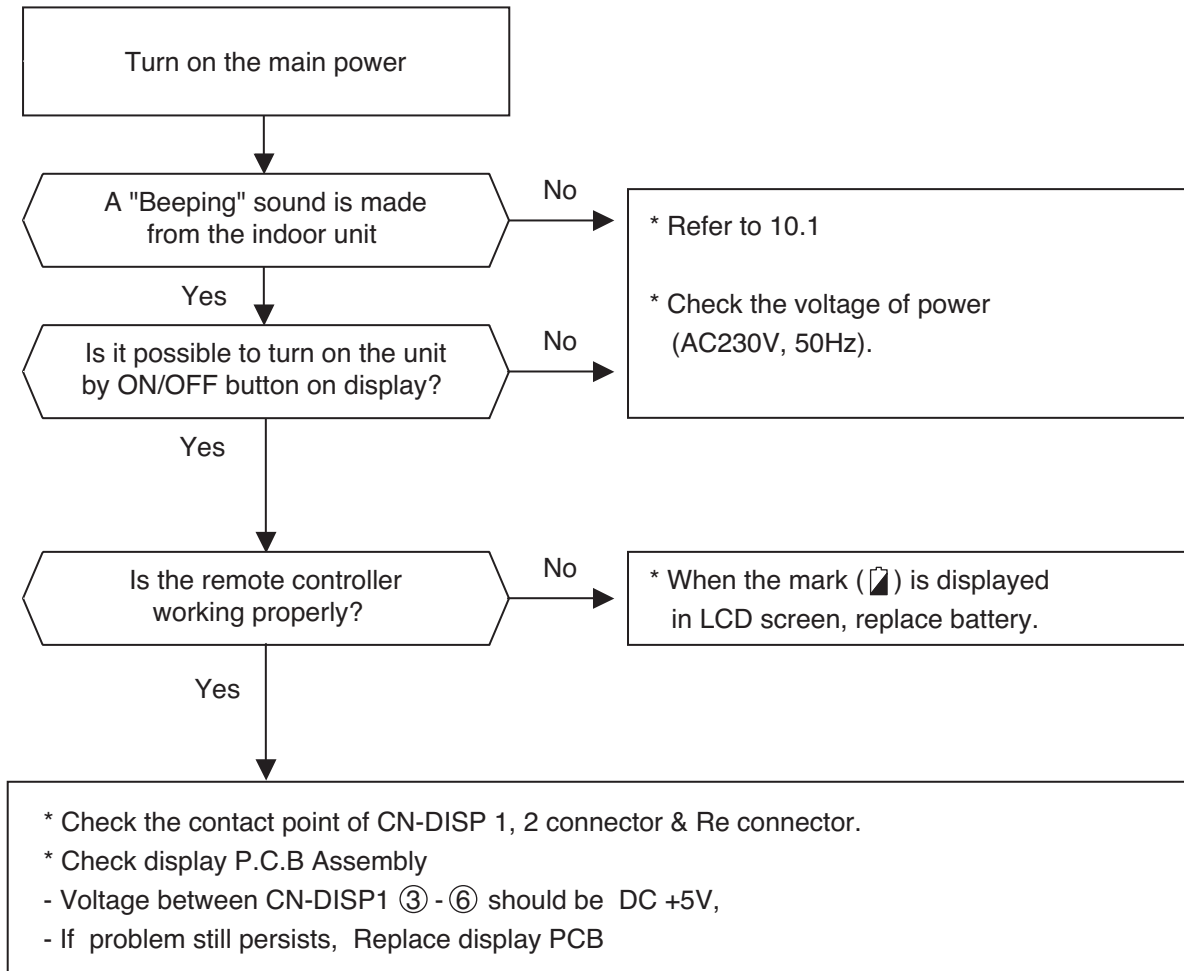

### 6.3 The Compressor/Outdoor Fan are don't operate

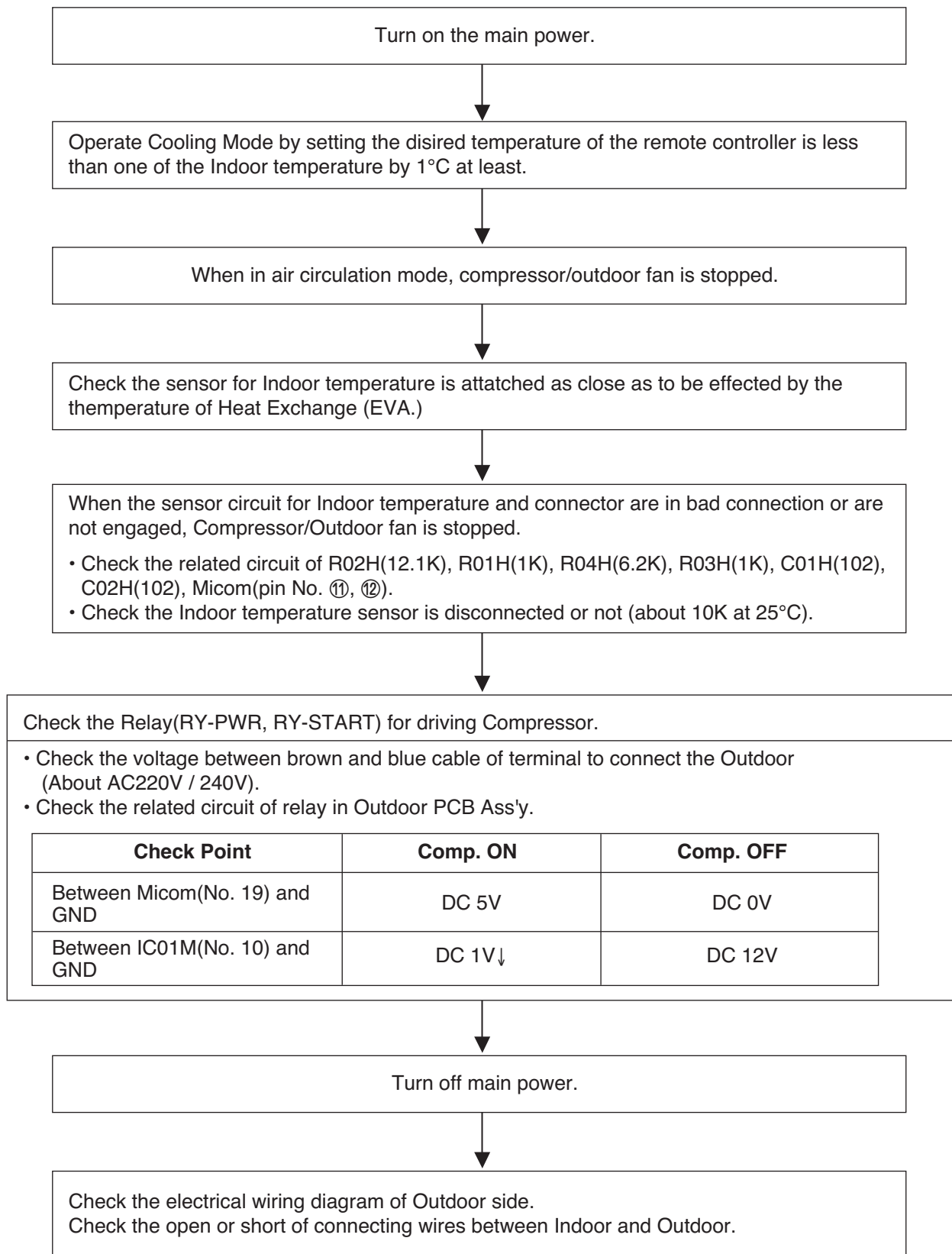

### 6.4 When indoor Fan does not operate.

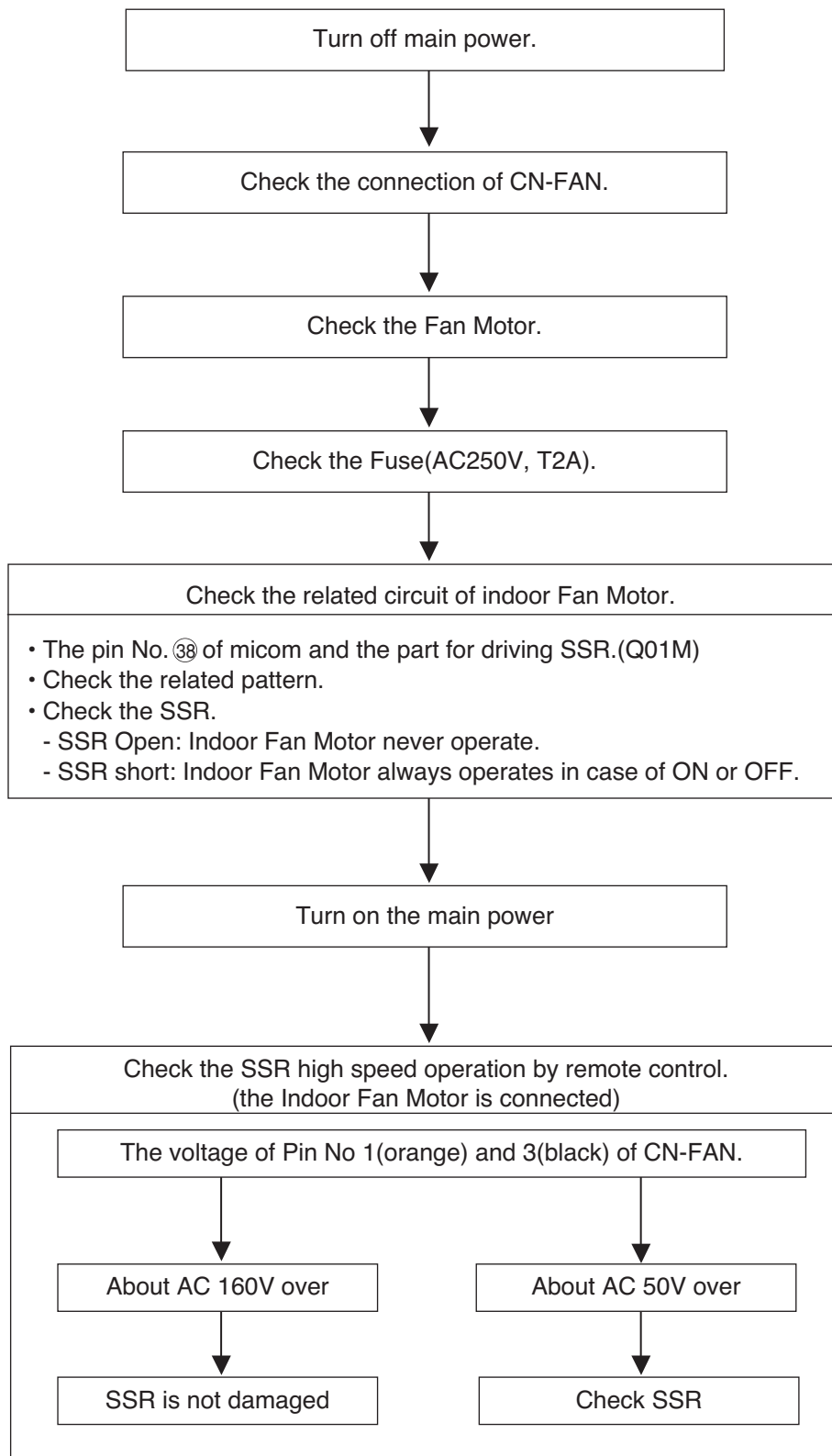

## 6.5 When the louver does not operate.

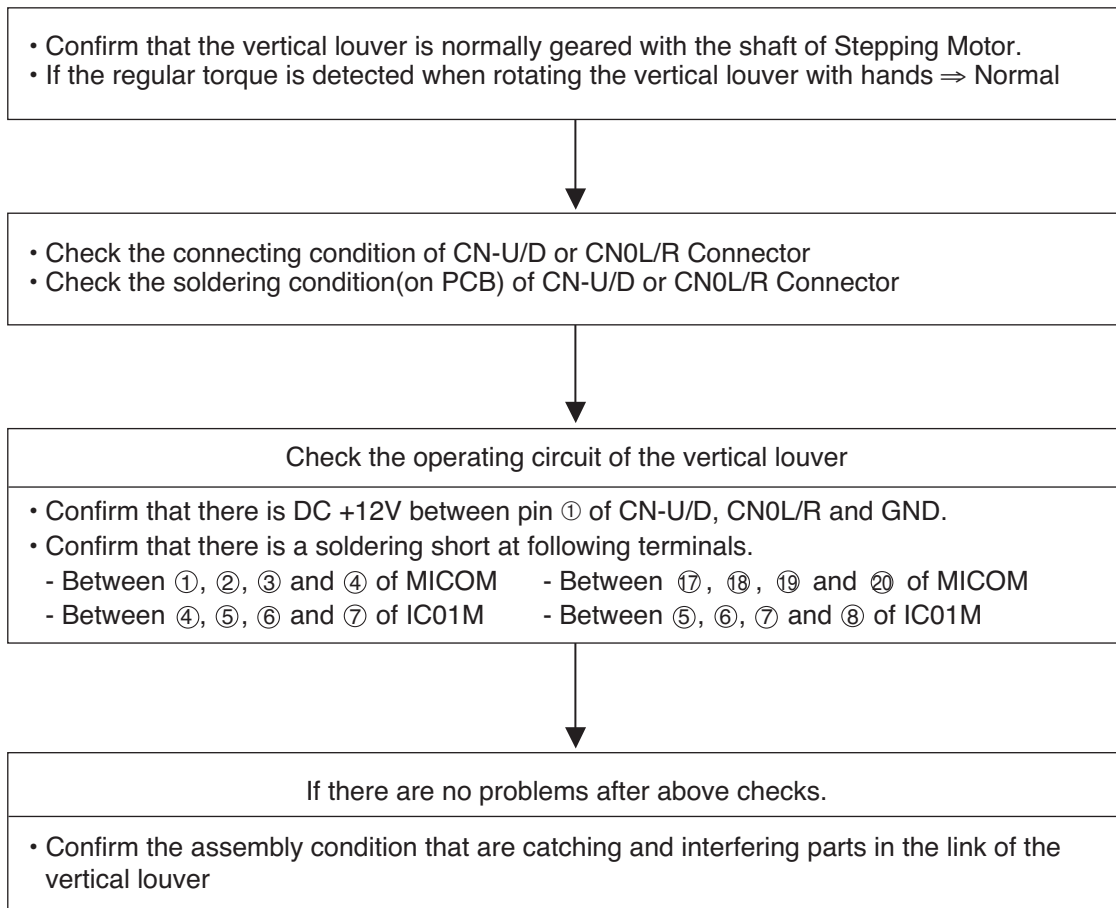

## 6.6 Troubleshooting Indoor Error

Display code	Title	Cause of error	Check point & Normal condition
01	Indoor air sensor	<ul style="list-style-type: none"> <li>• Open / Short</li> <li>• Soldered poorly</li> <li>• Internal circuit error</li> </ul>	Normal resistor : 10KΩ/ at 25°C (Unplugged) Normal voltage : 2.5Vdc / at 25°C (plugged)
02	Indoor inlet pipe sensor	<ul style="list-style-type: none"> <li>• Open / Short</li> <li>• Soldered poorly</li> <li>• Internal circuit error</li> </ul>	Normal resistor : 5KΩ/ at 25°C (Unplugged) Normal voltage : 2.5Vdc / at 25°C (plugged)
06	Indoor outlet pipe sensor	<ul style="list-style-type: none"> <li>• Open / Short</li> <li>• Soldered poorly</li> <li>• Internal circuit error</li> </ul>	Normal resistor : 5KΩ/ at 25°C (Unplugged) Normal voltage : 2.5Vdc / at 25°C (plugged)

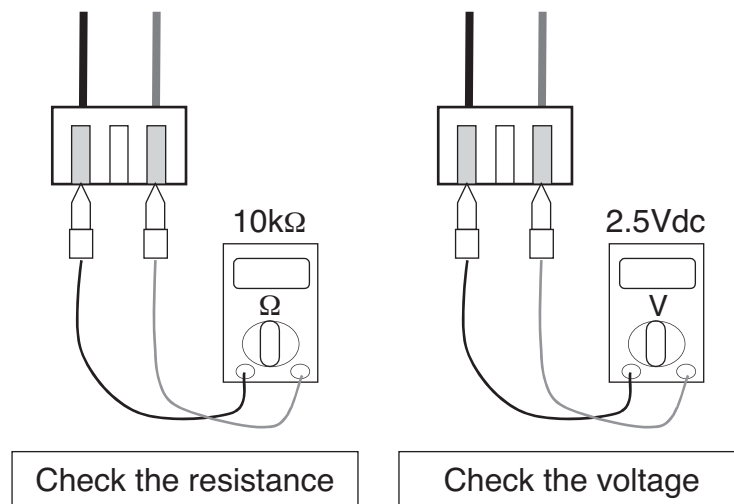

### Check Point

1. Unplug the sensor on Indoor unit PCB.
2. Estimate the resistance of each sensor.
3. If the resistance of the sensor is 10KΩ/ 5KΩ at 25°C, then sensor is normal.
4. If the resistance of the sensor is 0 KΩ or ∞, then sensor is abnormal. → Change the sensor.
5. Plug the sensor on Indoor unit PCB and Power ON.
6. Estimate the voltage of each sensor.
7. If the voltage of the sensor is 2.5Vdc at 25°C, then sensor is normal.
8. If the resistance of the sensor is 0 or 5Vdc, then sensor is abnormal. → Repair or Change the PCB.

Display code	Title	Cause of error	Check point & Normal condition
03	Communication Wired R/C	<ul style="list-style-type: none"> <li>• Open / Short</li> <li>• Wrong connection</li> </ul>	<ul style="list-style-type: none"> <li>• Connection of wire</li> <li>• Main PCB Volt. DC12V</li> <li>• Noise interference</li> </ul>

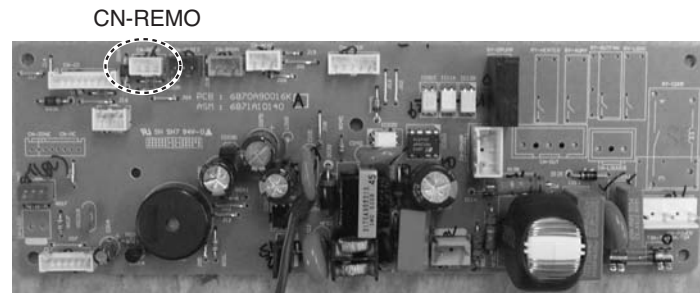
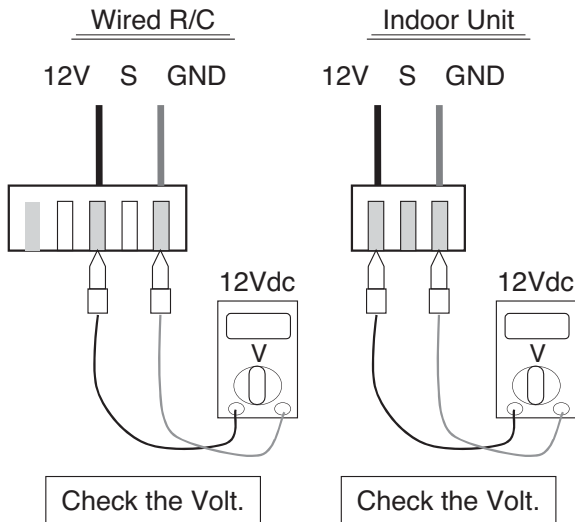

## Check Point

1. Check the wire connection. (Open / Short) → Repair the connection
2. Check the soldering state of connector. (Soldered poorly) → Repair or Change the PCB.
3. Check the volt. Of main PCB power source. (DC 12V, DC 5V) → Repair or Change the main PCB.
4. Check the installation of wired remote controller. (Noise interference) → Adjust the state of installation

## 5. Trouble Shooting

Display code	Title	Cause of error	Check point & Normal condition
04	Drain pump / Float switch	<ul style="list-style-type: none"> <li>• Float switch Open. (Normal : short)</li> </ul>	<ul style="list-style-type: none"> <li>• The connection of wire(Drain pump/ Float switch)</li> <li>• Drain pump power input. (220V)</li> <li>• Drain tube installation.</li> <li>• Indoor unit installation. (Inclination)</li> </ul>

CN Float

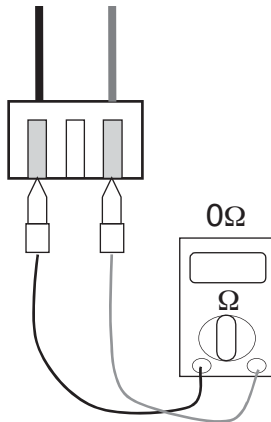

Check the resistance

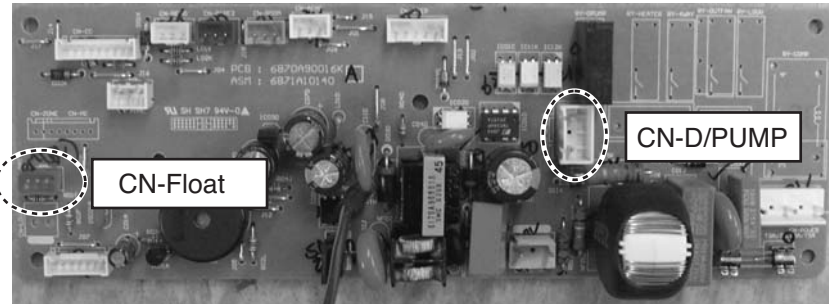

### Check Point

1. Check the wire connection. (Open, Soldered poorly) → Repair the connection or change the PCB.
2. Check the resistance of float switch (Abnormal : Open, Normal : short) → Check the float switch.
3. Check the level of water
4. Check the volt. Of Drain pump power supply. (AC 230V) → Repair or Change the main PCB.

Display code	Title	Cause of error	Check point & Normal condition
07	Different Operation Mode	<ul style="list-style-type: none"> <li>One of Indoor Unit operate cooling Another Unit operate heating</li> </ul>	<ul style="list-style-type: none"> <li>At the same time, this model cannot use cool and heating mode</li> </ul>

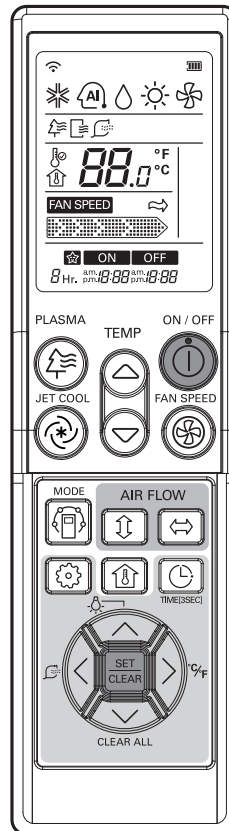

## Check Point

1. Check another indoor model operation mode
2. Operating the same mode with the first operated indoor unit
3. Clearing the "CH07"  
Press the on/off button or mode change button and matching the indoor unit mode same as the first operated indoor unit

## 5. Trouble Shooting

Display code	Title	Cause of error	Check point & Normal condition
09	Indoor EEPROM Check Sum Error	• Check sum error	1. Check the poor soldering 2. Check the insertion condition of the EEPROM 3. Check the PCB Connection

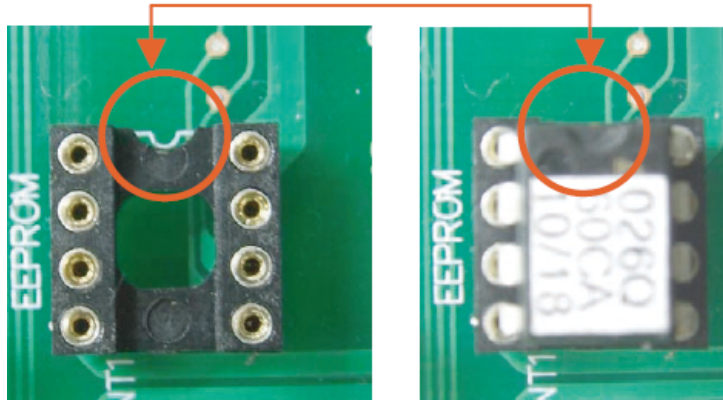

<EEPROM Direction Check Point>

### Check Point

1. Check the EEPROM Direction
2. If the EEPROM value & the Program value are not matched, the Code is Displayed
3. After Checking the connection and Insertion, replace the PCB or Option PCB

Display code	Title	Cause of error	Check point & Normal condition
10	Indoor BLDC Fan Motor Lock	The Fan is not operated properly	Check the Indoor fan locking

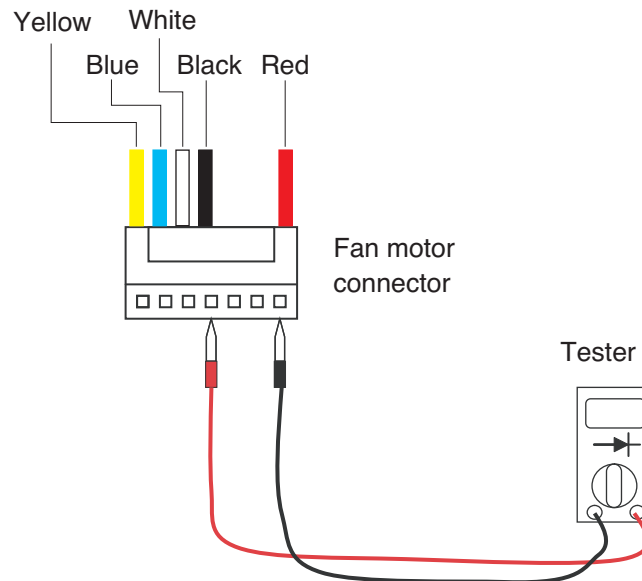

## Check Point

Check the PCB during the Power on

1. Check the Voltage Red line to Black line
  - The Voltage is about [input voltage x 1.414]
  - if the Voltage does not come with the above Voltage,
  - Check the power input
  - Replace the PCB & Motor
2. Check the Voltage Black line to White
  - the Voltage is DC 15V
  - Check the Power input
  - Replace the motor

Check the Motor

1. Check the shaft
  - if the shaft is not turn smoothly, the Motor Power IC is defected
  - replace the motor
2. Check the motor resistance(if the shaft is turn smoothly, check the resistance)
  - Check Red line to Black line, Blue line to Black line
  - The resistance should infinite
  - replace the motor

## 6.7 Troubleshooting Outdoor Error

Display code	Title	Cause of error	Check point & Normal condition
05 / 53	Title Communication (Indoor → Outdoor)	• Communication poorly	<ul style="list-style-type: none"> <li>• Power input AC 230V. (Outdoor, Indoor)</li> <li>• The connector for transmission is disconnected.</li> <li>• The connecting wires are misconnected.</li> <li>• The communication line is shorted at GND.</li> <li>• Transmission circuit of outdoor PCB is abnormal.</li> <li>• Transmission circuit of indoor PCB is abnormal.</li> </ul>

### Check Point

1. Check the input power AC230V. (Outdoor, Indoor unit)
2. Check the communication wires are correctly connected.  
Adjust the connection of wire Confirm the wire of "Live", "Neutral"
3. Check the resistance between communication line and GND. (Normal : Over 2MΩ)
4. Check the connector for communication is correctly connected.
5. If one indoor unit is operated normally, outdoor PCB is no problem.  
Check the another indoor unit.  
\* CH05 is displayed at indoor unit, CH53 is displayed at outdoor unit.
6. If all indoor unit is displayed CH05 but outdoor PCB not display  
CH53 : Check the CN\_COM and CN\_POWER is correctly connected.

#### • 24k/36k

1. In Case of CH53, Check the Connection → L , N at the terminal block

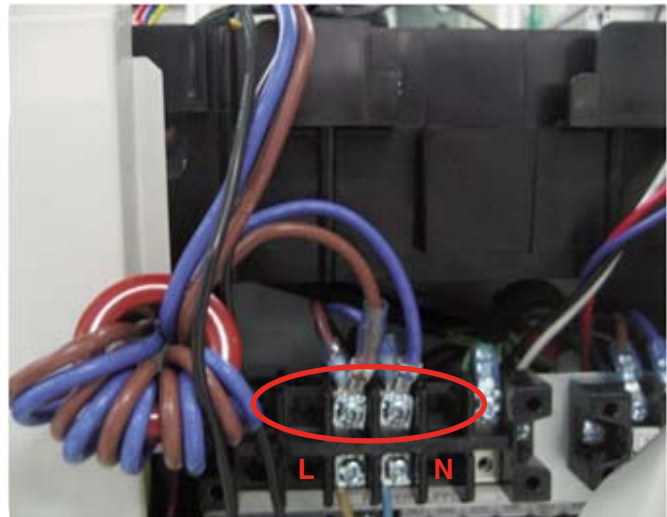

< TERMINAL BLOCK >

Display code	Title	Cause of error	Check point & Normal condition
21	DC PEAK (IPM Fault)	<ul style="list-style-type: none"> <li>Instant over current</li> <li>Over Rated current</li> <li>Poor insulation of IPM</li> </ul>	<ul style="list-style-type: none"> <li>An instant over current in the U,V,W phase                             <ul style="list-style-type: none"> <li>Comp lock</li> <li>The abnormal connection of U,V,W</li> </ul> </li> <li>Over load condition                             <ul style="list-style-type: none"> <li>Overcharging of refrigerant Pipe length.</li> <li>Outdoor Fan is stop</li> </ul> </li> <li>Poor insulation of compressor</li> </ul>

**Error Diagnosis and Countermeasure Flow Chart**

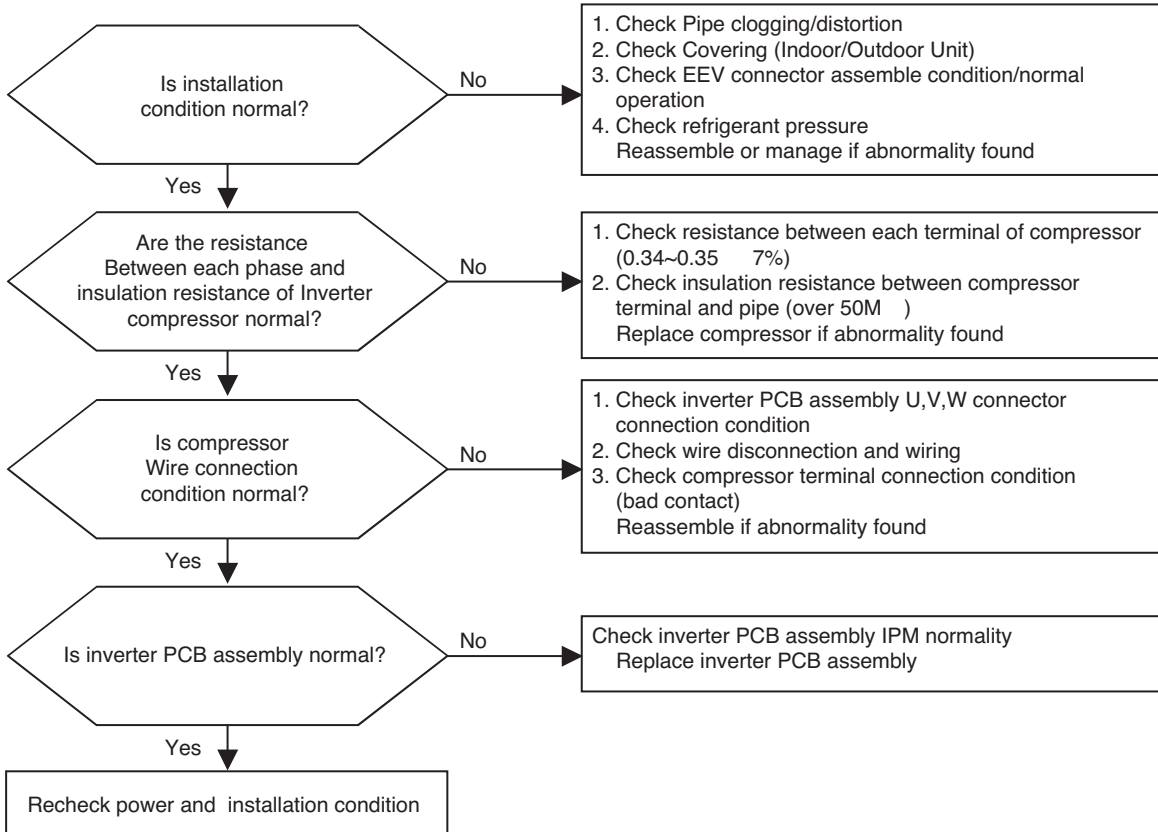

**Comp checking method**

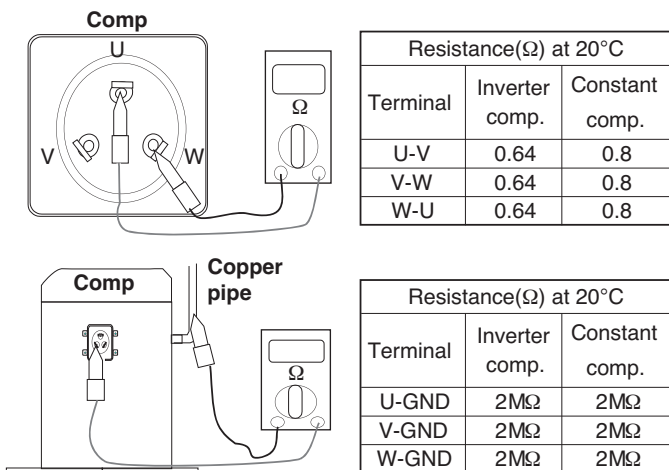

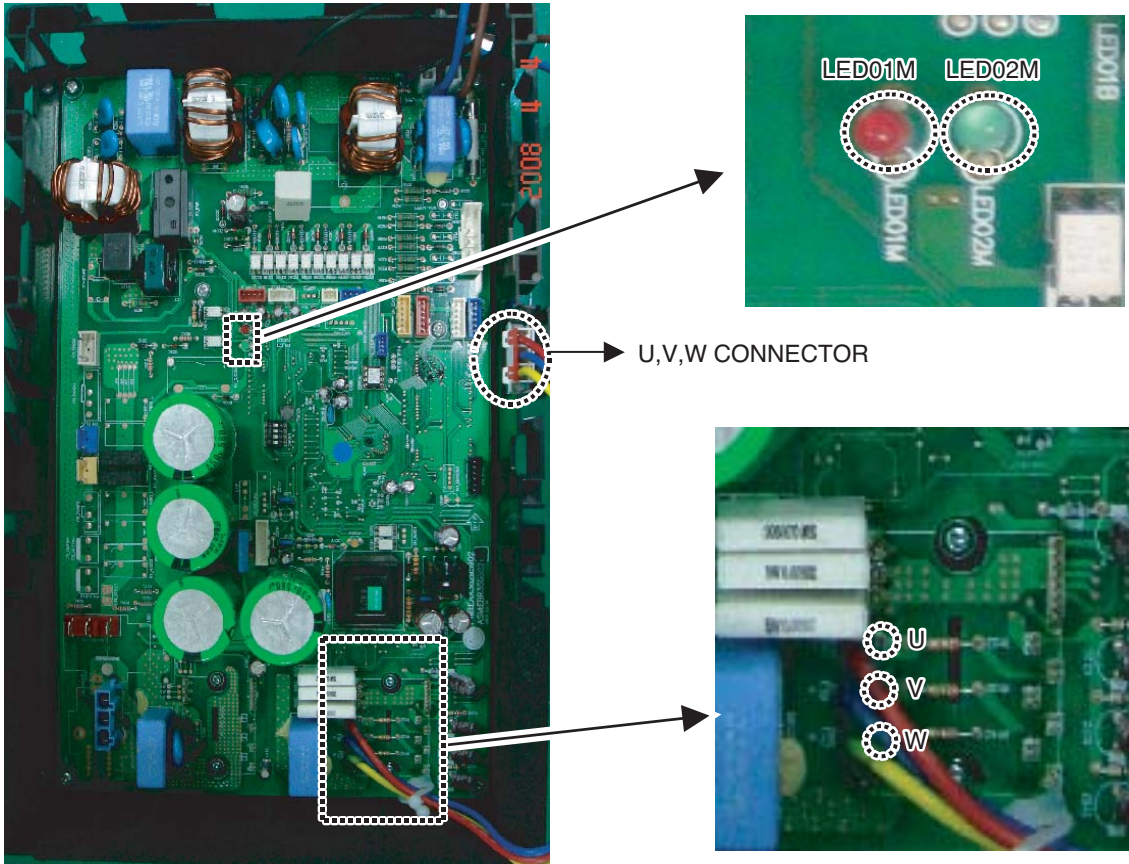

1. Wait until inverter PCB DC voltage is discharged after main power off.
2. Pull out V, V, W COMP connector.
3. Set multi tester to resistance mode.
4. If the value between P and N terminal of IPM is short( $0\Omega$ ) or open(hundreds  $M\Omega$ ), PCB needs to be replaced.(IPM damaged)
5. Set the multi tester to diode mode.
6. In case measured value is different from the table, PCB needs to be replaced.(PCB damaged).

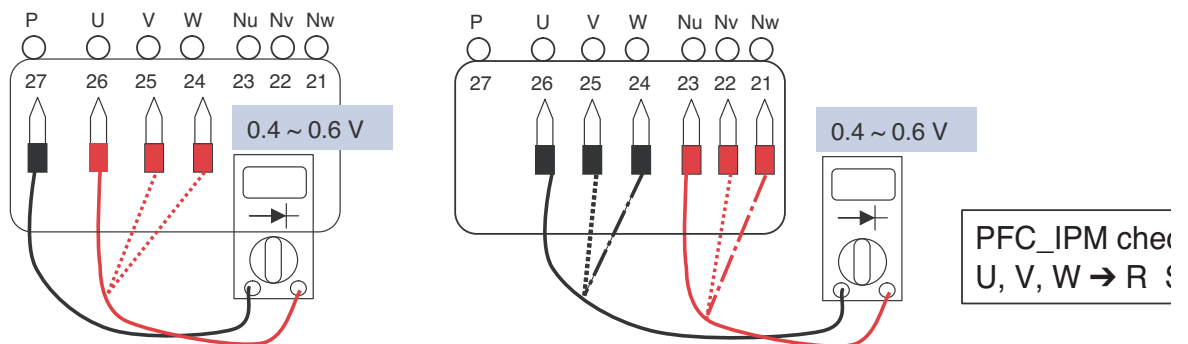

**CAUTION**

In case that the control box is opened and before checking electrical parts, it should be checked that the LED 01M, 02M turned off(wait 7 minutes after main power OFF), otherwise it may cause electrical shock.

Display code	Title	Cause of error	Check point & Normal condition
22	Max. C/T	Input Over Current(18k-13A ↑ , 24k/36k-20A ↑ )	1. Malfunction of Compressor 2. Blocking of Pipe 3. Low Voltage Input 4. Refrigerant, Pipe length, Blocked...

■ Error Diagnosis and Countermeasure Flow Chart

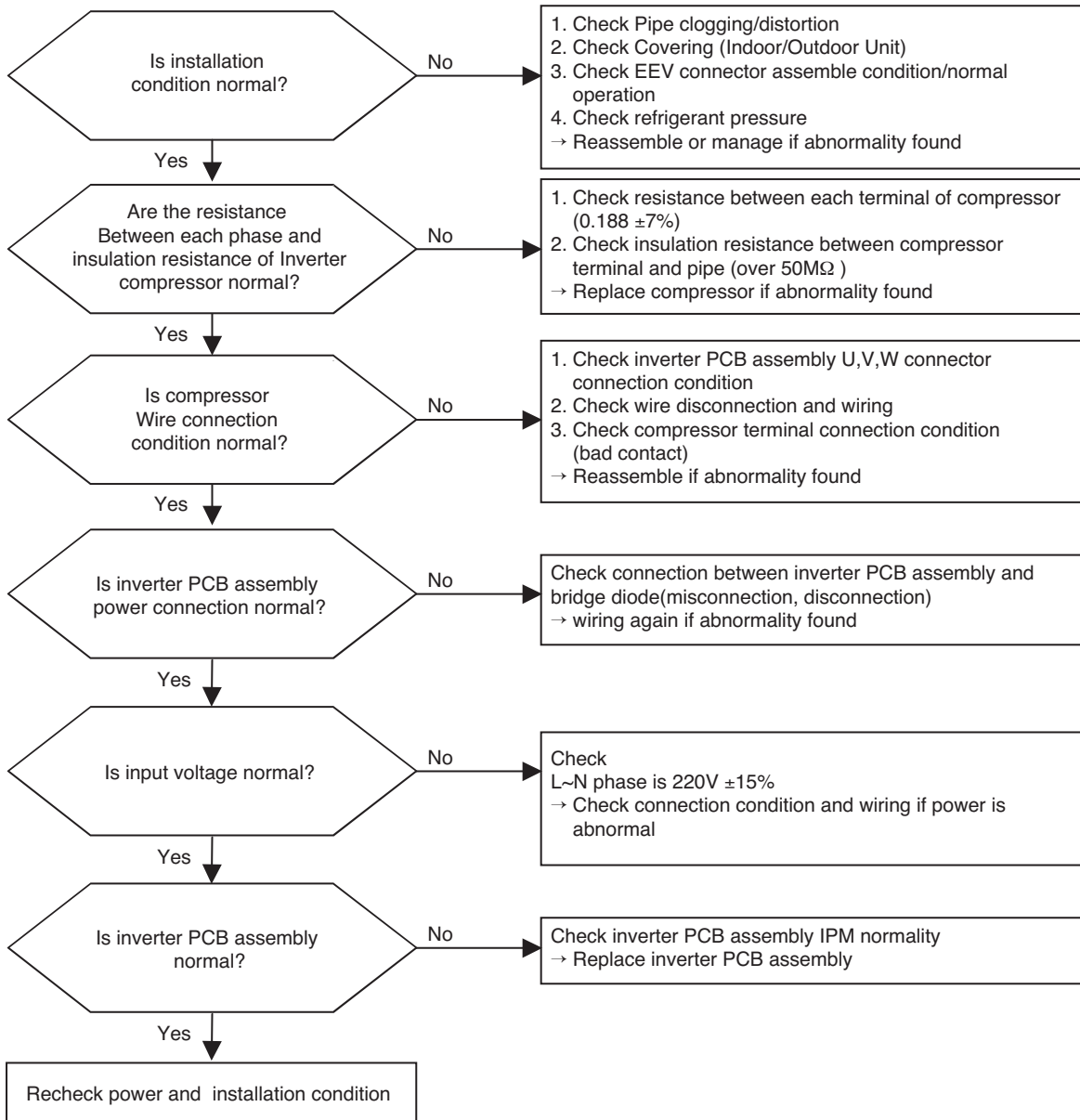

## 5. Trouble Shooting

### Check Point

1. Check the power source.(220V  $\pm$ 15%)
2. Check the fan operation is right.
3. Check the current.
4. Check the install condition.
5. Check the CT Sensor Output signal
  - Check output the CT Sensor : DC 2.5 $\pm$ 0.2V

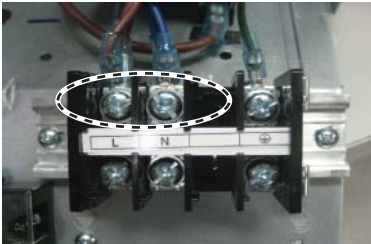

< Input Power Source Check Point >

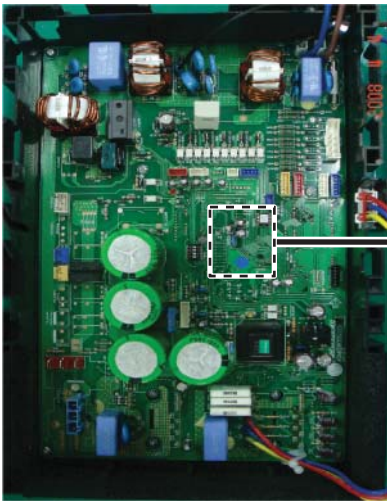

< Main PCB >

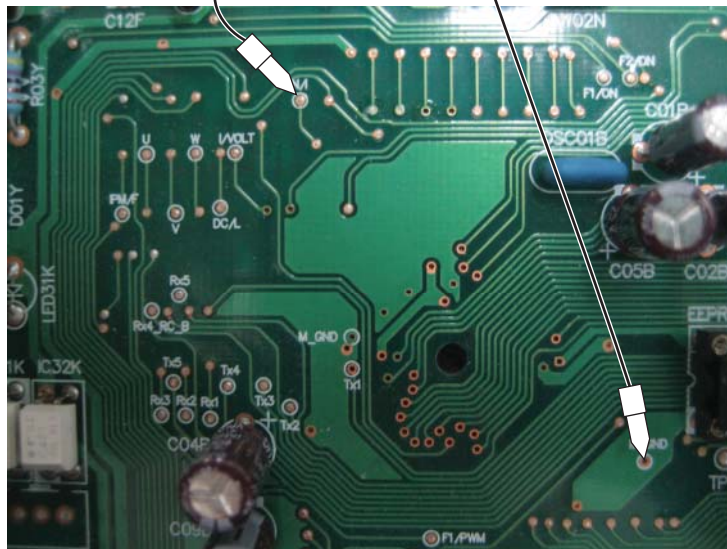

<CT Sensing Check Point>

Display code	Title	Cause of error	Check point & Normal condition
23	DC Link Low voltage	• DC Link volt is below 140Vdc	<ul style="list-style-type: none"> <li>• Check point &amp; Normal condition</li> <li>• Check theCN_(L),CN_(N) Connection.</li> <li>• At not operating : DC Link voltage(280V ↑ )</li> <li>• At Comp operating : DC Link voltage(340V ↑ )</li> </ul>

### ■ Error Diagnosis and Countermeasure Flow Chart

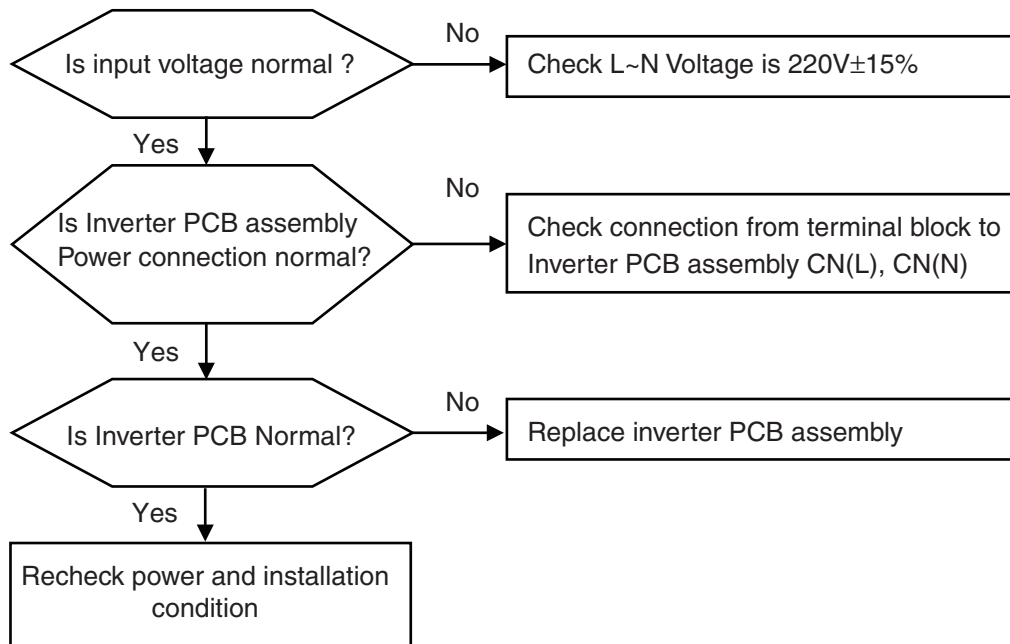

## 5. Trouble Shooting

### Check Point

1. Check the WCN\_P(L),P(N) Connection condition at the Main PCB.(Refer to outdoor wiring diagram)
2. Check the DC Link voltage at not operating(280V ↑ )
3. Check the DC Link voltage at Comp operating(340V ↑ )
4. Check DC Link Sensing Signal :2.4~2.8V (Refer the Picture)

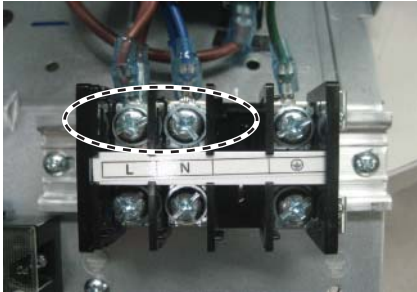

< Input Power Source Check Point >

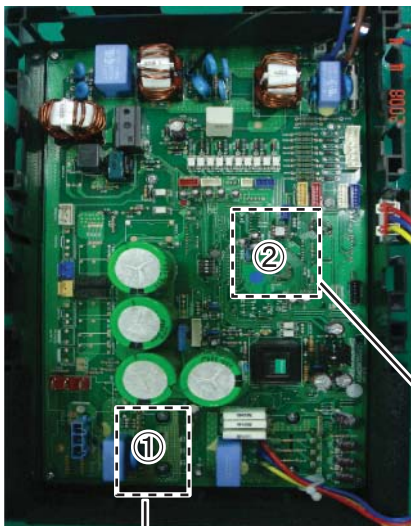

< Main PCB >

①

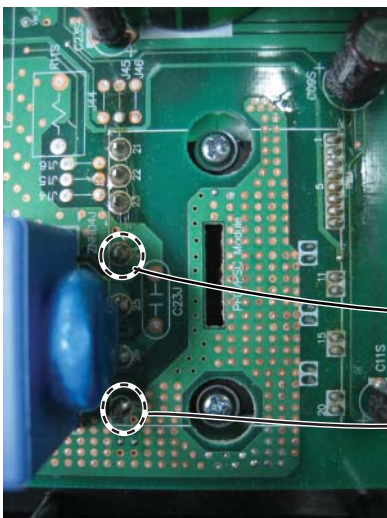

<DC Link Voltage Check Point>

②

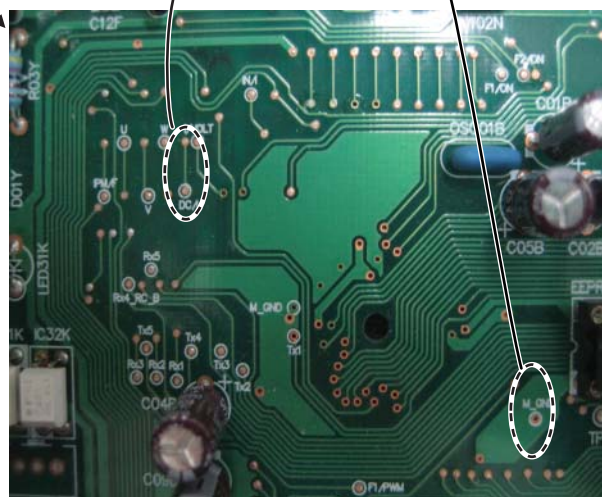

<DC\_LINK Sensing Check Point>

Display code	Title	Cause of error	Check point & Normal condition
24	Press S/W Open	<ul style="list-style-type: none"> <li>• Low / High press S/W open.</li> </ul>	<ul style="list-style-type: none"> <li>• Check the connection CN_L/PRESS,H/PRESS</li> <li>• Check the components.</li> </ul>

### ■ Error diagnosis and countermeasure flow chart

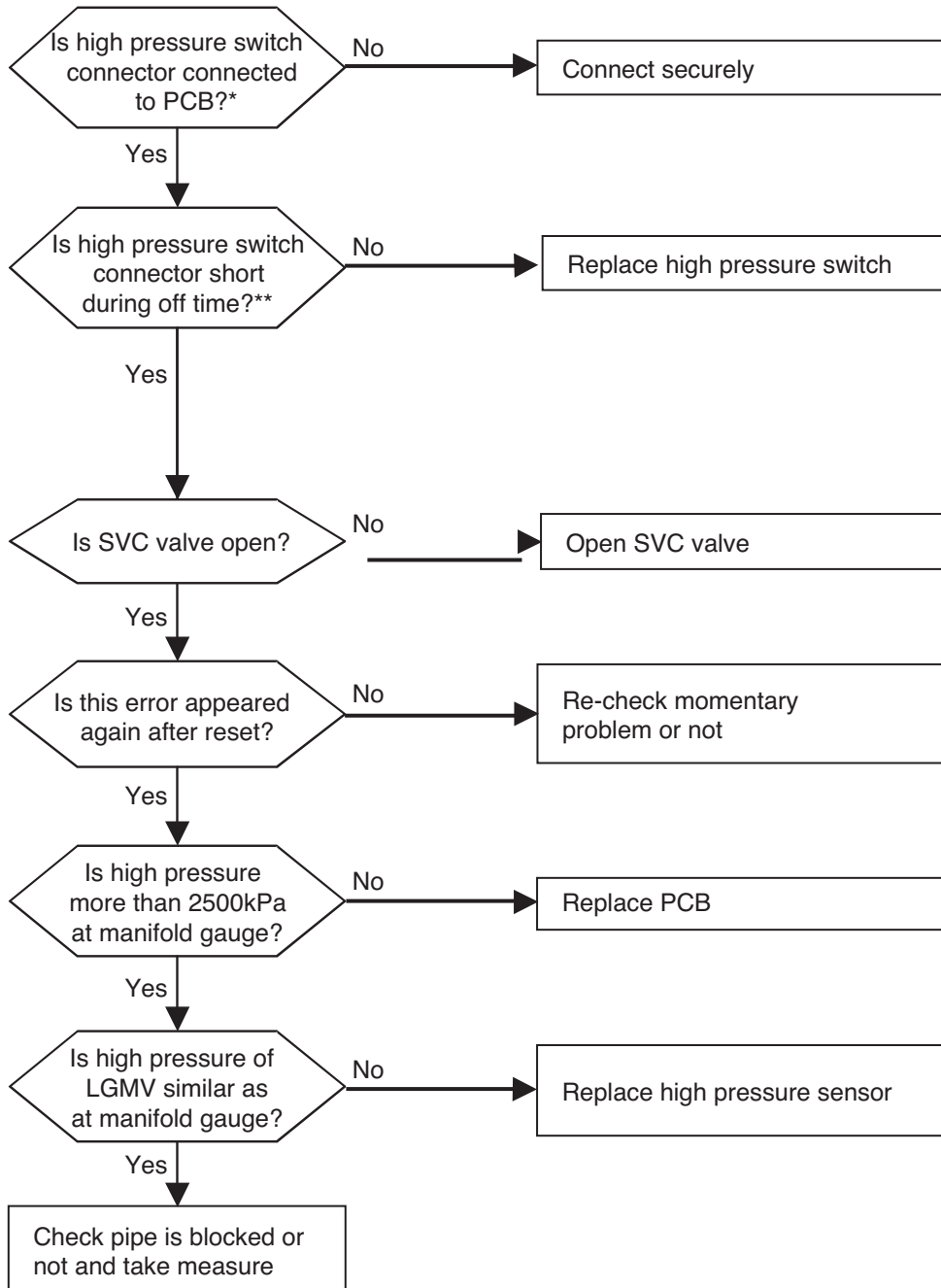

### Check Point

1. Check the connection of H/press switch
2. Check short or not at the connector of high pressure switch (Normal open)



< Main PCB : Connection Check Point >



< Checking the Press switch >

Display code	Title	Cause of error	Check point & Normal condition
25	Input voltage	<ul style="list-style-type: none"> <li>Abnormal Input voltage (140Vac , 300Vac)</li> </ul>	<ul style="list-style-type: none"> <li>Check the power source.</li> <li>Check the components.</li> </ul>

### ■ Error Diagnosis and Countermeasure Flow Chart

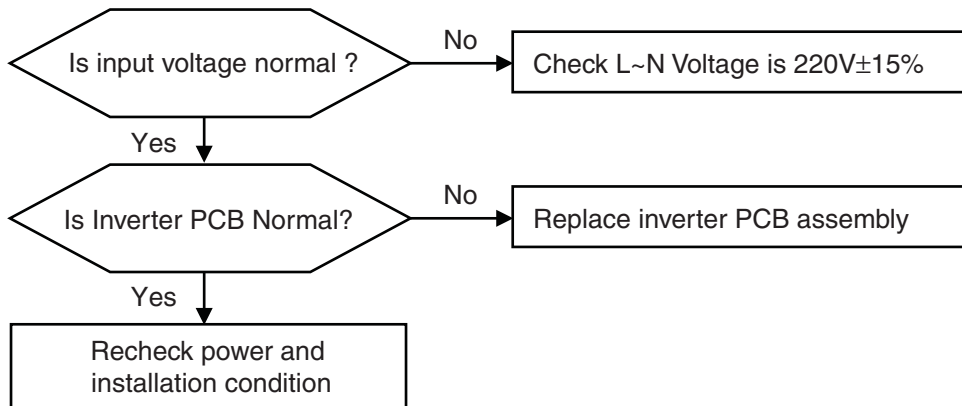

### Check Point

1. Check the Input Voltage (L-N → 220V±10%)
2. Check Input Voltage Sensor output voltage (2.5Vdc±10%)

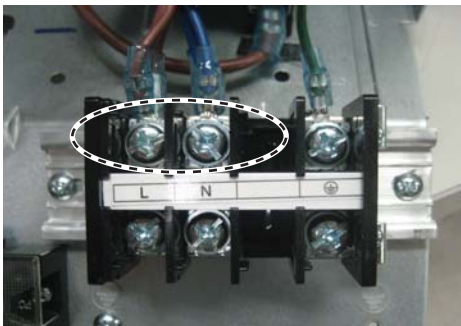

< Input Power Source Check Point >

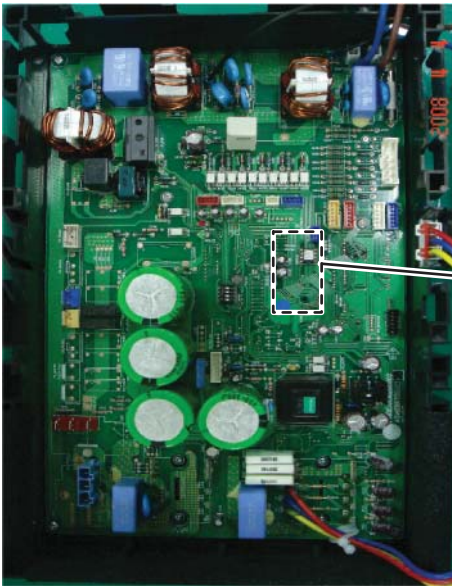

< Inverter PCB >

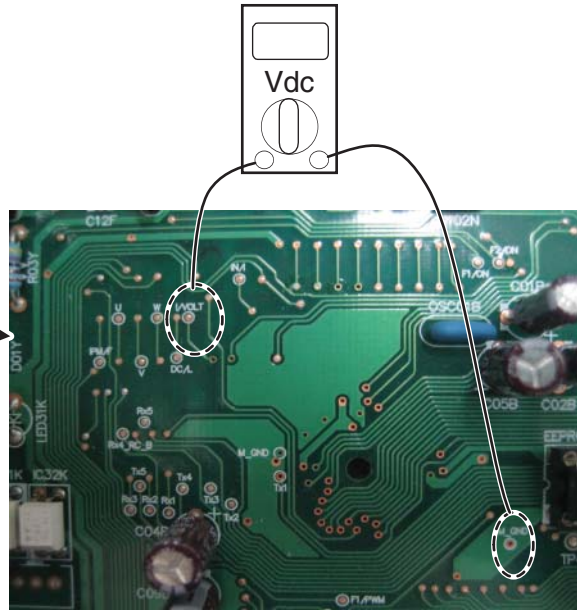

< Input Voltage Sensing Check Point >

Display code	Title	Cause of error	Check point & Normal condition
26	DC Compressor Position	<ul style="list-style-type: none"> <li>Compressor Starting fail error</li> </ul>	<ul style="list-style-type: none"> <li>Check the connection of comp wire "U,V,W"</li> <li>Malfunction of compressor</li> <li>Check the component of "IPM", detection parts.</li> </ul>

### ■ Error Diagnosis and Countermeasure Flow Chart

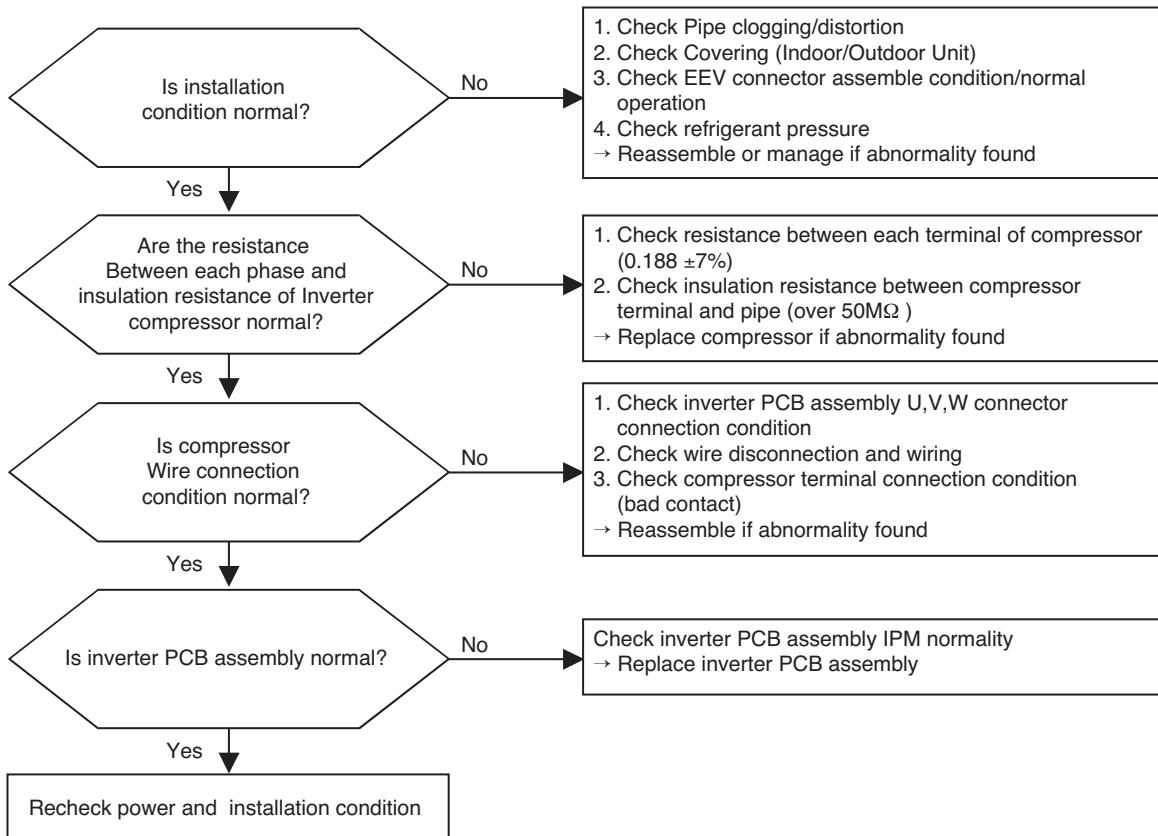

## 5. Trouble Shooting

Display code	Title	Cause of error	Check point & Normal condition
27	AC Input Instant over Current Error	Inverter PCB input current is over 100A(peak) for 2us	<ol style="list-style-type: none"> <li>1. Overload operation (Pipe clogging/Covering/EEV defect/Ref. overcharge)</li> <li>2. Compressor damage (Insulation damage/Motor damage)</li> <li>3. Input voltage abnormal (L,N)</li> <li>4. Power line assemble condition abnormal</li> <li>5. Inverter PCB assembly Damage (input current sensing part)</li> </ol>

### ■ Error Diagnosis and Countermeasure Flow Chart

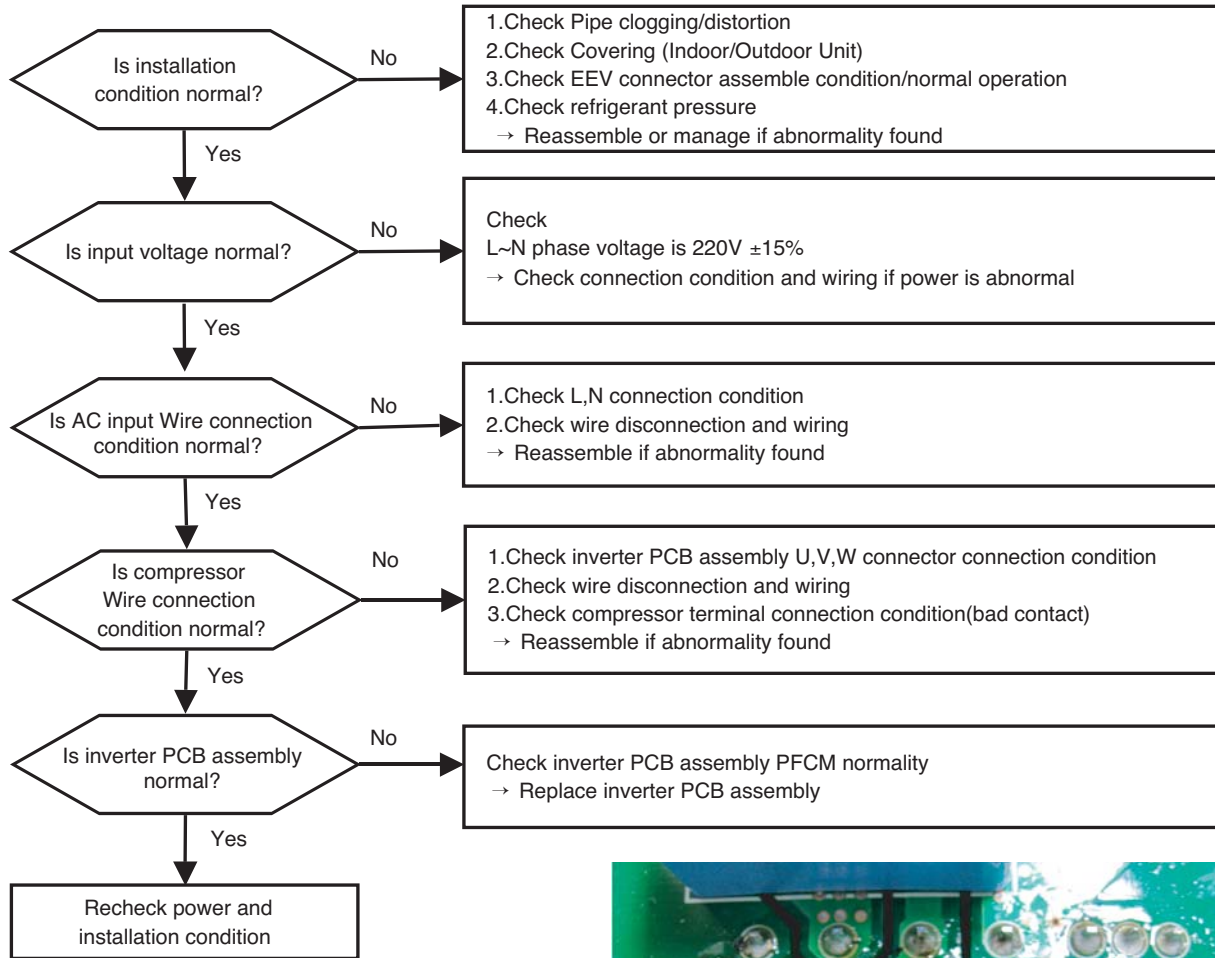

※ PFCM Module checking method

- ① Set the multi tester to diode mode.
- ② Check short between input signal pin which are placed below PFC Module
- ③ Replace PCB assembly if it is short between pins except No.4,5 pins.

### ⚠ CAUTION

PFCM module No.4,5 pins are internal short state.

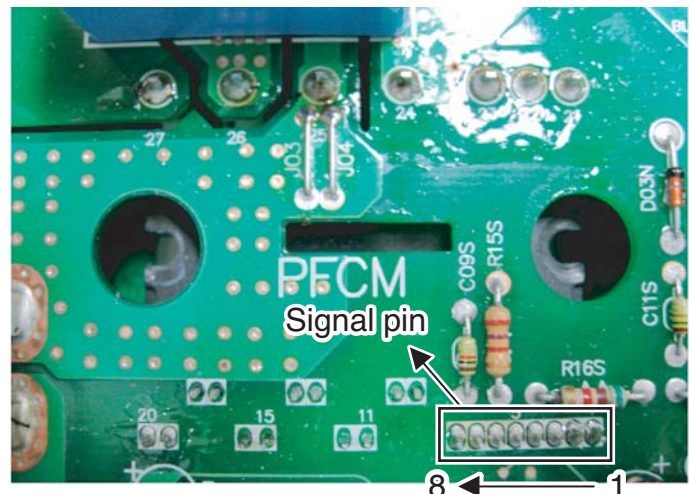

Display code	Title	Cause of error	Check point & Normal condition
28	Inverter DC link high voltage error	Inv PCB DC link voltage supplied over 420V	1. Input voltage abnormal (L~N) 2. ODU inverter PCB damage(DC Link voltage sensing part)

### ■ Error Diagnosis and Countermeasure Flow Chart

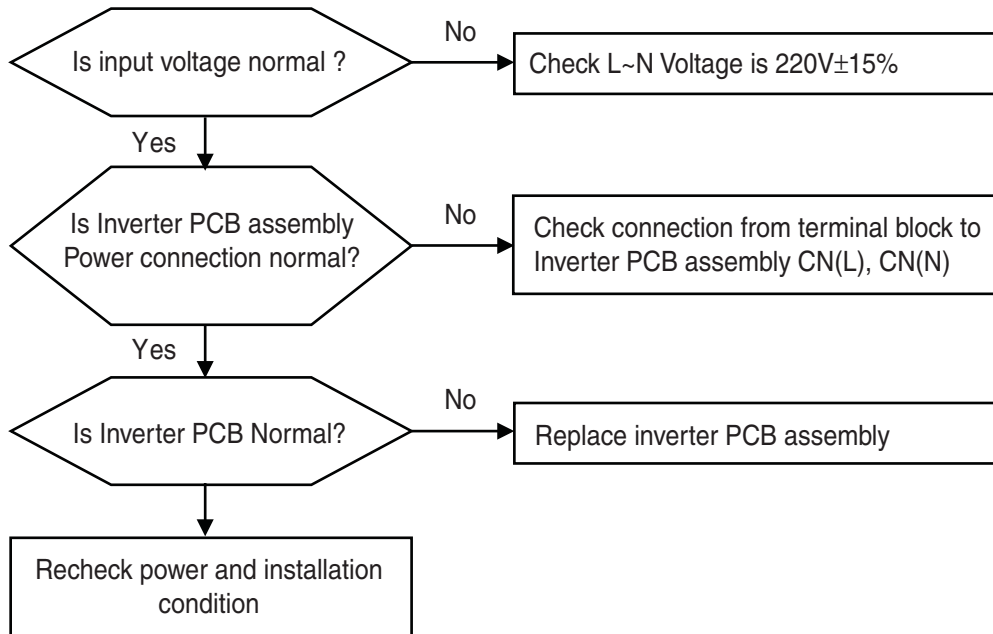

## 5. Trouble Shooting

### Check Point

1. Check the CN\_(L),CN\_(N) Connection condition at the Inverter PCB.(Refer to outdoor wiring diagram)
2. Check the DC Link voltage at not operating(280V ↑ )
3. Check the DC Link voltage at Comp operating(340V ↑ )
4. Check DC Link Sensing Signal : 2.4~2.8V (Refer the Picture)

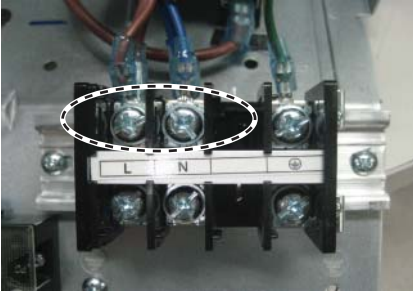

< Input Power Source Check Point >

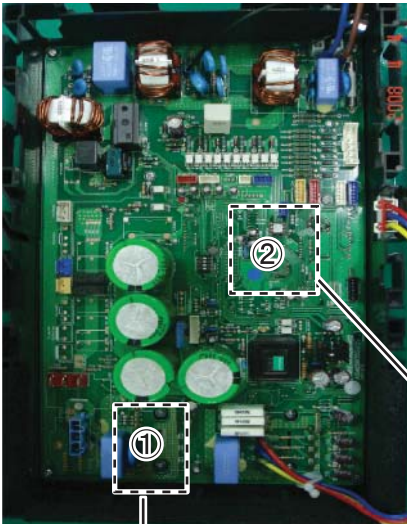

< Main PCB >

①

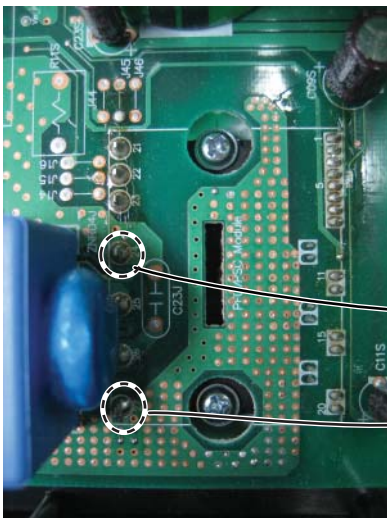

<DC Link Voltage Check Point>

②

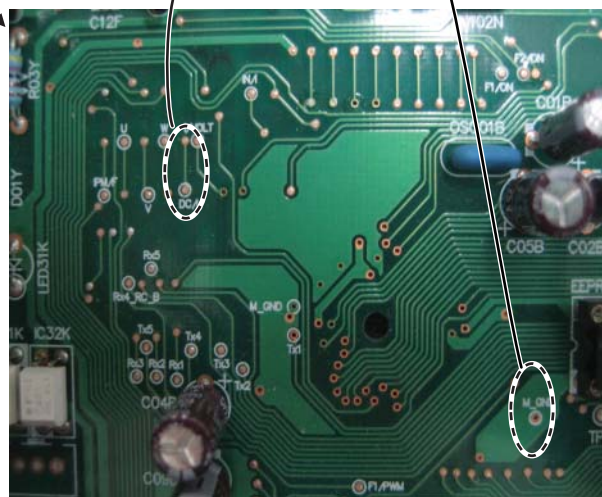

<DC\_LINK Sensing Check Point>

Display code	Title	Cause of error	Check point & Normal condition
29	Inverter compressor over current	Inverter compressor input current is over 30A	1. Overload operation (Pipe clogging/Covering/EEV defect/Ref. over-charge) 2. Compressor damage(Insulation damage/Motor damage) 3. Input voltage low 4. ODU inverter PCB assembly damage

■ Error Diagnosis and Countermeasure Flow Chart

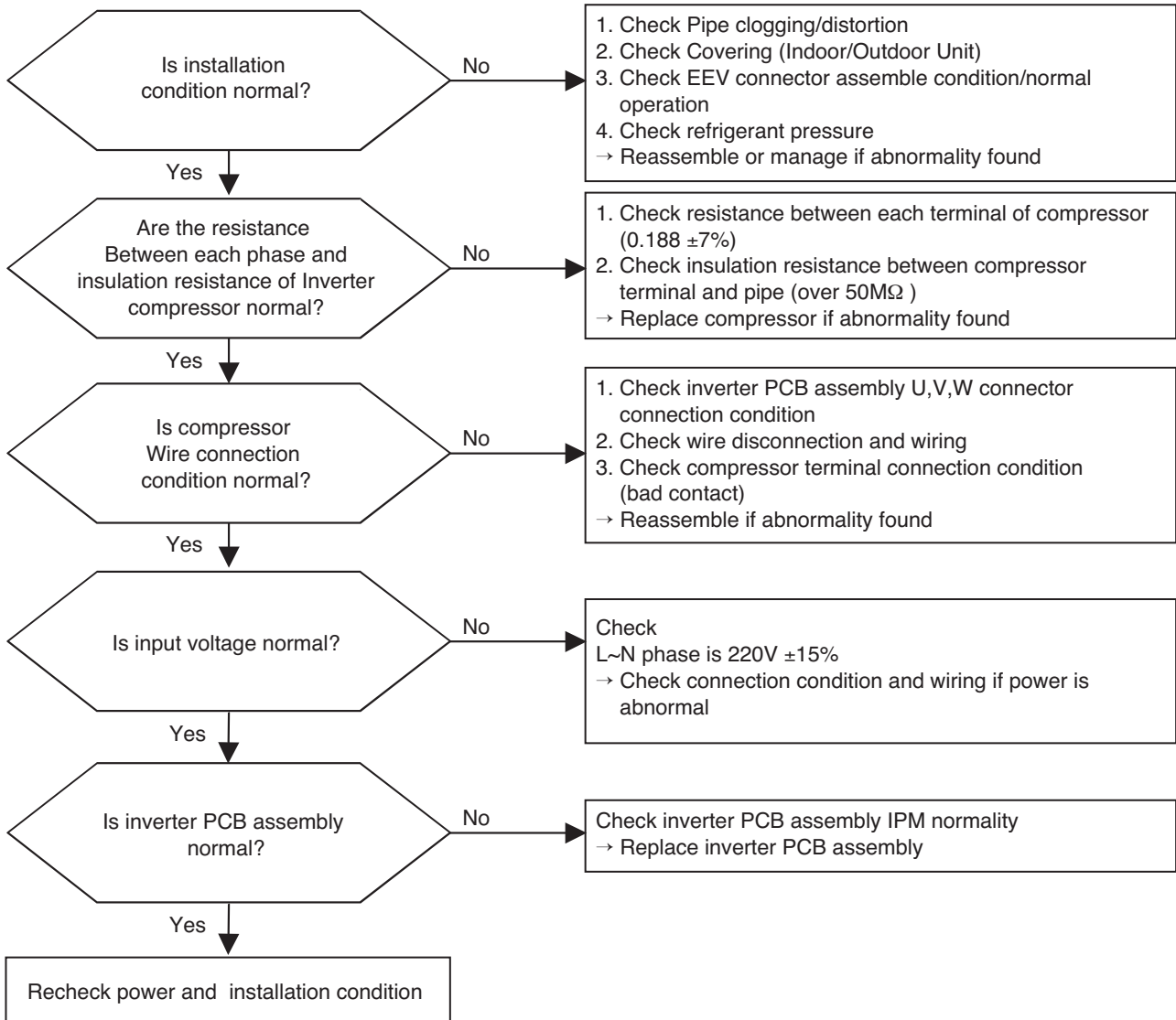

## 5. Trouble Shooting

Display code	Title	Cause of error	Check point & Normal condition
32	D-pipe (Inverter) temp. high (105°C ↑)	<ul style="list-style-type: none"> <li>Discharge sensor (Inverter) temp. high</li> </ul>	<ul style="list-style-type: none"> <li>Check the discharge pipe sensor for INV.</li> <li>Check the install condition for over load.</li> <li>Check the leakage of refrigerant.</li> <li>Check the SVC V/V open.</li> </ul>

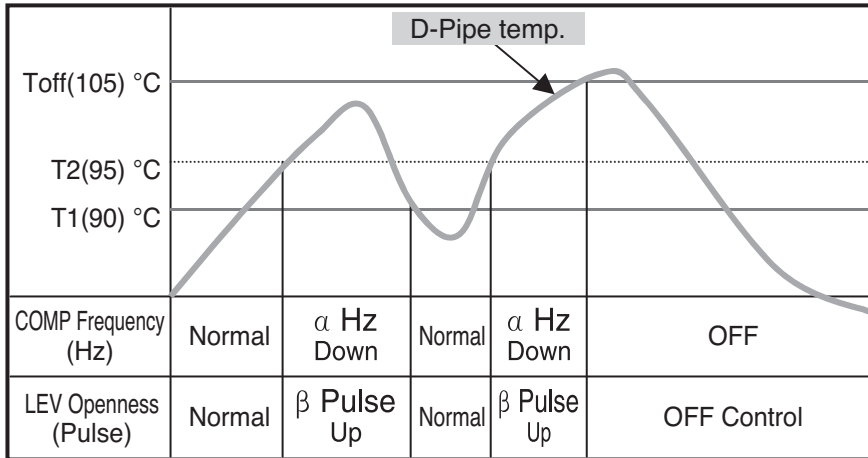

### Check Point

1. Check the install condition for over load.
2. Check the SVC V/V open.
3. Check the leakage of refrigerant.

Display code	Title	Cause of error	Check point & Normal condition
40	C/T Sensor Error	• Initial current error	<ul style="list-style-type: none"> <li>• Malfunction of current detection circuit. (Open / Short)</li> <li>• Check CT Sensor output voltage : 2.5Vdc <math>\pm</math>5%</li> </ul>

### ■ Error Diagnosis and Countermeasure Flow Chart

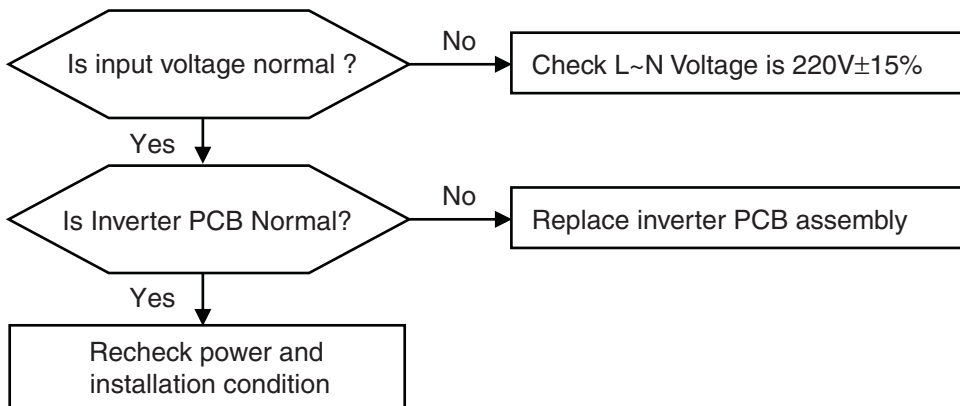

### Check Point

1. Check the Input Voltage (L-N  $\rightarrow$  220V $\pm$ 10%)
2. Check Input Voltage Sensor output voltage (2.5Vdc $\pm$ 10%)

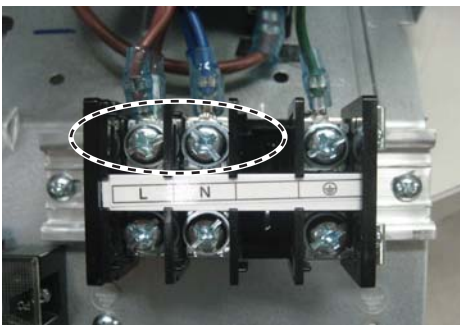

< Input Power Source Check Point >

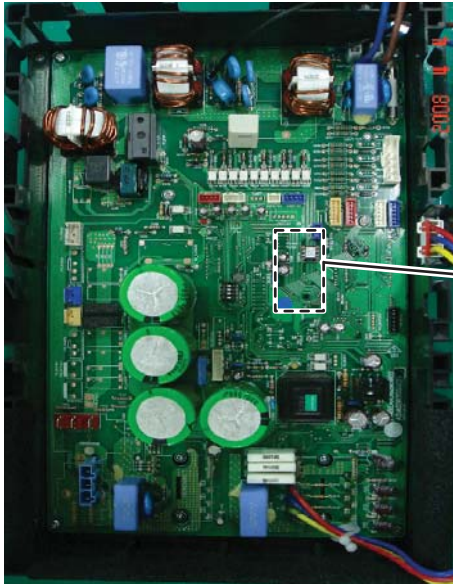

< Inverter PCB >

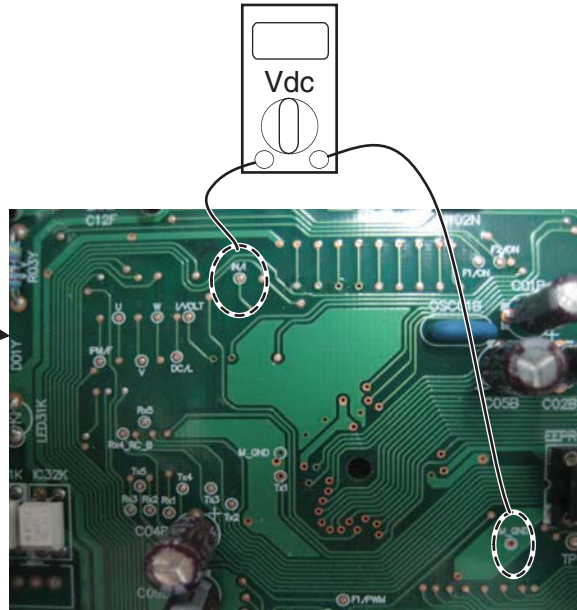

< CT Sensing Check Point >

Display code	Title	Cause of error	Check point & Normal condition
52	Transmission error between (Inverter PCB → Main PCB)	Main controller of Master unit of Master unit can't receive signal from inverter controller	1. Power cable or transmission cable is not connected 2. Defect of outdoor Main fuse/Noise Filter 3. Defect of outdoor Main / inverter PCB

■ Error diagnosis and countermeasure flow chart

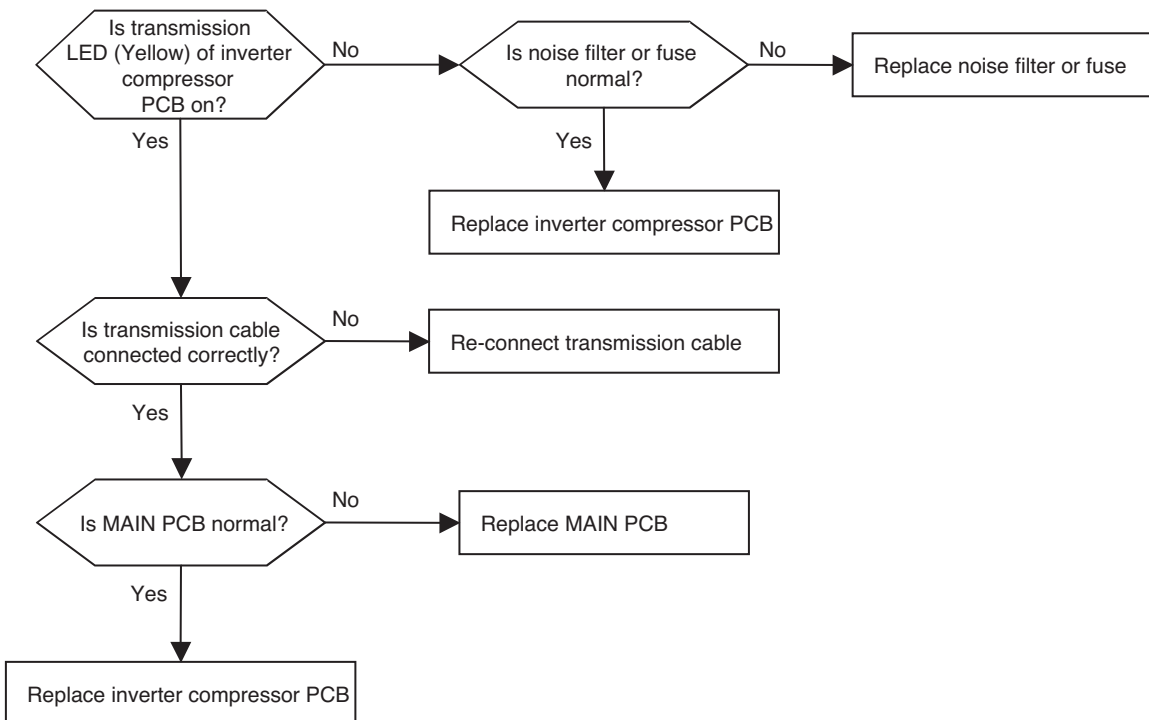

Display code	Title	Cause of error	Check point & Normal condition
41	D-pipe sensor (Inverter)	<ul style="list-style-type: none"> <li>• Open / Short</li> <li>• Soldered poorly</li> <li>• Internal circuit error</li> </ul>	<ul style="list-style-type: none"> <li>• Normal resistor : 200K<math>\Omega</math> / at 25°C (Unplugged)</li> <li>• Normal voltage : 4.5Vdc / at 25°C (plugged)</li> </ul>
44	Air sensor	<ul style="list-style-type: none"> <li>• Open / Short</li> <li>• Soldered poorly</li> <li>• Internal circuit error</li> </ul>	<ul style="list-style-type: none"> <li>• Normal resistor : 10K<math>\Omega</math> / at 25°C (Unplugged)</li> <li>• Normal voltage : 2.5Vdc / at 25°C (plugged)</li> </ul>
45	Condenser Pipe sensor	<ul style="list-style-type: none"> <li>• Open / Short</li> <li>• Soldered poorly</li> <li>• Internal circuit error</li> </ul>	<ul style="list-style-type: none"> <li>• Normal resistor : 5K<math>\Omega</math> / at 25°C (Unplugged)</li> <li>• Normal voltage : 2.5Vdc / at 25°C (plugged)</li> </ul>
46	Suction Pipe sensor	<ul style="list-style-type: none"> <li>• Open / Short</li> <li>• Soldered poorly</li> <li>• Internal circuit error</li> </ul>	<ul style="list-style-type: none"> <li>• Normal resistor : 5K<math>\Omega</math> / at 25°C (Unplugged)</li> <li>• Normal voltage : 2.5Vdc / at 25°C (plugged)</li> </ul>
65	Heat sink sensor	<ul style="list-style-type: none"> <li>• Open / Short</li> <li>• Soldered poorly</li> <li>• Internal circuit error</li> </ul>	<ul style="list-style-type: none"> <li>• Normal resistor : 10K<math>\Omega</math> / at 25°C (Unplugged)</li> <li>• Normal voltage : 2.5Vdc / at 25°C (plugged)</li> </ul>

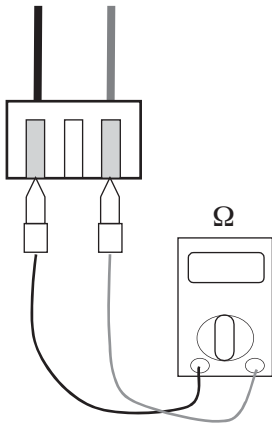

### Check Point

1. Estimate the resistance of each sensor.(Unplugged)
2. Estimate the voltage of each sensor.(Plugged)
3. If the resistance of the sensor is 0 k $\Omega$  or  $\infty$ , then sensor is abnormal.  
If the voltage of the sensor is 0 V or 5Vdc, then sensor is abnormal.

## 5. Trouble Shooting

---

Display code	Title	Cause of error	Check point & Normal condition
51	Over capacity	<ul style="list-style-type: none"><li>• Over capacity Combination</li></ul>	<ul style="list-style-type: none"><li>• Check the indoor unit capacity.</li><li>• Check the combination table.</li></ul>

Model	Gross max. capacity	Max. single indoor unit capacity
A2UW183FA2	28k	12k
A3UW243FA2	36k	18k
A4UW363FA1 A4UW363FA2	55k	

### Check Point

1. Check the indoor unit capacity.

Display code	Title	Cause of error	Check point & Normal condition
60	Inverter PCB & Main EEPROM check sum error	EEPROM Access error and Check SUM error	1. EEPROM contact defect/wrong insertion 2. Different EEPROM Version 3. ODU Inverter & Main PCB assembly damage

**■ Error Diagnosis and Countermeasure Flow Chart**

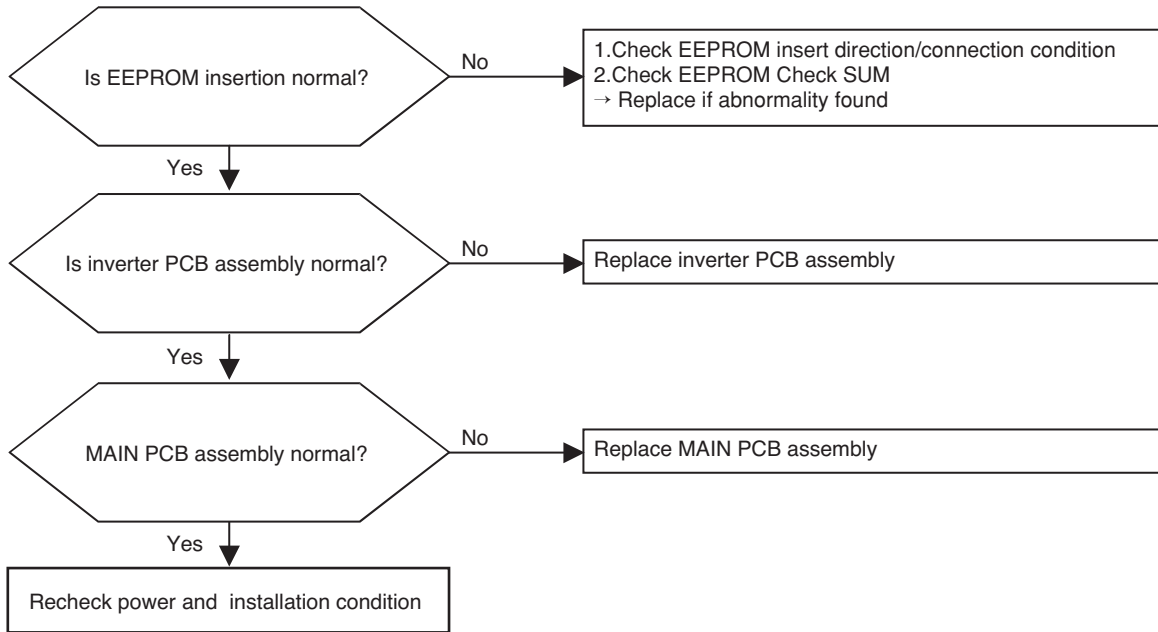

**Check Point**

- Check the EEPROM Check sum & Direction

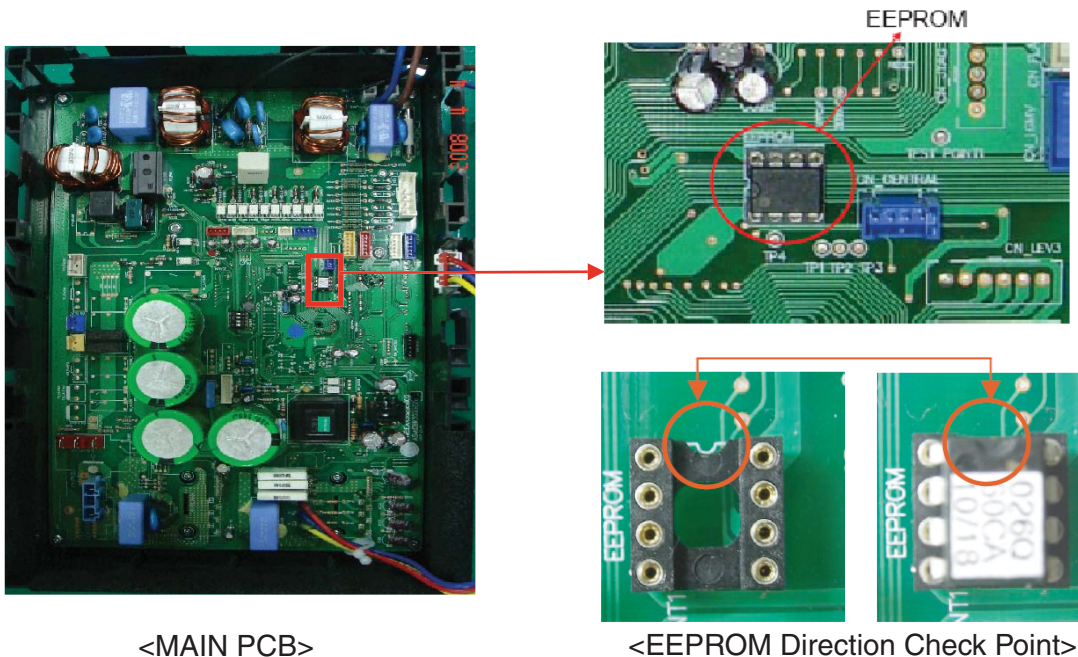

## 5. Trouble Shooting

---

Display code	Title	Cause of error	Check point & Normal condition
61	Condenser pipe sensor temp. high	<ul style="list-style-type: none"><li>• Condenser pipe sensor detected high temp.</li></ul>	<ul style="list-style-type: none"><li>• Check the load condition.</li><li>• Check the sensor of Condenser pipe sensor.</li></ul>

### Check Point

- Check the install condition for over load.  
(Refrigerant, Pipe length, Blocked, ...)

Display code	Title	Cause of error	Check point & Normal condition
62	Heatsink High error	Inverter PCB heatsink temperature is over 85°C	2. ODU fan locking 3. Heatsink assembly of INV PCB assemble condition abnormal 4. Defect of temperature sensing circuit part defect of INV PCB

### ■ Error Diagnosis and Countermeasure Flow Chart

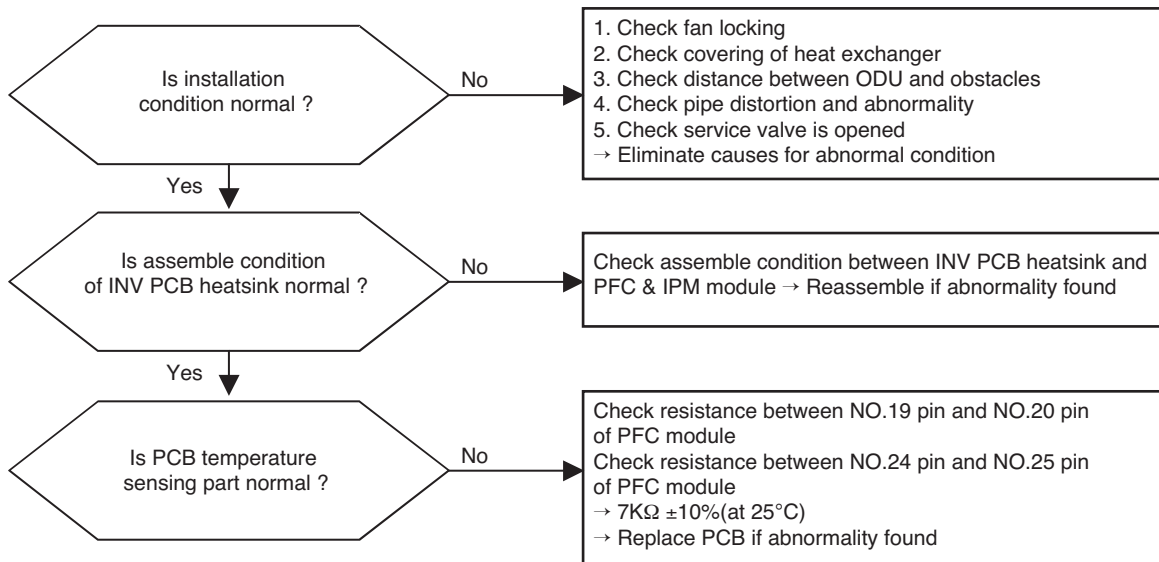

### Check Point

1. Check resistance between No.19 pin and NO.20 pin of PCB PFC module
2. Check resistance between No.24 pin and NO.25 pin of PCB PFC module - only 48/56k
3. Resistance value should be in 7kΩ ±10%.(at 25°C).

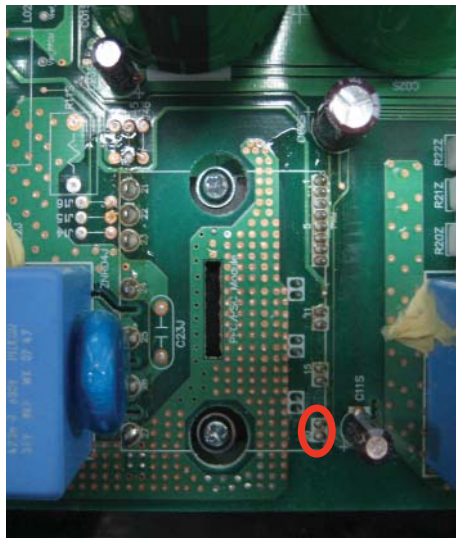

PFCM :  
Measuring resistance  
between No.19,20 pin

## 5. Trouble Shooting

Display code	Title	Cause of error	Check point & Normal condition
65	Heatsink High error	Inverter PCB heatsink sensor is open or short	1. ODU fan locking 2. Heatsink assembly of INV PCB assemble condition abnormal 3. Defect of temperature sensing circuit part defect of INV PCB

### ■ Error Diagnosis and Countermeasure Flow Chart

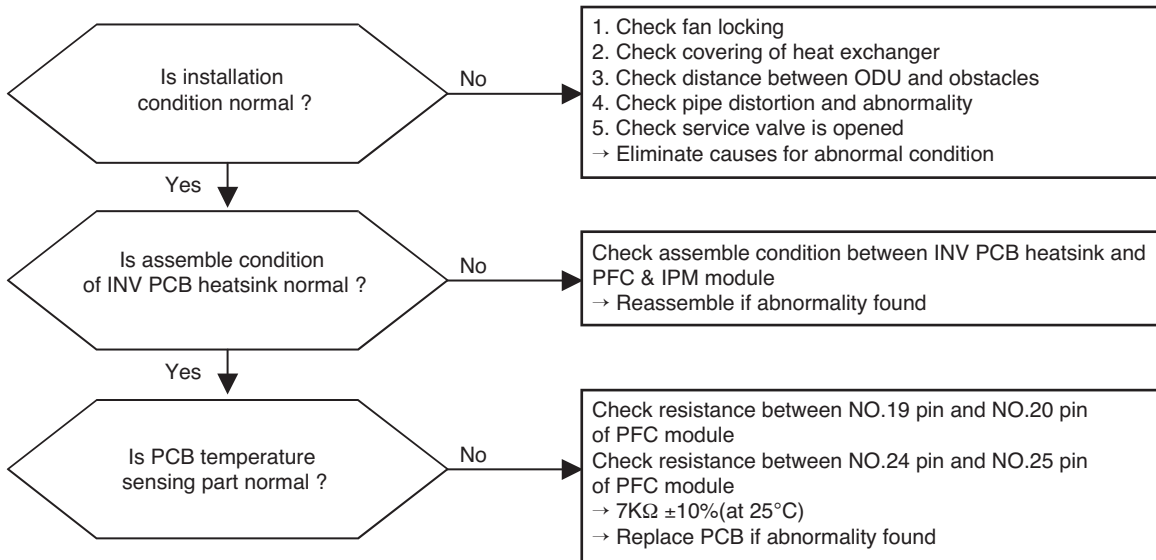

### Check Point

1. Check resistance between No.19 pin and NO.20 pin of PCB PFC module
2. Check resistance between No.24 pin and NO.25 pin of PCB PFC module - only 48/56k
3. Resistance value should be in  $7k\Omega \pm 10\%$ .(at 25°C).
4. Check the PFC Module No.19, 20 and IPM Module No.24, 25 pin soldering condition.

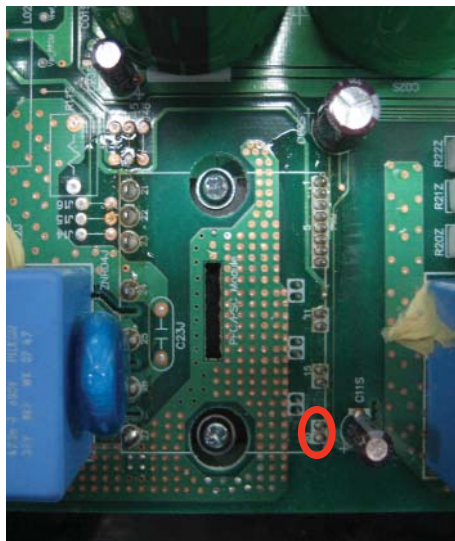
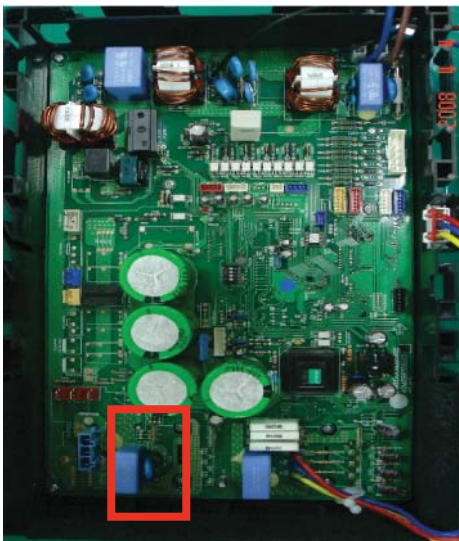

PFCM :  
Measuring resistance  
between No.19,20 pin

Display code	Title	Cause of error	Check point & Normal condition
67	Fan Lock Error	Fan RPM is 10RPM or less for 5 sec. when ODU fan starts or 40 RPM or less after fan starting.	1. ODU fan locking 2. Heatsink assembly of INV PCB assemble condition abnormal 3. Defect of temperature sensing circuit part defect of INV PCB

**■ Error Diagnosis and Countermeasure Flow Chart**

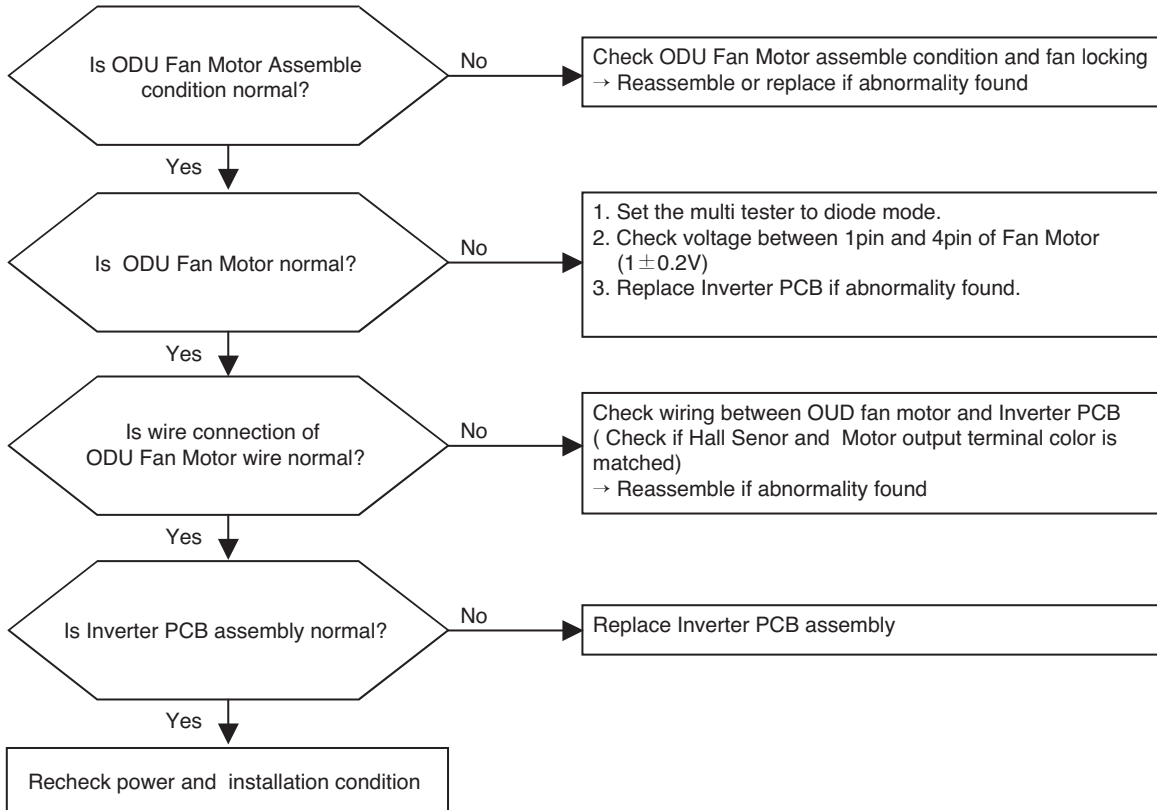

**Check Point**

1. Check voltage between 1pin and 4pin of Fan Motor connector (Tester diode mode)
2. Voltage value should be in 1V ± 0.2V.

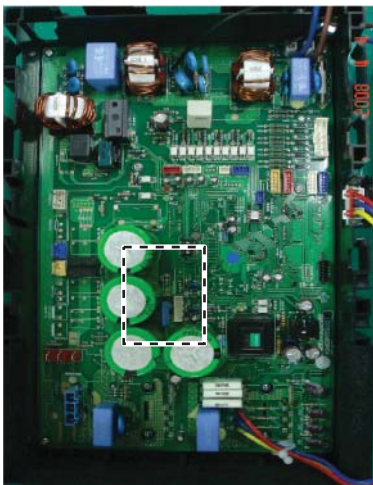

<Main PCB>

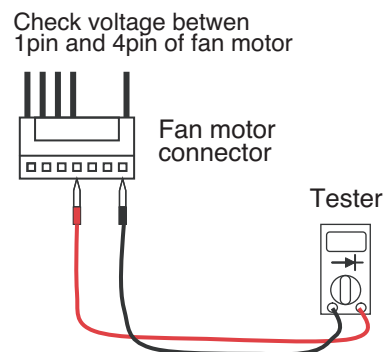

## 5. Trouble Shooting

Display code	Title	Cause of error	Check point & Normal condition
73	AC input instant over current error (Matter of software)	Inverter PCB input power current is over 48A(peak) for 2ms	<ol style="list-style-type: none"> <li>1. Overload operation (Pipe clogging/Covering/EEV defect/Ref.overcharge)</li> <li>2. Compressor damage (Insulation damage/Motor damage)</li> <li>3. Input voltage abnormal (L, N)</li> <li>4. Power line assemble condition abnormal</li> <li>5. Inverter PCB assembly damage (input current sensing part)</li> </ol>

### ■ Error Diagnosis and Countermeasure Flow Chart

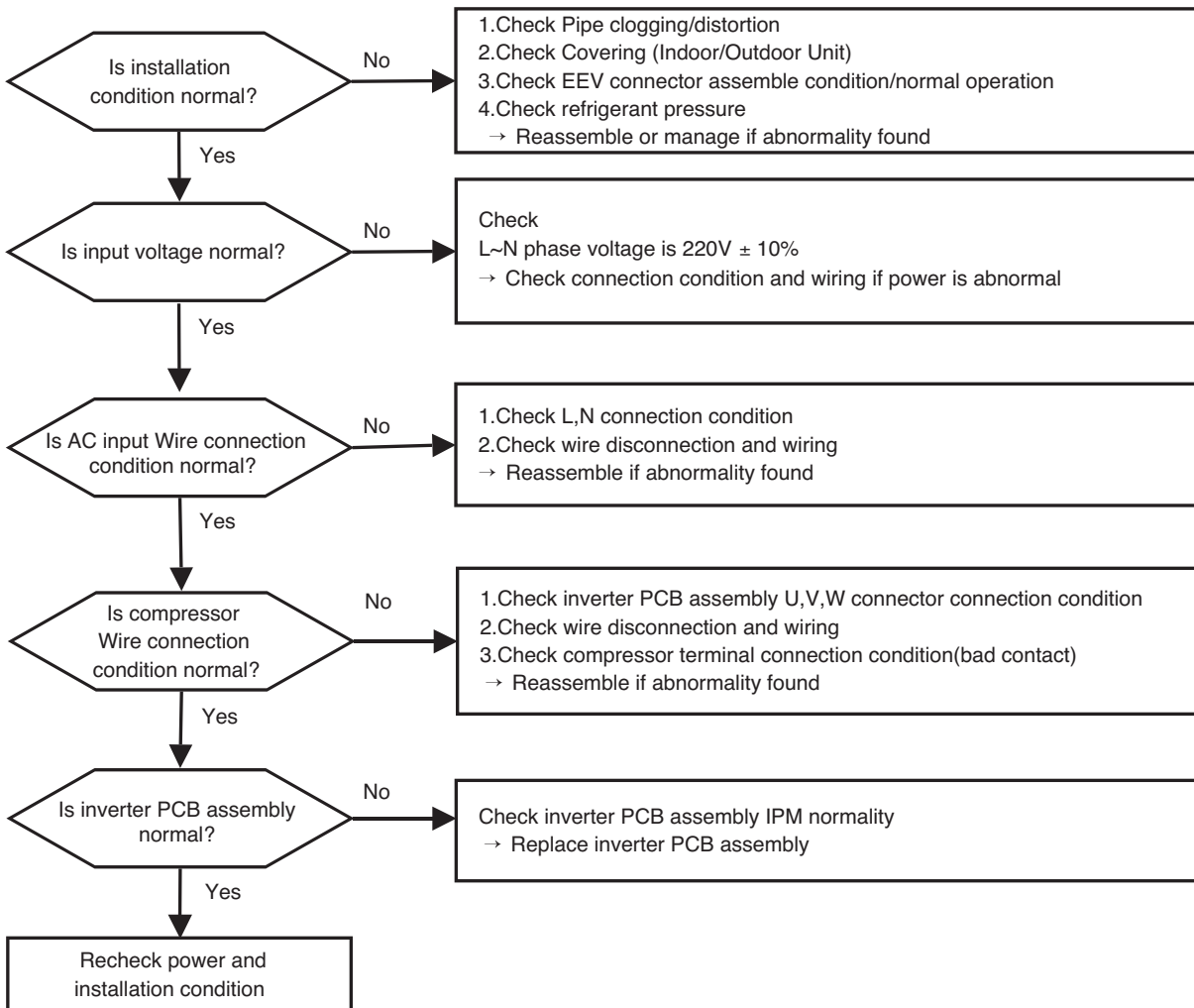

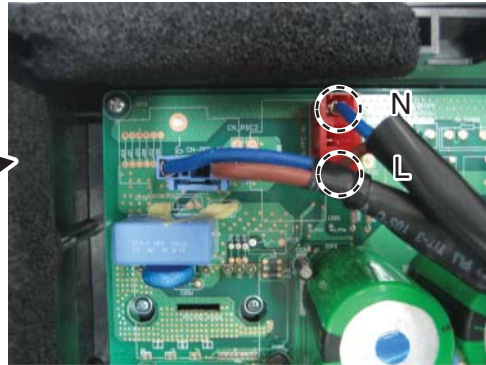
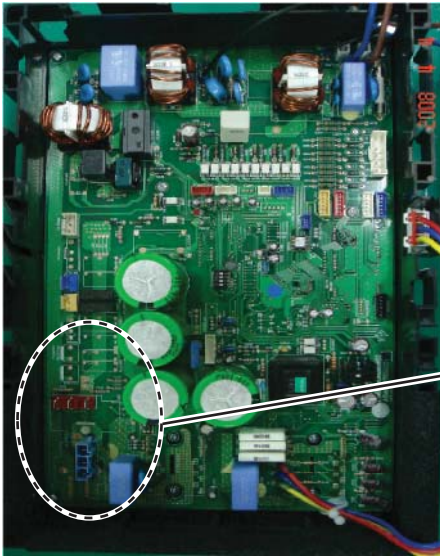

< Main PCB wiring Check Point >

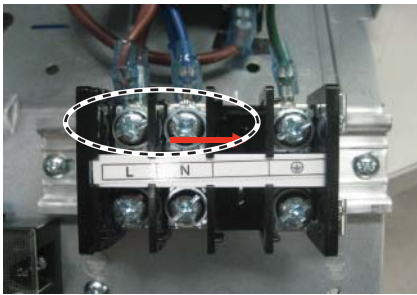

< Input Power Source Check Point >



P/NO : MFL63744402

NOVEMBER, 2010