

**HUSSmann**<sup>®</sup>/CHINO

Installation  
& Operation  
Manual

**SFG/SFNG**

**LOW/MEDIUM TEMP MERCHANDISER  
SELF-SERVICE**

**REV. 0825**

**HUSSmann**<sup>®</sup>

**SFG/SFNG  
LOW/MEDIUM TEMP MERCHANDISER  
SELF-SERVICE BAKERY**



---

**INSTALLATION & OPERATION GUIDE**

General Instructions

Table of Contents

General Instructions.....2
Cut and Plan Views .....3
Cut and Plan Views (Cont'd).....4
Installation.....5
Location ..... 5
Uncrating the Stand..... 5
Exterior Loading ..... 5
Setting and Joining ..... 5
Leveling ..... 5
Corner Wedges ..... 6
Joint Trim ..... 6
Bumper Installation Instructions ..... 6
Plumbing .....7
Waste Outlet and P-TRAP..... 7
Installing Condensate Drain ..... 7
Refrigeration .....7
Refrigerant Type ..... 7
Refrigeration Lines ..... 7
Control Settings ..... 7
Access to TX Valves and Drain Lines..... 7
Electronic Expansion Valve (Optional) ..... 8
Thermostatic Expansion Valve Location..... 8
Expansion Valve Adjustment ..... 8
Measuring the Operating Superheat ..... 8
T-STAT Location ..... 8
Piping..... 8
Refrigeration Data SFG ..... 9
Refrigeration Data SFNG ..... 10
Electrical.....11
Wiring Color Code .....11
Electrical Circuit Identification.....11
Electrical Service Receptacles (When Applicable) .....11
Ballast Location .....11
Field Wiring and Serial Plate Amperage.....11
Ashrae Color Code.....11
Rear Close-off Panel .....11
User Information.....12
Stocking..... 12
Important Steps ..... 12
Case Cleaning ..... 12
Stainless Steel Cleaning and Care..... 13
Cleaning Mirrors ..... 14
Cleaning Glass and Mirrors ..... 14
Non-Glare Glass..... 14
Plexiglass and Acrylic Care ..... 14
Cleaning ..... 14
Antistatic Coatings..... 14
Maintenance.....15
Evaporator Fans ..... 15
Copper Coils..... 15
Tips and Troubleshooting ..... 15
Electrical Wiring Diagram Index.....16
Electrical Wiring Diagrams .....17
Troubleshooting Guide .....31
Troubleshooting (Cont'd).....32
Appendices .....33

This Booklet Contains Information on:

Model Descriptions

All models are available in either 48", 60" lengths.

SFG-SFNG- Refrigerated Specialty Frozen Glass Self-Service Bakery Case with 1 or 2 tier merchandising, and rear signage.

SFG-SFNG- Refrigerated Specialty Frozen Glass Self-Service Bakery Case with 1 or 2 tier merchandising, and rear signage. Remote unit requires separate condenser unit connection. Low Temperature Model (SFG/SFNG).

Application

These service-type merchandisers have been specifically designed for bakery departments. The front glass provides complete product visibility.

The SFG-SFNG- Refrigerated model, is designed to display fresh bakery products that have fast turnover and require no refrigeration. The SFG-SFNG- remote and SFG-SFNG- self-contained, refrigerated bakery merchandisers are designed for use only in air conditioned stores where temperature and humidity are maintained at or below 75°F dry bulb temperature and 55% relative humidity.

Shipping Damage

All equipment should be thoroughly examined for shipping damage before and during unloading.

This equipment has been carefully inspected at our factory and the carrier has assumed responsibility for safe arrival. If damaged, either apparent or concealed, claim must be made to the carrier.

Apparent Loss or Damage

If there is an obvious loss or damage, it must be noted on the freight bill or express receipt and signed by the carrier's agent; otherwise, carrier may refuse claim. The carrier will supply necessary claim forms.

Concealed Loss or Damage

When loss or damage is not apparent until after equipment is uncrated, a claim for concealed damage is made. Make request in writing to carrier for inspection within 15 days, and retain all packaging. The carrier will supply inspection report and required claim forms.

Keep this booklet with the case at all times for future reference.

HUSSMANN®/CHINO

A publication of HUSSMANN® Chino
13770 Ramona Avenue • Chino, California 91710
(909) 628-8942 FAX
(909) 590-4910
(800) 395-9229

Attention Installer icon: A triangle containing a hand holding a wrench. Text: This equipment is to be installed to comply with the applicable NEC, Federal, State, and Local Plumbing and Construction Code having jurisdiction.

**General Instructions (Cont'd)**

**Shortages**

Check your shipment for any possible shortages of material. If a shortage should exist and is found to be the responsibility of Hussmann Chino, *notify Hussmann Chino*. If such a shortage involves the carrier, *notify the carrier immediately*, and request an inspection. Hussmann Chino will acknowledge shortages within ten days from receipt of equipment.

**Hussmann Chino Product Control**

The serial number and shipping date of all equipment has been recorded in Hussmann's files for warranty and replacement part purposes. All correspondence pertaining to warranty or parts ordering must include the serial number of each piece of equipment involved, in order to provide the customer with the correct parts.

**Cut and Plan Views**

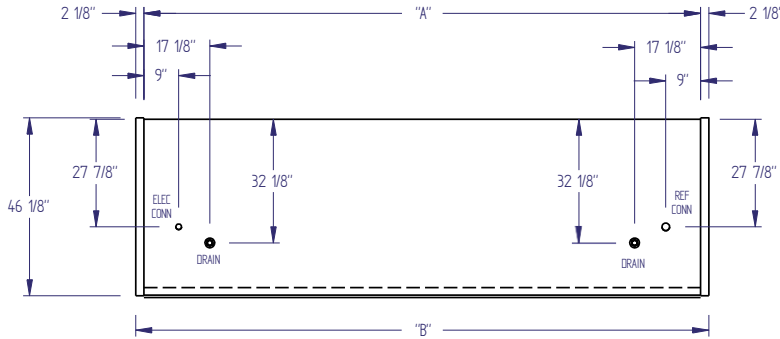

CASE SIZE	DIM [A] in	DIM [B] in
SFG-4	48 1/8	52 3/8
SFG-5	59 3/4	64
SFG-6	72 3/16	76 7/16
SFG-8	96 1/4	100 1/2
SFG-12	144 3/8	148 5/8

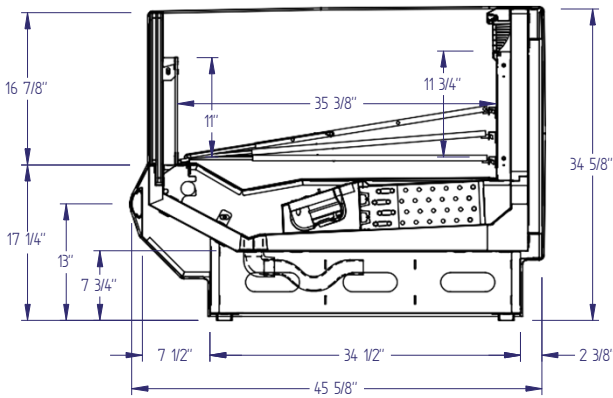

SFG W/ SGB BODY MATCH

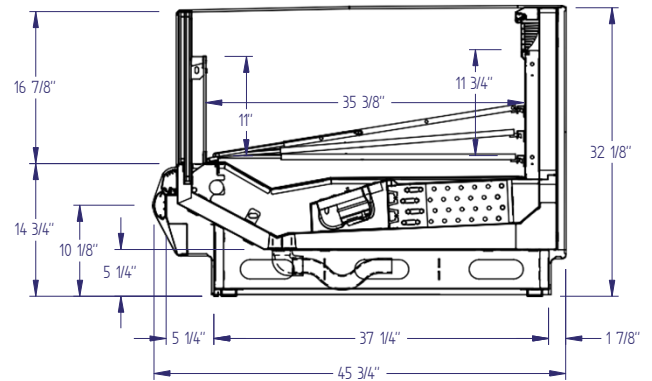

SFG W/ ISLA BODY MATCH

Cut and Plan Views (Cont'd)

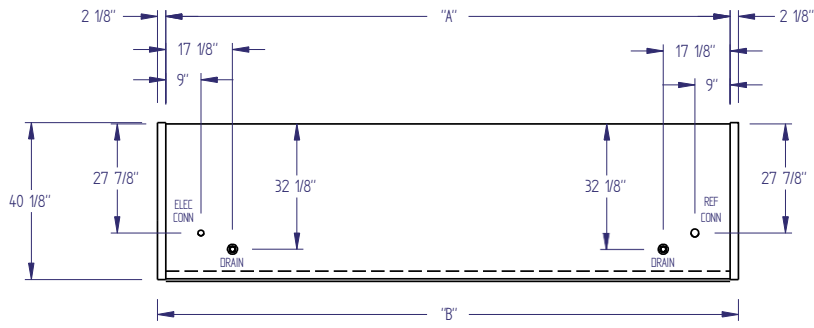

CASE SIZE	DIM [A] in	DIM [B] in
SFNG-4	48 1/8	52 3/8
SFNG-5	59 3/4	64
SFNG-6	72 3/16	76 7/16
SFNG-8	96 1/4	100 1/2
SFNG-12	144 3/8	148 5/8

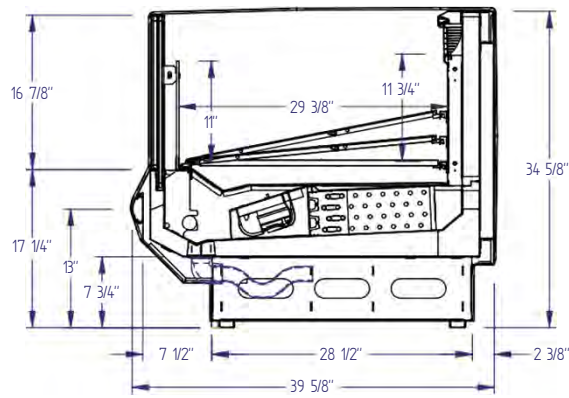

SFNG W/ SGB BODY MATCH

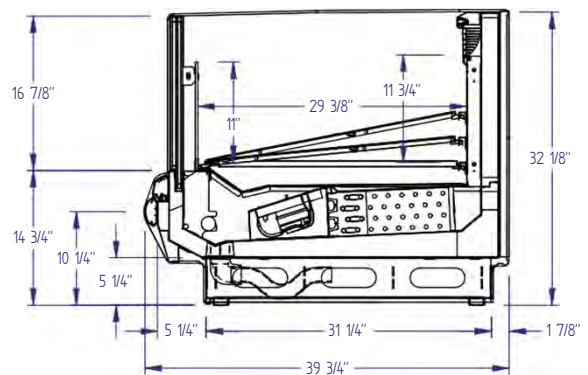

SFNG W/ ISLA BODY MATCH

## Installation

### Location

The refrigerated merchandisers have been designed for use only in air conditioned stores where temperature and humidity are maintained at or below 75°F and 55% relative humidity. DO NOT allow air conditioning, electric fans, ovens, open doors or windows (etc.) to create air currents around the merchandiser, as this will impair its correct operation.

Product temperature should always be maintained at a constant and proper temperature. This means that from the time the product is received, through storage, preparation and display, the temperature of the product must be controlled to maximize life of the product.

### Uncrating the Stand

Place the fixture as close to its permanent position as possible. Remove the top of the crate. Detach the walls from each other and remove from the skid. Unbolt the case from the skid. The fixture can now be lifted off the crate skid. **Lift only at base of stand!**

### Exterior Loading

These models have **not** been structurally designed to support excessive external loading. **Do not walk on their tops;** This could cause serious personal injury and damage to the fixture.

### Setting and Joining

The sectional construction of these models enable them to be joined in line to give the effect of one continuous display. A joint trim kit is supplied with each joint.

### Leveling

**IMPORTANT! IT IS IMPERATIVE THAT CASES BE LEVELED FROM FRONT TO BACK AND SIDE TO SIDE PRIOR TO JOINING. A LEVEL CASE IS NECESSARY TO INSURE PROPER OPERATION, WATER DRAINAGE, GLASS ALIGNMENT AND OPERATION OF THE HINGES SUPPORTING THE GLASS. LEVELING THE CASE CORRECTLY WILL SOLVE MOST HINGE OPERATION PROBLEMS.**

**NOTE:** A. To avoid removing concrete flooring when installing long lineups, begin lineup leveling from the highest point of the store floor.

B. When wedges are involved in a lineup, set them first.

All cases were leveled and joined prior to shipment to insure the closest possible fit when cases are joined in the field. When joining, use a carpenters level and shim legs accordingly. Case must be raised correctly, under legs where support is best, to prevent damage to case.

1. Check floor where cases are to be set to determine the highest point of the floor; cases will be set off this point.

2. Set first case, and adjust legs over the highest part of the floor so that case is level. Prevent damage - case must be raised under leg or by use of 2x6 or 2x4 leg brace. Remove side and back leg braces after case is set.
3. Set second case as close as possible to the first case, and level case to the first using the instructions in step one.
4. Apply masking tape 1/8" in from end of case on inside and outside rear mullion on both cases to be joined.
5. Apply liberal bead of case joint sealant (butyl) to (dotted area shown in figure) first case. Apply heavy amount to cover entire shaded area.

**DO NOT USE PERMAGUM!**



**ATTENTION  
INSTALLER**

**This equipment is to be installed to comply with the applicable NEC, Federal, State, and Local Plumbing and Construction Code having jurisdiction.**

6. Slide second case up to first case snugly. Then level second case to the first case so glass front, bumper and top are flush.
7. To compress butyl at joint, use two Jurgenson wood clamps. Make sure case is level from front to back and side to side on inside bulkheads at joint.
8. Attach sections together via a 2 bolts located in the base of the case. Secure the overhead structure by bolting the bracket, located inside behind lights.



**CAUTION**

**Do not use cam locks to pull cases together.**

9. Apply bead of butyl to top of bulkheads and slip on stainless steel bulkhead cap. Also apply butyl to seam between overhead light tubes.
10. **VERY IMPORTANT!** Apply liberal amounts of black butyl to area under interior lower legs and fill all voids down to bulkhead.
11. Use finger to smooth butyl as thin as possible at masking tape on inside and outside of rear mullion (apply additional butyl if necessary). Remove tape applied on line #3.

### Installation (Cont'd)

#### Corner Wedges

Corner wedges are attached via front and rear camlocks. Use a 7mm Allen wrench to turn the locks. Do not over-tighten! Join the top by using a joint bracket (included in joint kit) with 3/8" bolts.

#### Joint Trim

After cases have been leveled and joined and refrigeration, electrical, and wasted piping work completed, install the splashguards. Fasten along the top edge or center, with #10 X 3/8" sheet metal screws.

**DO NOT SEAL JOINT TRIM TO FLOOR!**

#### Bumper Installation Instructions



Step 1: Make sure the aluminum channel and end caps are installed.



Step 2: Use silicone lubricant to help the bumper slide into the channel.



Step 3: Starting on one end: while inserting the bumper, push it up against the end cap to prevent the bumper from shrinking after installation (when it gets cold).



Step 4: As you insert the bumper into the channel with one hand, pull the bumper toward you with the other to open the inside lips. Slowly apply pressure by rolling the bumper into the track.

## Plumbing

### Waste Outlet and P-TRAP

The waste outlet is located off the center of the case, on one side allowing drip piping to be run lengthwise under the fixture.

P-traps must be installed at the base of all refrigerated cases. The 1 ½" P-TRAPS and threaded adapters must be installed to prevent air leakage and insect entrance into the fixture.

### Installing Condensate Drain

Poorly or improperly installed condensate drains can seriously interfere with the operation of this refrigerator and result in costly maintenance and product losses. Please follow the recommendations listed below when installing condensate drains to insure a proper installation:

1. Never use pipe for condensate drains smaller than the nominal diameter of the pipe or P-TRAP supplied with the case.
2. When connecting condensate drains, the P-TRAP must be used as part of the condensate drain to prevent air leakage or insect entrance. Store plumbing system floor drains should be at least 14" off the center of the case to allow use of the P-TRAP pipe section. Never use two water seals in series in any one line. Double P-TRAPS in series will cause a lock and prevent draining.
3. Always provide as much down hill slope ("fall") as possible; 1/8" per foot is the preferred minimum. PVC pipe, when used, must be supported to maintain the 1/8" pitch and to prevent warping.

4. Avoid long runs of condensate drains. Long runs make it impossible to provide the "fall" necessary for good drainage.
5. Provide a suitable air break between the flood rim of the floor drain and outlet of condensate drain. 1" is ideal.
6. Prevent condensate drains from freezing:
  - a. Do not install condensate drains in contact with non-insulated suction lines. Suction lines should be insulated with a nonabsorbent insulation material such as Armstrong's Armaflex.
  - b. Where condensate drains are located in dead air spaces (between refrigerators or between a refrigerator and a wall), provide means to prevent freezing. The water seal should be insulated to prevent condensation.

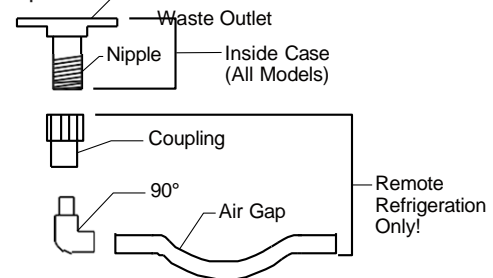

## Refrigeration

### Refrigerant Type

The standard refrigerant will be R-404A unless otherwise specified on the customer order. Check the serial plate on the case for information.

### Refrigeration Lines

Liquid	Suction
3/8" O.D.	5/8" O.D.

**NOTE:** The standard coil is piped at 5/8" (suction); however, the store tie-in may vary depending on the number of coils and the draw the case has. Depending on the case setup, the connecting point in the store may be 5/8", 7/8", or 1 1/8". Refer to the particular case you are hooking up.

Refrigerant lines should be sized as shown on the refrigeration legend furnished by the store.

Oil traps must be installed at the base of all suction line vertical risers on refrigerated cases.

Pressure drop can rob the system of capacity. To keep the pressure drop to a minimum, keep refrigerant line run as short as possible, using the minimum number of elbows. Where elbows are required, use long radius elbows only.

### Control Settings

See SFG/SFNG technical data sheet for the appropriate settings for your merchandiser. Maintain these parameters to achieve near constant product temperatures. For all multiplexing, defrost should be time terminated. Defrost times should be as seen in SFG/SFNG technical data sheet. The number of defrosts per day should never change. The duration of the defrost cycle may be adjusted to meet conditions present at your location.

0°F / - 18°C or less air temperature. Adequate performance is assured by the desired condition of the product in case.

### Access to TX Valves and Drain Lines

**MECHANICAL** - Remove product from end of case. Remove product racks. Remove refrigeration and drain access panels (labeled). TX valve (mechanical only) and drain are located under each access panel at end of the case.

**ELECTRONIC** - The Electronic Expansion valve master and slave cylinder(s) are located within the electrical access panel(s).

## Refrigeration (Cont'd)

### Electronic Expansion Valve (Optional)

A wide variety of electronic expansion valves and case controllers can be utilized. Please refer to EEV and controller Hussmann's information sheet. Sensors for electronic expansion valves will be installed on the coil inlet, coil outlet and in the discharge air. (Some supermarkets require a 4th sensor in the return air). Case controllers will be located in the electrical raceway or under the case.

### Thermostatic Expansion Valve Location

This device is located on the same side as the refrigeration stub. An Sporlan balanced port expansion valve model is furnished as standard equipment, unless otherwise specified by customer.

### Expansion Valve Adjustment

Expansion valves must be adjusted to fully feed the evaporator. Before attempting any adjustments, make sure the evaporator is either clear or very lightly covered with frost, and that the fixture is within 10°F of its expected operating temperature.

### Measuring the Operating Superheat

1. Determine the suction pressure with an accurate pressure gauge at the evaporator outlet.
2. From a refrigerant pressure temperature chart, determine the saturation temperature at the observed suction pressure.
3. Measure the temperature of the suction gas at the thermostatic remote bulb location.
4. Subtract the saturation temperature obtained in step No. 2 from the temperature measured in step No. 3.
5. The difference is superheat.
6. Set the superheat for 5°F - 7°F.

**Multiplexing** - Piping of merchandisers operating on the same refrigeration system may be run from merchandiser to merchandiser through the end frame saddles provided for this purpose. **DO NOT RUN REFRIGERANT LINES THROUGH MERCHANDISERS THAT ARE NOT THE SAME REFRIGERATION SYSTEM** as this may result in poor refrigeration control and compressor failure.

**Line Sizing** - Refrigerant lines should be sized as shown on the refrigeration legend that is furnished for the store (not furnished by Hussmann). If a legend has not been furnished, refer to the Hussmann Application Engineering Manual for guidance.

Oil traps must be installed at the base of all suction line vertical risers on refrigerated cases.

**Pressure Drop** - Pressure drop can rob the system of capacity. To keep the pressure drop to a minimum, keep the refrigerant line run as short as possible using a minimum number of elbows. Where elbows are required, use long radius elbows only.

**Insulation** - The suction and liquid lines should be clamped or taped together and insulated for a minimum of 30' from the merchandiser. Additional insulation is recommended wherever condensation drippage is objectionable.

### T-STAT Location

T-STATS are located within the electrical raceway.

### Piping

For merchandisers with "electric" defrost, the suction and liquid lines should be clamped or taped together and insulated for a minimum of 30 feet. For models with "KOOLGAS®" defrost, suction, and liquid lines should not contact each other, and should be insulated separately for a minimum of 30 feet. With either type defrost, additional insulation for the balance of the liquid and suction lines is required wherever condensation and drippage would be objectionable.

The refrigerant line outlets are located under the fixture at the left end when viewed from the back. Insulate suction lines to prevent condensation dripping on the floor.

**WARNING!**  
Do NOT apply thread sealer to ABS P-Trap.



## Refrigeration (Cont'd)



**SELF-SERVICE FROZEN FOOD, ICE CREAM CAKE, MEDIUM TEMP**  
**HUSSMANN - SFG-R (CHINO)**

REVISION DATE 07/09/19



Hussmann refrigerated merchandisers configured for sale for use in the United States meet or surpass the requirements of the DOE 2017 energy efficiency standards.

SFG shown with SGB body match

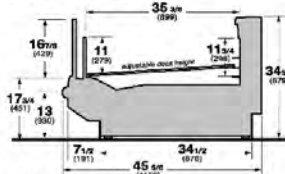

SFG shown with WSLA body match

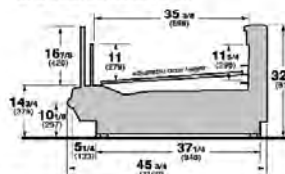

SFG plan view

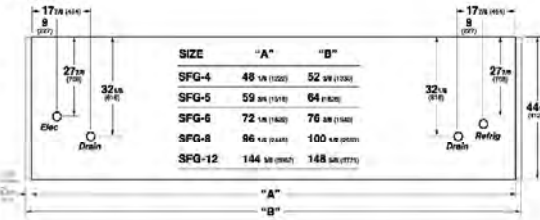

SFG W/SGB BODY



SFG W/SLA BODY

**REFRIGERATION DATA:**

CASE LENGTHS	CASE USAGE	CAPACITY *** (BTU/HR/FT)		TEMPERATURE (°F)			VELOCITY (FT/MIN)
		RATING CONDITION		EVAPORATOR		DISCHARGE AIR** (°F)	
		NSF 7	AHRI 1200	NSF 7	AHRI 1200	NSF 7	NSF 7
4', 5', 6', 8', 12'	FROZEN FOOD	340	340	-20	-20	-14	150-200
4', 5', 6', 8', 12'	ICE CREAM CAKE	360	350	-25	-20	-18	150-200
4', 5', 6', 8', 12'	MEDIUM TEMP	300	275	20	22	28	150-200

CASE LENGHT HS	EST. REFG. CHR.G. R404a(LBS)
4'	0.7
6'	0.8
8'	1.1
12'	1.4

\*\*FRONT DISCHARGE AIR MEASURED AT DISCHARGE LOUVER

\*\*\*REFRIGERATION NOTES:

- AHRI 1200 RATING POINT FOR ENERGY CONSUMPTION COMPARISON ONLY
- USE DEW POINT FOR HIGH GLIDE REFRIGERANTS. CARE SHOULD BE TAKEN TO USE THE DEW POINT IN P/T TABLES FOR MEASURING AND ADJUSTING SUPERHEAT. ADJUST EVAPORATOR PRESSURE AS NEEDED TO MAINTAIN THE DISCHARGE AIR TEMPERATURE SHOWN
- RATING CONDITION IS NSF TYPE I, 75°F / 55% RELATIVE HUMIDITY

**REFRIGERATION DATA CONTINUED:**

ELEC. THERMOSTAT / AIR SENSOR SETTINGS		DEFROST TYPE	TIME (MIN)	KOOL GAS DEFROST TIME (MIN.)	DEFROST FREQUENCY (#/DAY)	TERM. TEMP (°F) COIL ONLY	AIR SENSO R TEMP (REAR WALL)	DRIP TIME	DEFROST WATER (LBS/DAY/FT)	
USAGE	CUT IN (°F)									CUT OUT (°F)
FROZEN FOOD	-17	-14	ELECTRIC / KOOL GAS	45	15	1	55	54	NA	1.05
ICE CREAM CAKE	-22	-19	ELECTRIC / KOOL GAS	45	18	1	55	54	NA	1.1
MEDIUM TEMP	31	28	OFF TIME	45	NA	1	55	54	NA	0.9

**END PANEL WIDTH KEY**

# OF END PNLS	END PNL WIDTH (IN.)	TOTAL ADDED LENGTH (IN.)
1	2.125	2.125
2	2.125	4.25

**ELECTRICAL DATA:**

FANS, HEATERS, LED LIGHTS

CASE LENGTH	EVAPORATOR FANS (FROZEN FOOD AND ICE CREAM CAKE), 115V					DEFROST HEATERS (KOOL GAS ONLY), 115V		DEFROST HEATERS (ELECTRIC DEFROST ONLY), 208V		ANTI-SWEAT HEATERS, 115V							
	# OF EVAP FANS	BLADE DIA.	BLADE PITCH	AMPS	WATTS	AMPS	WATTS	AMPS	WATTS	GLASS HEATER		REAR LEDGE HEATER		PRODUCT STOP WARMER		VIEW END HEATER (VIEW END OPTION ONLY)	
										AMPS	WATTS	AMPS	WATTS	AMPS	WATTS	AMPS	WATTS
4'	1	8.75"	15°	0.1	8	2.0	230	5.8	1200	0.1	7	0.2	20	0.8	97	0.8	68
5'	1	8.75"	20°	0.1	8	2.0	233	9.6	2000	0.1	8	0.2	27	1.1	122	0.8	68
6'	2	8.75"	15°	0.2	16	2.5	290	9.6	2000	0.1	9	0.3	30	1.3	147	0.8	68
6'	2	8.75"	15°	0.2	16	2.5	284	10.8	2250	0.1	11	0.3	40	1.7	197	0.8	68
12'	3	6.75"	15°	0.4	24	6.8	760	16.1	3350	0.1	15	0.5	60	2.6	297	0.8	68

## Refrigeration (Cont'd)



**SELF-SERVICE FROZEN FOOD, ICE CREAM CAKE, MEDIUM TEMP**  
**HUSSMANN - SFNG-R (CHINO)**

REVISION DATE 08/15/25

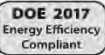

Husmann refrigerated merchandisers configured for sale for use in the United States meet or surpass the requirements of the DOE 2017 energy efficiency standards.

SFNG shown with SGB body match

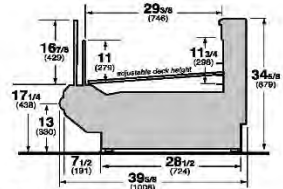

SFNG shown with isla body match

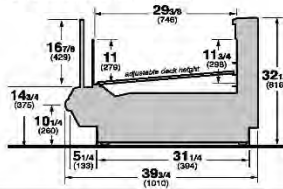

SFNG plan view

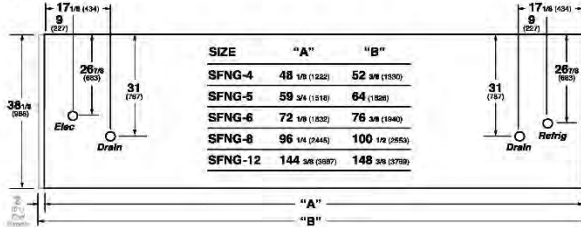

SIZE	"A"	"B"
SFNG-4	48 3/8 (1232)	52 3/8 (1330)
SFNG-5	59 3/4 (1516)	64 (1651)
SFNG-6	72 1/8 (1830)	76 3/8 (1940)
SFNG-8	96 1/4 (2444)	100 1/2 (2563)
SFNG-12	144 3/8 (3697)	148 3/8 (3770)



SFNG W/SGB BODY



SFNG W/ISLA BODY

**REFRIGERATION DATA:**

CASE LENGTHS	CASE USAGE	CAPACITY *** (BTU/HR/FT)		TEMPERATURE (°F)			VELOCITY (FT/MIN)
		RATING CONDITION		EVAPORATOR		DISCHARGE AIR** (°F)	
		NSF 7	AHRI	NSF 7	AHRI 1200	NSF 7	
4', 5', 6', 8', 12'	FROZEN FOOD	370	370	-29	-20	-12	80 - 180
4', 5', 6', 8', 12'	ICE CREAM CAKE	370	370	-29	-25	-12	80 - 180
4', 5', 6', 8', 12'	MEDIUM TEMP	340	355	20	20	22	80 - 180

CASE LENGHT HS	EST. REFG. CHR.G. R404A (LBS)
4'	0.7
6'	0.8
8'	1.1
12'	1.4

\*\*FRONT DISCHARGE AIR MEASURED AT DISCHARGE LOUVER

\*\*\*REFRIGERATION NOTES:

- AHRI 1200 RATING POINT FOR ENERGY CONSUMPTION COMPARISON ONLY
- USE DEW POINT FOR HIGH GLIDE REFRIGERANTS. CARE SHOULD BE TAKEN TO USE THE DEW POINT IN P/T TABLES FOR MEASURING AND ADJUSTING SUPERHEAT. ADJUST EVAPORATOR PRESSURE AS NEEDED TO MAINTAIN THE DISCHARGE AIR TEMPERATURE SHOWN.
- RATING CONDITION IS NSF TYPE I, 75°F / 55% RELATIVE HUMIDITY

**REFRIGERATION DATA CONTINUED:**

ELEC. THERMOSTAT / AIR SENSOR SETTINGS			DEFROST TYPE	TIME (MIN)	KOOL GAS DEFROST TIME (MIN.)	DEFROST FREQUENCY (#/DAY)	TERM. TEMP (°F) COIL ONLY	AIR SENSOR TEMP (REAR WALL)	DRIP TIME	DEFROST WATER (LBS/DAY/FT)
USAGE	CUT IN (°F)	CUT OUT (°F)								
FROZEN FOOD	-9	-19	ELECTRIC / KOOL GAS	60	15	2	48	58	NA	1.05
ICE CREAM CAKE	-7	-19	ELECTRIC / KOOL GAS	60	18	2	48	58	NA	1.1
MEDIUM TEMP	24	21	OFF TIME	60	NA	1	34	42	NA	0.9

END PANEL WIDTH KEY		
# OF END PNLS	END PNL WIDTH (IN.)	TOTAL ADDED LENGTH (IN.)
1	2.125	2.125
2	2.125	4.25

**ELECTRICAL DATA:**

**FANS, HEATERS**

CASE LENGTH	EVAPORATOR FANS (FROZEN FOOD AND ICE CREAM CAKE), 115V					DRAIN HEATER (KOOL GAS ONLY), 115V		DEFROST HEATERS (ELECTRIC DEFROST ONLY), 208V		ANTI-SWEAT HEATERS, 115V							
	# OF EVAP FANS	MOTOR RPM	DIAM (MM) / PITCH	AMPS	WATTS	AMPS	WATTS	AMPS	WATTS	GLASS HEATER		REAR LEDGE HEATER		PRODUCT STOP WARMER		VIEW END HEATER (VIEW END OPTION ONLY)	
										AMPS	WATTS	AMPS	WATTS	AMPS	WATTS	AMPS	WATTS
4'	1	1100	172 / 28°	0.07	12	2.00	230	5.77	1200	0.06	7	0.17	20	0.84	97	0.59	68.4
5'	1	1100	172 / 28°	0.07	12	2.03	233	9.62	2000	0.07	8	0.23	27	1.06	122	0.59	68.4
6'	2	1100	172 / 28°	0.14	24	2.52	290	9.62	2000	0.08	9	0.26	30	1.28	147	0.59	68.4
8'	2	1100	172 / 28°	0.14	24	2.47	284	10.82	2250	0.10	11	0.35	40	1.71	197	0.59	68.4
12'	3	1100	172 / 28°	0.21	36	6.61	760	16.11	3350	0.13	15	0.52	60	2.58	297	0.59	68.4

**OPTIONAL LED LIGHTS (115 VOLT)**

CASE LENGTH	SIGN LIGHTS OPTIONAL LED		SIGN LIGHT OPTIONAL H.O. LED	
	AMPS	WATTS	AMPS	WATTS
4'	0.09	10	0.13	15
5'	0.11	13	N/A	N/A
6'	0.13	15	0.23	26
8'	0.18	21	0.26	30
12'	N/A	N/A	N/A	N/A

**Electrical**

**Wiring Color Code**

STANDARD CASE WIRE COLOR CODE CODIGO DE COLORES DE LOS ALAMBRES PARA LAS VITRINAS ESTANDAR CODE COULEUR POUR FILS DE BOITIER NORMALISE		
COLOR DESCRIPTION	DESCRIPCION	DESCRIPTION
GROUND	TIERRA MASA	MASSE
ANTI-SWEAT	ANTICONDENSACION	ANTI-SURTEMENT
LIGHTS	LUCES	ECLAIRAGE
RECEPTACLES	ENCHUFES	PRISE DE COURANT
T-STAT/SOLENOID 230VAC	TERMOSTATO/SOLENOIDE (230VAC)	SOUPAPE A SOLENOID (230 VAC)
T-STAT/SOLENOID 115VAC	TERMOSTATO/SOLENOIDE (115VAC)	SOUPAPE A SOLENOID (115 VAC)
T-STAT/SOLENOID 24VAC	TERMOSTATO/SOLENOIDE (24VAC)	SOUPAPE A SOLENOID (24 VAC)
FAN MOTORS	VENTILADORES	VENTILATEUR
BLUE CONDENSING UNIT	UNIDAD DE CONDENSACION	UNITE DE CONDENSATION

**USE COPPER CONDUCTORS ONLY**  
**UTILISEZ LES CONDUCTEURS DE CUIVRE SEULEMENT**  
**UTILICE LOS CONDUCTORES DE COBRE SOLAMENTE**  
 430-01-0338 R101003

**CASE MUST BE GROUNDED**

**NOTE:** Refer to label affixed to case to determine the actual configuration as checked in the "TYPE INSTALLED" boxes.

**Electrical Circuit Identification**

Standard lighting for all models will be full length fluorescent lamps located within the case at the top.

The switch controlling the lights, the plug provided for digital scale, and the thermometer are located at the rear of the case mullion.

**Electrical Service Receptacles (When Applicable)**

The receptacle that is provided on the exterior back of these models is intended for computerized scales with a fifteen amp maximum load, not for large motors or other high wattage appliances. It should be wired to a dedicated circuit.



**DANGER**

**BEFORE SERVICING**

**ALWAYS DISCONNECT ELECTRICAL POWER AT THE MAIN DISCONNECT WHEN SERVICING OR REPLACING ANY ELECTRICAL COMPONENT.**

**This includes (but not limited to) Fans, Heaters Thermostats, and Lights.**

**LED Driver Location**

Drivers are located within the access panel that runs the length of the rear of the case.

**Field Wiring and Serial Plate Amperage**

Field Wiring must be sized for component amperes printed on the serial plate. Actual ampere draw may be less than

specified. Field wiring from the refrigeration control panel to the merchandisers is required for refrigeration thermostats. Case amperes are listed on the wiring diagram, but always check the serial plate.

**Ashrae Color Code**

**NOTE:** All other manufacturers have no standard sensor codes.

Case Control Systems SENSOR COLOR			
Manufacturer ® >	EIL	CPC	
Location			
Coil Inlet	Color	Blue	Blue
	Part#	225-01-1755	225-01-3255
Coil Outlet	Color	Red	Red
	Part#	225-01-1757	225-01-3123
Discharge Air	Color	Green	Green
	Part#	225-01-1756	225-01-3260
Return Air	Color	Purple	Green
	Part#	225-01-1758	225-01-3260
Defrost Term.	Color	White	Orange
	Part#	225-01-0650	225-01-3254
Liquid Line	Color	White	Blue
	Part#	225-01-0650	225-01-3255

**Rear Close-off Panel**

To perform electrical and refrigeration work, remove the rear closure panel by loosening the sheet metal screws. Replace when work is complete.

**Electrical Connections** - All wiring must be in compliance with NEC and local codes. All electrical connections for the non refrigerated model are to be made in the electrical panel. Electrical connections for refrigerated models are made in the electrical box on the back of the case behind the rear close-off panel.

**Field Wiring** - Field wiring must be sized for components amperes stamped on the serial plate. Actual ampere draw may be less than specified. Always check the serial plate.

**Post Construction Clean-up** - After the first two weeks of a major store remodel or new store operation, the grill should be removed and the condensing unit and condenser face cleaned due to the accumulated dirt and debris generated during construction.

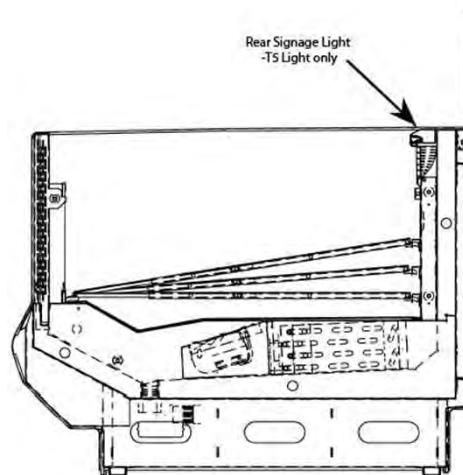

## User Information

### Stocking

In order to maximize product life, maintain a constant and proper product temperature from the time the product is received through storage, preparation and display.

Products should not be placed in merchandisers until all refrigeration controls have been adjusted and merchandisers are at proper operating temperature. Care should be taken to place the bakery trays all the way to the front of the shelf. This avoids blocking the rear refrigerated air discharge. The load limit decals are affixed to the interior of the merchandiser. Again, **air discharge and return air flow must be unobstructed at all times to provide proper refrigeration.**

There is also a row of vents located at the base of the front glass, just above the front rub rail. These vents allow a gentle air flow across the front glass from the ambient fans that prevents any condensation on the glass. **Do Not place any signs or other restrictive objects on the front of the merchandiser that will block these vents.**

Improper temperature and lighting will cause serious product loss. Discoloration, dehydration and spoilage can be controlled with proper use of the equipment and handling of product. Product temperature should always be maintained at a constant and proper temperature. This means that from the time the product is received, through storage, preparation and display, the temperature of the product must be controlled to maximize life of the product. Hussmann cases were not designed to "heat up" or "cool down" product - but rather to maintain an item's proper temperature for maximum shelf life. To achieve the protection required always:

1. Minimize processing time to avoid damaging temperature rise to the product. Product should be at proper temperature.
2. Keep the air in and around the case area free of foreign gasses and fumes or food will rapidly deteriorate.
3. Maintain the display merchandisers temperature controls as outlined in the refrigerator section of this manual.
4. Do not place any product into these refrigerators until all controls have been adjusted and they are operating at the proper temperature. Allow merchandiser to operate a minimum of 6 hours before stocking with any product.
5. When stocking, never allow the product to extend beyond the recommended load limit. **Air discharge and return air flow must be unobstructed at all times to provide proper refrigeration.**
6. There are vents located at the base of the front of the glass, just above the front rail. These vents supply a continuous, gentle flow of air across the front glass which inhibits condensation. Do not place any signs or other restrictive objects on the front of the refrigerator that will block these vents.
7. Avoid the use of supplemental flood or spot lighting. Display light intensity has been designed for maximum visibility and product life at the factory. The use of higher output fluorescent lamps (H.O. and V.H.O.), will shorten the shelf life of the product.

### Important Steps

1. Do not set temperature too cold, as this causes product dehydration. See SFG/SFNG technical data sheet for proper settings.
2. Temperature control should be by means of a T-STAT and Suction Stop Solenoid at each case. Do not use EPR valves, Liquid Line Solenoids or electronic control devices of any kind, as these allow temperature swings causing dehydration and excessive energy consumption.
3. Product should be worked and rotated on a regular basis, not to exceed a 4-hour period.

### Case Cleaning

Long life and satisfactory performance of any equipment are dependent upon the care given to it. To insure long life, proper sanitation and minimum maintenance costs, the refrigerator should be thoroughly cleaned frequently. It is essential to establish and regulate cleaning procedures. This will minimize bacteria causing discoloration which leads to degraded product appearance and significantly shortening product shelf life.

**SHUT OFF FAN DURING CLEANING PROCESS.** It can be unplugged within the case, or shut off case at the source. The interior bottom may be cleaned with any domestic soap or detergent based cleaners.

The use of hoses and sage machines to clean the inside of the cases is recommended and is an excellent way to clean the coil fins and hard to reach corners of the interior of the cases. Be sure to observe the warnings below when cleaning the case.

Sanitizing solutions will not harm the interior bottom, however, these solutions should always be used according to Hussmann's directions and should not contain Ammonia.

*Soap and hot water are not enough to kill this bacteria. A sanitizing solution must be included with each cleaning process to eliminate this bacteria.*

1. Allow cases to come to room temperature.
2. Scrub thoroughly, cleaning all surfaces, with soap and hot water.
3. Rinse with hot water, but do not flood.
4. Apply the sanitizing solution according to Hussmann's directions.
5. Rinse thoroughly.
6. Dry completely before resuming operation.

## User Information (Cont'd)

### Stainless Steel Cleaning and Care

There are three basic things, which can break down your stainless steel's passivity layer and allow corrosion.

#### 1. Mechanical Abrasion

Mechanical Abrasion means those things that will scratch the steels surface. Steel Pads, wire Brushes, and Scrapers are prime examples.

#### 2. Water

Water comes out of our tap in varying degrees of hardness. Depending on what part of the country you live in, you may have hard or soft water. Hard water may leave spots. Also, when heated, hard water leaves deposits behind that if left to sit, will break down the passive layer and rust your stainless steel. Other deposits from food preparation and service must be properly removed.

#### 3. Chlorides

Chlorides are found nearly everywhere. They are in water, food and table salt. One of the worst perpetrators of chlorides can come from household and industrial cleaners.

Don't Despair! Here are a few steps that can help prevent stainless steel rust.

#### 1. Use the Proper Tools

When cleaning your stainless steel products, take care to use non-abrasive tools. Soft Clothes and plastic scouring pads will NOT harm the steel's passive layer. Stainless steel pads can also be used but the scrubbing motion must be in the same direction of the manufacturer's polishing marks.

#### 2. Clean With the Polish Lines

Some stainless steels come with visible polishing lines or "grain". When visible lines are present, you should ALWAYS scrub in a motion that is parallel to them. When the grain cannot be seen, play it safe and use a soft cloth or plastic scouring pad.

#### 3. Use Alkaline, Alkaline Chlorinated or Non-chloride Containing Cleaners

While many traditional cleaners are loaded with chlorides, the industry is providing an ever increasing choice of non-chloride cleaners. If you are not sure of your cleaner's chloride content contact your cleaner supplier. If they tell you that your present cleaner contains chlorides, ask for an alternative. Also, avoid cleaners containing quaternary salts as they also can attack stainless steel & cause pitting and rusting.

#### 4. Treat your Water

Though this is not always practical, softening hard water can do much to reduce deposits. There are certain filters that can be installed to remove distasteful and corrosive elements. Salts in a properly maintained water softener are your friends. If you are not sure of the proper water treatment, call a treatment specialist.

#### 5. Keep your Food Equipment Clean

Use alkaline, alkaline chlorinated or non-chlorinated cleaners at recommended strength. Clean frequently to avoid build-up of hard, stubborn stains. If you boil water in your stainless steel equipment, remember the single most likely cause of damage is chlorides in the water. Heating cleaners that contain chlorides has a similar effect.

#### 6. RINSE, RINSE, RINSE

If chlorinated cleaners are used you must rinse, rinse, rinse and wipe dry immediately. The sooner you wipe off standing water, especially when sit contains cleaning agents, the better. After wiping the equipment down, allow it to air dry for the oxygen helps maintain the stainless steel's passivity film.

#### 7. Never Use Hydrochloric Acid (Muriatic Acid) on Stainless Steel

#### 8. Regularly Restore/Passivate Stainless Steel

## User Information (Cont'd)

### Cleaning Mirrors

Only use a soft cloth and mild glass cleaner for cleaning any glass or mirrored components. Be sure to rinse and/or dry completely.

### CAUTION

#### CLEANING PRECAUTIONS

##### When cleaning:

- Do not use high pressure water hoses
- Do not introduce water faster than waste outlet can drain
- NEVER INTRODUCE WATER ON SELF CONTAINED UNIT WITH AN EVAPORATOR PAN
- NEVER USE A CLEANING OR SANITIZING SOLUTION THAT HAS AN OIL BASE (these will dissolve the butyl sealants) or an AMMONIA BASE (this will corrode the copper components of the case)
- TO PRESERVE THE ATTRACTIVE FINISH:
- DO USE WATER AND A MILD DETERGENT FOR THE EXTERIOR ONLY
- DO NOT USE A CHLORANITED CLEANER ON ANY SURFACE
- DO NOT USE ABRASIVES OR STEEL WOOL SCOURING PADS (these will mar the finish)

### Cleaning Glass and Mirrors

Only use a soft cloth and mild glass cleaner for cleaning any glass or mirrored components. Be sure to rinse and/or dry completely.

**Never use hot water on cold glass surfaces! It may shatter and cause serious injury!** Allow glass surfaces to warm first.

### Non-Glare Glass

The high optical clarity of this glass is possible due to special coatings on the glass surface itself. To preserve this coating and the optical clarity, keep the glass clean.

Windex® or Glass Plus® are the only solutions recommended to be used to clean the non-glare glass. The damage to the glass from improper, caustic solutions is irreparable.

In addition to cleaning the glass with the recommended product, there are precautions that should be taken when working and cleaning the inside of the case.

- When cleaning the inside of the cases, we recommend that the glass be fully opened and covered to prevent solutions from splashing onto the glass and ruining the coating on the inside.

### Plexiglass and Acrylic Care

Improper cleaning not only accelerates the cleaning cycle but also degrades the quality of this surface. Normal daily buffing motions can generate static cling attracting dust to the surface. Incorrect cleaning agents or cleaning cloths can cause micro scratching of the surface, causing the plastic to haze over time.

### Cleaning

Hussmann recommends using a clean damp chamois, or a paper towel marked as dust and abrasive free with **210® Plastic Cleaner and Polish** available by calling Sumner Labs at **1-800-542-8656**. Hard, rough cloths or paper towels will scratch the acrylic and should not be used.

### Antistatic Coatings

The **210®** has proven to be very effective in not only cleaning and polishing the Plexiglass surface, but also providing anti-static and anti-fog capabilities. This product also seals pores and provides a protective coating.

## Maintenance



**DANGER**

**BEFORE SERVICING  
ALWAYS DISCONNECT ELECTRICAL  
POWER AT THE MAIN DISCONNECT  
WHEN SERVICING OR REPLACING ANY  
ELECTRICAL COMPONENT.  
This includes (but not limited to) Fans, Heaters  
Thermostats, and Lights.**

### Replacing LED Lights

This lamp has been treated to resist breakage and must be replaced with a similarly treated lamp in order to maintain compliance with NSF Standards. **NSF CODE 4.28.1**

Contact HUSSMANN Chino for replacement  
1-800-395-9229 x 2131

### Evaporator Fans

The evaporator fans are located in front of the CAD, directly beneath the display pans. *Should fans or blades need servicing, always replace fan blades with the raised embossed side of the blade TOWARD THE MOTOR.*

### Copper Coils

The copper coils used in Hussmann merchandisers may be repaired in the field. Materials are available from local refrigeration wholesalers.

Hussmann recommends using #15 Sil-Fos for repairs.

### Tips and Troubleshooting

**Before calling for service, check the following:**

1. Check electrical power supply to the equipment for connection.
2. Check fixture loading. Overstocking case will affect its proper operation.
3. If frost is collecting on fixture and/or product, check that Humidity Control is working properly, and that no outside doors or windows are open - allowing moisture to enter store.



**IMPORTANT  
INFORMATION**

Please read these instructions completely  
before beginning case installation

## Electrical Wiring Diagrams

<b>SFG/SFNG-4-R ELECTRIC DEFROST</b>	<b>4'</b>	<b>3020197</b>
<b>SFG/SFNG-5-R ELECTRIC DEFROST</b>	<b>5'</b>	<b>3020198</b>
<b>SFG/SFNG-6-R ELECTRIC DEFROST</b>	<b>6'</b>	<b>3020200</b>
<b>SFG/SFNG-8-R ELECTRIC DEFROST</b>	<b>8'</b>	<b>3020199</b>
<b>SFG/SFNG-12-R ELECTRIC DEFROST</b>	<b>12'</b>	<b>3020201</b>
<b>SFG/SFNG-4-R ELECT DEFROST DUAL TEMP</b>	<b>4'</b>	<b>3084682</b>
<b>SFG/SFNG-8-R ELECT DEFROST DUAL TEMP</b>	<b>8'</b>	<b>3143156</b>
<b>SFG/SFNG-12-R ELECT DEFROST DUAL TEMP</b>	<b>12'</b>	<b>3135709</b>
<b>SFG/SFNG-4-R KOOLGAS DEFROST</b>	<b>4'</b>	<b>3020306</b>
<b>SFG/SFNG-5-R KOOLGAS DEFROST</b>	<b>5'</b>	<b>3020307</b>
<b>SFG/SFNG-6-R KOOLGAS DEFROST</b>	<b>6'</b>	<b>3020308</b>
<b>SFG/SFNG-8-R KOOLGAS DEFROST</b>	<b>8'</b>	<b>3020309</b>
<b>SFG/SFNG-12-R KOOLGAS DEFROST</b>	<b>12'</b>	<b>3020310</b>
<b>SFG/SFNG-4-R KOOLGAS DUAL TEMP</b>	<b>4'</b>	<b>3149823</b>

REVISION HISTORY			
REV	EN	DATE	REV BY / APPR BY
A	ECN-CAP-0004894	2018/11/29	CE / CS
B	ECN-CAP-0016712	2023/10/06	CE / CS

REV	EN	DATE	REV BY / APPR BY
A	ECN-CAP-0004894	2018/11/29	CE / CS
B	ECN-CAP-0016712	2023/10/06	CE / CS

REV	EN	DATE	REV BY / APPR BY
A	ECN-CAP-0004894	2018/11/29	CE / CS
B	ECN-CAP-0016712	2023/10/06	CE / CS

REV	EN	DATE	REV BY / APPR BY
A	ECN-CAP-0004894	2018/11/29	CE / CS
B	ECN-CAP-0016712	2023/10/06	CE / CS

REV	EN	DATE	REV BY / APPR BY
A	ECN-CAP-0004894	2018/11/29	CE / CS
B	ECN-CAP-0016712	2023/10/06	CE / CS

REV	EN	DATE	REV BY / APPR BY
A	ECN-CAP-0004894	2018/11/29	CE / CS
B	ECN-CAP-0016712	2023/10/06	CE / CS

REV	EN	DATE	REV BY / APPR BY
A	ECN-CAP-0004894	2018/11/29	CE / CS
B	ECN-CAP-0016712	2023/10/06	CE / CS

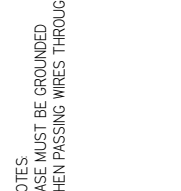
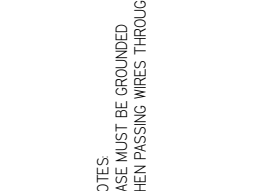
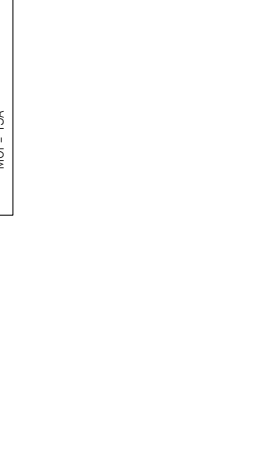
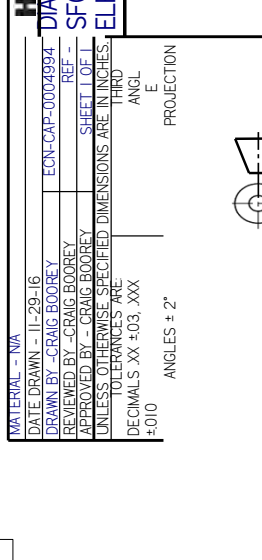
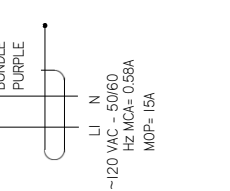
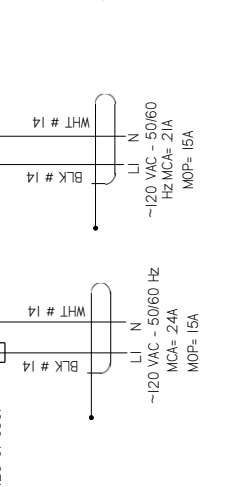
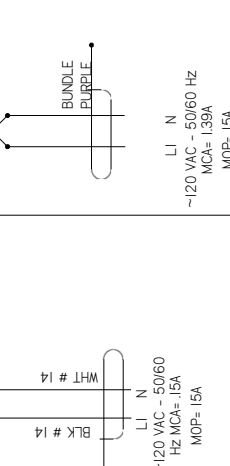
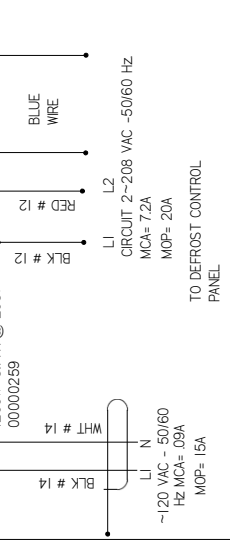
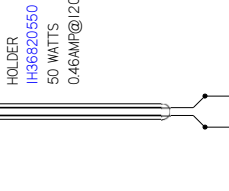
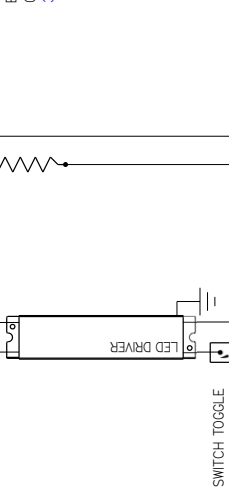
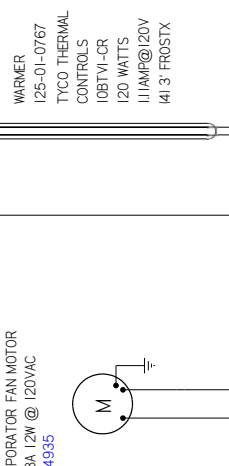
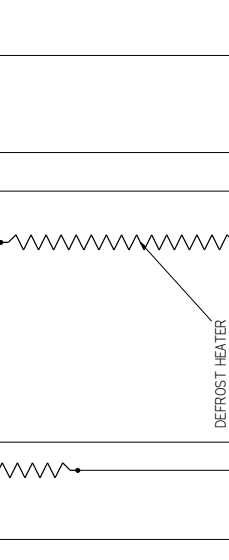
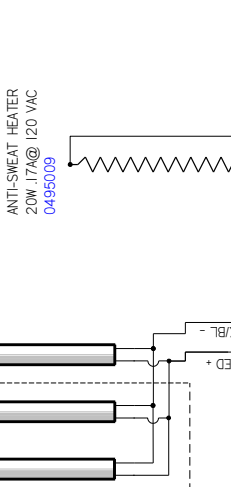
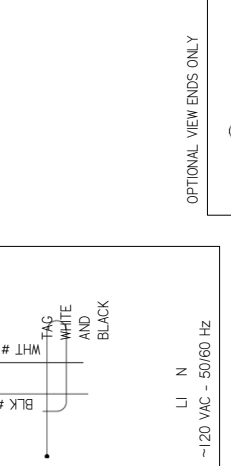
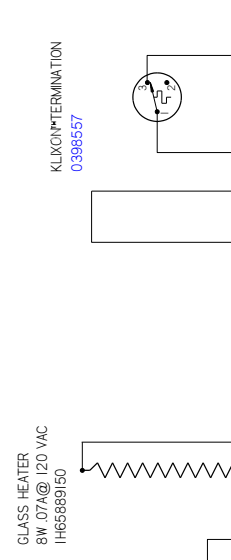
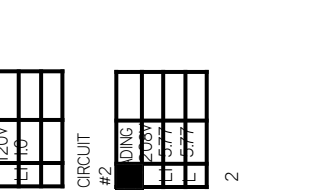
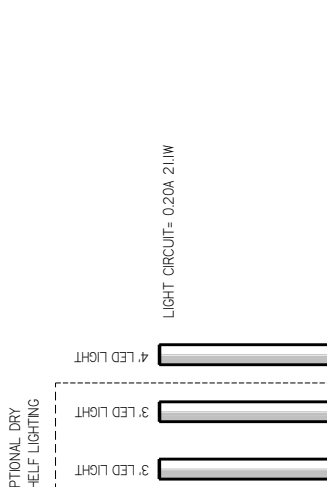
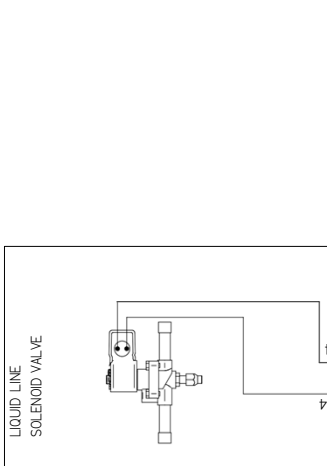
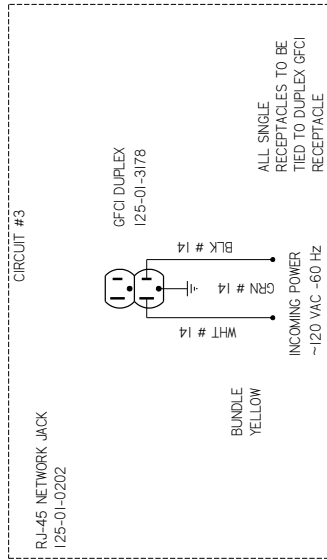

NOTES:  
CASE MUST BE GROUNDED  
WHEN PASSING WIRES THROUGH METAL HOLES A GROMMET MUST BE USED

**HUSSMANN**  
DIAGRAM-  
SFG/SFNG- 4-R  
ELECTRIC DEFROST  
3020197 | B

MATERIAL - N/A	DATE DRAWN - 11-29-16	ECN-CAP-0004994	REF -
DRAWN BY - CRAIG BOOREY	REVIEWED BY - CRAIG BOOREY	SHEET 1 OF 1	
UNLESS OTHERWISE SPECIFIED DIMENSIONS ARE IN INCHES TOLERANCES ARE: DECIMALS .XX +0.3 .XXX +0.0			
ANGLES ± 2°			



CIRCUIT #1  
LOADING

120V	
115	

CIRCUIT #2  
LOADING

200W	
150W	
100W	
50W	

LIGHT CIRCUIT= 0.26A 27.6W

REVISION HISTORY

REV	ECN	DATE	REVISION DESCRIPTION	REV BY	CHKD BY	APPR BY
A	ECN-CAP-0024984	2016/12/9	RELEASED TO PRODUCTION	CS	CS	CS
B	ECN-CAP-0018712	2023/10/06	CHANGED FAN MOTOR	CS	CS	CS
C	ECN-CAP-0018716	2023/11/02	NEW FAN MOTOR	CS	CS	CS

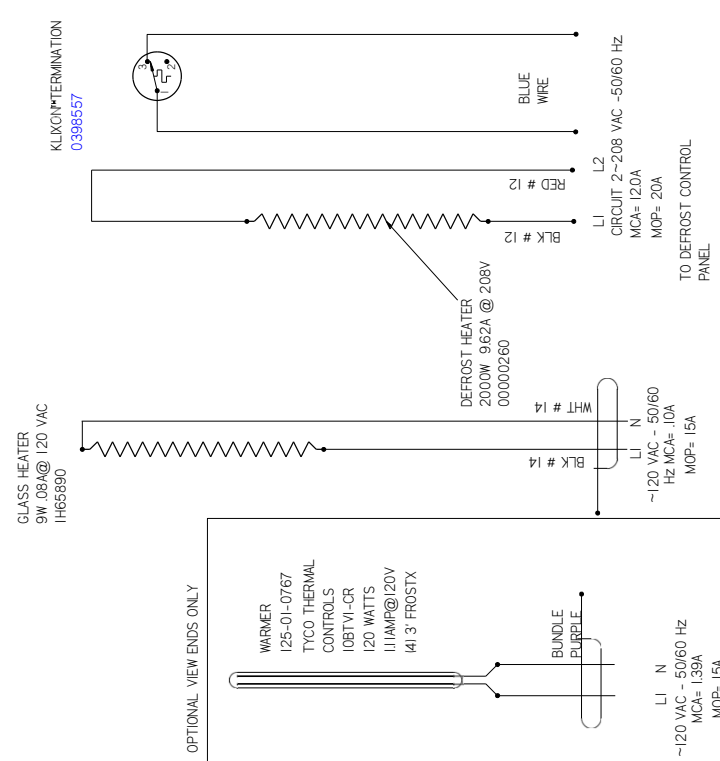
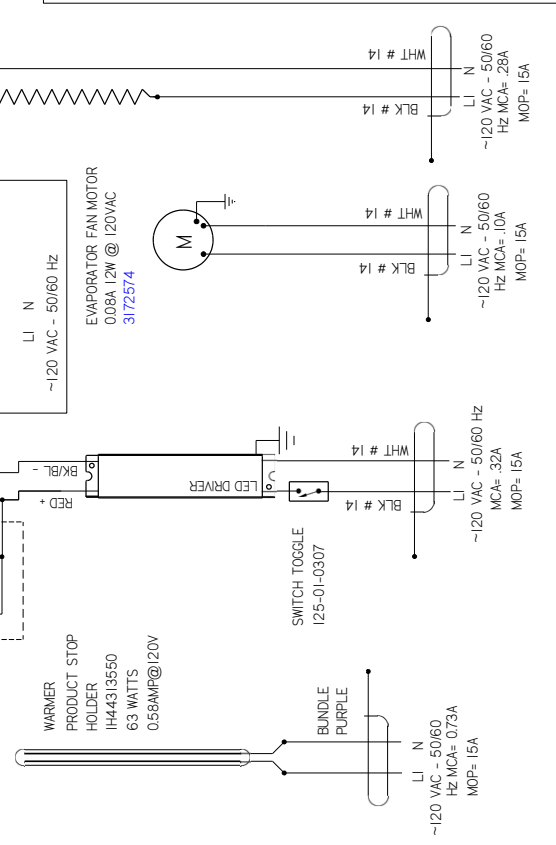
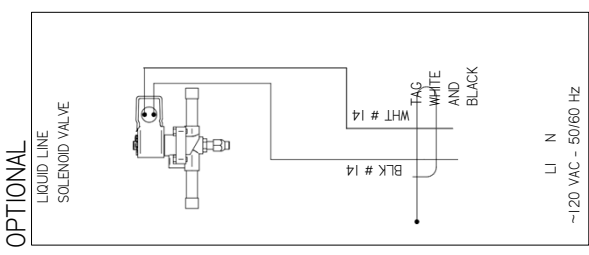
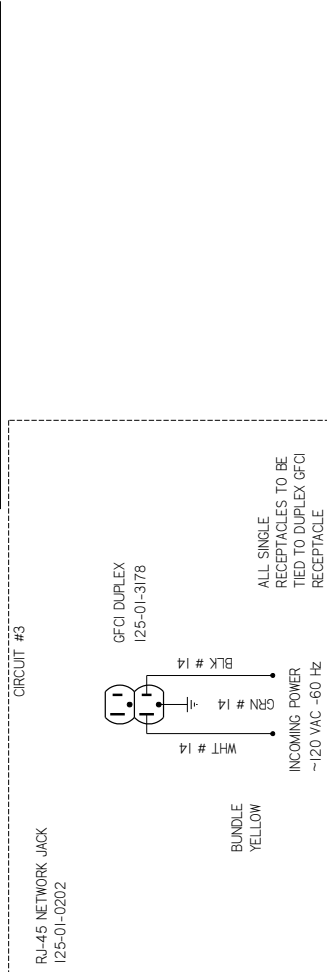

**HUSSMANN**  
DIAGRAM -  
SFG/SFNG- 5-R  
ELECTRIC DEFROST  
3020198 | C

MATERIAL - N/A  
DATE DRAWN - 11-29-16  
DRAWN BY - CRAIG BOOREY  
REVIEWED BY - CRAIG BOOREY  
APPROVED BY - CRAIG BOOREY  
SHEET NO. 1  
UNLESS OTHERWISE SPECIFIED DIMENSIONS ARE IN INCHES  
TOLERANCES ARE:  
DIMENSIONS .XX +0.3 .XXX  
+0.0  
ANGLES ± 2°  
PROJECTION  
E  
REF -

ECN-CAP-00024984  
SHEET OF 1

NOTES:  
CASE MUST BE GROUNDED  
WHEN PASSING WIRES THROUGH METAL HOLES A GROMMET MUST BE USED

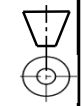



CIRCUIT #1 LOADING	CIRCUIT #2
120V	LOADING
110	200W
	100W
	100W

2

REV	EN	DATE	REVISION DESCRIPTION	REV BY	CHKD BY	APPR BY
A	ECN-CAP-0004994	2016/10/28	RELEASED TO PRODUCTION	CB	CB	CB
B	ECN-COD-0016072	2023/03/09	CHANGED FANS & LIGHTS	CB	CB	CB

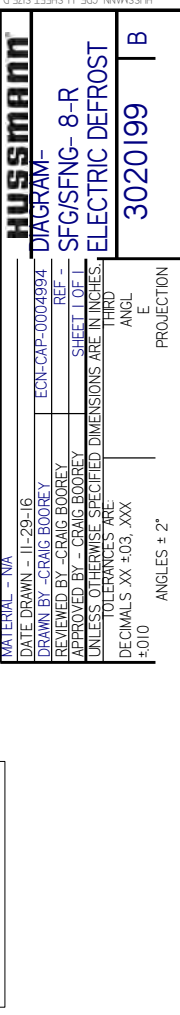
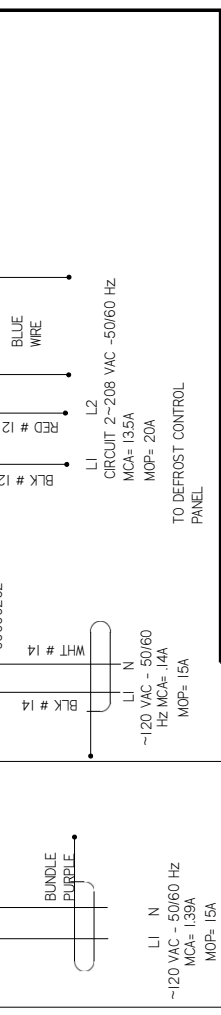
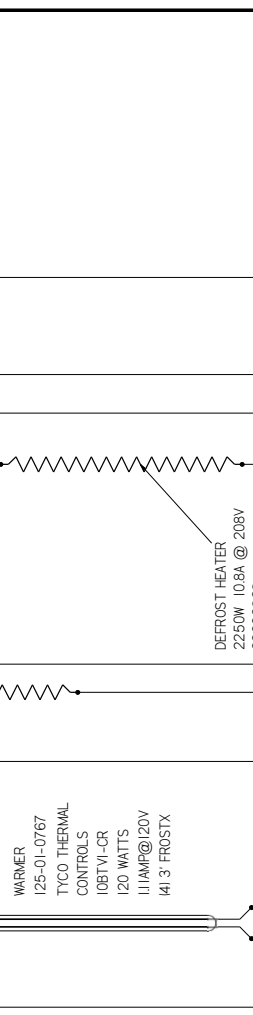
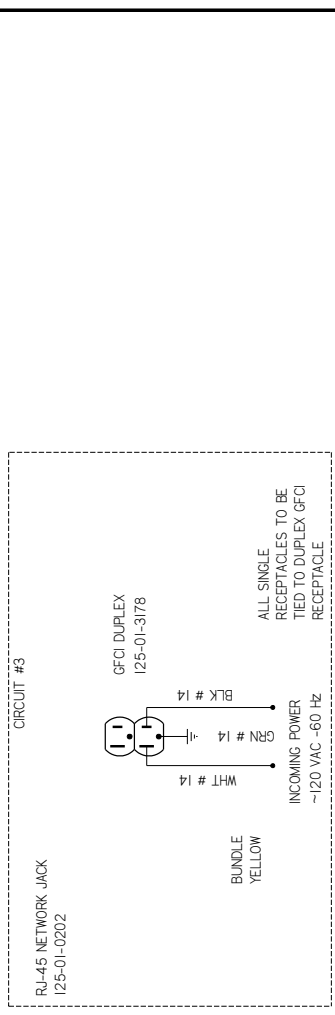

**HUSSMANN**

**DIAGRAM - SFG/SFNG-8-R ELECTRIC DEFROST**

DATE DRAWN - 11-29-16  
DRAWN BY - CRAIG BOOREY  
REVIEWED BY - CRAIG BOOREY  
APPROVED BY - CRAIG BOOREY

ECN-CAP-0004994  
REF -  
SHEET 1 OF 1

UNLESS OTHERWISE SPECIFIED DIMENSIONS ARE IN INCHES  
TOLERANCES ARE:  
DIMENSIONS .XX +.03, .XXX  
+0.0

ANGLES ± 2°

PROJECTION

3020199 | B

NOTES:  
CASE MUST BE GROUNDED  
WHEN PASSING WIRES THROUGH METAL HOLES A GROMMET MUST BE USED





REVISION HISTORY			
REV	EN	DATE	REV BY / CHG BY / APPR BY
A	EN-CAP-001592	2019/01/10	CB / CB / CB
B	EN-CAP-001592	2023/01/09	CB / CB / CB

REVISION HISTORY			
REV	EN	DATE	REV BY / CHG BY / APPR BY
A	EN-CAP-001592	2019/01/10	CB / CB / CB
B	EN-CAP-001592	2023/01/09	CB / CB / CB

REVISION HISTORY			
REV	EN	DATE	REV BY / CHG BY / APPR BY
A	EN-CAP-001592	2019/01/10	CB / CB / CB
B	EN-CAP-001592	2023/01/09	CB / CB / CB

REVISION HISTORY			
REV	EN	DATE	REV BY / CHG BY / APPR BY
A	EN-CAP-001592	2019/01/10	CB / CB / CB
B	EN-CAP-001592	2023/01/09	CB / CB / CB

REVISION HISTORY			
REV	EN	DATE	REV BY / CHG BY / APPR BY
A	EN-CAP-001592	2019/01/10	CB / CB / CB
B	EN-CAP-001592	2023/01/09	CB / CB / CB

REVISION HISTORY			
REV	EN	DATE	REV BY / CHG BY / APPR BY
A	EN-CAP-001592	2019/01/10	CB / CB / CB
B	EN-CAP-001592	2023/01/09	CB / CB / CB

REVISION HISTORY			
REV	EN	DATE	REV BY / CHG BY / APPR BY
A	EN-CAP-001592	2019/01/10	CB / CB / CB
B	EN-CAP-001592	2023/01/09	CB / CB / CB

REVISION HISTORY			
REV	EN	DATE	REV BY / CHG BY / APPR BY
A	EN-CAP-001592	2019/01/10	CB / CB / CB
B	EN-CAP-001592	2023/01/09	CB / CB / CB

REVISION HISTORY			
REV	EN	DATE	REV BY / CHG BY / APPR BY
A	EN-CAP-001592	2019/01/10	CB / CB / CB
B	EN-CAP-001592	2023/01/09	CB / CB / CB

REVISION HISTORY			
REV	EN	DATE	REV BY / CHG BY / APPR BY
A	EN-CAP-001592	2019/01/10	CB / CB / CB
B	EN-CAP-001592	2023/01/09	CB / CB / CB

REVISION HISTORY			
REV	EN	DATE	REV BY / CHG BY / APPR BY
A	EN-CAP-001592	2019/01/10	CB / CB / CB
B	EN-CAP-001592	2023/01/09	CB / CB / CB

REVISION HISTORY			
REV	EN	DATE	REV BY / CHG BY / APPR BY
A	EN-CAP-001592	2019/01/10	CB / CB / CB
B	EN-CAP-001592	2023/01/09	CB / CB / CB

REVISION HISTORY			
REV	EN	DATE	REV BY / CHG BY / APPR BY
A	EN-CAP-001592	2019/01/10	CB / CB / CB
B	EN-CAP-001592	2023/01/09	CB / CB / CB

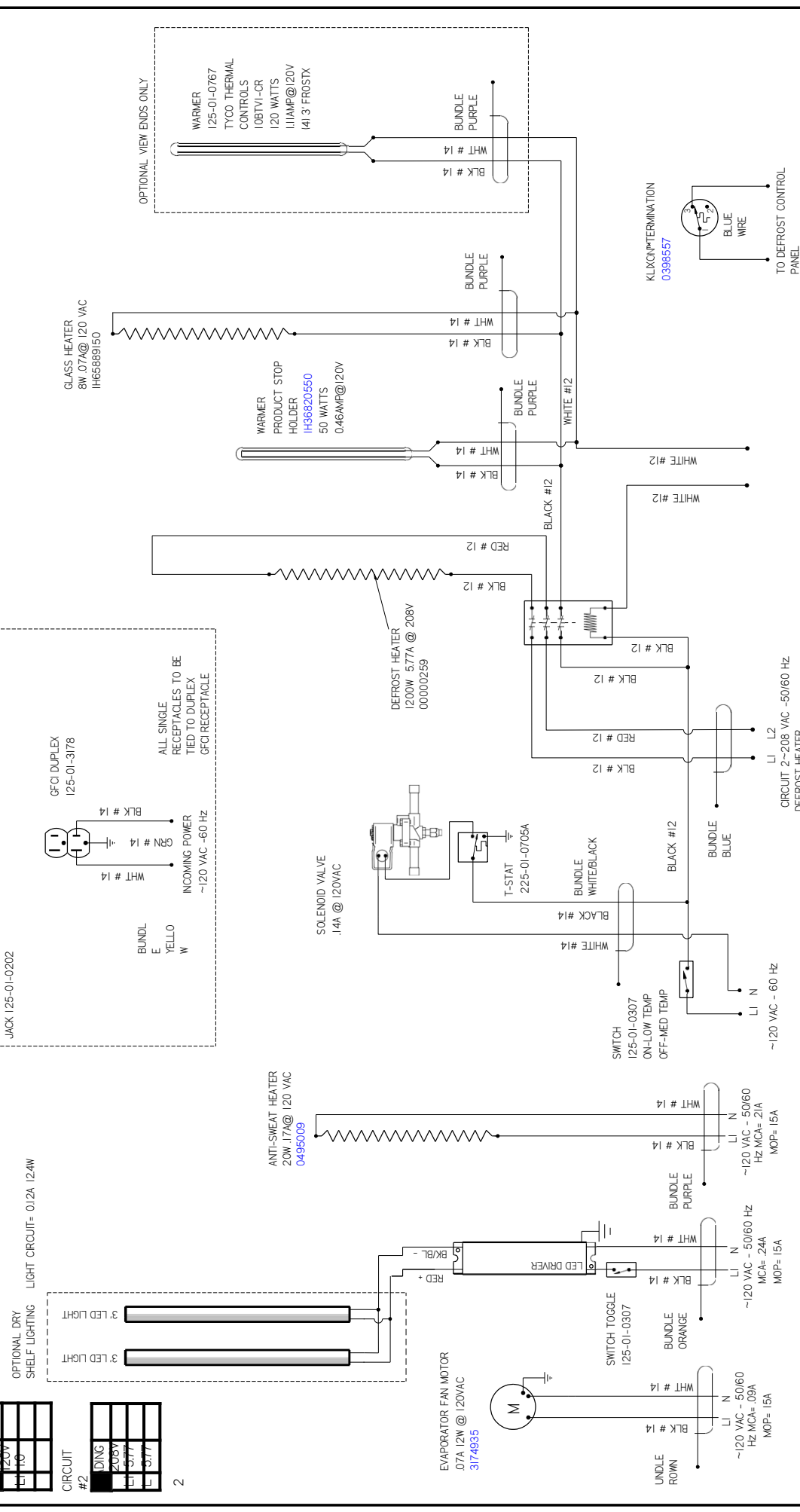

**HUSSMANN**  
**DIAGRAM-SFNG-4-R**  
**WELTRIC DEFROST, DUAL TEMP**

MATERIAL - N/A  
DATE DRAWN - 11-10-19  
DRAWN BY - CRAIG BOOREY  
REVIEWED BY - CRAIG BOOREY  
APPROVED BY - CRAIG BOOREY  
UNLESS OTHERWISE SPECIFIED DIMENSIONS ARE IN INCHES.  
TOLERANCES ARE TO FINISHES.  
DECIMALS .XX +0.3 .XXX  
+0.0

ANGLES ± 2°

PROJECTION

3084682 | B

REVISION HISTORY			
REV	EN	DATE	REV BY / CHG BY / APPR BY
A	EN-CAP-001592	2019/01/10	CB / CB / CB
B	EN-CAP-001592	2023/01/09	CB / CB / CB

REVISION HISTORY			
REV	EN	DATE	REV BY / CHG BY / APPR BY
A	EN-CAP-001592	2019/01/10	CB / CB / CB
B	EN-CAP-001592	2023/01/09	CB / CB / CB

REVISION HISTORY			
REV	EN	DATE	REV BY / CHG BY / APPR BY
A	EN-CAP-001592	2019/01/10	CB / CB / CB
B	EN-CAP-001592	2023/01/09	CB / CB / CB

REVISION HISTORY			
REV	EN	DATE	REV BY / CHG BY / APPR BY
A	EN-CAP-001592	2019/01/10	CB / CB / CB
B	EN-CAP-001592	2023/01/09	CB / CB / CB

REVISION HISTORY			
REV	EN	DATE	REV BY / CHG BY / APPR BY
A	EN-CAP-001592	2019/01/10	CB / CB / CB
B	EN-CAP-001592	2023/01/09	CB / CB / CB

REVISION HISTORY			
REV	EN	DATE	REV BY / CHG BY / APPR BY
A	EN-CAP-001592	2019/01/10	CB / CB / CB
B	EN-CAP-001592	2023/01/09	CB / CB / CB

REVISION HISTORY			
REV	EN	DATE	REV BY / CHG BY / APPR BY
A	EN-CAP-001592	2019/01/10	CB / CB / CB
B	EN-CAP-001592	2023/01/09	CB / CB / CB

REVISION HISTORY			
REV	EN	DATE	REV BY / CHG BY / APPR BY
A	EN-CAP-001592	2019/01/10	CB / CB / CB
B	EN-CAP-001592	2023/01/09	CB / CB / CB

REVISION HISTORY			
REV	EN	DATE	REV BY / CHG BY / APPR BY
A	EN-CAP-001592	2019/01/10	CB / CB / CB
B	EN-CAP-001592	2023/01/09	CB / CB / CB

REVISION HISTORY			
REV	EN	DATE	REV BY / CHG BY / APPR BY
A	EN-CAP-001592	2019/01/10	CB / CB / CB
B	EN-CAP-001592	2023/01/09	CB / CB / CB

REVISION HISTORY			
REV	EN	DATE	REV BY / CHG BY / APPR BY
A	EN-CAP-001592	2019/01/10	CB / CB / CB
B	EN-CAP-001592	2023/01/09	CB / CB / CB

NOTES:  
CASE MUST BE GROUNDED  
WHEN PASSING WIRES THROUGH METAL HOLES A GROMMET MUST BE USED

REV	ECN	DATE	REVISION DESCRIPTION	REV BY	CHKD BY	APPR BY
B	ECN-C00-0012731	2-12-21	LED LIGHTS, OPTIONAL	CB	CB	CB
C	ECN-C00-0016712	10-9-23	CHANGED EVAP FANS	CB	CB	CB

REVISION HISTORY
REVISION HISTORY

CIRCUIT #1	LOADING
120V	
14A	
17	

CIRCUIT #2	LOADING
120V	
10A	
100	
100	

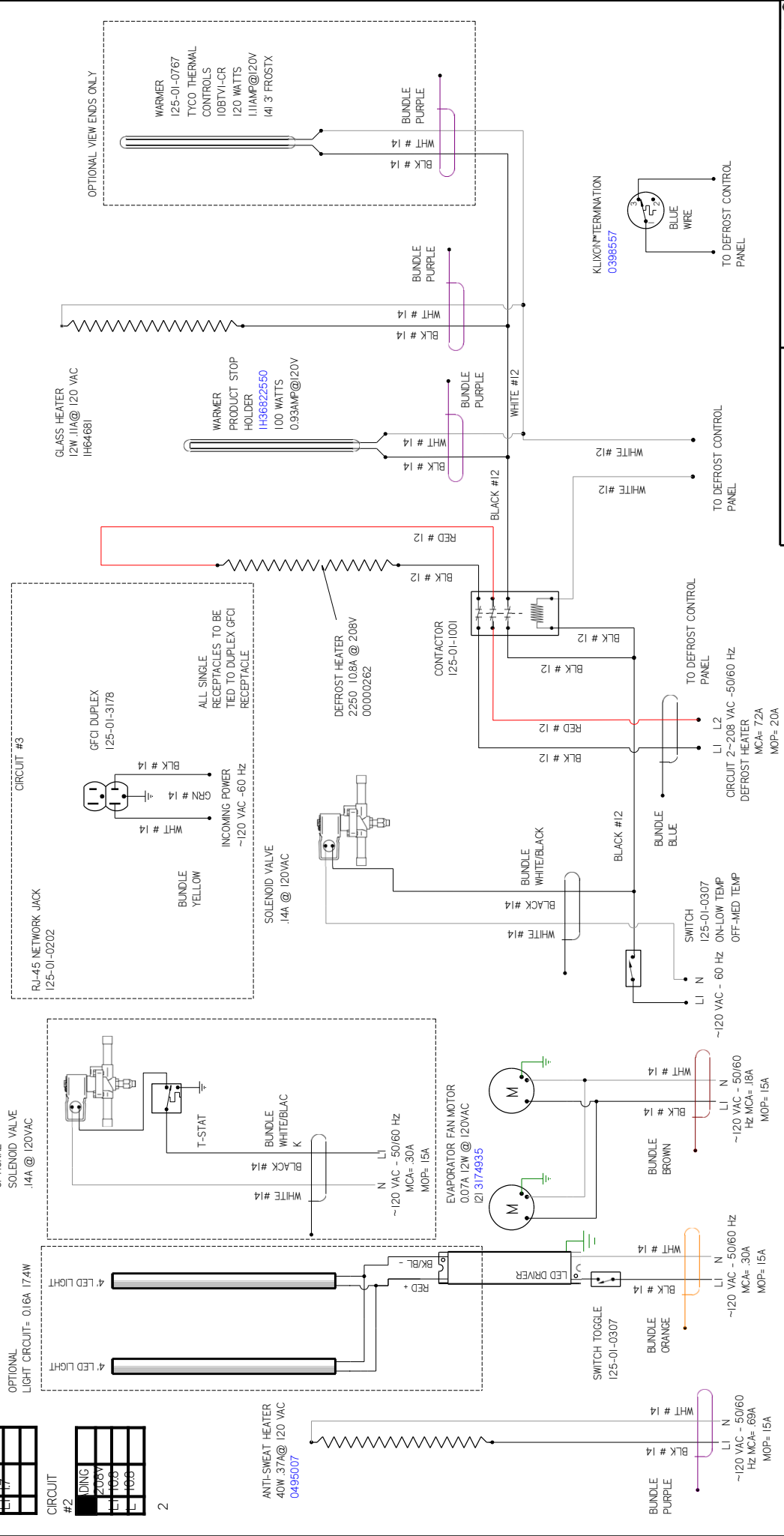

**HUSSMANN**  
**DIAGRAM-SFNG-8-**  
**RELECT DEFOEST**  
**DUAL TEMP**

FACTORY 14GA WIRE  
 \_FACTORY LOGGA WIRE  
 --- FIELD WIRE ---  
 --- DO NOT SCALE DRAWING ---  
 SHEET 1 OF 1

UL COLOR CODES / ABBREVIATIONS  
 RED = RD  
 BLACK = BK  
 BLUE = BL  
 YELLOW = YL  
 GRAY = GR  
 WHITE = WT  
 GREEN = GN  
 BROWN = BN  
 ORANGE = OR  
 PURPLE = VT

- NOTES:
1. PRINTED DOCUMENT REQUIRED SETTING. ALL COLORS BLACK & WHITE
  2. CASE & ANY REMOVABLE PANEL WITH ELECTRICAL PARTS MUST BE GROUNDED.
  3. WHEN PASSING WIRES THROUGH METAL HOLES A GROMMET MUST BE USED

3143156

REV	ECN	DATE	REVISION DESCRIPTION	REV BY	CHKD BY	APPR BY
A	ECN-COD-0011848	10-29-20	RELEASED TO PRODUCTION	CB	CB	CB
B	ECN-COD-0016712	10-9-23	CHANGED EVAP FANS	CB	CB	CB

CIRCUIT #1	LOADING
120V	
L1	
N	

CIRCUIT #2	LOADING
208V	
L1	
L2	
N	

CIRCUIT #3	LOADING
120V	
L1	
N	

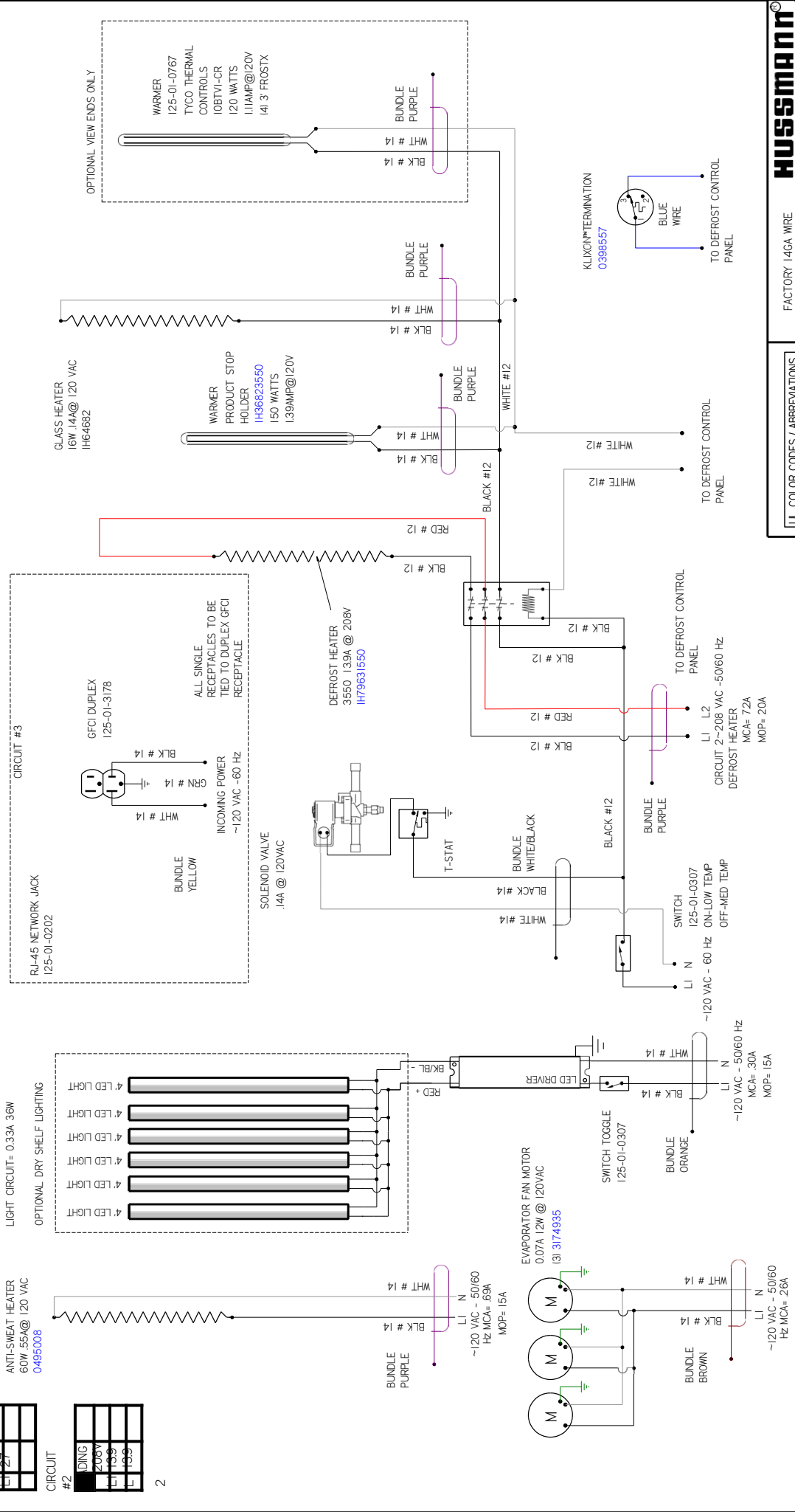

UL COLOR CODES / ABBREVIATIONS	
RED = RD	WHITE = WT
BLACK = BK	GREEN = GN
BLUE = BL	BROWN = BN
YELLOW = YL	ORANGE = OR
GRAY = GR	VIOLET = VT

FACTORY 14GA WIRE
FACTORY LOGGA WIRE
FIELD WIRE

**NOTES:**  
 1. PRINTED DOCUMENT REQUIRED SETTING: ALL COLORS BLACK & WHITE  
 2. CASE & ANY REMOVABLE PANEL WITH ELECTRICAL PARTS MUST BE GROUNDED.  
 3. WHEN PASSING WIRES THROUGH METAL HOLES A GROMMET MUST BE USED

CIRCUIT #1 LOADING	CIRCUIT #2 LOADING
120V	120V
11	11
11	11
11	11

LIGHT CIRCUIT= 0.24A 261W

OPTIONAL DRY  
SHELF LIGHTING

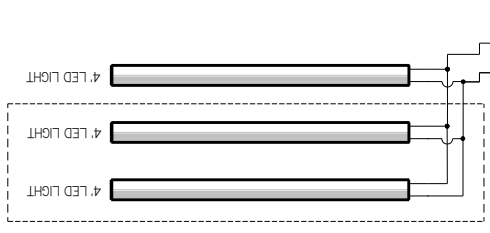

WARMER  
PRODUCT STOP  
HOLDER  
IH36821550  
50 WATTS  
0.46 AMP@120V

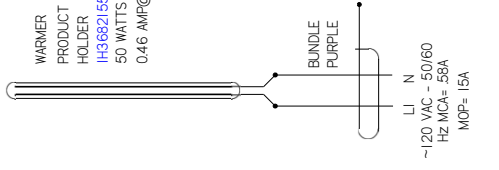

OPTIONAL

LIQUID LINE  
SOLENOID VALVE

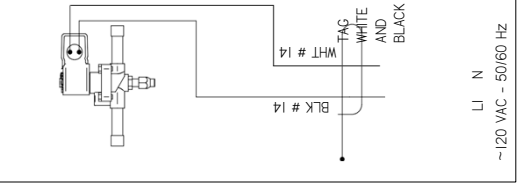

EVAPORATOR FAN MOTOR  
0.07A 12W @ 120VAC  
3174835

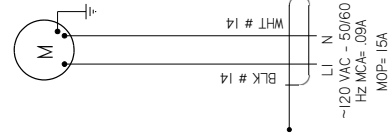

ANTI-SWEAT HEATER  
20W .17A@ 120 VAC  
0495009

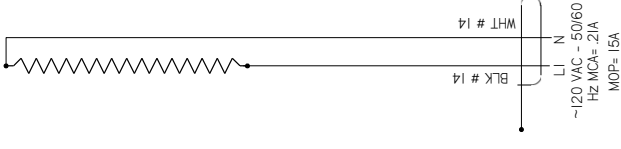

OPTIONAL VIEW ENDS ONLY

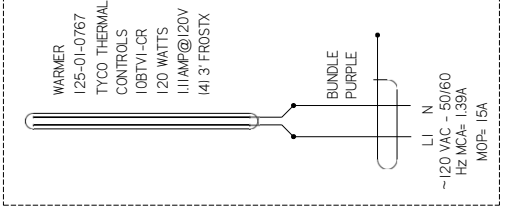

RJ-45 NETWORK JACK  
125-01-0202

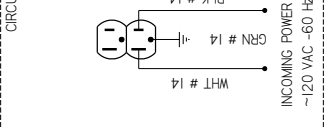

GFCI DUPLEX  
125-01-3178

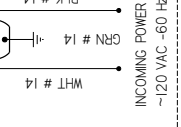

ALL SINGLE  
RECEPTACLES TO BE  
TIED TO DUPLEX GFCI  
RECEPTACLE

RETURN AIR HEATER  
120W 1.04A@ 120V  
125-02-3033

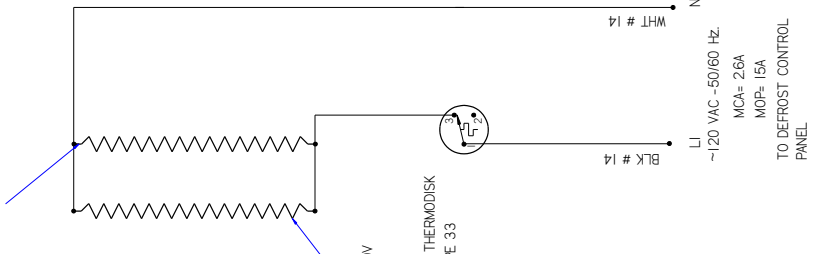

DRAIN HEATER  
110W 1.02A@ 120V  
0488967

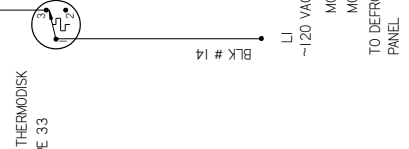

KLIXON™ THERMODISK  
DISC TYPE 33  
0481370

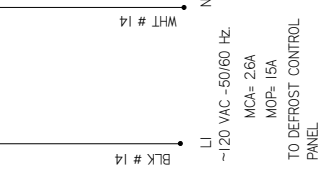

GLASS HEATER  
8W .07A@ 120 VAC  
IH65889

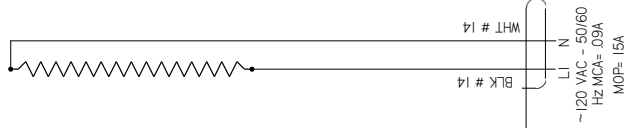

TO DEFFROST CONTROL  
PANEL

MCA= 26A  
MOP= 15A

MCA= 09A  
MOP= 15A

MCA= 21A  
MOP= 15A

MCA= 1.09A  
MOP= 15A

MCA= 30A  
MOP= 15A

MCA= 58A  
MOP= 15A

**HUSSMANN**  
DIAGRAM -  
SFG/SFNG- 4-R  
KOOL GAS DEFROST  
3020306 | B

MATERIAL - N/A  
DATE DRAWN - 12-1-16  
DRAWN BY - CRAIG BOOREY  
REVIEWED BY - CRAIG BOOREY  
APPROVED BY - CRAIG BOOREY  
REF -  
ECON-CAP-00024995  
SHEET 1 OF 1  
UNLESS OTHERWISE SPECIFIED DIMENSIONS ARE IN INCHES.  
TOLERANCES ARE:  
THIRD ANGLE PROJECTION  
DECIMALS .XX +03 .XX  
+0.0

NOTES:  
CASE MUST BE GROUNDED  
WHEN PASSING WIRES THROUGH METAL HOLES A GROMMET MUST BE USED

REV	ECN	DATE	REVISION DESCRIPTION	REV BY	CHKD BY	APPR BY
A	ECN-CAP-0004985	2016/12/01	RELEASED TO PRODUCTION	CS	CS	CS
B	ECN-CAP-0014537	2016/09/10	REVISED HEATER PART NUMBER	CS	CS	CS
C	ECN-COQ-0018713	2023/10/10	CHANGED EVAP FAN	CS	CS	CS
D	ECN-COQ-0024716	2023/11/02	NEW FAN MOTOR	CS	CS	CS

REVISION HISTORY
RELEASED TO PRODUCTION
REVISED HEATER PART NUMBER
CHANGED EVAP FAN
NEW FAN MOTOR

CIRCUIT #1	LOADING
1	120V
2	120V
3	120V
4	120V
5	120V

CIRCUIT #2	LOADING
1	120V
2	120V
3	120V
4	120V
5	120V

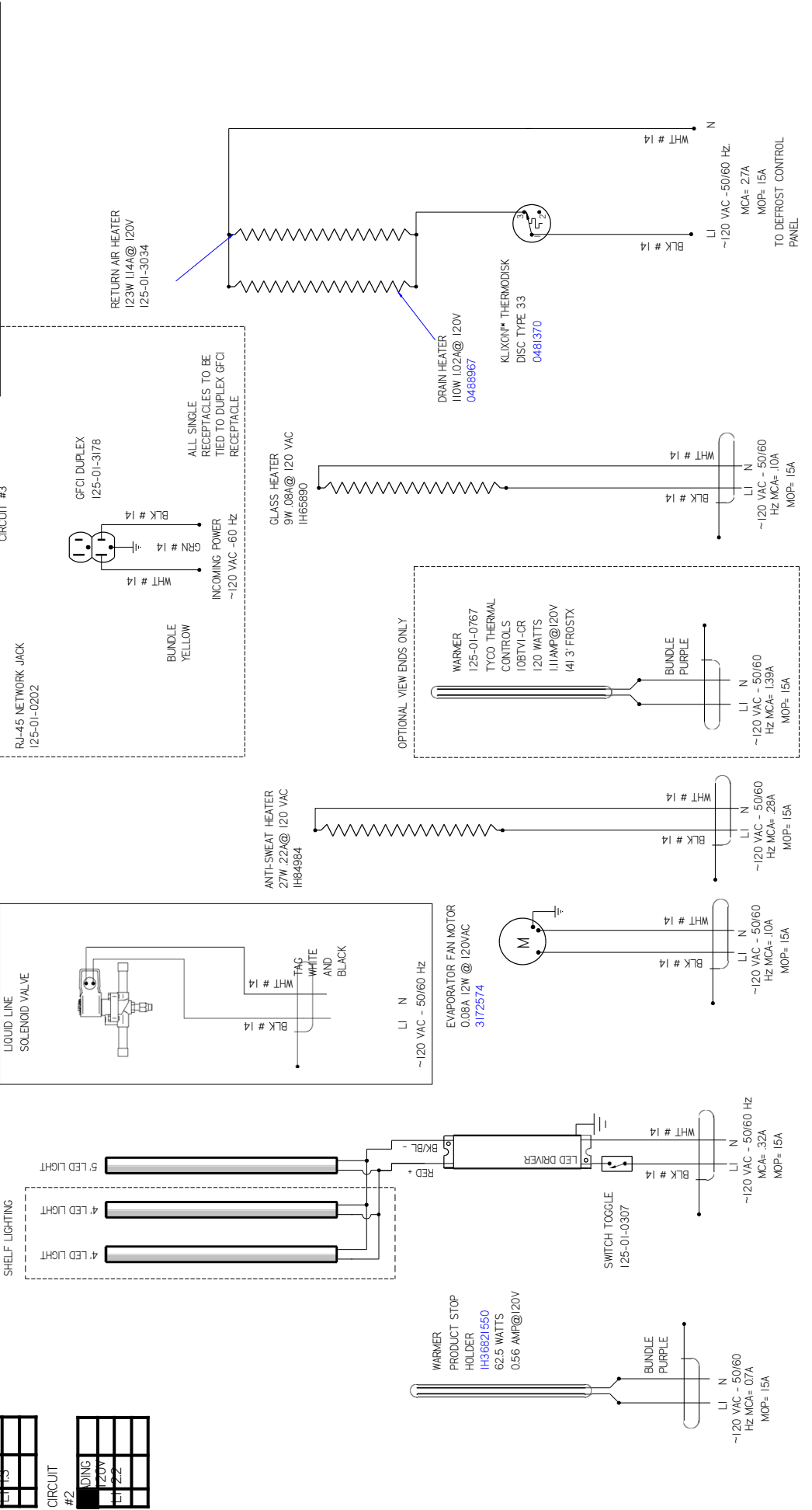

**HUSSMANN**  
**DIAGRAM -**  
**SFG/SFNG- 5-R**  
**KOOLGAS DEFROST**  
**3020307** | **D**

MATERIAL - N/A  
 DATE DRAWN - 12-1-16  
 DRAWN BY - CRAIG BOOREY  
 REVIEWED BY - CRAIG BOOREY  
 APPROVED BY - CRAIG BOOREY  
 REF -  
 SHEET OF 1  
 UNLESS OTHERWISE SPECIFIED DIMENSIONS ARE IN INCHES  
 TOLERANCES ARE:  
 FRACTIONS .XX  
 DECIMALS .XX +03 .XX  
 ANGLES ± 2°  
 PROJECTION

NOTES:  
 CASE MUST BE GROUNDED  
 WHEN PASSING WIRES THROUGH METAL HOLES A GROMMET MUST BE USED

CIRCUIT #1  
LOADING

120V			
115V			
120V			
115V			

CIRCUIT #2  
LOADING

120V			
115V			
120V			
115V			

LIGHT CIRCUIT= 0.11A 124W

OPTIONAL

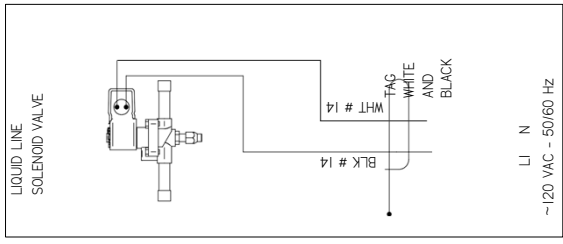

ANTI-SWEAT HEATER  
30W .27A@120 VAC  
0495006

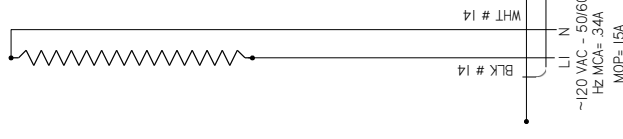

EVAPORATOR FAN MOTOR  
0.07A 12W@120VAC  
121.3174935

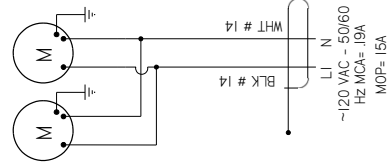

WARMER  
PRODUCT STOP  
HOLDER  
I#38821550  
75 WATTS  
0.63 AMP@120V

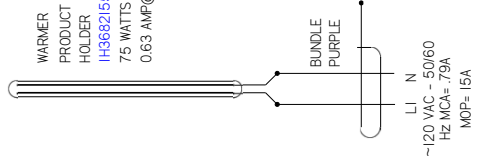

SWITCH TOGGLE  
125-01-0307

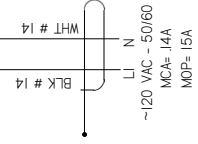

RJ-45 NETWORK JACK  
125-01-0202

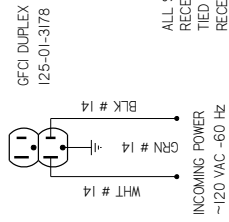

GFCI DUPLEX  
125-01-3178

BUNDLE  
YELLOW

ALL SINGLE  
RECEPTACLES TO BE  
TIED TO DUPLEX GFCI  
RECEPTACLE

GLASS HEATER  
18W .15A@120 VAC  
IH65891

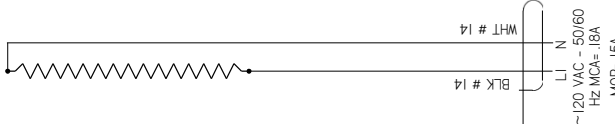

OPTIONAL VIEW ENDS ONLY

WARMER  
125-01-0767  
TYCO THERMAL  
CONTROLS  
108TV-CR  
120 WATTS  
1.1AMP@120V  
141.3 FROSTX

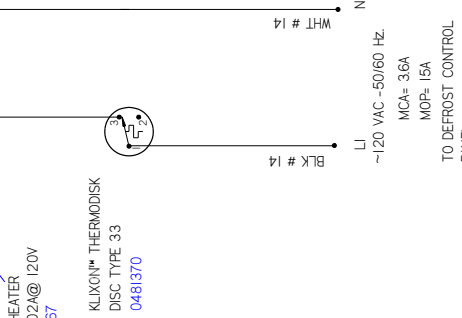
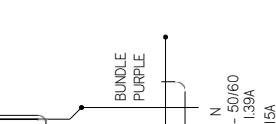

RETURN AIR HEATER  
180W 1.67A@120V  
125-01-3032

DRAIN HEATER  
110W 1.02A@120V  
0488967

KLIXON™ THERMODISK  
DISC TYPE 33  
0481370

LI N  
~120 VAC - 50/60 Hz  
MCA= 36A  
MOP= 15A  
TO DEFFROST CONTROL  
PANEL

LI N  
~120 VAC - 50/60  
Hz MCA= 18A  
MOP= 15A

LI N  
~120 VAC - 50/60  
Hz MCA= 1.39A  
MOP= 15A

LI N  
~120 VAC - 50/60  
Hz MCA= .34A  
MOP= 15A

LI N  
~120 VAC - 50/60  
Hz MCA= 1.9A  
MOP= 15A

LI N  
~120 VAC - 50/60 Hz  
MCA= 14A  
MOP= 15A

LI N  
~120 VAC - 50/60  
Hz MCA= 7.9A  
MOP= 15A

MATERIAL - N/A

DATE DRAWN - 12-1-16

DRAWN BY - CRAIG BOOREY

REVIEWED BY - CRAIG BOOREY

APPROVED BY - CRAIG BOOREY

UNLESS OTHERWISE SPECIFIED DIMENSIONS ARE IN INCHES

TO LEARNERS ART

DECIMALS .XX +03 .XX

ANGLES ± 2°

HUSSMANN

DIAGRAM-

ECN-CAP-00024995

REF -

SHEET 1 OF 1

UNLESS OTHERWISE SPECIFIED DIMENSIONS ARE IN INCHES

TO LEARNERS ART

DECIMALS .XX +03 .XX

ANGLES ± 2°

3020308

B

PROJECTION

E

ANG

THRU

DIMENSIONS ARE IN INCHES

UNLESS OTHERWISE SPECIFIED

APPROVED BY - CRAIG BOOREY

REVIEWED BY - CRAIG BOOREY

DRAWN BY - CRAIG BOOREY

DATE DRAWN - 12-1-16

MATERIAL - N/A

UNLESS OTHERWISE SPECIFIED DIMENSIONS ARE IN INCHES

TO LEARNERS ART

DECIMALS .XX +03 .XX

ANGLES ± 2°



NOTES:  
CASE MUST BE GROUNDED  
WHEN PASSING WIRES THROUGH METAL HOLES A GROMMET MUST BE USED





REV	ECN	DATE	REVISION DESCRIPTION	REV BY	CHKD BY	APPR BY
A	ECN-COD-0013665	5-27-21	RELEASED TO PRODUCTION	CB	CB	CB
B	FEN-COD-0016713	10-11-23	CHANGED EVAP FAN	CB	CB	CB

CIRCUIT #1	LOADING
120V	
14A	

CIRCUIT #2	LOADING
120V	
14A	

CIRCUIT #3	LOADING
120V	
14A	

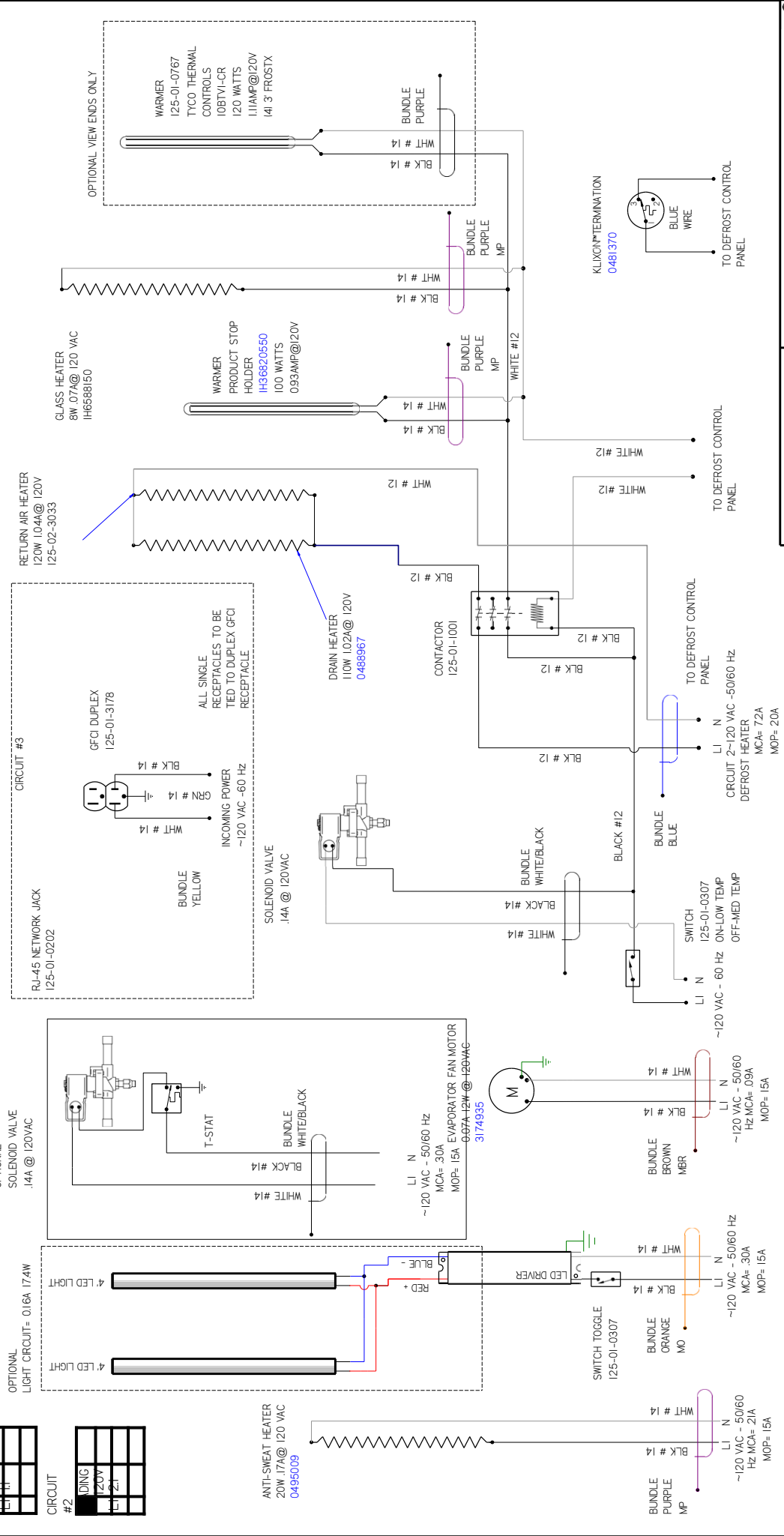

**HUSSMANN**  
**DIAGRAM-SFNG-4-**  
**R KOOLGAS**  
**DEFROST DUAL**  
**TEMP 3149823**  
**B**

FACTORY 14GA WIRE  
 \_FACTORY LOGGA WIRE  
 --- FIELD WIRE ---  
 --- DO NOT SCALE DRAWING ---  
 SHEET 1 OF 1

UL COLOR CODES / ABBREVIATIONS  
 RED = RD  
 BLACK = BK  
 BLUE = BL  
 YELLOW = YL  
 GRAY = GR  
 WHITE = WT  
 GREEN = GN  
 BROWN = BN  
 ORANGE = OR  
 PURPLE = VT

- NOTES:  
 1. PRINTED DOCUMENT REQUIRED SETTING: ALL COLORS BLACK & WHITE  
 2. CASE & ANY REMOVABLE PANEL WITH ELECTRICAL PARTS MUST BE GROUNDED.  
 3. WHEN PASSING WIRES THROUGH METAL HOLES A GROMMET MUST BE USED

## Troubleshooting Guide

Problem	Possible Cause	Possible Solution
<b>Case temperature is too warm.</b>	Ambient conditions may be affecting the case operation.	Check case position in store. Is the case located near an open door, window, electric fan or air conditioning vent that may cause air currents? Case must be located minimum 15 Ft away from doors or windows. Cases are designed to operate at 55% Relative humidity and a temperature of 75°F.
	Discharge air temp is out of spec.	Check evaporator fan operation. Check electrical connections and input voltage.
		Fans are installed backwards. Check airflow direction.
		Fan blades are installed incorrectly. Make sure fan blades have correct pitch and are per specification.
		Check to see that fan plenum is installed correctly. It should not have any gaps.
		Check suction pressure and insure that it meets factory specifications.
	Case is in defrost.	Check defrost settings. See Technical Specifications section.
	Product load may be over its limits blocking airflow.	Redistribute product so it does not exceed load level. There is a sticker on the inside of the case indicating what the maximum load line is.
	Coil is freezing over.	Return air is blocked, make sure debris is not blocking the intake section.
Coil close-offs are not installed. Inspect coil to make sure these parts are on the case.		
Condensing coil or evaporator coil is clogged or dirty.	Clean coil.	
<b>Case temperature is too cold.</b>	The t-stat temp is set too low.	Check settings. See Technical Specifications section.
	Ambient conditions may be affecting the case operation.	Check case position in store. Is the case located near an open door, window, electric fan or air conditioning vent that may cause air currents? Case must be located minimum 15 Ft away from doors or windows. Cases are designed to operate at 55% Relative humidity and a temperature of 75°F.
<b>Condensation on glass.</b>	Ambient conditions may be affecting the case operation.	Check case position in store. Is the case located near an open door, window, electric fan or air conditioning vent that may cause air currents? Case must be located minimum 15 Ft away from doors or windows. Cases are designed to operate at 55% Relative humidity and a temperature of 75°F.
	Inadequate air circulation.	Check if air sweep fans are functioning, check electrical connections.
	There is not enough heat provided in the airflow.	Check if air sweep heater is functioning, check electrical connections.
	There are glass gaps on the side of the case.	See glass adjustment section.
	Glass is not completely shut.	Close glass correctly.

### Troubleshooting (Cont'd)

Problem	Possible Cause	Possible Solution
<b>Water has pooled under case.</b>	Case drain is clogged.	Clear drain.
	PVC drains under case may have a leak.	Repair as needed.
	Case tub has unsealed opening.	Seal as needed.
	If the case is in a line-up, case to case joint is missing or unsealed.	Install case to case joint and seal as needed.
	Evaporator pan is overflowing (if applicable).	Check electrical connection to evaporator pan. Check float assembly, it should move freely up and down the support stem. Clear any debris.
<b>Case is not draining properly.</b>	Case is not level.	Level the case.
	Drain screen is plugged.	Clean drain screen and remove any debris.
	Drain or P-trap is clogged.	Clear any debris.
<b>Frost or ice on evaporator coil.</b>	Evaporator fans are not functioning.	Check electrical connections.
	Defrost clock is not functioning.	Case should be serviced by a qualified service technician.
	Coil is freezing over.	Return air is blocked, make sure debris is not blocking the intake section.
Coil close-offs are not installed. Inspect coil to make sure these parts are on the case.		
<b>Large gap is visible on bottom of front glass or glass can't be opened because it is too low.</b>	Glass Height adjusters need to be adjusted.	See Glass Adjustment section.
<b>Large gaps are visible in between glass panels or glass rubs against end panel.</b>	Glass/glass clamp assembly needs to be adjusted.	See Glass Adjustment section.
<b>Front glass does not stay open and falls closed.</b>	Glass shock/piston may need to be replaced.	Case should be serviced by a qualified service technician.
<b>Lights do not come on.</b>	LED Driver/light socket wiring.	Check electrical connections. See Electrical Section and check wiring diagram.
	Driver needs to be replaced.	Case should be serviced by a qualified service technician. See Electrical Section.
	Lamp socket needs to be replaced.	Case should be serviced by a qualified service technician.
	Lamp needs to be replaced.	See Maintenance Section.
	Light Switch needs to be replaced.	Case should be serviced by a qualified service technician.

## Appendices

### Appendix A. - Temperature Guidelines - Refrigerated

The refrigerators should be operated according to the manufacturer's published engineering specifications for entering air temperatures for specific equipment applications. Table 1 shows the typical temperature of the air entering the food zone one hour before the start of defrost and one hour after defrost for various categories of refrigerators. Refer to Appendix C for Field Evaluation Guidelines.

Type of Refrigerator	Typical Entering Air Temperature
<b>I. OPEN DISPLAY</b>	
A. Non frozen:	
1) Meat	28°F
2) Dairy/Deli	32°F
3) Produce	
a. Processed	36°F
b. Unprocessed	45°F
B. Frozen	0°F
C. Ice Cream	-5°F
<b>II. CLOSED DISPLAY</b>	
A. Non frozen:	
1) Meat	34°F
2) Dairy/Deli	34°F
3) Produce	
a. Processed	36°F
b. Unprocessed	45°F
B. Frozen	0°F
C. Ice Cream	-5°F

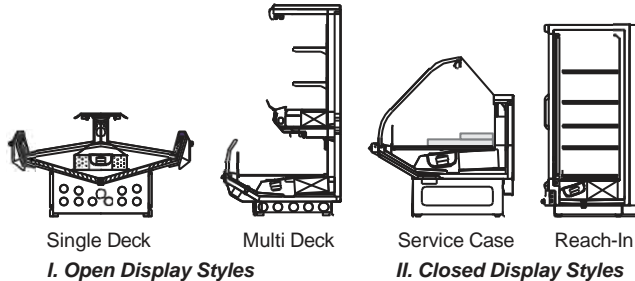

### Appendix B. - Application Recommendations - Refrigerated

1. Temperature performance is critical for controlling bacteria growth. Therefore, the following recommendations are included in the standard. They are based on confirmed field experience over many years.
2. The installer is responsible for following the installation instructions and recommendations provided by Hussmann for the installation of each individual type refrigerator.
2. Refrigeration piping should be sized according to the equipment manufacturer's recommendations and installed in accordance with normal refrigeration practices. Refrigeration piping should be insulated according to Hussmann's recommendations.

3. A clogged waste outlet blocks refrigeration. The installer is responsible for the proper installation of the system which dispenses condensate waste through an air gap into the building indirect waste system.
4. The installer should perform a complete start-up evaluation prior to the loading of food into the refrigerator, which includes such items as:
  - a) Initial temperature performance, Coils should be properly fed with a refrigerant according to manufacturer's recommendations.
  - b) Observation of outside influences such as drafts, radiant heating from the ceiling and from lamps. Such influence should be properly corrected or compensated for.
  - c) At the same time, checks should be made of the store dry-bulb and wet-bulb temperatures to ascertain that they are within the limits prescribed by Hussmann.
  - d) Complete start-up procedures should include checking through a defrost to make certain of its adequate frequency and length without substantially exceeding the actual needs. This should include checking the electrical or refrigerant circuits to make sure that defrosts are correctly programmed for all the refrigerators connected to each refrigeration system.
  - e) Recording instruments should be used to check performance.

### Appendix C. - Field Recommendations - Refrigerated

#### Recommendations for field evaluating the performance of retail food refrigerators and hot cases

- 1.0 The most consistent indicator of display refrigerator performance is temperature of the air entering the product zone (see Appendix A). In practical use, the precise determination of return air temperature is extremely difficult. Readings of return air temperatures will be variable and results will be inconsistent. The product temperature alone is not an indicator of refrigerator performance.

**NOTE:** Public Health will use the temperature of the product in determining if the refrigerator will be allowed to display potentially hazardous food. For the purpose of this evaluation, product temperature above the FDA Food Code 1993 temperature for potentially hazardous food will be the first indication that an evaluation should be performed. It is expected that all refrigerators will keep food at the FDA Food Code 1993 temperature for potentially hazardous food.

## Appendices (Cont'd)

1. The following recommendations are made for the purpose of arriving at easily taken and understood data which, coupled with other observations, may be used to determine whether a display refrigerator is working as intended:
  - a) **INSTRUMENT** - A stainless steel stem-type thermometer is recommended and it should have a dial a minimum of 1 inch internal diameter. A test thermometer scaled only in Celsius or dually scaled in Celsius and Fahrenheit shall be accurate to 1°C (1.8°F). Temperature measuring devices that are scaled only in Fahrenheit shall be accurate to 2°F. The thermometer should be checked for proper calibration. (It should read 32°F when the stem is immersed in an ice water bath).
  - b) **LOCATION** - The probe or sensing element of the thermometer should be located in the airstream where the air first enters the display or storage area, and not more than 1 inch away from the surface and in the center of the discharge opening.
  - c) **READING** - It should first be determined that the refrigerator is refrigerating and has operated at least one hour since the end of the last defrost period. The thermometer reading should be made only after it has been allowed to stabilize, i.e., maintain a constant reading.
  - d) **OTHER OBSERVATIONS** - Other observations should be made which may indicate operating problems, such as unsatisfactory product, feel/appearance.
  - e) **CONCLUSIONS** - In the absence of any apparent undesirable conditions, the refrigerator should be judged to be operating properly. If it is determined that such condition is undesirable, i.e., the product is above proper temperature, checks should be made for the following:
    1. Has the refrigerator been loaded with warm product?
    2. Is the product loaded beyond the "Safe Load Line" markers?
    3. Are the return air ducts blocked?
    4. Are the entering air ducts blocked?
    5. Is a dumped display causing turbulent air flow and mixing with room air?
    6. Are spotlights or other high intensity lighting directed onto the product?
    7. Are there unusual draft conditions (from heating/air-conditioning ducts, open doors, etc.)?
  8. Is there exposure to direct sunlight?
  9. Are display signs blocking or diverting airflow?
  10. Are the coils of the refrigerator iced up?
  11. Is the store ambient over 75°F, 55% RH as set forth in ASHRAE Standard 72 and ASHRAE Standard 117?
  12. Are the shelf positions, number, and size other than recommended by Hussmann?
  13. Is there an improper application or control system?
  14. Is the evaporator fan motor/blade inoperative?
  15. Is the defrost time excessive?
  16. Is the defrost termination, thermostat (if used) set too high?
  17. Are the refrigerant controls incorrectly adjusted?
  18. Is the air entering the condenser above design conditions? Are the condenser fins clear of dirt, dust, etc.?
  19. Is there a shortage of refrigerant?
  - f) **READING** - The thermometer reading should be made only after it has been allowed to stabilize, i.e., maintain a constant reading. Loading Product: Cases should be allowed to heat up for one hour before product is loaded. Temperature adjustments: Allow 4 hours after adjustment has been made before testing pulp temperature of product.
  - g) **OTHER OBSERVATIONS** - Other observations should be made which may indicate operating problems, such as unsatisfactory product, feel/appearance.

### Appendix D. - Recommendations to User - Refrigerated

- 1.0 Hussmann Corporation provides instructions and recommendations for proper periodic cleaning. The user will be responsible for such cleaning, including the cleaning of low temperature equipment within the compartment and the cooling coil area(s). Cleaning practices, particularly with respect to proper refrigerator unloading and warm-up, must be in accordance with applicable recommendations.

---

## Appendices (Cont'd)

- 1.1 Cleaning of non frozen food equipment should include a weekly cleaning of the food compartment as a minimum to prevent bacteria growth from accumulating. Actual use and products may dictate more frequent cleaning. Circumstances of use and equipment design must also dictate the frequency of cleaning the display areas. Weekly washing down of the storage compartment is also recommended, especially for equipment subject to drippage of milk or other liquids, or the collection of vegetable, meat, crumbs, etc. or other debris or litter. Daily cleaning of the external areas surrounding the storage or display compartments with detergent and water will keep the equipment presentable and prevent grime buildup.
2. Load levels as defined by the manufacturer must be observed.
3. The best preservation is achieved by following these rules:
  - a) Buy quality products.
  - b) Receive perishables from transit equipment at the ideal temperature for the particular product.
  - c) Expedite perishables to the store's storage equipment to avoid unnecessary warm-up and prolonged temperature recovery. Food store refrigerators are not food chillers nor can they reclaim quality lost through previous mishandling.
  - d) Care must be taken when cross merchandising products to ensure that potentially hazardous vegetable products are not placed in non refrigerated areas.
  - e) Display and storage equipment doors should be kept closed during periods of inactivity.
  - f) Minimize the transfer time of perishables from storage to display.
  - g) Keep meat under refrigeration in meat cutting and processing area except for the few moments it is being handled in processing. When a cut or tray of meat is not to be worked on immediately, the procedure should call for returning it to refrigeration.
  - h) Keep tools clean and sanitized. Since mechanical equipment is used for fresh meat processing, all such equipment should be cleaned at least daily and each time a different kind of meat product comes in contact with the tool or equipment.
  - i) Make sure that all refrigeration equipment is installed and adjusted in strict accordance with the manufacturer's recommendations.
  - j) See that all storage and refrigeration equipment is kept in proper working order by routine maintenance.



---

This warning does not mean that Hussmann products will cause cancer or reproductive harm, or is in violation of any product-safety standards or requirements. As clarified by the California State government, Proposition 65 can be considered more of a ‘right to know’ law than a pure product safety law. When used as designed, Hussmann believes that our products are not harmful. We provide the Proposition 65 warning to stay in compliance with California State law. It is your responsibility to provide accurate Proposition 65 warning labels to your customers when necessary. For more information on Proposition 65, please visit the California State government website.

---

**Service Record**

Last service date:      By:

_____	_____
_____	_____
_____	_____
_____	_____
_____	_____
_____	_____
_____	_____

---

**HUSSMANN®/Chino**

Additional copies of this publication may be obtained by contacting:  
Hussmann® Chino  
13770 Ramona Avenue • Chino, California 91710  
(909) 628-8942 FAX  
(909) 590-4910  
(800) 395-9229

The <i>MODEL NAME</i> and <i>SERIAL NUMBER</i> is required in order to provide you with the correct parts and information for your particular unit. They can be found on a small metal plate on the unit. Please note them below for future reference.
<b>MODEL:</b>
<b>SERIAL NUMBER:</b>