

HUSSMANN[®]

microDS[™]

RMN-W
 with INNOVATOR Doors
 Water-cooled
 Self-Contained
 R290 (Propane)

Merchandise Data Sheet

P/N 3086449_A

UL EPH[®] Certified

April 2019

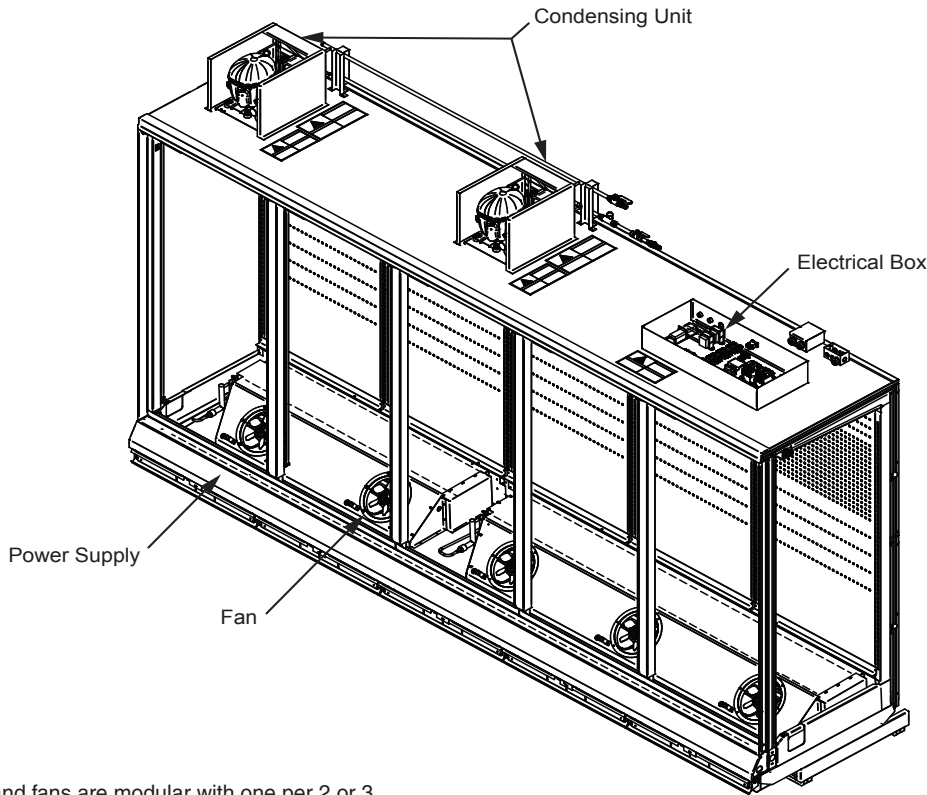

DOE 2017
 Energy Efficiency
 Compliant



*Coils and fans are modular with one per 2 or 3 door section.

Portion of parts removed for clarity.

5 door merchandiser shown.

UL EPH Certification

This merchandiser model is manufactured to meet ANSI/SCC Standards requirements for construction, materials, and cleanability.

IMPORTANT

ONE FLOOR DRAIN IS
 REQUIRED FOR EACH CASE.

Performance Data	Page 2	Shelf Options	Page 6
Product Data (AHRI Statistics)	Page 2	Replacement Parts List	Page 7
Cross Section	Page 3	Wiring Diagrams	Page 8
Plan View	Page 4	Top Views	Page 15
Electrical Loads	Page 5	Revision History	Page 19
Estimated Shipping Weights	Page 6		

Data sheet-Reach-in-RMN-W

We reserve the right to change or revise specifications and product design in connection with any feature of our products. Such changes do not entitle the buyer to corresponding changes, improvements, additions or replacements for equipment previously sold or shipped.

RMN-W

Medium Temperature

Refrigeration Data ¹

RMN-W			
Application		Optimal Shelf Life	AHRI Rating
Temperature	Discharge Air °F (°C)	34 (1.11)	37 (2.78)

Notes:

- All data based on store temperature and humidity that does not exceed NSF Type 1 ambient conditions of 75°F and 55% relative humidity, except where noted.
- Water supply design conditions are 41 to 118°F (5 to 48°C).

Compressor Data

Total Heat of Rejection	BTU/Hr
2 Dr	1,830
3 Dr	2,355
4 Dr	3,660
5 Dr	4,185

Defrost Data

Frequency (hours between defrost) 24

	RMN-W
Time (minutes)	60
Temp Termination (°F)	N/A

Off-Time

Defrost Water ³ 0.36 lb/dr/day
(0.15 kg/m)

³ (± 15% based on case configuration and product loading).

RMN-W

Cooling Water Pressure Drop ⁴

	PSI
2 Dr	2.5
3 Dr	2.5
4 Dr	2.5
5 Dr	2.5

Cooling Water Design TD 10°F

⁴ Auto-Balancing Valve requires a minimum of 2 PSI to operate. Subtract 2 PSI if the Auto-Balancing Valve is not supplied.

RMN-W Glycol/Water Flow Rate ⁵

	GPM	LPM
2 Dr	1.0	3.8
3 Dr	1.0	3.8
4 Dr	1.0	3.8
5 Dr	1.5	5.7

Charge per unit ⁶

2 Dr	0.33 lb	5.3 oz	150 g
3 Dr	0.29 lb	4.6 oz	130 g
4 Dr	0.33 lb	5.3 oz	150 g
5 Dr	0.33 lb	5.3 oz	150 g

⁵ Use a pre-mixed inhibited glycol solution. If the mixing is to be done on site, use only distilled or de-ionized water (do not use city water).

⁶ Maximum R290 charge per condensing unit = 150 g.

⁶ Charge per unit per coil section.

Product Data

Gross Refrigerated Volume ⁷ (Cu Ft/Ft)	22.80 ft ³ /ft (0.65 m ³ /m)
AHRI Total Display Area ⁸ (Sq Ft/Ft)	13.04 ft ² /ft (1.21 m ² /m)
Shelf Area ⁹ (Sq Ft/Ft)	28.50 ft ² /ft (2.65 m ² /m)

⁷ AHRI Gross Refrigerated Volume: Refrigerated Volume/Unit of Length, ft³/ft [m³/m]

⁸ Computed using AHRI 1200 standard methodology: Total Display Area, ft² [m²]/Unit of Length, ft [m]

⁹ Shelf surface area is composed of bottom deck plus standard shelf complement for this model: (5) 22-inch shelves, evenly distributed vertically.

Self-Contained R290 Propane Reach-in Merchandiser,
 2, 3, 4 & 5 Door Models, 6 Display Levels,
 Water-cooled, Self-Contained R290 Propane

RMN-W
 Medium Temperature

DOE 2017
 Energy Efficiency
 Compliant

Husmann refrigerated merchandisers configured for sale for use in the United States meet or surpass the requirements of the DOE 2017 energy efficiency standards.

Shelf complement shown as tested:
 Five rows of shelves (22-in) spaced
 equally between bottom display pan
 and interior top panel.

Dimensions shown as in. and (mm).

4-in. between back to back cases.

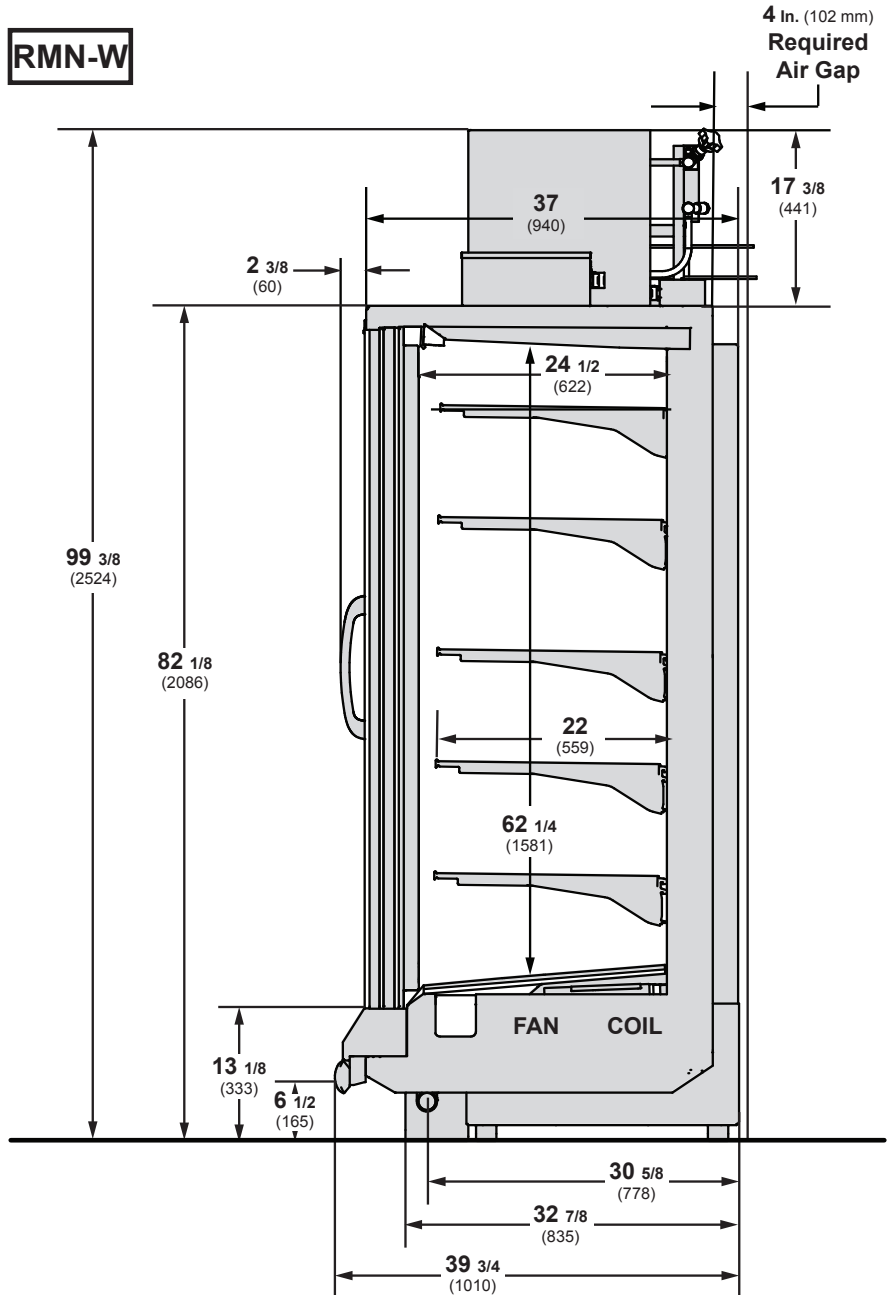

UL EPH Certification

This merchandiser model is manufactured to meet ANSI/SCC Standards requirements for construction, materials, and cleanability.

Engineering Plan View

RMN-W

Dimensions shown as in. and (mm).

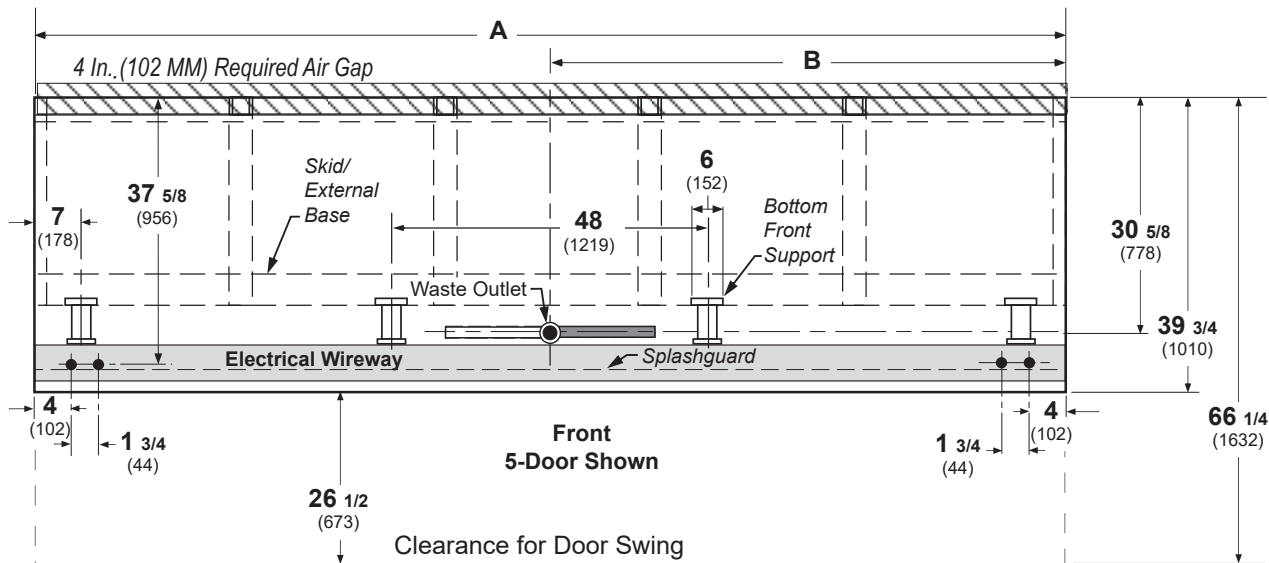

(5 Door Model shown above)

	2 Dr	3 Dr	4 Dr	5 Dr
General				
(A) Case Length (without ends or partitions) Each end and insulated partition adds 2 in. (51 mm) to case line up; each window end or insulated partition adds 1 1/2 in. (38 mm).	62 (1575)	92 1/2 (2350)	122 7/8 (3121)	153 3/8 (3896)
Maximum O/S dimension of case back to front (includes bumper) (Add 26 1/2 in (673 mm) for door swing.)	39 3/4 (1010)	39 3/4 (1010)	39 3/4 (1010)	39 3/4 (1010)
Back of case to rear of splashguard	35 3/4 (908)	35 3/4 (908)	35 3/4 (908)	35 3/4 (908)
Width of Skidrail	3 3/4 (95)	3 3/4 (95)	3 3/4 (95)	3 3/4 (95)
Width of Bottom Front Support	6 (152)	6 (152)	6 (152)	6 (152)
Stub-up area between front support and splashguard	3 1/8 (79)	3 1/8 (79)	3 1/8 (79)	3 1/8 (79)
Electrical Service (Field Electrical Wiring Connection)				
RH End of case to center of Electrical Wiring Connection (top of case)	13 3/4 (349)	13 3/4 (349)	13 3/4 (349)	13 3/4 (349)
Back outside of case to center of Electrical Wiring Connection	5 1/2 (140)	5 1/2 (140)	5 1/2 (140)	5 1/2 (140)
Waste Outlets (with required drain extension)				
(B) RH End of case to the center of waste outlet	23 7/8 (606)	54 1/4 (1378)	46 1/4 (1175)	76 5/8 (1946)
Back O/S of case to center of waste outlet	30 5/8 (778)	30 5/8 (778)	30 5/8 (778)	30 5/8 (778)
Schedule 40 PVC drip pipe	1 1/4 (32)	1 1/4 (32)	1 1/4 (32)	1 1/4 (32)
Water Seal				
Edge of water seal to center of waste outlet	13 (330)	13 (330)	13 (330)	13 (330)
**NOTE: Field installed water seal outlets, tees, and connectors are shipped with the case.				

Electrical Data

Number of Fans 8.25-in.	2 dr	3 dr	4 dr	5 dr						
	2	3	4	5						
		Amperes					Watts			
Evaporator Fan 120V 50/60Hz	2 dr	3 dr	4 dr	5 dr	2 dr	3 dr	4 dr	5 dr	5 dr	
	0.60	0.90	1.20	1.50	36	54	72	90		
Frame Anti-sweat Heaters (on fan circuit) 120V 50/60Hz	0.39	0.59	0.79	0.99	47	71	94	118		
Condensing Unit (120V, 1 ph, 60 Hz) Standard NOTE: One compressor can start at a time.										
Compressor RLA	2.9		2.9		5.8		5.8			
Compressor LRA	14.9/unit		14.9/unit		14.9/unit		14.9/unit			
Merchandise Circuit Requirements (120V, 1 Ph, 60 Hz)										
Total Amps	4.8	5.4	9.0	9.7						
MCA	5.8	6.6	11.0	11.8						
Maximum Over Current Protection	15.0	15.0	15.0	15.0						

NEMA Plug



NEMA 5-15P

Optional Electrical Plug - NEMA 5-15P/120V

ONLY LIGHTING CONFIGURATIONS THAT ARE COMPLIANT WITH THE U.S. DEPT. OF ENERGY (DOE) 2017 REGULATION ARE AVAILABLE FOR SALE FOR USE IN THE U.S.A.

STANDARD LIGHTING

EcoShine II	2 Dr	3 Dr	4 Dr	5 Dr	2 Dr	3Dr	4 Dr	5 Dr
120V	0.31	0.46	0.62	0.77	37.1	55.6	74.2	92.7
220V Export	0.17	0.25	0.34	0.42	37.1	55.6	74.2	92.7

OPTIONAL LIGHTING

EcoShine II	2 Dr	3 Dr	4 Dr	5 Dr	2 Dr	3Dr	4 Dr	5 Dr
[22 W] 120V	0.36	0.52	0.68	0.84	43.2	62	81	100
[22 W] 220V Export	0.20	0.28	0.37	0.46	43.2	62	81	100
GE Illumination	2 Dr	3 Dr	4 Dr	5 Dr	2 Dr	3Dr	4 Dr	5 Dr
120V	0.30	0.45	0.60	0.75	36	54	72	90
220V Export	0.16	0.25	0.33	0.41	36	54	72	90

RMN-W
Medium Temperature

ENDS or PARTITIONS

Each standard end and each insulated partition adds 2 in. (38 mm) to case line up.

PHYSICAL DATA

Merchandiser Drip Pipe (in.) 1 1/4
Schedule 40 PVC

ESTIMATED SHIPPING WEIGHT †

Case	2 Dr	3 Dr	4 Dr	5 Dr	Solid End (each)
lb (kg)	945 (429)	1172 (532)	1645 (746)	1924 (873)	55 (25)

† Actual weights will vary according to optional kits included.

Shelf Options

Approved shelf sizes for standard (horizontal, 2-3 position brackets) displays:

20-inch
22-inch

Contact engineering for non-standard display recommendations.

Optimal number of Shelves: 5 per door

Maximum number of Shelves: 5 per door

Standard shelf complement for test purposes: (5 per door) 22-inch shelves, evenly distributed vertically

Replacement Parts List

Part #	Description	Part #	Description
FAN ASSEMBLIES		CORELINK CONTROL	
2-Dr & 4 Dr		0554376	CoreLink Controller
Standard HE Fan Assembly		3013759	Discharge Air Sensor
0529672	Fan Assembly	3047275	Fan / Light Relay
0527610	Fan Motor	3051962	Pressure Switch
0461805	Fan Blade		
LED FIXTURES AND POWER SUPPLY		REFRIGERATION SYSTEM	
0499399	Power Supply	0528947	Capillary Tube 2, 4 & 5 Door
	LED Fixture	3024061	Compressor 2, 4 & 5 Door
	<i>Replace with like fixtures.</i>	0530462	Filter/drier
		3031242	Heat Exchanger
COILS		WATER LINE	
0530400	2 Door & 4 Door	0527748	Strainer, Water
0530429	3 Door & 5 Door	0527742	Balancing Valve (Adjustable)
		3040938	2,3,4 Door Auto-Balancing Valve
			1.0 GPM (Optional)
HONEYCOMB - WHITE		3042623	5 Door Auto-Balancing Valve
0495287	2 Door & 4 Door		1.5 GPM (Optional)
0495261	3 Door		
0495262	5 Door		
RELAYS			
3048148	Compressor Relay		

NOTE: For LED lighting parts contact your Hussmann service representative at 1-800-922-1919. Please have your model and serial number available. Descriptions including size and color are at [HTTP://WWW.HUSSMANN.COM/EN/PRODUCTS/LED-LIGHTING/PAGES/DEFAULT.ASPX](http://www.hussmann.com/en/products/led-lighting/pages/default.aspx).

FOR ADDITIONAL PARTS INFORMATION, VISIT [HTTP://WWW.HUSSMANN.COM/EN/PAGES/AFTERMARKET-PARTS.ASPX](http://www.hussmann.com/en/pages/aftermarket-parts.aspx)

RMN-W

Medium Temperature

CoreLink Propane

Wiring - 2 & 3 Door

REVISION HISTORY		REVISION DESCRIPTION	REV BY/CHKD BY	APPR BY
REV	ECN	DATE	ECN	AGA
A	ECN-NPD-0001527	2018/12/07	ECN	AGA
		RELEASED TO PRODUCTION		

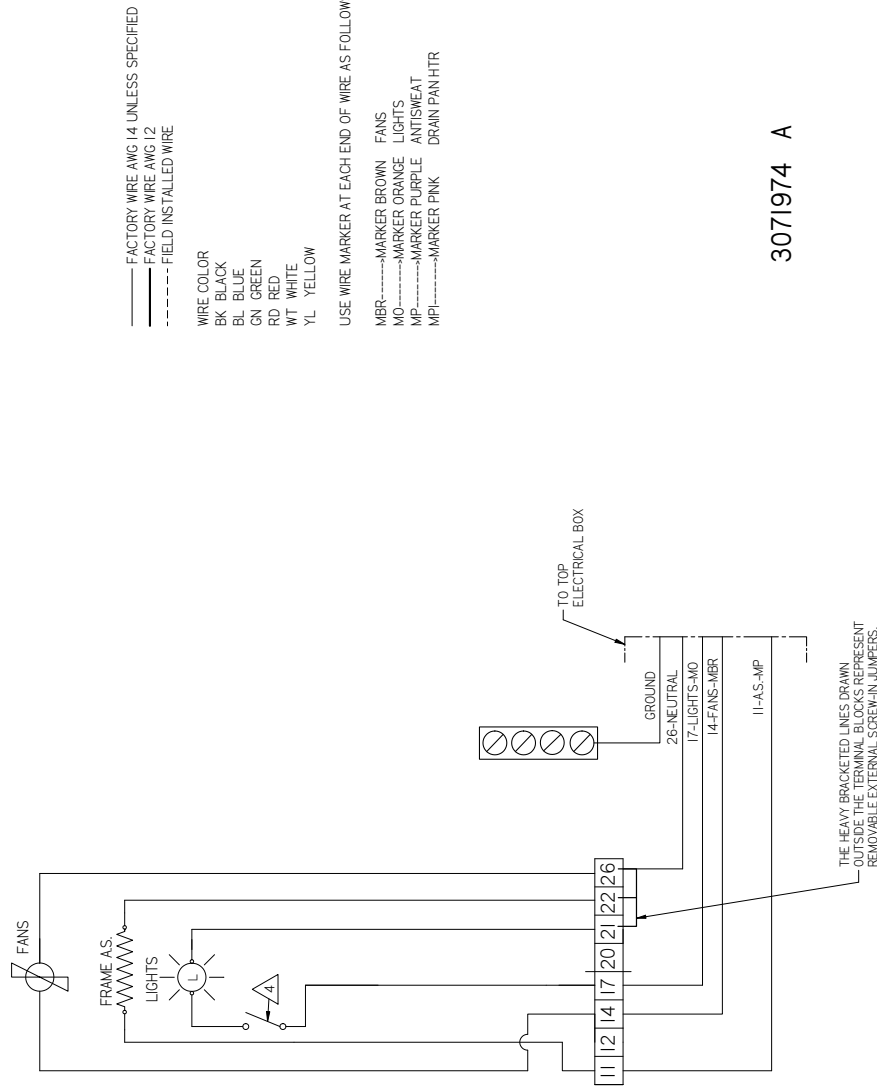

_____ FACTORY WIRE AWG 14 UNLESS SPECIFIED
 _____ FACTORY WIRE AWG 12
 - - - - - FIELD INSTALLED WIRE

WIRE COLOR
 BK BLACK
 BL BLUE
 GN GREEN
 RD RED
 WT WHITE
 YL YELLOW

USE WIRE MARKER AT EACH END OF WIRE AS FOLLOWS:

MBR-----MARKER BROWN FANS
 MO-----MARKER ORANGE LIGHTS
 MP-----MARKER PURPLE ANTISWEAT
 MPI-----MARKER PINK DRAIN PAN HTR

3071974 A

- NOTES:
1. APPLICABLE STANDARDS / SPECIFICATIONS
ASME Y14.5M-1994, DIMENSIONS AND TOLERANCES
 2. KEY PRODUCT CHARACTERISTICS PER EPR-0006 & IDENTIFIED WITH SYMBOL
 3. REF 3060859
 4. LIGHT SWITCH MAY NOT BE PROVIDED WITH CASE FOR CERTAIN CONFIGURATIONS
 5. ALL WIRES GETTING INSERTED INTO THE CONTACTOR MUST USE FORK TERMINALS 0383151 OR 0383152
TORQUE ON TERMINAL SCREWS NOT TO EXCEED 12 IN-LBS

CoreLink Propane Wiring - 2 & 3 Door

RMN-W
Medium Temperature

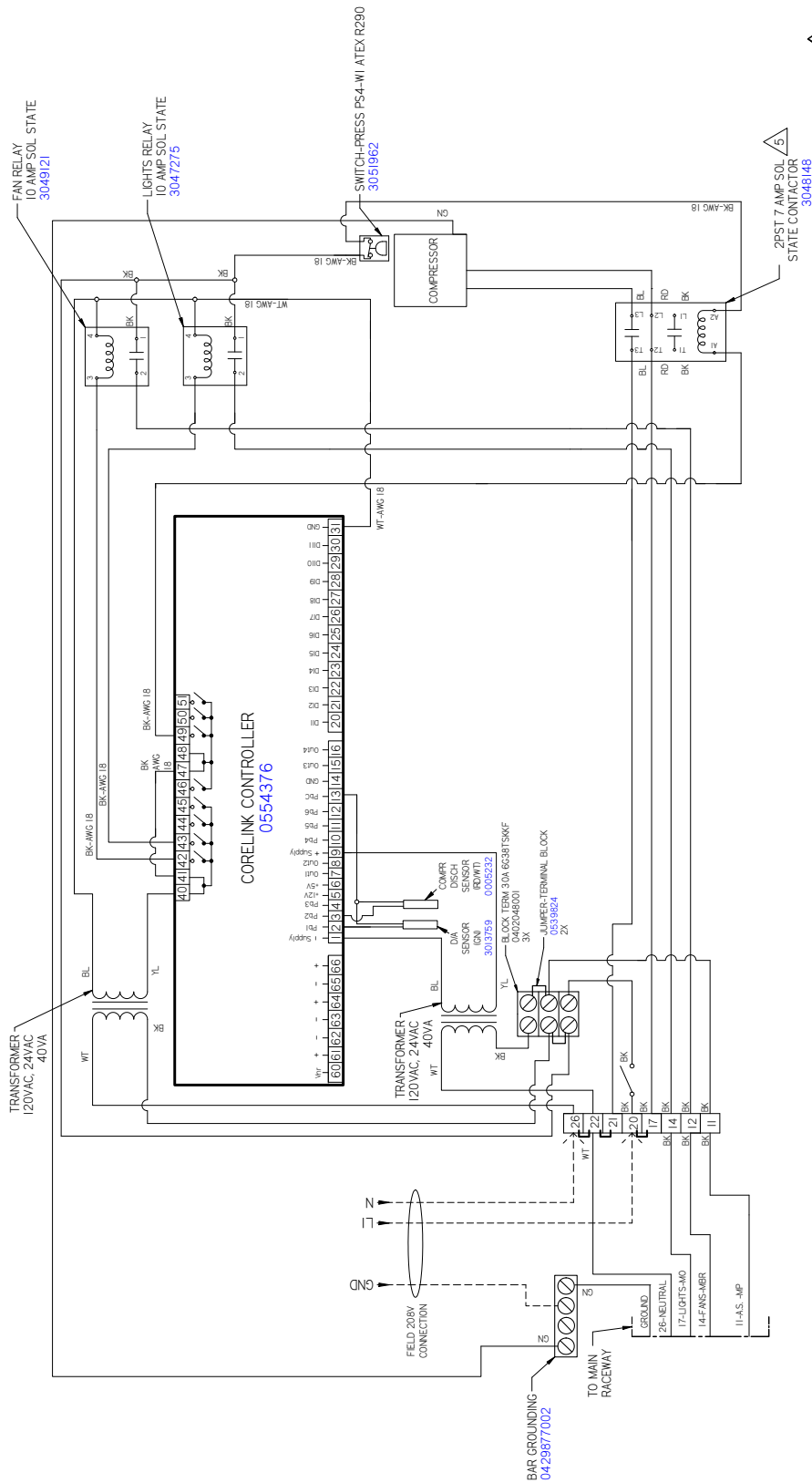

- NOTES:
1. APPLICABLE STANDARDS / SPECIFICATIONS: ASME Y14.5M-1994. DIMENSIONS AND TOLERANCES
 2. KEY PRODUCT CHARACTERISTICS PER EPR-0006 & IDENTIFIED WITH SYMBOL
 3. REF 3060959
 4. LIGHT SWITCH MAY NOT BE PROVIDED WITH CASE FOR CERTAIN CONFIGURATIONS
 5. ALL WIRES GETTING INTO THE CONTACTOR MUST USE FORK TERMINALS 0383151 OR 0383152
 6. TORQUE ON TERMINAL SCREWS NOT TO EXCEED 12 IN-LBS

3071974 A

RMN-W

Medium Temperature

CoreLink Propane

Wiring - 4 & 5 Door

REVISION HISTORY		REVISION DESCRIPTION	REV BY	CHKD BY	APPR BY
A	ECN-NPD-0001527	2018/12/07	ECAY	AGA	AGA
B	ECN-NPD-0001847	2019/02/07	ADD 2 RELAY 3049121 AND 1 RELAY 3050554	ECAY	AGA

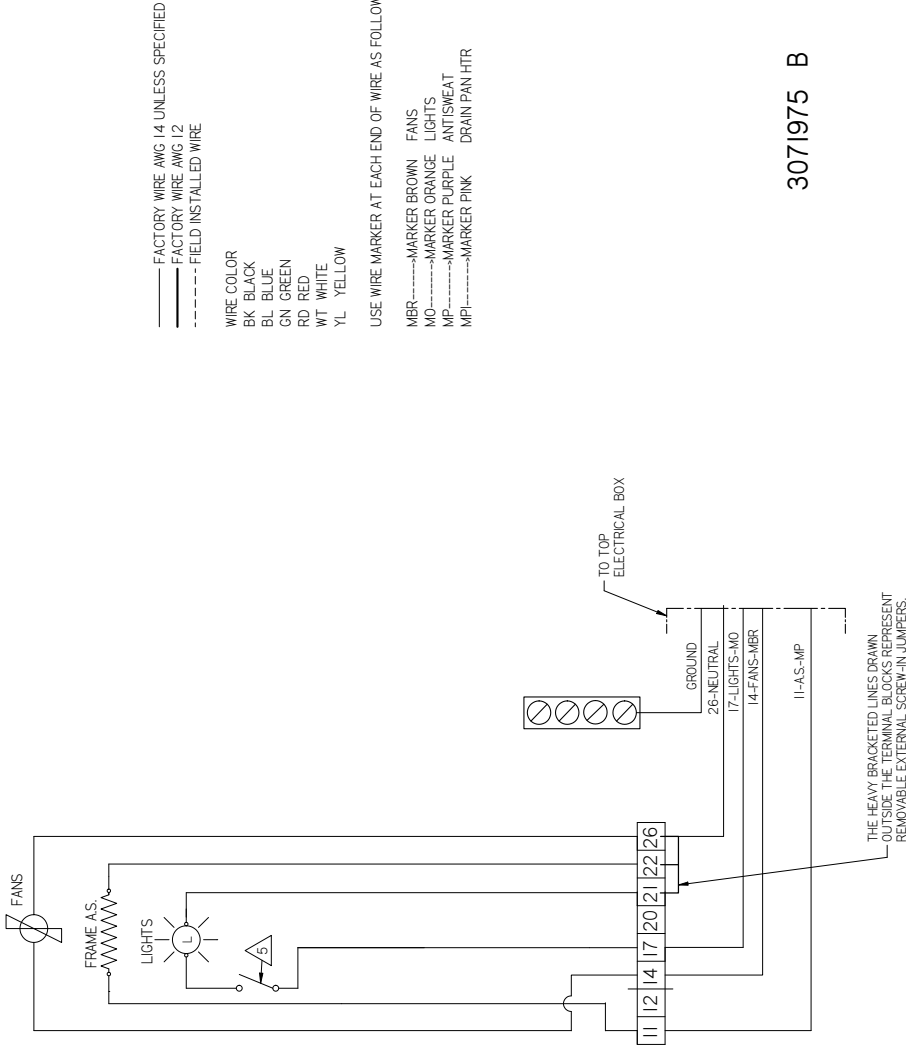

_____ FACTORY WIRE AWG 14 UNLESS SPECIFIED
 _____ FACTORY WIRE AWG 12
 - - - - - FIELD INSTALLED WIRE

WIRE COLOR
 BK BLACK
 BL BLUE
 GN GREEN
 RD RED
 WT WHITE
 YL YELLOW

USE WIRE MARKER AT EACH END OF WIRE AS FOLLOWS
 MBR-----MARKER BROWN FANS
 MO-----MARKER ORANGE LIGHTS
 MP-----MARKER PURPLE ANTSWEAT
 MPI-----MARKER PINK DRAIN PAN/HTR

3071975 B

- NOTES
1. APPLICABLE STANDARDS / SPECIFICATIONS
 2. ASME Y14.5M-1984 DIMENSIONS AND TOLERANCES
 3. REF 3060960 CHARACTERISTICS PER EPR-0008 & IDENTIFIED WITH SYMBOL
 4. ADD PURPLE MARKERS AT EACH END OF ALL SENSORS MARKED WITH 2 OR 4 TO SIGNIFY RH OF CASE
 5. LIGHT SWITCH MAY NOT BE PROVIDED WITH CASE FOR CERTAIN CONFIGURATIONS
 6. ALL WIRES GETTING INSERTED INTO THE CONTACTORS MUST USE FORK TERMINALS 0383151 OR 0383152 TORQUE ON TERMINAL SCREWS NOT TO EXCEED 12 IN-LBS

**RMN-W
Top Views**

**RMN-W
Medium Temperature**

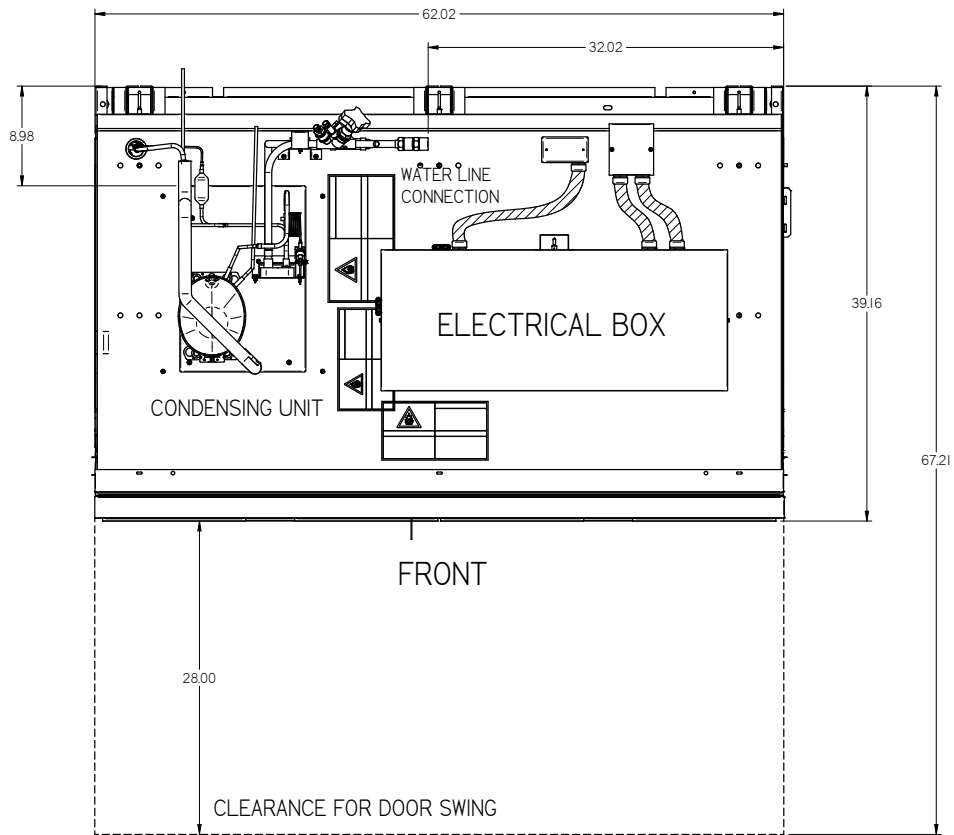

RMN-W
Medium Temperature

RMN-W
Top Views

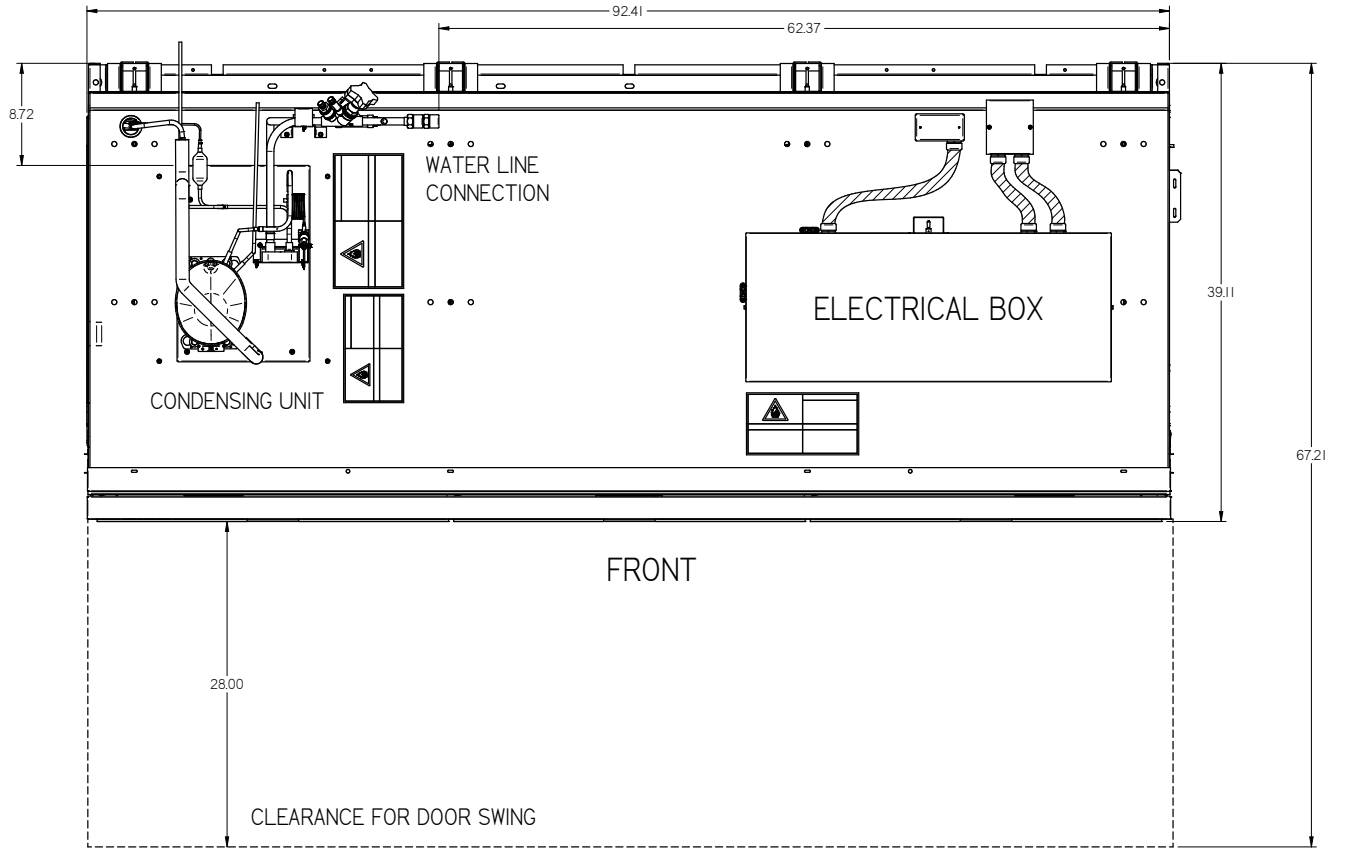

**RMN-W
Top Views**

**RMN-W
Medium Temperature**

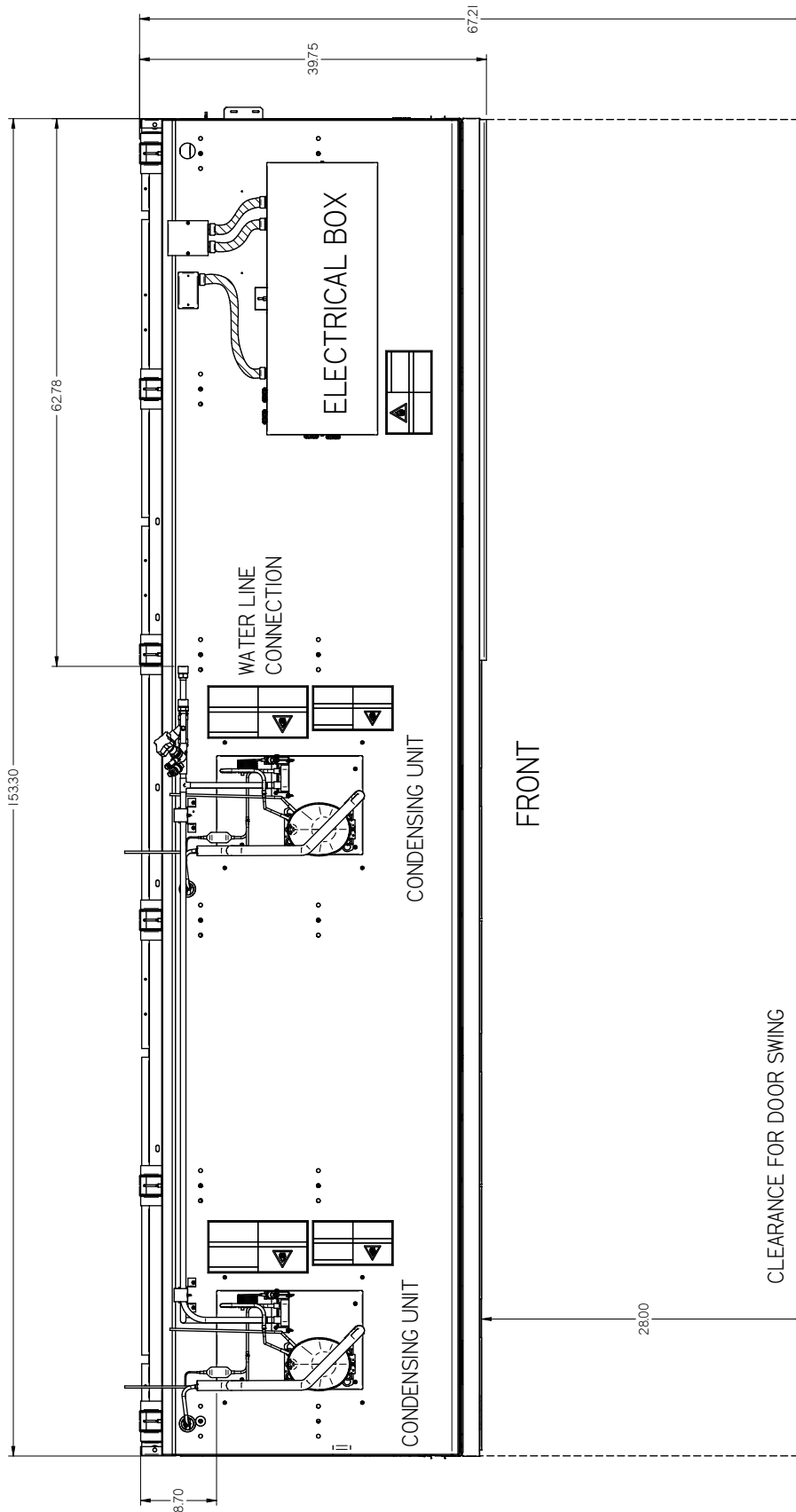

RMN-W
Medium Temperature

RMN-W
Top Views

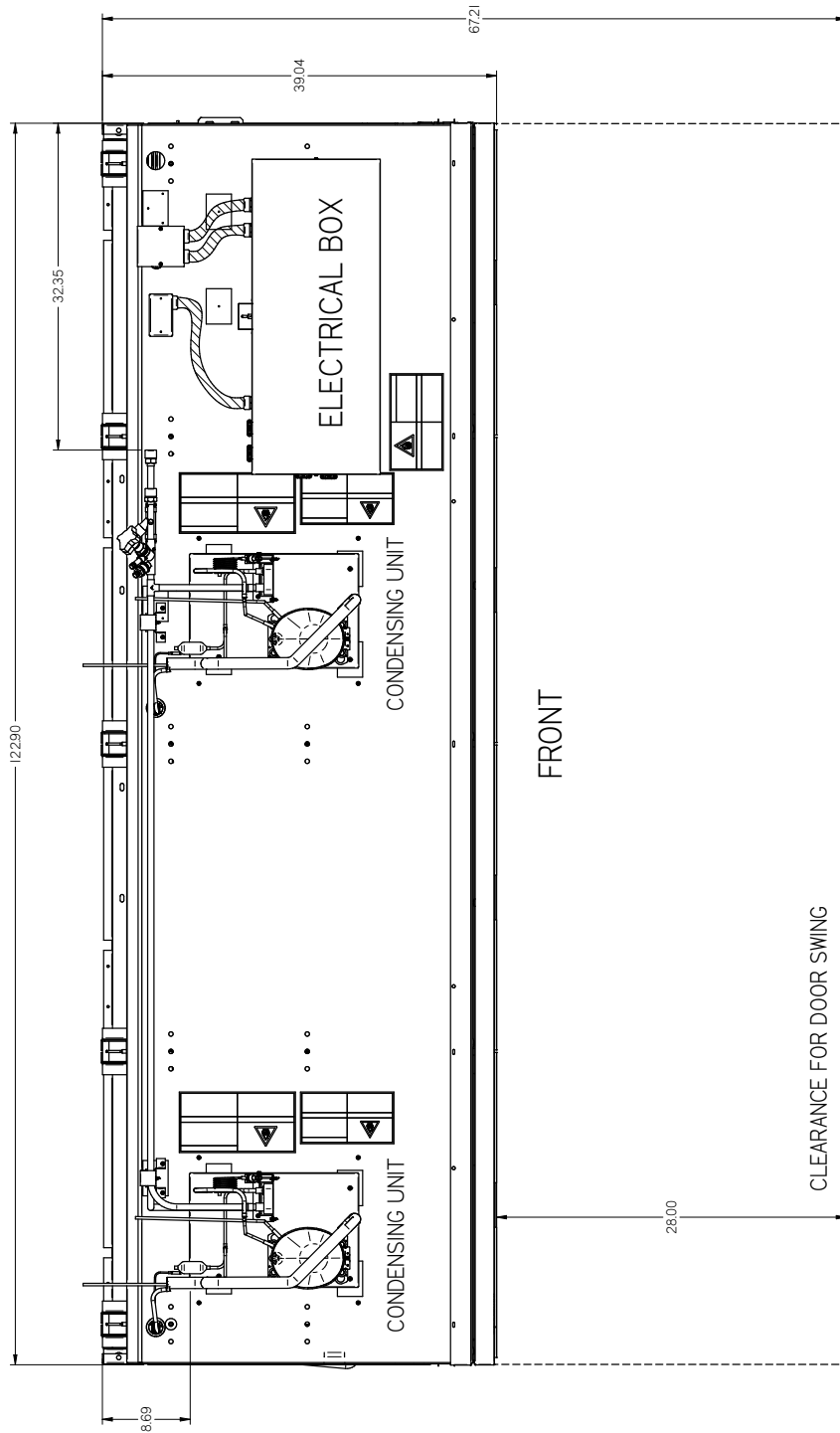

RMN-W
Medium Temperature



Scan QR code to
access product
information on your
mobile device.

Revision History

Revision A: April 2019: New Document