

Installation
& Operation
Manual

REV. 1123

HUSSMAN[®]/CHINO

R3HV (CR3HV)-M/F-EP

R3 (CR3)-M/F-EP

COMBINATION SERVICE AND SELF-SERVICE MEAT/FISH CASE

DOE 2012
Energy Efficiency
Compliant

Hussmann refrigerated merchandisers configured for sale for use in the United States meet or surpass the requirements of the DOE 2012 energy efficiency standards.

HUSSMANN[®]

R3HV (CR3HV)-M/F-EP

R3 (CR3)-M/F-EP

COMBINATION SERVICE AND SELF-SERVICE MEAT/FISH CASE



INSTALLATION & OPERATION GUIDE

General Instructions

Table of Contents

General Instructions..... 2

Cut and Plan Views 3

Installation..... 4

 Location..... 4

 Uncrating the Stand 4

 Exterior Loading 4

 Leveling 4

 Glass Installation/Balancing 6

 Level Minitop Hardware 6

 R3HV Glass Alignment Field Instructions..... 7

 Joint Trim.....11

 Bumper Installation Instructions 11

Plumbing12

 Waste Outlet and P-TRAP 12

 Installing Condensate Drain 12

Refrigeration13

 Piping 13

 Refrigeration Lines 13

 Control Settings..... 13

 Access to Thermostatic Expansion Valve (TEX) and Drain Lines..... 13

 Electronic Expansion Valve EEV (Optional) 13

 Thermostatic Expansion Valve Location 13

 Expansion Valve Adjustment 13

 Measuring the Operating Superheat 13

 Evaporator Pressure Regulator..... 13

 Service Case Temperature Control 13

 Thermostat (T-STAT) Location 13

User Information..... 16

 Startup 16

 Load Limit 16

 Basic Operation 16

 Merchandising Requirements 17

Maintenance..... 22

 Case Cleaning..... 22

Electrical..... 24

 Wiring Color Code..... 24

 Electrical Circuit Identification 24

 Electrical Service Receptacles (When Applicable)..... 24

 Field Wiring and Serial Plate Amperage 24

 Ballast Location 24

Spec Sheets 25

Electrical Wiring Diagrams 27

Wiring Diagrams 28

Troubleshooting..... 35

Appendices 38

 Appendix A. - Temperature Guidelines..... 38

 Appendix B. - Application Recommendations 38

 Appendix C. - Field Recommendations..... 38

 Appendix D. - Recommendations to User..... 39

Keep this booklet with the case at all times for future reference.

This Booklet Contains Information on:
R3HV-MF-EP/R3-MF-EP: Refrigerated Service Top for Meat with Gravity Coil and Refrigerated Self-Service Front Case

Shipping Damage
All equipment should be thoroughly examined for shipping damage before and during unloading.

This equipment has been carefully inspected at our factory and the carrier has assumed responsibility for safe arrival. If damaged, either apparent or concealed, claim must be made to the carrier.

Apparent Loss or Damage
If there is an *obvious loss or damage*, it must be noted on the freight bill or express receipt and signed by the carrier's agent; otherwise, carrier may refuse claim. The carrier will supply necessary claim forms.

Concealed Loss or Damage
When loss or damage *is not apparent until after equipment is uncrated*, a claim for concealed damage is made. Make request in writing to carrier for inspection within 15 days, and retain all packaging. The carrier will supply inspection report and required claim forms.

Shortages
Check your shipment for any possible shortages of material. If a shortage should exist and is found to be the responsibility of Hussmann Chino, *notify Hussmann Chino*. If such a shortage involves the carrier, *notify the carrier immediately*, and request an inspection. Hussmann Chino will acknowledge shortages within ten days from receipt of equipment.

Hussmann Chino Product Control
The serial number and shipping date of all equipment has been recorded in Hussmann's files for warranty and replacement part purposes. All correspondence pertaining to warranty or parts ordering must include the serial number of each piece of equipment involved, in order to provide the customer with the correct parts.



**ATTENTION
INSTALLER**

It is the contractor's responsibility to install case(s) according to local construction and health codes.

HUSSmann®/CHINO

A publication of HUSSMANN® Chino
13770 Ramona Avenue • Chino, California 91710
(909) 628-8942 FAX
(909) 590-4910
(800) 395-9229

Cut and Plan Views

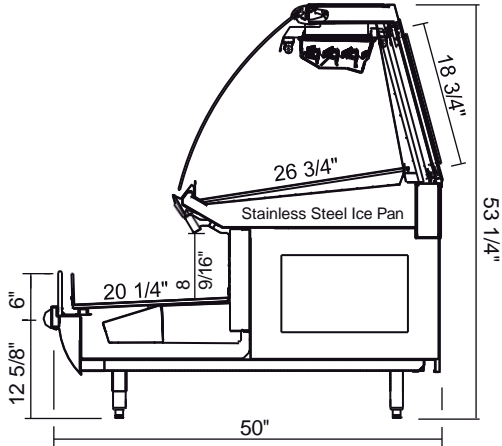

CR3HV-F
High Volume Fish Case with Curved Glass,
Gravity Coil and Ice Pans
Scale = 1/2"

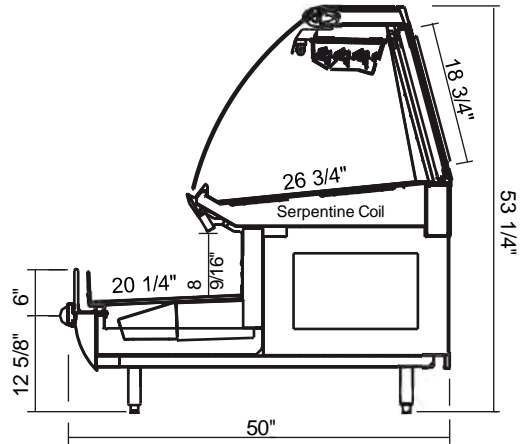

CR3HV-M
High Volume Meat Case with Curved Glass,
Gravity and Conduction Coil
Scale = 1/2"

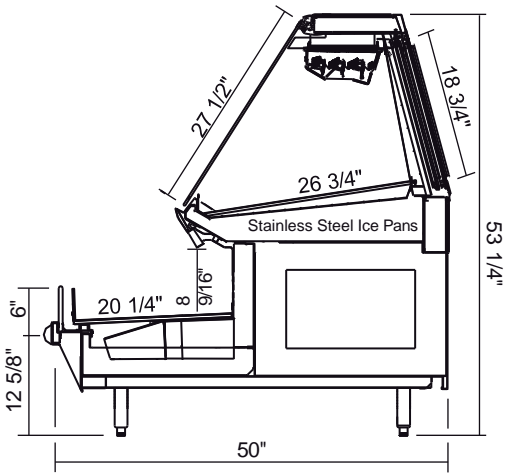

R3HV-F
High Volume Service - Fish Case with
Straight Glass, Gravity Coil and Ice Pans
Scale = 1/2"

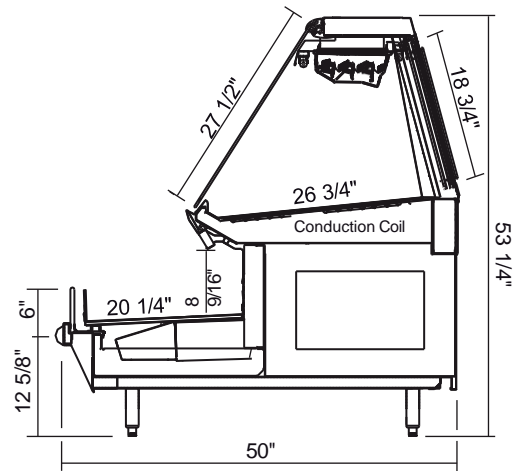

R3HV-M
High Volume Meat Case with Straight Glass,
Gravity and Conduction Coil
Scale = 1/2"

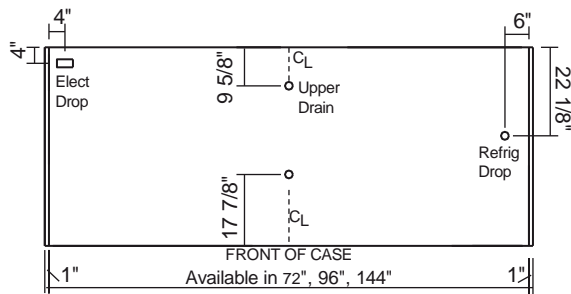

R3HV CR3HV R3HV-F CR3HV-F
R3HV-M CR3HV-M
Service Cases with Self Service Front
Plan View
Scale = 1/4"

Installation



Location

The refrigerated merchandisers have been designed for use only in air conditioned stores where temperature and humidity are maintained at or below 75°F and 55% relative humidity. **DO NOT** allow air conditioning, electric fans, ovens, open doors or windows (etc.) to create air currents around the merchandiser, as this will impair its correct operation.

Product temperature should always be maintained at a constant and proper temperature. This means that from the time the product is received, through storage, preparation and display, the temperature of the product must be controlled to maximize life of the product.

Uncrating the Stand

Place the fixture as close to its permanent position as possible. Remove the top of the crate. Detach the walls from each other and remove from the skid. Unbolt the case from the skid. The fixture can now be lifted off the crate skid. **Lift only at base of stand!**

Exterior Loading

These models have **not** been structurally designed to support excessive external loading. **Do not walk on their tops;** This could cause serious personal injury and damage to the fixture.

Leveling

IMPORTANT!: TO AVOID REMOVING CONCRETE FLOORING, WHEN INSTALLING A LINEUP OF CASES, IT IS IMPERATIVE THAT THE HIGHEST SPOT OF THE STORE FLOOR IN THE AREA WHERE THE CASES ARE TO BE SET IS DETERMINED. BEGIN SETTING THE LINEUP WITH THE CASE THAT IS NEAREST TO THE HIGHEST PART OF THE FLOOR. IF A WEDGE IS A PART OF THE LINEUP NEAR THE HIGH SPOT, SET IT FIRST.

IMPORTANT!: WHEN REMOVING LOOSE PARTS FROM INSIDE OR ON TOP OF THE CASE SUCH AS INSTALLATION KITS, HARDWARE OR FASTENERS, ICE PANS, DISPLAY PANS, SPLASH GUARDS, AND INSTRUCTION MANUALS TO GAIN ACCESS TO THE SIDE BULKHEADS AT EACH END OF THE CASE OR TO BEGIN PREPARATION FOR INSTALLATION: DO NOT LOSE THEM OR PUT THEM WHERE THEY CAN BECOME DAMAGED.

LEVELING: ALL CASES WERE LEVELED AND JOINED WHERE NECESSARY PRIOR TO SHIPMENT TO ENSURE THE CLOSEST POSSIBLE FIT WHEN CASES ARE JOINED IN THE FIELD. WHEN JOINING, USE A CARPENTERS LEVEL AND SHIM LEGS ACCORDINGLY. CASES MUST BE RAISED CORRECTLY: LIFT UNDER LEGS OR WOOD LEG BRACES WHERE SUPPORT IS BEST, TO PREVENT DAMAGE TO THE CASE.

1. It is imperative that the cases be leveled from front to back and side to side as they are being joined beginning with the first case that is set in place. Remember: the first case in a line-up to be set should be the one closest to the highest spot of the store floor. A level case is necessary to ensure proper operation, water drainage, and glass alignment. Remove any skids or shipping supports that are **under** the legs. Leave the leg supports attached to the sides of the legs on the case until the case has been set and leveled.

Front to back plumb should be checked by placing the level on the top of the side bulkhead of the lower case after the lower deck pans have been removed. Make sure that the area on the bulkhead where the level is placed is smooth and free of debris. Check plumb at both ends of the case at the side bulkheads.

Side to side plumb should be checked both at the front and rear of the case. At the front, a level can be placed on the stainless steel liner cap at the front of the lower case interior or on the stainless steel bumper box between the bumper and front Plexiglass. At the rear of the case, place the level on the stainless steel rear ledge. **Check plumb at the center and ends** to ensure that the case is truly level and that **all** legs of the case are supporting the weight of the case equally, front and rear and side to side.

2. Set the first case, and adjust the legs over the highest part of the floor so that case is level as described above. Prevent case damage: if lifting the case, it must be raised under the legs, the leg tubes or by the use of the wood 2" x 6" or 2" x 4" leg braces if applicable. Remove the side and back leg braces **after** the case is set.
3. Set the second case as close as possible to the first case, and level the second case to the first using the instructions in step 1. This will be a mock-up only. The final leveling of the case will be rechecked once they are bolted together in steps 7 and 8.
4. Apply masking tape 1/8" in from end of case on the inside and outside rear mullion and to the side bulkheads on both cases to be joined. The tape will minimize cleanup from sealant overflow when the cases are drawn together. (It can also be left in place on the upper case mullions and exterior bodywork for finish caulking with silicone in step 9.)

Installation (Cont'd)

- Apply liberal beads of case joint sealant (butyl) to the areas (solid dark lines) shown in the diagram below (Fig.2, #1) of the first case.

DO NOT USE PLUMBER'S PUTTY!

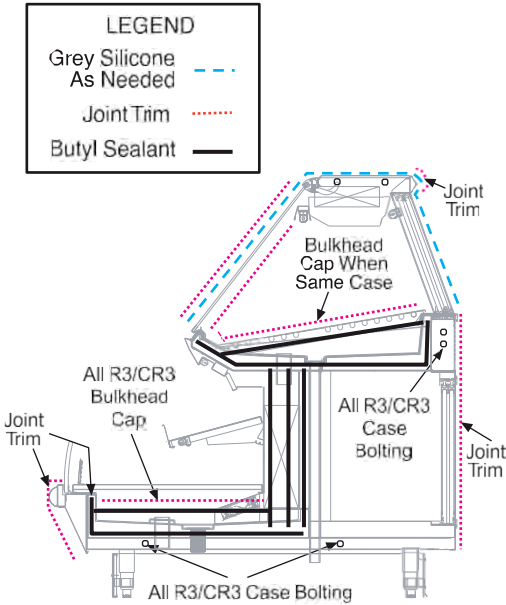

Fig.2, #1

DO NOT USE PLUMBER'S PUTTY!

Plumber's putty will not allow the cases to be fully drawn together which will cause gaps between the cases resulting in poor bodywork fit, finish and case sealing. Only use Plumber's putty where necessary after the cases have been bolted and drawn tightly together.



**ATTENTION
INSTALLER**

It is the contractor's responsibility to install case(s) according to local construction and health codes

- Slide the second case up to the first case snugly. Then align the second case to the first case so that the glass, front bumper, bodywork, and top are flush.

- To compress the sealant at the joints, use two Jurgenson® or similar hand screw type wood clamps. Make sure the case is level from front to back and side to side per the instructions in step 1. If using clamps on the plastic sprayed interior liner use scrap wood (as wide as possible) under the clamps so that the liner is not damaged. Be careful to observe the area where the clamp is being tightened so that the case is not damaged as pressure is applied.
- Attach cases together via 2 bolts located in the end leg tubes at the base of the cases and 1 bolt in the rear raceway end brackets. On fixed glass Meat and Fish cases, there are 2 additional bolts in the top of the case that are accessible by removing the top insert. The top insert is removed by pushing up on the bottom side of the insert from inside of the case.
- Remove the masking tape from the bulkheads only and trial fit the stainless steel bulkhead caps. Once proper fit is confirmed, apply a bead of silicone to the tops of the bulkheads and install the stainless steel bulkhead cap. Also, sparingly apply silicone to seal case interior and exterior bodywork as needed to ensure a water-tight seal, and a cleanable and professional appearance. Use a finger in a clean rag, as you go, to smooth the silicone as thin as possible on the inside and outside of the case, while it is still fluid. (Apply additional silicone if necessary). Immediately remove the masking tape applied in step 3.



DANGER

GLASS BREAKAGE MAY OCCUR!
Retighten glass along glass clamp after leveling and first time case is brought to full operating temperature!

Installation (Cont'd)

Glass Installation/Balancing

Glass Adjustment

The top cylinders, which allow the raising and lowering of the glass, have been carefully tested for proper tension. However, during shipment, the lubricant inside may have settled. This settling may cause excessive or uneven tension on the glass - to the point of breakage. Perform the three easy steps listed below before completely raising the front glass.

1. Slowly raise and lower each glass section 6 times to a height of 6 inches.
2. Increase the height to 12 inches, and raise and lower the glass 6 more times.
3. Finally raise the glass to its full extension, and lower. These steps should release any settled lubricant within the cylinders and prevent any stress on the front glass.

Additionally, after installing NEW cylinders, it is advisable to perform these three easy steps before completely raising the front glass.



**CYLINDERS ARE A "WEAR" ITEM
Glass is HEAVY and can cause bodily harm.**

Cylinders are designed to:

- **Support the glass when fully open**
- **Allow the glass to close slowly**

Have your Service Contractor replace the cylinders when required.



**IMPORTANT
INFORMATION**

**READ BEFORE RAISING
FRONT GLASS ON R3-M/F or
CR3-M/F:**

before opening glass!



**IMPORTANT
INFORMATION**

**READ BEFORE RAISING FRONT GLASS :
Hex screws along glass clamp may
have loosened during shipping!!
Retighten all glass clamp screws**

Level Minitop Hardware

IF GLASS DOES NOT CLOSE/STAY OPEN PROPERLY - Level MINI TOP HARDWARE

During shipping, it is possible that the mini top hardware housing the pistons and armature has been jostled out of position. This affects the opening angle of the glass.

1. Be sure mini top hardware is level front to back by placing a level along the top of the mini top housing at each hinge location. **If it is not, you will need a shim kit before you can correct. Order from Hussmann.**
2. Remove top glass and panel at top of hardware housing.
3. Mark position of hardware (glass) in relation to case before loosening hex screw using masking tape applied on mini top hardware and case, and pen. Hex screw allows realignment of glass angle and position front to back.
4. Raise glass and loosen hex screw. (See diagram on page 9.)
5. Shim to adjust until level using shims available from Hussmann (16 or 20 gauge stainless steel).
6. Check angle by using level placed on top of mini top hardware. Note: a 6" level will fit perfectly within access area.
7. Tighten hex screw.
8. If there is still a problem with glass staying open over-level by adding an addition shim under front of case.

NOTE: Before making any of the recommended adjustments, Verify that the case(s) have been leveled properly.

Installation (Cont'd)

Strategies for correcting Glass bounce and opening overlap problems

Adjust hinges FRONT – BACK.

Adjustments

Before calling for service if something seems wrong, check the following:

1. Inspect the gap between the glass panels

A. If pinched at the top: Gap is more narrow at the top than at the bottom.

Correct UNEVEN GAP and opening overlap problems by Vertically adjusting the hinge(s) to even the gap. Adjust center hinge (Outer hinges stationary). As this diagram indicates, raising the middle hinge draws the bottom edges closer together. Whereas lowering the hinge widens the gap. (See Vertical Adjustment on page 9)

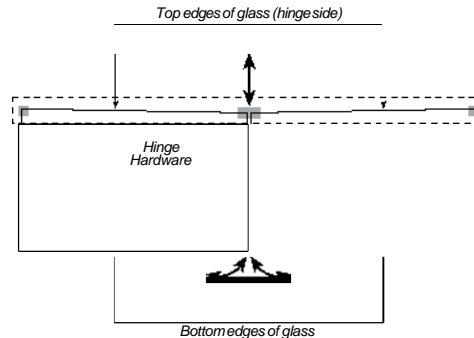

B. If pinched at the bottom: Gap is more narrow at the bottom than at the top.

Adjust outside hinges (Center hinge stationary). This diagram indicates that raising the outside hinges widens the gap at the bottom; whereas, lowering the outside hinges will draw the bottom edges closer together. (See Vertical Adjustment on page 9).

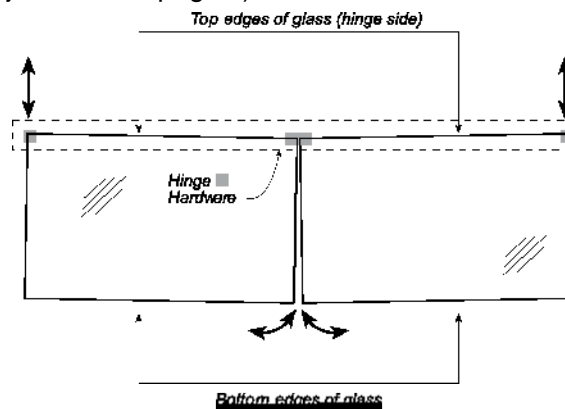

Which hinge(s) should I adjust first?

In most cases the center hinge is the first candidate, but if it cannot be adjusted because, either the adjustment screw is “maxed” out or no additional shims can be added or removed, then obviously the outer hinges must be adjusted

1. Check closing action of the glass panel

Test each panel by gently pushing it to close. Does the glass panel bounce or wobble as it closes?

A glass panel that does not close smoothly and neatly, most likely is misaligned with the front edge of the glass and the surface or edge which it closes upon. Refer to diagram below.

Installation (Cont'd)

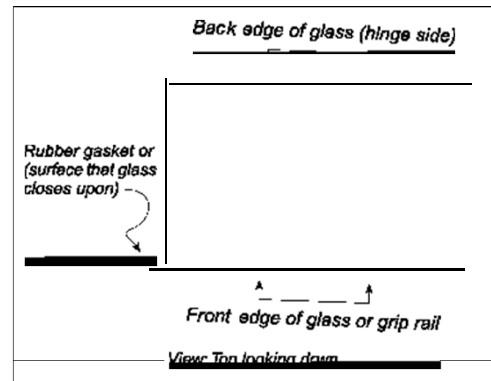

3. Strategies for correcting Glass Bounce and opening overlap problems Adjust hinges FRONT - BACK.

A. Adjust center Hinge (Outer hinges stationary).

As this diagram indicates, pulling the middle hinge further back, pulls the inside edges closer to the surface or edge which the glass rests upon. And pushing the middle hinge to the front, pushes the inside edges further away from the surface or edge which the glass rests upon. (See Vertical Adjustment of Glass)

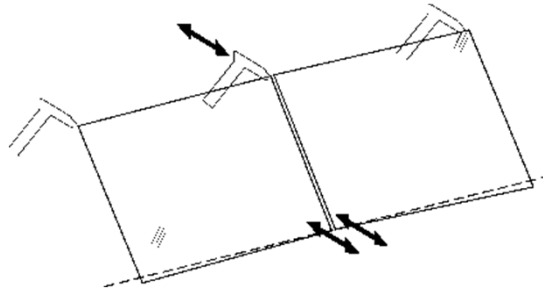

A. Adjust outside hinges (Center hinge stationary)

As this diagram indicates, pulling the outside hinge further back, pulls the outside edge closer to the surface or edge which the glass rests upon. And pushing the middle hinge to the front, pushes the inside edges further away from the surface or edge which the glass rests upon.

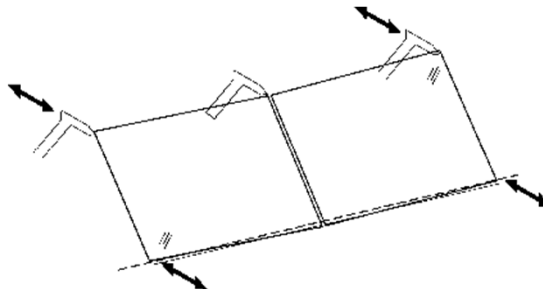

Which hinge(s) should I adjust first?

In most cases the center hinge is the first candidate, but if the arm/minicam is at its maximum or minimum position, then obviously the outer hinges must be used. (See Vertical Adjustment of Glass)

Vertical Adjustment of Glass

A. Adjust outside hinges (Center hinge stationary)

This diagram indicates that raising the outside hinges widens the gap at the bottom; whereas, lowering the outside hinges will draw the bottom edges closer together.

Which hinge(s) should I adjust first?

In most cases the center hinge is the first candidate, but if it cannot be adjusted because, either the adjustment screw is "maxed" out or no additional shims can be added or removed, then obviously the outer hinges must be adjusted.

Installation (Cont'd)

Vertical Adjustment

- 1. Remove top glass and panel enclosing mini-top hardware.
- 2. Lift open glass panel(s) and relieve tension on hinge.
- 3. Loosen hex screw (1/4" allen).
- 4. Add or remove shims as needed. (see note on shims below)
- 5. Close glass panel(s) and check alignment. Retighten hex screw and reinstall removed

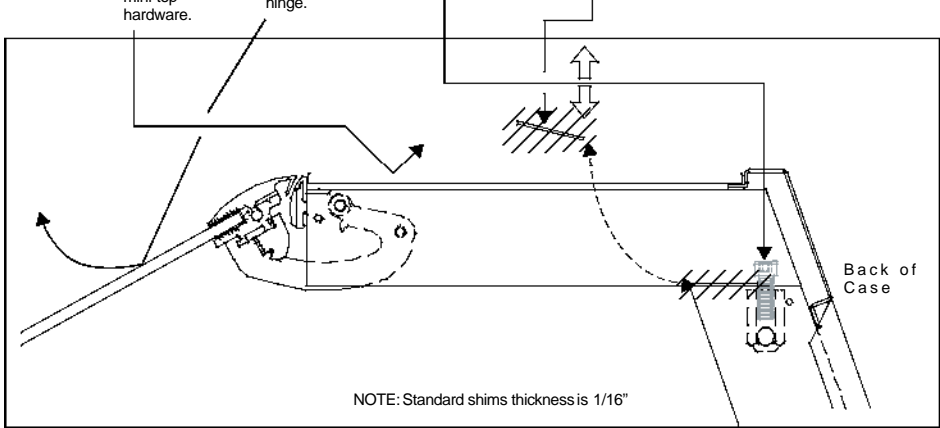

Installation (Cont'd)

Joint Trim

After cases have been leveled and joined, and refrigeration, electrical, and waste piping work completed, install the splashguards and joint trim where necessary. Fasten the splash guards along the top edge, or center, with 3/8" long sheet metal screws. If needed, use silicone sparingly to caulk the joint trim and exterior body panels with an appropriate colored silicone to ensure that a cleanable and professional appearance is achieved. Use a finger in a clean rag, as you go, to create smooth and neat joints, while the silicone is still fluid.

DO NOT SEAL JOINT TRIM OR SPLASHGUARDS TO THE FLOOR!

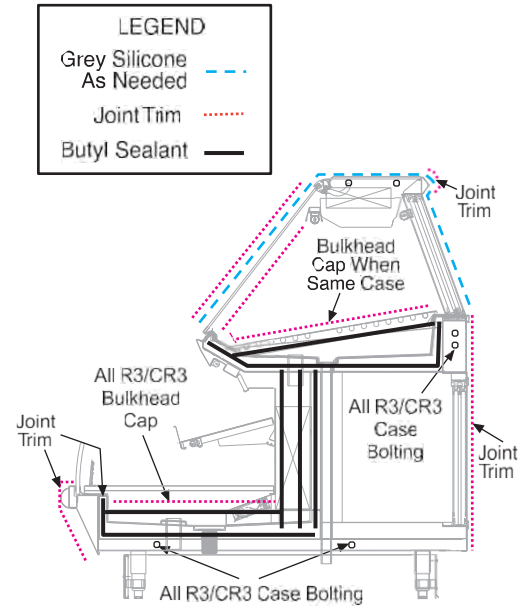

Bumper Installation Instructions



Step 1: Make sure the aluminum channel and end caps are installed.



Step 2: Use silicone lubricant to help the bumper slide into the channel.



Step 3: Starting on one end: while inserting the bumper, push it up against the end cap to prevent the bumper from shrinking after installation (when it gets cold).



Step 4: As you insert the bumper into the channel with one hand, pull the bumper toward you with the other to open the inside lips. Slowly apply pressure by rolling the bumper into the track.

R3HM/CR3-HVM JOINT CHECKSHEET

INSPECTOR _____

SALES ORDER # _____

EXT COLOR _____

*SEE INSTALLATION GUIDE

INT FINISH SS / BLACK

 INDICATES CASE BOLTING/ALIGNMENT POINT

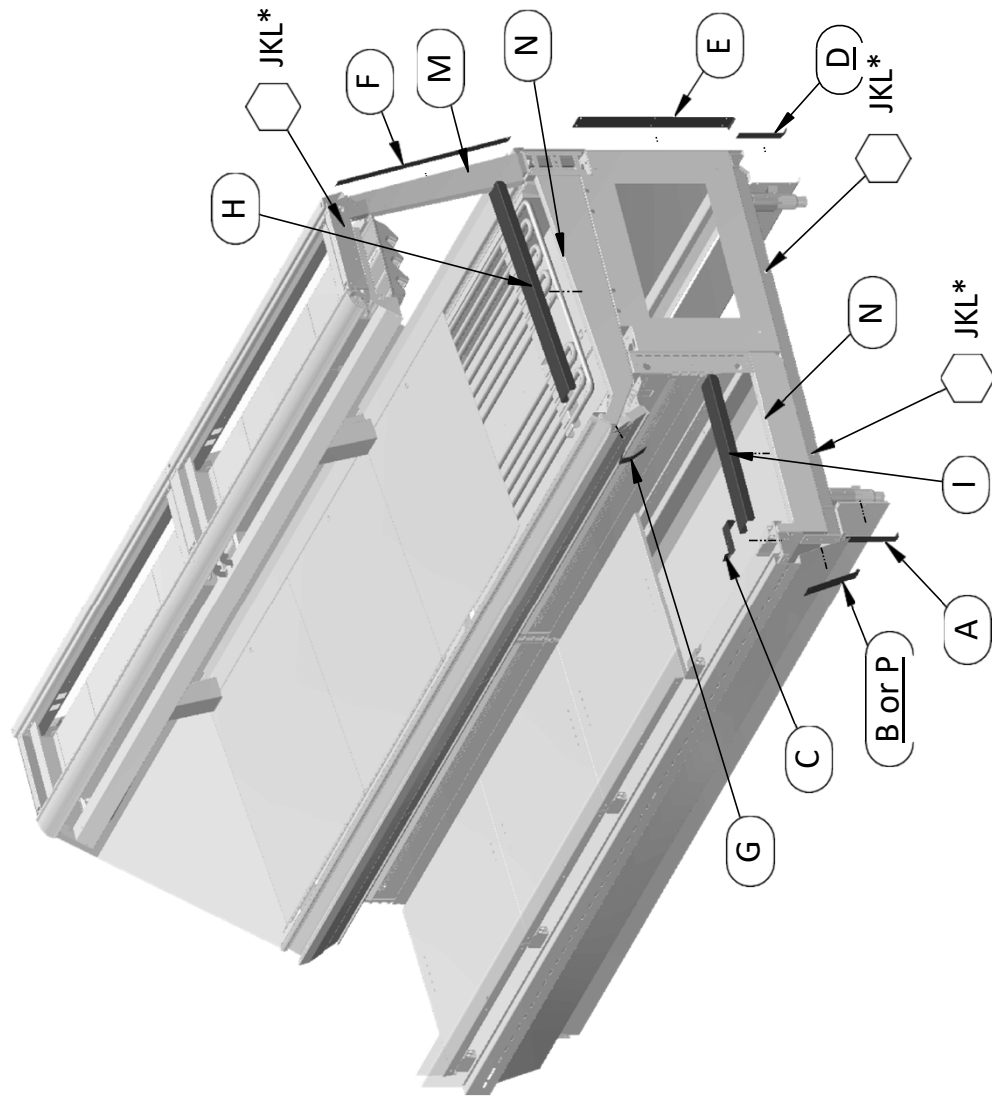

CHK	ITEM	PART #	QTY	GRAPHIC
<input type="checkbox"/>	TOE KICK TRIM	TBD (EXT COLOR) TBD (STAINLESS)	1	A
<input type="checkbox"/>	R3 FRONT BODY PANEL TRIM	091523J (EXT COLOR)	1	B
<input type="checkbox"/>	FRONT LEDGE TRIM	091515SS (STAINLESS)	1	C
<input type="checkbox"/>	REAR TOE KICK TRIM	2H22014004 (STAINLESS)	1	D
<input type="checkbox"/>	REAR STORAGE TRIM	130996SS (STAINLESS)	1	E
<input type="checkbox"/>	ARM COVER TRIM	130998SS (STAINLESS)	1	F
<input type="checkbox"/>	FRONT FASCIA TRIM	108393SS (STAINLESS)	1	G
<input type="checkbox"/>	SERVICE BULKHEAD CAP	063719SS (STAINLESS)	1	H
<input type="checkbox"/>	SELF SERVICE BULKHEAD CAP	130997SS (STAINLESS)	1	I
<input type="checkbox"/>	NUT, 3/8 - 16	300-03-1370	3	J
<input type="checkbox"/>	WASHER, 5/16"	300-03-1315	6	K
<input type="checkbox"/>	BOLT, 3/8 - 16X 8	300-03-0902	3	L
<input type="checkbox"/>	GASKET SEAL TAPE	225-01-0628	16FT	M
<input type="checkbox"/>	SEALANT, BUTYL, TUBE	100-01-0121	1	N
<input type="checkbox"/>	SEALANT, SILICONE, TUBE	100-01-0051 (CLEAR) 100-01-0063 (SILVER) 100-01-0065 (BLACK)	1	-
<input type="checkbox"/>	SCREW, SELF TAP #8X 1/2	300-03-0037	16	-
<input type="checkbox"/>	VHB DOUBLE-SIDED TAPE	175-01-0562	16FT	-
<input type="checkbox"/>	COUPLING, 2" PVC	225-01-0090	1	-
<input type="checkbox"/>	NIPPLE, 2" PVC	225-01-0577	1	-
<input type="checkbox"/>	ADAPTER, 1-1/2" PVC	225-01-1429	1	-
<input type="checkbox"/>	DRAIN TRAP, PVC	225-01-1552	1	-

CHK	ITEM	PART #	QTY	GRAPHIC
<input type="checkbox"/>	CR3 FRONT BODY PANEL TRIM	091769PL (EXT COLOR) 091769SS (STAINLESS)	1	P

HUSSMANN

REV B 01/19/2016

1

Plumbing

Waste Outlet and P-TRAP

The waste outlet is located off the center of the case on one side allowing drip piping to be run lengthwise under the fixture. There are 2 drains in each fixture that can be easily located.

P-traps must be installed at the base of all refrigerated cases. The 1 ½" P-TRAPS and threaded adapters must be installed to prevent air leakage and insect entrance into the fixture.

Installing Condensate Drain

Poorly or improperly installed condensate drains can seriously interfere with the operation of this refrigerator, and result in costly maintenance and product losses. Please follow the recommendations listed below when installing condensate drains to insure a proper installation:

1. Never use pipe for condensate drains smaller than the nominal diameter of the pipe or P-TRAP supplied with the case.
2. When connecting condensate drains, the P-TRAP must be used as part of the condensate drain to prevent air leakage or insect entrance. Store plumbing system floor drains should be at least 14" off the center of the case to allow use of the P-TRAP pipe section. Never use two water seals in series in any one line. Double P-TRAPS in series will cause a lock and prevent draining.

3. Always provide as much down hill slope ("fall") as possible; 1/8" per foot is the preferred minimum. PVC pipe, when used, must be supported to maintain the 1/8" pitch and to prevent wrapping.
4. Avoid long runs of condensate drains. Long runs make it impossible to provide the "fall" necessary for good drainage.
5. Provide a suitable air break between the flood rim of the floor drain and outlet of condensate drain. 1" is ideal.
6. Prevent condensate drains from freezing:
 - a. Do not install condensate drains in contact with non-insulated suction lines. Suction lines should be insulated with a non absorbent insulation material such as Armstrong's Armaflex.
 - b. Where condensate drains are located in dead air spaces (between refrigerators or between a refrigerator and a wall), provide means to prevent freezing. The water seal should be insulated to prevent condensation.

WARNING!

Do NOT apply thread sealer to ABS P-Trap.



Refrigeration

Piping

The refrigerant line outlets are located under the case. Locate first the electrical box, the outlets are then on the same side of the case but at the opposite end. Insulate suction lines to prevent condensation drippage.

Refrigeration Lines

<u>Liquid</u>	<u>Suction</u>
3/8" O.D.	5/8" O.D.

NOTE: The standard coil is piped at 5/8" (suction); however, the store tie-in may vary depending on the number of coils and the draw the case has. Depending on the case setup, the connecting point in the store may be 5/8", 7/8", or 1 1/8". Refer to the particular case you are hooking up.

Refrigerant lines should be sized as shown on the refrigeration legend furnished by the store.

Oil traps must be installed at the base of all suction line vertical risers on refrigerated cases.

Pressure drop can rob the system of capacity. To keep the pressure drop to a minimum, keep refrigerant line run as short as possible, using the minimum number of elbows. Where elbows are required, use long radius elbows only.

Control Settings

See R3(CR3)-M/F technical data sheet for the appropriate settings for your merchandiser. Maintain these parameters to achieve near constant product temperatures. Product temperature should be measured first thing in the morning, after having been refrigerated overnight. Defrost times should be as follows: OFF CYCLE - Defrost times should be as directed in the R3HV (CR3HV)-M/F technical data sheet. The number of defrosts per day and the duration of the defrost cycle may be adjusted to meet conditions present at your location.

Access to Thermostatic Expansion Valve (TEX) and Drain Lines

Mechanical - Remove product from end of case. Remove product racks. Remove refrigeration and drain access panels (labeled). TEX valve (mechanical only) and drain are located under each access panel at end of the case.

Electronic - The Electronic Expansion valve master and slave cylinder(s) are located within the electrical access panel(s).

Electronic Expansion Valve EEV (Optional)

A wide variety of electronic expansion valves and case controllers can be utilized. Please refer to EEV and controller manufacturers information sheet. Sensors for electronic expansion valves will be installed on the coil inlet, coil outlet, and in the discharge air. (Some supermarkets require a 4th sensor in the return air). Case controllers will be located in the electrical raceway or under the case.

Thermostatic Expansion Valve Location

This device is located on the same side as the refrigeration stub. A balanced port expansion valve model is furnished as standard equipment, unless otherwise specified by customer.

Expansion Valve Adjustment

Expansion valves must be adjusted to fully feed the evaporator. Before attempting any adjustments, make sure the evaporator is either clear or very lightly covered with frost, and that the fixture is within 10°F of its expected operating temperature.

Measuring the Operating Superheat

1. Determine the suction pressure with an accurate pressure gauge at the evaporator outlet.
2. From a refrigerant pressure temperature chart, determine the saturation temperature at the observed suction pressure.
3. Measure the temperature of the suction gas at the thermostatic remote bulb location.
4. Subtract the saturation temperature obtained in step No. 2 from the temperature measured in step No. 3. The difference is superheat.
5. Set the superheat for 5°F - 7°F.

Evaporator Pressure Regulator

An Evaporator Pressure Regulator is installed in the front of the self service section to maintain a constant discharge temperature. It is located at the front right side of the case, under the fan plenum near the TEX Valve.

Service Case Temperature Control

Temperature control in the upper section of the CR3 with the Service Option is done by means of a thermostat and suction solenoid valve. This controls both temperature and humidity.

Thermostat (T-STAT) Location

Thermostats are located within the electrical raceway. Refer to diagram below. There are also labels on the back of the case indicating T-STAT location(s).

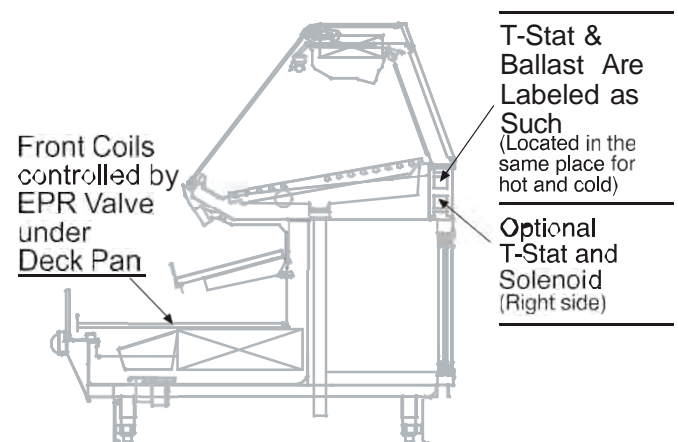
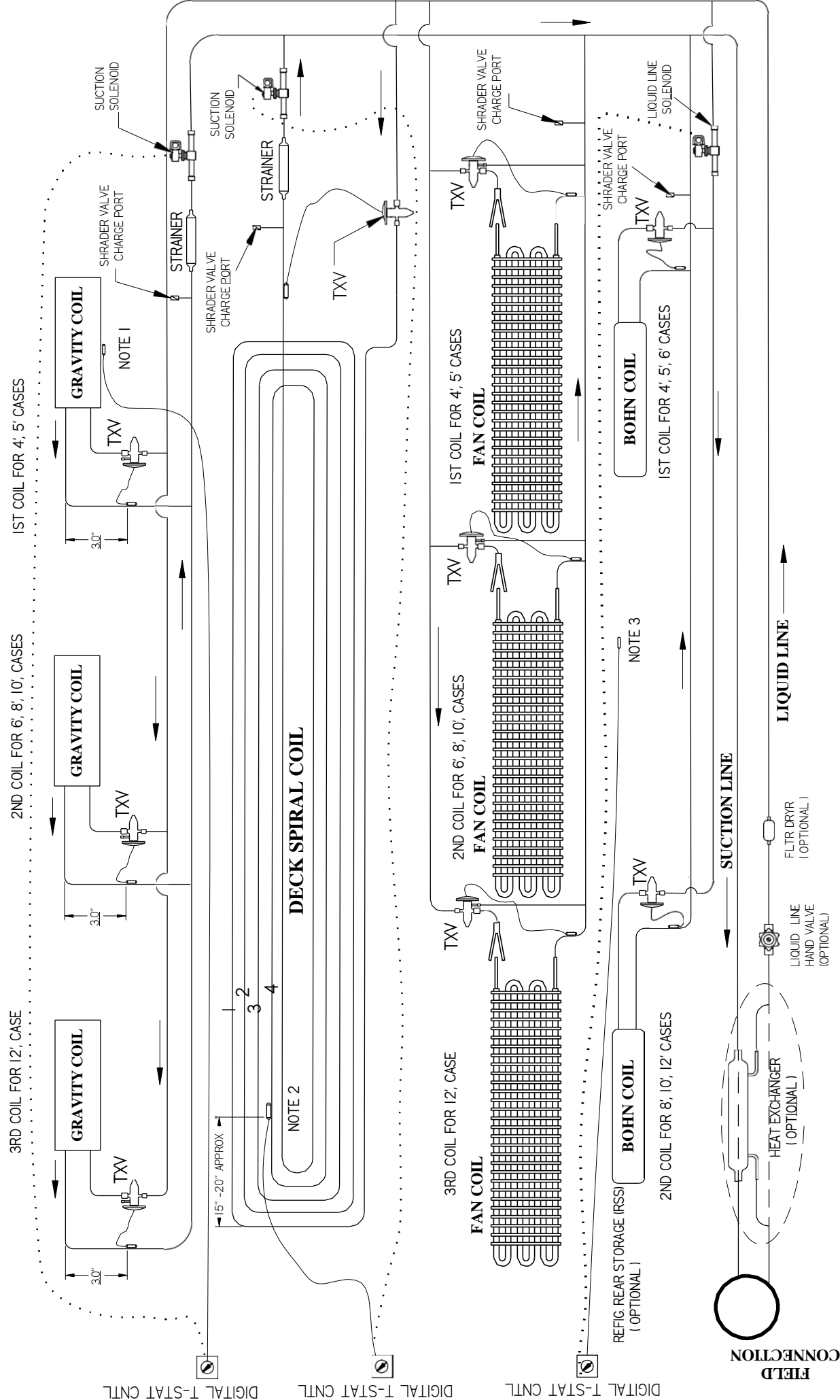

Figure #3



GRAVITY COIL SENSOR IS LOCATED AT APPROXIMATELY 18" - 32" FROM LEFT HAND SIDE END OF COIL 1.0" BELOW BOTTOM OF COIL
 DECK COIL SENSOR AND CLAMP SHOULD BE MOUNTED BELOW COIL TUBES TOP SURFACE

Refrigeration (cont'd)

See demonstrations below for detailed overview of the (C)R3HV-M/F-EP Piping schematic.

Note: Refrigeration components have been fitted with a component tray for ease in use of cleaning and maintenance under the deck pans.

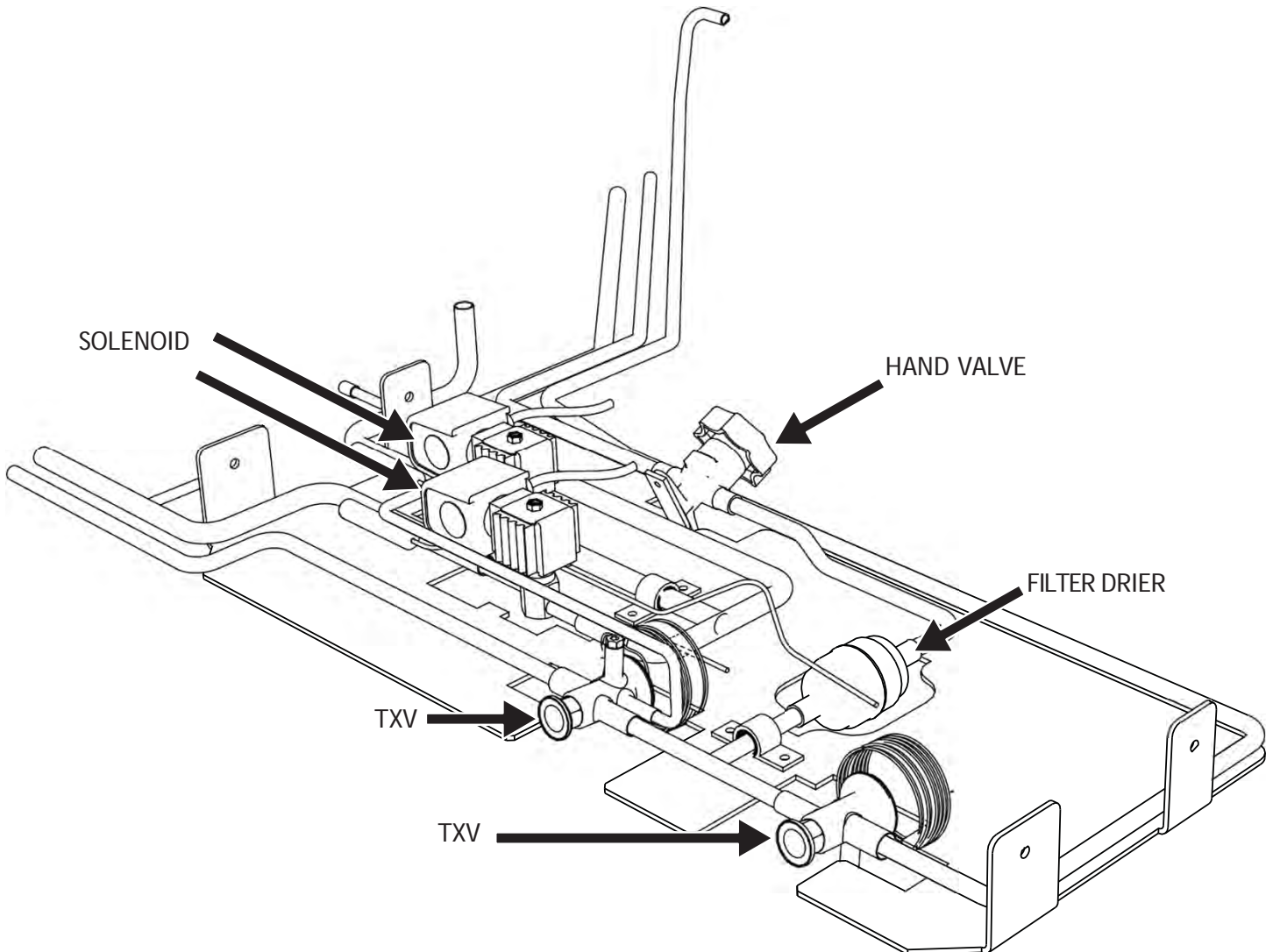

User Information

Start Up

See the merchandisers Data Sheet Set for refrigerant settings and defrost requirements. Bring merchandisers down to the operating temperatures listed on the Data Sheet.



WARNING

--LOCK OUT/ TAG OUT--

To avoid serious injury or death from electrical shock, always disconnect the electrical power at the main disconnect when servicing or replacing any electrical component. This includes, but is not limited to, such items as doors, lights, fans, heaters, and thermostats.

Load Limit

Each Merchandiser has a Load Limit. Shelf life of perishables will shorten if Load Limit is violated.

AT NO TIME SHOULD THE MERCHANDISER BE STOCKED BEYOND THE LOAD LIMITS INDICATED.

LOAD LIMIT



Basic Operation

The R3HV-M/F- EP series case cools meat/fish in two ways:

1. The Spiral Deck Coil under the display deck cools the meat/fish product by means of contact conduction.
2. The Gravity Coil cools the case and product via natural air convection.

Spiral Deck Coil is the **primary source** of refrigeration while the Gravity Coil acts as a secondary source. Slow moving air circulation from the Gravity Coil (GC) and cold contact with the Spiral Coil (SC) on the deck combine to cool the product and keep product dehydration low. This balance is critical to achieve the expected display life and product temperature. If the product is lifted off of the deck surface by an aftermarket display shelf, reduced contact surface trays, or other means, the benefit of conduction cooling from the deck Spiral Coil is reduced dramatically.

((C)R3HV-M/F-EP

Service Meat or Fish

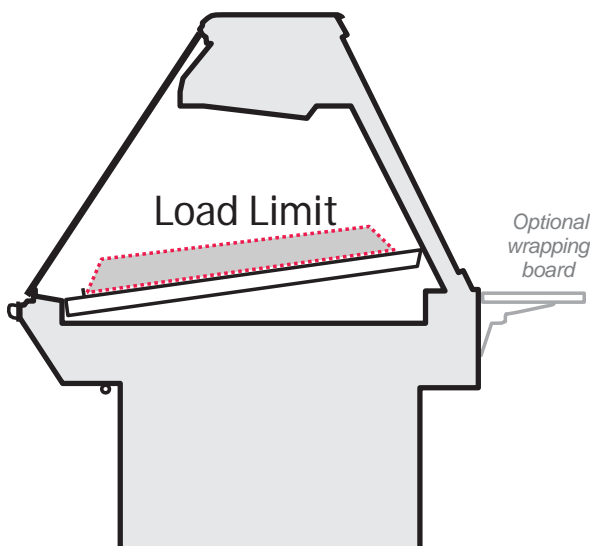

User Information (cont'd)

Merchandising Requirements

Use a consistent display strategy in each case. Hussmann recommends the use of flat bottomed aluminum or high density plastic trays as the ideal merchandising display method.

When displaying product on flat trays directly on the deck surface (ideal display method), layer product single or double high keeping product within the load limits (page 27). This promotes even cooling from both the spiral deck coil below and gravity coil above, and allows for less refrigeration power, lower dehydration and increased product life.

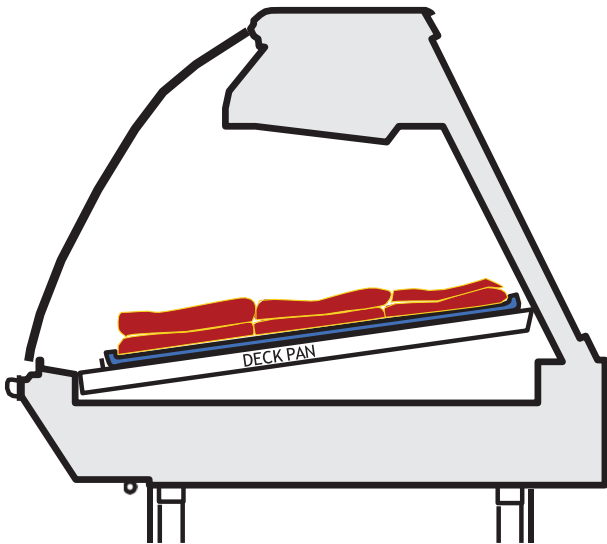

Rotate product every several hours. Bottom layer should be rotated to the top and flipped. This ensures even cooling, dehydration and color maintenance.

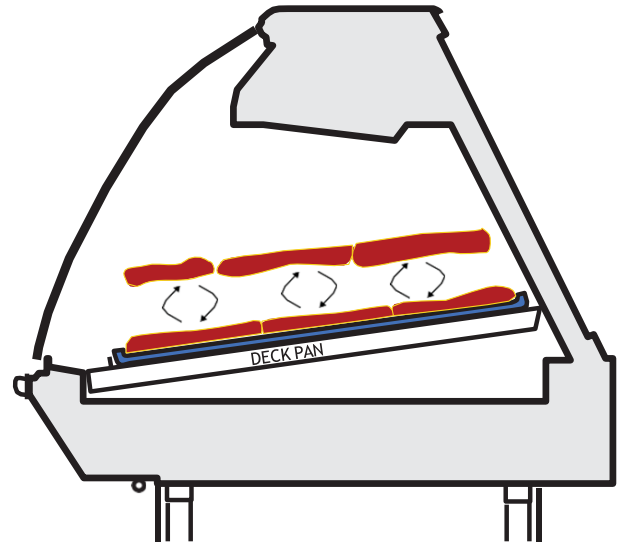

As demonstrated below, each layer of product has a slight increase in internal product temperature the higher it is stacked. It is very important that each layer make direct contact with the layer below it. With conductive cooling, heat will flow from the warmer surface to the cooler surface until both are nearly at the same temperature.

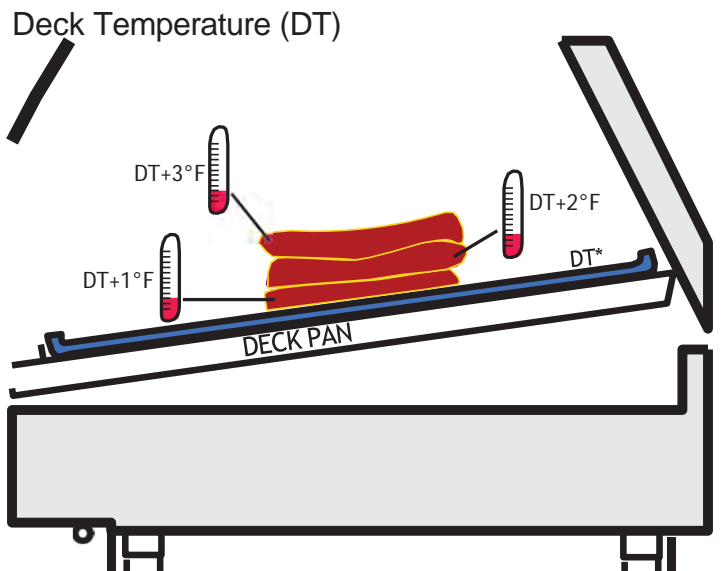

* DT will vary based on store conditions and case set points.

User Information (cont'd)

Merchandising DON'TS

Products can be stacked too high on trays or display ware, the Spiral serpentine coil underneath the deck pans are the main source for cooling for the case. If you are not achieving the internal product temperature your store desires, remove one layer. Monitor product interval temperatures for several hours.

By no means use Foam, polycarbonate, wood, synthetic solid surface materials or any other product partition which acts as an insulator to display product. When separating product from direct contact preferably refer to Butcher Paper if desired.

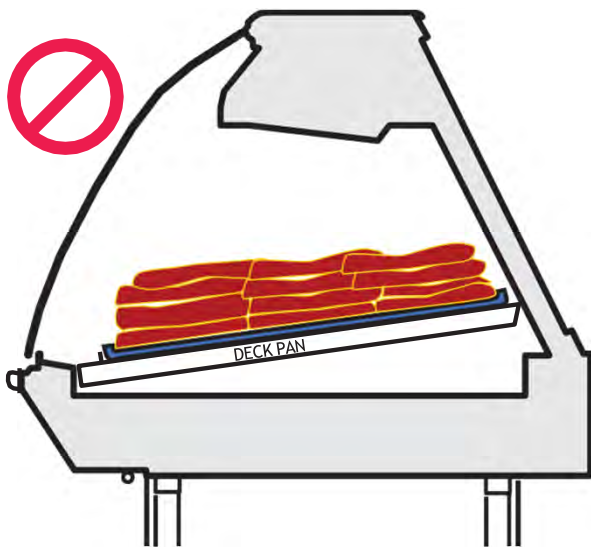

Display ware used inside a R3HV-M/F-EP **MUST BE FLAT BOTTOMED** to make direct contact with the cooled deck pans, keep in mind that most display ware is designed with ridge along the bottom end or ridges across the surface bottom for structural support. Often times display ware has feet on the bottom of it to prevent direct contact with the display pan. Refrain from using any display ware which prevents direct contact between the display ware bottom and the cooled display pans. Any air space between the Hussmann opticold deck pans, the display ware or the product will adversely affect case performance and cause elevated product temperature and early product loss.

The following Display Wares or display configurations are **NOT RECOMMENDED** and working outside of the Hussmann requirements will adversely affect product and/or case performance.

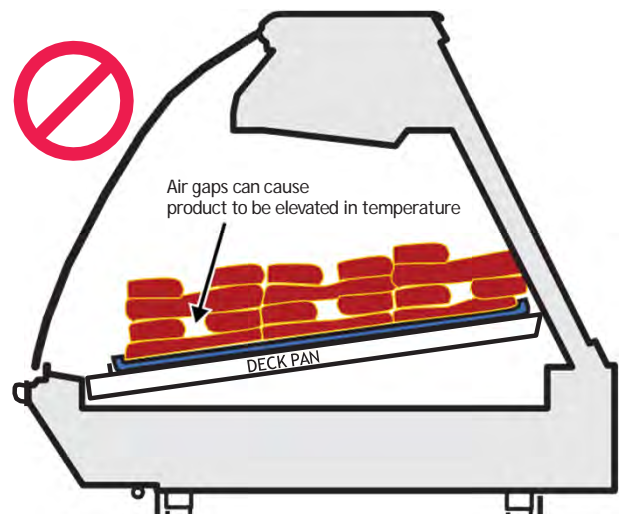
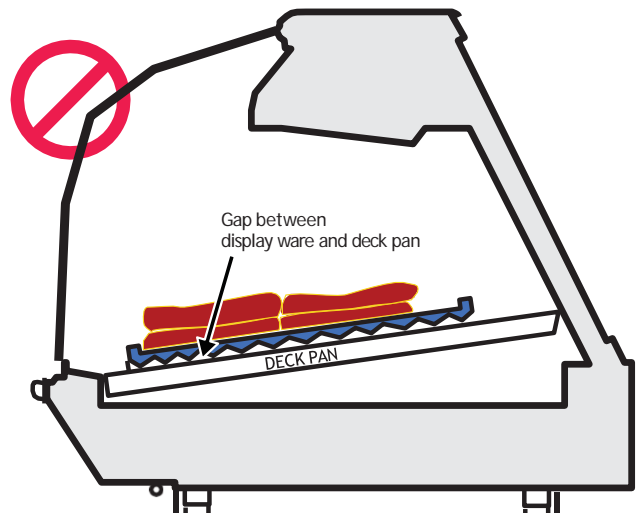
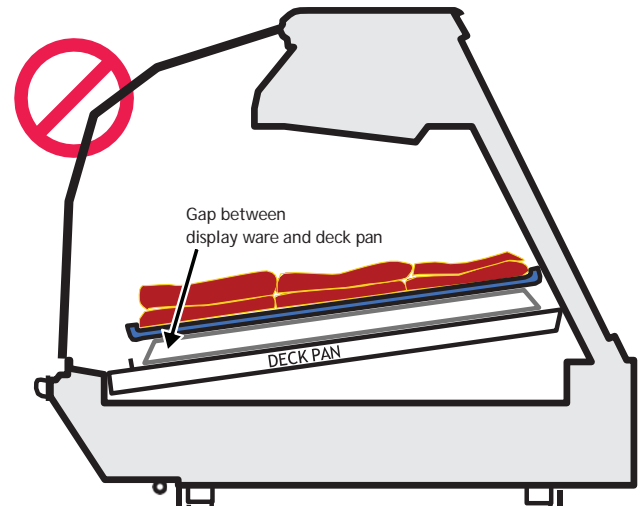

User Information (cont'd)

Stocking

Improper temperature and lighting will cause serious product loss. Discoloration, dehydration and spoilage can be controlled with proper use of the equipment and handling of product. Product temperature should always be maintained at a constant and proper temperature. This means that from the time the product is received, through storage, preparation and display, the temperature of the product must be controlled to maximize life of the product. Hussmann cases were not designed to "heat up" or "cool down" product - but rather to maintain an item's proper temperature for maximum shelf life. To achieve the protection required always:

1. Minimize processing time to avoid damaging temperature rise to the product. Product should be at proper temperature.
2. Keep the air in and around the case area free of foreign gasses and fumes or food will rapidly deteriorate.
3. Maintain the display merchandisers temperature controls as outlined in the refrigerator section of this manual.
4. Do not place any product into these refrigerators until all controls have been adjusted and they are operating at the proper temperature. Allow merchandiser to operate a minimum of 6 hours before stocking with any product.
5. When stocking, never allow the product to extend beyond the recommended load limit. **Air discharge and return air flow must be unobstructed at all times to provide proper refrigeration.**
6. Keep the service doors closed (when applicable). Refrigeration performance will be seriously affected if left open for a prolonged period of time.
7. Avoid the use of supplemental flood or spot lighting. Display light intensity has been designed for maximum visibility and product life at the factory. The use of higher output fluorescent lamps (H.O. and V.H.O.), will shorten the shelf life of the product.

Replacing Fluorescent Lamps

Fluorescent lamps are furnished with a shatterproof protective coating. The same type of lamp with protective coating must be used if replaced.

HUSSMANN®

ENCAPSULITE
SHATTERPROOF COATING - SA 10645

Complies with FDA USDA
& OSHA Regulations

for replacement call:
1-800-395-9229

→ Turn switch off then on after replacing bulb ←



Evaporator Fans

The evaporator fans are located at the center front of these merchandisers directly beneath the display pans. *Should fans or blades need servicing, always replace fan blades with the raised embossed side of the blade TOWARD THE MOTOR.*

Copper Coils

The copper coils used in Hussmann merchandisers may be repaired in the field. Materials are available from local refrigeration wholesalers.

Hussmann recommends using #15 Sil-Fos for repairs.

Aluminum Coils

The aluminum coils should be replaced if damaged.

Non-Glare Glass (Optional)

The high optical clarity of this glass is possible due to special coatings on the glass surface itself. To preserve this coating and the optical clarity, keep the glass clean.

Water is the only solution recommended to be used to clean the non-glare glass. The damage to the glass from improper, caustic solutions is irreparable.

In addition to cleaning the glass with the recommended product, there are precautions that should be taken when working and cleaning the inside of the case.

- When cleaning the inside of the cases, we recommend that the glass be fully opened and covered to prevent solutions from splashing onto the glass and ruining the coating on the inside.
- Only use a soft cloth and water (in a spray bottle) for cleaning any glass or mirrored components. Be sure to rinse and/or dry completely.
- **Never use hot water on cold glass surfaces! It may shatter and cause serious injury!** Allow glass surfaces to warm to room temperature.

Plexiglass and Acrylic Care

Improper cleaning not only accelerates the cleaning cycle but also degrades the quality of this surface. Normal daily buffing motions can generate static cling attracting dust to the surface. Incorrect cleaning agents or cleaning cloths can cause micro scratching of the surface, causing the plastic to haze over time.

Cleaning

Hussmann recommends using a clean damp chamois, or a paper towel marketed as dust and abrasive free with **210® Plastic Cleaner and Polish** available by calling Sumner Labs at 1-800-542-8656. Hard, rough cloths or paper towels will scratch the acrylic and should not be used.

Antistatic Coatings

The product **210®** has proven to be very effective in not only cleaning and polishing the Plexiglass surface, but also providing anti-static and anti-fog capabilities. This product also seals pores and provides a protective coating.

User Information (Cont'd)

Tips and Troubleshooting

Before calling for service, check the following:

1. Check electrical power supply to the equipment for connection.
2. Check fixture loading. Overstocking case will affect its proper operation.
3. If frost is collecting on fixture and/or product, check that no outside doors or windows are open allowing moisture to enter store. These merchandisers were designed for use in stores where temperature & humidity does not exceed 75° F and 55% H.
4. If front self-service case is not performing check proper installation of lower deck pan refer to case cleaning section.

Case Cleaning

Long life and satisfactory performance of any equipment are dependent upon the care given to it. To insure long life, proper sanitation and minimum maintenance costs, the refrigerator should be thoroughly cleaned frequently.

SHUT OFF FAN DURING CLEANING PROCESS. It can be unplugged within the case, or shut off case at the source. The interior bottom may be cleaned with any domestic soap or detergent based cleaners. Sanitizing solutions will not harm the interior bottom, however, these solutions should always be used according to the manufacturer's directions.

It is essential to establish and regulate cleaning procedures. This will minimize bacteria causing discoloration which leads to degraded product appearance and significantly shortening product shelf life.

Soap and hot water are NOT enough to kill this bacteria. A sanitizing solution MUST be included with each cleaning process to eliminate this bacteria.

Remove all food stuffs, ice, debris, etc., and either access the case from the rear or the front of the case. Allow the case to come to room temperature.



CAUTION

**WHEN CLEANING, DO NOT SPRAY GLASS!
FRONT AND BACK GLASS IS NOT
SEALED AND WILL LEAK!!!
Front glass is "Lift Up Glass" that is
NOT SEALED and back access doors
ARE NOT SEALED and WILL LEAK if
sprayed with any liquid!**



CAUTION

If you access the case from the front, be certain the glass is FULLY upright before beginning the cleaning process.

1. Scrub thoroughly, cleaning all surfaces, with soap and hot water.
2. Rinse with hot water, but DO NOT flood or spray glass. (If you are working from the rear of the case, the front glass is "lift up glass" and is NOT sealed. IT WILL LEAK.) Keep all water within the base of the case.
3. Apply the sanitizing solution according to the manufacturer's directions.
4. Rinse thoroughly.
5. Dry completely before resuming operation.

CAUTION

CLEANING PRECAUTIONS

When cleaning:

- Do not use high pressure water hoses
- Do not introduce water faster than waste outlet can drain
- NEVER INTRODUCE WATER ON SELF CONTAINED UNIT WITH AN EVAPORATOR PAN
- NEVER USE A CLEANING OR SANITIZING SOLUTION THAT HAS AN OIL BASE (these will dissolve the butyl sealants) or an AMMONIA BASE (this will corrode the copper components of the case)
- TO PRESERVE THE ATTRACTIVE FINISH:
- DO USE WATER AND A MILD DETERGENT FOR THE EXTERIOR ONLY
- DO NOT USE A CHLORANITED CLEANER ON ANY SURFACE
- DO NOT USE ABRASIVES OR STEEL WOOL SCOURING PADS (these will mar the finish)

User Information (Cont'd)

Front Deck Pan Placement

ATTENTION!

When reassembling the front self-service portion of the case, assure proper installation of bottom deck pan. If the deck pan is NOT installed properly, the front self service section will NOT maintain safe product temperature.



Stainless Steel Cleaning and Care

There are three basic things, which can break down your stainless steel's passivity layer and allow corrosion.

1. Mechanical Abrasion

Mechanical Abrasion means those things that will scratch the steels surface. Steel Pads, wire Brushes, and Scrapers are prime examples.

2. Water

Water comes out of our tap in varying degrees of hardness. Depending on what part of the country you live in, you may have hard or soft water. Hard water may leave spots. Also, when heated, hard water leaves deposits behind that if left to sit, will break down the passive layer and rust your stainless steel. Other deposits from food preparation and service must be properly removed.

3. Chlorides

Chlorides are found nearly everywhere. They are in water, food and table salt. One of the worst perpetrators of chlorides can come from household and industrial cleaners.

Don't Despair! Here are a few steps that can help prevent stainless steel rust.

1. Use the Proper Tools

When cleaning your stainless steel products, take care to use non-abrasive tools. Soft Clothes and plastic scouring pads will NOT harm the steel's passive layer. Stainless steel pads can also be used but the scrubbing motion must be in the same direction of the manufacturer's polishing marks.

2. Clean With the Polish Lines

Some stainless steels come with visible polishing lines or "grain". When visible lines are present, you should ALWAYS scrub in a motion that is parallel to them. When the grain cannot be seen, play it safe and use a soft cloth or plastic scouring pad.

3. Use Alkaline, Alkaline Chlorinated or Non-chloride Containing Cleaners

While many traditional cleaners are loaded with chlorides, the industry is providing an ever increasing choice of non-chloride cleaners. If you are not sure of your cleaner's chloride content contact your cleaner supplier. If they tell you that your present cleaner contains chlorides, ask for an alternative. Also, avoid cleaners containing quaternary salts as they also can attack stainless steel & cause pitting and rusting.

4. Treat your Water

Though this is not always practical, softening hard water can do much to reduce deposits. There are certain filters that can be installed to remove distasteful and corrosive elements. Salts in a properly maintained water softener are your friends. If you are not sure of the proper water treatment, call a treatment specialist.

5. Keep your Food Equipment Clean

Use alkaline, alkaline chlorinated or non-chlorinated cleaners at recommended strength. Clean frequently to avoid build-up of hard, stubborn stains. If you boil water in your stainless steel equipment, remember the single most likely cause of damage is chlorides in the water. Heating cleaners that contain chlorides has a similar effect.

6. RINSE, RINSE, RINSE

If chlorinated cleaners are used you must rinse, rinse, rinse and wipe dry immediately. The sooner you wipe off standing water, especially when sit contains cleaning agents, the better. After wiping the equipment down, allow it to air dry for the oxygen helps maintain the stainless steel's passivity film.

7. Never Use Hydrochloric Acid (Muriatic Acid) on Stainless Steel

8. Regularly Restore/Passivate Stainless Steel

Maintenance

Case Cleaning

Long life and satisfactory performance of any equipment are dependent upon the care it receives. To insure long life, proper sanitation and minimum maintenance costs, the merchandiser should be thoroughly cleaned, all debris removed and interiors washed down, weekly.



TO PREVENT INJURY ALWAYS SHUT OFF POWER DURING CLEANING PROCESS.

Exterior Surfaces

The exterior surfaces must be cleaned with a mild detergent without chloride and warm water to protect and maintain their attractive finish. **NEVER USE ABRASIVE CLEANSERS OR SCOURING PADS.**

Cleaning Bumpers

Clean Bumpers with household spray cleaners.

Cleaning Under Merchandiser

Remove lower body panels. Use a vacuum with a long wand attachment to remove accumulated dust and debris from under the merchandiser.

Cleaning Stainless Steel Surfaces

Use non abrasive cleaning materials, and always polish with the grain of the steel. Use warm water or add a mild detergent to the water and apply with a cloth. Always wipe dry after wetting.

Use non-chlorine containing cleaners such as window cleaners and mild detergents. Do not use cleaners containing salts as this may cause pitting and rusting of the stainless steel finish. Do not use bleach.

Clean frequently to avoid build-up of hard, stubborn stains. A stainless steel cleaning solution may be used periodically to minimize scratching and remove stains.

Rinse and wipe dry immediately after cleaning. Never use hydrochloric acid (muriatic acid) on stainless steel.

Interior Surfaces

The interior surfaces may be cleaned with most domestic detergents, ammonia based cleaners and sanitizing solutions that do not contain chloride with no harm to the surface.

Cleaning Coils

NEVER USE SHARP OBJECTS AROUND COILS. Use a soft brush or vacuum brush to clean debris from coils. Do not puncture Coils! Do not bend fins. Contact an authorized service technician if a coil is punctured, cracked, or otherwise damaged.

Recommended Cleaning Schedule

Follow the schedule listed below for optimal sanitation and case performance. Exterior and Interior cleaning will be cleaned varying on upkeep of the merchandiser through daily use.

- Merchandiser Deck & Drain Area: Once a week minimum.
- Gravity Coil & Drip Tray: Once a month minimum.

ICE in or on the coil indicates the refrigeration and defrost cycle is not operating properly. Contact an authorized Service Technician to determine the cause of icing and to make proper adjustments as necessary. To maintain product integrity, if not done so already, move all product to a cooler until the merchandiser has returned to normal operating temperatures.

Maintenance Cont'd

Do Not Use:

- Abrasive cleaners and scouring pads, as these will damage the finish.
- A hose on lighted shelves or submerge lighted shelves in water.
- Solvent, oil or acidic based cleaners on any interior surfaces.
- A hose on LED Lights or any other electrical component.
- **IT IS NOT REQUIRED TO RAISE THE DECK SPIRAL COIL ASSEMBLY DURING CLEANING.**
- The case can be cleaned after removing the deck pan and alum tray. Nothing else needs to be moved or lifted.

Do:

- Remove the product and all loose debris to avoid clogging the waste outlet.
- Store product in a refrigerated area such as a cooler during the cleaning process. Remove only as much product as can be taken to the cooler in a timely manner.
- **First Turn off Refrigeration, then disconnect electrical power to merchandiser.**
- Thoroughly clean all surfaces with soap and hot water. Do not use steam or high pressure water hoses to wash the interior. These will destroy the merchandisers' sealing causing leaks and poor performance.
- Avoid direct contact between fan motors and cleaning or rinse water.
- Rinse with hot water, but DO NOT flood. Never introduce water faster than the waste outlet can drain.
- Allow merchandiser to completely dry before

Electrical

Wiring Color Code

STANDARD CASE WIRE COLOR CODE CODIGO DE COLORES DE LOS ALAMBRES PARA LAS VITRINAS ESTANDAR CODE COULER POUR FILS DE BOITIER NORMALISE		
COLOR DESCRIPTION	DESCRIPCION	DESCRIPTION
■ GROUND	TIERRA MASA	MASSE
■ ANTI-SWEAT	ANTICONDENSACION	ANTI-SUINTEMENT
■ LIGHTS	LUCES	ECLAIRAGE
■ RECEPTACLES	ENCHUFES	PRISE DE COURANT
■ T-STAT/SOLENOID 230VAC	TERMOSTATO/SOLENOIDE (230VAC)	SOUPAPE A SOLENOID (230 VAC)
■ T-STAT/SOLENOID 115VAC	TERMOSTATO/SOLENOIDE (115VAC)	SOUPAPE A SOLENOID (115 VAC)
■ T-STAT/SOLENOID 24VAC	TERMOSTATO/SOLENOIDE (24VAC)	SOUPAPE A SOLENOID (24 VAC)
■ FAN MOTORS	VENTILADORES	VENTILATEUR
■ BLUE CONDENSING UNIT	UNIDAD DE CONDENSACION	UNITE DE CONDENSATION

USE COPPER CONDUCTORS ONLY
UTILISEZ LES CONDUCTEURS DE CUIVRE SEULEMENT
UTILICE LOS CONDUCTORES DE COBRE SOLAMENTE
 430-01-0338 R101003

CASE MUST BE GROUNDED

NOTE: Refer to label affixed to case to determine the actual configuration as checked in the "TYPE INSTALLED" boxes.

Electrical Circuit Identification

Standard lighting for all models will be full length fluorescent lamps located within the case at the top.

The switch controlling the lights, the plug provided for digital scale, and the thermometer are located at the rear of the case mullion.

The receptacle that is provided on the exterior back of these models is intended for computerized scales with a five amp maximum load, not for large motors or other high wattage appliances. It should be wired to a dedicated circuit.

Electrical Service Receptacles (When Applicable) The receptacles located on the exterior of the merchandiser are intended for scales and lighted displays. They are not intended nor suitable for large motors or other external appliances.

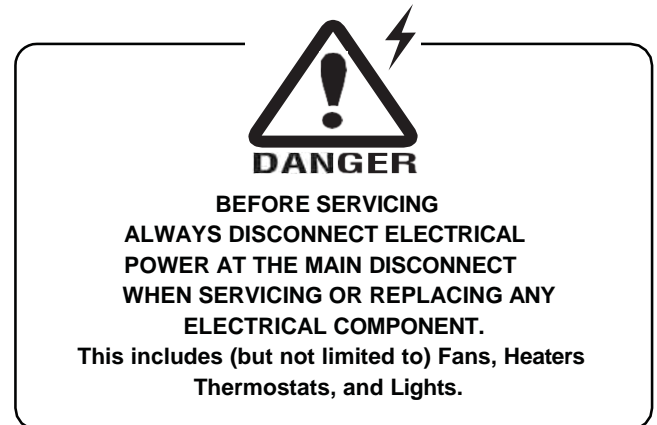

Field Wiring and Serial Plate Amperage

Field Wiring must be sized for component amperes printed on the serial plate. Actual ampere draw may be less than specified. Field wiring from the refrigeration control panel to the merchandisers is required for refrigeration thermostats. Case amperes are listed on the wiring diagram, but always check the serial plate.

Ballast Location

Ballasts are located within the access panel (Electrical raceway) that runs the length of the rear of the case. Refer to Figure 3 on page 15.

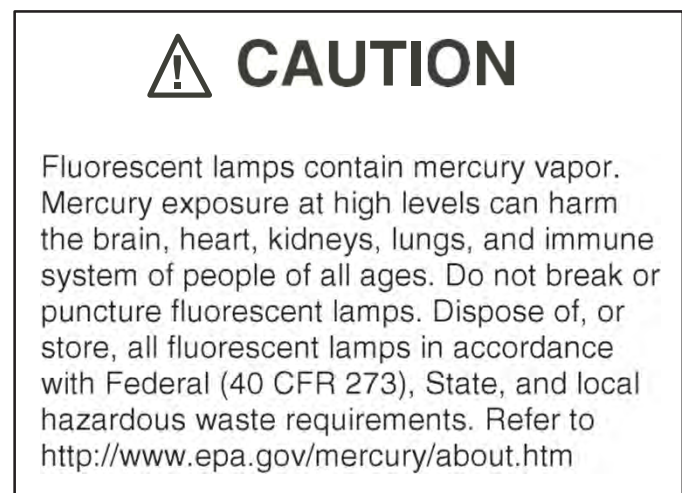

Fluorescent Lamp Disposal: The United States Environmental Protection Agency has information regarding environmentally-safe fluorescent lamp waste management programs.

On the Net: EPA Website:

<http://www.epa.gov/osw/hazard/wastetypes/universal/lamps/recycle.htm>



ENHANCED PERFORMANCE MEAT/FISH SERVICE / SELF-SERVICE CASE
 RUSSMANN - R3HV-MF-EP, CR3HV-MF-EP (CHIND)

REVISION DATE 04/11/18

DOE 2017 Energy Efficiency Compliance
 Minimum refrigerated test conditions compared to units for use in the United States meet or surpass the requirements of the DOE 2017 energy efficiency standards.

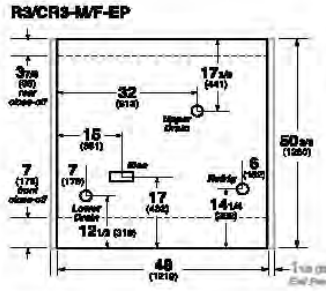
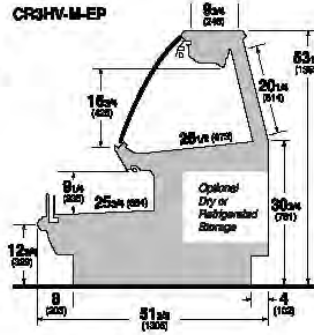
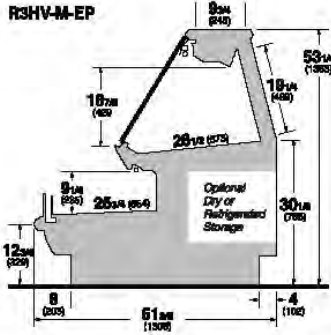

REFRIGERATION DATA:

CASE LENGTHS	CASE USAGE	CAPACITY *** (BTUHR/FT) TOP/FRONT		TEMPERATURE (°F) TOP/FRONT			VELOCITY (FT/MIN) TOP/FRONT
		RATING CONDITION		EVAPORATOR		DISCHARGE AIR ** (°F)	
		NSF 7	AHRI 1200	NSF 7	AHRI 1200	NSF 7	
4', 6', 8', 10', 12'	MEAT/FISH	230 / 680	230 / 680	26 / 26	26 / 26	33 / 34	75 / 175
REAR STORAGE	MEAT/FISH	95	95	26	26	32-34	600-725

CASE LENGTHS	EST. REFG. CHR.G. (LBS)	20°F GLYCOL 0° RISE					
		TOP		FRONT		REFRIGERATED REAR STORAGE	
		GPM	PSI	GPM	PSI	GPM	PSI
4'	1.7	0.4	5.4	1.0	2.5	0.1	0.0
6'	2.4	0.5	2.9	1.4	5.7	0.2	0.2
8'	3.4	0.7	5.4	1.9	2.6	0.3	0.3
10'	4.3	0.8	8.6	2.3	4.6	0.3	0.5
12'	5.1	1.0	5.5	2.8	5.4	0.4	0.7

**FRONT DISCHARGE AIR MEASURED INSIDE AIR CURTAIN HONEYCOMB

***REFRIGERATION NOTES:

- 1) BTUS DO NOT INCLUDE LIGHTS
- 2) ADD 10 BTUS PER FOOT/PER SHELF ROW FOR OPTIONAL LED SHELF LIGHTS
- 3) AHRI 1200 RATING POINT FOR ENERGY CONSUMPTION COMPARISON ONLY
- 4) USE DEW POINT F FOR HIGH GLIDE REFRIGERANTS. CARE SHOULD BE TAKEN TO USE THE DEW POINT IN P/T TABLES FOR MEASURING AND ADJUSTING SUPERHEAT. ADJUST EVAPORATOR PRESSURE AS NEEDED TO MAINTAIN THE DISCHARGE AIR TEMPERATURE SHOWN.
- 5) RATING CONDITION IS NSF TYPE I, 75°F/55% RH

REFRIGERATION DATA CONTINUED:

ELEC. THERMOSTAT / AIR SENSOR SETTINGS		DEFROST TYPE	TIME (MIN)	DEFROST FREQUENCY (#/DAY)	TERM. TEMP (°F) COIL ONLY	DRIP TIME	DEFROST WATER (LBS/DAY/FT)
LOCATION	CUT IN (°F) / CUT OUT (°F)						
GRAVITY COIL DISCHARGE AIR	34 / 33	OFF TIME	30	4	54	N/A	TBD
DECK COIL FRONT	30 / 29						
FRONT	28 / 26						
REAR STORAGE	37 / 36						

END PANEL WIDTH KEY		
# OF END PNL'S	END PNL WIDTH (IN.)	TOTAL ADDED LENGTH (IN.)
1	1.125	1.125
2	1.125	2.25

ELECTRICAL DATA:

STANDARD FANS, HEATERS, LED LIGHTS (115VOLT)

CASE LENGTH	EVAPORATOR FANS: FRONT SECTION				EVAPORATOR FANS: REFRIGERATED REAR STORAGE (OPTIONAL)				AIR SWEEP FANS			CANOPY LIGHTS LED TOP AND FRONT		OPTIONAL LED SHELF LIGHTS FRONT		MAX. LED LOAD (W/ ALL OPTIONS)		ANTI-SWEAT HEATERS		CONVENIENCE OUTLETS (OPTIONAL)		
	# OF EVAP FANS	BLADE DIA. (IN.)	BLADE PITCH (°)	AMPS	WATTS	# OF EVAP FANS	AMPS	WATTS	# OF AIR SWEEP FANS	AMPS	WATTS	AMPS	WATTS	AMPS	WATTS	AMPS	WATTS	AMPS	WATTS	# OUTLETS	VOLTS	AMPS
4'	2	6.7	15	0.2	16	1	0.3	9	N/A	N/A	N/A	0.2	28	0.1	10	0.3	39	0.4	46	1	115	15
6'	3	6.7	15	0.4	24	1	0.3	9	N/A	N/A	N/A	0.4	41	0.1	15	0.5	56	0.6	68	1	115	15
8'	4	6.7	15	0.5	32	1	0.3	9	N/A	N/A	N/A	0.5	57	0.2	21	0.7	77	0.8	91	1	115	15
10'	6	6.7	10	0.7	48	1	0.3	9	N/A	N/A	N/A	0.7	78	0.2	26	0.9	103	1.0	114	1	115	15
12'	6	6.7	15	0.7	48	1	0.3	9	N/A	N/A	N/A	0.7	83	0.3	31	1.0	114	1.2	137	2	115	30

OPTIONAL HIGH OUTPUT LED LIGHTS (115 VOLT)

CASE LENGTH	CANOPY LIGHTS H.O. LED		OPTIONAL SHELF		MAX. H.O. LED LOAD	
	AMPS	WATTS	AMPS	WATTS	AMPS	WATTS
4'	0.4	43	0.1	15	0.5	59
6'	N/A	N/A	N/A	N/A	N/A	N/A
8'	0.8	87	0.3	30	1.0	117
10'	N/A	N/A	N/A	N/A	N/A	N/A
12'	1.1	130	0.4	46	1.5	176



DELI SERVICE - SELF SERVICE
HUSSMANN - R3HV-M, CR3HV-M, R3HV-F, CR3HV-F (CHINO)

REVISION DATE 01/11/18

DOE 2017 Energy Efficiency Compliant

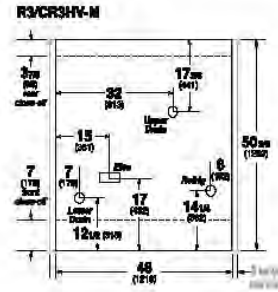
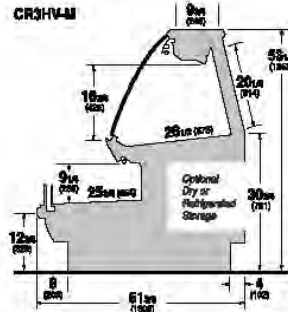
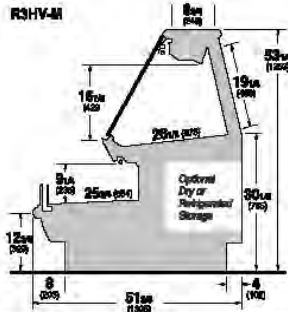

REFRIGERATION DATA:

CASE LENGTHS/ WEDGES	CASE USAGE	CAPACITY TOP/FRONT *** (BTU/HR/FT)		TEMPERATURE (°F)				VELOCITY (TOP/FRONT) (FT/MIN)
		RATING CONDITION		EVAPORATOR (TOP/FRONT)		DISCHARGE AIR (TOP/FRONT **)		
		NSF 7	AHRI 1200	NSF 7	AHRI 1200	NSF 7	NSF 7	
4', 6', 8', 12'	MEAT / FISH	260/740	120/335	20/20	24/24	26 / 30	50~75 / 175~200	
REAR STORAGE	MEAT / FISH	110	90	20	26	32~34	380~600	

CASE LENGTH S	EST. REFG. CHR.G. (R404A) (LBS)	20°F GLYCOL 6° RISE INLET TOP		20°F GLYCOL 6° RISE INLET FRONT		20° GLYCOL 6° RISE INLET OPTION REFRIGERATED REAR STORAGE	
		GPM	PSI	GPM	PSI	GPM	PSI
4'	1.8	0.4	0.7	1.1	2.7	0.2	0.1
6'	2.6	0.5	2.0	1.5	6.2	0.2	0.3
8'	3.5	0.7	3.7	2.0	2.9	0.3	0.5
12'	5.2	1.0	8.7	3.0	5.8	0.5	1.1

**FRONT DISCHARGE AIR MEASURED INSIDE AIR CURTAIN HONEYCOMB

**REFRIGERATION NOTES:

- 1) BTU'S INCLUDE 2 ROWS (1 TOP; 1 FRONT) CANOPY LED LIGHTS AND NO SHELF LIGHTS
- 2) ADD 10 BTU'S PER FOOT/PER SHELF FOR OPTIONAL LED SHELF LIGHTS
- 3) AHRI 1200 RATING POINT FOR ENERGY CONSUMPTION COMPARISON ONLY
- 4) USE DEW POINT FOR HIGH GLIDE REFRIGERANTS. CARE SHOULD BE TAKEN TO USE THE DEW POINT IN P/T TABLES FOR MEASURING AND ADJUSTING SUPERHEAT. ADJUST EVAPORATOR PRESSURE AS NEEDED TO MAINTAIN THE DISCHARGE AIR TEMPERATURE SHOWN.
- 5) THE PRINCIPAL COOLING EFFECT IN FISH CASES IS ACCOMPLISHED WITH A TRADITIONAL ICE BED. THE REFRIGERATION PRESERVES THE ICE AND MAINTAINS A COLD PROTECTIVE LAYER OVER THE PRODUCT.
- 6) RATING CONDITION IS NSF TYPE I, 75°F/55% RH

REFRIGERATION DATA CONTINUED:

LOCATION	ELEC. THERMOSTAT / AIR SENSOR SETTINGS		DE FROST TYPE	TIME (MIN)	DE FROSTS PER DAY	TERM. TEMP (°F) AIR TEMP	DRIP TIME	DEFROST WATER (LBS /DAY/FT)	FAN BLADE DIA.	FAN BLADE PITCH
	USAGE	CUT IN (°F)								
TOP	MEAT / FISH	29	26	OFF TIME	40	45	NA	0.34	6.75"	N/A
FRONT	MEAT / FISH	31	28							
REFRIGERATED REAR STORAGE	MEAT / FISH	37	36							

END PANEL WIDTH KEY

# OF END PNLS	END PNL WIDTH (IN.)	TOTAL ADDED LENGTH (IN.)
1	1.125	1.125
2	1.125	2.25

ELECTRICAL DATA:

STANDARD FANS, HEATERS, LED LIGHTS (115 VOLT)

CASE LENGTH	TOTAL EVAPORATOR FANS			CANOPY LIGHTS LED TOP & FRONT		OPTIONAL LED SHELF LIGHTS (FRONT AND TOP)		OPTIONAL LED 2ND SHELF (TOP)		MAX. LED LOAD (W/ALL OPTIONS)		ANTI-SWEAT HEATERS		REFRIGERATED REAR STORAGE (OPTIONAL) EVAP FANS			CONVENIENCE OUTLETS (OPTIONAL)		
	# OF EVAP FANS	AMPS	WATTS	AMPS	WATTS	AMPS	WATTS	AMPS	WATTS	AMPS	WATTS	AMPS	WATTS	# OF EVAP FANS	AMPS	WATTS	# OUTLET S	VOLTS	AMPS
4'	2	0.2	16	0.2	28	0.1	10	0.1	10	0.4	49	0.8	97	1	0.3	8.8	1	115	15
6'	2	0.2	16	0.4	41	0.1	15	0.1	15	0.6	72	1.3	147	1	0.3	8.8	1	115	15
8'	4	0.5	32	0.5	57	0.2	21	0.2	21	0.9	98	1.7	197	1	0.3	8.8	1	115	15
12'	6	0.7	48	0.7	85	0.3	31	0.3	31	1.3	147	2.6	297	1	0.3	8.8	2	115	30

OPTIONAL HIGH OUTPUT LED LIGHTS (115 VOLT)

CASE LENGTH	CANOPY LIGHTS H.O. LED TOP & FRONT		OPTIONAL SHELF (FRONT AND TOP)		OPTIONAL 2ND SHELF (TOP)		MAX. H.O. LED LOAD	
	AMPS	WATTS	AMPS	WATTS	AMPS	WATTS	AMPS	WATTS
4'	0.4	46	0.1	15	0.1	15	0.7	76
6'	0.7	78	0.2	26	0.2	26	1.1	130
8'	0.8	91	0.3	30	0.3	30	1.3	152
12'	1.2	137	0.4	46	0.4	46	2.0	228

Wiring Diagrams

R3HV-M/F-EP	DIGITAL T-STATS, ROPE HTRS NO CALRODS	4'	3154451
	DIGITAL T-STATS, ROPE HTRS NO CALRODS	6'	3154452
	DIGITAL T-STATS, ROPE HTRS NO CALRODS	8'	3154453
	DIGITAL T-STATS, ROPE HTRS NO CALRODS	10'	3154454
	DIGITAL T-STATS, ROPE HTRS NO CALRODS	12'	3154455
	DIGITAL 208V, ROPE HTRS NO CALRODS	8'	2H18308
	DIGITAL 208V, ROPE HTRS NO CALRODS	12'	2H18309

REVISION HISTORY			
REV	ECN	DATE	REVISION DESCRIPTION
B	ECN-COD-001562L	11-1-22	REMOVED GLASS HTR-FRACAS
C	ECN-COD-001814L	7-6-23	CHANGED FAN MOTOR

REV	CHKD BY	APPR BY
AL	CB	CB
CB	CB	CB
CB	CB	CB

CIRCUIT #1	LOADING
120 V	
LI	
LI	
LI	

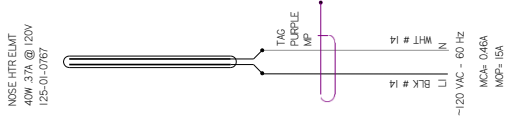
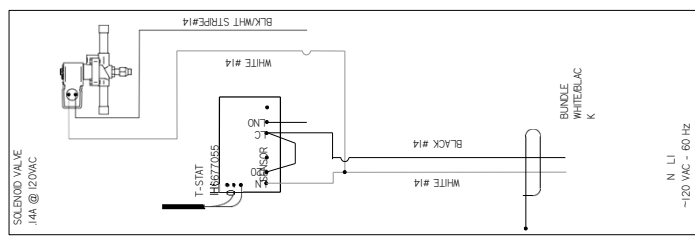
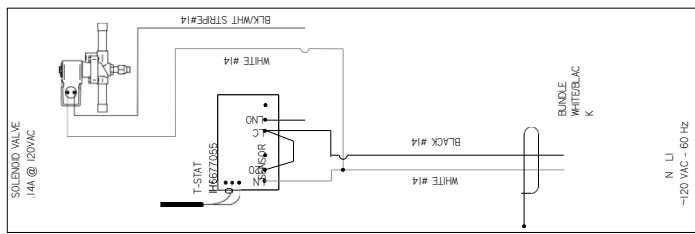
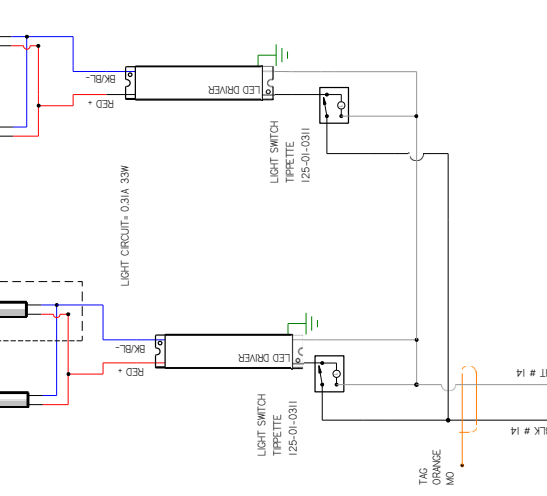
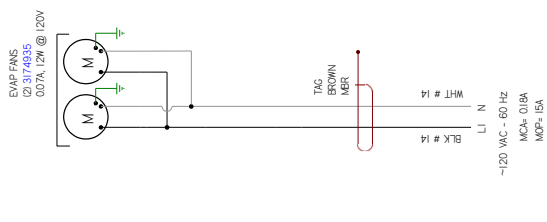
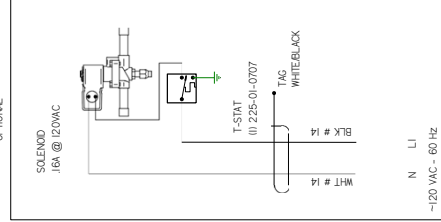
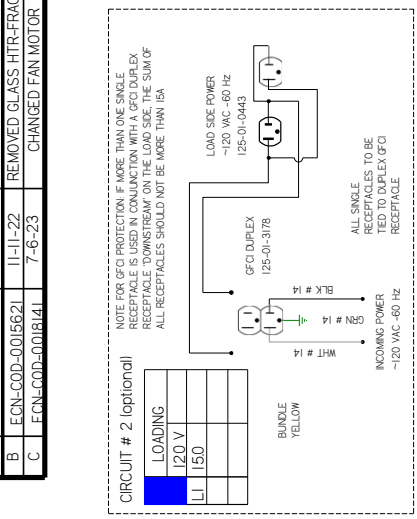

HUSSMANN
DIAGRAM-R3HV-
MF-EP-4-R

FACTORY 14GA WIRE
 _FACTORY LOGGA WIRE
 --- FIELD WIRE
 DO NOT SCALE DRAWING
 SHEET 1 OF 1

UL COLOR CODES / ABBREVIATIONS

RED = RD	WHITE = WT
BLACK = BK	GREEN = GN
BLUE = BL	BROWN = BN
YELLOW = YL	ORANGE = OR
GRAY = GR	OR VIOLET = VT

WIRE MARKER COLORS/ABBREVIATIONS

BLACK = MBK	MAROON =
BLUE = MBL	MMR ORANGE =
BROWN = MBR	MO PINK = MPI
DARK BLUE =	PURPLE = MP
DBG GREEN = MG	RED = MR
LIGHT BLUE =	YELLOW = MYL

NOTES:
 1. PRINTED DOCUMENT REQUIRED SETTING: ALL COLORS BLACK & WHITE
 2. CASE & ANY REMOVABLE PANEL WITH ELECTRICAL PARTS MUST BE GROUNDED.
 3. WHEN PASSING WIRES THROUGH METAL HOLES A GROMMET MUST BE USED

REVISION HISTORY			
REV	ECN	DATE	REVISION DESCRIPTION
B	ECN-COD-0016843	11-10-22	REMOVED GLASS HTR-FRACAS
C	ECN-COD-0018141	7-6-23	CHANGED FAN MOTOR

CIRCUIT #1 LOADING	
120 V	
150	

CIRCUIT #2 optional	
120 V	
150	

UL COLOR CODES / ABBREVIATIONS	
RED = RD	WHITE = WT
BLACK = BK	GREEN = GN
BLUE = BL	BROWN = BN
YELLOW = YL	ORANGE = OR
GRAY = GR	OR VIOLET = VT

WIRE MARKER COLORS/ABBREVIATIONS	
BLACK = MBK	MAROON = MR
BLUE = MBL	MNR ORANGE = MNR
BROWN = MBR	MO PINK = MPI
DARK BLUE = MDB	PURPLE = MP
MDB GREEN = MCG	RED = MR
LIGHT BLUE = MYL	YELLOW = MYL

WIRE MARKER COLORS/ABBREVIATIONS	
RED = RD	WHITE = WT
BLACK = BK	GREEN = GN
BLUE = BL	BROWN = BN
YELLOW = YL	ORANGE = OR
GRAY = GR	OR VIOLET = VT

DO NOT SCALE DRAWING

SHEET 1 OF 1

3154452

HUSSMANN

DIAGRAM-R3HV-
MF-EP-6-R

REV C

FACTORY 14GA WIRE

FACTORY LOGGA WIRE

FIELD WIRE

DO NOT SCALE DRAWING

SHEET 1 OF 1

3154452

HUSSMANN

DIAGRAM-R3HV-
MF-EP-6-R

REV C

FACTORY 14GA WIRE

FACTORY LOGGA WIRE

FIELD WIRE

DO NOT SCALE DRAWING

SHEET 1 OF 1

3154452

HUSSMANN

DIAGRAM-R3HV-
MF-EP-6-R

REV C

FACTORY 14GA WIRE

FACTORY LOGGA WIRE

FIELD WIRE

DO NOT SCALE DRAWING

SHEET 1 OF 1

3154452

HUSSMANN

DIAGRAM-R3HV-
MF-EP-6-R

REV C

FACTORY 14GA WIRE

FACTORY LOGGA WIRE

FIELD WIRE

DO NOT SCALE DRAWING

SHEET 1 OF 1

3154452

HUSSMANN

DIAGRAM-R3HV-
MF-EP-6-R

REV C

FACTORY 14GA WIRE

FACTORY LOGGA WIRE

FIELD WIRE

DO NOT SCALE DRAWING

SHEET 1 OF 1

3154452

HUSSMANN

DIAGRAM-R3HV-
MF-EP-6-R

REV C

FACTORY 14GA WIRE

FACTORY LOGGA WIRE

FIELD WIRE

DO NOT SCALE DRAWING

SHEET 1 OF 1

3154452

HUSSMANN

DIAGRAM-R3HV-
MF-EP-6-R

REV C

FACTORY 14GA WIRE

FACTORY LOGGA WIRE

FIELD WIRE

DO NOT SCALE DRAWING

SHEET 1 OF 1

3154452

HUSSMANN

DIAGRAM-R3HV-
MF-EP-6-R

REV C

FACTORY 14GA WIRE

FACTORY LOGGA WIRE

FIELD WIRE

DO NOT SCALE DRAWING

SHEET 1 OF 1

3154452

HUSSMANN

DIAGRAM-R3HV-
MF-EP-6-R

REV C

FACTORY 14GA WIRE

FACTORY LOGGA WIRE

FIELD WIRE

DO NOT SCALE DRAWING

SHEET 1 OF 1

3154452

HUSSMANN

DIAGRAM-R3HV-
MF-EP-6-R

REV C

FACTORY 14GA WIRE

FACTORY LOGGA WIRE

FIELD WIRE

DO NOT SCALE DRAWING

SHEET 1 OF 1

3154452

HUSSMANN

DIAGRAM-R3HV-
MF-EP-6-R

REV C

FACTORY 14GA WIRE

FACTORY LOGGA WIRE

FIELD WIRE

DO NOT SCALE DRAWING

SHEET 1 OF 1

3154452

HUSSMANN

DIAGRAM-R3HV-
MF-EP-6-R

REV C

FACTORY 14GA WIRE

FACTORY LOGGA WIRE

FIELD WIRE

DO NOT SCALE DRAWING

SHEET 1 OF 1

3154452

HUSSMANN

DIAGRAM-R3HV-
MF-EP-6-R

REV C

FACTORY 14GA WIRE

FACTORY LOGGA WIRE

FIELD WIRE

DO NOT SCALE DRAWING

SHEET 1 OF 1

3154452

HUSSMANN

DIAGRAM-R3HV-
MF-EP-6-R

REV C

FACTORY 14GA WIRE

FACTORY LOGGA WIRE

FIELD WIRE

DO NOT SCALE DRAWING

SHEET 1 OF 1

3154452

HUSSMANN

DIAGRAM-R3HV-
MF-EP-6-R

REV C

FACTORY 14GA WIRE

FACTORY LOGGA WIRE

FIELD WIRE

DO NOT SCALE DRAWING

SHEET 1 OF 1

3154452

HUSSMANN

DIAGRAM-R3HV-
MF-EP-6-R

REV C

FACTORY 14GA WIRE

FACTORY LOGGA WIRE

FIELD WIRE

DO NOT SCALE DRAWING

SHEET 1 OF 1

3154452

HUSSMANN

DIAGRAM-R3HV-
MF-EP-6-R

REV C

FACTORY 14GA WIRE

FACTORY LOGGA WIRE

FIELD WIRE

DO NOT SCALE DRAWING

SHEET 1 OF 1

3154452

HUSSMANN

DIAGRAM-R3HV-
MF-EP-6-R

REV C

FACTORY 14GA WIRE

FACTORY LOGGA WIRE

FIELD WIRE

DO NOT SCALE DRAWING

SHEET 1 OF 1

3154452

HUSSMANN

DIAGRAM-R3HV-
MF-EP-6-R

REV C

FACTORY 14GA WIRE

FACTORY LOGGA WIRE

FIELD WIRE

DO NOT SCALE DRAWING

SHEET 1 OF 1

3154452

HUSSMANN

DIAGRAM-R3HV-
MF-EP-6-R

REV C

FACTORY 14GA WIRE

FACTORY LOGGA WIRE

FIELD WIRE

DO NOT SCALE DRAWING

SHEET 1 OF 1

3154452

HUSSMANN

DIAGRAM-R3HV-
MF-EP-6-R

REV C

FACTORY 14GA WIRE

FACTORY LOGGA WIRE

FIELD WIRE

DO NOT SCALE DRAWING

SHEET 1 OF 1

3154452

HUSSMANN

DIAGRAM-R3HV-
MF-EP-6-R

REV C

FACTORY 14GA WIRE

FACTORY LOGGA WIRE

FIELD WIRE

DO NOT SCALE DRAWING

SHEET 1 OF 1

3154452

HUSSMANN

DIAGRAM-R3HV-
MF-EP-6-R

REV C

FACTORY 14GA WIRE

FACTORY LOGGA WIRE

FIELD WIRE

DO NOT SCALE DRAWING

SHEET 1 OF 1

3154452

HUSSMANN

DIAGRAM-R3HV-
MF-EP-6-R

REV C

FACTORY 14GA WIRE

FACTORY LOGGA WIRE

FIELD WIRE

DO NOT SCALE DRAWING

SHEET 1 OF 1

3154452

HUSSMANN

DIAGRAM-R3HV-
MF-EP-6-R

REV C

FACTORY 14GA WIRE

FACTORY LOGGA WIRE

FIELD WIRE

DO NOT SCALE DRAWING

SHEET 1 OF 1

3154452

HUSSMANN

DIAGRAM-R3HV-
MF-EP-6-R

REV C

FACTORY 14GA WIRE

FACTORY LOGGA WIRE

FIELD WIRE

DO NOT SCALE DRAWING

SHEET 1 OF 1

3154452

HUSSMANN

DIAGRAM-R3HV-
MF-EP-6-R

REV C

FACTORY 14GA WIRE

FACTORY LOGGA WIRE

FIELD WIRE

DO NOT SCALE DRAWING

SHEET 1 OF 1

3154452

HUSSMANN

DIAGRAM-R3HV-
MF-EP-6-R

REV C

FACTORY 14GA WIRE

FACTORY LOGGA WIRE

FIELD WIRE

DO NOT SCALE DRAWING

SHEET 1 OF 1

REV	ECN	DATE	REVISION DESCRIPTION	REV BY	CHKD BY	APPR BY
B	ECN-COD-0016843	11-10-22	REMOVED GLASS HTR-FRACAS	CB	CB	CB
C	ECN-COD-0018141	7-6-23	CHANGED FAN MOTOR	CB	CB	CB

REVISION HISTORY
REMOVED GLASS HTR-FRACAS
CHANGED FAN MOTOR

CIRCUIT #1	LOADING
20V	
120V	
150V	

CIRCUIT #2 (optional)	LOADING
120V	
150V	

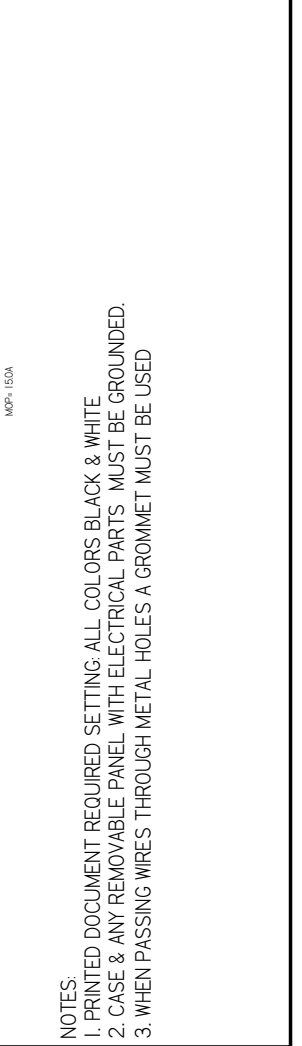
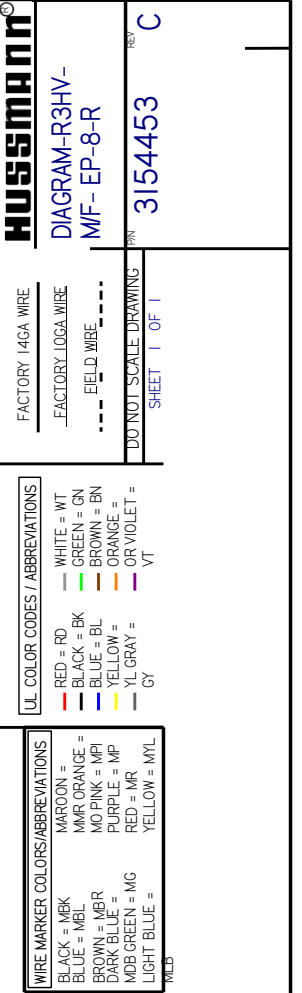
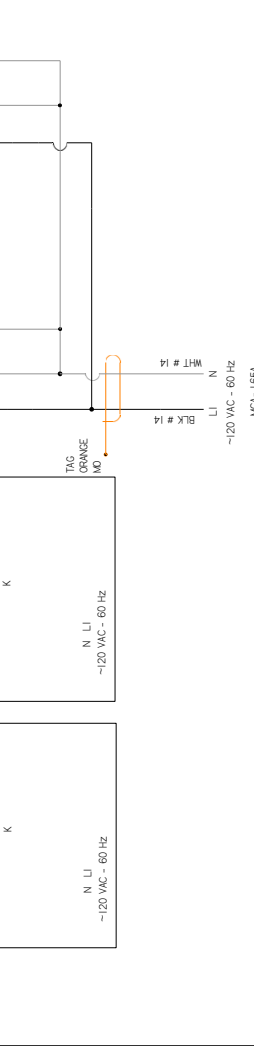
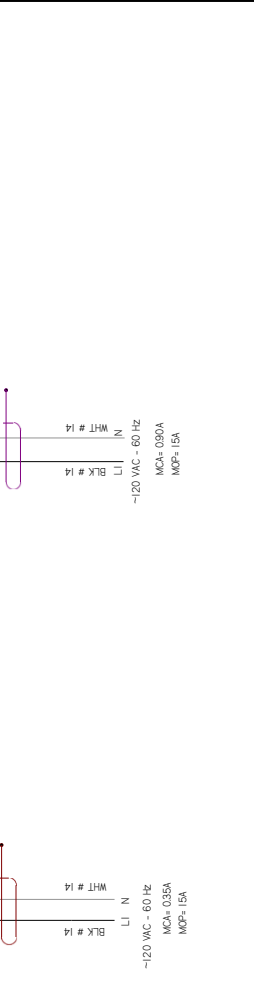
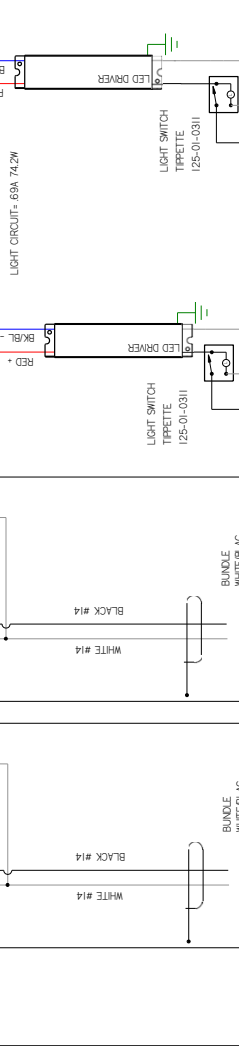
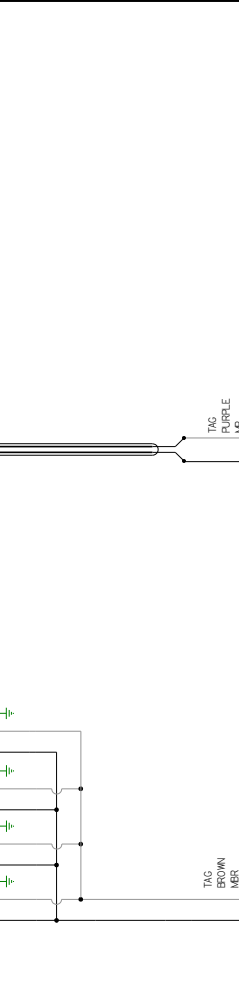
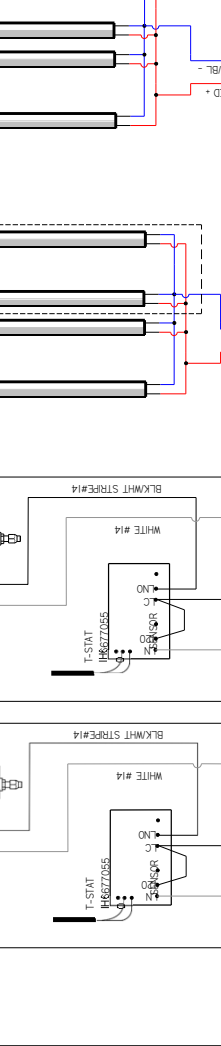
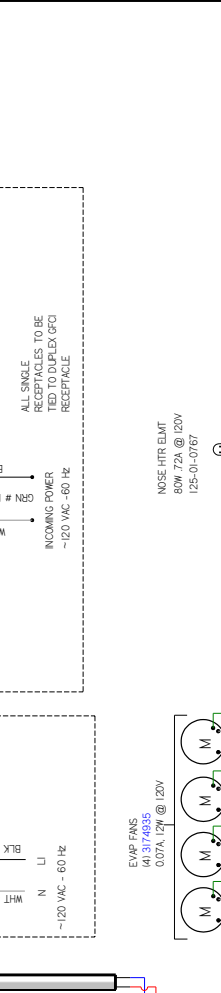
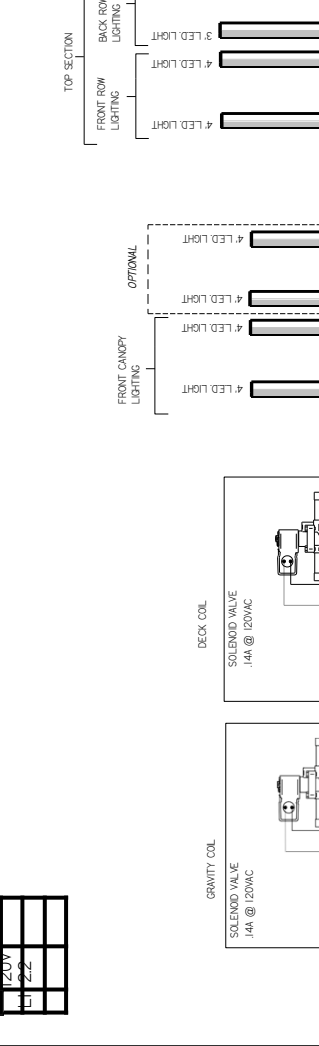
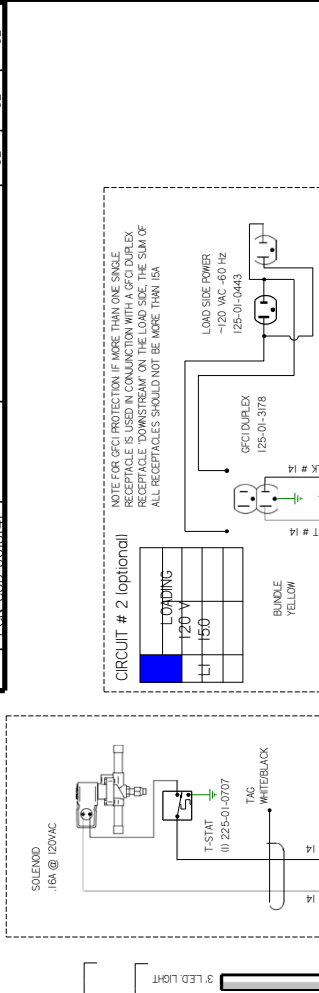

NOTE: 1. PRINTED DOCUMENT REQUIRED SETTING: ALL COLORS BLACK & WHITE
 2. CASE & ANY REMOVABLE PANEL WITH ELECTRICAL PARTS MUST BE GROUNDED.
 3. WHEN PASSING WIRES THROUGH METAL HOLES A GROMMET MUST BE USED

UL COLOR CODES / ABBREVIATIONS	
RED = RD	WHITE = WT
BLACK = BK	GREEN = GN
BLUE = BL	BROWN = BN
YELLOW = YL	ORANGE = OR
YL GRAY = YL GRAY	OR VIOLET = OR VIOLET
	VT

WIRE MARKER COLORS/ABBREVIATIONS	
BLACK = MBK	MAROON = MAROON
BLUE = MBL	MNR ORANGE = MNR ORANGE
BROWN = MBR	MO PINK = MPI
DARK BLUE = MDB	PURPLE = MP
GREEN = MGR	RED = MR
LIGHT BLUE = MBL	YELLOW = MYL

FACTORY 14GA WIRE
FACTORY LOGA WIRE
FIELD WIRE

DO NOT SCALE DRAWING
SHEET 1 OF 1

HUSSMANN
 DIAGRAM-R3HV-
 MF-EP-8-R
 3154453
 MCA-099A
 MOP-15A

REV	ECN	DATE	REVISION DESCRIPTION	REV BY	CHKD BY	APPR BY
B	ECN-COD-0016843	11-10-22	REMOVED GLASS HTR-FRACAS	CB	CB	CB
C	ECN-COD-0018141	7-6-23	CHANGED FAN MOTOR	CB	CB	CB

REVISION HISTORY	
REV	ECN
B	ECN-COD-0016843
C	ECN-COD-0018141

CIRCUIT #1 LOADING	
120V	
150	

CIRCUIT #2 optional LOADING	
120V	
150	

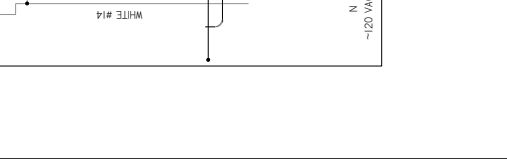
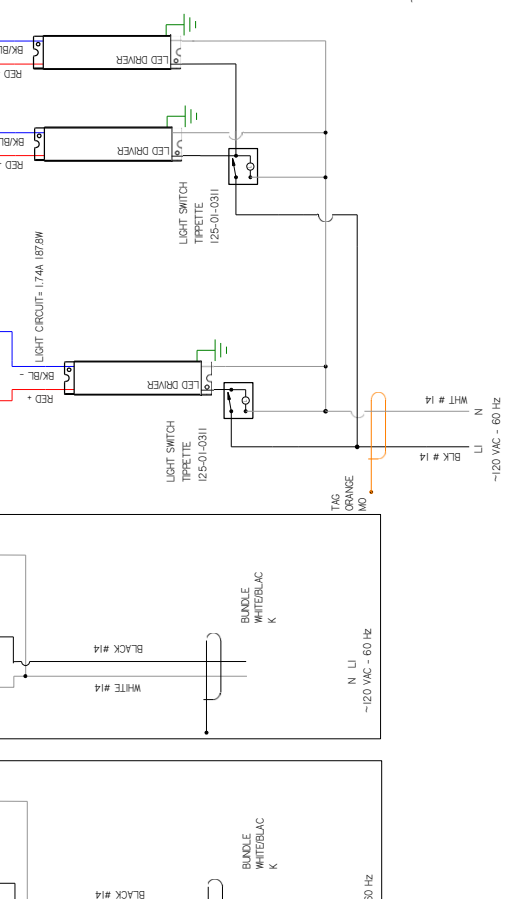
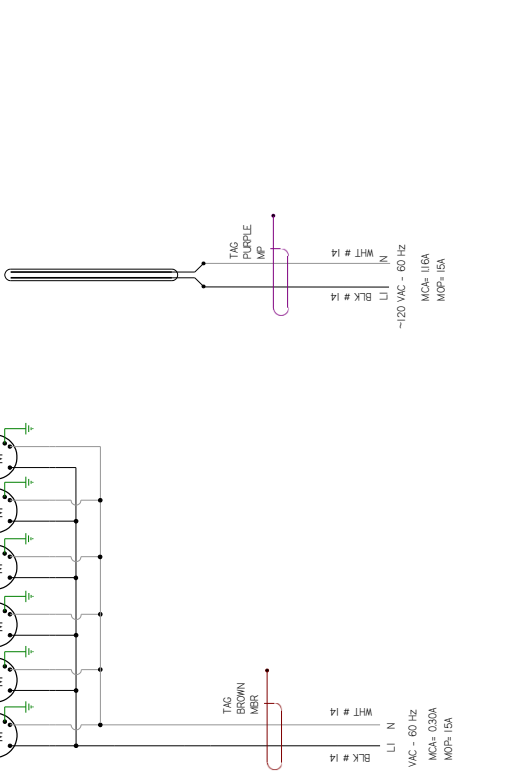
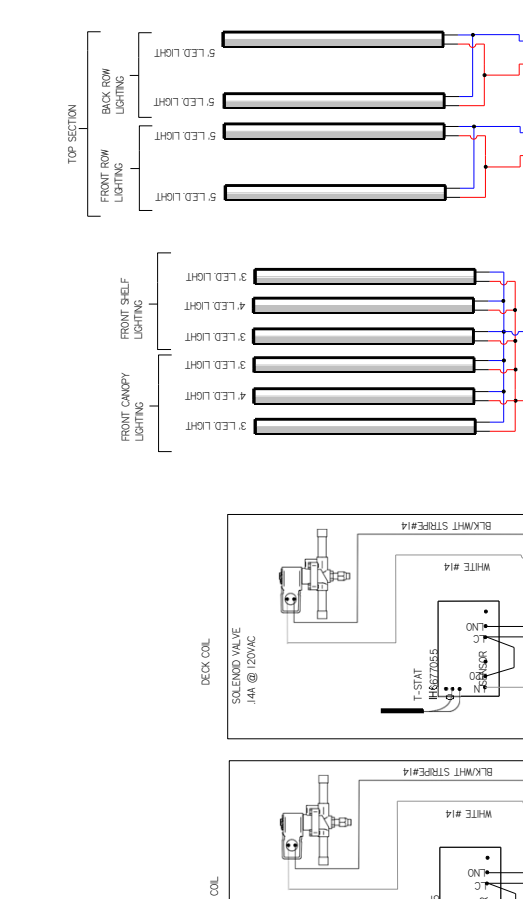
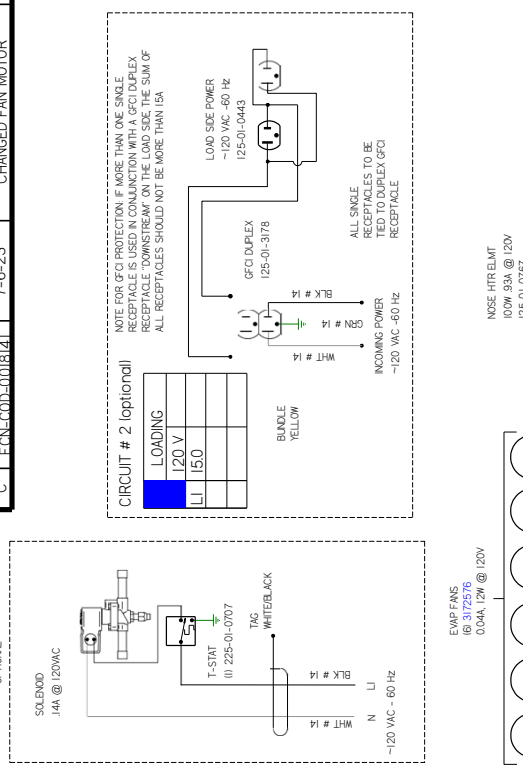

HUSSMANN
DIAGRAM-R3HV-
MF-EP-10-R

FACTORY 14GA WIRE	FACTORY LOGGA WIRE	FIELD WIRE
DO NOT SCALE DRAWING	SHEET 1 OF 1	

UL COLOR CODES / ABBREVIATIONS	
RED = RD	WHITE = WT
BLACK = BK	GREEN = GN
BLUE = BL	BROWN = BN
YELLOW = YL	ORANGE = OR
GRAY = GR	PURPLE = PR
	VIOLET = VT

WIRE MARKER COLORS/ABBREVIATIONS	
BLACK = MBK	MAROON = MR
BLUE = MBL	MMR ORANGE = MO
BROWN = MBR	MO PINK = MPI
DARK BLUE = MDB	PURPLE = MP
GREEN = MGR	RED = MR
LIGHT BLUE = MVL	YELLOW = MYL

NOTES:
 1. PRINTED DOCUMENT REQUIRED SETTING: ALL COLORS BLACK & WHITE
 2. CASE & ANY REMOVABLE PANEL WITH ELECTRICAL PARTS MUST BE GROUNDED.
 3. WHEN PASSING WIRES THROUGH METAL HOLES A GROMMET MUST BE USED

CIRCUIT #1
LOADING

120V	
150	

REV	ECN	DATE	REVISION DESCRIPTION	REV BY	CHKD BY	APPR BY
B	ECN-000-0016843	11-10-22	REMOVED GLASS HTR-FRACAS	CB	CB	CB
C	ECN-000-0018141	7-6-23	CHANGED FAN MOTOR	CB	CB	CB

REVISION HISTORY

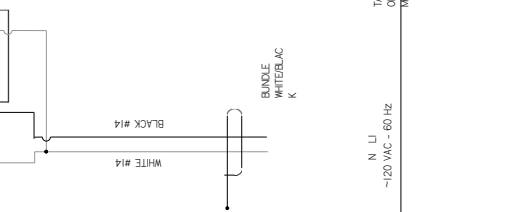
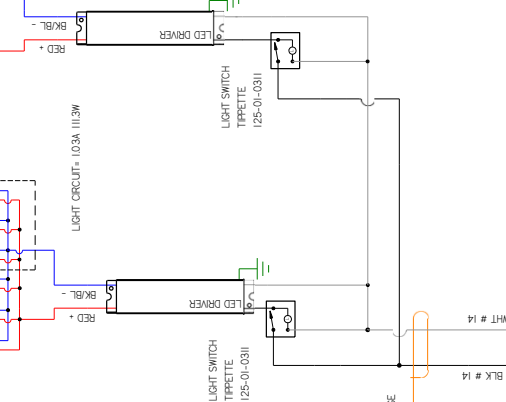
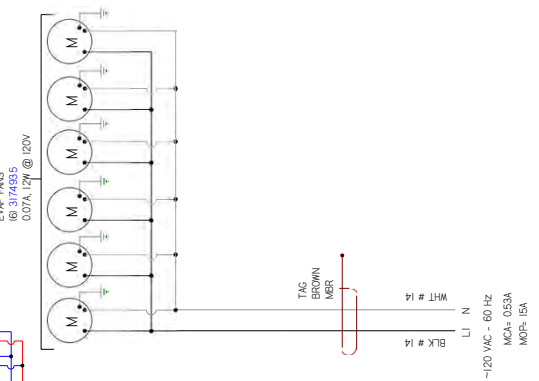
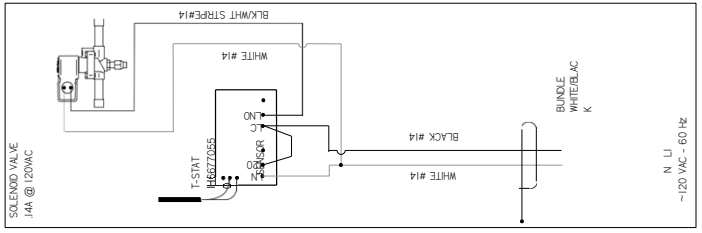
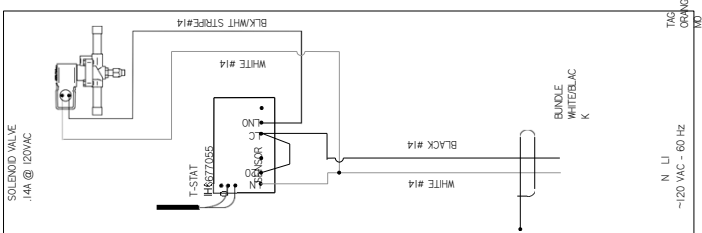
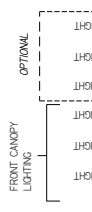
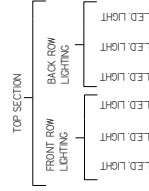
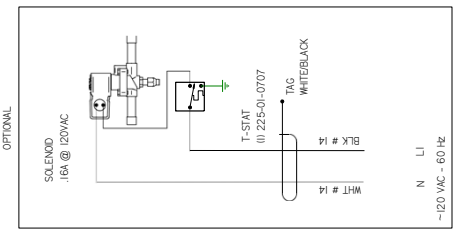
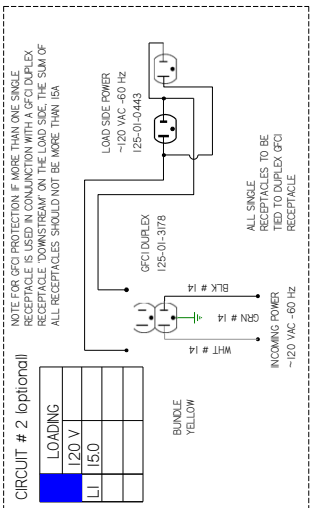

HUSSMANN
DIAGRAM-R3HV-
MF-EP-12-R

FACTORY 14GA WIRE
_FACTORY 10GA WIRE
_FIELD WIRE - - -
DO NOT SCALE DRAWING
SHEET 1 OF 1

UL COLOR CODES / ABBREVIATIONS
RED = RD
BLACK = BK
BLUE = BL
YELLOW = YL
GRAY = GR
WHITE = WT
GREEN = GN
BROWN = BN
ORANGE = OR
OR VIOLET = VT

WIRE MARKER COLORS/ABBREVIATIONS
BLACK = MBK
BLUE = MBL
BROWN = MBR
DARK BLUE = MDB
MARBON = MAR
MMR ORANGE = MMR
MO PINK = MPI
PURPLE = MPP
RED = MRR
YELLOW = MYL

3154455
REV C

NOTES:
1. PRINTED DOCUMENT REQUIRED SETTING: ALL COLORS BLACK & WHITE
2. CASE & ANY REMOVABLE PANEL WITH ELECTRICAL PARTS MUST BE GROUNDED.
3. WHEN PASSING WIRES THROUGH METAL HOLES A GROMMET MUST BE USED

REV	EN	DATE	REVISION DESCRIPTION	REV BY	CHKD BY	APPR BY
A	005293	2016/09/29	ADDED 3RD T-STAT	CB	CB	CB
B	EEN-CAP-00090000	2016/09/16	CHANGED T-STAT	CB	CB	CB
C	EEN-COD-0015253	2022/02/09	NEW LIGHTS	AL	CB	CB
D	EEN-COD-0018141	2022/02/09	CHANGED FANS AND LIGHTS	CB	CB	CB

CIRCUIT #1

LOADING	120V	150V
LI		

CIRCUIT #2

LOADING	120V	150V
LI		

CIRCUIT #1

LOADING	120V	150V
LI		

CIRCUIT #2

LOADING	120V	150V
LI		

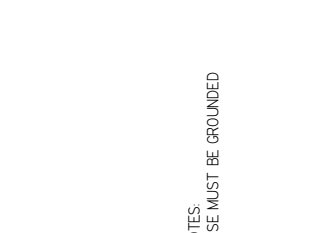
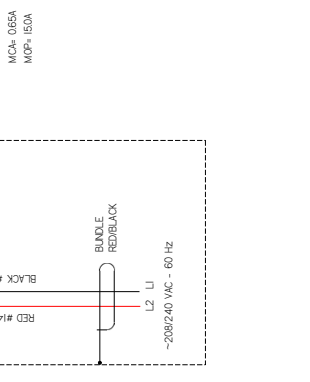
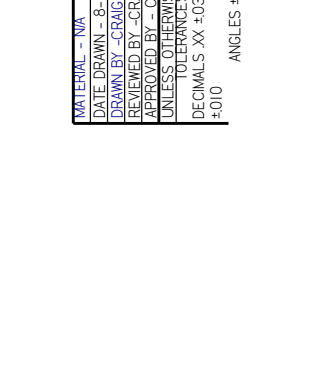
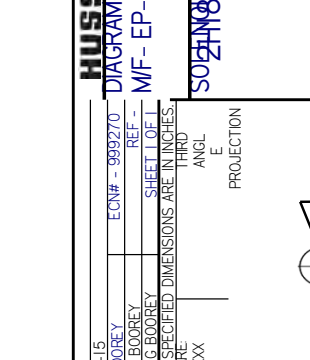
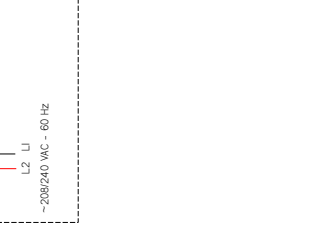
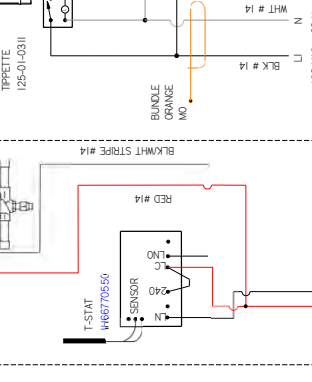
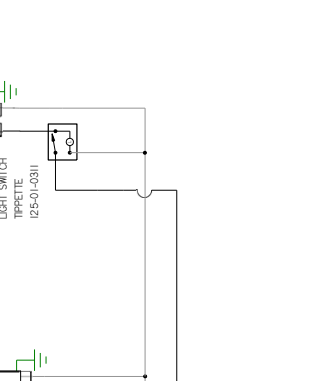
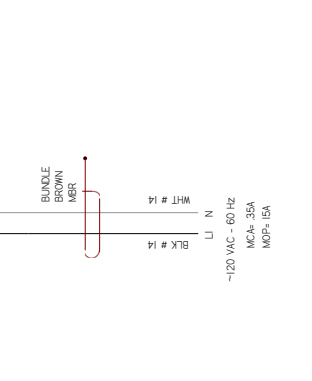
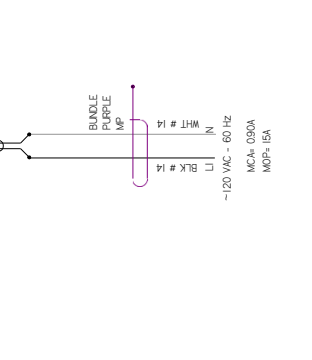
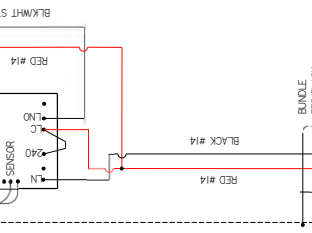
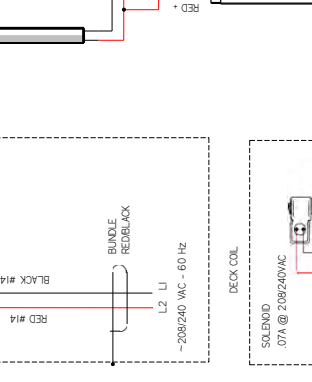
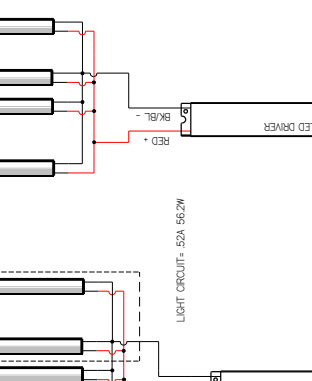
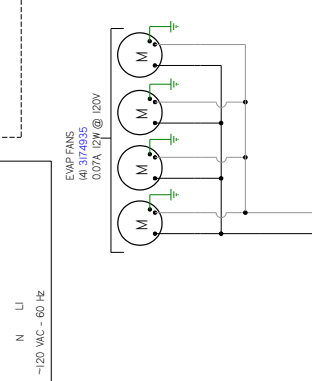
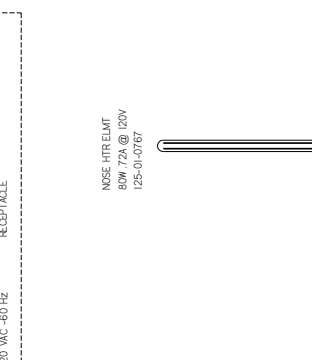
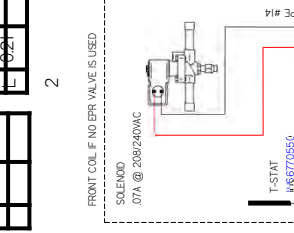
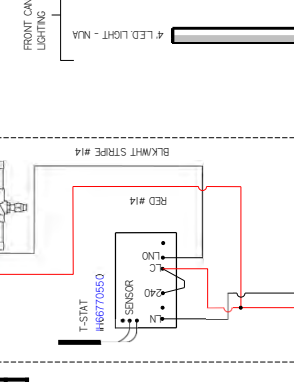
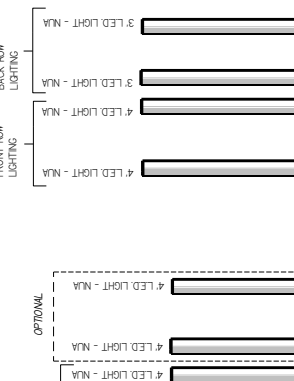
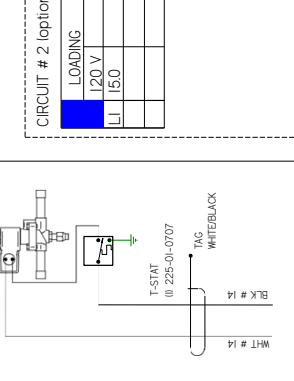
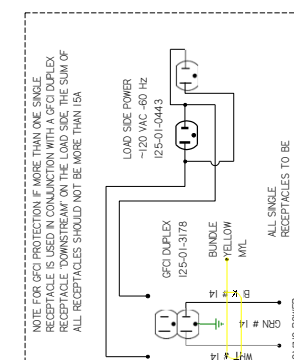

HUSSMANN
DIAGRAM-R3HV-
M/F-EP-8-R
W/208V

MATERIAL - N/A
 DATE DRAWN - 8-25-15
 DRAWN BY - CRAIG BOOREY
 REVIEWED BY - CRAIG BOOREY
 APPROVED BY - CRAIG BOOREY
 UNLESS OTHERWISE SPECIFIED DIMENSIONS ARE IN INCHES
 DECIMALS .XX +03 .XXX
 ANGLES ± 2°

CON# - 999270
 REF -
 SHEET 1 OF 1
 TO FINANCES ARTS
 THIRD
 ANCL
 E
 PROJECTION

NOTES:
 CASE MUST BE GROUNDED

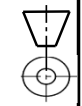

REVISION HISTORY			
REV	ECN	DATE	DESCRIPTION
A	1085239	2015/09/29	ADDED 3RD T-STAT
B	ECN4-CAP-0000000	2016/06/16	CHANGED T-STAT
C	ECN4-COD-0015253	2022/02/02	NEW LIGHTS
D	ECN4-COD-0018141	2024/04/16	CHANGED FANS AND LIGHTS

CIRCUIT #1 LOADING	
LI	120V
LI	150

CIRCUIT #2 LOADING	
LI	120V
LI	150

CIRCUIT #2 (optional) LOADING	
LI	120V
LI	150

NOTE FOR GFI PROTECTION IF MORE THAN ONE SINGLE RECEPTACLE IS USED IN CONJUNCTION WITH A GFI DUPLEX RECEPTACLE DOWNSTREAM ON THE LOAD SIDE THE SUM OF ALL RECEPTACLES SHOULD NOT BE MORE THAN 15A

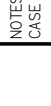
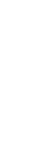
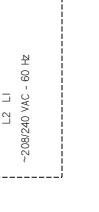
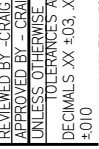
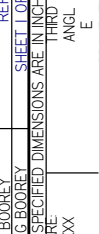
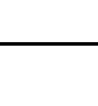
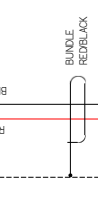
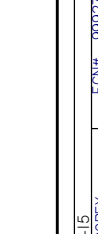
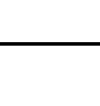
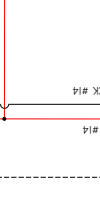
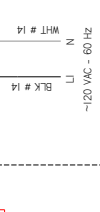
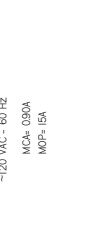
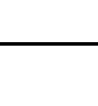
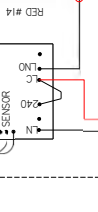
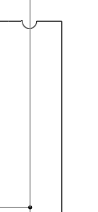
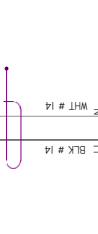
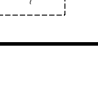
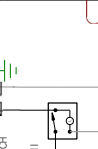
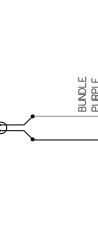
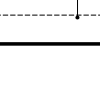
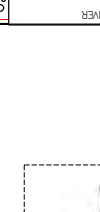
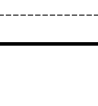
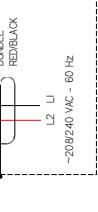
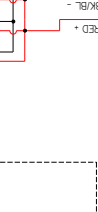
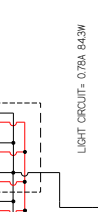
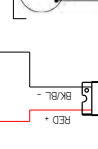
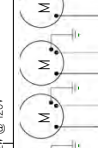
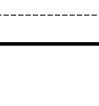
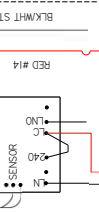
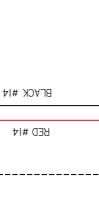
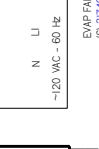
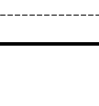
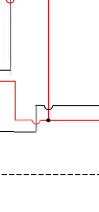
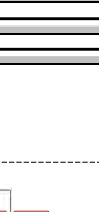
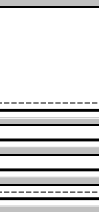
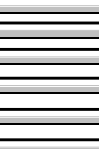
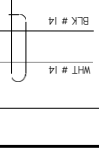
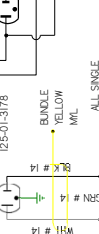
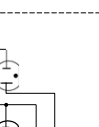
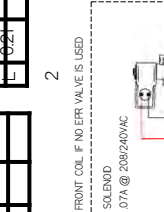
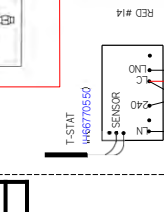
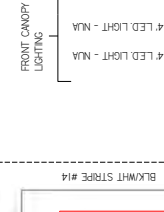
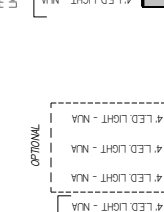
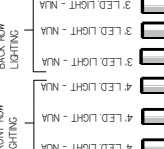
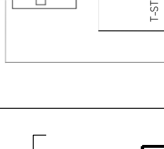
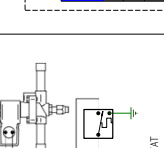
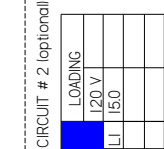
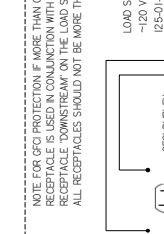
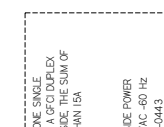
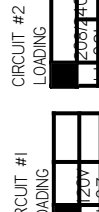

Troubleshooting

Problem	Possible Cause	Possible Solution
Product too cold and/ or freezing	Spiral Deck Coil (SDC) is too cold.	Probe the deck with the product in place. If the deck is less than 29°F increase the SDC thermostatic SP incrementally. Allow approximately 60 minutes or stable temperatures for system to react then recheck temperatures. Verify when SDC T-Stat is active that SDC is operating at desired Temperature/ Pressure (Evap Pressure).
	Gravity Coil (GC) set too cold	Increase thermostatic set point *(SP) of GC. Your setting will depend on store conditions and desired product temperature. The thermostatic SP is properly set when the product is ideally 33-38°F. Should ice be forming on the GC, verify Evaporator Pressure, GC Discharge Air (DA) is ranging between 33-36°F
	Excessive Icing	Ensure excessive icing condition's don't exist on SDC or that any exist on the GC
	Evaporator Suction Temperature	Ensure case evaporator / suction temperature is above 28°F.
	Superheat Set Too Low	Check superheat and adjust as necessary. See Case Specification
	T-Stat Sensor And TXV Bulbs Not Firmly Secured	<p>Ensure that all T-Stat sensor and TXV bulbs are firmly secured to the pipes in the locations shown in figure (C). The bulbs should be at the 3 or 9 o'clock position on the pipe. Take care to insure SDC T-Stat sensor is below the surface of the Spiral Deck Tube (at mid tube from outer/inner of spiral) to insure no interference with Deck Plate. Band strap should be thin gauge copper. GC T-Stat sensor tip should be located approximately 1" below the bottom fin surface, at approximately coil center (front-back) and between 18"-24" from the end of the case wall.</p> <p>Ensure that the case is piped per the piping diagram (C) [Note: some components may be optional].</p>
Product dehydrating prematurely	GC set too cold	Increase thermostatic SP of GC. Your setting will depend on store conditions and desired product temperature. The thermostatic SP is properly set when the DA from the GC is ranging between 33-37°F, depending upon Meat Department ambient conditions. Product should be turned and rotated about every 4 hours. Product should be covered at night with a clean, damp cloth such as cheese cloth if left in the display case overnight
Product too warm	Improper Case Piping	Verify case is properly piped per the Piping Diagram. Refer to Pipe Diagram
	Improper Suction Pressure Setting	Verify case suction pressure is set to a 28°F temperature equivalent when all Solenoid VLV are active/open
	Improper Superheat Setting	Verify superheat. Adjust TX valves accordingly. Deck/Spiral coil may be set as low as 1-2° SH. Gravity coil may be set as low as 3° SH. (NOTE, when adjusting TXV superheat, first adjust the corresponding T-Stat below equivalent suction temperature. This will ensure that the T-Stat does not close during the adjustment period. Be sure to return T-Stat to SP.

Troubleshooting Cont'd

Problem	Possible Cause	Possible Solution
Product too warm	Improper EPR Set Point	If SDC inlet temperature is above 28°F reduce the EPR set point
	Improper Thermostat Bulb Location	Ensure that the thermostat bulb for the gravity coil (A) is not contacting any coil parts and is located in the discharge air stream
	Improper TXV Bulb Location	Ensure that the TX valve bulbs are located as per the piping diagram. Refer to Pipe Diagram
	Improper Deck Plates (and Pans) Sitting	Ensure that the deck plates (and pans) are seated and making good contact with the SDC and each other
	Gravity Coil Air Flow Obstruction	Ensure that gravity coil is fully cleared all the time
	Defrost Failure To Clear All SDC Ice Buildup	The SDC will eventually pack with ice and refrigeration performance will be severely degraded. Confirm Evaporator Temperature is 28°F, SDC T-Stat SP to specification, and SDC termination temperature reaching at least 42°F. Increase the defrost time in 5 minute increments if this condition is observed, and termination temperature not achieved.
	Improperly sized refrigerant lines	Ensure that refrigerant lines are properly sized per the installation manual. Inspect liquid line for kinks, pinched or excessive u-bends
	Solid Column Of Liquid Refrigerant NOT reaching the TXV	Inspect liquid line for kinks, pinched or excessive u- bends.
	Liquid Refrigerant case inlet Temperature is excessive	Ensure that the liquid refrigerant entering temperature is not excessive. Liquid greater than 110°F at 6" ahead of the TXV may be an indication of equipment problems
	Product Introduction Temperature Too High	Correct product introduction temperature should be 34°F.-36°F.
	Product Is Stacked Too High	Reduce display height of product. Less than 6" is recommended
	Product is displayed in containers that impede the conduction cooling from the SDC	Use containers with full length, flat bottoms. Refer to MERCHANDIZING RECOMMENDATIONS (page 29) section for further information.
Incorrect replacement lighting is adding too much heat	Use only Hussmann genuine replacement parts or equivalent.	
Case temperature is too warm.	Ambient conditions may be affecting the case operation.	Check case position in store. Is the case located near an open door, window, electric fan or air conditioning vent that may cause air currents? Case must be located minimum 15 Ft away from doors or windows. Cases are designed to operate at or below 75°F Dry bulb and 55% relative humidity.
	Discharge air temp is out of spec.	Check suction pressure and insure that it meets factory specifications.
	Case is in defrost.	Check defrost settings. See Technical Specifications section.
	Product load may be over its limits blocking airflow.	Redistribute product so it does not exceed load level.

Troubleshooting Cont'd

Problem	Possible Cause	Possible Solution
Case temperature is too cold.	The t-stat temp is set too low.	Check settings. See Technical Specifications section.
	Ambient conditions may be affecting the case operation.	Check case position in store. Is the case located near an open door, window, electric fan or air conditioning vent that may cause air currents? Case must be located minimum 15 Ft away from doors or windows. Cases are designed to operate at or below 75°F Dry bulb and 55% relative humidity.
Condensation on glass.	Ambient conditions may be affecting the case operation.	Check case position in store. Is the case located near an open door, window, electric fan or air conditioning vent that may cause air currents? Case must be located minimum 15 Ft away from doors or windows. Cases are designed to operate at or below 75°F Dry bulb and 55% relative humidity.
	There are glass gaps on the side of the case.	See glass adjustment section.
	Glass is not completely shut.	Close glass correctly.
	Ambient Conditions	Turn on Air Sweep Fans located at the right rear of merchandiser.
Water has pooled under case.	Case drain is clogged.	Clear drain.
	PVC drains under case may have a leak.	Repair as needed.
	Case tub has unsealed opening.	Seal as needed.
	If the case is in a line-up, case to case joint is missing or unsealed.	Install case to case joint and seal as needed.
	Evaporator pan is overflowing (if applicable).	Check electrical connection to evaporator pan. Check float assembly, it should move freely up and down the support stem. Clear any debris.
Case is not draining properly.	Case is not level.	Level the case.
	Drain screen is plugged.	Clean drain screen and remove any debris.
	Drain or P-trap is clogged.	Clear any debris.
Frost or ice on evaporator coil.	Defrost clock is not functioning.	Case should be serviced by a qualified service technician.
Lights do not come on.	LED Driver /light wiring.	Check electrical connections. See Electrical Section and check wiring diagram.
	LED Driver needs to be replaced.	Case should be serviced by a qualified service technician. See Electrical Section.
	LED Light needs to be replaced.	Case should be serviced by a qualified service technician.
	Light Switch needs to be replaced.	Case should be serviced by a qualified service technician.

Appendices

Appendix A. - Temperature Guidelines

The refrigerators should be operated according to the manufacturer's published engineering specifications for entering air temperatures for specific equipment applications. Table 1 shows the typical temperature of the air entering the food zone one hour before the start of defrost and one hour after defrost for various categories of refrigerators. Refer to Appendix C for Field Evaluation Guidelines.

Type of Refrigerator	Typical Entering Air Temperature
I. OPEN DISPLAY	
A. Non frozen:	
1) Meat	28°F
2) Dairy/Deli	32°F
3) Produce	
a. Processed	36°F
b. Unprocessed	45°F
B. Frozen	0°F
C. Ice Cream	-5°F
II. CLOSED DISPLAY	
A. Non frozen:	
1) Meat	34°F
2) Dairy/Deli	34°F
3) Produce	
a. Processed	36°F
b. Unprocessed	45°F
B. Frozen	0°F
C. Ice Cream	-5°F

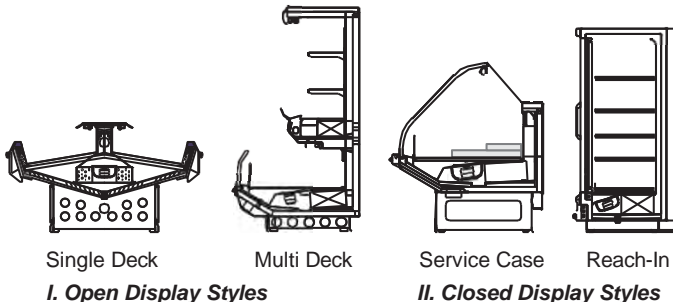

Appendix B. - Application Recommendations

- Temperature performance is critical for controlling bacteria growth. Therefore, the following recommendations are included in the standard. They are based on confirmed field experience over many years.
- The installer is responsible for following the installation instructions and recommendations provided by Hussmann for the installation of each individual type refrigerator.
- Refrigeration piping should be sized according to the equipment manufacturer's recommendations and installed in accordance with normal refrigeration practices. Refrigeration piping should be insulated according to Hussmann's recommendations.

- A clogged waste outlet blocks refrigeration. The installer is responsible for the proper installation of the system which dispenses condensate waste through an air gap into the building indirect waste system.
- The installer should perform a complete start-up evaluation prior to the loading of food into the refrigerator, which includes such items as:
 - Initial temperature performance, Coils should be properly fed with a refrigerant according to manufacturer's recommendations.
 - Observation of outside influences such as drafts, radiant heating from the ceiling and from lamps. Such influence should be properly corrected or compensated for.
 - At the same time, checks should be made of the store dry-bulb and wet-bulb temperatures to ascertain that they are within the limits prescribed by Hussmann.
 - Complete start-up procedures should include checking through a defrost to make certain of its adequate frequency and length without substantially exceeding the actual needs. This should include checking the electrical or refrigerant circuits to make sure that defrosts are correctly programmed for all the refrigerators connected to each refrigeration system.
 - Recording instruments should be used to check performance.

Appendix C. - Field Recommendations

Recommendations for field evaluating the performance of retail food refrigerators and hot cases

- The most consistent indicator of display refrigerator performance is temperature of the air entering the product zone (see Appendix A). In practical use, the precise determination of return air temperature is extremely difficult. Readings of return air temperatures will be variable and results will be inconsistent. The product temperature alone is not an indicator of refrigerator performance.

NOTE: Public Health will use the temperature of the product in determining if the refrigerator will be allowed to display potentially hazardous food. For the purpose of this evaluation, product temperature above the FDA Food Code 1993 temperature for potentially hazardous food will be the first indication that an evaluation should be performed. It is expected that all refrigerators will keep food at the FDA Food Code 1993 temperature for potentially hazardous food.

Appendices (Cont'd)

1. The following recommendations are made for the purpose of arriving at easily taken and understood data which, coupled with other observations, may be used to determine whether a display refrigerator is working as intended:
 - a) INSTRUMENT - A stainless steel stem-type thermometer is recommended and it should have a dial a minimum of 1 inch internal diameter. A test thermometer scaled only in Celsius or dually scaled in Celsius and Fahrenheit shall be accurate to 1°C (1.8°F). Temperature measuring devices that are scaled only in Fahrenheit shall be accurate to 2°F. The thermometer should be checked for proper calibration. (It should read 32°F when the stem is immersed in an ice water bath).
 - b) LOCATION - The probe or sensing element of the thermometer should be located in the airstream where the air first enters the display or storage area, and not more than 1 inch away from the surface and in the center of the discharge opening.
 - c) READING - It should first be determined that the refrigerator is refrigerating and has operated at least one hour since the end of the last defrost period. The thermometer reading should be made only after it has been allowed to stabilize, i.e., maintain a constant reading.
 - d) OTHER OBSERVATIONS - Other observations should be made which may indicate operating problems, such as unsatisfactory product, feel/appearance.
 - e) CONCLUSIONS - In the absence of any apparent undesirable conditions, the refrigerator should be judged to be operating properly. If it is determined that such condition is undesirable, i.e., the product is above proper temperature, checks should be made for the following:
 1. Has the refrigerator been loaded with warm product?
 2. Is the product loaded beyond the "Safe Load Line" markers?
 3. Are the return air ducts blocked?
 4. Are the entering air ducts blocked?
 5. Is a dumped display causing turbulent air flow and mixing with room air?
 6. Are spotlights or other high intensity lighting directed onto the product?
7. Are there unusual draft conditions (from heating/air-conditioning ducts, open doors, etc.)?
8. Is there exposure to direct sunlight?
9. Are display signs blocking or diverting airflow?
10. Are the coils of the refrigerator iced up?
11. Is the store ambient over 75°F, 55% RH as set forth in ASHRAE Standard 72 and ASHRAE Standard 117?
12. Are the shelf positions, number, and size other than recommended by Hussmann?
13. Is there an improper application or control system?
14. Is the evaporator fan motor/blade inoperative?
15. Is the defrost time excessive?
16. Is the defrost termination, thermostat (if used) set too high?
17. Are the refrigerant controls incorrectly adjusted?
18. Is the air entering the condenser above design conditions? Are the condenser fins clear of dirt, dust, etc.?
19. Is there a shortage of refrigerant?
20. Has the equipment been modified to use replacements for CFC-12, CFC-502 or other refrigerant? If so, have the modifications been made in accordance with the recommendations of the equipment manufacturer? Is the refrigerator charged with the proper refrigerant and lubricant? Does the system use the recommended compressor?

Appendix D. - Recommendations to User

- 1.0 Hussmann Corporation provides instructions and recommendations for proper periodic cleaning. The user will be responsible for such cleaning, including the cleaning of low temperature equipment within the compartment and the cooling coil area(s). Cleaning practices, particularly with respect to proper refrigerator unloading and warm-up, must be in accordance with applicable recommendations.

Appendices (Cont'd)

- 1.1 Cleaning of non frozen food equipment should include a weekly cleaning of the food compartment as a minimum to prevent bacteria growth from accumulating. Actual use and products may dictate more frequent cleaning. Circumstances of use and equipment design must also dictate the frequency of cleaning the display areas. Weekly washing down of the storage compartment is also recommended, especially for equipment subject to drippage of milk or other liquids, or the collection of vegetable, meat, crumbs, etc. or other debris or litter. Daily cleaning of the external areas surrounding the storage or display compartments with detergent and water will keep the equipment presentable and prevent grime buildup.
2. Load levels as defined by the manufacturer must be observed.
3. The best preservation is achieved by following these rules:
 - a) Buy quality products.
 - b) Receive perishables from transit equipment at the ideal temperature for the particular product.
 - c) Expedite perishables to the store's storage equipment to avoid unnecessary warm-up and prolonged temperature recovery. Food store refrigerators are not food chillers nor can they reclaim quality lost through previous mishandling.
 - d) Care must be taken when cross merchandising products to ensure that potentially hazardous vegetable products are not placed in non refrigerated areas.
 - e) Display and storage equipment doors should be kept closed during periods of inactivity.
 - f) Minimize the transfer time of perishables from storage to display.
 - g) Keep meat under refrigeration in meat cutting and processing area except for the few moments it is being handled in processing. When a cut or tray of meat is not to be worked on immediately, the procedure should call for returning it to refrigeration.
 - h) Keep tools clean and sanitized. Since mechanical equipment is used for fresh meat processing, all such equipment should be cleaned at least daily and each time a different kind of meat product comes in contact with the tool or equipment.
 - i) Make sure that all refrigeration equipment is installed and adjusted in strict accordance with the manufacturer's recommendations.
 - j) See that all storage and refrigeration equipment is kept in proper working order by routine maintenance.



Service Record

Last service date: **By:**

_____	_____
_____	_____
_____	_____
_____	_____
_____	_____
_____	_____
_____	_____

HUSSmann®/Chino
Additional copies of this publication may be obtained by contacting:
Hussmann® Chino
13770 Ramona Avenue • Chino, California 91710
(909) 628-8942 FAX
(909) 590-4910
(800) 395-9229

The <i>MODEL NAME</i> and <i>SERIAL NUMBER</i> is required in order to provide you with the correct parts and information for your particular unit. They can be found on a small metal plate on the unit. Please note them below for future reference.
MODEL:
SERIAL NUMBER:



HUSSMANN[®]

**To obtain warranty information
or other support, contact your
Husmann representative.
Please include the model and
serial number of the product.**

Husmann Warranty / Technical Assistance
(800) 592-2060