

HUSSMANN®/CHINO

Q1-DC/DS

DELI SERVICE CASE

Installation
& Operation
Manual

REV. 1123

HUSSMANN®

**Q1-DC/DS
Deli Service Case**



INSTALLATION & OPERATION GUIDE

1. General Instructions

HUSSMANN®/CHINO

A publication of HUSSMANN® Chino
13770 Ramona Avenue • Chino, California 91710
(909) 628-8942 FAX
(909) 590-4910
(800) 395-9229

www.hussmann.com

This Booklet Contains Information on:

Q1-DC/DS refrigerated, service deli merchandiser.

Shipping Damage

All equipment should be thoroughly examined for shipping damage before and during unloading.

This equipment has been carefully inspected at our factory and the carrier has assumed responsibility for safe arrival. If damaged, either apparent or concealed, claim must be made to the carrier.

Apparent Loss or Damage

If there is an obvious loss or damage, it must be noted on the freight bill or express receipt and signed by the carrier's agent; otherwise, carrier may refuse claim. The carrier will supply necessary claim forms.

Concealed Loss or Damage

When loss or damage is not apparent until after equipment is uncrated, a claim for concealed damage is made. Make request in writing to carrier for inspection within 15 days, and retain all packaging. The carrier will supply inspection report and required claim forms.

Shortages

Check your shipment for any possible shortages of material. If a shortage should exist and is found to be the responsibility of Hussmann Chino, notify Hussmann Chino. If such a shortage involves the carrier, notify the carrier immediately, and request an inspection. Hussmann Chino will acknowledge shortages within ten days from receipt of equipment.

Hussmann Chino Product Control

The serial number and shipping date of all equipment has been recorded in Hussmann's files for warranty and replacement part purposes. All correspondence pertaining to warranty or parts ordering must include the serial number of each piece of equipment involved, in order to provide the customer with the correct parts.

Keep this booklet with the case at all times for future reference.

Table of Contents

1. General Instructions.....	2
2. Table of Contents	3
3. Cut and Plan Views	4
4. Installation.....	5
5. Plumbing	13
6. Refrigeration	13
7. Specification Sheet	15
8. Electrical.....	16
9. Finishing Touches	17
10. User Information.....	17
11. Maintenance	20
12. Wiring Diagram Index	22
13. Wiring Diagrams	23
14. Troubleshooting Guide	35
15. Appendices	37

3. Cut and Plan Views

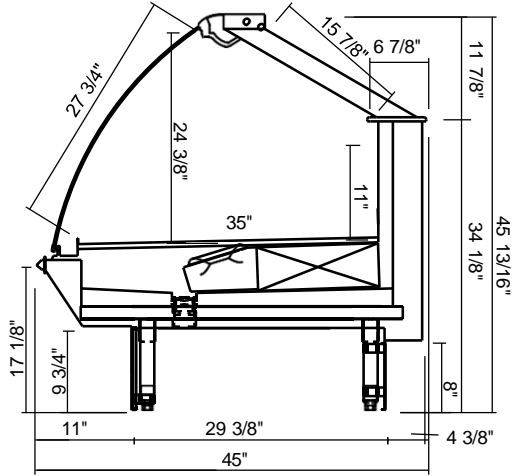

Q1-DC
Single Deck Deli - Curved Glass

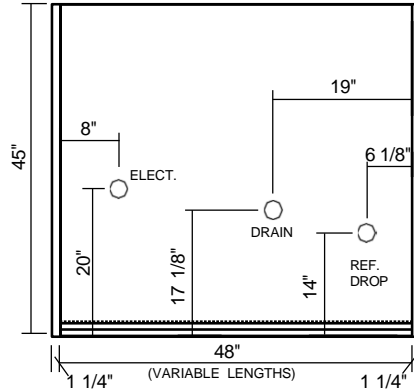

Q1-DC / Q1-DS / Q1-SS
Plan View - Straight Section

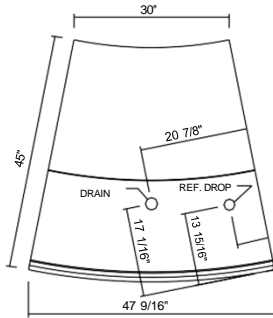

22.5° O/S

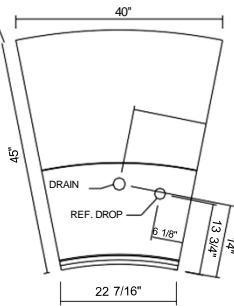

22.5° I/S

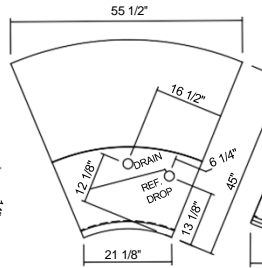

45° I/S

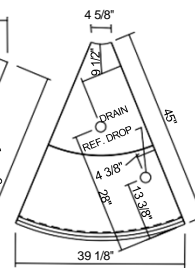

45° O/S

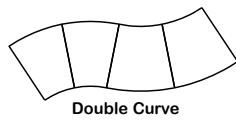

Double Curve

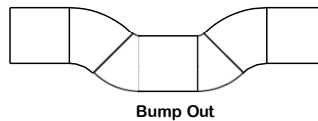

Bump Out

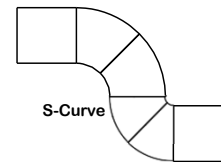

S-Curve

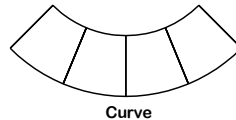

Curve

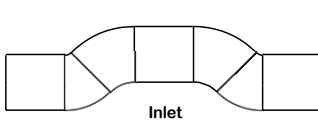

Inlet

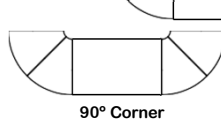

90° Corner

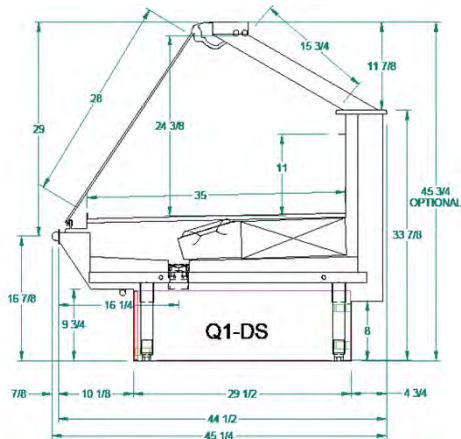

Q1-DS

4. Installation

Location

The refrigerated merchandisers have been designed for use only in air conditioned stores where temperature and humidity are maintained at or below 75°F and 55% relative humidity. DO NOT allow air conditioning, electric fans, ovens, open doors or windows (etc.) to create air currents around the merchandiser, as this will impair its correct operation.

Product temperature should always be maintained at a constant and proper temperature. This means that from the time the product is received, through storage, preparation and display, the temperature of the product must be controlled to maximize life of the product.

Uncrating the Stand

Place the fixture as close to its permanent position as possible. Keep in place, attached case until ready to set/bolt to adjoining case.

Tighten Glass Screws

Tighten screws along clamshell located on the underside of glass before placing unit into operation.

Exterior Loading

These models have **not** been structurally designed to support excessive external loading. **Do not walk on their tops;** This could cause serious personal injury and damage to the fixture.

Setting and Joining

The sectional construction of these models enable them to be joined in line to give the effect of one continuous display.

An Alignment pin kit is supplied with every case and must be used in alignment.

Leveling

IMPORTANT! IT IS IMPERATIVE THAT CASES BE LEVELED FROM FRONT TO BACK AND SIDE TO SIDE PRIOR TO JOINING. A LEVEL CASE IS NECESSARY TO INSURE PROPER OPERATION, WATER DRAINAGE, GLASS ALIGNMENT, AND OPERATION OF THE HINGES SUPPORTING THE GLASS. LEVELING THE CASE CORRECTLY WILL SOLVE ALL HINGE OPERATION AND GLASS PROBLEMS.

NOTE: A. To avoid removing concrete flooring, begin lineup leveling from the highest point of the store floor.

B. When wedges are involved in a lineup, set them first.

All cases were leveled and joined prior to shipment to insure the closest possible fit when cases are joined in the field. When joining, use a carpenter's level and adjust legs accordingly. The legs on the Q1-DC/DS are adjustable and do not require shims. Simply screw the leg up or down to adjust height.

1. Using case blueprints, measure off and mark on the floor the exact dimensions of where the cases will sit. Snap chalk line for front and back positions of base rail or pedestal. Mark the location of each joint front and back. Find the highest point throughout the lineup. **FLOORS ARE NORMALLY NOT LEVEL!** Determine the highest point of the floor; cases will be set off this point. All cases in the entire lineup must be brought up to the highest level of the case sitting at the highest point in the lineup. This may be done a few different ways.
 - a) Walk the floor looking for any mounds or dips.
 - b) Use a string level.
 - c) Use a transit.

If a wedge is used in the middle of a lineup, the wedge must be set on the highest point on the floor **FIRST**, with the rest of the lineup being leveled from it. The Q1-DC/DS case has adjustable legs to allow for leveling.

2. Set first case over the highest part of the floor and adjust legs so that case is level. Remove side and back leg braces after case is set and joined.
3. Set second case within one foot (1') of the first case, and remove leg skids. Keep the supports along the length of the case and far end of case. Level case to the first using the instructions in step one.
4. Apply masking tape 1/8" in from end of case on inside and outside rear mullion and body work on both cases to be joined.

Installation (Cont'd)

5. Apply liberal bead of case joint sealant (butyl) to first case. Sealant area is shown using a dotted line in illustration in Step 8. Apply heavy amount to cover entire shaded area.

DO NOT USE PERMAGUM!



6. Slide second case up to first case snugly. Then level second case to the first case so glass front, bumper and top are flush.



CAUTION

Do not use bolts to pull cases together.

7. To compress butyl at joint, use two Jurgenson wood clamps. Make sure case is level from front to back and side to side on inside bulkheads at joint.

8. Attach sections together via the bolts pictured in the illustration below.

9. Apply bead of butyl to top of bulkheads and slip on stainless steel bulkhead cap. Also apply silicone to seam between overhead light

10. Use finger to smooth silicone as thin as possible at masking tape on inside and outside of rear mullion (apply additional silicone if necessary). Remove tape applied on line #4.

11. Remove front, back and end shipping braces.

Q1-DC/DS Refrigerated Wedges and Standard Cases

Line-up taper pins and line-up plates with holes on adjoining case. Bolting is located at the rear of the case, behind the air discharge wall, and behind the front body panel. The cases are bolted together in front by means of a bracket located behind the front panel. Remove the front panel by unscrewing these bottom screws.

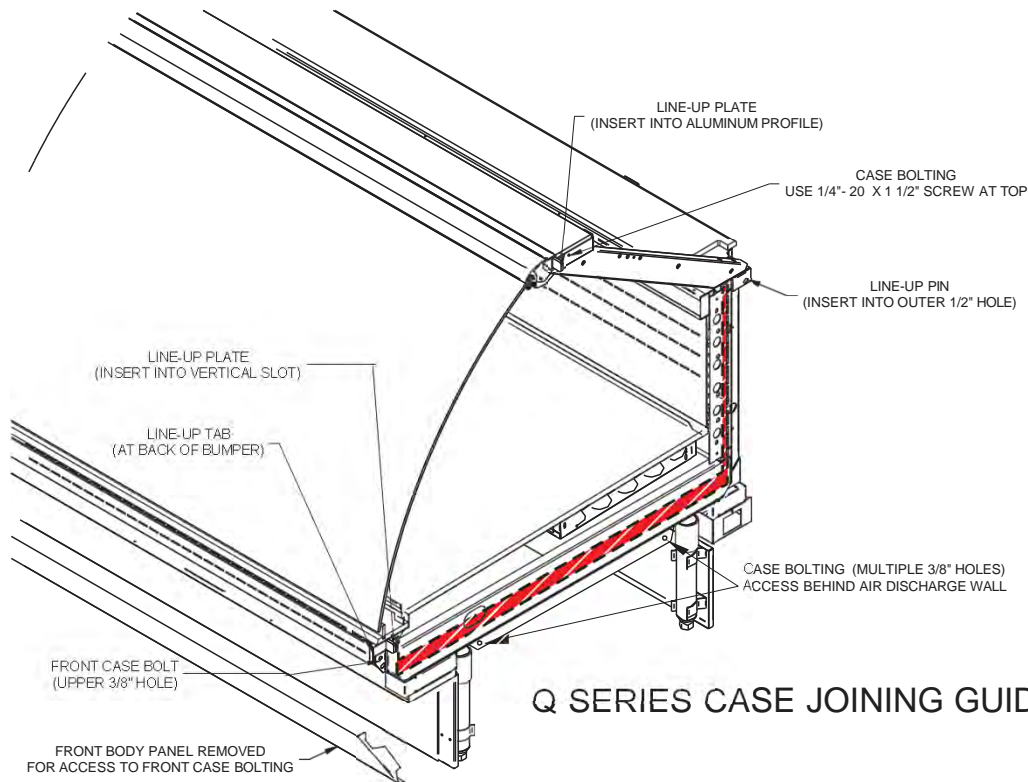

Q SERIES CASE JOINING GUIDE

Installation (Cont'd)

Line Up Tab



Line Up Plate



To adjust the front glass please follow these steps
Before you start any adjustments make sure the cases are level, Front to Back and side to side



Q-1 Glass Adjustment

Proper adjustment of the side-to-side position on the glass clamp on Vieler Streamline hardware such as used on Hussmann Q series service cases is critical to proper operation of the glass hardware. Failure to properly adjust the glass clamp can result in failure of the hardware and possible injury to personnel.

When setting or repairing cases, the glass clamp is frequently adjusted from side to side once the cases are set in order to control glass gaps or compensate for poorly installed case line ups. Due to the unique design of this type of hardware, using practices common to other types of hardware can result in the above failures.

Step 1: Level Case



The canopy hardware and glass gaps are set at the factory for proper fit with the Cases Square and level. Before attempting to do any adjustment of the canopy hardware, ensure that the cases are set square and level. Additionally, the adjoining cases must be pulled together tightly.



Step # 2

To level the cases remove the front and rear close-offs, You can adjust the Height by turning the base leg adjusters



When you turn the leg adjuster clock-wise the case will go up.

When you turn the leg adjuster counter clock-wise the case will go down.

Installation (Cont'd)

IMPORTANT: Attempting to compensate for poor installation practices by manipulating the canopy hardware will result in unsatisfactory workmanship and possibly cause hardware failure and/or injury.

Step 3: Adjust Glass Height

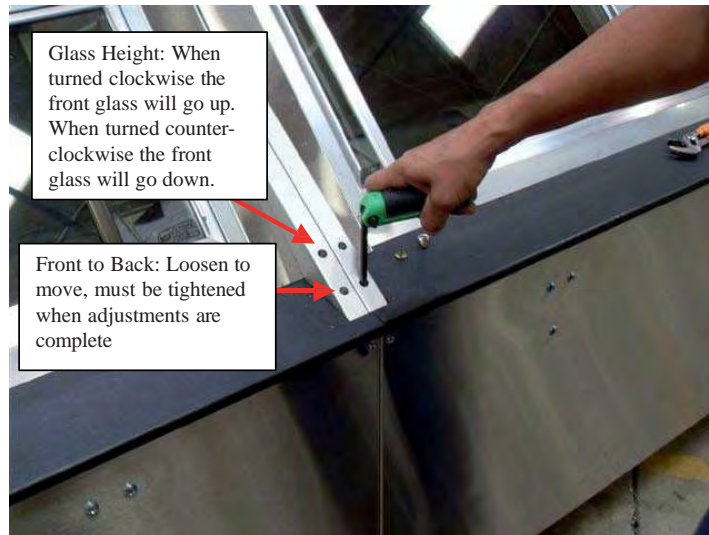

To properly adjust the height of the glass requires that both hinge arms of each section of glass be loosened before attempting to change the glass position.

Glass must be parallel to ledge when viewed from front



IMPORTANT: Attempting to compensate for poor installation practices by manipulating the canopy hardware will result in unsatisfactory workmanship and possibly cause hardware failure and/or injury.

Installation (Cont'd)

Step 4: Glass Side to Side Adjustment

The glass gaps can be slightly optimized by moving the glass and glass clamp assembly side to side. This should be done as the final adjustment only after the glass/canopy height of the cases are set and leveled to each other. The canopy hardware on adjoining Q Series cases should be screwed together with the 1/4"-20 THD screws included with the cases. There are threaded holes provided in the stationary portion of the top hardware for this purpose.



To properly adjust the glass gaps requires that both hinge arms of each section of glass be loosened before attempting to change the glass position.

To shift the glass side to side or front to back at the glass clamp

#1 Open the glass and loosen the Torx T-15 screw

2 Loosen the #10 MM bolt on both sides of the glass as needed

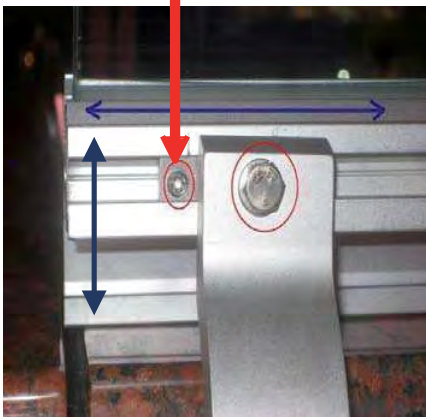

Figure 16



Figure 17

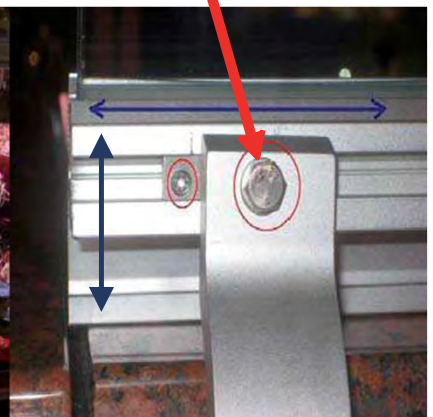
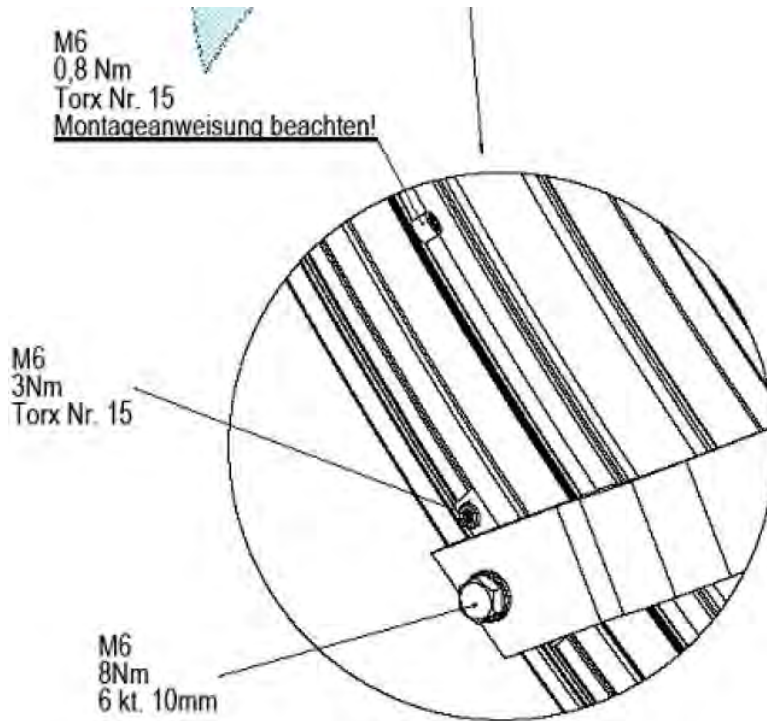

Figure 18

Installation (Cont'd)

Torque Specs:



IMPORTANT: Attempting to change the glass position by loosening only one side or by forcing the clamp sideways will result in damaging the hardware and its eventual failure. Loosening the hinge arms requires loosening the attachment screws and setscrews on both hinge arms on the section of glass.

IMPORTANT: It is critical to use the proper size Torx or Hex wrench for the fasteners to avoid stripping the fasteners.

Installation (Cont'd)

Loosen the fasteners only as needed to allow the glass clamp to slip to the desired position.

Reposition the glass and glass clamp assembly as needed and verify its position by carefully closing the glass to check clearances.

Once the glass is in the desired position, retighten the fasteners at the hinge arms with the proper wrench.

Recheck the glass position and double check that the fasteners are properly torqued.

IMPORTANT: It is critical that the hinge arm washers or bushings that fasten the hinge arms to the stationary portion of the upper glass hardware do not have any side pressure on them. Even the slightest side pressure will result in the failure of the hardware. If the retaining clips or hinge arm washers or bushings at each hinge arm have any side pressure it is necessary to repeat the adjustment procedure.

When properly adjusted, the hinge arm washers or bushings will have a slight side-to-side free play.

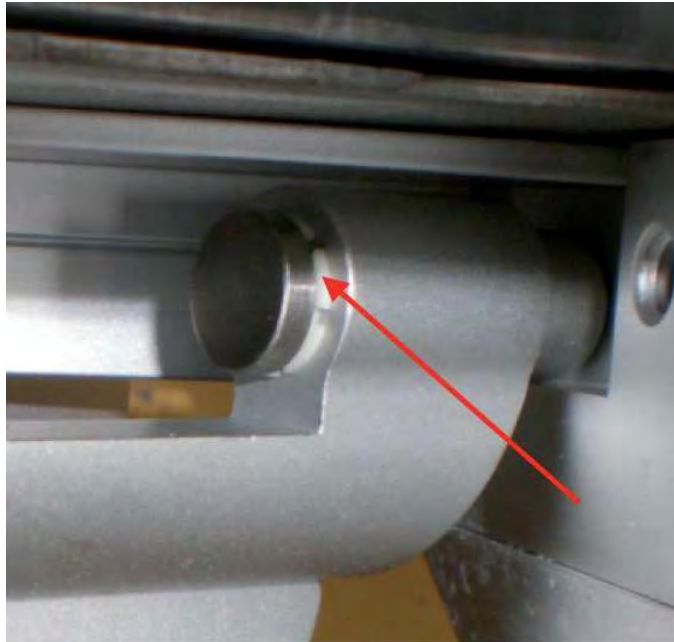

Installation (Cont'd)

Bumper Installation Instructions



Step 1: Make sure the aluminum channel and end caps are installed.



Step 2: Use silicone lubricant to help the bumper slide into the channel.



Step 3: Starting on one end: while inserting the bumper, push it up against the end cap to prevent the bumper from shrinking after installation (when it gets cold).



Step 4: As you insert the bumper into the channel with one hand, pull the bumper toward you with the other to open the inside lips. Slowly apply pressure by rolling the bumper into the track.

5. Plumbing

Waste Outlet and P-TRAP

The waste outlet is located off the center of the case on one side allowing drip piping to be run lengthwise under the fixture.

P-traps must be installed at the base of all refrigerated cases. The 1 ½" P-TRAP and threaded adapter must be installed to prevent air leakage and insect entrance into the fixture.

Installing Condensate Drain

Poorly or improperly installed condensate drains can seriously interfere with the operation of this refrigerator, and result in costly maintenance and product losses. Please follow the recommendations listed below when installing condensate drains to insure a proper installation:

1. Never use pipe for condensate drains smaller than the nominal diameter of the pipe or P-TRAP supplied with the case.
2. When connecting condensate drains, the P-TRAP must be used as part of the condensate drain to prevent air leakage or insect entrance. Store plumbing system floor drains should be at least 14" off the center of the case to allow use of the P-TRAP

pipe section. Never use two water seals in series in any one line. Double P-TRAPS in series will cause a lock and prevent draining.

3. Always provide as much down hill slope ("fall") as possible; 1/8" per foot is the preferred minimum. PVC pipe, when used, must be supported to maintain the 1/8" pitch and to prevent warping.
4. Avoid long runs of condensate drains. Long runs make it impossible to provide the "fall" necessary for good drainage.
5. Provide a suitable air break between the flood rim of the floor drain and outlet of condensate drain. 1" is ideal.
6. Prevent condensate drains from freezing:
 - a. Do not install condensate drains in contact with non-insulated suction lines. Suction lines should be insulated with a nonabsorbent insulation material such as Armstrong's Armaflex.
 - b. Where condensate drains are located in dead air spaces (between refrigerators or between a refrigerator and a wall), provide means to prevent freezing. The water seal should be insulated to prevent condensation.

6. Refrigeration

Refrigerant Type

The standard refrigerant will be R-404A unless otherwise specified on the customer order. Check the serial plate on the case for information.

Piping

The refrigerant line outlets are located under the case. Locate first the electrical box, the outlets are then on the same side of the case, but at the opposite end. Insulate suction lines to prevent condensation drippage.

Refrigeration Lines

<u>Liquid</u>	<u>Suction</u>
3/8" O.D.	5/8" O.D.

NOTE: The standard coil is piped at ½" (suction); however, the store tie-in may vary depending on the number of coils and the draw the case has. Depending on the case setup, the connecting point in the store may be 5/8", 7/8", or 1 1/8". Refer to the particular case you are hooking up.

Refrigerant lines should be sized as shown on the refrigeration legend furnished by the store.

Oil traps must be installed at the base of all suction line vertical risers on refrigerated cases.

Pressure drop can rob the system of capacity. To keep the pressure drop to a minimum, keep refrigerant line run as short as possible, using the minimum number of elbows. Where elbows are required, use long radius elbows only.

Control Settings

Maintain these parameters to achieve near constant product temperatures. Product temperature should first be measured in the morning, after having been refrigerated overnight. For all multiplexing, defrost should be time terminated. The number of defrosts per day should never change. The duration of the defrost cycle may be adjusted to meet conditions present at your location.

Access to TEV Valves and Drain Lines

MECHANICAL - Remove product from case. Remove pans. TX valve (mechanical only) and drain are located under the pans within the case.

ELECTRONIC - The electronic expansion valve master and slave cylinder(s) are located within the electrical access panel(s) in the rear of case. Rear panels lift up and out.

NOTE: Duplex receptacles must be detached before removing rear panels.

Refrigeration (Cont'd)

Electronic Expansion Valve (Optional)

A wide variety of electronic expansion valves and case controllers can be utilized. Please refer to EEV and controller Hussmann's information sheet. Sensors for electronic expansion valves will be installed on the coil inlet, coil outlet, and in the discharge air. (Some supermarkets require a 4th sensor in the return air). Case controllers will be located in the electrical raceway or under the case.

Expansion Valve Adjustment

Expansion valves must be adjusted to fully feed the evaporator. Before attempting any adjustments, make sure the evaporator is either clear or very lightly covered with frost, and that the fixture is within 10°F of its expected operating temperature.



**ATTENTION
INSTALLER**

After case has been brought to running temperature
verify screws along glass clamp aluminum
extrusion are tight.

Measuring the Operating Superheat

1. Determine the suction pressure with an accurate pressure gauge at the evaporator outlet.
2. From a refrigerant pressure temperature chart, determine the saturation temperature at the observed suction pressure.
3. Measure the temperature of the suction gas at the thermostatic remote bulb location.
4. Subtract the saturation temperature obtained in step No. 2 from the temperature measured in step No. 3.
5. The difference is superheat.
6. Set the superheat for 5°F - 7°F.

Thermostat Location

Thermostats are located in the electrical section; behind the rear panel, on the right-hand side of the case (facing the back of the case).

WARNING!

Do NOT apply thread sealer to ABS P-Trap.



7. Specification Sheet



SERVICE DELI
HUSSMANN - Q1-D (CHINO)

REVISION DATE 01/31/17

DOE 2017 Energy Efficiency Compliant
Hussmann refrigerated merchandisers configured for sale for use in the United States meet or surpass the requirements of the DOE 2017 energy efficiency standards.

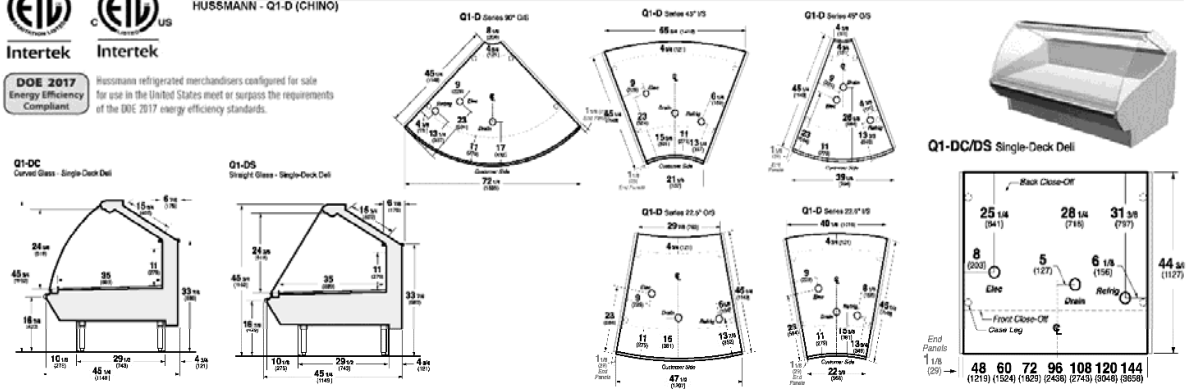

REFRIGERATION DATA:

CASE LENGTHS/ WEDGES	CASE USAGE	CAPACITY *** (BTU/HR/FT) (TOTAL FOR)		TEMPERATURE (°F)			VELOCITY (FT/MIN)
		RATING CONDITION		EVAPORATOR		DISCHARGE AIR	
		NSF 7	AHRI 1200	NSF 7	AHRI 1200	** (°F)	
4' 5' 6' 8' 10' 12'	DELI	430	430	20	20	26-28	150-180
22.5° IS *	DELI	1200	1200	20	20	26-28	150-180
22.5° OS *	DELI	1000	1000	20	20	26-28	150-180
45° IS *	DELI	1200	1200	20	20	26-28	150-180
45° OS *	DELI	1000	1000	20	20	26-28	150-180
90° OS *	DELI	3675	3675	20	20	26-28	150-180

* ADJACENT STRAIGHT CASE(S) REQUIRED
**FRONT DISCHARGE AIR MEASURED INSIDE AIR CURTAIN HONEYCOMB

***REFRIGERATION NOTES:

- 1) BTU'S INCLUDE CANOPY LIGHTS.
- 2) AHRI 1200 RATING POINT FOR ENERGY CONSUMPTION COMPARISON ONLY
- 3) USE DEW POINT FOR HIGH GLIDE REFRIGERANTS. CARE SHOULD BE TAKEN TO USE THE DEW POINT IN P/T TABLES FOR MEASURING AND ADJUSTING SUPERHEAT. ADJUST EVAPORATOR PRESSURE AS NEEDED TO MAINTAIN THE DISCHARGE AIR TEMPERATURE SHOWN.
- 4) RATING CONDITION IS NSF TYPE I, 75°F/55% RH

CASE LENGTHS	EST. REFRG. CHR.G. 404A (LBS)	GLYCOL (20°F INLET, 6° RISE)	
		GPM	PSI
4'	0.5	0.6	1.5
5'	0.7	0.8	2.4
6'	0.7	0.9	3.5
8'	1.0	1.2	1.6
10'	1.4	1.5	2.8
12'	1.5	1.8	3.3
22.5° IS	0.3	0.4	0.5
22.5° OS	0.3	0.3	0.4
45° IS	0.3	0.4	0.5
45° OS	0.2	0.3	0.2
90° OS	0.3	1.1	2.4

REFRIGERATION DATA CONTINUED:

ELEC. THERMOSTAT / AIR SENSOR SETTINGS		DEFROST TYPE	TIME (MIN)	DEFROST FREQUENCY (#/DAY)	TERM. TEMP (°F) COIL ONLY	DRIP TIME	DEFROST WATER (LBS/DAY/FT)
USAGE	CUT IN (°F)						
DELI	29	26	OFF TIME	40	45	N/A	3.3

END PANEL WIDTH KEY		
# OF ENDS	END PNL WIDTH (IN.)	TOTAL ADDED LENGTH (IN.)
1	1.125	1.125
2	1.125	2.25

ELECTRICAL DATA:

STANDARD FANS, HEATERS, LED LIGHTS (115 VOLT)

CASE LENGTH	EVAPORATOR FANS				AIRSWEEP FANS				CANOPY LIGHTS LED		OPTIONAL LED SHELF LIGHTS		MAX. LED LOAD (W/ ALL OPTIONS)		CONVENIENCE OUTLETS (OPTIONAL)			
	# OF EVAP FANS	BLADE DIA. (IN.)	BLADE PITCH (°)	AMPS	WATTS	# OF AIRSWEEP FANS	AMPS	WATTS	AMPS	WATTS	AMPS	WATTS	AMPS	WATTS	AMPS	WATTS	# OUTLETS	VOLTS
4'	1	6.7	20	0.1	8	1	0.1	9	0.1	15	N/A	N/A	0.1	15	1	115	15	
5'	1	6.7	25	0.1	8	1	0.1	9	0.2	21	N/A	N/A	0.2	21	1	115	15	
6'	2	6.7	15	0.2	16	2	0.2	18	0.2	26	N/A	N/A	0.2	26	1	115	15	
8'	2	6.7	20	0.2	16	2	0.2	18	0.3	31	N/A	N/A	0.3	31	1	115	15	
10'	2	6.7	25	0.2	16	3	0.2	26	0.4	41	N/A	N/A	0.4	41	1	115	15	
12'	4	6.7	20	0.5	32	3	0.2	26	0.4	46	N/A	N/A	0.4	46	2	115	30	
22.5° IS	1	6.7	10	0.1	8	1	0.1	9	0.1	10	N/A	N/A	0.1	10	N/A	N/A	N/A	
22.5° OS	1	6.7	15	0.1	8	1	0.1	9	0.1	10	N/A	N/A	0.1	10	N/A	N/A	N/A	
45° IS	1	6.7	20	0.1	8	1	0.1	9	0.1	9	N/A	N/A	0.1	9	N/A	N/A	N/A	
45° OS	1	6.7	10	0.1	8	1	0.1	9	0.0	4	N/A	N/A	0.0	4	N/A	N/A	N/A	
90° OS	2	6.7	15	0.2	16	2	0.2	18	0.1	9	N/A	N/A	0.1	9	N/A	N/A	N/A	

OPTIONAL HIGH OUTPUT LED LIGHTS (115 VOLT)

CASE LENGTH	CANOPY LIGHTS		OPTIONAL SHELF		MAX. H.O. LED LOAD	
	AMPS	WATTS	AMPS	WATTS	AMPS	WATTS
4'	0.2	26	N/A	N/A	0.2	26
5'	0.3	30	N/A	N/A	0.3	30
6'	N/A	N/A	N/A	N/A	N/A	N/A
8'	0.5	52	N/A	N/A	0.5	52
10'	0.5	61	N/A	N/A	0.5	61
12'	0.7	78	N/A	N/A	0.7	78
22.5° IS	N/A	N/A	N/A	N/A	N/A	N/A
22.5° OS	N/A	N/A	N/A	N/A	N/A	N/A
45° OS	N/A	N/A	N/A	N/A	N/A	N/A
45° IS	N/A	N/A	N/A	N/A	N/A	N/A
90° OS	N/A	N/A	N/A	N/A	N/A	N/A

8. Electrical

Wiring Color Code

STANDARD CASE WIRE COLOR CODE CODIGO DE COLORES DE LOS ALAMBRES PARA LAS VITRINAS ESTANDAR CODE COULEUR POUR FILS DE BOITIER NORMALISE		
COLOR DESCRIPTION	DESCRIPCION	DESCRIPTION
GROUND	TIERRA MASA	MASSE
ANTI-SWEAT	ANTICONDENSACION	ANTI-SUITEMENT
LIGHTS	LUCES	ECLAIRAGE
RECEPTACLES	ENCHUFES	PRISE DE COURANT
T-STAT/SOLENOID 230VAC	TERMOSTATO/SOLENOIDE (230VAC)	SOUPAPE A SOLENOID (230 VAC)
T-STAT/SOLENOID 115VAC	TERMOSTATO/SOLENOIDE (115VAC)	SOUPAPE A SOLENOID (115 VAC)
T-STAT/SOLENOID 24VAC	TERMOSTATO/SOLENOIDE (24VAC)	SOUPAPE A SOLENOID (24 VAC)
FAN MOTORS	VENTILADORES	VENTILATEUR
BLUE CONDENSING UNIT	UNIDAD DE CONDENSACION	UNITE DE CONDENSATION

USE COPPER CONDUCTORS ONLY
UTILISEZ LES CONDUCTEURS DE CUIVRE SEULEMENT
UTILICE LOS CONDUCTORES DE COBRE SOLAMENTE
430-01-0338 R101003

CASE MUST BE GROUNDED

NOTE: Refer to label affixed to case to determine the actual configuration as checked in the "TYPE INSTALLED" boxes.

Electrical Circuit Identification

Standard lighting for all models will be full length fluorescent lamps located within the case at the top. The switch controlling the lights, the plug provided for digital scale, and the thermometer are located at the rear of the case mullion.

The receptacle that is provided on the exterior back of these models is intended for computerized scales with a five amp maximum load, not for large motors or other high wattage appliances. It should be wired to a dedicated circuit.



DANGER

**BEFORE SERVICING
ALWAYS DISCONNECT ELECTRICAL
POWER AT THE MAIN DISCONNECT
WHEN SERVICING OR REPLACING ANY
ELECTRICAL COMPONENT.**

**This includes (but not limited to) Fans, Heaters
Thermostats, and Lights.**

Field Wiring and Serial Plate Amperage

Field Wiring must be sized for component amperes printed on the serial plate. Actual ampere draw may be less than specified. Field wiring from the refrigeration control panel to the merchandisers is required for refrigeration thermostats. Case amperes are listed on the wiring diagram, but always check the serial plate.

LED Driver Location

Drivers are located within the access panel that runs the length of the rear of the case.

Electrical (Cont'd)

ASHRAE Color Code

NOTE: All other manufacturers have no standard sensor codes.

Case Control Systems SENSOR COLOR			
Manufacturer ® >	EIL	CPC	
Location			
Coil Inlet	Color	Blue	Blue
	Part#	225-01-1755	225-01-3255
Coil Outlet	Color	Red	Red
	Part#	225-01-1757	225-01-3123
Discharge Air	Color	Green	Green
	Part#	225-01-1756	225-01-3260
Return Air	Color	Purple	Green
	Part#	225-01-1758	225-01-3260
Defrost Term.	Color	White	Orange
	Part#	225-01-0650	225-01-3254
Liquid Line	Color	White	Blue
	Part#	225-01-0650	225-01-3255

9. Finishing Touches

Bumper Installation Tips

1. Start to attach the bumper at one end of the lineup, preferably on a straight case.
2. Push the end of the bumper into the bumper channel firmly. This may be difficult if bumper is cold.
3. Bend the bumper backwards to open and guide it forward onto the bumper channel.
4. An inside bumper miter must be cut on wedges.
5. Loose ends on miters must be anchored with screws on the bottom edge.
6. The top and bottom edges of the bumper must be firmly seated into the retainer by applying with a rubber mallet (not by hand).
7. The bumper should be struck by the mallet at a slight angle that forces the bumper back into itself to prevent stretching. The installation can be made easier by applying a paraffin block to the retainer grooves.

Installing Splashguard

After merchandisers have been leveled and joined, and all drip piping, electrical and refrigeration work has been completed, install the splashguards. Splashguards may be sealed to the floor using a vinyl cove base trim. The size of trim needed will depend on how much the floor is out of level.

NOTE: The splashguard must be removable to allow access to components behind it.

1. Remove all dirt, wax, debris, etc. from the area of the splashguard to ensure a secure adhesion.
2. Apply a good contact cement to the trim, allowing a proper dry time.
3. Install trim to the splashguard so that it is flush with the floor.

10. User Information

Stocking

Improper temperature and lighting will cause serious product loss. Discoloration, dehydration and spoilage can be controlled with proper use of the equipment and handling of product. Product temperature should always be maintained at a constant and proper temperature. This means that from the time the product is received, through storage, preparation and display, the temperature of the product must be controlled to maximize life of the product. Hussmann cases were not designed to "heat up" or "cool down" product - but rather to maintain an item's proper temperature for maximum shelf life. To achieve the protection required always:

1. Minimize processing time to avoid damaging temperature rise to the product. Product should be at proper temperature.

2. Keep the air in and around the case area free of foreign gasses and fumes or food will rapidly deteriorate.
3. Maintain the display merchandisers temperature controls as outlined in the refrigerator section of this manual.
4. Do not place any product into these refrigerators until all controls have been adjusted and they are operating at the proper temperature. Allow merchandiser to operate a minimum of six (6) hours before stocking with any product.
5. When stocking, never allow the product to extend beyond the recommended load limit. Air discharge and return air flow must be unobstructed at all times to provide proper refrigeration.

User Information (Cont'd)

6. There are vents located at the base of the front of the glass, just above the front rail. These vents supply a continuous, gentle flow of air across the front glass which inhibits condensation. Do not place any signs or other restrictive objects on the front of the refrigerator that will block these vents.
7. Keep the service doors closed (when applicable). Refrigeration performance will be seriously affected if left open for a prolonged period of time.
8. Avoid the use of supplemental flood or spot lighting. Display light intensity has been designed for maximum visibility and product life at the factory. The use of higher output fluorescent lamps (H.O. and V.H.O.), will shorten the shelf life of the product.
9. In the Deli, Meat and Fish cases, completely cover the product each night with a clean damp cloth or butcher paper (never use plastic, as it does not allow for proper circulation). Make sure the cloth or paper is in direct contact with the product.
10. Turn and rotate the meat fairly often. The blood which gives the pink color works its way downward with time.
11. Cold coils remove heat and moisture from the case and deposit this as frost onto the coil. Thus, a defrost is required. Our humidity system induces moisture into the case and helps slow down the dehydration process. The only other moisture within the case is that in the product itself. A single level of meat will dry out faster than a fully loaded case of 3-4 levels of meat.

Important Steps

1. Do not set temperature too cold, as this causes product dehydration. **Product Temperature: 33°-35°F!** Set thermostat to cut in at 28°F discharge air. Meat holding box: 32°F. Meat prep room: 55°F. Meat bloom box: 36°F. Process the meat to enter case at 40°F or below. Product deterioration is very rapid above 40°F.
2. Temperature control should be by means of a T-STAT and Suction Stop Solenoid at each case. Do not use EPR valves, Liquid line solenoids or electronic control devices of any kind, as these allow temperature swings causing dehydration and excessive energy consumption.
3. Product should be worked and rotated on a regular basis, not to exceed a 4 hour period.
4. At night, turn off case lights and cover the product with a damp (not wet) cloth similar to cheese cloth (etc.). This should be washed out in the morning and kept in a walk-in box during the day - so that it is cool and moist when covering the product.
5. Discharge air temperature should be approximately 26°F, with between 150-200 FPM air velocity. Do not display product directly within the air discharge.

6. Clean humidity system a minimum of every 90 days for proper system operation.

Case Cleaning

Long life and satisfactory performance of any equipment are dependent upon the care given to it. To insure long life, proper sanitation and minimum maintenance costs, the refrigerator should be thoroughly cleaned frequently. **SHUT OFF FAN DURING CLEANING PROCESS.** It can be unplugged within the case, or shut off entire case at the source. The interior bottom may be cleaned with any domestic soap or detergent based cleaners. Sanitizing solutions will not harm the interior bottom, however, these solutions should always be used according to the Hussmann's directions. It is essential to establish and regulate cleaning procedures. This will minimize bacteria causing discoloration which leads to degraded product appearance and significantly shortening product shelf life.

Soap and hot water are not enough to kill this bacteria. A sanitizing solution must be included with each cleaning process to eliminate this bacteria.

1. Scrub thoroughly, cleaning all surfaces, with soap and hot water.
2. Rinse with hot water, but do not flood.
3. Apply the sanitizing solution according to Hussmann's directions.
4. Rinse thoroughly.
5. Dry completely before resuming operation.

Cleaning Glass and Mirrors

Only use a soft cloth and mild glass cleaner for cleaning any glass or mirrored components. Be sure to rinse and/or dry completely.

Never use hot water on cold glass surfaces! It may shatter and cause serious injury! Allow glass surfaces to warm first.

CAUTION

CLEANING PRECAUTIONS

When cleaning:

- Do not use high pressure water hoses
- Do not introduce water faster than waste outlet can drain
- NEVER INTRODUCE WATER ON SELF CONTAINED UNIT WITH AN EVAPORATOR PAN
- NEVER USE A CLEANING OR SANITIZING SOLUTION THAT HAS AN OIL BASE (these will dissolve the butyl sealants) or an AMMONIA BASE (this will corrode the copper components of the case)
- TO PRESERVE THE ATTRACTIVE FINISH:
- DO USE WATER AND A MILD DETERGENT FOR THE EXTERIOR ONLY
- DO NOT USE A CHLORINATED CLEANER ON ANY SURFACE
- DO NOT USE ABRASIVES OR STEEL WOOL SCOURING PADS (these will mar the finish)

User Information (Cont'd)

Non-Glare Glass

The high optical clarity of this glass is possible due to special coatings on the glass surface itself. To preserve this coating and the optical clarity, keep the glass clean.

Water is the only solution recommended for use in cleaning non-glare glass. The damage to the glass from improper, caustic solutions is irreparable.

In addition to cleaning the glass with the recommended product, there are precautions that should be taken when working and cleaning the inside of the case.

- When cleaning the inside of the cases, we recommend that the glass be fully opened and covered to prevent solutions from splashing onto the glass and ruining the coating on the inside.

Plexiglass and Acrylic Care

Improper cleaning not only accelerates the cleaning cycle but also degrades the quality of this surface. Normal daily buffing motions can generate static cling attracting dust to the surface. Incorrect cleaning agents or cleaning cloths can cause micro scratching of the surface, causing the plastic to haze over time.

Cleaning

Husmann recommends using a clean damp chamois, or a paper towel marked as "dust and abrasive free" with **210[®] Plastic Cleaner and Polish** available by calling Sumner Labs at **1-800-542-8656**. Hard, rough cloths or paper towels will scratch the acrylic and should not be used.

Antistatic Coatings

The **210[®]** has proven to be very effective in not only cleaning and polishing the Plexiglass surface, but also providing antistatic and anti-fog capabilities. This product also seals pores and provides a protective coating.

11. Maintenance



IMPORTANT INFORMATION

FOR PROMPT SERVICE
Have case Model and Serial Number ready!
This information is located
on the nameplate of the unit.



DANGER

BEFORE SERVICING
ALWAYS DISCONNECT ELECTRICAL
POWER AT THE MAIN DISCONNECT
WHEN SERVICING OR REPLACING ANY
ELECTRICAL COMPONENT.

This includes (but not limited to) Fans, Heaters
Thermostats, and Lights.

Tips and Troubleshooting

Before calling for service, check the following:

1. Check electrical power supply to the equipment for connection.
2. Check fixture loading. Overstocking case will affect its proper operation.
3. If frost is collecting on fixture and/or product, check that Humidity Control is working properly, and that no outside doors or windows are open - allowing moisture to enter store.

Glass Replacement and Adjustment Instructions

In order to replace or adjust the glass, the glass must be placed in the raised position. The underside of the clamp is exposed, revealing the tightening screws. By turning these screws counterclockwise 1/4 turn each, the glass will be loosened for either removal or adjustment.

Note: Do not overtighten the screws since damage may occur.

Evaporator Fans

The evaporator fans are located at the center front of these merchandisers directly beneath the display pans. *Should fans or blades need servicing, always replace fan blades with the raised embossed side of the blade TOWARD THE MOTOR.*

Coils

The copper coils used in Hussmann merchandisers may be repaired in the field. Materials are available from local refrigeration wholesalers.

Hussmann recommends using #15 Sil-Fos for repairs.

Maintenance (Cont'd)

Stainless Steel Cleaning and Care

There are three basic things, which can break down your stainless steel's passivity layer and allow corrosion.

1. Mechanical Abrasion

Mechanical Abrasion means those things that will scratch the steel's surface. Steel Pads, wire Brushes, and Scrapers are prime examples.

2. Water

Water comes out of our tap in varying degrees of hardness. Depending on what part of the country you live in, you may have hard or soft water. Hard water may leave spots. Also, when heated, hard water leaves deposits behind that if left to sit, will break down the passive layer and rust your stainless steel. Other deposits from food preparation and service must be properly removed.

3. Chlorides

Chlorides are found nearly everywhere. They are in water, food and table salt. One of the worst perpetrators of chlorides can come from household and industrial cleaners.

Don't Despair! Here are a few steps that can help prevent stainless steel rust.

1. Use the Proper Tools

When cleaning your stainless steel products, take care to use non-abrasive tools. Soft Clothes and plastic scouring pads will NOT harm the steel's passive layer. Stainless steel pads can also be used but the scrubbing motion must be in the same direction of the manufacturer's polishing marks.

2. Clean With the Polish Lines

Some stainless steels come with visible polishing lines or "grain". When visible lines are present, you should ALWAYS scrub in a motion that is parallel to them. When the grain cannot be seen, play it safe and use a soft cloth or plastic scouring pad.

3. Use Alkaline, Alkaline Chlorinated or Non-chloride Containing Cleaners

While many traditional cleaners are loaded with chlorides, the industry is providing an ever increasing choice of non-chloride cleaners. If you are not sure of your cleaner's chloride content contact your cleaner supplier. If they tell you that your present cleaner contains chlorides, ask for an alternative. Also, avoid cleaners containing quaternary salts as they also can attack stainless steel & cause pitting and rusting.

4. Treat your Water

Though this is not always practical, softening hard water can do much to reduce deposits. There are certain filters that can be installed to remove distasteful and corrosive elements. Salts in a properly maintained water softener are your friends. If you are not sure of the proper water treatment, call a treatment specialist.

5. Keep your Food Equipment Clean

Use alkaline, alkaline chlorinated or non-chlorinated cleaners at recommended strength. Clean frequently to avoid build-up of hard, stubborn stains. If you boil water in your stainless steel equipment, remember the single most likely cause of damage is chlorides in the water. Heating cleaners that contain chlorides has a similar effect.

6. RINSE, RINSE, RINSE

If chlorinated cleaners are used you must rinse, rinse, rinse and wipe dry immediately. The sooner you wipe off standing water, especially when it contains cleaning agents, the better. After wiping the equipment down, allow it to air dry for the oxygen helps maintain the stainless steel's passivity film.

7. Never Use Hydrochloric Acid (Muriatic Acid) on Stainless Steel

8. Regularly Restore/Passivate Stainless Steel

12. Electrical Wiring Diagrams

Q1-DC/DS-4R	4'	3014184
Q1-DC/DS-5R	5'	3014185
Q1-DC/DS-6R	6'	3014186
Q1-DC/DS-8R	8'	3014187
Q1-DC/DS-9R	9'	3014188
Q1-DC/DS-10R	10'	3014189
Q1-DC/DS-12R	12'	3014190
Q1-DC/DS-22.5 OS		3014191
Q1-DC/DS-22.5 IS		3014192
Q1-DC/DS-45 OS		3014193
Q1-DC/DS-45 IS		3014194
Q1-DC/DS-90 OS		3014195

CIRCUIT #1
LOADING

120V			
150			

LIGHT CIRCUIT= 0.22A 24W

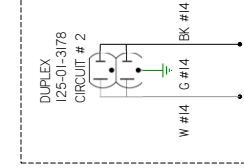
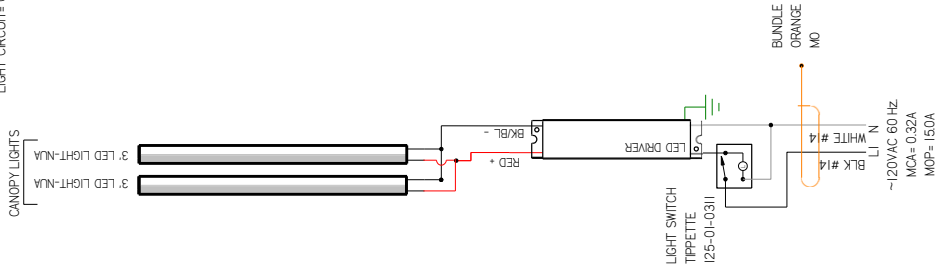

CIRCUIT #2	
LOADING	
120 V	
150	

AIR SWEEP FAN
20A @ 120VAC 15W
0404551

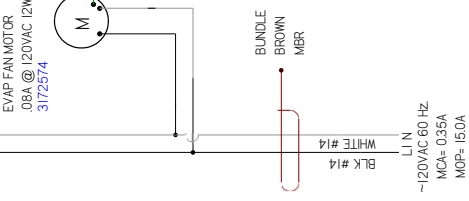
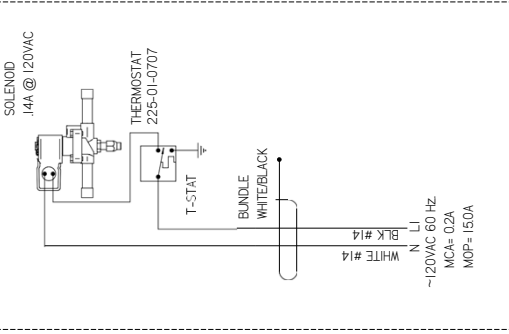

REV	ECN	DATE	REVISION DESCRIPTION	REV BY	CHK BY	APPR BY
A	ECN-CAP-0003238	2018/06/01	RELEASED TO PRODUCTION	CB	CB	CB
B	ECN-COD-0014613	2020/12/06	NEW LIGHTS	CB	CB	CB
C	ECN-COD-0018441	2022/09/01	CHANGED EVAP FAN	CB	CB	CB
D	ECN-COD-0018715	2023/11/01	NEW FAN MOTOR	CB	CB	CB

HUSSMANN
DIAGRAM-Q1-
DC/DS- 4R

MATERIAL - N/A
DATE DRAWN - 8-30-16
DRAWN BY - CRAIG BOOREY
REVIEWED BY - CRAIG BOOREY
APPROVED BY - CRAIG BOOREY
UNLESS OTHERWISE SPECIFIED DIMENSIONS ARE IN INCHES
TOLERANCES ARE:
DIMENSIONS .XX +.03 .XXX
+0.0
ANGLES ± 2°

ECN-CAP-0003238
REF -
SHEET 1 OF 1
THIRD
ANCL
E
PROJECTION

3014184 | D

NOTES:
CASE MUST BE GROUNDED
WHEN PASSING WIRES THROUGH METAL HOLES A GROMMET MUST BE USED

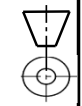

CIRCUIT #1
LOADING

120V			
150			
175			
200			

LIGHT CIRCUIT= 0.32A 34.0W

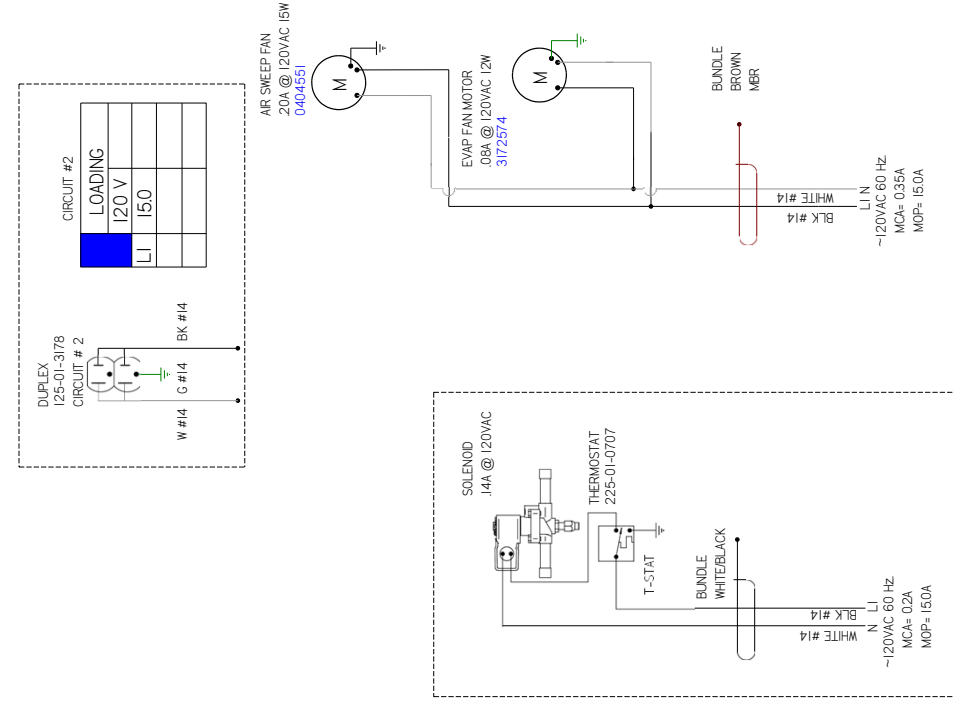
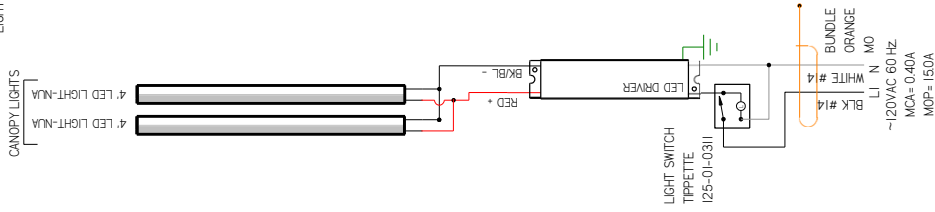

DUPLEX 125-01-3178
CIRCUIT # 2

CIRCUIT #2	LOADING
LI	120 V
LI	150

REV	EN	DATE	REVISION DESCRIPTION	REV BY	CHK BY	APP BY
A	ECN-CAP-0003238	2018/06/03	RELEASED TO PRODUCTION	CB	CB	CB
B	ECN-CDD-0014613	2020/12/06	NEW LIGHTS	CB	CB	CB
C	ECN-CDD-0018441	2022/09/03	CHANGED EVAP FAN	CB	CB	CB

HUSSMANN
DIAGRAM-Q1-
DC/DS-5R

MATERIAL - N/A

DATE DRAWN - 8-30-16
DRAWN BY - CRAIG BOOREY
REVIEWED BY - CRAIG BOOREY
APPROVED BY - CRAIG BOOREY

ECN-CAP-0003238
REF -
SHEET 1 OF 1

UNLESS OTHERWISE SPECIFIED DIMENSIONS ARE IN INCHES
TOLERANCES ARE:
FRACTIONS .XX
DECIMALS .XX +03 .XXX
ANGLES ± 2°

PROJECTION
E
C

NOTES:
CASE MUST BE GROUNDED
WHEN PASSING WIRES THROUGH METAL HOLES A GROMMET MUST BE USED

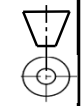

CIRCUIT #1				
LOADING	120V	150		

REV	ECN	DATE	REVISION DESCRIPTION	REV BY	CHK BY	APPR BY
A	ECN-CAP-0003238	2016/06/00	RELEASED TO PRODUCTION	CB	CB	CB
B	ECN-CAP-0006200	2017/07/12	REVISED EVAP FAN MOTORS	CB	CB	CB
C	ECN-CAP-001819	2018/04/10	REVISED MODEL NUMBER	CB	CB	CB
D	ECN-COD-0014613	2020/11/20/6	NEW LIGHTS	CB	CB	CB
E	ECN-COD-0018441	2023/01/10	CHANGED EVAP FANS	CB	CB	CB

LIGHT CIRCUIT= 0.41A 4.4W

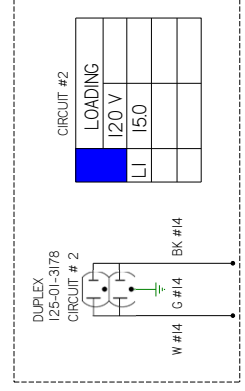
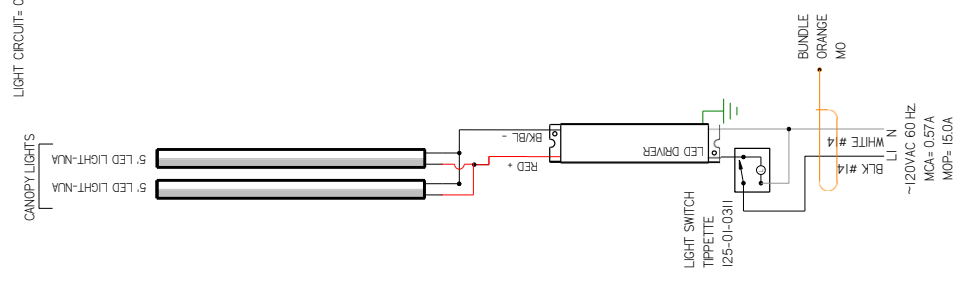

AIR SWEEP FAN
20A @ 120VAC 15W
(2) D4004551

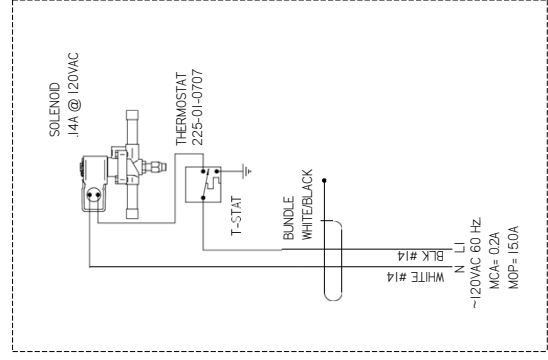
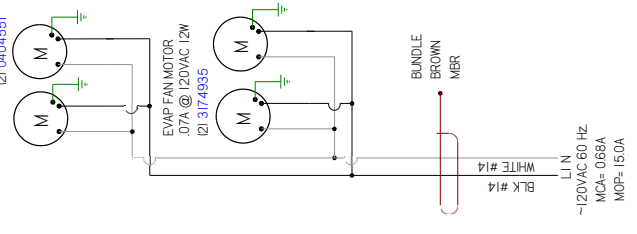

HUSSMANN
DIAGRAM-QTFCFS-6 R

MATERIAL - N/A
DATE DRAWN - 8-30-16
DRAWN BY - CRAIG BOOREY
REVIEWED BY - CRAIG BOOREY
APPROVED BY - CRAIG BOOREY
SHEET NO. 1
UNLESS OTHERWISE SPECIFIED DIMENSIONS ARE IN INCHES
TOLERANCES ARE:
DIMENSIONS .XX +.03 .XXX
+0.0 ANGL
E
PROJECTION
ANGLES ± 2°

ECN-CAP-0003238
REF -
SHEET NO. 1

3014186 | E

NOTES:
CASE MUST BE GROUNDED
WHEN PASSING WIRES THROUGH METAL HOLES A GROMMET MUST BE USED

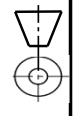

CIRCUIT #1	LOADING		
	120V		
	L1	L3	

REVISION HISTORY			
REV	EN	DATE	DESCRIPTION
A	ECN-CAP-0003238	20/06/2007	RELEASED TO PRODUCTION
B	ECN-COD-0014653	20/07/2007	NEW LIGHTS

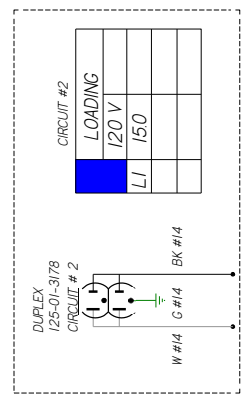
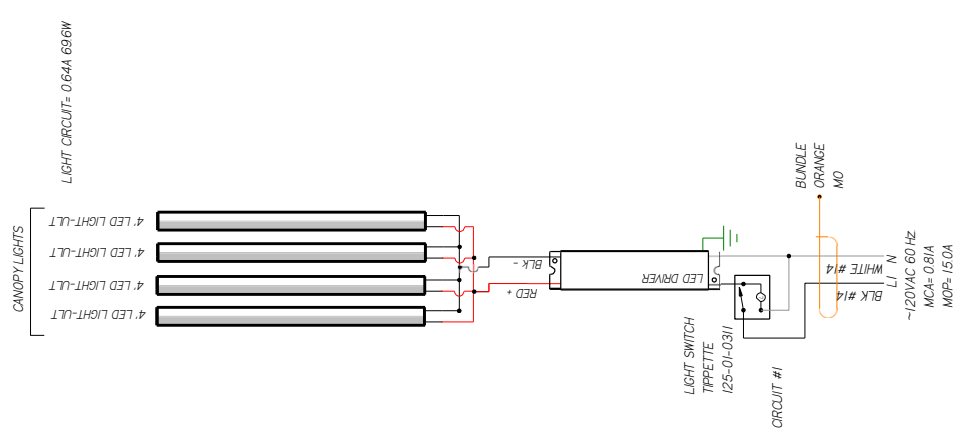

CIRCUIT #2	
LOADING	
120 V	
L1	L50

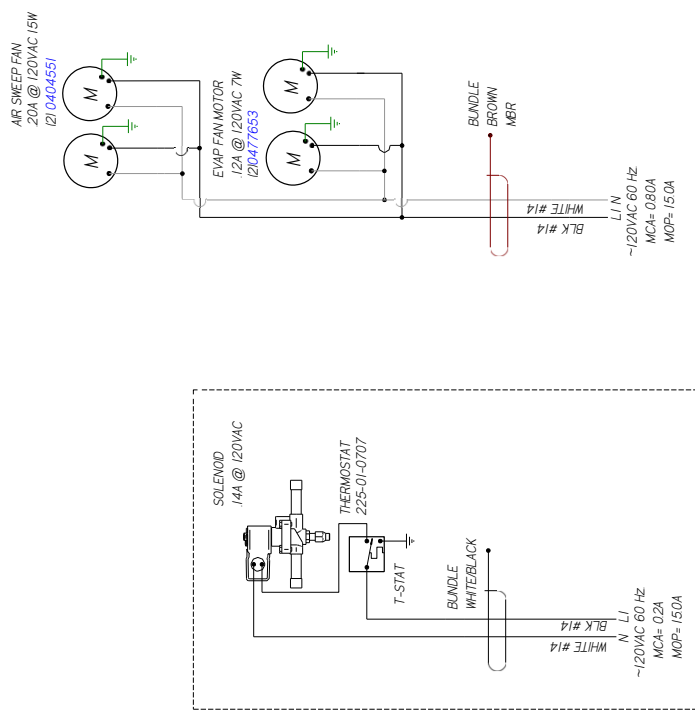

HUSSMANN
DIAGRAM-Q1-
DC/DS- 9R

DATE DRAWN - 8-30-16
DRAWN BY - CRAIG BOOREY
REVIEWED BY - CRAIG BOOREY
APPROVED BY - CRAIG BOOREY

ECN-CAP-0003238
REF -
SHEET 1 OF 1

UNLESS OTHERWISE SPECIFIED DIMENSIONS ARE IN INCHES
TOLERANCES ARE:
THIRD ANGLE PROJECTION

DECIMALS .XX +0.3 .XXX
ANGLES ± 2°

MATERIAL - NA

NOTES:
CASE MUST BE GROUNDED
WHEN PASSING WIRES THROUGH METAL HOLES A GROMMET MUST BE USED

3014188

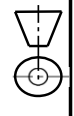

CIRCUIT #1
LOADING

120V	
150V	
175V	
200V	

REVISION HISTORY

REV	ECN	DATE	REVISION DESCRIPTION	REV BY	CHK BY	APPR BY
A	ECN-CAP-0003238	2018/08/03	RELEASED TO PRODUCTION	CB	CB	CB
B	ECN-CDD-0014613	2020/12/08	NEW LIGHTS	CB	CB	CB
C	ECN-CDD-0018441	2022/09/01	CHANGED SWP FAN	CB	CB	CB

LIGHT CIRCUIT= 0.16A 17.4W

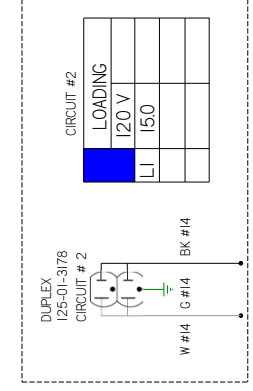
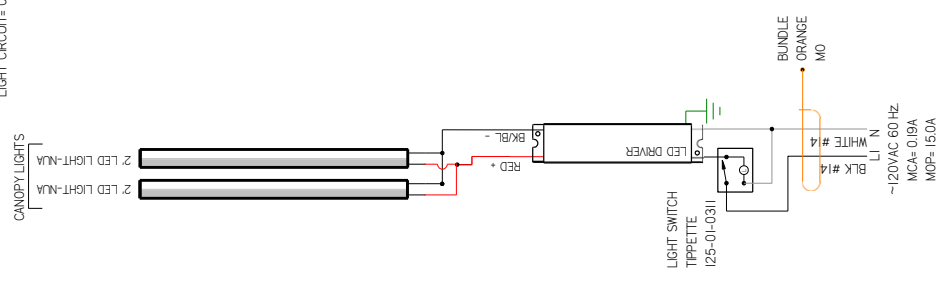

AIR SWEEP FAN
20A @ 120VAC 15W
0404551

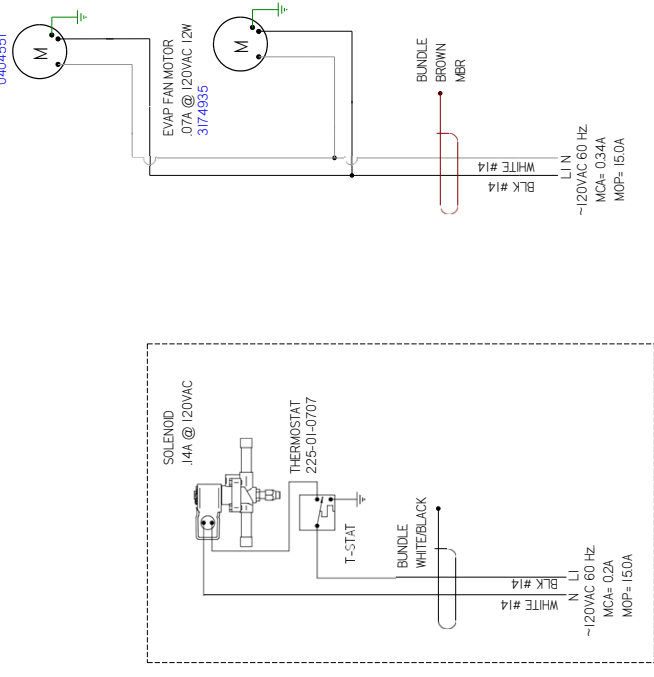

HUSSMANN
DIAGRAM-Q1-DCDS-
22.5 0S

MATERIAL - N/A

DATE DRAWN - 8-30-16
DRAWN BY - CRAIG BOOREY
REVIEWED BY - CRAIG BOOREY
APPROVED BY - CRAIG BOOREY

ECN-CAP-0003238
REF -
SHEET 1 OF 1
UNLESS OTHERWISE SPECIFIED DIMENSIONS ARE IN INCHES
TOLERANCES ARE:
FRACTIONS .XXX
DECIMALS .XX +03 .XXX
ANGLES ± 2°

3014191 | C

PROJECTION

NOTES:
CASE MUST BE GROUNDED
WHEN PASSING WIRES THROUGH METAL HOLES A GROMMET MUST BE USED

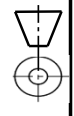

CIRCUIT #1
LOADING

120V	
150	

REVISION HISTORY

REV	ECN	DATE	REVISION DESCRIPTION	REV BY	CHKD BY	APPR BY
A	ECN-CAP-0003238	2018/08/03	RELEASED TO PRODUCTION	CB	CB	CB
B	ECN-CDD-0014613	2020/12/08	NEW LIGHTS	CB	CB	CB
C	ECN-CDD-0018441	2022/09/10	CHANGED EVAP FAN	CB	CB	CB

LIGHT CIRCUIT= 0.16A 17.4W

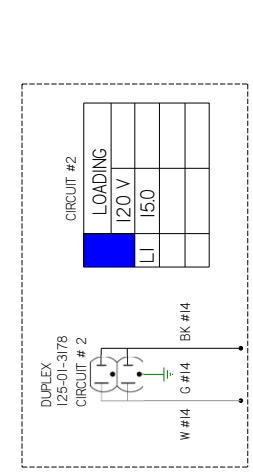
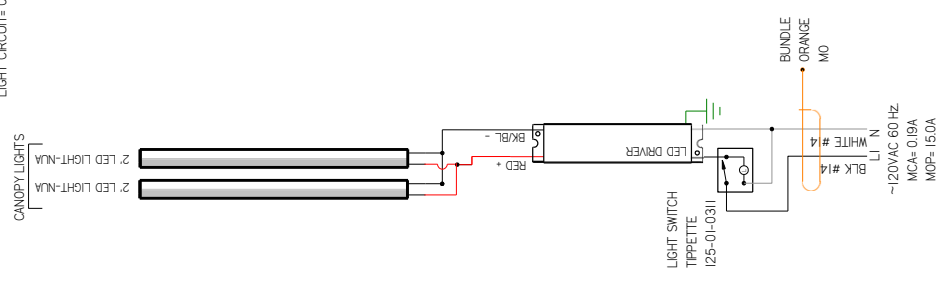

AIR SWEEP FAN
20A @ 120VAC 15W
0404551

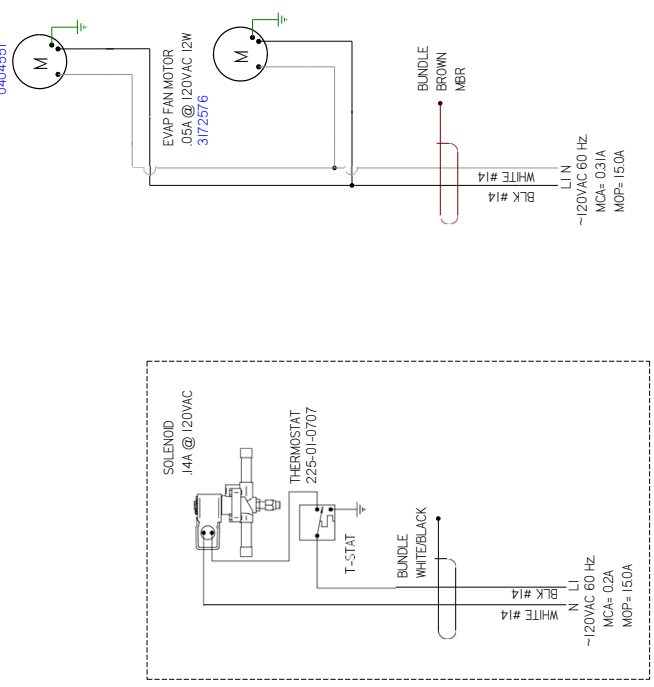

HUSSMANN
DIAGRAM-Q1-DCDS-
22.5 IS

MATERIAL - N/A

DATE DRAWN - 8-30-16
DRAWN BY - CRAIG BOOREY
REVIEWED BY - CRAIG BOOREY
APPROVED BY - CRAIG BOOREY

ECN-CAP-0003238
REF -
SHEET 1 OF 1

UNLESS OTHERWISE SPECIFIED DIMENSIONS ARE IN INCHES
TOLERANCES ARE:
FRACTIONS .XX
DECIMALS .XX +03 .XXX
ANGLES ± 2°

PROJECTION
E
A
C

NOTES:
CASE MUST BE GROUNDED
WHEN PASSING WIRES THROUGH METAL HOLES A GROMMET MUST BE USED

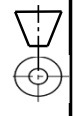

CIRCUIT #1
LOADING

120V			
LI	050		

LIGHT CIRCUIT= 0.1A 10.4W

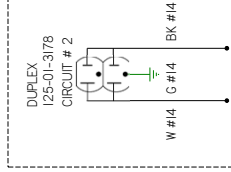
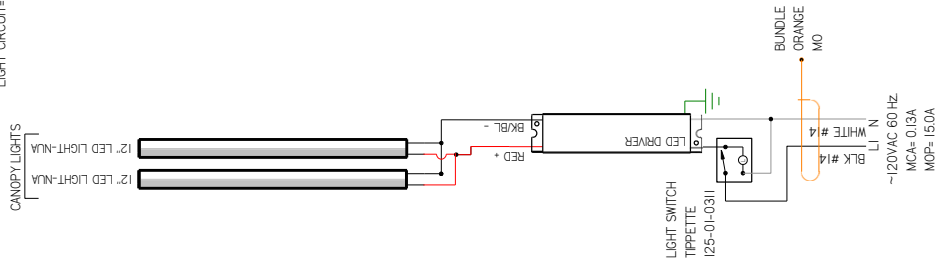

CIRCUIT #2	LOADING
LI	150

AIR SWEEP FAN
20A @ 120VAC 15W
0404551

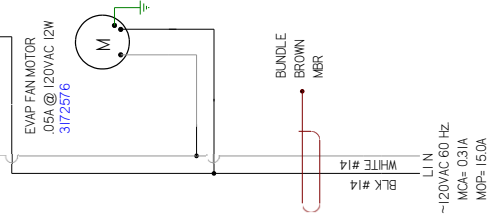
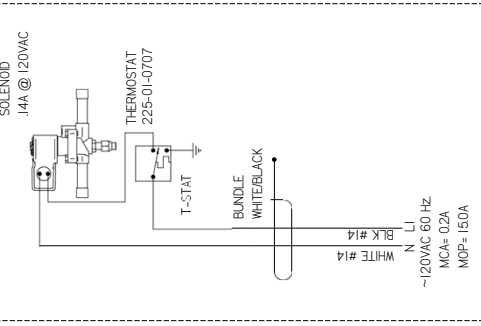

REV	ECN	DATE	REVISION DESCRIPTION	REV BY	CHK BY	APP BY
A	ECN-CAP-0003238	2018/06/03	RELEASED TO PRODUCTION	CB	CB	CB
B	ECN-CDD-0014613	2020/12/08	NEW LIGHTS	CB	CB	CB
C	ECN-CDD-0018441	2022/09/01	CHANGED EVAP FAN	CB	CB	CB

REVISION HISTORY

HUSSMANN
DIAGRAM-Q1-
DC/DS- 45 OS
3014193 | C

MATERIAL - N/A
DATE DRAWN - 8-30-16
DRAWN BY - CRAIG BOOREY
ECN-CAP-0003238
REVIEWED BY - CRAIG BOOREY
APPROVED BY - CRAIG BOOREY
SHEET 1 OF 1
UNLESS OTHERWISE SPECIFIED DIMENSIONS ARE IN INCHES
TOLERANCES ARE:
DIMENSIONS .XX +.03 .XXX
+0.0
ANGLES ± 2°
PROJECTION
E
A

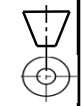

NOTES:
CASE MUST BE GROUNDED
WHEN PASSING WIRES THROUGH METAL HOLES A GROMMET MUST BE USED

CIRCUIT #1 LOADING	120V	150	(C3)

REV	ECN	DATE	REVISION DESCRIPTION	REV BY	CHK BY	APPR BY
A	ECN-CAP-0003238	2018/06/01	RELEASED TO PRODUCTION	CB	CB	CB
B	ECN-COD-0014613	2020/12/08	NEW LIGHTS	CB	CB	CB
C	ECN-COD-0018441	2022/09/01	CHANGED EVAP FAN	CB	CB	CB
D	ECN-COD-0018715	2023/11/01	NEW FAN MOTORS	CB	CB	CB

LIGHT CIRCUIT= 0.19A 20.8W

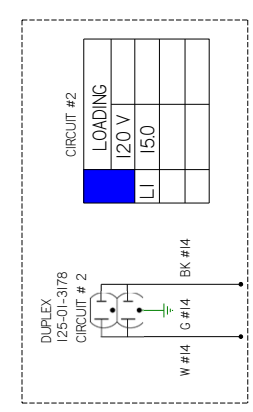
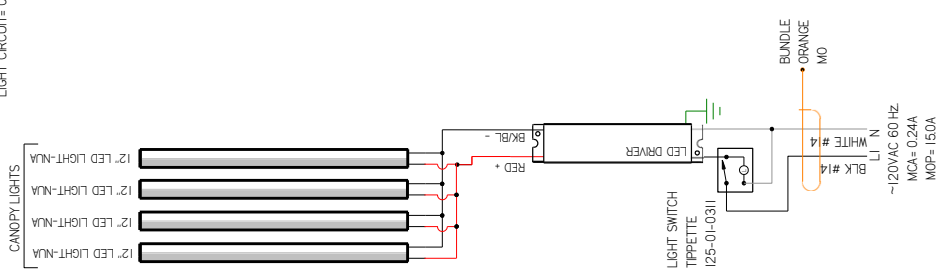

AIR SWEEP FAN
20A @ 120VAC 15W
0404551

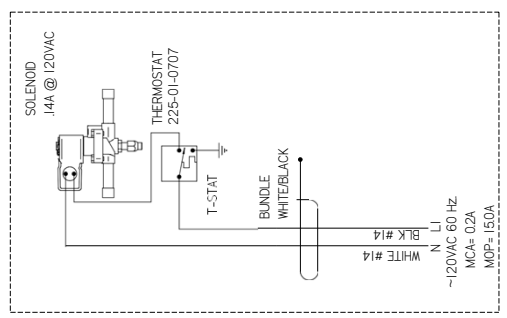
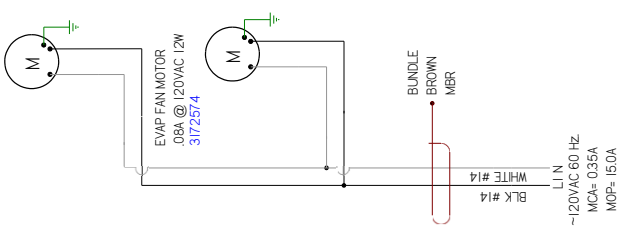

HUSSMANN
DIAGRAM-Q1-
DC/DS- 45 IS

MATERIAL - N/A
 DATE DRAWN - 8-30-16
 DRAWN BY - CRAIG BOOREY
 ECN-CAP-0003238
 REF -
 REVIEWED BY - CRAIG BOOREY
 SHEET 1 OF 1
 UNLESS OTHERWISE SPECIFIED DIMENSIONS ARE IN INCHES
 TOLERANCES ARE:
 FRACTIONS - AS SHOWN
 DECIMALS .XX +03 .XXX
 ANGLES ± 2°
 PROJECTION
 E
 3014194 | D

NOTES:
 CASE MUST BE GROUNDED
 WHEN PASSING WIRES THROUGH METAL HOLES A GROMMET MUST BE USED

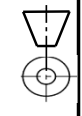

CIRCUIT #1 LOADING	120V	150V	200V

REV	ECN	DATE	REVISION DESCRIPTION	REV BY	CHK BY	APPR BY
A	ECN-CAP-0003238	2018/08/03	RELEASED TO PRODUCTION	CB	CB	CB
B	ECN-COD-0014613	2020/12/08	NEW LIGHTS	CB	CB	CB
C	ECN-COD-0018441	2023/09/10	CHANGED EVAP FANS	CB	CB	CB

LIGHT CIRCUIT= 0.19A, 20.8W

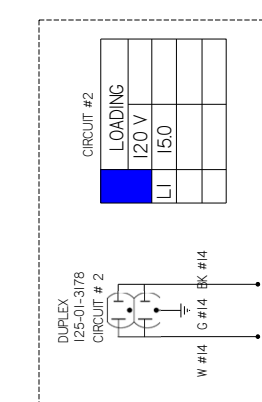
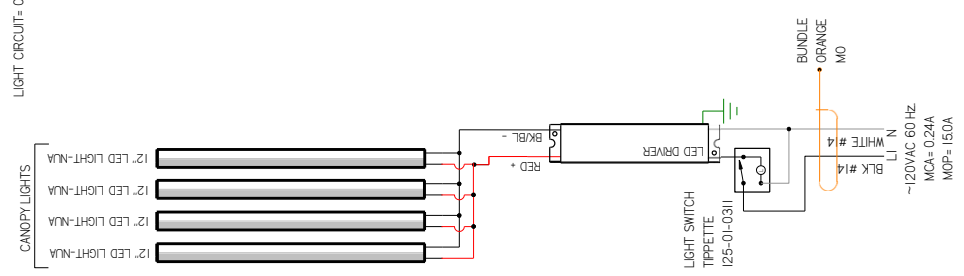

CIRCUIT #2 LOADING	120V	150V	200V

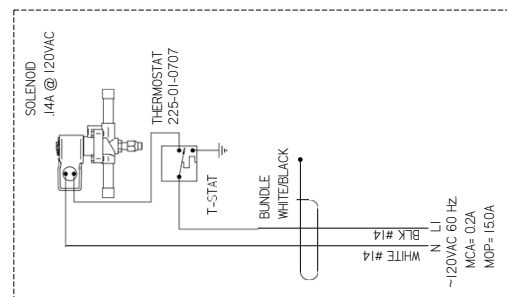
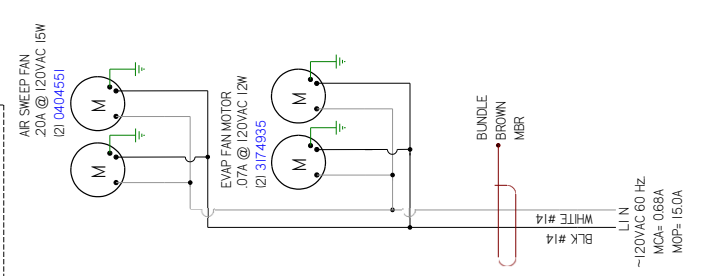

HUSSMANN
DIAGRAM-Q1-
DC/DS- 90 OS

MATERIAL - N/A
DATE DRAWN - 8-30-16
DRAWN BY - CRAIG BOOREY
REVIEWED BY - CRAIG BOOREY
APPROVED BY - CRAIG BOOREY
UNLESS OTHERWISE SPECIFIED DIMENSIONS ARE IN INCHES
TOLERANCES ARE:
FRACTIONS .XX .XXX
DECIMALS .XX +03 .XXX
+0.0 ANGL
E
PROJECTION

3014195 | C

NOTES:
CASE MUST BE GROUNDED
WHEN PASSING WIRES THROUGH METAL HOLES A GROMMET MUST BE USED

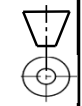

14. Troubleshooting Guide

Problem	Possible Cause	Possible Solution
Case temperature is too warm.	Ambient conditions may be affecting the case operation.	Check case position in store. Is the case located near an open door, window, electric fan or air conditioning vent that may cause air currents? Case must be located minimum 15 Ft away from doors or windows. Cases are designed to operate at 55% Relative humidity and a temperature of 75°F.
	Discharge air temp is out of spec.	Check evaporator fan operation. Check electrical connections and input voltage.
		Fans are installed backwards. Check airflow direction.
		Fan blades are installed incorrectly. Make sure fan blades have correct pitch and are per specification.
		Check to see that fan plenum is installed correctly. It should not have any gaps.
		Check suction pressure and insure that it meets factory specifications.
	Case is in defrost.	Check defrost settings. See Technical Specifications section.
	Product load may be over its limits blocking airflow.	Redistribute product so it does not exceed load level. There is a sticker on the inside of the case indicating what the maximum load line is.
	Coil is freezing over.	Return air is blocked, make sure debris is not blocking the intake section.
Coil close-offs are not installed. Inspect coil to make sure these parts are on the case.		
Condensing coil or evaporator coil is clogged or dirty.	Clean coil.	
Case temperature is too cold.	The t-stat temp is set too low.	Check settings. See Technical Specifications section.
	Ambient conditions may be affecting the case operation.	Check case position in store. Is the case located near an open door, window, electric fan or air conditioning vent that may cause air currents? Case must be located minimum 15 Ft away from doors or windows. Cases are designed to operate at 55% Relative humidity and a temperature of 75°F.
Condensation on glass.	Ambient conditions may be affecting the case operation.	Check case position in store. Is the case located near an open door, window, electric fan or air conditioning vent that may cause air currents? Case must be located minimum 15 Ft away from doors or windows. Cases are designed to operate at 55% Relative humidity and a temperature of 75°F.
	Inadequate air circulation.	Check if air sweep fans are functioning, check electrical connections.
	There is not enough heat provided in the airflow.	Check if air sweep heater is functioning, check electrical connections.
	There are glass gaps on the side of the case.	See glass adjustment section.
	Glass is not completely shut.	Close glass correctly.

Troubleshooting Guide (Cont'd)

Problem	Possible Cause	Possible Solution
Water has pooled under case.	Case drain is clogged.	Clear drain.
	PVC drains under case may have a leak.	Repair as needed.
	Case tub has unsealed opening.	Seal as needed.
	If the case is in a line-up, case to case joint is missing or unsealed.	Install case to case joint and seal as needed.
	Evaporator pan is overflowing (if applicable).	Check electrical connection to evaporator pan. Check float assembly, it should move freely up and down the support stem. Clear any debris.
Case is not draining properly.	Case is not level.	Level the case.
	Drain screen is plugged.	Clean drain screen and remove any debris.
	Drain or P-trap is clogged.	Clear any debris.
Frost or ice on evaporator coil.	Evaporator fans are not functioning.	Check electrical connections.
	Defrost clock is not functioning.	Case should be serviced by a qualified service technician.
	Coil is freezing over.	Return air is blocked, make sure debris is not blocking the intake section.
		Coil close-offs are not installed. Inspect coil to make sure these parts are on the case.
Large gap is visible on bottom of front glass or glass can't be opened because it is too low.	Glass Height adjusters need to be adjusted.	See Glass Adjustment section.
Large gaps are visible in between glass panels or glass rubs against end panel.	Glass/glass clamp assembly needs to be adjusted.	See Glass Adjustment section.
Front glass does not stay open and falls closed.	Glass shock/piston may need to be replaced.	Case should be serviced by a qualified service technician.
Lights do not come on.	Ballast/light socket wiring.	Check electrical connections. See Electrical Section and check wiring diagram.
	Ballast needs to be replaced.	Case should be serviced by a qualified service technician. See Electrical Section.
	Lamp socket needs to be replaced.	Case should be serviced by a qualified service technician.
	Lamp needs to be replaced.	See Maintenance Section.
	Light Switch needs to be replaced.	Case should be serviced by a qualified service technician.

15. Appendices

Appendix A. - Temperature Guidelines - Refrigerated

The refrigerators should be operated according to the manufacturer's published engineering specifications for entering air temperatures for specific equipment applications. Table 1 shows the typical temperature of the air entering the food zone one hour before the start of defrost and one hour after defrost for various categories of refrigerators. Refer to Appendix C for Field Evaluation Guidelines.

Type of Refrigerator	Typical Entering Air Temperature
I. OPEN DISPLAY	
A. Non frozen:	
1) Meat	28°F
2) Dairy/Deli	32°F
3) Produce	
a. Processed	36°F
b. Unprocessed	45°F
B. Frozen	0°F
C. Ice Cream	-5°F
II. CLOSED DISPLAY	
A. Non frozen:	
1) Meat	34°F
2) Dairy/Deli	34°F
3) Produce	
a. Processed	36°F
b. Unprocessed	45°F
B. Frozen	0°F
C. Ice Cream	-5°F

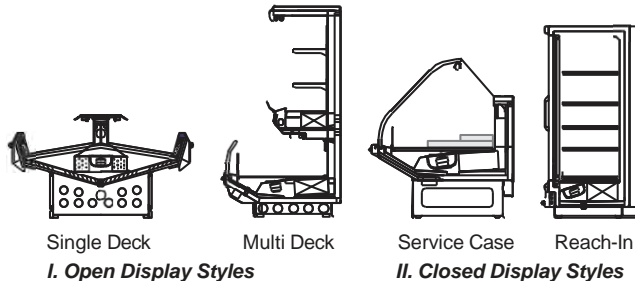

Single Deck

Multi Deck

Service Case

Reach-In

I. Open Display Styles**II. Closed Display Styles**

Appendix B. - Application Recommendations - Refrigerated

- Temperature performance is critical for controlling bacteria growth. Therefore, the following recommendations are included in the standard. They are based on confirmed field experience over many years.
- The installer is responsible for following the installation instructions and recommendations provided by Hussmann for the installation of each individual type refrigerator.
- Refrigeration piping should be sized according to the equipment manufacturer's recommendations and installed in accordance with normal refrigeration

practices. Refrigeration piping should be insulated according to Hussmann's recommendations.

- A clogged waste outlet blocks refrigeration. The installer is responsible for the proper installation of the system which dispenses condensate waste through an air gap into the building indirect waste system.
- The installer should perform a complete start-up evaluation prior to the loading of food into the refrigerator, which includes such items as:
 - Initial temperature performance, Coils should be properly fed with a refrigerant according to manufacturer's recommendations.
 - Observation of outside influences such as drafts, radiant heating from the ceiling and from lamps. Such influence should be properly corrected or compensated for.
 - At the same time, checks should be made of the store dry-bulb and wet-bulb temperatures to ascertain that they are within the limits prescribed by Hussmann.
 - Complete start-up procedures should include checking through a defrost to make certain of its adequate frequency and length without substantially exceeding the actual needs. This should include checking the electrical or refrigerant circuits to make sure that defrosts are correctly programmed for all the refrigerators connected to each refrigeration system.
 - Recording instruments should be used to check performance.

Appendix C. - Field Recommendations - Refrigerated

Recommendations for field evaluating the performance of retail food refrigerators and hot cases.

- The most consistent indicator of display refrigerator performance is temperature of the air entering the product zone (see Appendix A). In practical use, the precise determination of return air temperature is extremely difficult. Readings of return air temperatures will be variable and results will be inconsistent. The product temperature alone is not an indicator of refrigerator performance.

NOTE: Public Health will use the temperature of the product in determining if the refrigerator will be allowed to display potentially hazardous food. For the purpose of this evaluation, product temperature above the FDA Food Code 1993 temperature for potentially hazardous food will be the first indication that an evaluation should be performed. It is expected that all refrigerators will keep food at the FDA Food Code 1993 temperature for potentially hazardous food.

Appendices (Cont'd)

- 1.1 The following recommendations are made for the purpose of arriving at easily taken and understood data which, coupled with other observations, may be used to determine whether a display refrigerator is working as intended:
- a) **INSTRUMENT** - A stainless steel stem-type thermometer is recommended and it should have a dial a minimum of 1 inch internal diameter. A test thermometer scaled only in Celsius or dually scaled in Celsius and Fahrenheit shall be accurate to 1°C (1.8°F). Temperature measuring devices that are scaled only in Fahrenheit shall be accurate to 2°F. The thermometer should be checked for proper calibration. (It should read 32°F when the stem is immersed in an ice water bath).
 - b) **LOCATION** - The probe or sensing element of the thermometer should be located in the airstream where the air first enters the display or storage area, and not more than 1 inch away from the surface and in the center of the discharge opening.
 - c) **READING** - It should first be determined that the refrigerator is refrigerating and has operated at least one hour since the end of the last defrost period. The thermometer reading should be made only after it has been allowed to stabilize, i.e., maintain a constant reading.
 - d) **OTHER OBSERVATIONS** - Other observations should be made which may indicate operating problems, such as unsatisfactory product, feel/appearance.
 - e) **CONCLUSIONS** - In the absence of any apparent undesirable conditions, the refrigerator should be judged to be operating properly. If it is determined that such condition is undesirable, i.e., the product is above proper temperature, checks should be made for the following:
 1. Has the refrigerator been loaded with warm product?
 2. Is the product loaded beyond the "Safe Load Line" markers?
 3. Are the return air ducts blocked?
 4. Are the entering air ducts blocked?
 5. Is a dumped display causing turbulent air flow and mixing with room air?
 6. Are spotlights or other high intensity lighting directed onto the product?
 7. Are there unusual draft conditions (from heating/air-conditioning ducts, open doors, etc.)?
 8. Is there exposure to direct sunlight?
 9. Are display signs blocking or diverting airflow?
 10. Are the coils of the refrigerator iced up?
 11. Is the store ambient over 75°F, 55% RH as set forth in ASHRAE Standard 72 and ASHRAE Standard 117?
 12. Are the shelf positions, number, and size other than recommended by Hussmann?
 13. Is there an improper application or control system?
 14. Is the evaporator fan motor/blade inoperative?
 15. Is the defrost time excessive?
 16. Is the defrost termination, thermostat (if used) set too high?
 17. Are the refrigerant controls incorrectly adjusted?
 18. Is the air entering the condenser above design conditions? Are the condenser fins clear of dirt, dust, etc.?
 19. Is there a shortage of refrigerant?
 20. Has the equipment been modified to use replacements for CFC-12, CFC-502 or other refrigerant? If so, have the modifications been made in accordance with the recommendations of the equipment manufacturer? Is the refrigerator charged with the proper refrigerant and lubricant? Does the system use the recommended compressor?

Appendix D. - Recommendations to User - Refrigerated

- 1.0 Hussmann Corporation provides instructions and recommendations for proper periodic cleaning. The user will be responsible for such cleaning, including the cleaning of low temperature equipment within the compartment and the cooling coil area(s). Cleaning practices, particularly with respect to proper refrigerator unloading and warm-up, must be in accordance with applicable recommendations.

Appendices (Cont'd)

1. Cleaning of non frozen food equipment should include a weekly cleaning of the food compartment as a minimum to prevent bacteria growth from accumulating. Actual use and products may dictate more frequent cleaning. Circumstances of use and equipment design must also dictate the frequency of cleaning the display areas. Weekly washing down of the storage compartment is also recommended, especially for equipment subject to drippage of milk or other liquids, or the collection of vegetable, meat, crumbs, etc. or other debris or litter. Daily cleaning of the external areas surrounding the storage or display compartments with detergent and water will keep the equipment presentable and prevent grime buildup.
2. Load levels as defined by the manufacturer must be observed.
3. The best preservation is achieved by following these rules:
 - a) Buy quality products.
 - b) Receive perishables from transit equipment at the ideal temperature for the particular product.
 - c) Expedite perishables to the store's storage equipment to avoid unnecessary warm-up and prolonged temperature recovery. Food store refrigerators are not food chillers nor can they reclaim quality lost through previous mishandling.
 - d) Care must be taken when cross merchandising products to ensure that potentially hazardous vegetable products are not placed in non refrigerated areas.
 - e) Display and storage equipment doors should be kept closed during periods of inactivity.
 - f) Minimize the transfer time of perishables from storage to display.
 - g) Keep meat under refrigeration in meat cutting and processing area except for the few moments it is being handled in processing. When a cut or tray of meat is not to be worked on immediately, the procedure should call for returning it to refrigeration.
 - h) Keep tools clean and sanitized. Since mechanical equipment is used for fresh meat processing, all such equipment should be cleaned at least daily and each time a different kind of meat product comes in contact with the tool or equipment.
 - i) Make sure that all refrigeration equipment is installed and adjusted in strict accordance with the manufacturer's recommendations.
 - j) See that all storage and refrigeration equipment is kept in proper working order by routine maintenance.



This warning does not mean that Hussmann products will cause cancer or reproductive harm, or is in violation of any product-safety standards or requirements. As clarified by the California State government, Proposition 65 can be considered more of a ‘right to know’ law than a pure product safety law. When used as designed, Hussmann believes that our products are not harmful. We provide the Proposition 65 warning to stay in compliance with California State law. It is your responsibility to provide accurate Proposition 65 warning labels to your customers when necessary. For more information on Proposition 65, please visit the California State government website.

Service Record

Last service date: By:

_____	_____
_____	_____
_____	_____
_____	_____
_____	_____
_____	_____
_____	_____
_____	_____

HUSSMANN®/Chino

Additional copies of this publication may be obtained by contacting:

Husmann® Chino
13770 Ramona Avenue • Chino, California 91710
(909) 628-8942 FAX
(909) 590-4910
(800) 395-9229

The <i>MODEL NAME</i> and <i>SERIAL NUMBER</i> is required in order to provide you with the correct parts and information for your particular unit.
They can be found on a small metal plate on the unit. Please note them below for future reference.
MODEL:
SERIAL NUMBER: