

We reserve the right to change or revise specifications and product design in connection with any feature of our products. Such changes do not entitle the buyer to corresponding changes, improvements, additions or replacements for equipment previously sold or shipped.

Item	Part #	Description	Wiring Item #	Item	Part #	Description	Wiring Item #
FAN ASSEMBLIES, AND THERMOSTATS				HEATERS (CONTINUED)			
A.	4W Standard Efficient Fan Assembly <u>0477653</u> Fan Motor, Evaporator (MO.4410544) <u>0521166</u> Fan Blade (FB.4780611)	(1)	I.	Return Grille Anti-sweat Heaters <u>0524427</u> 8 ft case (HE.4851251) <u>0524428</u> 10 ft case (HE.4851252) <u>0524429</u> 12 ft case (HE.4851253)	(9)		
B.	Optional Adjustable Refrigeration Thermostat	(2)	J.	Return Glass Anti-sweat Heaters <u>0474778</u> 8 ft case (GL.4987838) <u>0497575</u> 10 ft case (GL.4850714) <u>0474779</u> 12 ft case (GL.4987839)	(10)		
C.	Defrost Termination Thermostat (Electric Defrost only) (CT.4440611)	(3)	K.	Discharge Glass Anti-sweat Heaters <u>0465421</u> 8 ft case (GL.4978595) <u>0497576</u> 10 ft case (GL.4850715) <u>0465422</u> 12 ft case (GL.4978596)	(11)		
D.	Heater Switch (Koolgas Defrost only) (CT.4440738)	(4)	GLASS LID PARTS ARE LISTED ON PAGE 5.				
HEATERS				OPTIONAL LED FIXTURES AND POWER SUPPLY			
E.	208V Evaporator Defrost Heaters <u>3016524</u> 8 ft case (HE.4850603) <u>3016526</u> 10 ft case (HE.4850710) <u>3016527</u> 12 ft case (HE.4850571)	(5)	L.	0501213 Power Supply (EP.4481861)	(12)		
F.	208V Drip Pan Defrost Heaters, Electric <u>0462160</u> 8 ft case (HE.4850636) <u>0497581</u> 10 ft case (HE.4850711) <u>0444296</u> 12 ft case (HE.4850572)	(6)	M.	LED Fixture	(13)		
G.	120V Drip Pan Defrost Heaters, Koolgas <u>0465907</u> 8 ft case (HE.4850622) <u>0465908</u> 12 ft case (HE.4850623)	(7)					
H.	Nosing Anti-sweat Heaters <u>0524419</u> 8 ft case (HE.4851257) <u>0524420</u> 10 ft case (HE.4851258) <u>0524421</u> 12 ft case (HE.4851259)	(8)					

Data sheet-Excel FNG-L

Note: Revision D: Added high glide refrigerant note. Other changes marked by bar, underline or circle.

Engineering Plan Views

PHYSICAL DATA	
Merchandiser Drip Pipe (in.)	1 1/4
Merchandiser Liquid Line (in.)	3/8
Merchandiser Suction Line (in.)	5/8

Narrow Island Frozen Food



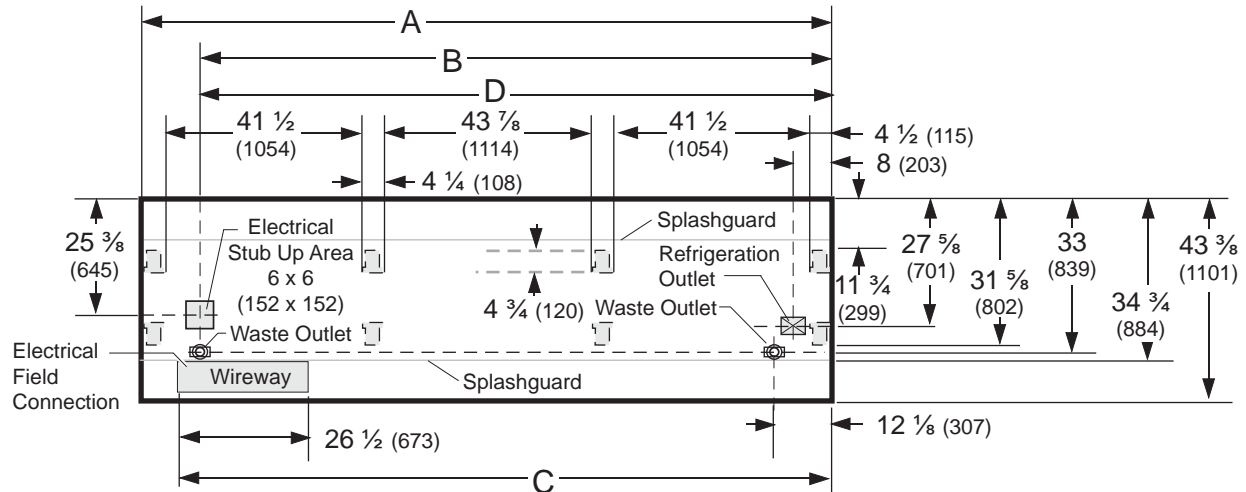

02-2012

Dimensions shown as inches & (mm).



NOTE: Case-to-Case Electrical Connections are made IN FRONT OF SPLASHGUARD.

FRONT

	8 ft	10 ft	12 ft
General			
(A) Case Length (<i>without ends or partitions</i>)	96 3/8 (2448)	120 1/2 (3061)	144 1/2 (3670)
<i>(Each end and insulated partition adds 2 in. (51 mm) to case line up.)</i>			
Maximum O/S dimension of case back to front (<i>includes bumper</i>)	43 3/8 (1101)	43 3/8 (1101)	43 3/8 (1101)
Back of case to front of splashguard	34 3/4 (884)	34 3/4 (884)	34 3/4 (884)
Back of case to O/S edge of front leg	31 5/8 (802)	31 5/8 (802)	31 5/8 (802)
Distance between edges of external legs and center legs	41 1/2 (1054)	29 1/2 (749)	41 1/2 (1054)
Distance between edges of center legs	NA	43 7/8 (1114)	43 7/8 (1114)
Distance between front legs and splashguard	3 1/8 (82)	3 1/8 (82)	3 1/8 (82)
Electrical Service  (<i>Electrical Field Wiring connection point</i>)			
(B) RH End of case to center of stub up area	84 1/4 (2141)	108 3/8 (2753)	132 3/8 (3363)
Back of case to center of stub up area	25 3/8 (645)	25 3/8 (645)	25 3/8 (645)
Length of electrical wireway 	26 1/2 (673)	26 1/2 (673)	26 1/2 (673)
(C) RH End of case to LH end of wireway	90 1/8 (2289)	114 1/4 (2902)	138 1/4 (3511)
Waste Outlets (<i>One each end</i>) 			
(D) RH End of case to the center of LH waste outlet	84 1/4 (2141)	108 3/8 (2753)	132 3/8 (3363)
RH End of case to the center of RH waste outlet	12 1/8 (307)	12 1/8 (307)	12 1/8 (307)
Back O/S of case to center of waste outlets	33 (839)	33 (839)	33 (839)
Schedule 40 PVC drip pipe	1 1/4 (32)	1 1/4 (32)	1 1/4 (32)
Refrigeration Outlet 			
Back of case to center of refrigeration outlet	27 5/8 (701)	27 5/8 (701)	27 5/8 (701)
RH end of case to center of refrigeration outlet	8 (203)	8 (203)	8 (203)

Narrow Island Display with Glass Walls and Lids



Hussmann refrigerated merchandisers configured for sale for use in the United States meet or surpass the requirements of the DOE 2017 energy efficiency standards.

Excel FNG-L
Low / Medium Temperature

REFRIGERATION DATA[§]

Note: This data is based on store temperature and humidity that does not exceed 75°F and 55% R.H.

	MED	FF	IC
Discharge Air (°F)	+32	-8	-16
Evaporator (°F)	+25	-15	-24
Unit Sizing (°F)	+23	-18	-27

[§] Average evaporator temperature shown. Use dew point for high glide refrigerants for unit sizing. Care should be taken to use the dew point in PT tables for measuring and adjusting superheat. Adjust evaporator pressure as needed to maintain discharge air temperature shown.

Btu/hr/ft*	MED	FF	IC
Parallel	130	210	230
Conventional	135	215	240

* Add 10 Btu/hr/ft for LED lighting.

DEFROST DATA

	MED	FF	IC
Frequency (hr)	24	24	24
Defrost Water (lb/ft/day)	0.3	0.29	0.25

(± 15% based on case configuration and product loading).

ELECTRIC	MED	FF	IC
Temp Term (°F)	48	48	48
Failsafe (minutes)	30	50	60

GAS	MED	FF	IC
Duration (minutes)	NA	15	18

OFFTIME Not Recommended

Standard Defrost Thermostat

Close on rise: close 48°F — open 33°F

CONVENTIONAL CONTROLS

Low Pressure Backup Control — CI/CO **

MED	+28°F / +16°F
FF	-15°F / -27°F
IC	-21°F / -33°F

Indoor Unit Only, Pressure Defrost Termination**

Not Recommended

**Use a Temperature Pressure Chart to determine PSIG conversions.

FNG-L

Dimensions shown as inches & (mm).

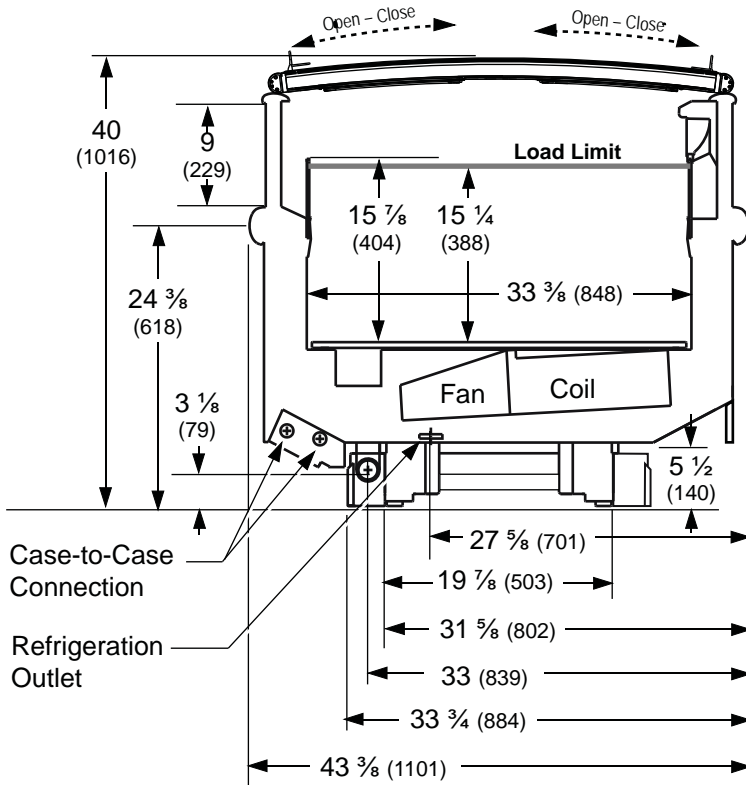

Estimated Charge (lb)***

8 ft	2.0
10 ft	2.5
12 ft	3.0

***This is an average for all refrigerant types. Actual refrigerant charge may vary by approximately half a pound.

Length Added to Lineup by Each

End or Partition (in.) 2

NSF Certification

This merchandiser model is manufactured to meet NSF/ANSI (National Sanitation Foundation) Standard #7 requirements for construction, materials & cleanability.

Excel FNG-L Low / Medium Temperature

Electrical Data

			8 ft	10 ft	12 ft			
Number of Fans – 4W Evaporator			2	2	2			
			Amperes			Watts		
			8 ft	10 ft	12 ft	8 ft	10 ft	12 ft
Evaporator Fans								
120V	50/60Hz	Standard Energy Efficient	0.24	0.24	0.24	16	16	16
230V	50/60Hz	Standard Energy Efficient	0.12	0.12	0.12	16	16	16
230V	60Hz	Export	0.30	0.30	0.30	48	48	48
230V	50Hz	Export	0.36	0.36	0.36	54	54	54
Anti-sweat Heaters (on fan circuit)								
120V	50/60Hz	Standard	0.34	0.42	0.52	41	51	62
230V	50/60Hz	Export	0.18	0.22	0.27	41	51	62
Minimum Circuit Ampacity								
120V	50/60Hz	Standard Energy Efficient	0.78	0.86	0.96			
230V	50/60Hz	Standard Energy Efficient	0.50	0.54	0.59			
230V	60Hz	Export	0.68	0.72	0.77			
230V	50Hz	Export	0.74	0.78	0.83			
Maximum Over Current Protection 120V			20	20	20			
Maximum Over Current Protection 230V			15	15	15			
Return Glass Anti-sweat Heaters								
120V	50/60Hz	Standard	0.08	0.11	0.11	9	11	13
230V	50/60Hz	Export	0.04	0.06	0.06	9	11	13
Discharge Glass Anti-sweat Heaters								
120V	50/60Hz	Standard	0.46	0.66	0.66	55	67	79
230V	50/60Hz	Export	0.24	0.34	0.34	55	67	79
208V Electric Defrost			7.69	9.61	11.54	1600	2000	2400
230V Export Electric Defrost			6.96	8.70	10.43	1600	2000	2400
120V Koolgas Defrost			1.67	2.50	3.33	200	300	400

ONLY LIGHTING CONFIGURATIONS THAT ARE COMPLIANT WITH THE U.S. DEPT. OF ENERGY (DOE) 2017 REGULATION ARE AVAILABLE FOR SALE FOR USE IN THE U.S.A.

Standard Lighting

None

Optional Lighting

LED	120V	50/60Hz	0.30	0.36	0.42	36	43	50
LED	230V	50/60Hz	0.17	0.19	0.22	36	43	50

Please note: some combinations of fluorescent lights on this case model may not be compliant with DOE 2017 and may not be available to order in the US and Canada. More lighting options are available with LED lights. The Hussmann Product Configurator will not allow lighting options that do not comply with the DOE 2017 standards.

Product Data

Recommended Usable Cube ¹ (Cu Ft/Ft)	3.69 ft ³ /ft (0.34 m ³ /m)
AHRI Total Display Area ² (Sq Ft/Ft)	3.35 ft ² /ft (1.02 m ² /m)
Shelf Area ³ (Sq Ft/Ft)	2.79 ft ² /ft (0.85 m ² /m)

- ¹ AHRI Refrigerated Volume less shelving and other unusable space: Refrigerated Volume/Unit of Length, ft³/ft [m³/m]
² Computed using AHRI 1200 standard methodology: Total Display Area, ft² [m²]/Unit of Length, ft [m]
³ Shelf surface area is composed of bottom deck plus standard shelf complement, as shown in the Hussmann **Product Reference Guide**. The standard shelf complement for this model is NONE.

ESTIMATED SHIPPING WEIGHT ⁴

Case	4 ft	6 ft	8 ft	12 ft	Solid End (each)
lb (kg)	673 (306)	905 (411)	1140 (517)	1400 (636)	50 (23)

⁴ Actual weights will vary according to optional kits included.

Glass Lid Replacement Parts

FN4L, FN8L, FN12L GLASS ASSEMBLIES

- S. 0524244 Top Glass - Fixed B00153 (GL.4998369)
- T. 0524245 Middle Glass with Handle B00154 (GL.4998370)
- U. 0524246 Bottom Glass with Handle B00155 (GL.4998371)

FN6L GLASS ASSEMBLIES

- S. 0524256 Top Glass - Fixed B00165 (GL.4998372)
- T. 0524257 Middle Glass with Handle B00166 (GL.4998373)
- U. 0524258 Bottom Glass with Handle B00167 (GL.4998374)

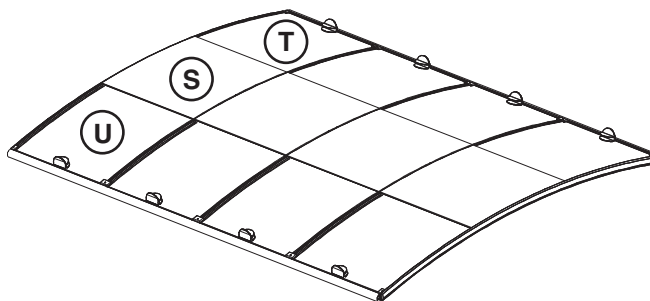

Electric Defrost – Standard

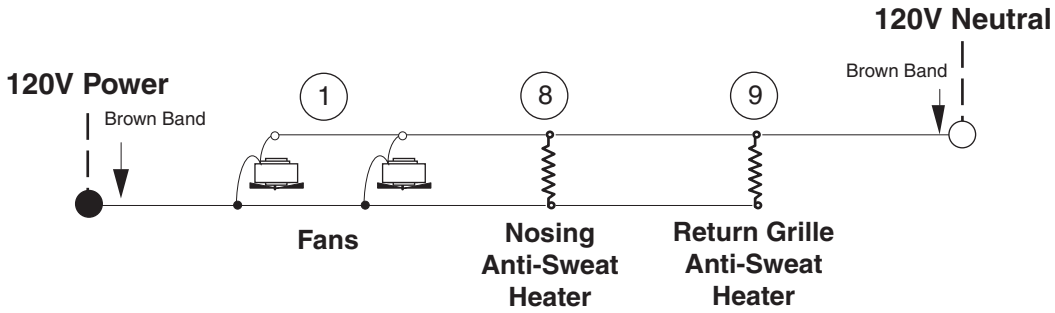

Refrigeration Thermostat (Optional)

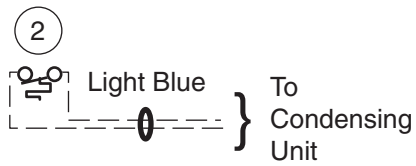

Defrost Termination Thermostat

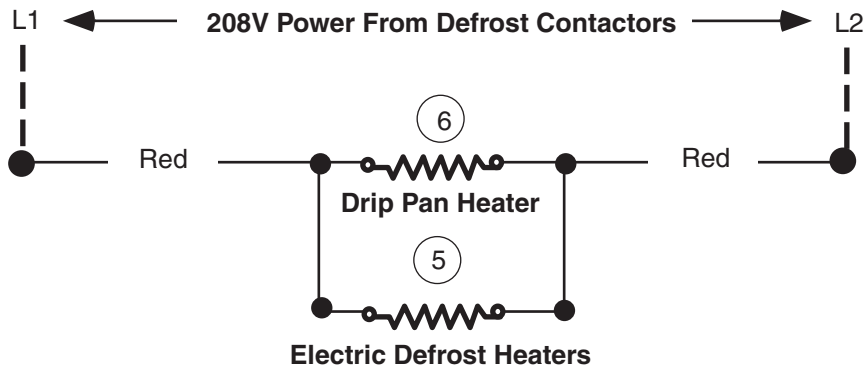

Return Class Anti-Sweat Heater

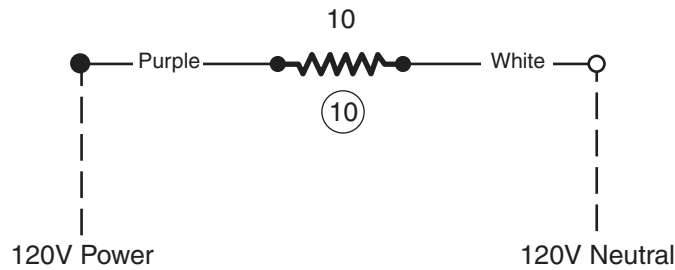

WARNING

All components must have mechanical ground, and the merchandiser must be grounded.
 Circled Number = Parts List Item Numbers

Gas Defrost – Optional

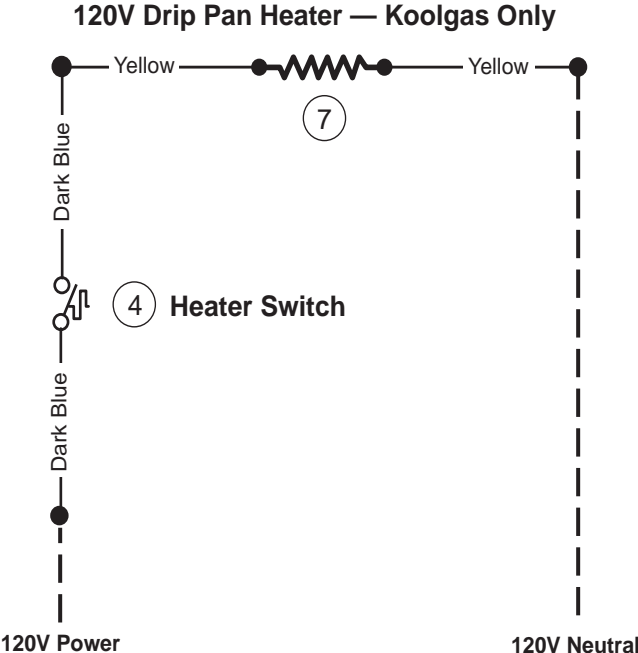

WARNING

All components must have mechanical ground, and the merchandiser must be grounded.
Circled Number = Parts List Item Numbers

Optional LED Lighting Wiring Diagrams

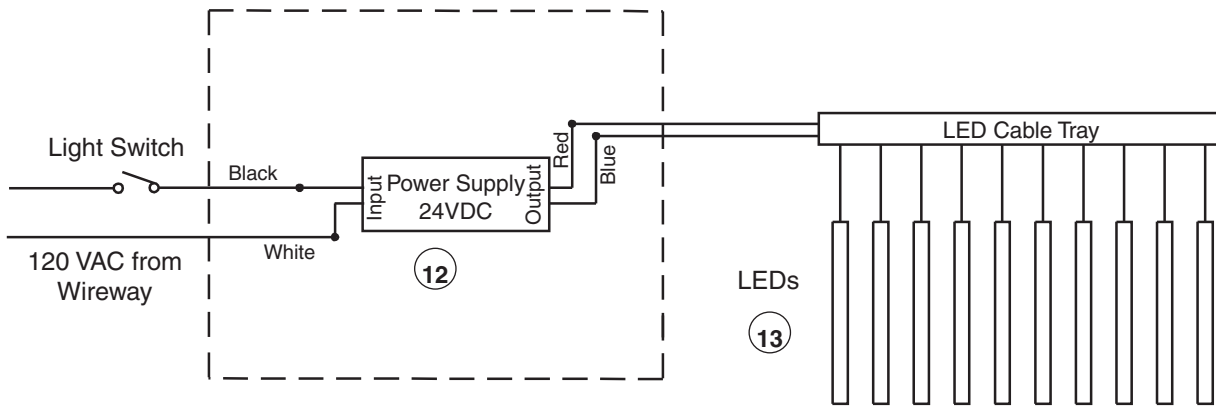

FN8GL LED Wiring Diagram

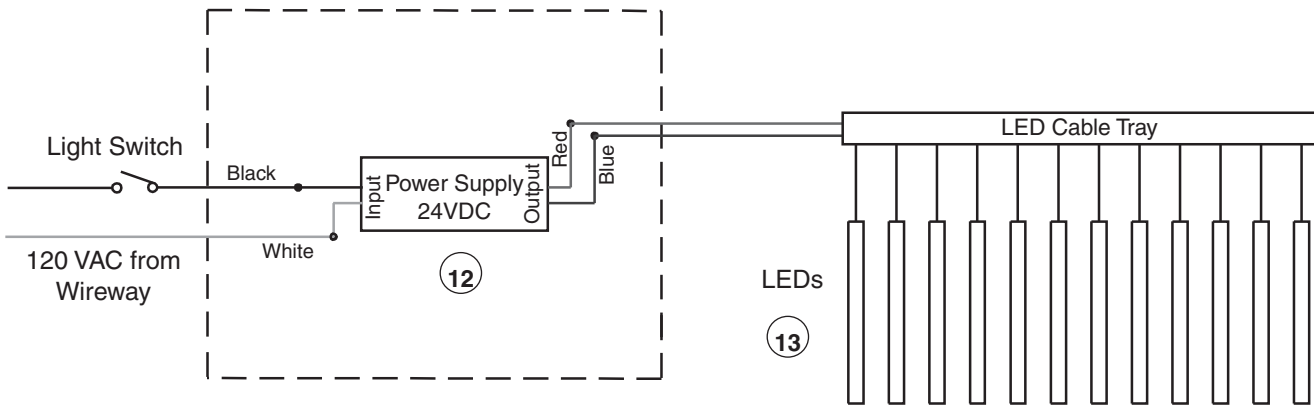

**FN10GL
LED Wiring Diagram**

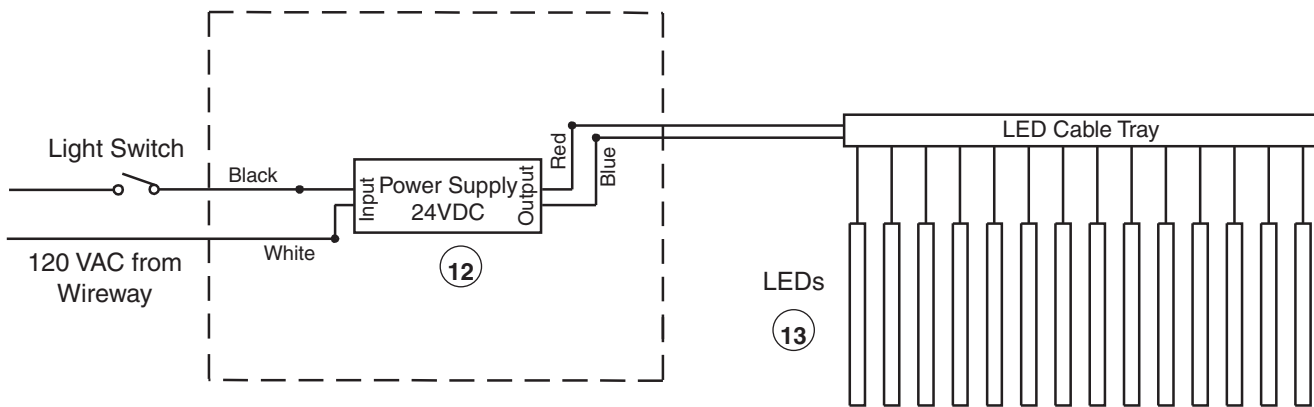

FN12GL LED Wiring Diagram