



OPERATING AND MAINTENANCE MANUAL TANKLESS TXA, ETXA AND MTXA

8/1/23



-IMPORTANT-

Always reference the full model number and serial number when calling the factory.

HUBBELL ELECTRIC HEATER COMPANY
45 SEYMOUR STREET
STRATFORD, CT 06615

PHONE: (203) 378-2659
FAX: (203) 378-3593
Hubbellheaters.com

Table of Contents

SECTION I – TANKLESS WATER HEATER OPERATING PRINCIPLE	4
SECTION II – GENERAL DESCRIPTION AND CONSTRUCTION	5
Technical Specifications Common to All Models:	5
Product Overview TXA/MTXA:	5
Product Overview ETXA:	6
Tankless Water Heater Maximum Flow Rates:	7
Formulas:	8
SECTION III – INSTALLATION	9
Choosing location and Mounting Instructions:.....	9
Mounting the unit:.....	9
Plumbing Installation Instructions:	10
IMPORTANT INFORMATION:	10
Flushing the Line:	10
Checking for Leaks and Purging Air:.....	10
Typical Accessory Piping	11
Electrical Installation Instructions.....	12
WIRING DIAGRAMS:.....	13
SECTION IV – TROUBLESHOOTING	27
Advanced Troubleshooting:	28
Tools Required:	28
Pre-Operational Procedures:	28
Check the Power Supply to the Unit:	28
Check the Transformer:	29
Check the Hi-Limit Thermostats:.....	29
Check the Thermistor:.....	30
Check the Flow Meter:.....	31
Check the Temperature Controller: TK2000 Control Board.....	32
Check the Temperature Controller: TK2250 Control Board.....	32
Check the Triacs (Step 1):.....	33
Check the Heating Elements:	33
Check the Triacs (Step 2):.....	33
SECTION V - SCHEDULED MAINTENANCE	35
First Use of your Hubbell Tankless Water Heater:	35
Temperature Controller User Interface Instructions:	35
Configuration Menu	36

Remote Display:	38
Power and Triac Wiring.....	40
SECTION VI - SERVICING & REPLACEMENT OF PARTS	42
Heating Element:	42
Hi-Limit Switch:	42
Inlet Thermistor:	43
Outlet Thermistor:	43
Temperature Controller:.....	43
Triac:	44
Flow Meter:.....	44
Magnetic Contactor:	45
Transformer:	45
Control Fuse:.....	45
Low Water Cut off (LWCO):.....	46
Low Water Cut off (LWCO) Probe:	46
PARTS LIST.....	47
SECTION VII – WARRANTY	48

Important Safety Information

1. You must read and follow all instructions. Serious bodily injury or death could occur if you ignore this warning.
2. All circuit breakers and/or disconnect switches serving the heater must be turned off when installing, uninstalling, or repairing this water heater.
3. The Hubbell Tankless Water Heater must be grounded.
4. The unit must be installed by a licensed electrician and plumber.
5. The unit must be wired in accordance with the current version of the National Electrical Code (US) or Canadian Electric Code (Canada).
6. This installation must comply with all national, state, and local plumbing and electrical codes.
7. When the heater is not within sight of the electrical circuit breakers, an additional local means of disconnection of all ungrounded conductors must be provided that is within sight of the appliance or a circuit breaker lockout must be used. (Ref. NEC 422.31)
8. If the Hubbell Tankless Water Heater is installed in a location where water damage could occur in the event of a leak, it is recommended that a drip pan be installed and connected to a suitable drain. Alternatively, an active water leak detector and shut off valve can be installed to turn off your water supply in the event a leak is detected.
9. It is recommended that water hardness levels in excess of 12 grains per gallon [approx. 200ppm (mg/l)] be treated prior to entering the water heater. Unless treated, water at or above this hardness level will cause scaling which will significantly impact the water heater performance.
10. When the heater is installed in a well water system or if the plumbing system is prone to introducing air into the heater, it is highly recommended that an air separator be installed in the cold-water feed to the heater to avoid possible failure of the heating element and/or heating chamber.

SECTION I – TANKLESS WATER HEATER OPERATING PRINCIPLE

How the Hubbell Tankless Water Heater Works:

For the most part, operating the new tankless water heater is very similar to using any traditional water heater system. *However, it is very important that all the set-up procedures and operating instructions are carefully read to ensure maximum performance and energy savings from the new water heater.*

The Hubbell TXA Series Water Heater does not store hot water like a conventional tank-type water heater. It contains high powered heating elements that are capable of heating water instantly on-demand as needed. Due to these high-powered elements, dry firing the TXA series heater is a possibility. To prevent this, a low water detection system has been installed to keep the elements from turning on if the unit has not been properly purged of air.

Once the air has been purged and as soon as there is a hot water demand, a sophisticated flow sensor within the heater recognizes the demand and initiates the heating process. This sensor measures the water flow rate while two other sensors measure the incoming and outgoing water temperature. This information is transmitted continually to the microprocessor controller which determines the precise amount of power to send to the heating elements to heat the water to the desired temperature. The Hubbell tankless water heater only uses as much power as is needed to meet the demand by fully modulating the heating elements from 0 to 100%.

It is important to keep in mind that all tankless water heaters are subject to a maximum flow rate. If this flow rate is exceeded, the heater will not be capable of fully heating water. The amount of water that can be heated by the tankless water heater at any given time will depend on the model selected and the incoming water temperature. See the charts in Section II to determine the maximum flow rates.

Moreover, since a tankless water heater eliminates the ongoing thermal losses caused by storing hot water in a tank, there will be a significant energy savings compared to a conventional tank type water heater.

SECTION II – GENERAL DESCRIPTION AND CONSTRUCTION

Technical Specifications Common to All Models:

Materials:	Stainless Steel Exchanger and Casing	Plumbing Connection:	Low Flow	1" FNPT
Energy Efficiency:	98%		High Flow	1" FNPT
Voltage:	208-600Volts	Operating Range:	5 – 150 psi	
Frequency:	50 / 60 Hz	Protection:	Thermal Auto Reset	

Product Overview TXA/MTXA:

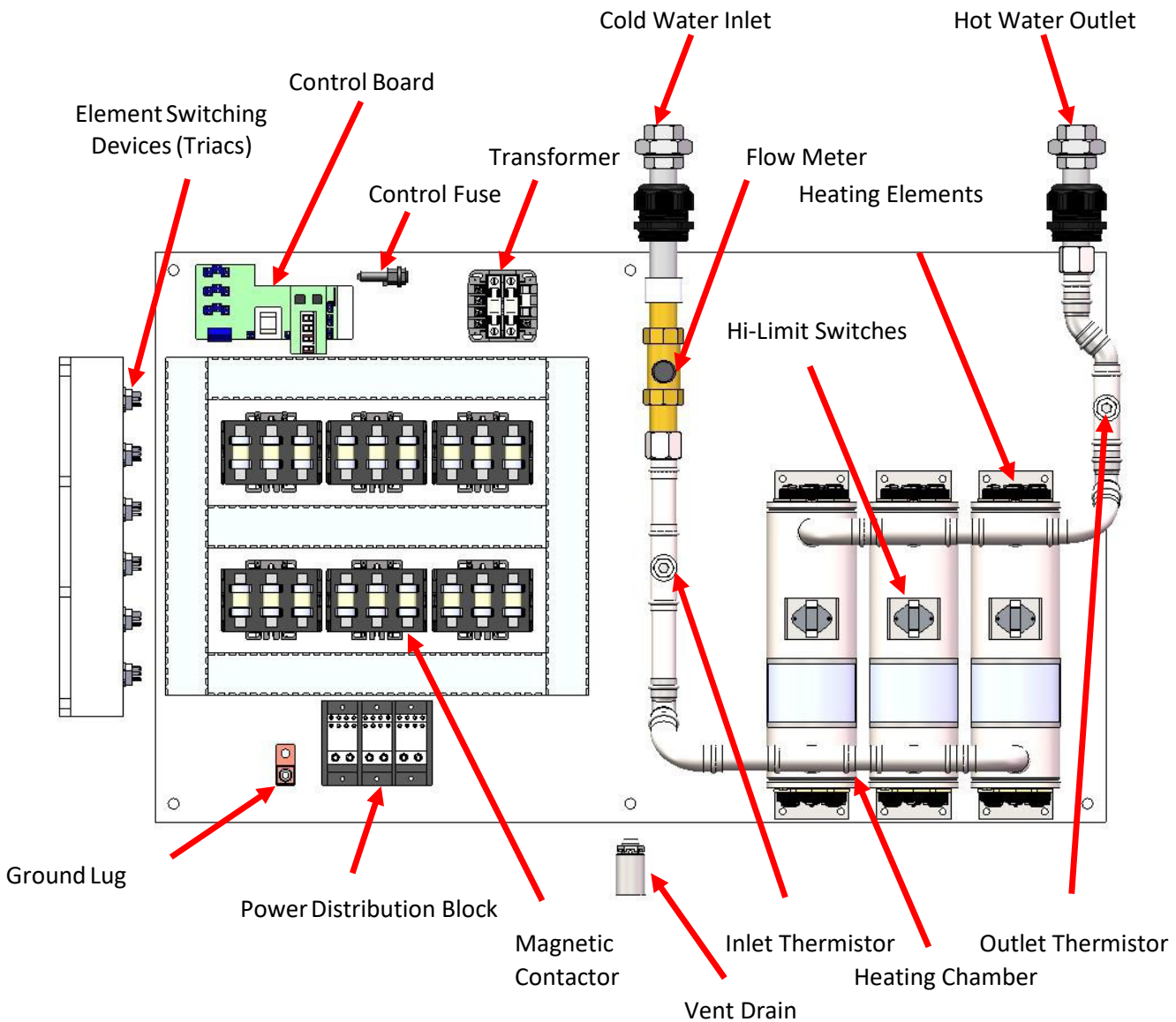

Notes:

1. Transformers are only installed on 3-phase models over 240 volts.
2. System components and layout are subject to change without notice.

Product Overview ETXA:

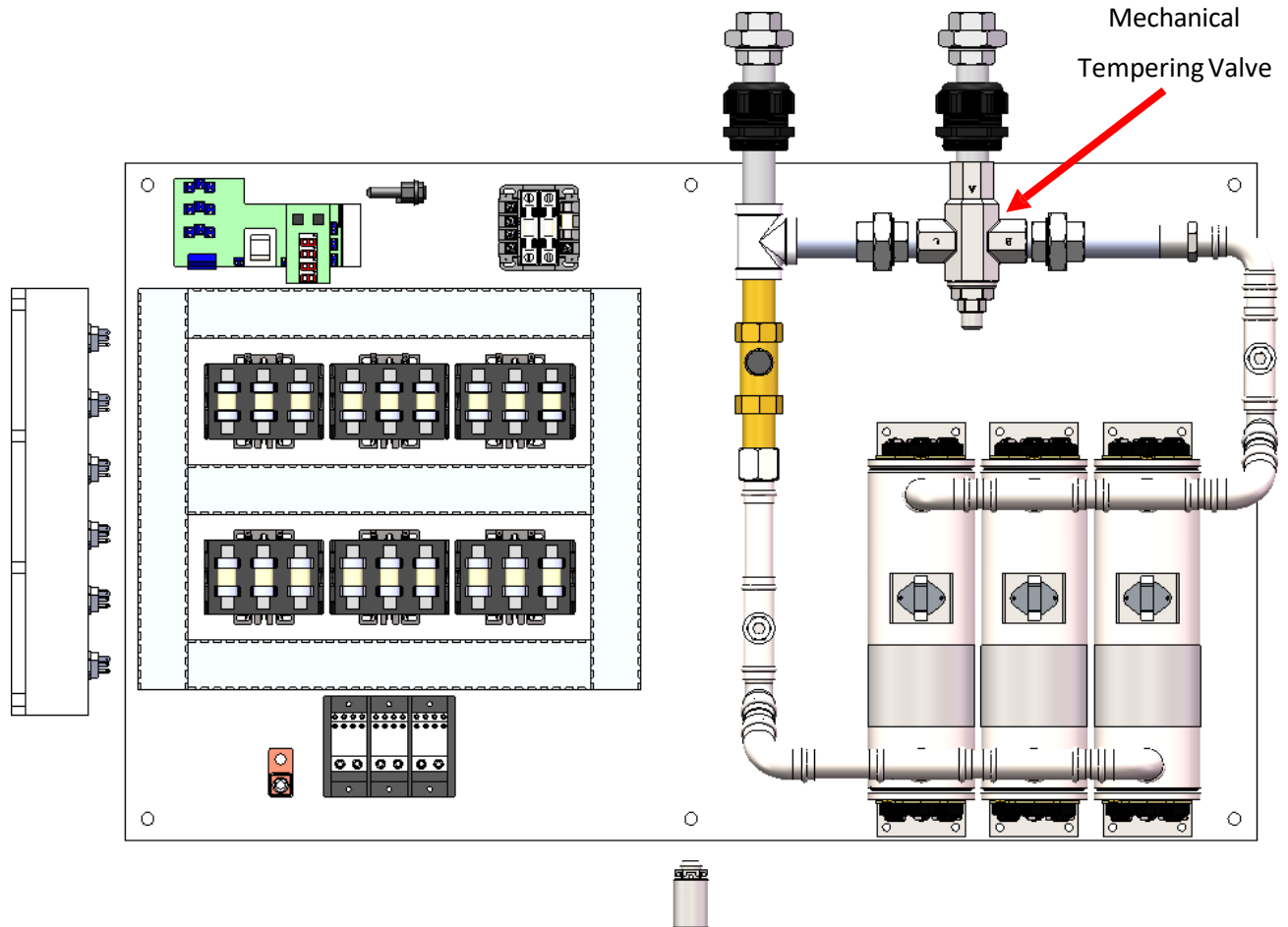

Notes:

1. Construction of ETXA is similar to TXA, with the addition of a mechanical tempering valve, factory set at 85°F.
2. System components and layout are subject to change without notice.

Tankless Water Heater Maximum Flow Rates:

		Maximum Flow Rate (GPM) at Temperature Rise ($F_{\Delta T}$)											
		5	10	20	30	40	50	60	70	80	100	120	140
KW Power (KW)	5	6.8	3.4	1.7	1.1	0.9	0.7	0.6	0.5	0.4			
	6	8.2	4.1	2.0	1.4	1.0	0.8	0.7	0.6	0.5	0.4		
	7	9.6	4.8	2.4	1.6	1.2	1.0	0.8	0.7	0.6	0.5		
	8	10.9	5.5	2.7	1.8	1.4	1.1	0.9	0.8	0.7	0.5	0.5	
	9	12.3	6.1	3.1	2.0	1.5	1.2	1.0	0.9	0.8	0.6	0.5	0.4
	10	13.7	6.8	3.4	2.3	1.7	1.4	1.1	1.0	0.9	0.7	0.6	0.5
	12	16.4	8.2	4.1	2.7	2.0	1.6	1.4	1.2	1.0	0.8	0.7	0.6
	14	19.1	9.6	4.8	3.2	2.4	1.9	1.6	1.4	1.2	1.0	0.8	0.7
	16	21.8	10.9	5.5	3.6	2.7	2.2	1.8	1.6	1.4	1.1	0.9	0.8
	18	24.6	12.3	6.1	4.1	3.1	2.5	2.0	1.8	1.5	1.2	1.0	0.9
	20	27.3	13.7	6.8	4.6	3.4	2.7	2.3	2.0	1.7	1.4	1.1	1.0
	24	32.8	16.4	8.2	5.5	4.1	3.3	2.7	2.3	2.0	1.6	1.4	1.2
	25	34.1	17.1	8.5	5.7	4.3	3.4	2.8	2.4	2.1	1.7	1.4	1.2
	27	36.9	18.4	9.2	6.1	4.6	3.7	3.1	2.6	2.3	1.8	1.5	1.3
	30		20.5	10.2	6.8	5.1	4.1	3.4	2.9	2.6	2.0	1.7	1.5
	31		21.2	10.6	7.1	5.3	4.2	3.5	3.0	2.6	2.1	1.8	1.5
	33		22.5	11.3	7.5	5.6	4.5	3.8	3.2	2.8	2.3	1.9	1.6
	36		24.6	12.3	8.2	6.1	4.9	4.1	3.5	3.1	2.5	2.0	1.8
	40		27.3	13.7	9.1	6.8	5.5	4.6	3.9	3.4	2.7	2.3	2.0
	42		28.7	14.3	9.6	7.2	5.7	4.8	4.1	3.6	2.9	2.4	2.0
	48		32.8	16.4	10.9	8.2	6.6	5.5	4.7	4.1	3.3	2.7	2.3
	50		34.1	17.1	11.4	8.5	6.8	5.7	4.9	4.3	3.4	2.8	2.4
	54		36.9	18.4	12.3	9.2	7.4	6.1	5.3	4.6	3.7	3.1	2.6
	60			20.5	13.7	10.2	8.2	6.8	5.9	5.1	4.1	3.4	2.9
	63			21.5	14.3	10.8	8.6	7.2	6.1	5.4	4.3	3.6	3.1
	66			22.5	15.0	11.3	9.0	7.5	6.4	5.6	4.5	3.8	3.2
	70			23.9	15.9	11.9	9.6	8.0	6.8	6.0	4.8	4.0	3.4
	72			24.6	16.4	12.3	9.8	8.2	7.0	6.1	4.9	4.1	3.5
	75			25.6	17.1	12.8	10.2	8.5	7.3	6.4	5.1	4.3	3.7
	81			27.6	18.4	13.8	11.1	9.2	7.9	6.9	5.5	4.6	3.9
84			28.7	19.1	14.3	11.5	9.6	8.2	7.2	5.7	4.8	4.1	
95			32.4	21.6	16.2	13.0	10.8	9.3	8.1	6.5	5.4	4.6	
96			32.8	21.8	16.4	13.1	10.9	9.4	8.2	6.6	5.5	4.7	
99			33.8	22.5	16.9	13.5	11.3	9.7	8.4	6.8	5.6	4.8	
108			36.9	24.6	18.4	14.7	12.3	10.5	9.2	7.4	6.1	5.3	
116			39.6	26.4	19.8	15.8	13.2	11.3	9.9	7.9	6.6	5.7	
126				28.7	21.5	17.2	14.3	12.3	10.8	8.6	7.2	6.1	
144				32.8	24.6	19.7	16.4	14.0	12.3	9.8	8.2	7.0	
162				36.9	27.6	22.1	18.4	15.8	13.8	11.1	9.2	7.9	

For alternate power (kW) values, the maximum flow rate can be calculated using the formulas on the following page.

Formulas:

Wattage De-rating Formula:

$$\frac{\text{Applied Voltage}^2}{\text{Rated Voltage}^2} \times \text{Rated Wattage} = \text{Actual Wattage}$$

For example: If installing a 27-kW unit when actual voltage is 212 V,

$$\frac{212^2}{240^2} = \frac{44,944}{57,600} = 0.78 \times 27,000 \text{ W} = 21,060 \text{ W @ 212 V}$$

Amperage Formula:

$$\frac{\text{Watts}}{\text{Volts}} = \text{Amps (Single Phase)}$$

$$\frac{\text{Watts}}{\text{Volts}} \div 1.73 = \text{Amps (3-Phase)}$$

Flow Rate Formulas:

To determine power (kW) requirement

$$\text{GPM} \times \text{°F } \Delta T \times 0.1465 = \text{kW}$$

To determine temperature rise

$$\text{kW} \times 6.824 \div \text{GPM} = \text{°F } \Delta T$$

To determine flowrate

$$\text{kW} \times 6.824 \div \text{°F } \Delta T = \text{GPM}$$

SECTION III – INSTALLATION

WARNING: SERIOUS BODILY INJURY OR DEATH MAY OCCUR IF THE FOLLOWING WARNINGS ARE IGNORED.

- All circuit breakers and/or disconnect switches servicing this heater must be turned off before installing, repairing or uninstalling this water heater.
- Installation **MUST** be done by a licensed electrician and licensed plumber.

Choosing location and Mounting Instructions:

The Hubbell TXA series tankless water heater can be installed just about anywhere. However, there are some important guidelines to follow that will ensure that the installation is both safe and convenient if future servicing is required.

The unit may be installed in either indoor or outdoor locations due to the NEMA 4 -12 enclosure rating, that protects it from rain, splashed water, direct sunlight, debris, and insects. *This product should NOT be installed in a location where it may be subject to freezing temperatures.* If the water inside the tankless water heater freezes, it can cause severe and permanent damage that is not covered under the warranty. If you suspect that the tankless water heater may have frozen, do not turn on the heater until it has thawed, and it has been inspected for damage. (Hubbell has options for internal heaters for low ambient conditions.)

When selecting an installation location, consider the existing plumbing configuration, the location of your main electrical panel, and location of the point of use. Try to choose a location that does not require major plumbing alterations, that is close to the main electrical panel (this will reduce the amount of wire needed to install), and that is physically close to the hot water fixtures. By locating the heater close to the points of use, this will reduce the amount of time it takes for the hot water to travel from the water heater to the point of use. Consideration should also be given to future servicing. *Do NOT locate the water heater in a location that is difficult to access or on a horizontal surface, like the ceiling or floor. This will affect the operation of the high limits.*

Avoid installing the tankless water heater in a location prone to excessive humidity, moisture, or dust, or in an area where it may be splashed with corrosive liquids. DO NOT install under water pipes or air conditioning lines that might leak or condense moisture that could then drip onto the heater. Do NOT install above electrical boxes or junctions.

If installation of the water heater is such that leaks may cause water damage, make sure that all code requirements for such installations as required for your area are followed. Hubbell recommends that a drip pan (connected to a drain) is installed below the water heater to avoid property damage in the unlikely event of a leak. Alternatively, an active water leak detector and shut-off valve designed to turn off the water supply if a leak is ever detected may be installed.

Mounting the unit:

- Leave a minimum of 12" to both sides 11" on the bottom and 36" in front of the unit.
- Mount the water heater securely to the wall by putting four (4) screws through the mounting holes.
- Install a ¼" diameter bead of sealing caulk around the entire perimeter of the heater between the heater back panel and the wall. This prevents any moisture or debris from accumulating.

Plumbing Installation Instructions:

IMPORTANT INFORMATION:

- Ensure all fitting installations comply with local plumbing and building codes.
- This water heater does not require a temperature and pressure (T&P) relief valve. You may install a T&P relief valve if the county, city or state plumbing code requires it.
- Installations in the Commonwealth of MASSACHUSETTS and KENTUCKY require a T&P relief valve.
- It is recommended that this unit be installed in plumbing systems that use copper or stainless-steel piping only. If using plastic piping such as PEX or PVC is required, then contact the Hubbell Heater for more information.
- **WARNING:** *DO NOT SOLDER ANY PIPING WHILE THE UNIT IS CONNECTED TO THE PIPING. DOING SO WILL DAMAGE THE FLOW METER AND VOID YOUR WARRANTY.*
- Before energizing the heater, run water for a minimum of three (3) minutes and verify that all air has been removed.
- Installation of an air separator device is recommended for installations where air can be easily introduced into the water system (i.e., Well water systems, lake pumps, and other municipal systems).
- Shut off valves **MUST** be installed on both the inlet side and outlet piping of the unit.
- **WARNING:** *DO NOT SUPPLY WATER TO THE UNIT THAT IS HOTTER THAN 130°F.*

Flushing the Line:

- Before connecting the copper pipe to the water heater, it is extremely important to flush the lines to eliminate all plumbing paste, residue, or debris in the lines and damaging the flow meter.
- After completing plumbing installation, open the hot water faucet and allow water to run through the water heater for at least three (3) minutes, cycling the flow on and off every minute. This process clears all the air from the lines and must be performed prior to turning on the power at the unit. **WARNING:** *FAILURE TO DO THIS MAY DAMAGE THE FLOW METER AND/OR HEATING ELEMENTS AND WILL VOID YOUR WARRANTY.*

Checking for Leaks and Purging Air:

- Verify circuit breakers and service disconnect supplying power to the unit are turned off.
- Open all hot water taps supplied by the unit and inspect water connections for leaks.
- **With all hot water taps still open, allow the water to run for a minimum of 3 minutes.** Inspect each tap to ensure all air in the lines has been purged. This process purges all the air from the water lines and **MUST** be performed prior to turning on the power at the unit. **WARNING:** *FAILURE TO FOLLOW THIS STEP CAN CAUSE PERMANENT DAMAGE TO THE HEATING ELEMENTS.*
- Close all hot water taps.

Typical Accessory Piping

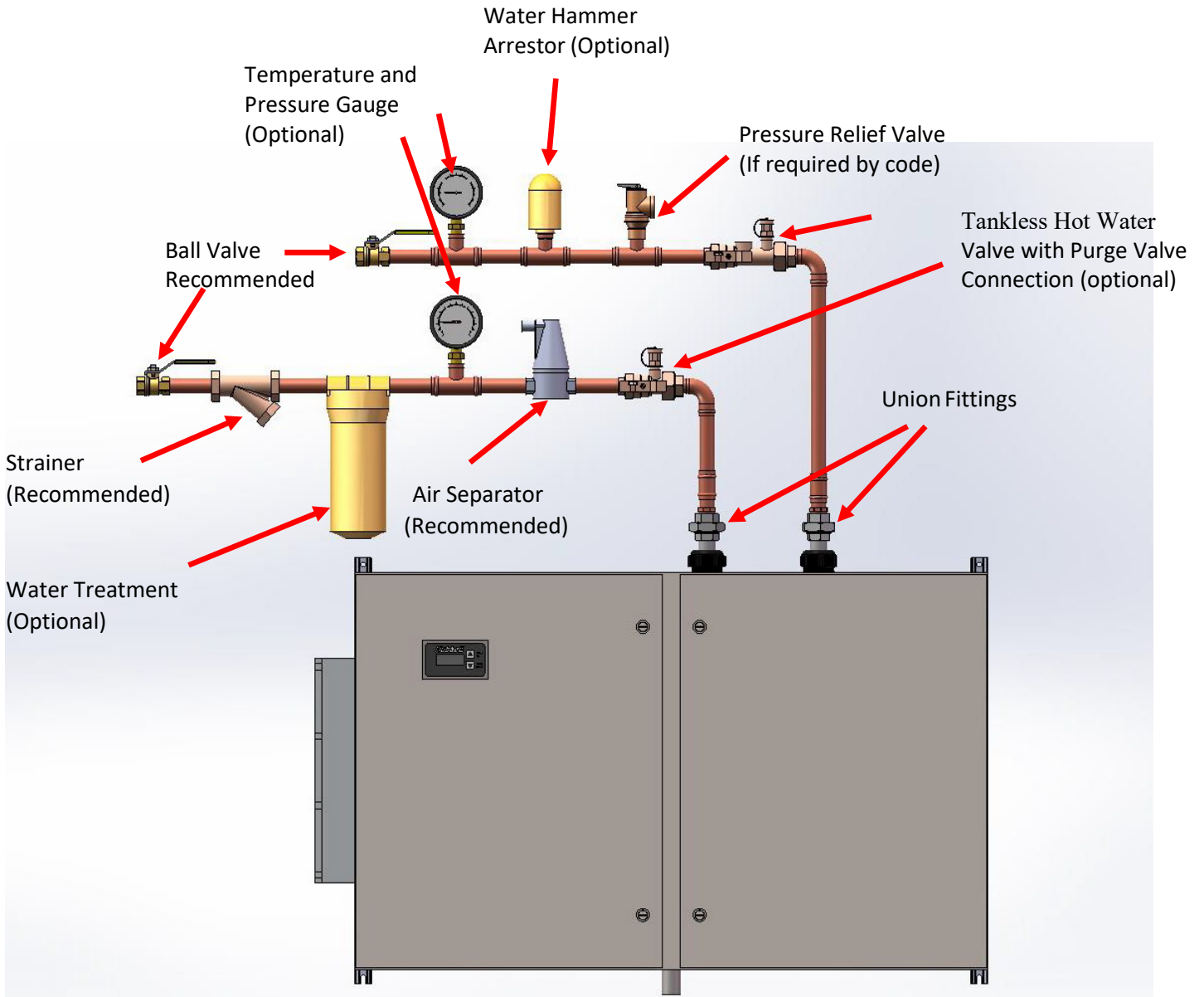

Electrical Installation Instructions



IMPORTANT INFORMATION:

- The unit must be wired in accordance with the current version of the National Electrical Code (US) or Canadian Electric Code (Canada).
- The unit must have its own independent circuits.
- When the heater is not within sight of the electrical circuit breakers, an additional local means of disconnection (service disconnect) of all ungrounded conductors must be provided that is within sight of the appliance or a circuit breaker lockout must be used. (Ref. NEC 422.31)
- For Canada, per Canadian Electric Code, C22.1-02, the unit must be wired by a single feed installation with one (1) three-pole circuit breaker.
- For US, the unit may be wired by a single feed installation with one (1) three-pole circuit breaker or by a multiple feed installation with multiple double-pole circuit breakers.

Wiring to the water heater:

- Connect the power wire from the main panel to the power distribution block or magnetic contactor as applicable.
- Connect the main ground wire to the ground lug in the heater.
- Make sure the connections are securely tightened.

Electrical Specifications:

- Tankless water heaters are considered a non-continuous load.
- If a multiple feed installation is used, it is acceptable to install up to two conductors in one-line side port. Additionally, when a power distribution block is supplied, additional conductors may be installed in an open load side port of the power distribution block.
- Wiring sizing listed is for 75°C THHN. 60°C or 90°C wire may be used. Refer to NFPA70 table 310.15 (B) for proper sizing.
- Wiring penetrations are recommended in bottom of heater.
- Conductors should be sized to maintain a voltage drop of less than 3% under load.

Tankless Wiring Diagram 1C (Delta)

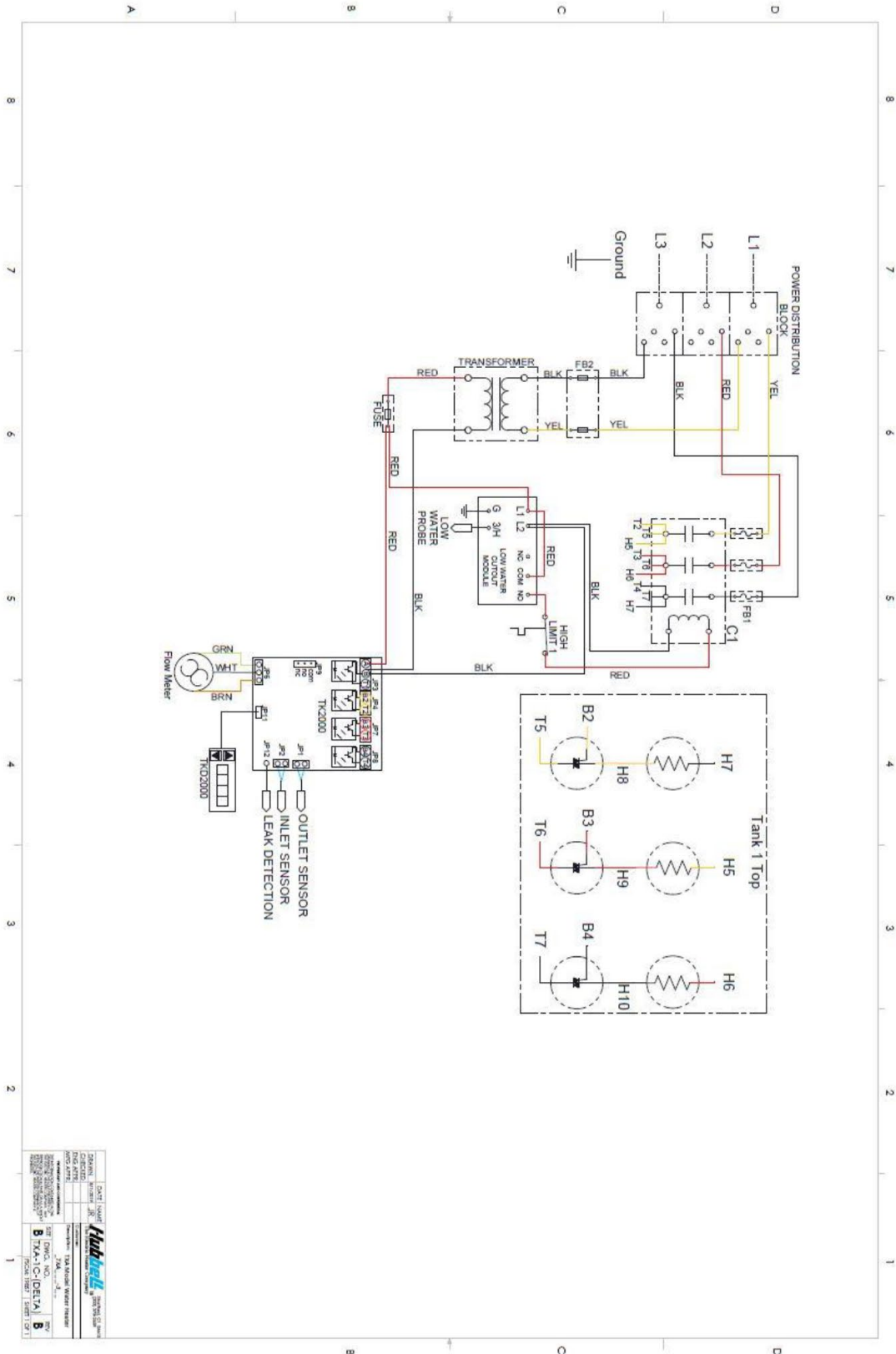

DATE	1/20/11	BY	W. J. HUBBELL
DESIGN	W. J. HUBBELL	CHKD	W. J. HUBBELL
REVISED	1/20/11	BY	W. J. HUBBELL
DATE	1/20/11	BY	W. J. HUBBELL
PROJECT	TXA-C-DELTA		
DESCRIPTION	WATER HEATER		
REVISIONS	1. 1/20/11 W. J. HUBBELL 2. 1/20/11 W. J. HUBBELL		

Tankless Wiring Diagram 1F

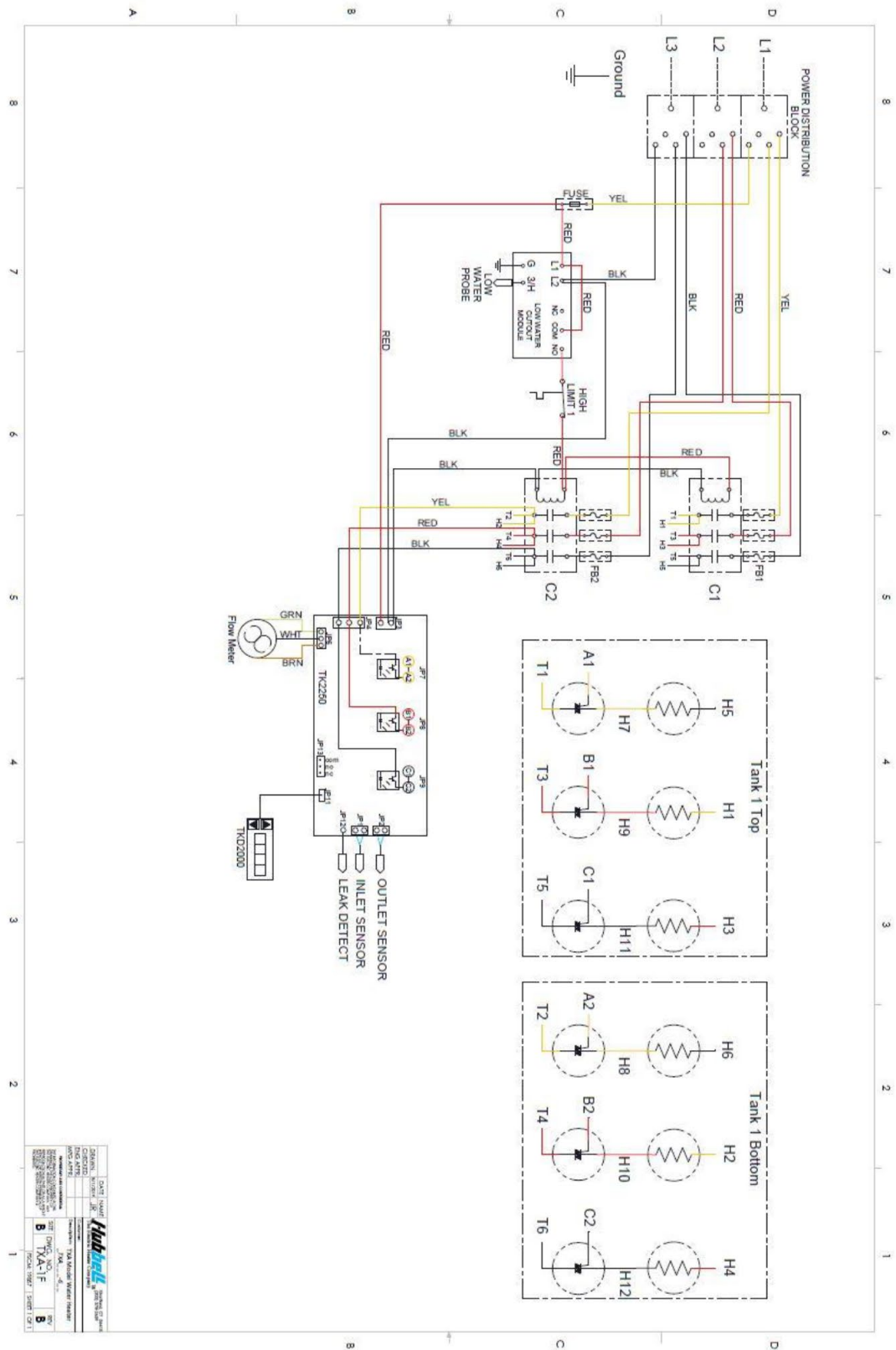

Tankless Wiring Diagram 1G (Delta)

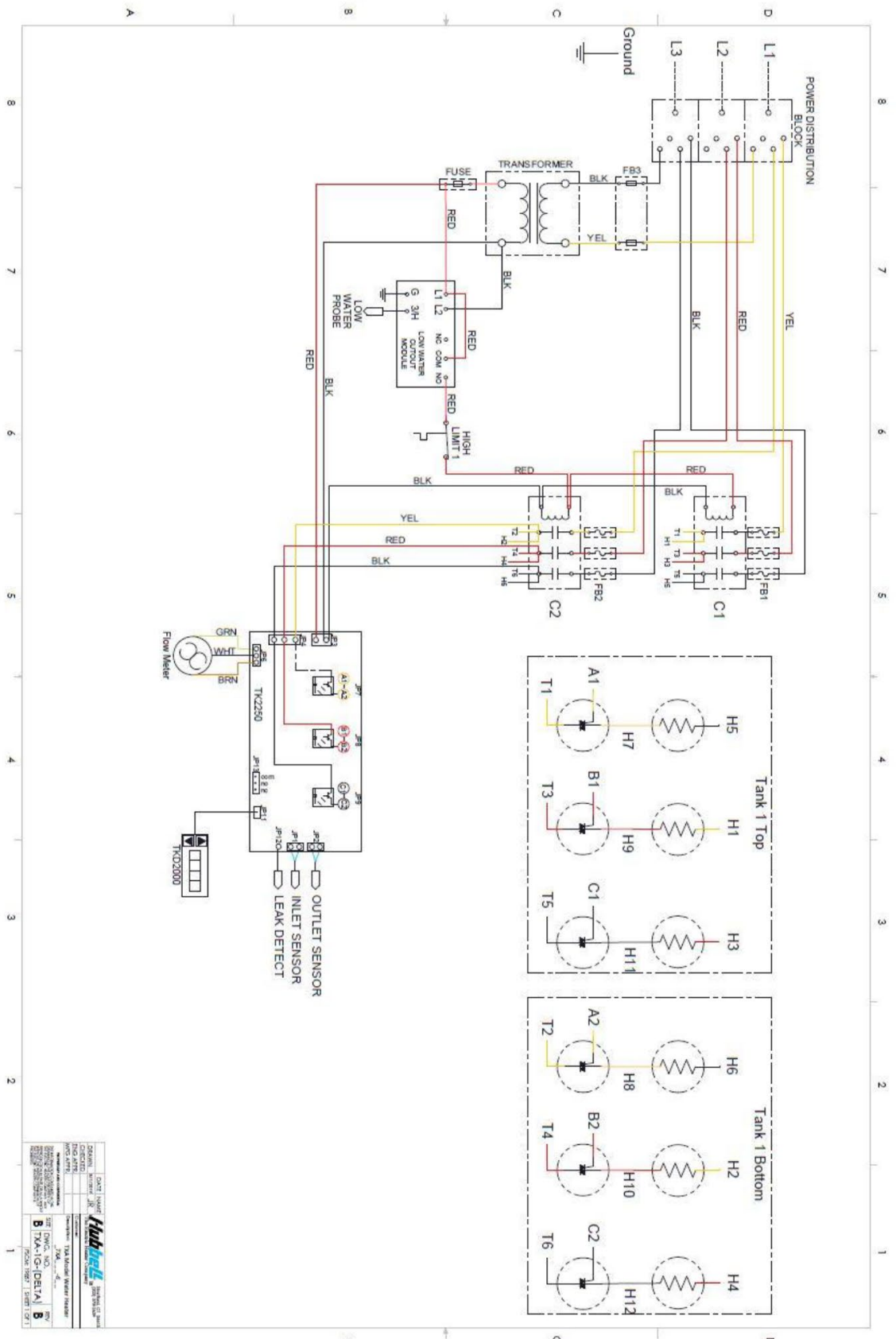

Tankless Wiring Diagram 1G (Wye)

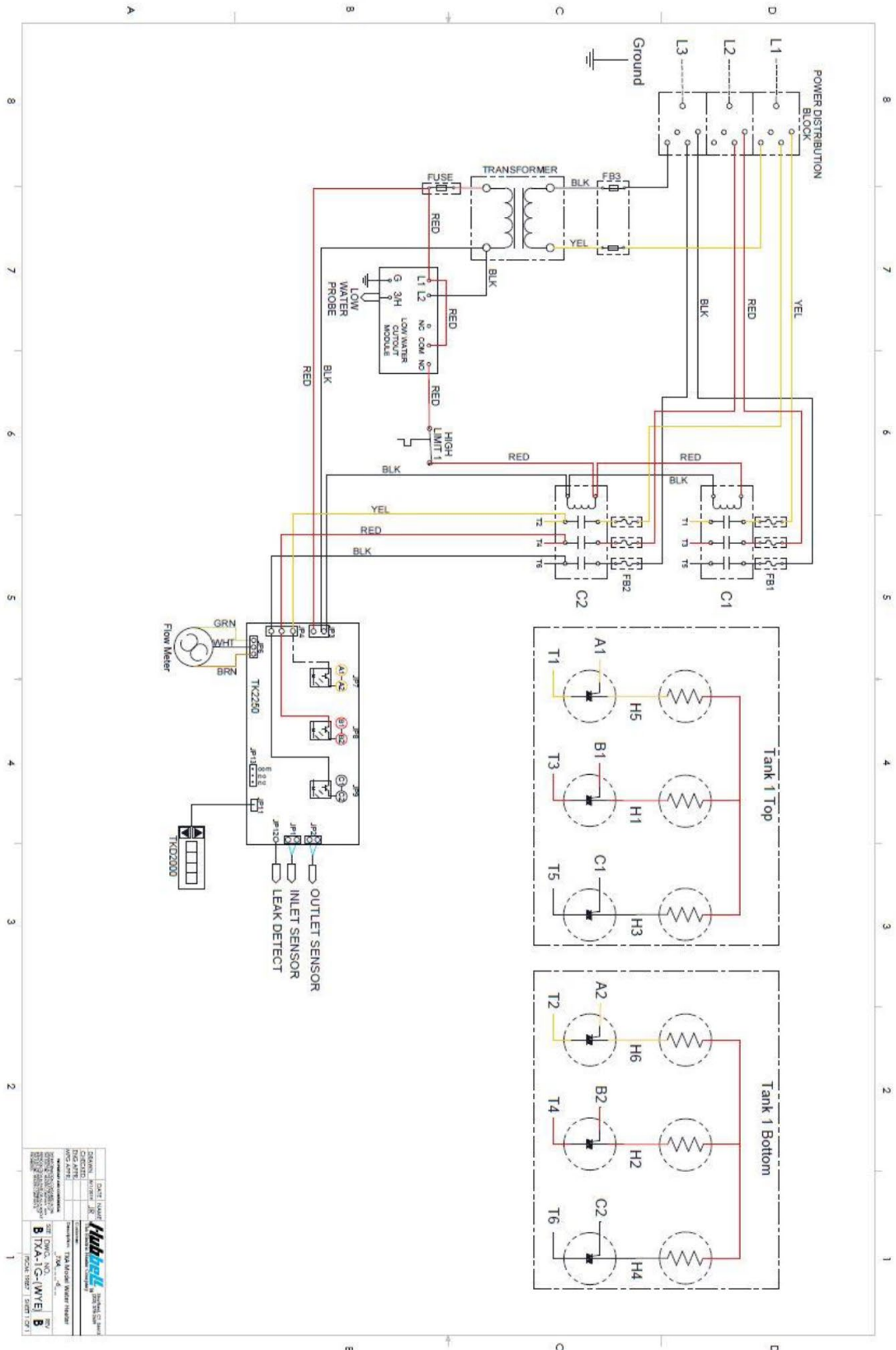

DATE	1/1/2011	DESIGNER	JK
REV	1	DATE	1/1/2011
Hubbell A THOMSON COMPANY 10000 W. 10th Ave., Suite 100 Denver, CO 80202 TEL: 303.440.2000 FAX: 303.440.2001 WWW.HUBBELL.COM			
TANKLESS WATER HEATER MODEL NO. TXA-1G-WYE SERIAL NO. 15871371			

Tankless Wiring Diagram 2D

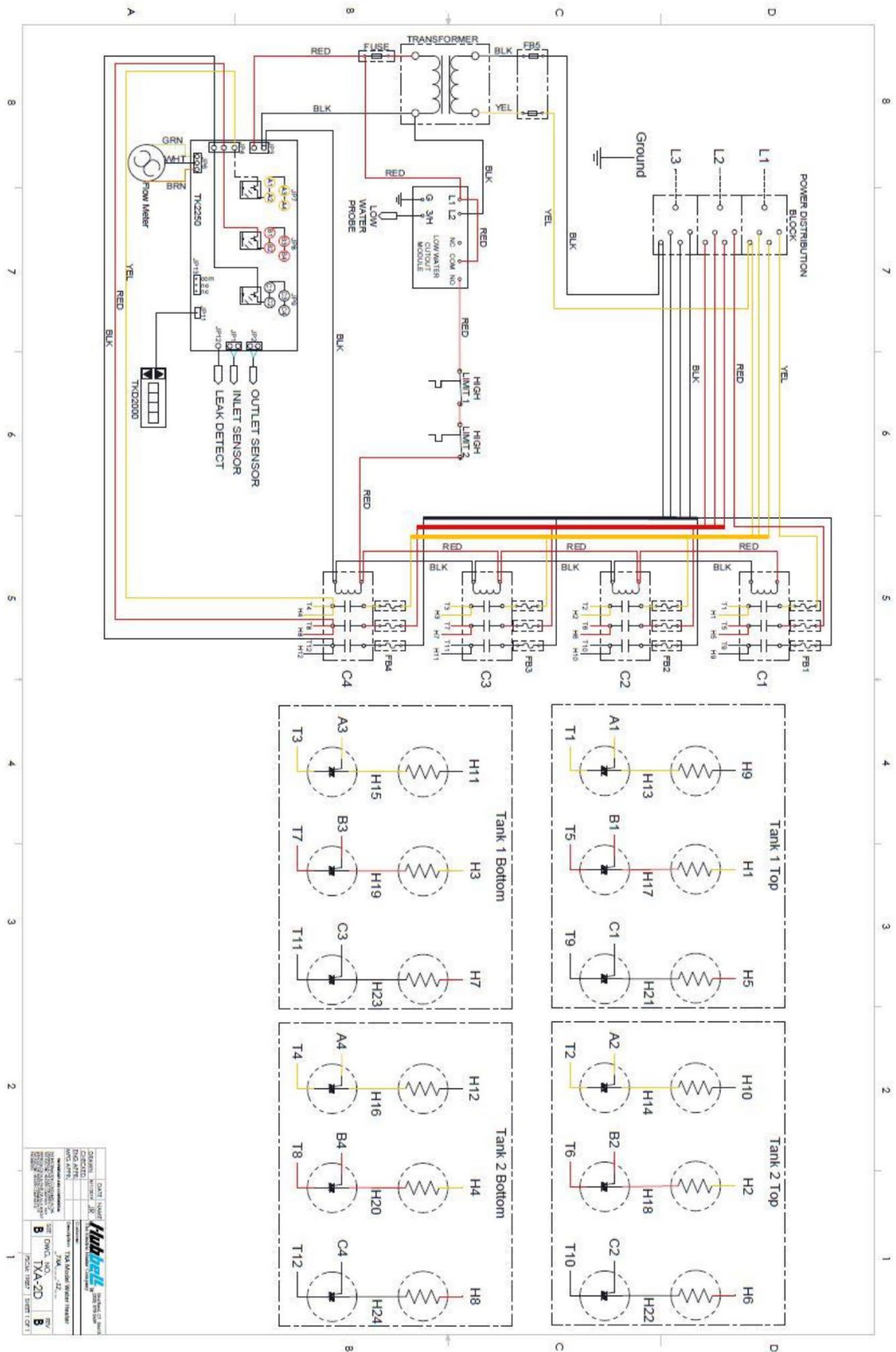

Tankless Wiring Diagram 2E (Delta)

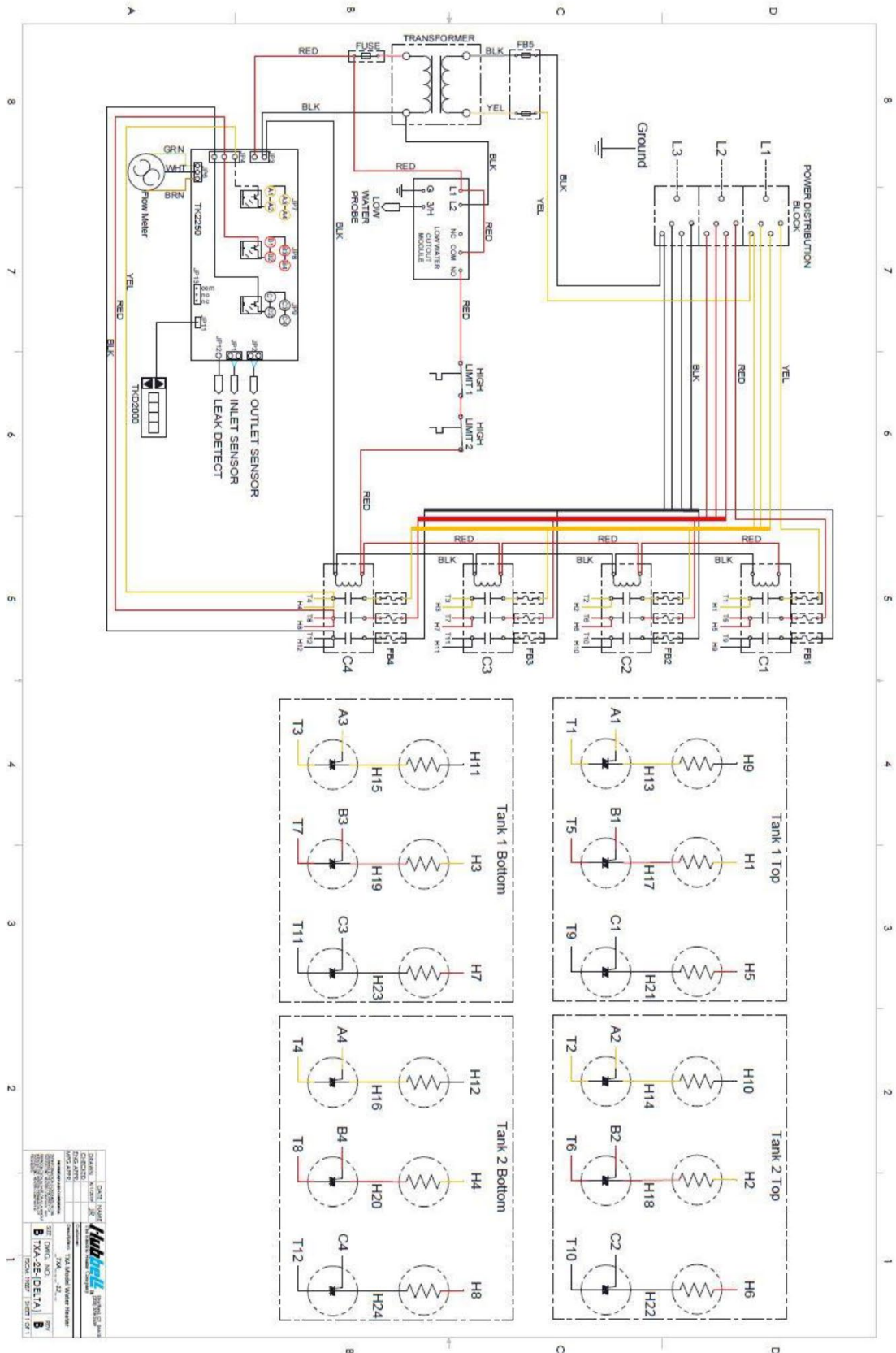

Tankless Wiring Diagram 2F

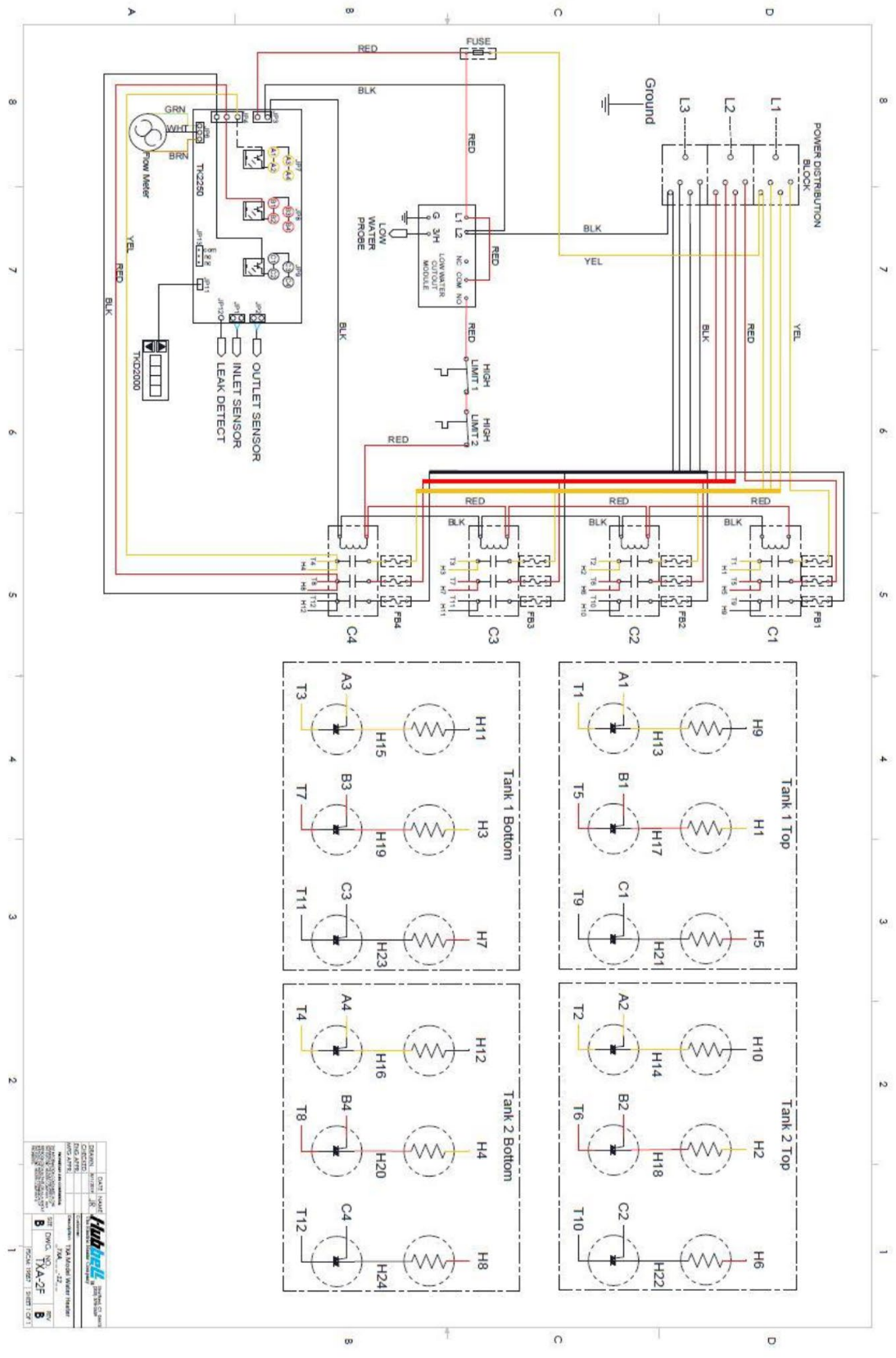

Tankless Wiring Diagram 3A (Delta)

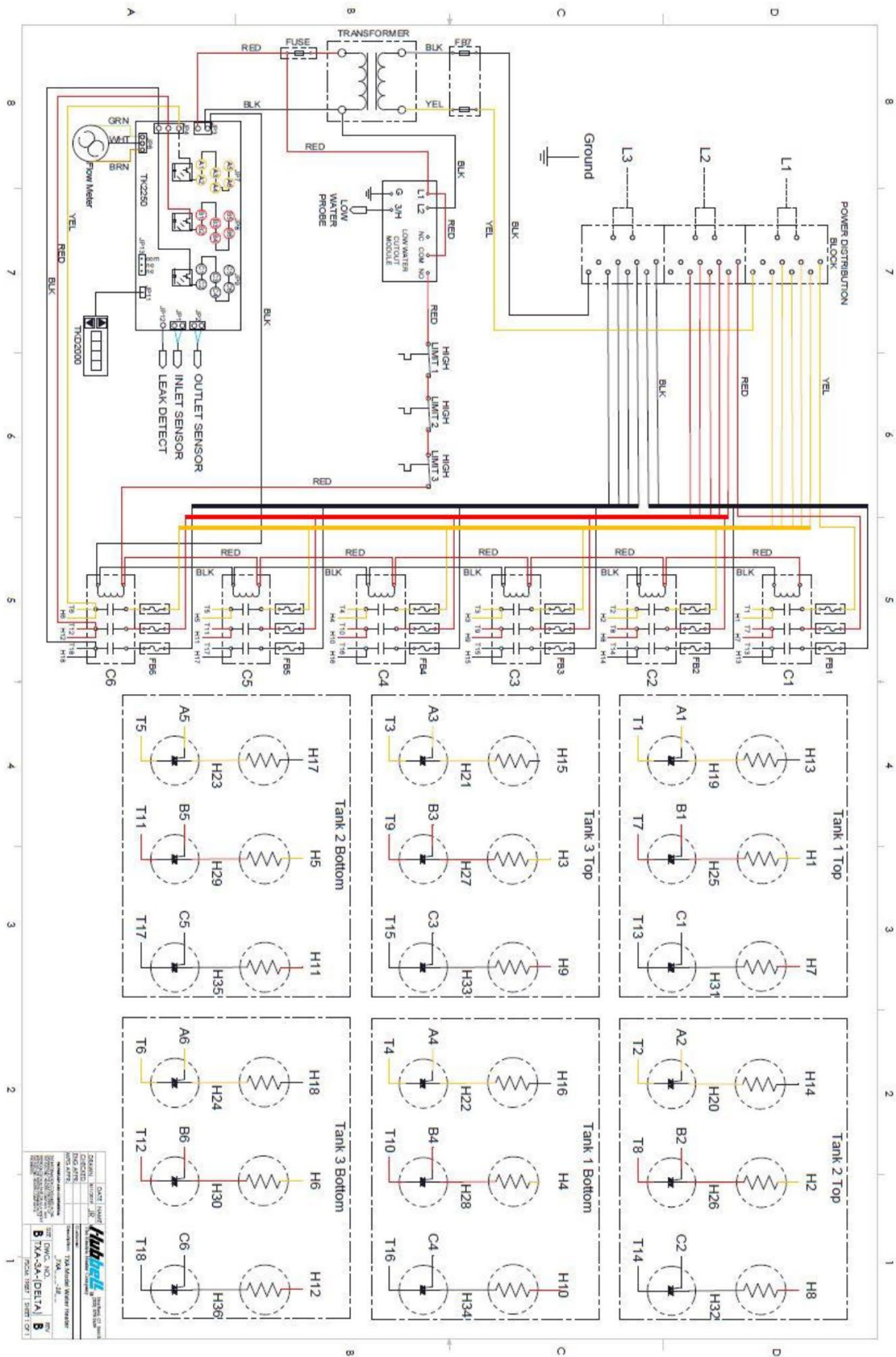

Tankless Wiring Diagram 3B

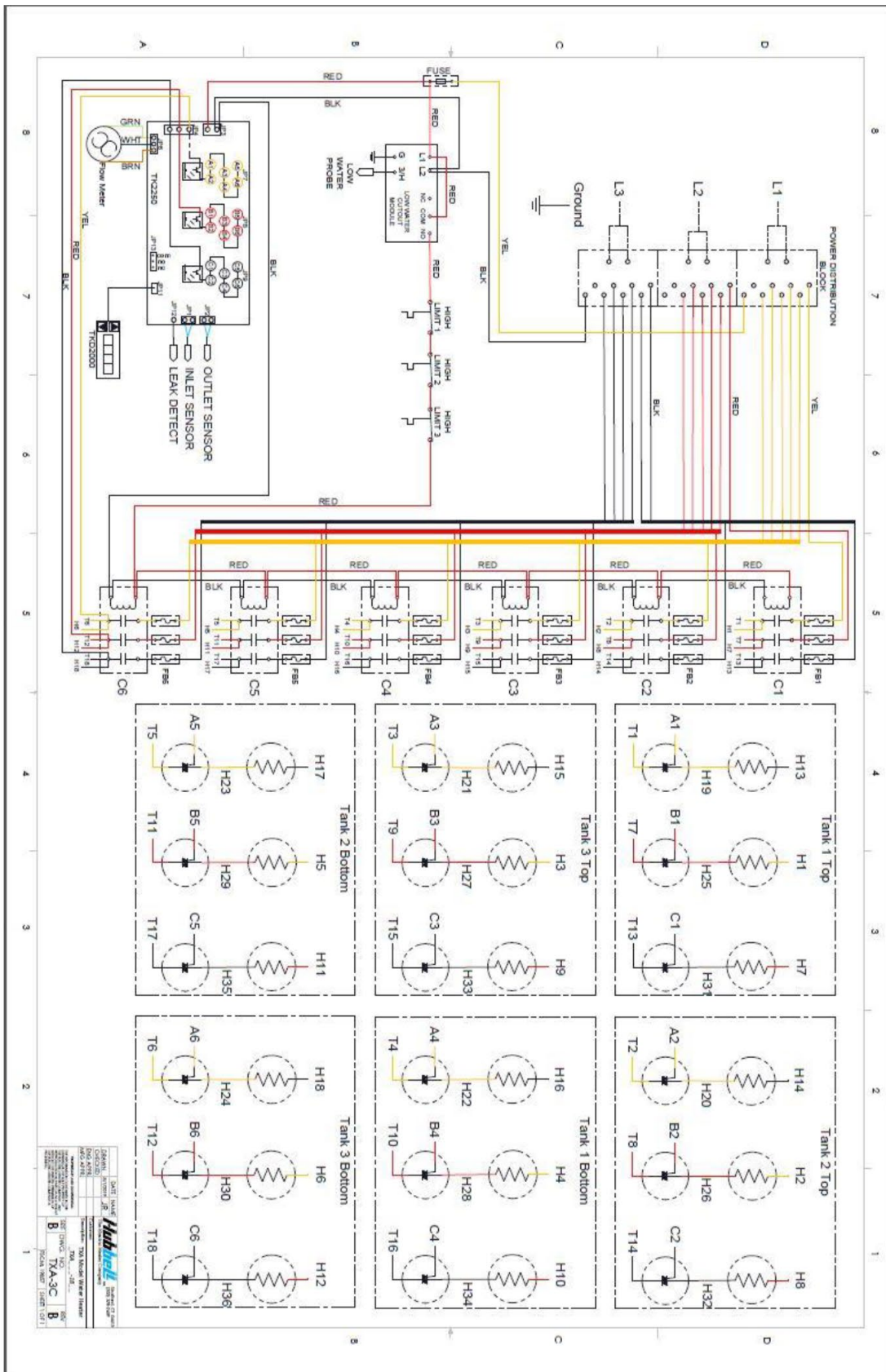

SECTION IV – TROUBLESHOOTING

Initial Evaluation:

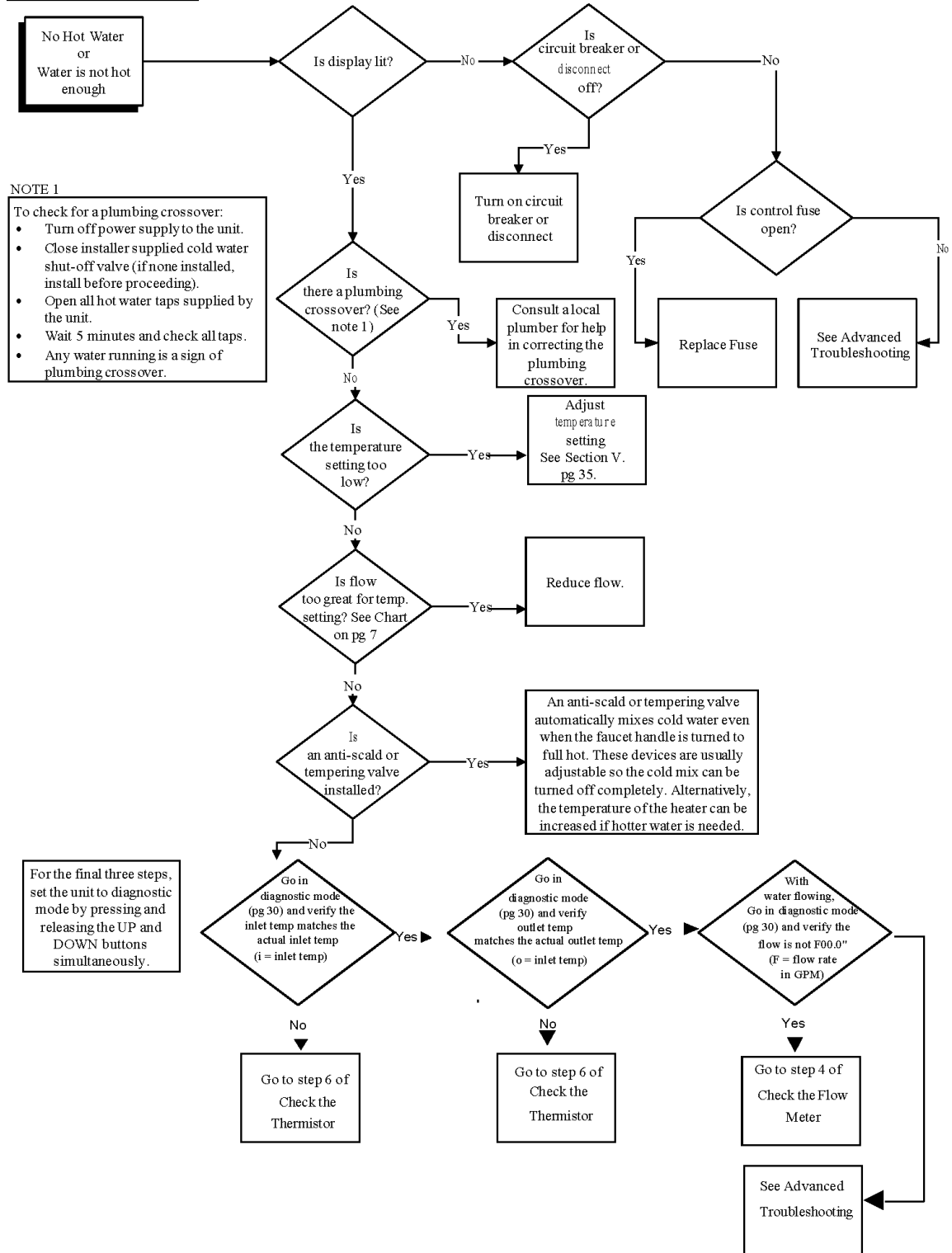

Advanced Troubleshooting:

WARNING: SERIOUS BODILY INJURY OR DEATH MAY OCCUR IF THE FOLLOWING WARNINGS ARE IGNORED.

- The following portion of this section is intended for use by a QUALIFIED ELECTRICIAN.
- All circuit breakers and the service disconnect must be turned off before opening the doors of the unit.
- Hubbell Water heaters provides technical assistance Monday - Friday, 8:00am – 5:00pm EST (203) 378-2659 or 800-647-3165.

This troubleshooting section will cover all the points that need to be checked from an electrical standpoint to ensure that the Hubbell tankless water heater is working correctly and to determine which component may need to be replaced.

Tools Required:

- Phillips screwdriver
- Flat blade screwdriver
- Clamp multi-meter able to read voltage and amperage (amperage readings require a clamp type meter).
- Thermometer

Pre-Operational Procedures:

1. With power to the unit turned ON, verify that the configuration settings are correct in accordance with the configuration code sticker on the inside of the door or use [Temperature Controller User Interface Instructions in Section V.](#)
2. TURN OFF POWER BY MEANS OF DISCONNECT.
3. Open front door(s).
4. Verify that the main power feed is properly connected to the power distribution block or magnetic contactor, as applicable.
5. Verify all connections are tight.

Check the Power Supply to the Unit:

1. Wearing proper P.P.E., turn on the power to the unit by means of disconnect.
2. Check the incoming voltage between each phase at the line side of the power distribution block or magnetic contactor, as applicable.
3. If no voltage is present between all phases, verify that the circuit breakers at the main panel and/or disconnect have been turned on.
4. If the circuit breakers are on and there is still no voltage present or if the incorrect voltage or no voltage is present between any of the phases, contact an electrician to troubleshoot the electrical feed.
5. If all voltage readings are acceptable, proceed to [Check the Transformer.](#)

Check the Transformer:

1. The transformer is utilized on units with supply voltages above 240 volts to supply a reduced voltage capable of powering the temperature controller.
2. If the display is lit or the unit is not equipped with a transformer (208- and 240-volt units), proceed to Check the Hi-Limit Thermostats.
3. Check the voltage on the primary side of the transformer.
4. If there is no voltage present, check the wiring and connections to the primary side of the transformer from the power distribution block or magnetic contactor, as applicable.
5. Check the voltage on the secondary side of the transformer.
6. If the secondary voltage does not conform to the table below, replace the transformer.
7. If all voltage readings are acceptable, proceed to Check the Hi-Limit Thermostats.

Primary Voltage	Secondary Voltage (±5%)
380	207
415	221
440	214
480	234
575	206
600	215

Transformer Voltage Table

Note: The secondary voltage listed in the transformer is based on the transformer being used at full capacity. Because there is essentially “no load” on the transformer, the secondary voltage will be higher than the voltage listed on the transformer. This “regulation” varies from 8.4% to 12% depending on the primary voltage and the transformer used.

Check the Hi-Limit Thermostats:

1. The unit is supplied with safety hi-limit thermostats mounted to the plate on the front of the heat exchanger. In all TXA series heaters, hi-limit thermostats are wired in series to a magnetic contactor coil. If any hi-limit thermostat opens due to high temperature or in the event of failure it will not supply power to the contactor coil and therefore no power will be supplied to any heating elements.
2. If there is no voltage at the bottom of any hi-limit thermostat, then check the wiring and connections between that hi-limit thermostat and the power distribution block or transformer.
3. If correct voltage is present at the bottom of the hi-limit thermostat but no voltage is present at the top of the thermostat, then that hi-limit thermostat needs to be replaced.
4. If correct voltage is present on the top and bottom continue to Check the Thermistor.
5. For three-phase units, if the magnetic contactor is pulled in, continue to Check the Thermistor. Otherwise, starting at the lower connection on the left side hi-limit thermostat, check the voltage between the metal connection point of the thermostat and the ground lug.
6. If correct voltage is present (208-240Vac), check the voltage at the upper metal connection point of the thermostat, then check the next hi-limit thermostat to the right and continue this pattern to the rightmost thermostat.
7. If at any point there is voltage on the lower side and there is no voltage on the upper side of the same thermostat, replace that hi-limit thermostat.

8. If at any point there is voltage on the upper part of a thermostat and there is no voltage on the lower part of the thermostat, check the wiring and connections.
9. If all voltage readings are good and the contactor is not pulled in, check the wiring and connections between the right-hand side thermostat and the magnetic contactor coil.
10. If the wiring and connections are good, replace the magnetic contactor(s).

Check the Thermistor:

1. The thermistor is a temperature sensing device that changes resistance with changes in temperature. It is designed to register 150,000Ω at 25°C (77°F).
2. Set the unit to diagnostic mode by pressing and releasing the UP and DOWN buttons simultaneously.
3. With a thermometer, measure the temperature of the cold water and hot water at a fixture.
4. Compare the displayed inlet temperature (i####) to the measured cold-water temperature and the displayed outlet temperature (o####) to the measured hot water temperature. If either of these readings are significantly different, continue with the next step. Otherwise, proceed to Check the Flow Meter.
5. At the right-hand side of the temperature controller are two terminal blocks JP1 and JP2. Disconnect the wires from the uppermost terminal block JP2 (Outlet Thermistor). Using the multi-meter probes with the setting at OHM or Ω, place one probe on the end of one wire and the other probe on the end of the other wire. An ohm reading consistent with the chart on the next page for the approximate temperature of the water should be indicated. NOTE: Alligator clips should be used. Holding the wires in your hands will give a false reading. Reconnect the wires.
6. Repeat the above step with the lower terminal block JP1 (Inlet Thermistor).
7. If either of these readings is not consistent with the chart (within ±10,000Ω), replace that thermistor.
8. If all ohm readings are acceptable, proceed to Check the Flow Meter.

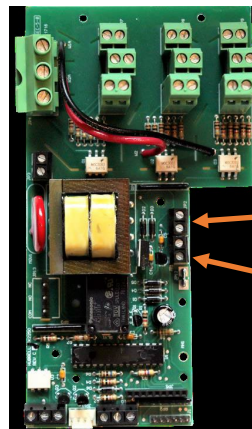

Outlet Thermistor
Inlet Thermistor

Thermistor Chart (150,000Ω @ 25°C (77°F))

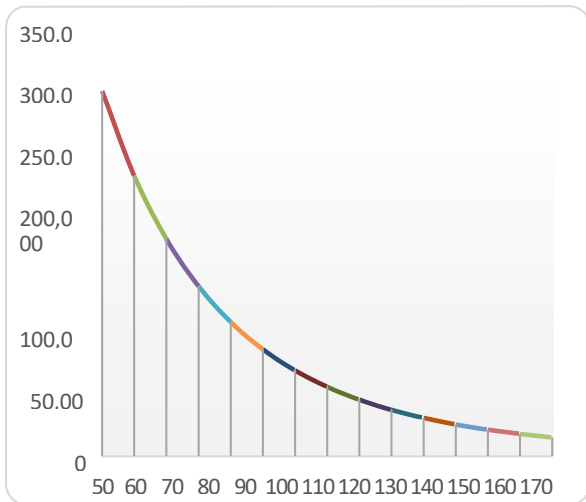

Temperature, °F (°C)	Ohms, Ω
50 (10.0)	299,516
60 (15.6)	229,905
70 (21.1)	178,244
80 (26.7)	139,501
90 (32.2)	110,157
100 (37.8)	87,723
110 (43.3)	70,418
120 (48.9)	56,957
130 (54.4)	46,402
140 (60.0)	38,062
150 (65.6)	31,425
160 (71.1)	26,106
170 (76.7)	21,816
180 (82.2)	18,333
190 (87.8)	15,489

Check the Flow Meter:

1. Set the unit to diagnostic mode by pressing and releasing the UP and DOWN buttons simultaneously.
2. Turn on a hot water tap at a fixture that will ensure a good flow rate through the unit.
3. If the flow rate on the display reads “F00.0” then continue with the next step. Otherwise, proceed to Check the Temperature Controller.
4. Verify that the wiring from the flow switch is connected to the control board in the order **WHITE/GREEN/BROWN** from left to right on pin block JP6.
5. With no flow on the unit, using the multi-meter probes with the setting at Volts – Direct Current, place one probe on the terminal block where the **WHITE** wire is connected (F1 Left) and the other probe where the **BROWN** wire is connected (F3 Right). A voltage reading in the appropriate range (9V) should be indicated.
6. If the voltage reading is not in the appropriate range (9V), replace the temperature controller.
7. Turn on a hot water tap at a fixture that will ensure a good flow rate through the unit and using the multi-meter probe with the setting at Volts – Direct Current, place one probe on the terminal block where the **WHITE** wire is connected (F1 Left) and the other probe where the **GREEN** wire is connected (F2 Middle). A voltage reading in the appropriate range (4.5V) should be indicated.

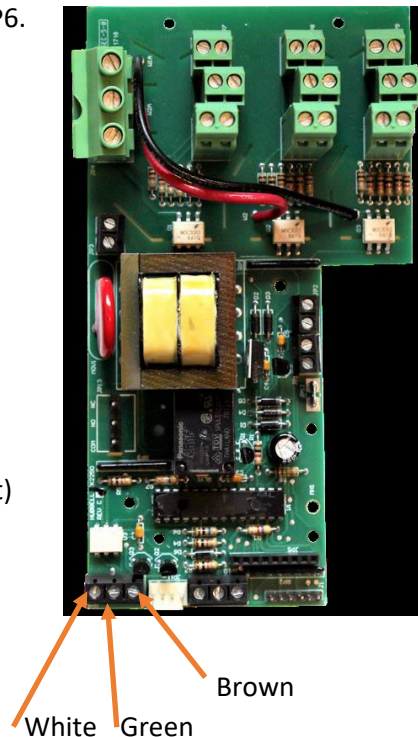

8. If the voltage reading is not in the appropriate range (4.5V), replace the flow meter.
9. If all voltage readings are acceptable, proceed to Check the Temperature Controller.

Check the Temperature Controller: TK2000 Control Board

With no flow to the heater:

1. At the top of the temperature controller there are 4 sets of terminal blocks for the **TK2000** control board, verify the wiring is correct as indicated in the wiring diagram specific to your heater model.
2. Check the voltage on the 2 connections labeled “A” and “B” on terminal block JP3 in the upper left-hand side of the board. A voltage reading in the appropriate range (208-240V) should be indicated.
3. If no voltage is present, verify that the wires connected in the terminal blocks are properly tightened and verify that the opposite end is properly connected to the power distribution block, magnetic contactor, or transformer, as applicable. Also check the control fuse located next to the control board.
4. If voltage is present where the black wires connect to the terminals and there is no display, replace the temperature controller.
5. Check the voltage between each additional pair of terminals labeled T2, T3 and T4. A voltage reading in the appropriate range of the incoming power voltage should be indicated. (i.e., if the incoming power is 480V, then the reading should be 480V across the pair)
6. If no voltage is present, verify that the **BLACK** jumper wires in the terminal block labeled B2, B3 and B4 are properly tightened and verify that the opposite ends of the **BLACK** wires are properly jumped to the previous **BLACK** wire connection terminal or properly connected the magnetic contactor, as per the unit wiring diagram.
7. Turn on a hot water tap at a fixture that will ensure a good flow rate through the unit and set the temperature at the highest setpoint, so the unit calls for full power.
8. Check the voltage between the terminal block labeled T2, T3 and T4 where the **YELLOW** wire is connected, from left to right to the case ground. A voltage reading in the appropriate range (one half of the incoming power voltage, i.e., if the incoming power is 480V, then the reading should be 240V) should be indicated. Repeat this step for each of the **YELLOW** wires.

If all voltage readings are acceptable, proceed to Check the Triacs (Step 1).

Check the Temperature Controller: TK2250 Control Board

With no flow to the heater:

1. Locate terminal block labeled JP3 at the bottom of the control board next to the control board’s transformer, and check voltage at terminals. A voltage reading in the appropriate range (208-240V) should be indicated.
2. If no voltage is present, verify that the wires connected in the terminal blocks are properly tightened and verify that the opposite end is properly connected to the power distribution block, magnetic contactor, or transformer, as applicable. Also check the control fuse located next to the control board.
3. If voltage is present where the black wires connect to the terminals and there is no display, replace the temperature controller.
4. Next, check the voltage between JP4 and JP7, JP8 and JP9. To check this voltage, place a probe on the **YELLOW** terminal of JP4 and the other probe to any of the terminals of JP7. A voltage reading in the appropriate range of the incoming power voltage should be indicated (i.e. if the incoming power is 480V, then the reading should be 480V across the pair). Repeat this step for the **RED** terminal of JP4 to JP8 and the **BLACK** terminal of JP4 to JP9.

- Turn on a hot water tap at a fixture that will ensure a good flow rate through the unit and set the temperature at the highest setpoint, so the unit calls for full power. Check the voltage between the terminal block labeled T7, T8 and T9 to the case ground. A voltage reading in the appropriate range (one half of the incoming power voltage, i.e. if the incoming power is 480V, then the reading should be 240V) should be indicated.

If all voltage readings are acceptable, proceed to Check the Triacs (Step 1).

Check the Triacs (Step 1):

- The triacs are the switching mechanism for turning the heating elements on and off.
- Turn on a hot water tap at a fixture that will ensure a good flow rate through the unit and set the temperature at the highest setpoint, so the unit calls for full power.
- Check the voltage between the two wires that are connected to the top of the heating element. A voltage reading in the appropriate range (equal to the incoming line voltage) should be indicated.
- If no voltage is present on any heating element, the triac connected to that element should be replaced.
- If all voltage readings are acceptable, proceed to Check the Heating Elements.



Check the Heating Elements:

- To check the heating element, the amperage draw from each heating element must be verified. To do this the unit must be operating.
- Turn on a hot water tap at a fixture that will ensure a good flow rate through the unit and set the temperature at the highest setting.
- Using a clamp-on multi-meter, clamp the meter around one of the wires going to the heating elements. The reading should be as indicated ($\pm 5\%$) based on the specific model listed in the Electrical Specification table in the Installation section.
- Repeat for all the heating elements.
- If any amp reading is not within the range as indicated in the chart, that heating element should be replaced.
- If all readings are within range continue to Check the Triacs (Step 2).



Check the Triacs (Step 2):

- Turn off the flow of hot water.
- Using a clamp-on multi-meter, clamp the meter around one of the wires going to the heating element (same as in step 3 of Check the Heating Elements). The reading should be zero. Repeat for all the heating elements.
- If any reading is not zero with the hot water turned off, then that triac should be replaced.

Contact the Factory:

If you were unable to determine the problem from the above troubleshooting, please have the electrician contact the factory.

Hubbell Water heaters provides technical assistance Monday - Friday, 8:00am – 5:00pm EST (203) 378-2659 or 800-647-3165. When making a call please have the unit model and serial number available.

SECTION V - SCHEDULED MAINTENANCE

Maintenance:

- The Hubbell TXA series water heater requires periodical maintenance, to check around the outside and inside of the unit for water leaks. Inspect the contactors for wear, noise and to also inspect ALL wiring connects for tightness. If a water leak is found in your water heater, turn off the water supply at the shut-off valve on the inlet side of the water heater, turn off the power to the heater at the main electrical panel or service disconnect and call a service technician or plumber for evaluation and repair.
- Once a year the heating chamber should be flushed to remove any debris or mineral build up that has accumulated in the operation of the heater. It may be required to run a descaling solution to help remove built up scale.
- When any maintenance is performed on the water heater or the plumbing system that may introduce air into the water supply pipes, it is important to turn the power off to the water heater and purge the air out of the lines before restoring power to the unit. See Checking for Leaks and Purging Air in Section III.

First Use of your Hubbell Tankless Water Heater:

Once the water supply is on and air has been purged from the system, power the unit on at the main panel. The unit is now operating automatically. When water flows through the unit, the heating elements turn on to heat the water to the displayed setpoint temperature. When the water flow stops, the heating elements turn off.

You can adjust the setpoint upward or downward by pressing the UP or DOWN button on either the internal or remote display.

Displaying Celsius or Fahrenheit degrees and adjusting other settings for the tankless water heater can be done via the configuration menu, described below.



Temperature Controller User Interface Instructions:

1. To turn the unit ON and OFF:
 - a. To turn the unit OFF, press and hold the DOWN button until the display shows OFF.
 - b. To turn the unit ON, press and hold the UP button until the setpoint temperature is displayed.
 - c. Note that the display is always on when power is applied to the unit.
 - d. Note that the controller will preserve all its settings during any power outage or disconnect.
2. To change setpoint temperature (the temperature is fully adjustable in 1° increments).
 - a. Press the UP or DOWN button to change the setpoint temperature.
 - b. Pressing and holding either the UP or DOWN button will fast scroll.

Configuration Menu

- c. To enter configuration menu, press and hold the UP and DOWN buttons simultaneously for 7 seconds. (Note that the display will change during the time you are holding the buttons. You are in the configuration menu and can release the buttons when the first character of the display is 'P').
- d. To scroll through menu items, press the UP or DOWN button.
- e. To leave the configuration menu, wait 7 seconds without pushing any buttons.
- f. To make a change to a specific configuration menu item, simultaneously press the UP and DOWN buttons. The menu item setting will now flash indicating it can be changed.
- g. To scroll through menu item settings, press the UP or DOWN key.
- h. When the desired setting is displayed, simultaneously press the UP and DOWN buttons to lock in the selection and return to the configuration menu.

i. Configuration Menu Items:

- i. Power Setting - Sets the total kW rating of the water heater.

- ###, where ### is adjustable from 001 to 164 (Note that the kW selection should equal to the kW based upon the actual voltage measured to the heater. Please see the nameplate on the front cover of the heater for a listing of kW ratings at various voltages).



- ii. Temperature Range - Sets the temperature adjustment range.

1. r001, 60° to 140°F (15°-60°C) (Factory Default)
2. r002, 32° to 194°F (0°-90°C)
3. r003, 32° to 104°F (0°-40°C)



- iii. Display units – Sets the display units to either Fahrenheit/Gallons or Celsius/Liters.

1. dEFF, for degrees Fahrenheit and Gallons. (Factory Default)
2. dECC, for degrees Celsius and Liters.



- iv. Normal Display Mode– Sets the display to show various values.

1. dSP1, to display setpoint temperature only. (Factory Default)
 - a. Setpoint is displayed as ###
2. dSP2, to display measured inlet temperature intermittently with setpoint temperature.
 - a. Inlet temperature is displayed as i###
3. dSP3, to display measured outlet temperature intermittently with setpoint temperature.
 - a. Outlet temperature is displayed as o###
4. dSP4, to display measured flow rate intermittently with setpoint temperature
 - a. The flow rate is displayed as F##.#, in tenths of a gallon or liter.
5. dSP5, to display inlet temp, outlet temp, flow rate and setpoint all intermittently.



- v. Power Limiting Factor – Sets the % of heater output allowed by the controller.

1. L###, where ### is a percentage from 001 to 100 (Factory Default 100). This feature allows a user to limit the kW rating of the unit by a specific percentage and effectively lower the total amp draw of the unit. (NOTE: The electrical service still needs to be sized for the total amperage listed on equipment nameplate.)



- vi. Heater Configuration – Sets the controller to perform calculations based on the heater configuration of the unit.

1. E001, for single-phase one heating element and all 3-phase units
2. E002, for single-phase two heating elements
3. E003, for single-phase three or six heating elements



4. E004, for single-phase four heating elements

vii. Calibration – Used to calibrate the heater. (For factory use only)

1. CA #, where ## equals the degrees of calibration from -3 to 3. Default is 0.



viii. Low/High Flow – Sets the unit as either a low flow or high flow unit.

1. LF, for low flow (Factory Default).
2. HF, for high flow.



ix. Remote Control – Sets the operation of the remote-control function (see Priority and Remote Controls in this section).

1. iPOF, disables the remote control (Factory Default).
2. iPHi, 24VDC signal connected to P1 and P2 or closed relay connected to P2 and P3 will allow the heater to operate and loss of 24VDC signal or open relay connected to P2 and P3 will inhibit the heater operation.
3. iPLo, 24VDC signal connected to P1 and P2 or closed relay connected to P2 and P3 will inhibit the heater operation and loss of 24VDC signal or open relay connected to P2 and P3 will allow the heater to operate.
4. When the remote-control operation is inhibiting the unit from operating the display will show hLd.



x. Display Lock – Allows the user to lock the heater parameters. When the display is locked the temperature setpoint cannot be changed and although the configuration menu will still be accessible, no changes can be made to any parameters, except to change the display lock. With the display lock on, attempting to change the temperature setpoint will cause the display to show, LcLd.



1. LcOn, to turn the display lock on.
2. LcOF, to turn the display lock off (Factory Default).

xi. Software Version – Displays the version number of the software

1. Sd###, where ### is the version of the display software.
2. Sb###, where ### is the version of the main board software.

NOTE: Both software versions of the board and display must match.

j. After this menu item, the configuration menu cycles back to the first item.

3. Diagnostic Menu Display

a. To display common diagnostic data useful for troubleshooting, when in normal display mode press and release the UP and DOWN buttons simultaneously.



b. The display will intermittently display the following values: flow rate (F##.#), measured inlet temp (i####), measured outlet temp (o####), setpoint (###).



c. These values and settings will continue to display and scroll until either the UP or DOWN button is pressed. The display then returns to normal display mode.



4. Configuration Settings Display

a. To display all configuration settings, when in normal display mode press and release the UP and DOWN buttons simultaneously twice.

b. The display will scroll through all configuration settings.

c. The display will continue to scroll until either the UP or DOWN button is pressed and will then return to normal display mode.

5. Power Rate Display



- a. The decimal point in the display's rightmost digit is a visual indicator of how much power is required to meet the demand. A blinking decimal point indicates that the triac is being sent a signal to energize and thus turn the element on. The decimal point light will blink at a faster rate as the controller is calling for more heat. When the unit is calling for full power the light is solid.
 - b. If the amount of power required exceeds the capacity of the heater, then the entire display will intermittently flash. (Note that the display will only flash when the display configuration is set to 'dSP1'.)
- ## 6. Cost Calculator—Allows user to view the amount of power and hot water consumed and the cost of operation.
- a. To display the Cost Calculator values, when in normal display mode press and release the UP and DOWN buttons simultaneously three times.
 - b. the display will scroll through the Cost Calculator Values since the last reset
 - i. C###, where ### equals the total cost of operation
 - ii. #####, where ##### equals the total number of kW·Hrs consumed
 - iii. H0##, where ## equals water usage up to the ten thousandth place, followed by h###, where ### equals water usage up to the hundreds place. Example: H012, h345 equals 12,345 gallons of water used.
 - iv. To reset these values to 0, press and hold the UP and DOWN buttons simultaneously for 5 seconds. When the display shows '0000', the cost calculator has been reset.
 - a. To enter a specific cost per kW·Hr value, while displaying the Cost Calculator values above press and release the UP and DOWN buttons simultaneously.
 - v. The display shows the cost per kW·Hr as #.### (Factory Default 0.114)
 - vi. Press the UP or DOWN button to adjust the cost per kW·Hr. Holding the UP or DOWN buttons will fast scroll.
 - vii. Press the UP and DOWN buttons simultaneously to lock in the cost per kW·Hr.
 - viii. Press the UP or DOWN button to return to Cost Calculator values.
 - ix. Press the UP or DOWN button to return to normal display mode.

7. Error Code



- a. Err1, Future use.
- b. Err2, Future use.
- c. Err3, Future use.
- d. Err4, Future use.
- e. Err5, indicates a failure of the inlet thermistor.
- f. Err6, indicates a failure of the outlet thermistor.
- g. Err7, indicates a failure of the display unit to communicate with the main board.
- h. Err8, indicates that water has been detected in the case.
- i. Err9, indicates a problem with the flow meter.

Remote Display:

A remote display is supplied and connected to the [TK2000](#) and the [TK2250](#) control board on pin JP11 as shown below.

Priority and Remote Controls:

Optionally, the tankless water heater may be connected to another electrical device (10A @240VAC max.) that will give priority to the water heater over that device to ensure that both do not operate at the same time and/or the tankless water heater may be wired to a remote switch, relay, or provided with a 24VDC signal (such as from a building maintenance system) to allow the tankless water heater to be remotely controlled. The diagram and description below provide details on how connections to the tankless water heater control board are to be made.

1. Priority Relay (10A@240VAC max.)

- a. When the unit is demanding power (calling for heat):

- i. The connection between the terminals marked C and NO are closed and will allow power to pass through.
- ii. The connection between the terminals marked C and NC are open and will not allow power to pass through.
- b. When the unit is not demanding power (not calling for heat):
 - i. The connection between the terminals marked C and NO are open and will not allow power to pass through.
 - ii. The connection between the terminals marked C and NC are closed and will allow power to pass through.

2. Remote Control

- a. When a 24VDC signal (5mA draw max.) is supplied between terminals P1 and P2, the heater will either operate or be inhibited (displayed as hLd) as determined by the Remote Control settings as shown above. Loss of 24VDC signal has the opposite effect.
- b. When wired to a volt-free contact (10A max.) between terminal P2 and P3 (output signal 24VDC@5mA), opening or closing the contact will allow the heater to either operate or inhibit (displayed as hLd) operation as determined by the Remote Control settings as shown above.



Power and Triac Wiring

TK2000 Control Board Wiring Detail

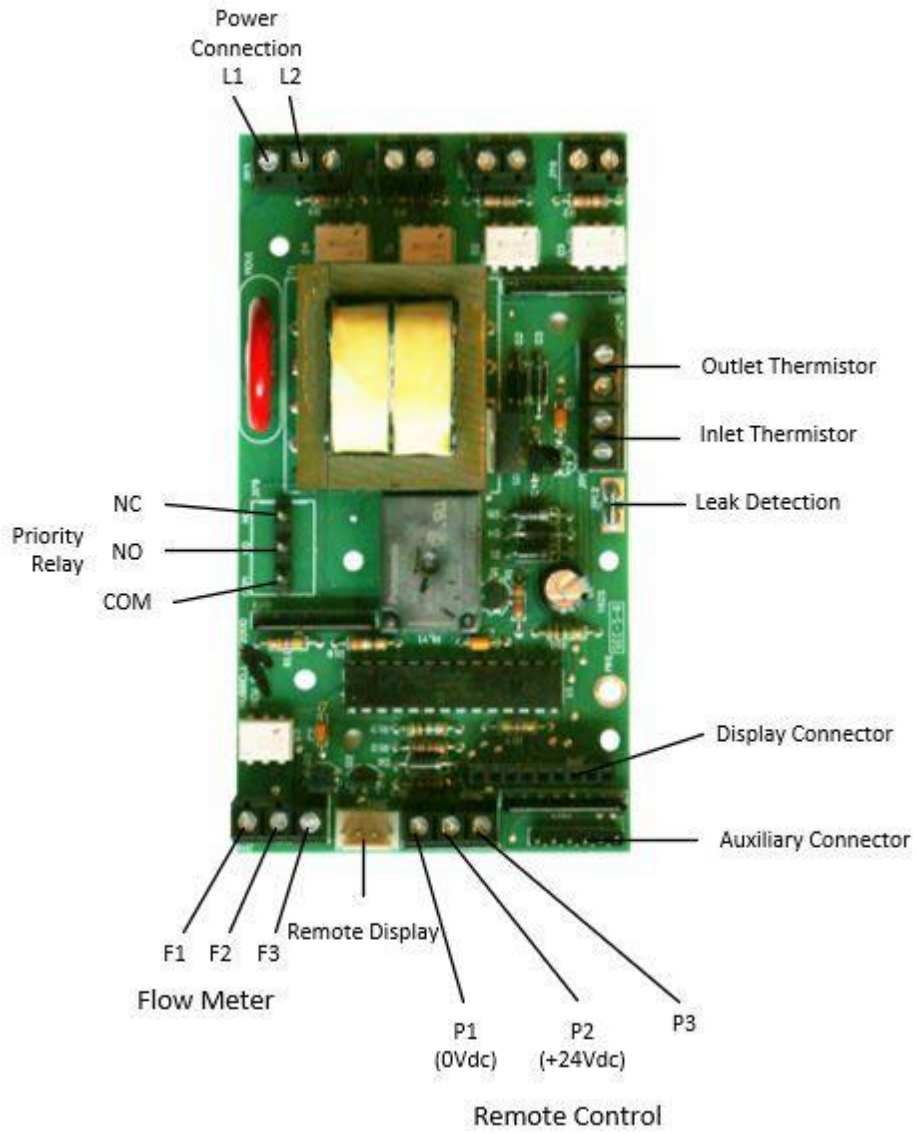

TK2250 Control Board Wiring Detail

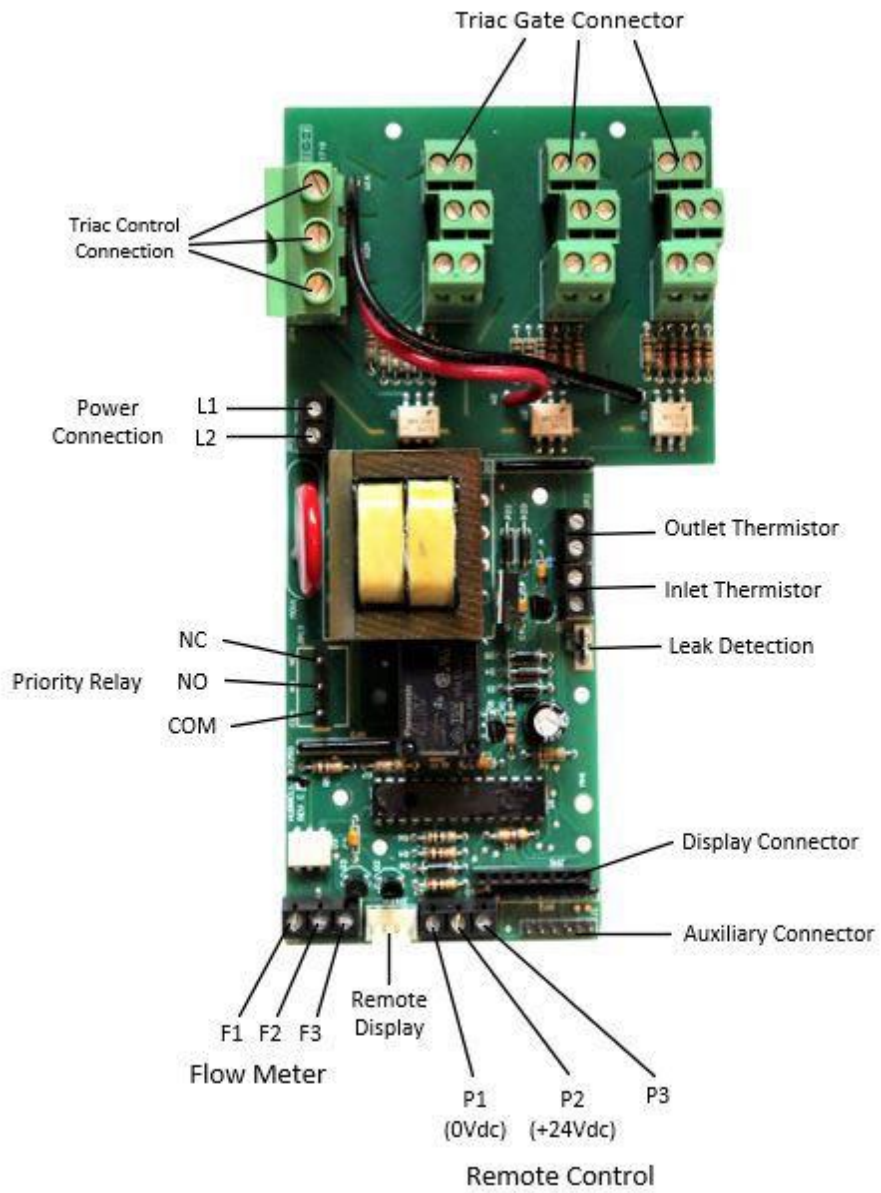

SECTION VI - SERVICING & REPLACEMENT OF PARTS

WARNING: *SERIOUS BODILY INJURY OR DEATH MAY OCCUR IF THE FOLLOWING WARNINGS ARE IGNORED.*

- The following portion of this section is intended for use by a QUALIFIED ELECTRICIAN OR PLUMBER.
- All circuit breakers at main panel or means of service disconnect must be turned off before opening the front door to the unit.
- When any maintenance is performed on the water heater that may introduce air into the unit, it is important to purge the air out of the lines before allowing the unit to power up. See [Checking for Leaks and Purging Air](#) in Section III.

Heating Element:

- Disconnect power.
- Shut off cold water inlet and hot water outlet valves.
- Drain unit.
- Open door.
- Disconnect the power leads from the element to be replaced.
- Unscrew the element from the heating chamber.
- Install the replacement heating element by screwing it into the heating chamber coupling. NOTE: Verify that the O-ring is installed onto the heating element prior to installation.
- Re-connect the power leads to the element terminals.
- Close door.
- Open the cold-water inlet and hot water outlet valves.
- Bleed air from the unit. See [Checking for Leaks and Purging Air in Section III](#).
- Turn on the power.

Hi-Limit Switch:

- Disconnect power.
- Open door.
- Disconnect the wires from the hi-limit switch to be replaced.
- Remove the two (2) screws securing the hi-limit switch to the heating chamber cover.
- Remove the hi-limit switch.
- Spread a pea sized amount of the conductive thermal paste included with the replacement kit on the back of the hi-limit switch (the portion to be installed against the heating chamber tube).
- Install the hi-limit switch to the heating chamber cover with the two screws previously removed.
- Connect the wires previously disconnected in the prior step.
- Close door.
- Turn on the power.

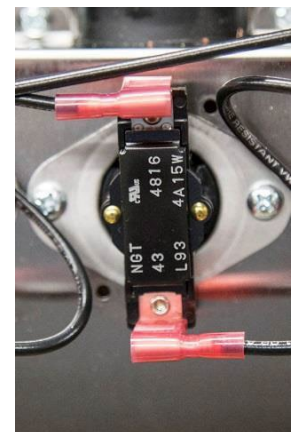

Inlet Thermistor:

- Disconnect power.
- Open door.
- Disconnect inlet thermistor wires from terminals marked JP1 on the temperature controller.
- Cut the tie-wrap securing the inlet thermistor wire to the inlet pipe and unscrew the inlet thermistor.
- Screw in new inlet thermistor and secure the inlet thermistor wire to the inlet pipe with a new tie-wrap.
- Connect the new inlet thermistor wires to terminals marked JP1 on the temperature controller.
- Close door.
- Turn on the power.

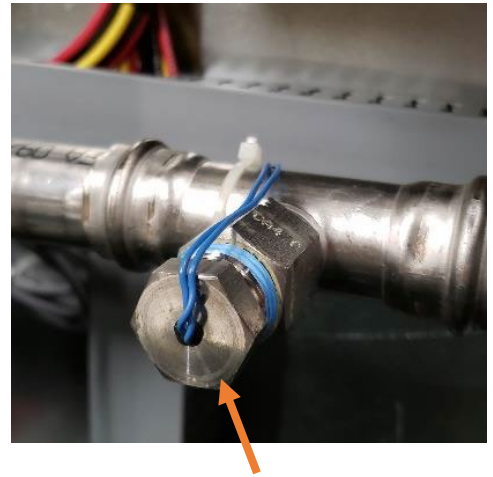

Outlet Thermistor:

- Disconnect power.
- Open door.
- Temperature Controller
- Disconnect outlet thermistor wires from terminals marked JP2 on the temperature controller.
- Cut the tie-wrap securing the outlet thermistor wire to the outlet piping and unscrew the outlet thermistor.
- Screw in new outlet thermistor and secure the outlet thermistor wire to the outlet pipe with a new tie-strap.
- Connect the new outlet thermistor wires to terminals marked JP2 on the temperature controller.
- Close door.
- Turn on the power.

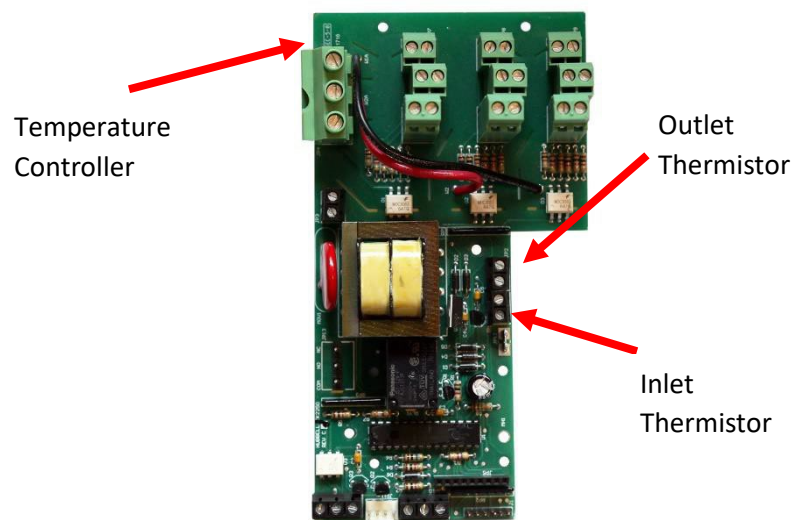

TK22500 Temperature controller

Temperature Controller:

- Disconnect power.
- Open door.
- Mark the wires going to the controller so they can be re-connected in the same places upon replacement.
- Disconnect all the wires from the controller. NOTE: The display may need to be removed to access the wires from the flow meter. The display can be removed by removing the four (4) screws securing the display to the controller standoffs and then pulling the display from the socket.
- Remove the two (2) screws securing the temperature controller to the controller stand.
- Install the replacement controller with the two (2) screws removed in the last step.

- Re-connect the wires to the temperature controller in the same locations they were previously disconnected from.
- Close door.
- Turn on the power.

Triac:

- Disconnect power.
- Open door.
- Disconnect the wire from the failed triac.
NOTE: Replacement triacs come with replacement wires attached but are not used in this application.
- Remove the two (2) nuts securing the triac to the heatsink and remove the triac. Please note the triac orientation, one terminal (the triac gate) is narrower than the others.
- Spread a pea sized amount of the conductive thermal paste included with the replacement kit on the back of the triac to be installed.
- Install the replacement triac in the correct orientation to the heatsink with the two (2) nuts removed previously.
- Reconnect the wire from the heating element, the wire from the power distribution block or magnetic contactor (as applicable), and the wire from the temperature controller.
- Close door.
- Turn on the power.

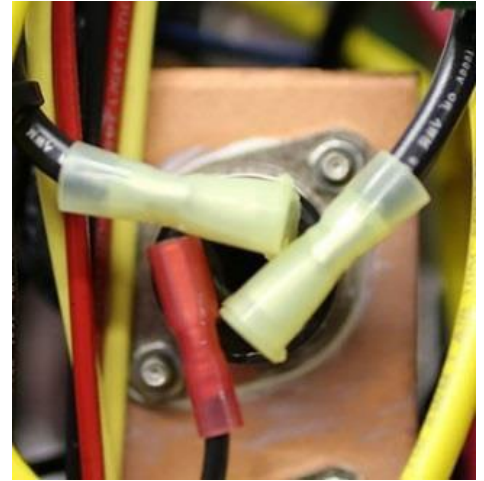

Flow Meter:

- Disconnect power.
- Shut off cold water inlet and hot water outlet valves.
- Drain unit.
- Open door.
- Disconnect the flow meter wires from the controller.

NOTE: The display may need to be removed to access the wires from the flow meter. The display can be removed by removing the four (4) screws securing the display to the controller standoffs and then pulling the display from the socket.

- Disconnect the cold-water supply pipe from the quick-connect fitting. See [Disconnecting a Joint in Section III](#).
- Unscrew the two union couplers from the flow meter.
- Slide the replacement flow meter into the inlet piping and tighten two union couplers to the new flow meter.
NOTE: When installing flow meter make sure arrow is pointing in the direction of the water flow.
- Connect the flow meter wires to the controller on terminal JP6, WHITE / GREEN / BROWN.
- Close door.
- Open the cold-water inlet and hot water outlet valves.
- Bleed air from the unit. See [Checking for Leaks and Purging Air in Section III](#).
- Turn on the power.



Magnetic Contactor:

- Disconnect power.
- Open door.
- Mark the wires going to the magnetic contactor so they can be re-connected in the same places upon replacement.
- Slide fuse block up to move out of the way.
- Disconnect all the wires from the magnetic contactor.
- Remove the two (2) screws securing the magnetic contactor to the base.
- Install the replacement magnetic contactor with the two (2) screws removed in the last step.
- Re-connect the wires to the magnetic contactor in the same locations they were previously disconnected from.
- Close door.
- Turn on the power.

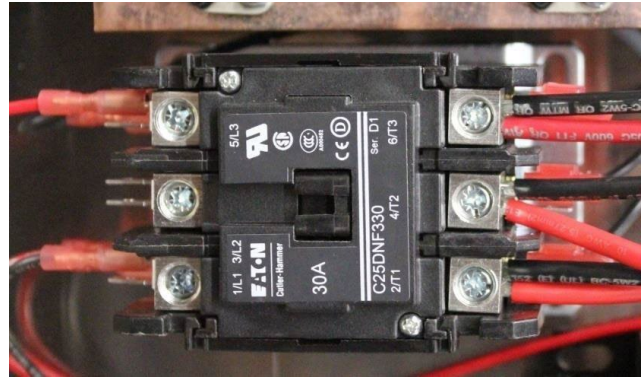

Transformer:

- Disconnect power.
- Open door.
- Mark the wires going to the transformer so they can be re-connected in the same places upon replacement.
- Disconnect all the wires from the transformer.
- Remove the two (2) screws securing the transformer to the base.
- Install the replacement transformer with the two (2) screws removed in the last step.
- Re-connect the wires to the transformer in the same locations they were previously disconnected from.
- Close door.
- Turn on the power.

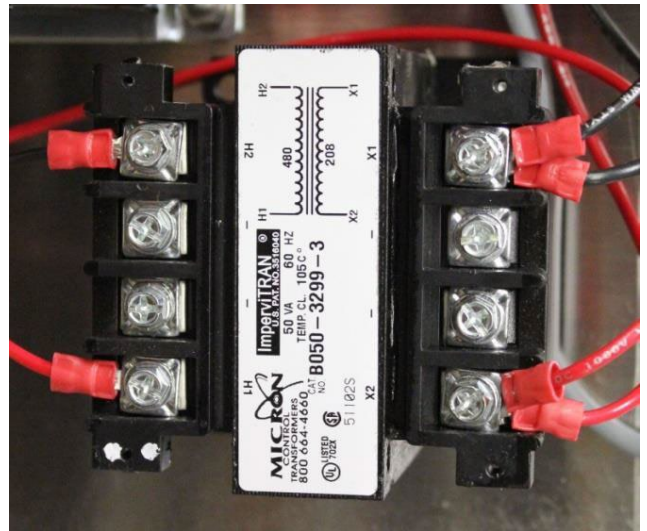

Control Fuse:

Disconnect power.

- Open door.
- Twist fuse and pull from fuse holder.
- Insert new fuse in holder and twist to lock in place.
- Close door.
- Turn on the power.

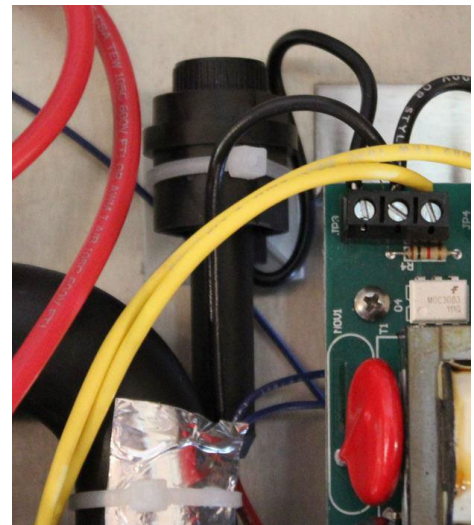

Low Water Cut off (LWCO):

- Disconnect power.
- Open door.
- Mark wires going to the LWCO control board.
- Disconnect all wires going to the LWCO and remove 3 screws from the board.
- Install new LWCO board with the 3 screws removed from the last step.
- Re-connect the wires to the LWCO in the same locations they were previously disconnected from.
- Close door.
- Turn on the power.

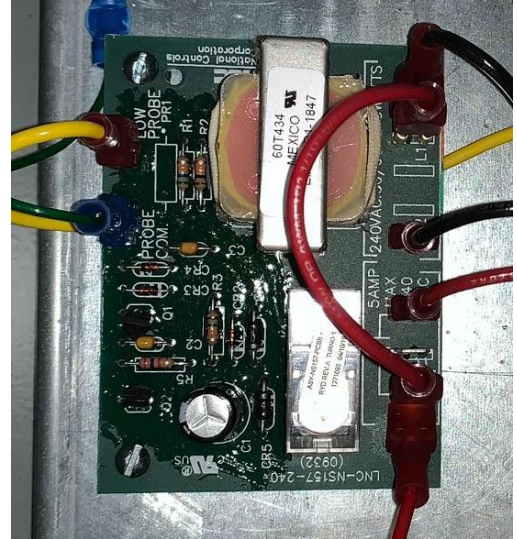

Low Water Cut off (LWCO) Probe:

- Disconnect power and shut off water.
- Open door.
- Locate LWCO probe in the top of tank 1.
- Disconnect wire from LWCO probe.
- Remove probe from tank and install new probe with thread sealant.
- Reconnect wire to LWCO probe.
- Close door.
- Turn on the power.



LWCO Probe

PARTS LIST

Category	Description	Hubbell P/N
Plumbing	Compression Fitting (each)	COMP FTNG TK
	Tankless Water Heater Valve set With PSI Relief Valve	TWH-UT-HC-RV
	Quick Connector Press Fit-Inlet, 3/4" C x 3/4" MNPT	U134
	Quick Connector Press Fit-Outlet 3/4" C x 3/4" C	U016
	Taco 49-075T 3/4" NPT Air Separator	AIR SEPERATOR 3/4"
	Filter Screen for Inlet	SCREEN TK
Triacs	Triac (Supplied with wire leads), Voltages 480V & below	TG40E60
	Triac (Supplied with wire leads), Voltages over 480V	TG40E80
Elements (with O-ring)	3500 Watt @ 240V 1 phase	N1315-3500
	4500 Watts @ 240V 1 phase	N1315-4500
	5500 Watts @ 240V 1 phase	N1315-5500
	7000 Watts @ 240V 1 phase	N1315-7000
	8000 Watts @ 240V 1 phase	N1375-8000
	9000 Watts @ 240V 1 phase	N1375-9000
	6000 Watts @480V 3 phase	N1315-6000T4
	7000 Watts @480V 3 phase	N1315-7000T4
	8000 Watts @480V 3 phase	N1375-8000T4
	9000 Watts @480V 3 phase	N1375-9000T4
	7000 Watts @440V 3 phase	N1315-7000T5
	8000 Watts @440V 3 phase	N1375-8000T5
	9000 Watts @440V 3 phase	N1375-9000T5
	7000 Watts @346V 3 phase	N1315-7000T6
	8000 Watts @346V 3 phase	N1375-8000T6
	9000 Watts @346V 3 phase	N1375-9000T6
	8000 Watts @208V 3 phase	N1375-8000R
	9000 Watts @208V 3 phase	N1375-9000R
	Extra O-Ring	O RING SGB
	Electrical	Thermistor
Thermistor for ETX, 1/8" NPT		USP12197
Auto Resetting Hi-Limit (Supplied with Leads) set to 140F		L60
Auto Resetting Hi-Limit (Supplied with Leads) set to 200F		L93
Manual reset high limit		20615L11-C85
Temperature Control Board (Flow Meter Type)		TK2000
Temperature Control Board (6, 12 & 18 element)		TK2250
Digital Display-Numeric Type (Flow Meter Type)		TKD2000
Power Distribution Block		67512
Flow Meter (3/4" GHT x 1/2" NPT) w/ Sensor		TK FLOW BR
Flow Meter Sensor (Supplied with wire leads)		VTY10 SENSOR
High flow meter, .5-40 GPM		VT2511MSHNP000
Contactora, 40 amp, 240V		C252DNF330B
Contactora, 50 amp, 240V		C25DNF340B
Contactora, 65 amp, 240V		C25DNF350B
Transformer, 480/440V:208V		B050-3299-3
Transformer, 600/575V:195V		B050-3350-3
Transformer, 380/415V:185V		B050-3351-3
Fuse		LGR003
Fuse Holder		LHR000
Wire	Wire #18 (Specify: Yellow, Red, Black)	WIRE 18"COLOR"
	Wire #10 Red (Specify: Red, Black)	WIRE 10"COLOR
	Wire #8 Red (Specify: Red, Black)	WIRE 8"COLOR"
Miscellaneous	Tankless Overlay	TANKLESS OVERLAY
	Flow-Aide System Descale Kit, Solution & Pump	DESCALER WHITLAM FLOW
	Flood Stop	FLOOD STOP

SECTION VII – WARRANTY

MANUFACTURER’S LIMITED WARRANTY

- 1. PRODUCT WARRANTY:** Hubbell warrants the Hubbell Tankless Water Heater and its components as manufactured by Hubbell (the "Product") to be free from defects in materials and workmanship, under normal use and service for the period of time identified below beginning from the date of installation, provided that the Product is (i) installed within sixty (60) days from date of shipment from Hubbell and (ii) installed by a licensed electrician and plumber (*specific proof required*) and maintained in accordance with Hubbell's written instructions.

HEATING CHAMBER: Five (5) years

ELECTRICAL COMPONENTS: One (1) year

REPLACEMENT PARTS: Thirty (30) days

SUCH WARRANTIES DO NOT COVER:

- Product failure caused by liming, sediment buildup, chemical corrosion, chlorine/chloride corrosion, or freezing.
- Product failure caused by the failure to remove air from system prior to or during operation.
- Product misuse, tampering or misapplication, accidental damage, improper installation, or the application of improper voltage.
- Costs incurred for shipping, delivery, handling, and/or administrative charges.
- Product failure due to lightning, flood or other natural or manmade calamities.
- Labor charges of any kind.

THE FOREGOING WARRANTIES ARE EXCLUSIVE AND IN LIEU OF ANY OTHER WARRANTY, EXPRESSED OR IMPLIED, INCLUDING BUT NOT LIMITED TO ANY IMPLIED WARRANTY OF MERCHANTABILITY OR FITNESS FOR A PARTICULAR PURPOSE OR PATENT OR OTHER INTELLECTUAL PROPERTY RIGHT INFRINGEMENT.

- 2. LIMITATION OF REMEDIES AND DAMAGES:** Hubbell's liability and Buyer's exclusive remedy hereunder will be limited solely, at Hubbell's option, to repair or replacement by the Hubbell Service Center with respect to any claim made within the applicable warranty period referred to above. Without limiting the generality of the foregoing, all warranty items shall be returned by Buyer, at its sole expense, to the Hubbell Service Center for replacement or repair. Hubbell reserves the right to accept or reject any such claim in whole or in part. Hubbell will not accept the return of any product without prior written approval from Hubbell, and all such approved returns shall be made at Buyer's sole expense. HUBBELL WILL NOT BE LIABLE, UNDER ANY CIRCUMSTANCES, FOR CONSEQUENTIAL OR INCIDENTAL DAMAGES, INCLUDING BUT NOT LIMITED TO LABOR COSTS OR LOST PROFITS RESULTING FROM THE USE OF (OR INABILITY TO USE) THE PRODUCTS OR FROM THE PRODUCTS BEING INCORPORATED IN OR BECOMING A COMPONENT OF ANY OTHER PRODUCT OR GOODS.
- 3. FURTHER LIMITATIONS AND EXCLUSIONS AFFECTING YOUR WARRANTY:** This warranty is void if the product is not installed in accordance with relevant, local electrical and plumbing codes and in accordance with the installation instructions specified by the manufacturer. Local codes will override manufacturer's instructions at the time of installation and if additional installation parts are required, the costs will be the responsibility of

Buyer. Product nameplate identifying the model and serial number must be affixed to the unit and legible for the warranty to be exercised. Product without the nameplate is excluded from warranty consideration. Above ground level installations must be protected with drip pans and drains just as the codes call for protective requirements used in regular hot water tank installations. Buyer hereby accepts the entire responsibility for ascertaining whether they have sufficient electrical power to operate our Tankless Water heaters as indicated in our specifications which are readily available at our website, in our brochures and contained in the shipping box for installers to read before installation. If Buyer has purchased without first ascertaining the cost for installation or the necessary power available for operation, Hubbell at its sole and complete discretion may allow a return and grant a refund less freight and less 30% of the retail price as a restocking fee. The refund will be conditioned upon a determination by Hubbell after inspection of the Product being returned (either unopened or in the original shipping box and packing) that the Product has not been damaged. This request and for this reason only must be made within 30 calendar days of receipt of the Product.

AFTER 30 CALENDAR DAYS FROM DATE OF PURCHASE THERE WILL BE NO RETURNS WHATSOEVER. BUYER ACCEPTS ALL SALES AS FINAL. ANY ALTERATION TO THE PRODUCT VOIDS ALL WARRANTIES. HUBBELL IS NOT RESPONSIBLE FOR ANY OTHER CHARGE OR EXPENSE INCURRED OTHER THAN THE ORIGINAL PURCHASE PRICE OF THE PRODUCT. Hubbell shall not be liable for consequential, special, incidental, or contingent expenses or damages arising directly or indirectly from any defect in or use of the Product nor will Hubbell be liable for any water damage arising directly or indirectly from the use of the Product or from the failure of or defect in any component part or connecting plumbing. Hubbell and Buyer agree to these and the above terms in their entirety and accept all sales as final without recourse to a credit card company and hereby agree that this Manufacturer's Limited Warranty shall be governed by the laws of the State of Connecticut any and all actions arising from or relating to this Manufacturer's Limited Warranty and any aspects of the Product shall be brought in a court of competent jurisdiction in Fairfield County, Connecticut.

WARRANTY PROCEDURE

PARTS REPLACEMENT PROCEDURE (Under Warranty within 1 Year): Have your licensed electrician determine the exact parts that are defective and require replacement. Please note that technical support is available for qualified technicians only (licensed electricians and/or plumbers). Technical support that involves potentially dangerous electrical conditions is not available to an unqualified person. When contacting Hubbell, please be sure that the technician has read the "Operation and Maintenance Manual" and has written down all the data from the Advanced Troubleshooting Section.

If, at the sole discretion of Hubbell, a component requires repair or replacement under the terms of this Manufacturer's Limited Warranty, the part must be purchased and paid for under our "Bill and Credit" terms and will be shipped via standard ground delivery. All shipping charges are not included and are the responsibility of the Buyer. If faster shipping service is desired, the Buyer must select and pay for same.

The replacement part purchased under our "Bill and Credit" terms is purchased via credit card and upon return of the defective parts Hubbell will determine the cause of failure, and if under warranty will issue a full credit less shipping charges. The returned part must be received by Hubbell within thirty (30) days of shipment of the replacement part. Hubbell will evaluate the returned part within ten (10) days, and if determined to be defective and covered under terms of this warranty, full credit for the part will be issued.

Return warranty parts to: Hubbell Electric Heater

ATTN: Tankless Warranty 45 Seymour Street

Stratford, CT 06615