



# Installation and Operations Manual

H-IM-UC

August 2022

Part No. 25008201

Replaces June 2020

## Unit Coolers



*Scan QR codes in this manual, or scan Unit Cooler Cabinet for links to additional important information*

## Table of Contents

General Safety Information.....	2	Check Out and Start Up .....	5
Inspection .....	2	Operational Check Out.....	5
Warranty Statement .....	2	Evaporator Superheat.....	6
DOE Walk-In Cooler Freezer AWEF Set Points .....	2	Refrigerant Glide.....	6
Placement .....	2	2 Speed Motor Field Wiring .....	6
Minimum Unit Clearances.....	3	Expansion Valve Selection.....	7-8
Unit Cooler Mounting.....	4	Hot Gas Defrost Systems .....	9
Defrost Troubleshooting.....	4	Evaporator Troubleshooting .....	10
Field Wiring.....	4	InterLink™ Replacement Parts .....	10
Condensate Drain Lines .....	5	Discontinued Unit Coolers .....	11

## General Safety Information

1. Installation and maintenance to be performed only by qualified personnel who are familiar with this type of equipment.
2. Units are pressurized with dry air or inert gas. All units must be evacuated before charging the system with refrigerant.
3. Make sure that all field wiring conforms to the requirements of the equipment and all applicable national and local codes.
4. Avoid contact with sharp edges and coil surfaces. They are a potential injury hazard.
5. Make sure all power sources are disconnected before any service work is done on units.

**WARNING:** *Refrigerant can be harmful if it is inhaled. Refrigerant must be used and recovered responsibly. Failure to follow this warning may result in personal injury or death.*

## Inspection

Responsibility should be assigned to a dependable individual at the job site to receive material. Each shipment should be carefully checked against the bill of lading. The shipping receipt should not be signed until all items listed on the bill of lading have been accounted. Check carefully for concealed damage. Any shortage or damages should be reported to the delivering carrier. Damaged material becomes the delivering carrier's responsibility, and should not be returned to the manufacturer unless prior approval is given to do so. When uncrating, care should be taken to prevent damage. Heavy equipment should be left on its shipping base until it has been moved to the final location. Check the serial tag information with invoice. Report any discrepancies to your Heatcraft Refrigeration Products Sales Representative.

Units are pressurized with dry air or inert gas. The absence of pressure does not verify a leak. Check the coil for leaks before installing or returning it to your wholesaler.

## Warranty Statement

Seller warrants to its direct purchasers that products, including Service Parts, manufactured by SELLER shall be of a merchantable quality, free of defects in material or workmanship, under normal use and service for a period of one **(1) year from date of original installation, or eighteen (18) months from date of shipment** by SELLER, whichever first occurs. Any product covered by this order found to Seller's satisfaction to be defective upon examination at Seller's factory will at SELLER's option, be repaired or replaced and returned to Buyer via lowest common carrier, or SELLER may at its option grant Buyer a credit for the purchase price of the defective article. Upon return of a defective product to SELLER's plant, freight prepaid, by Buyer, correction of such defect by repair or replacement, and return freight via lowest common carrier, shall constitute full performance by SELLER of its obligations hereunder.

SELLER shall have no liability for expenses incurred for repairs made by Buyer except by prior, written authorization. Every claim on account of breach of warranty shall be made to SELLER in writing within the warranty period specified above – otherwise such claim shall be deemed waived. Seller shall have no warranty obligation whatsoever if its products have been subjected to alteration, misuse, negligence, free chemicals in system, corrosive atmosphere, accident, or if operation is contrary to SELLER's or manufacturer's recommendations, or if the serial number has been altered, defaced, or removed.

Seller makes no express warranties except as noted above. All implied warranties are limited to the duration of the Express Warranty. Liability for incidental and consequential damages is excluded.

The forgoing is in lieu of all other warranties, express or implied, notwithstanding the provisions of the uniform commercial code, the Magnuson-Moss Warranty - Federal Trade Commission Improvement Act, or any other statutory or common law, federal or state.

SELLER makes no warranty, express or implied, of fitness for any particular purpose, or of any nature whatsoever, with respect to products manufactures or sold by seller hereunder, except as specifically set forth above and on the face hereof. It is expressly understood and agreed that SELLER shall not be liable to buyer, or any customer of buyer, for direct or indirect, special, incidental, consequential or penal damages, or for any expenses incurred by reason of the use or misuse by buyer or third parties of said products. To the extent said products may be considered "consumer products," As defined in Sec. 101 of the Magnuson-Moss Warranty - Federal Trade Commission Improvement Act, SELLER makes no warranty of any kind, express or implied, to "consumers," except as specifically set forth above and on the face hereof.

### The following conditions should be adhered to when installing this unit to maintain the manufacturers warranty:

- (a) System piping must be in accordance with good refrigeration practices.

- (b) Inert gas must be charged into the piping during brazing.
- (c) The power supply to the unit must meet the following conditions:
  - A. Three phase voltages must be +/- 10% of nameplate ratings. Single phase must be within +10% or -5% of nameplate ratings.
  - B. Phase imbalance cannot exceed 2%.
- (d) All control and safety switch circuits must be properly connected according to the wiring diagram.
- (e) The factory installed wiring and piping must not be changed without written factory approval.
- (f) All equipment is installed in accordance with Heatcraft Refrigeration Products specified minimum clearances.

## Recommended Unit Cooler Placement

Some general rules for evaporator placement which must be followed are:

1. The air pattern must cover the entire room.
2. **NEVER** locate evaporators over doors.
3. Location of aisles, racks, etc. must be known.
4. Location relative to compressors for minimum pipe runs.
5. Location of condensate drains for minimum run.

The size and shape of the storage will generally determine the type and number of evaporators to be used and their location. The following are some typical examples:

**NOTE:** *Leave space equal to unit height between bottom of unit and product. Do not stack product in front of fans.*

## DOE Walk-In Cooler Freezer AWEF Set Points

Based on information currently available, following set points must be adhered to for DOE AWEF test conditions:

### Condensing Unit Minimum Head Pressure

LT - 100 psi

MT - 150 psi

### Evaporator Superheat

6.5°F

### Defrost Termination

LOP - 55°F      MP - 55°F

CM - 85°F      LUC - 55°F

LVCM - 50°F

### Unloader Pressure Control

MT - Below 23°F SST      LT - Below -22°F SST

Disclaimer: This communication is provided for informational purposes only and is based on information that is subject to change and interpretation. Heatcraft recommends customers review the applicable laws and regulations to ensure compliance with regulations. For DOE regulations, see US DOE Energy Efficiency and Renewable Energy website for Walk-In Coolers and Freezers at <https://www.regulations.doe.gov/ccms>

## Minimum Unit Clearances

**Figure 1. Medium Profile and Large Unit Coolers**

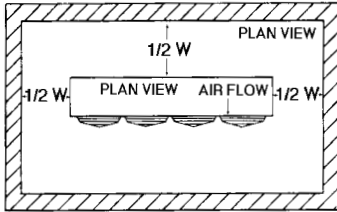

One evaporator

**NOTE:**  
W = Total width of evaporator coil surface.

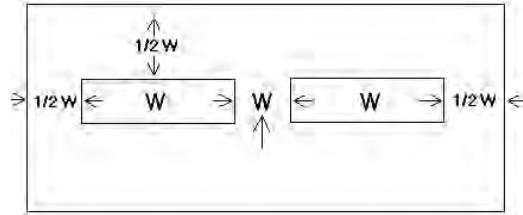

Two evaporators

**Figure 2. Low Profile Unit Coolers**

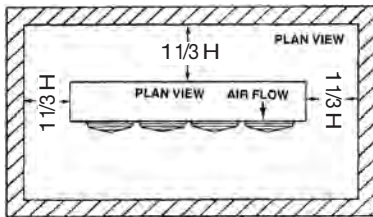

One evaporator

**NOTE:**  
H = Total height of evaporator coil surface.

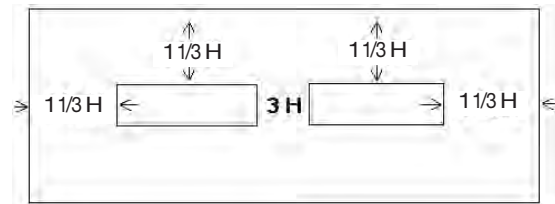

Two evaporators

**Figure 3. Center Mount Unit Coolers**

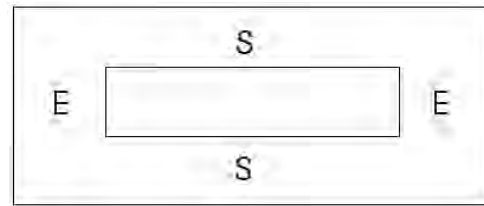
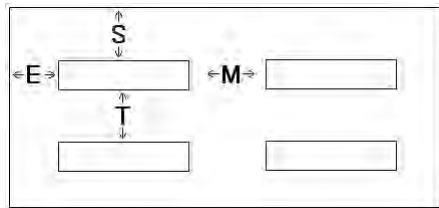

**Recommended Maximum - Minimum Dimensions for Center Mount Unit Cooler Installations.**

E		S		M		T	
Max.	Min.	Max.	Min.	Max.	Min.	Max.	Min.
25'	2'	20'	3'	40'	3'	40'	6'

## Unit Cooler Mounting

Most evaporators can be mounted with rod hangers, lag screws, or bolts. Use 5/16" bolt and washers or rod for up to 250 pounds, 3/8" for up to 600 pounds and 5/8" for over 600 pounds. Care should be taken to mount the units level so that condensate drains properly. Note that some unit cooler designs achieve drain pan slope by using different height mounting brackets. In this situation, the top of the mounting brackets should be level. Adequate support must be provided to hold the weight of the unit.

When using rod hangers, allow adequate space between the top of the unit and the ceiling for cleaning. To comply with NSF Standard 7, the area above the unit cooler must be sealed or exposed in such a way to facilitate hand

cleaning without the use of tools. When lagging or bolting the unit flush to the ceiling, seal the joint between the top and the ceiling with an NSF listed sealant and ends of open hanger channels must be sealed to prevent accumulation of foreign matter.

When locating unit coolers in a cooler or freezer, refer to Figures 1 through 4 for guidelines.

**NOTE: Always avoid placement of Unit Coolers direct above doors and door openings.**

**Figure 4. Large Coolers and Freezers Placement**

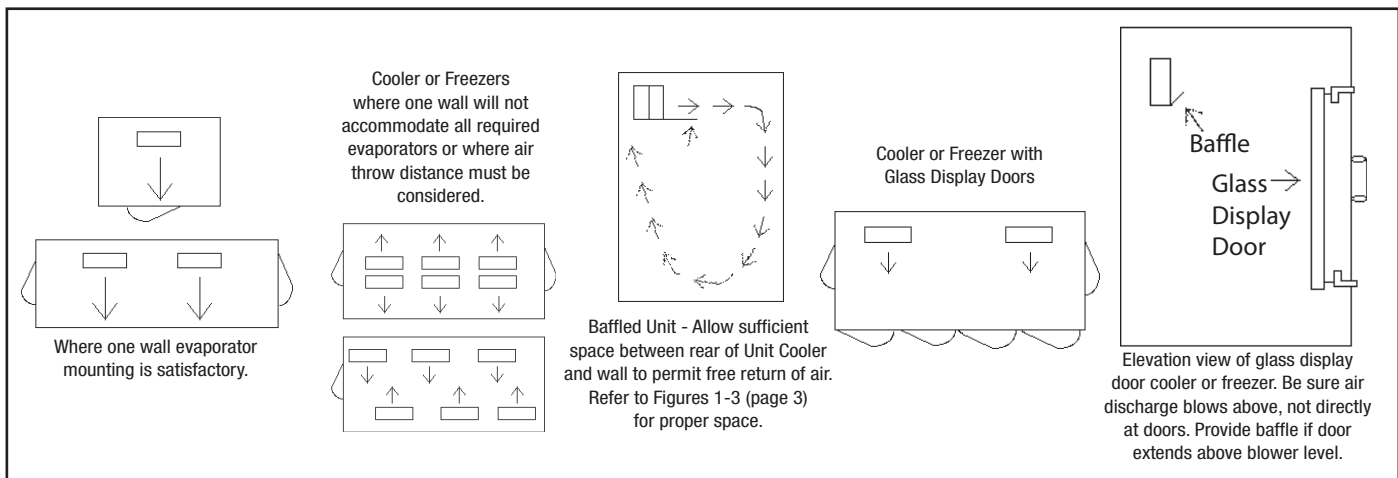

## Defrost Troubleshooting

### Fan Motor

If the motor does not operate or it cycles on thermal overload, remove motor leads from terminal block and apply correct voltage across the leads. If motor still does not operate satisfactorily, it must be replaced. Before starting the unit, rotate fan blades to make sure they turn freely and have sufficient clearance.

### Fan Delay & Defrost Termination Control

This control is a single pole double throw switch. The red lead wire is wired to common. The black wire is wired in series with the fan motors. The brown wire is wired in series with the defrost termination solenoid in the timer. The brown and red contacts close and the black and red contacts open when the temperature is above 55°F. The black and red contacts close and the brown and red contacts open when the temperature is below 35°F.

On initial "pull down" of a warm box the fan will not start until the coil temperature reaches approximately 35°F. If the box is still comparatively warm (60°F) when the fan starts, then blowing this warm air over the coil may cause it to warm up to 55°F and thus stop the fan. Therefore, the fan may recycle on initial "pull down." This control cannot be adjusted.

If the fan motor fails to start when the control is below 35°F, disconnect the fan motor leads and check the motor as described for fan motors. Also check whether current is being supplied at "N" and "4" from the timer. The fan delay control must be below 35°F when checking for a closed circuit.

### Defrost Heater

If unit shows very little or no defrosting and does not heat, disconnect heater and check to find if it is burned out. To test, apply correct voltage across heater or use continuity flashlight battery tester.

### Drain Pan

If drain pan has an ice build-up, drain line may be frozen. The drain line should be pitched sharply and exit cabinet as quickly as possible. Sometimes location and ambient at the drain outside of cabinet may cause freeze-up. A drain line heater may be required to correct the freeze-up. Any traps in the drain line must be located in a warm ambient.

## Field Wiring

The field wiring should enter the areas as provided on the unit. The wiring diagram for each unit is located on the inside of the electrical panel door. All field wiring should be done in a professional manner and in accordance with all governing codes. Before operating unit, double check all wiring connections, including the factory terminals. Factory connections can vibrate loose during shipment.

1. The serial data tag on the unit is marked with the electrical characteristic for wiring the unit.
2. Consult the wiring diagram in the unit cooler and in the condensing unit for proper connections.
3. Wire type should be of copper conductor only and of the proper size to handle the connected load.
4. The unit must be grounded.
5. For multiple evaporator systems, the defrost termination controls should be wired in series. Follow the wiring diagrams for multiple evaporator systems carefully. This will assure complete defrost of all evaporators in the system.
6. Multiple evaporator systems should operate off of one thermostat.
7. If a remote defrost timer is to be used, the timer should be located outside the refrigerated space.

**WARNING: All wiring must be done in accordance with applicable codes and local ordinances.**

## Condensate Drain Lines

Either copper or steel drain lines should be used and properly protected from freezing. In running drain lines, provide a minimum 1/4 inch per foot pitch for proper drainage. Drain lines should be at least as large as the evaporator drain connection. All plumbing connections should be made in accordance with local plumbing codes. All condensate drain lines must be trapped, and run to an open drain. They must never be connected directly to the sewer system. Traps in the drain line must be located in a warm ambient. We recommend a trap on each evaporator drain line prior to any tee connections. Traps located outside, or extensive outside runs of drain line must be wrapped with a drain line heater and covered with 3/8" minimum thickness pipe insulation. The heater should be connected so that it operates continuously. It is recommended that the drain line be insulated to prevent heat loss. A heat input of 20 watts per linear foot of drain line for 0°F (-18°C) room applications and 30 watts per linear foot for -20°F (-29°C) rooms is satisfactory. In freezers, the evaporator drain pan fitting should be included when heating and insulating the drain line.

Inspect drain pan periodically to insure free drainage of condensate. If drain pan contains standing water, check for proper installation. The drain pan should be cleaned regularly with warm soapy water.

**WARNING:** *All power must be disconnected before cleaning. Drain pan also serves as cover of hazardous moving parts. Operation of unit without drain pan constitutes a hazard.*

Traps on low temperature units must be outside of refrigerated enclosures. Traps subject to freezing temperatures must be wrapped with heat tape and insulated.

**NOTE:** *Always avoid placement of Unit Coolers direct above doors and door openings.*

**Figure 5. Condensate Drain Lines**

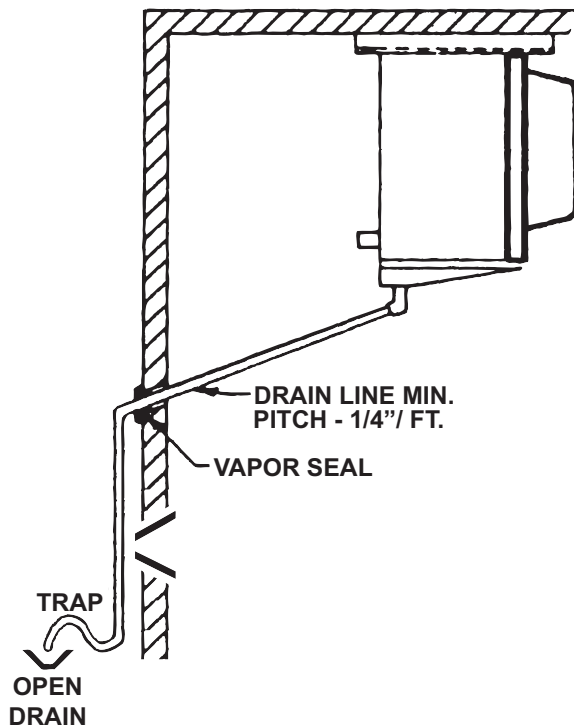

## Check Out and Start Up

**WARNING:** *All adjustable controls and valves must be field adjusted to meet desired operation. There are no factory preset controls or valve adjustments. This includes low pressure, high pressure, adjustable head pressure systems and expansion valves.*

After the installation has been completed, the following points should be covered before the system is placed in operation:

- (a) Check all electrical and refrigerant connections. Be sure they are all tight.
- (b) Check the room thermostat for normal operation and adjust.
- (c) Wiring diagrams, instruction bulletins, etc. attached to the condensing units should be read and filed for future reference.
- (d) All fan motors on evaporators should be checked for proper rotation. Fan motor mounts should be carefully checked for tightness and proper alignment.
- (e) Electric and hot gas evaporator fan motors should be temporarily wired for continuous operation until the room temperature has stabilized.
- (f) Do not leave unit unattended until the system has reached normal operating conditions and the oil charge has been properly adjusted to maintain the oil level between 1/4 and bottom of the sight glass.
- (g) Make sure all Schrader valve caps are in place and tight.

## Operational Check Out

After the system has been charged and has operated for at least two hours at normal operating conditions without any indication of malfunction, it should be allowed to operate overnight on automatic controls. Then a thorough recheck of the evaporator operation should be made as follows:

- (a) Check liquid line sight glass and expansion valve operation. If there are indications that more refrigerant is required, leak test all connections and system components and repair any leaks before adding refrigerant.
- (b) Thermostatic expansion valves must be checked for proper superheat settings. Sensing bulbs must be in positive contact with the suction line and should be insulated. Valves set at high superheat will lower refrigeration capacity. Low superheat promotes liquid slugging and compressor bearing washout.
- (c) Check defrost controls for initiation and termination settings and length of defrost period. Set fail safe at length of defrost + 25%.  
*Example: 20 minute defrost + 5 minutes = 25 minute fail safe*
- (d) Check drain pan for proper drainage.
- (e) Install instruction card and control system diagram for use of building manager or owner.

## Evaporator Superheat

Check Your Superheat. After the box temperature has reached or is close to reaching the desired temperature, the evaporator superheat should be checked and adjustments made if necessary. Generally, systems with a design TD of 10°F should have a superheat value of 6° to 10°F for maximum efficiency. For systems operating at higher TD's, the superheat can be adjusted to 12° to 15°F as required.

**NOTE:** *Minimum compressor suction superheat of 20°F may override these recommendations on some systems with short line runs.*

To properly determine the superheat of the evaporator, the following procedure is the method Heatcraft recommends:

**WARNING:** *If the condensing unit has no flooded condenser head pressure control, the condensing unit must have the discharge pressure above the equivalent 105°F condensing pressure.*

1. Measure the temperature of the suction line at the point the bulb is clamped.
2. Obtain the suction pressure at the access port located on the suction outlet header.
3. Convert the pressure obtained in 2. above to saturated evaporator temperature by using a temperature-pressure chart.
4. Subtract the saturated temperature from the actual suction line temperature. The difference is Superheat.

**Figure 6. Bulb and Contact Location**

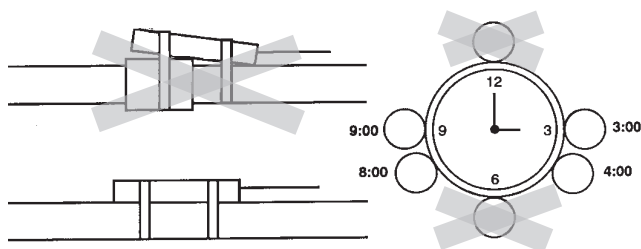

**Figure 7. Multiple Evaporators**

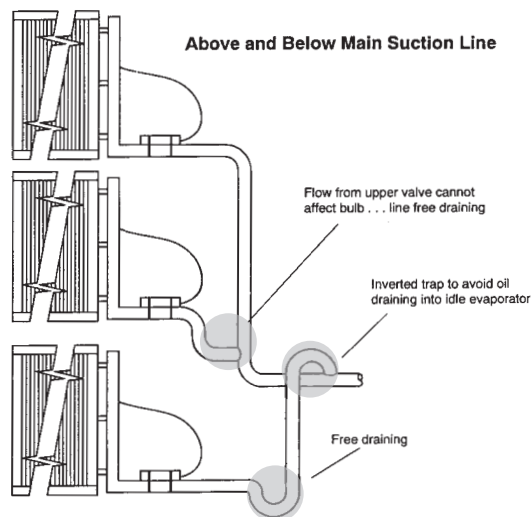

## Refrigerant Glide

To reach EPA-mandated lower global warming potential (GWP) levels, the commercial refrigeration industry has increasingly turned to refrigerant blends.

These blends are non-toxic, non-flammable and operate within the typical commercial refrigeration operating pressures.

Refrigerant blends such as R-404A, R-407A, R-407C, R-407F, R-448A and R-449A are a mixture of components that retain their individual evaporating and condensing points.

The range of temperature where these individual components evaporate or condense at a constant pressure called refrigerant glide.

With R-404A, the refrigerant glide is approximately 1F and can generally be ignored.

With R-407A, R-407C, R-407F, R-448A and R-449A refrigerant glide is much higher (6-10°F) and yields greater evaporator capacity (with colder evaporator surface temperatures) than R-404A at the same dew point evaporating temperature.

## Two Speed EC Motors

Unit coolers may be equipped with energy saving two-speed EC fan motors which run at full speed during active refrigeration and at a lower speed during the refrigeration off-cycle when room temperature has been reached.

Most unit coolers with two-speed EC motors require field wiring to provide a control input to the motors via a factory-installed relay. Refer to the following table for requirements:

**Heatcraft Unit Cooler Applications with 2-Speed Fan Motors- External Motor Control Wiring Requirements**

UNIT COOLER PRODUCT LINE	DEFROST TYPE	FACTORY CONTROL PACKAGE	TERMINAL BOARD WIRING POINTS FOR CONTROL CONTACT	CONTROL CONTACT CURRENT RATING	CONTROL CONTACT VOLTAGE RATING	CONTROL FIELD WIRING REQUIREMENTS		
ALL	ALL	FACTORY WIRE ROOM THERMOSTAT	NO FIELD WIRING NEEDED FOR FAN MOTOR CONTROL	N/A	N/A	N/A		
ALL	ALL	INTELLIGEN	NO FIELD WIRING NEEDED FOR FAN MOTOR CONTROL	N/A	N/A	N/A		
ALL	ALL	QUICK RESPONSE CONTROLLER	NO FIELD WIRING NEEDED FOR FAN MOTOR CONTROL	N/A	N/A	N/A		
LOW PROFILE	ALL	BEACON II	WIRE TO 2-POLE TERMINAL BLOCK NEXT TO CONTROL BOARD	5VA MIN	30V MIN	18 AWG 30V MIN (2 WIRES)		
CENTER MOUNT / LOW VELOCITY CENTER MOUNT	ALL		WIRE TO FAN CONTROL RELAY COIL					
MEDIUM PROFILE	ALL		WIRE TO FAN CONTROL RELAY COIL					
LARGE UNIT COOLER	ALL		WIRE TO FAN CONTROL RELAY COIL					
LOW PROFILE	AIR	NONE	K / T1	25VA min	300V min	18 AWG 300V MIN (2 WIRES)		
LOW PROFILE	ELECTRIC/ HOT GAS		K / 4					
CENTER MOUNT / LOW VELOCITY CENTER MOUNT	AIR		T1 / T3					
CENTER MOUNT / LOW VELOCITY CENTER MOUNT	ELECTRIC/ HOT GAS		J / 4					
MEDIUM PROFILE	AIR		K / T1 115V or 208V; 1 Phase					
MEDIUM PROFILE	AIR		K / 4 460V; 1Phase					
MEDIUM PROFILE	ELECTRIC/ HOT GAS		K / 4					
LARGE UNIT COOLER	AIR		T1/T2				4VA	192V min
LARGE UNIT COOLER	ELECTRIC/ HOT GAS		T1/T2					

**Table 3. Expansion Valve Selection 180# Head Pressure Valve**

BTUH at about 10°F T.D.	R-404A / R-507A		R-404A / R-507A		R-407A / R-407F		R-407A / R-407F		R-448A / R-449A		R-448A / R-449A	
	-20°F / -29°C Evap.		+25°F / -4°C Evap.		-20°F / -29°C Evap.		+25°F / -4°C Evap.		-20°F / -29°C Evap.		+25°F / -4°C Evap.	
	Sporlan	Alco	Sporlan	Alco	Sporlan	Alco	Sporlan	Alco	Sporlan	Alco	Sporlan	Alco
3,000-3,500	SQE-1(1/4T)-SZP	HFESC-1/4SZ	SQE-1(1/4T)-SC	HFESC-1/4SC	SQE-1(3/4T)-NZP	HFESC-1-HZ	SQE-0(1/3T)-NC	HFESC-1/2-HC	SQE-1(1/4T)-DZP	HFESC-1/2-BZ	SQE-0(1/6T)-DC	HFESC-1/2-BC
3,600-5,000	SQE-2(1/2T)-SZP	HFESC-1/2SZ	SQE-1(1/4T)-SC	HFESC-1/4SC	SQE-1(3/4T)-NZP	HFESC-1-HZ	SQE-1(3/4T)-NC	HFESC-1-HC	SQE-1(1/4T)-DZP	HFESC-1-BZ	SQE-1(1/4T)-DC	HFESC-1-BC
5,500-7,000	SQE-3(1T)-SZP	HFESC-1-SZ	SQE-2(1/2T)-SC	HFESC-1/2-SC	SQE-2(1T)-NZP	HFESC-1-1/2-HZ	SQE-1(3/4T)-NC	HFESC-1-HC	SQE-2(1/2T)-DZP	HFESC-1-BZ	SQE-1(1/4T)-DC	HFESC-1-BC
7,500-8,000	SQE-3(1T)-SZP	HFESC-1-SZ	SQE-3(1T)-SC	HFESC-1-SC	SQE-3(1-1/2T)-NZP	HFESC-1-1/2-HZ	SQE-1(3/4T)-NC	HFESC-1-1/2-HC	SQE-2(1/2T)-DZP	HFESC-1-BZ	SQE-2(1/2T)-DC	HFESC-1-BC
8,500-10,000	SQE-4(1-1/2T)-SZP	HFESC-1-1/2-SZ	SQE-3(1T)-SC	HFESC-1-SC	SQE-3(1-1/2T)-NZP	HFESC-2-HZ	SQE-2(1T)-NC	HFESC-1-1/2-HC	SQE-3(1T)-DZP	HFESC-1-1/2-BZ	SQE-2(1/2T)-DC	HFESC-1-1/2-BC
10,500-11,000	SQE-4(1-1/2T)-SZP	HFESC-1-1/2-SZ	SQE-4(1-1/2T)-SC	HFESC-1-1/2-SC	SQE-4(2-1/2T)-NZP	HFESC-2-HZ	SQE-3(1-1/2T)-NC	HFESC-1-1/2-HC	SQE-3(1T)-DZP	HFESC-1-1/2-BZ	SQE-2(1/2T)-DC	HFESC-1-1/2-BC
11,500-13,000	SQE-4(1-1/2T)-SZP	HFESC-1-1/2-SZ	SQE-4(1-1/2T)-SC	HFESC-1-1/2-SC	SQE-4(2-1/2T)-NZP	HFESC-2-1/2-HZ	SQE-3(1-1/2T)-NC	HFESC-2-HC	SQE-4(1-1/2T)-DZP	HFESC-2-BZ	SQE-3(1T)-DC	HFESC-1-1/2-BC
13,500-15,000	SQE-4(1-1/2T)-SZP	HFESC-1-1/2-SZ	SQE-4(1-1/2T)-SC	HFESC-1-1/2-SC	SQE-4(2-1/2T)-NZP	HFESC-2-1/2-HZ	SQE-3(1-1/2T)-NC	HFESC-2-HC	SQE-4(1-1/2T)-DZP	HFESC-2-BZ	SQE-3(1T)-DC	HFESC-2-BC
15,500-17,000	SQE-5(2T)-SZP	HFESC-2-SZ	SQE-4(1-1/2T)-SC	HFESC-1-1/2-SC	SQE-4(2-1/2T)-NZP	HFESC-3-HZ	SQE-4(2-1/2T)-NC	HFESC-2-1/2-HC	SQE-4(1-1/2T)-DZP	HFESC-2-1/2-BZ	SQE-4(1-1/2T)-DC	HFESC-2-BC
17,500-20,000	SQE-5(2T)-SZP	HFESC-2-SZ	SQE-5(2T)-SC	HFESC-2-SC	SQE-4(2-1/2T)-NZP	HFESC-3-HZ	SQE-4(2-1/2T)-NC	HFESC-2-1/2-HC	SQE-4(1-1/2T)-DZP	HFESC-2-1/2-BZ	SQE-4(1-1/2T)-DC	HFESC-2-1/2-BC
20,500-24,000	SQE-6(3T)-SZP	HFESC-3-1/2-SZ	SQE-6(3T)-SC	HFESC-3-1/2-SC	SQE-5(3-1/2T)-NZP	HFESC-5-1/2-HZ	SQE-4(2-1/2T)-NC	HFESC-3-HC	SQE-5(2T)-DZP	HFESC-3-1/2-BZ	SQE-4(1-1/2T)-DC	HFESC-3-1/2-BC
24,500-28,000	SSE-4-ZP	HFESC-3-1/2-SZ	SQE-6(3T)-SC	HFESC-3-1/2-SC	SQE-6(5T)-NZP	HFESC-5-1/2-HZ	SQE-5(3-1/2T)-NC	HFESC-3-HC	SQE-5(2T)-DZP	HFESC-3-1/2-BZ	SQE-5(2T)-DC	HFESC-3-1/2-BC
28,500-34,000	SSE-4-ZP	HFES-5-SZ	SSE-4-C	HFES-5-SC	SNE-5-ZP	HFESC-5-1/2-HZ	SQE-5(3-1/2T)-NC	HFESC-5-1/2-HC	SQE-6(3T)-DZP	HFES-6-BZ	SQE-5(2T)-DC	HFESC-3-1/2-BC
34,500-40,000	SSE-6-ZP	HFES-7-SZ	SSE-6-C	HFES-7-SC	SNE-8-ZP	HFES-8-HZ	SQE-6(5T)-NC	HFESC-5-1/2-HC	SDE-4-ZP	HFES-6-BZ	SQE-6(3T)-DC	HFES-6-BC
40,500-50,000	SSE-7-ZP	HFES-7-SZ	SSE-6-C	HFES-7-SC	ONE-10-ZP	HFES-8-HZ	SQE-6(5T)-NC	HFESC-5-1/2-HC	SDE-4-ZP	HFES-6-BZ	SDE-4-C	HFES-6-BC
50,500-60,000	SSE-7-ZP	HFES-7-SZ	SSE-7-C	HFES-7-SC	ONE-15-ZP	HFES-10-HZ	SNE-5-C	HFESC-5-1/2-HC	SDE-6-ZP	HFES-8-1/2-BZ	SDE-4-C	HFES-6-BC
60,500-70,000	OSE-12-ZP	TRAE-12-SZ	OSE-9-C	HFES-10-SC	ONE-15-ZP	HFES-15-HZ	SNE-8-C	HFES-8-HC	SDE-7-ZP	HFES-8-1/2-BZ	SDE-6-C	HFES-8-1/2-BC
70,500-80,000	OSE-12-ZP	TRAE-12-SZ	OSE-9-C	HFES-10-SC	ONE-15-ZP	HFES-15-HZ	SNE-8-C	HFES-10-HC	SDE-7-ZP	HFES-10-1/2-BZ	SDE-6-C	HFES-8-1/2-BC
80,500-90,000	OSE-12-ZP	TRAE-12-SZ	OSE-9-C	HFES-10-SC	ONE-20-ZP	HFES-15-HZ	ONE-10-C	HFES-15-HC	ODE-12-ZP	HFES-10-1/2-BZ	SDE-7-C	HFES-10-1/2-BC
90,500-100,000	OSE-12-ZP	TRAE-12-SZ	OSE-12-C	HFES-13-SC	ONE-20-ZP	TRAE-20-HZ	ONE-10-C	HFES-15-HC	ODE-17-ZP	HFES-16-BZ	SDE-7-C	HFES-10-1/2-BC
100,500-110,000	OSE-21-ZP	TRAE-20-SZ	OSE-12-C	HFES-13-SC	ONE-20-ZP	TRAE-20-HZ	ONE-15-C	TRAE-15-HC	ODE-17-ZP	HFES-16-BZ	ODE-12-C	HFES-16-BC
110,500-120,000	OSE-21-ZP	TRAE-20-SZ	OSE-12-C	HFES-13-SC	ONE-20-ZP	TRAE-20-HZ	ONE-15-C	TRAE-15-HC	ODE-17-ZP	HFES-16-BZ	ODE-12-C	HFES-16-BC
120,500-130,000	OSE-30-ZP	TRAE-30-SZ	OSE-12-C	HFES-13-SC	ONE-30-ZP	TRAE-30-HZ	ONE-15-C	TRAE-15-HC	ODE-17-ZP	HFES-16-BZ	ODE-12-C	HFES-16-BC
130,500-140,000	OSE-30-ZP	TRAE-30-SZ	OSE-21-C	TRAE-20-SC	ONE-30-ZP	TRAE-30-HZ	ONE-15-C	TRAE-15-HC	ODE-17-ZP	HFES-20-BZ	ODE-12-C	HFES-16-BC

**NOTES:**

1. Selections are optimized for systems using an air-cooled condensing unit.
2. For Medium temperature R507(A), valve power element will use a "P" code for refrigerant
3. Use R407A/R407F selections as a guide for R22/R407C applications, valve power element will use a "V" code for refrigerant (Sporlan)
4. An equivalent valve may be used in place of selection.

**Table 4. Expansion Valve Selection 150# Head Pressure Valve**

BTUH at about 10°F T.D.	R-404A / R-507A		R-404A / R-507A		R-407A / R-407F		R-407A / R-407F		R-448A / R-449A		R-448A / R-449A	
	-20°F / -29°C Evap.		+25°F / -4°C Evap.		-20°F / -29°C Evap.		+25°F / -4°C Evap.		-20°F / -29°C Evap.		+25°F / -4°C Evap.	
	Sporlan	Alco	Sporlan	Alco	Sporlan	Alco	Sporlan	Alco	Sporlan	Alco	Sporlan	Alco
3,000-4,000	SBFSE-AA-ZP	HFESC-1/2-SZ	SBFSE-AA-C	HFESC-1/2-SC	SBFNE-AA-ZP	HFESC-1-HZ	SBFNE-AA-C	HFESC-1-2-HC	SBFDE-AA-ZP	HFESC-1/2-BZ	SBFDE-AA-C	HFESC-1/2-BC
4,100-5,000	SBFSE-AA-ZP	HFESC-1/2-SZ	SBFSE-AA-C	HFESC-1-SC	SBFNE-AA-ZP	HFESC-1-HZ	SBFNE-AA-C	HFESC-1-HC	SBFDE-AA-ZP	HFESC-1-BZ	SBFDE-AA-C	HFESC-1-BC
5,500-7,000	SBFSE-A-ZP	HFESC-1-SZ	SBFSE-A-C	HFESC-1-SC	SBFNE-A-ZP	HFESC-1-HZ	SBFNE-AA-C	HFESC-1-HC	SBFDE-AA-ZP	HFESC-1-BZ	SBFDE-AA-C	HFESC-1-BC
7,500-8,000	SBFSE-A-ZP	HFESC-1-SZ	SBFSE-A-C	HFESC-1-SC	SBFNE-A-ZP	HFESC-1-1/2-HZ	SBFNE-A-C	HFESC-1-1/2-HC	SBFDE-A-ZP	HFESC-1-1/2-BZ	SBFDE-A-C	HFESC-1-1/2-BC
8,500-10,000	SBFSE-A-ZP	HFESC-1-SZ	SBFSE-A-C	HFESC-1-SC	SBFNE-A-ZP	HFESC-1-1/2-HZ	SBFNE-A-C	HFESC-1-1/2-HC	SBFDE-A-ZP	HFESC-1-1/2-BZ	SBFDE-A-C	HFESC-1-1/2-BC
10,500-11,000	SBFSE-A-ZP	HFESC-1-SZ	SBFSE-B-C	HFESC-2-SC	SBFNE-A-ZP	HFESC-2-HZ	SBFNE-A-C	HFESC-2-HC	SBFDE-A-ZP	HFESC-2-BZ	SBFDE-A-C	HFESC-2-BC
11,500-13,000	SBFSE-B-ZP	HFESC-1-1/2-SZ	SBFSE-B-C	HFESC-2-SC	SBFNE-B-ZP	HFESC-2-HZ	SBFNE-A-C	HFESC-2-HC	SBFDE-A-ZP	HFESC-2-BZ	SBFDE-A-C	HFESC-2-BC
13,500-15,000	SBFSE-B-ZP	HFESC-1-1/2-SZ	SBFSE-B-C	HFESC-2-SC	SBFNE-B-ZP	HFESC-3-HZ	SBFNE-A-C	HFESC-2-1/2-HC	SBFDE-A-ZP	HFESC-2-1/2-BZ	SBFDE-A-C	HFESC-2-1/2-BC
15,500-17,000	SBFSE-C-ZP	HFESC-2-SZ	SBFSE-B-C	HFESC-2-SC	SBFNE-B-ZP	HFESC-3-HZ	SBFNE-B-C	HFESC-2-1/2-HC	SBFDE-B-ZP	HFESC-2-1/2-BZ	SBFDE-B-C	HFESC-2-1/2-BC
17,500-20,000	SBFSE-C-ZP	HFESC-2-SZ	SBFSE-C-C	HFESC-3-1/2-SC	SBFNE-B-ZP	HFESC-3-HZ	SBFNE-B-C	HFESC-3-HC	SBFDE-B-ZP	HFESC-3-1/2-BZ	SBFDE-B-C	HFESC-2-1/2-BC
20,500-24,000	SBFSE-C-ZP	HFESC-3-1/2-SZ	SBFSE-C-C	HFESC-3-1/2-SC	SBFNE-C-ZP	HFESC-5-1/2-HZ	SBFNE-B-C	HFESC-3-HC	SBFDE-C-ZP	HFESC-3-1/2-BZ	SBFDE-B-C	HFESC-3-1/2-BC
24,500-28,000	OSE-6-ZP	HFES-5-SZ	SBFSE-C-C	HFESC-3-1/2-SC	SBFNE-C-ZP	HFESC-5-1/2-HZ	SBFNE-B-C	HFESC-5-1/2-HC	SBFDE-C-ZP	HFES-6-BZ	SBFDE-B-C	HFES-6-BC
28,500-34,000	OSE-6-ZP	HFES-5-SZ	OSE-6-C	HFES-5-SC	SBFNE-C-ZP	HFESC-5-1/2-HZ	SBFNE-C-C	HFESC-5-1/2-HC	SBFDE-C-ZP	HFES-6-BZ	SBFDE-C-C	HFES-6-BC
34,500-40,000	OSE-6-ZP	HFES-7-SZ	OSE-6-C	HFES-7-SC	ONE-10-C	HFES-8-HZ	SBFNE-C-C	HFESC-5-1/2-HC	ODE-7-ZP	HFES-6-BZ	SBFDE-C-C	HFES-6-BC
40,500-50,000	OSE-9-ZP	HFES-10-SZ	OSE-6-C	HFES-7-SC	ONE-10-C	HFES-8-HZ	SBFNE-C-C	HFES-8-HC	ODE-7-ZP	HFES-8-1/2-BZ	ODE-7-C	HFES-6-BC
50,500-60,000	OSE-9-ZP	HFES-10-SZ	OSE-9-C	HFES-7-SC	ONE-15-ZP	HFES-10-HZ	ONE-10-C	HFES-8-HC	ODE-12-ZP	HFES-10-1/2-BZ	ODE-7-C	HFES-8-1/2-BC
60,500-70,000	OSE-12-ZP	TRAE-12-SZ	OSE-9-C	HFES-10-SC	ONE-15-ZP	HFES-10-HZ	ONE-10-C	HFES-10-HC	ODE-12-ZP	HFES-10-1/2-BZ	ODE-7-C	HFES-10-1/2-BC
70,500-80,000	OSE-12-ZP	TRAE-12-SZ	OSE-9-C	HFES-10-SC	ONE-15-ZP	HFES-15-HZ	ONE-10-C	HFES-10-HC	ODE-12-ZP	HFES-16-BZ	ODE-12-C	HFES-10-1/2-BC
80,500-90,000	OSE-12-ZP	TRAE-12-SZ	OSE-12-C	HFES-10-SC	ONE-20-ZP	HFES-15-HZ	ONE-10-C	HFES-15-HC	ODE-17-ZP	HFES-16-BZ	ODE-12-C	HFES-10-1/2-BC
90,500-100,000	OSE-21-ZP	TRAE-20-SZ	OSE-12-C	HFES-13-SC	ONE-20-ZP	TRAE-20-HZ	ONE-15-C	HFES-15-HC	ODE-17-ZP	HFES-16-BZ	ODE-12-C	HFES-16-BC
100,500-110,000	OSE-21-ZP	TRAE-20-SZ	OSE-12-C	HFES-13-SC	ONE-20-ZP	TRAE-20-HZ	ONE-15-C	HFES-15-HC	ODE-17-ZP	HFES-16-BZ	ODE-12-C	HFES-16-BC
110,500-120,000	OSE-30-ZP	TRAE-30-SZ	OSE-21-C	TRAE-20-SC	ONE-20-ZP	TRAE-20-HZ	ONE-15-C	TRAE-15-HC	ODE-17-ZP	HFES-20-BZ	ODE-12-C	HFES-20-BC
120,500-130,000	OSE-30-ZP	TRAE-30-SZ	OSE-21-C	TRAE-20-SC	ONE-30-ZP	TRAE-30-HZ	ONE-20-C	TRAE-20-HC	ODE-17-ZP	HFES-20-BZ	ODE-12-C	HFES-20-BC
130,500-140,000	OSE-30-ZP	TRAE-30-SZ	OSE-21-C	TRAE-20-SC	ONE-30-ZP	TRAE-30-HZ	ONE-20-C	TRAE-20-HC	ODE-28-ZP	-	ODE-17-C	-

**NOTES:**

1. Selections are optimized for systems using an air-cooled condensing unit.
2. For Medium temperature R507(A), valve power element will use a "P" code for refrigerant
3. Use R407A/R407F selections as a guide for R22/R407C applications, valve power element will use a "V" code for refrigerant (Sporlan)
4. An equivalent valve may be used in place of selection.

**Table 5. Expansion Valve Selection 100# Head Pressure Valve**

BTUH at about 10°F T.D.	R-404A / R-507A		R-404A / R-507A		R-407A / R-407F		R-407A / R-407F		R-448A / R-449A		R-448A / R-449A	
	-20°F / -29°C Evap.		+25°F / -4°C Evap.		-20°F / -29°C Evap.		+25°F / -4°C Evap.		-20°F / -29°C Evap.		+25°F / -4°C Evap.	
	Sporlan	Alco	Sporlan	Alco	Sporlan	Alco	Sporlan	Alco	Sporlan	Alco	Sporlan	Alco
3,000-3,500	SBFSE-AA-ZP	HFESC-1/2-SZ	SBFSE-A-C	HFESC-1/2-SC	SBFNE-AA-ZP	HFESC-1-HZ	SBFNE-AA-C	HFESC-1/2-HC	SBFDE-AA-ZP	HFESC-1-BZ	SBFDE-AA-C	HFESC-1/2-BC
3,600-5,000	SBFSE-A-ZP	HFESC-1-SZ	SBFSE-A-C	HFESC-1-5C	SBFNE-AA-ZP	HFESC-1-1/2-HZ	SBFNE-AA-C	HFESC-1-HC	SBFDE-AA-ZP	HFESC-1-BZ	SBFDE-AA-C	HFESC-1-BC
5,500-7000	SBFSE-A-ZP	HFESC-1-SZ	SBFSE-B-C	HFESC-1-1/2-SC	SBFNE-A-ZP	HFESC-1-1/2-HZ	SBFNE-AA-C	HFESC-1-1/2-HC	SBFDE-A-ZP	HFESC-1-1/2-BZ	SBFDE-A-C	HFESC-1-1/2-BC
7,500-8,000	SBFSE-A-ZP	HFESC-1-SZ	SBFSE-B-C	HFESC-2-5C	SBFNE-A-ZP	HFESC-2-HZ	SBFNE-A-C	HFESC-1-1/2-HC	SBFDE-A-ZP	HFESC-1-1/2-BZ	SBFDE-A-C	HFESC-1-1/2-BC
8,500-10,000	SBFSE-B-ZP	HFESC-1-1/2-SZ	SBFSE-B-C	HFESC-2-5C	SBFNE-A-ZP	HFESC-3-HZ	SBFNE-A-C	HFESC-2-HC	SBFDE-A-ZP	HFESC-2-BZ	SBFDE-A-C	HFESC-1-1/2-BC
10,500-11,000	SBFSE-B-ZP	HFESC-1-1/2-SZ	SBFSE-B-C	HFESC-2-5C	SBFNE-B-ZP	HFESC-3-HZ	SBFNE-A-C	HFESC-2-HC	SBFDE-A-ZP	HFESC-2-BZ	SBFDE-A-C	HFESC-1-1/2-BC
11,500-13,000	SBFSE-B-ZP	HFESC-1-1/2-SZ	SBFSE-C-C	HFESC-3-1/2-5C	SBFNE-B-ZP	HFESC-3-HZ	SBFNE-A-C	HFESC-2-1/2-HC	SBFDE-A-ZP	HFESC-2-1/2-BZ	SBFDE-A-C	HFESC-2-BC
13,500-15,000	SBFSE-C-ZP	HFESC-2-SZ	SBFSE-C-C	HFESC-3-1/2-5C	SBFNE-B-ZP	HFESC-3-HZ	SBFNE-B-C	HFESC-2-1/2-HC	SBFDE-B-ZP	HFESC-2-1/2-BZ	SBFDE-B-C	HFESC-2-1/2-BC
15,500-17,000	SBFSE-C-ZP	HFESC-2-SZ	SBFSE-C-C	HFESC-3-1/2-5C	SBFNE-B-ZP	HFESC-5-1/2-HZ	SBFNE-B-C	HFESC-3-HC	SBFDE-B-ZP	HFESC-3-1/2-BZ	SBFDE-B-C	HFESC-2-1/2-BC
17,500-20,000	SBFSE-C-ZP	HFESC-3-1/2-SZ	OSE-6-C	HFES-5-5C	SBFNE-C-ZP	HFESC-5-1/2-HZ	SBFNE-B-C	HFESC-3-HC	SBFDE-B-ZP	HFESC-3-1/2-BZ	SBFDE-B-C	HFESC-2-1/2-BC
20,500-24,000	OSE-6-ZP	HFES-5-SZ	OSE-6-C	HFES-5-5C	SBFNE-C-ZP	HFESC-5-1/2-HZ	SBFNE-B-C	HFESC-5-1/2-HC	SBFDE-C-ZP	HFES-6-BZ	SBFDE-B-C	HFESC-3-1/2-BC
24,500-28,000	OSE-6-ZP	HFES-5-SZ	OSE-6-C	HFES-7-5C	SBFNE-C-ZP	HFESC-5-1/2-HZ	SBFNE-C-C	HFESC-5-1/2-HC	SBFDE-C-ZP	HFES-6-BZ	SBFDE-C-C	HFES-6-BC
28,500-34,000	OSE-6-ZP	HFES-5-SZ	OSE-6-C	HFES-7-5C	ONE-10-C	HFES-8-HZ	SBFNE-C-C	HFESC-5-1/2-HC	ODE-7-ZP	HFES-6-BZ	SBFDE-C-C	HFES-6-BC
34,500-40,000	OSE-9-ZP	HFES-7-SZ	OSE-9-C	HFES-10-5C	ONE-10-C	HFES-10-HZ	SBFNE-C-C	HFES-8-HC	ODE-7-ZP	HFES-8-1/2-BZ	ODE-7-C	HFES-6-BC
40,500-50,000	OSE-9-ZP	HFES-7-SZ	OSE-9-C	HFES-10-5C	ONE-10-C	HFES-10-HZ	ONE-10-C	HFES-8-HC	ODE-7-ZP	HFES-8-1/2-BZ	ODE-7-C	HFES-8-1/2-BC
50,500-60,000	OSE-12-ZP	TRAE-12-SZ	OSE-12-C	HFES-10-5C	ONE-15-ZP	HFES-15-HZ	ONE-10-C	HFES-10-HC	ODE-12-ZP	HFES-10-1/2-BZ	ODE-7-C	HFES-10-1/2-BC
60,500-70,000	OSE-12-ZP	TRAE-12-SZ	OSE-12-C	HFES-13-5C	ONE-15-ZP	HFES-15-HZ	ONE-10-C	HFES-15-HC	ODE-12-ZP	HFES-16-BZ	ODE-7-C	HFES-10-1/2-BC
70,500-80,000	OSE-21-ZP	TRAE-20-SZ	OSE-12-C	HFES-13-5C	ONE-20-ZP	TRAE-20-HZ	ONE-10-C	HFES-15-HC	ODE-12-ZP	HFES-16-BZ	ODE-12-C	HFES-10-1/2-BC
80,500-90,000	OSE-21-ZP	TRAE-20-SZ	OSE-21-C	TRAE-20-5C	ONE-20-ZP	TRAE-20-HZ	ONE-15-C	TRAE-15-HC	ODE-17-ZP	HFES-16-BZ	ODE-12-C	HFES-10-1/2-BC
90,500-100,000	OSE-30-ZP	TRAE-30-SZ	OSE-21-C	TRAE-20-5C	ONE-20-ZP	TRAE-20-HZ	ONE-15-C	TRAE-15-HC	ODE-17-ZP	HFES-16-BZ	ODE-12-C	HFES-16-BC
100,500-110,000	OSE-30-ZP	TRAE-30-SZ	OSE-21-C	TRAE-20-5C	ONE-30-ZP	TRAE-30-HZ	ONE-15-C	TRAE-15-HC	ODE-17-ZP	HFES-20-BZ	ODE-12-C	HFES-16-BC
110,500-120,000	OSE-30-ZP	TRAE-30-SZ	OSE-21-C	TRAE-20-5C	ONE-30-ZP	TRAE-30-HZ	ONE-15-C	TRAE-15-HC	ODE-17-ZP	HFES-20-BZ	ODE-17-C	HFES-20-BC
120,500-130,000	OSE-30-ZP	TRAE-30-SZ	OSE-30-C	TRAE-30-5C	ONE-30-ZP	TRAE-30-HZ	ONE-20-C	TRAE-20-HC	ODE-28-ZP	—	ODE-17-C	HFES-20-BC
130,500-140,000	OSE-30-ZP	TRAE-30-SZ	OSE-30-C	TRAE-30-5C	ONE-30-ZP	TRAE-30-HZ	ONE-20-C	TRAE-20-HC	ODE-28-ZP	—	ODE-17-C	HFES-20-BC

**NOTES:**

1. Selections are optimized for systems using an air-cooled condensing unit.
2. For Medium temperature R507(A), valve power element will use a "P" code for refrigerant
3. Use R407A/R407F selections as a guide for R22/R407C applications, valve power element will use a "V" code for refrigerant (Sporlan)
4. An equivalent valve may be used in place of selection.

## Hot Gas Defrost Systems

Hot Gas Defrost systems can be described as reverse cycle, re-evap., or alternating evaporator. Please see manual **H-IM-HGD** for Mohave™ systems on Heatcraft Website: [www.heatcraftprd.com](http://www.heatcraftprd.com)

### Refrigerant Piping

Install all refrigerant components in accordance with applicable local and national codes and in accordance with good practice for proper system operation. The thermostatic expansion valve must be the externally equalized type. It can be mounted inside the unit end compartment. Mount the expansion valve bulb on a horizontal run of suction line as close as possible to the suction header. Use the clamps provided with the valve to fasten the bulb securely so there is a tight line-to-line contact between the bulb and the suction header. Suction and hot gas connections are made on the outside of the unit.

Suction lines should be sloped towards the compressor at the rate of one (1) inch per ten (10) feet for good oil return. Vertical risers of more than four (4) feet should be trapped at the bottom with a P-trap. If a P-trap is used, the expansion valve bulb should be installed between the unit and the trap.

### Reverse Cycle System

The hot gas unit coolers can be used in reverse cycle hot gas defrost systems using multiple evaporators connected to one condensing unit. Generally, not more than one-third of the system defrosts at one time. During the reverse cycle defrost, the reversing valve, located in the compressor discharge line, diverts hot gas through the suction line to the evaporator.

See the piping view in the Reverse Cycle Defrost Piping diagram. The suction line check valve directs the hot gas through the drain pan loop which prevents condensate in the pan from freezing. The hot gas exits the loop at the pan loop outlet header and enters the evaporator through the check valve assembly. As the hot gas defrosts the coil, heat is removed from the hot gas and eventually it condenses into a liquid and exits the coil at the distributor side port. The liquid then flows through the check valve of the thermostatic expansion valve bypass assembly, around the thermostatic expansion valve, and into the system liquid line. The liquid refrigerant then feeds other evaporators on the cooling cycle, evaporates, and returns to the compressor through their suction lines.

### REVERSE CYCLE DEFROST PIPING

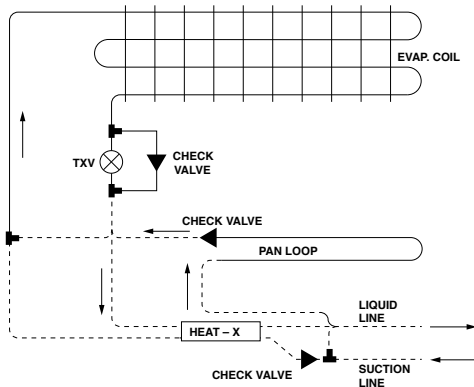

## Three Pipe System

The three pipe system (sometimes called re-evap.) uses three pipes: one for liquid line, one for suction line, and one for hot gas line. In addition, a re-evaporator accumulator is used at the suction outlet of the evaporator. The hot gas is taken from the discharge line between the compressor and the condenser, through a hot gas solenoid valve, then to the evaporator drain pan circuit, distributor tee, through the coil. See the Three-Pipe Defrost Piping Diagram for typical piping at the evaporator coil.

### Alternating Evaporator System

In the alternating evaporator hot gas defrost system, a third line is taken off the compressor discharge line as the re-evap system. It is piped with solenoids at each evaporator, so that hot gas defrost is accomplished on one or more evaporators while the remaining evaporators continue to function in a normal manner. The liquid from defrosting evaporators is reintroduced to the main liquid line and it is necessary that 75% or greater capacity be retained in the normal refrigeration cycle to offset the capacity that is being removed by the units on the hot gas defrost.

**IMPORTANT:** It is imperative that with the alternating evaporator hot gas defrost system, no more that 25% of the operating refrigeration load be in defrost at any time.

### Hot gas line sizes for R-404A, R-407\*, R-448A/R-449A

System Capacity BTU/Hr	Equivalent Discharge Length (Ft.)				
	25	50	75	100	150
4,000	1/2	1/2	1/2	1/2	1/2
5,000	1/2	1/2	1/2	1/2	1/2
6,000	1/2	1/2	1/2	5/8	5/8
7,000	1/2	1/2	5/8	5/8	5/8
8,000	1/2	5/8	5/8	5/8	5/8
9,000	1/2	5/8	5/8	5/8	5/8
10,000	1/2	5/8	5/8	5/8	5/8
12,000	5/8	5/8	5/8	7/8	7/8
14,000	5/8	5/8	7/8	7/8	7/8
16,000	5/8	5/8	7/8	7/8	7/8
18,000	5/8	7/8	7/8	7/8	7/8
20,000	5/8	7/8	7/8	7/8	7/8
25,000	7/8	7/8	7/8	7/8	1-1/8
30,000	7/8	7/8	7/8	1-1/8	1-1/8
35,000	7/8	7/8	1-1/8	1-1/8	1-1/8
40,000	7/8	1-1/8	1-1/8	1-1/8	1-1/8
45,000	7/8	1-1/8	1-1/8	1-1/8	1-1/8
50,000	7/8	1-1/8	1-1/8	1-1/8	1-1/8
60,000	1-1/8	1-1/8	1-1/8	1-3/8	1-3/8
70,000	1-1/8	1-1/8	1-3/8	1-3/8	1-3/8
80,000	1-1/8	1-1/8	1-3/8	1-3/8	1-5/8
90,000	1-1/8	1-3/8	1-3/8	1-5/8	1-5/8
100,000	1-1/8	1-3/8	1-3/8	1-5/8	1-5/8

Note: Use next larger hot gas line size for -20°F. and lower suction temperatures.

### THREE-PIPE DEFROST PIPING

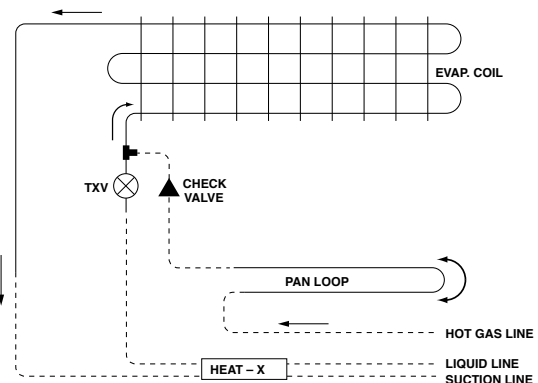

**Table 3. Evaporator Troubleshooting Chart**

SYMPTOMS	POSSIBLE CAUSES	POSSIBLE CORRECTIVE STEPS
Fan(s) will not operate.	<ol style="list-style-type: none"> <li>1. Main switch open.</li> <li>2. Blown fuses.</li> <li>3. Defective motor.</li> <li>4. Defective timer or defrost thermostat.</li> <li>5. Unit in defrost cycle.</li> <li>6. Coil does not get cold enough to reset thermostat.</li> </ol>	<ol style="list-style-type: none"> <li>1. Close switch.</li> <li>2. Replace fuses. Check for short circuits or overload conditions.</li> <li>3. Replace motor.</li> <li>4. Replace defective component.</li> <li>5. Wait for completion of cycle.</li> <li>6. Adjust fan delay setting of thermostat. See Defrost Thermostat Section of this bulletin.</li> </ol>
Room temperature too high.	<ol style="list-style-type: none"> <li>1. Room thermostat set too high.</li> <li>2. Superheat too high.</li> <li>3. System low on refrigerant.</li> <li>4. Coil iced-up.</li> <li>5. Unit cooler located too close to doors.</li> <li>6. Heavy air infiltration.</li> </ol>	<ol style="list-style-type: none"> <li>1. Adjust thermostat.</li> <li>2. Adjust thermal expansion valve.</li> <li>3. Add refrigerant.</li> <li>4. Manually defrost coil. Check defrost controls for malfunction.</li> <li>5. Relocate unit cooler or add strip curtain to door opening.</li> <li>6. Seal unwanted openings in room.</li> </ol>
Ice accumulating on ceiling around evaporator and/or on fan guards venturi or blades.	<ol style="list-style-type: none"> <li>1. Defrost duration is too long.</li> <li>2. Fan delay not delaying fans after defrost period.</li> <li>3. Defective defrost thermostat or timer.</li> <li>4. Too many defrosts.</li> </ol>	<ol style="list-style-type: none"> <li>1. Adjust defrost termination thermostat.</li> <li>2. Defective defrost thermostat or not adjusted properly.</li> <li>3. Replace defective component.</li> <li>4. Reduce number of defrosts.</li> </ol>
Coil not clearing of frost during defrost cycle.	<ol style="list-style-type: none"> <li>1. Coil temperature not getting above freezing point during defrost.</li> <li>2. Not enough defrost cycles per day.</li> <li>3. Defrost cycle too short.</li> <li>4. Defective timer or defrost thermostat.</li> </ol>	<ol style="list-style-type: none"> <li>1. Check heater operation.</li> <li>2. Adjust timer for more defrost cycles.</li> <li>3. Adjust defrost thermostat or timer for longer cycle.</li> <li>4. Replace defective component.</li> </ol>
Ice accumulating in drain pan	<ol style="list-style-type: none"> <li>1. Defective heater.</li> <li>2. Unit not pitched properly.</li> <li>3. Drain line plugged.</li> <li>4. Defective drain line heater.</li> <li>5. Defective timer or thermostat.</li> </ol>	<ol style="list-style-type: none"> <li>1. Replace heater.</li> <li>2. Check and adjust if necessary.</li> <li>3. Clean drain line.</li> <li>4. Replace heater.</li> <li>5. Replace defective component.</li> </ol>
Uneven coil frosting	<ol style="list-style-type: none"> <li>1. Defective heater.</li> <li>2. Located too close to door or opening.</li> <li>3. Defrost termination set too low.</li> <li>4. Incorrect or missing distributor nozzle.</li> </ol>	<ol style="list-style-type: none"> <li>1. Replace heater.</li> <li>2. Relocate evaporator.</li> <li>3. Adjust defrost termination setting higher.</li> <li>4. Add or replace nozzle with appropriately sized orifice for conditions.</li> </ol>



InterLink is your link to a complete line of dependable and certified commercial refrigeration parts, accessories and innovative electronic controls for all Heatcraft Refrigeration Products (HRP) brands - including Bohn, Larkin, Climate Control and Chandler. At InterLink, we provide our wholesalers with a comprehensive selection of product solutions and innovative technologies for the installed customer base. And every product is built to ensure the same high performance standards with which all HRP brands are built — backed by a dedicated team to serve every customer need, delivering at the best lead times in the industry.

Replacement parts should be obtained from your local InterLink wholesaler. Replacement parts, which are covered under the terms of the warranty statement on page 2 of this manual, will be reimbursed for total part cost only. The original invoice from the parts supplier must accompany all warranty claims for replacement part reimbursement. Heatcraft Refrigeration Products reserves the right to adjust the compensation amount paid on any parts submitted for warranty reimbursement when a parts supplier's original invoice is not provided with a claim. **For more information, call 800-686-7278 or visit [www.interlinkparts.com](http://www.interlinkparts.com).**

## Slim Contour Exclusive Information

The Slim Contour has several exclusive features that improve the serviceability.

### Cassette Removal/Replacement

Removal of modular cassettes in the Slim Contour improve access and the speed required to service the unit cooler.

1. Turn off electrical feed to the unit.
2. Remove the fan guard (2 Screws).
3. Remove screws from modular cassette and pull cassette forward, but do not fully remove cassette. (Figure 8)
4. With the cassette slightly removed, reach behind the cassette and unplug wired connection. This will separate the cassette from unit cooler. (Figure 9)
5. Once the cassette has been removed from the unit cooler, the cassette can be stored on the unit by using the service clip feature. (Figure 10)
6. To reinstall cassette, reconnect plug and slide cassette back into place. Re-secure the cassette by placing screws in place.

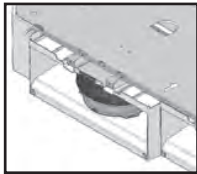

Figure 8.  
Cassette Removal (Step 3)

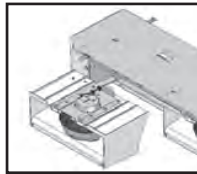

Figure 9.  
Cassette Removal (Step 4)

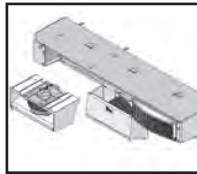

Figure 10.  
Cassette Removal (Step 5)

### Service Clip Features

The Slim Contour features a service clip on all of its modular cassettes. The service clip is exclusive to Slim Contour cassettes and is designed to improve the serviceability of the unit cooler. The service clip features two separate hooks that can be used to aide in common maintenance.

The service clip that is featured on top of the cassettes motor can be used to suspend the cassette while being removed to assist in removing the power connection of the cassette( Figure 11). The Slim Contour cassette also can be suspended from the drain pan using the screw mounts (Figure 12).

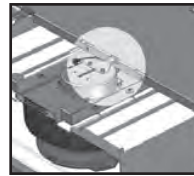
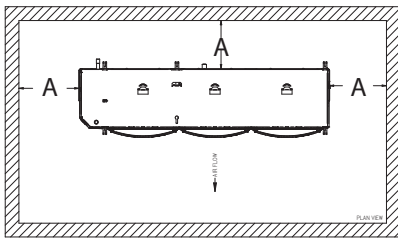

Figure 11.  
Service Clip (Feature 1)

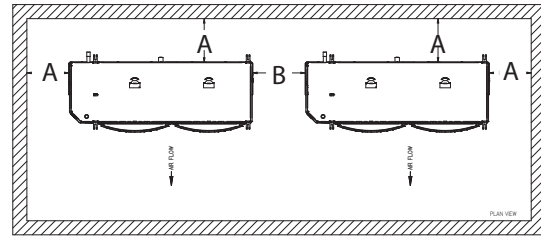

Figure 12.  
Service Clip (Feature 2)

### Figure 3A. Slim Contour Unit Coolers



	Min
A	18"
B	36"



**For more detailed information on the following topics, please visit <http://heatcraftprd.com/service/publibrary.asp> for our complete Refrigeration Systems Installation and Operation Manual (H-IM-64L).**

Defrost Thermostat  
Expansion Valves & Nozzles  
Refrigerant Oils  
Recommended Refrigerant Piping Practices  
Line Sizing Charts  
Hot Gas Defrost Systems  
Evacuation and Leak Detection

Refrigerant Charging Instructions  
System Balancing — Compressor Superheat  
General Sequence and Operation  
Troubleshooting Guides  
Preventive Maintenance Guidelines  
Typical Wiring Diagrams

*Since product improvement is a continuing effort, we reserve the right to make changes in specifications without notice.*

The name behind the brands you trust.™



**BOHN**

*CLIMATE*  
  
**CONTROL**

**InterLINK**  
Commercial Refrigeration Parts

**CHANDLER**  
REFRIGERATION

  
**LARKIN**