

OPERATOR'S MANUAL

SwingMan-20/25

16"x20" & 20"x25" Swing Away Heat Transfer Machines

EVO TOUCH

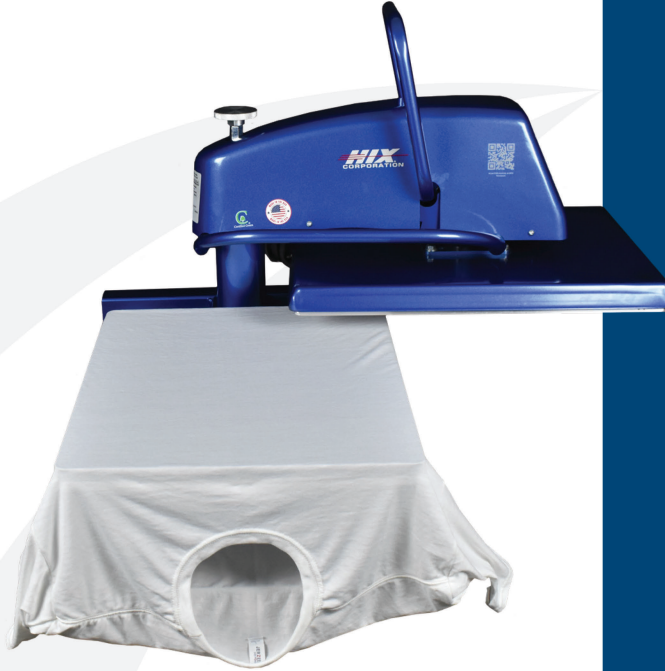

For Customer Service:
Call 1-800-835-0606 or Visit hixcorp.com

HIX CORPORATION



CONTENTS

<i>Receiving & Setup</i>	3
<i>Power</i>	4
<i>User Adjustable Settings</i>	5
<i>Machine Presets</i>	6
<i>Platen Pressure</i>	7
<i>Transfer Application</i>	8
<i>Troubleshooting</i>	9-12
<i>Repairs</i>	13
<i>Maintenance</i>	13
<i>Repairs</i>	15
<i>Parts List</i>	14-17
<i>Warranty</i>	18

BEFORE warranty repair you MUST get Prior Authorization



Intertek



Certified Green

RECEIVING & SETUP

SHIPPING OR RETURNS

NOTE *Save all of your shipping/packing material. Do not risk costly shipping damage, ship only in original box.*

1. Fasten machine to plywood shipping base with bolts provided.
2. Tie or tape handle securely to base.
3. Place in original box, and put side liner and top liner in place. Fold flaps and seal the box. (Additional bottom boards, box and liners may be obtained from your supplier for a normal cost.)

UNPACKING

Remember to save all packing material - including box, liner and board. You may need these for shipping your machine or if a repair is necessary in the future.

INSPECTION

Inspect your machine for hidden shipping damage. Contact the delivery company immediately, should you find damage.

INSTALLATION

1. Remove plywood shipping base bolts (see A and B) and screw on feet or affix self-adhesive rubber feet provided.

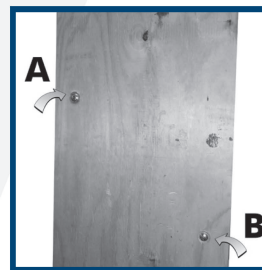
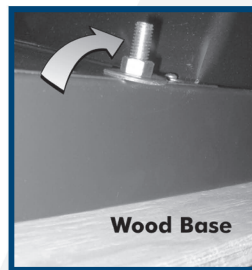

CAUTION: Handle must be tied to base before moving or shipping.

2. Carefully cut tape/wrap holding the machine closed.
3. Plug the machine into the correct grounded electrical outlet.

WARNING: When using an extension cord, use 12 or 14 ga.-3 conductor.
Maximum length, 25' (7.762 m).

POWER

TURNING THE POWER “ON”

1. Once the machine is plugged into power, the display will show a “Red Icon” as shown below. To turn the power on to the machine, simply press the Red Icon.

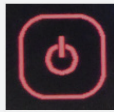

2. The display will then come on and look similar to what is shown below.

To turn the Power “OFF” to the machine, simply press the Green “Power” Icon in the upper right corner of the display and the machine will turn “OFF.”



To adjust the temperature or time settings, simply press the “UP” or “DOWN” arrows to change the values.

As the temperature is warming up from a cold start, the temperature digits will be RED when the heat platen temperature is more than 10 degrees away from desired set point temperature.

When the platen temperature is less than 10 degrees, but more than 5 degrees from the desired set point the temperature displayed will be YELLOW.

When the platen temperature displayed is within 5 degrees of the desired set point, the temperature digits will be GREEN.

When the actual platen temperature reaches the set point, the controller will BEEP.

3. A little “Red Dot” shown above in the lower left corner of the temperature display window represents the “Heat Light.” This indicator will be on when the controller is applying power to the heating element. It is normal for this indicator to flash on and off as heat is required.

USER ADJUSTABLE SETTINGS

USER ADJUSTABLE SETTINGS

Pressing the “GEAR” Icon  in the upper left corner of the Home Screen will switch the screen to the user settings menu, shown below.

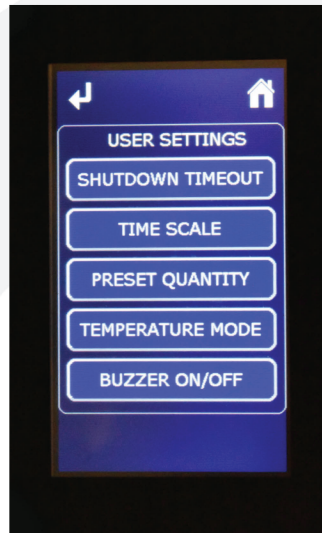

Pressing the “Back Arrow” Icon in the upper left corner of the display will take you to the previous screen.

Pressing the “Home” Icon in the upper right corner of the display will take you to the “HOME” Screen.

Pressing any of the USER SETTINGS buttons will take you to one of the screens shown below where you can adjust the machine settings to your preferences.

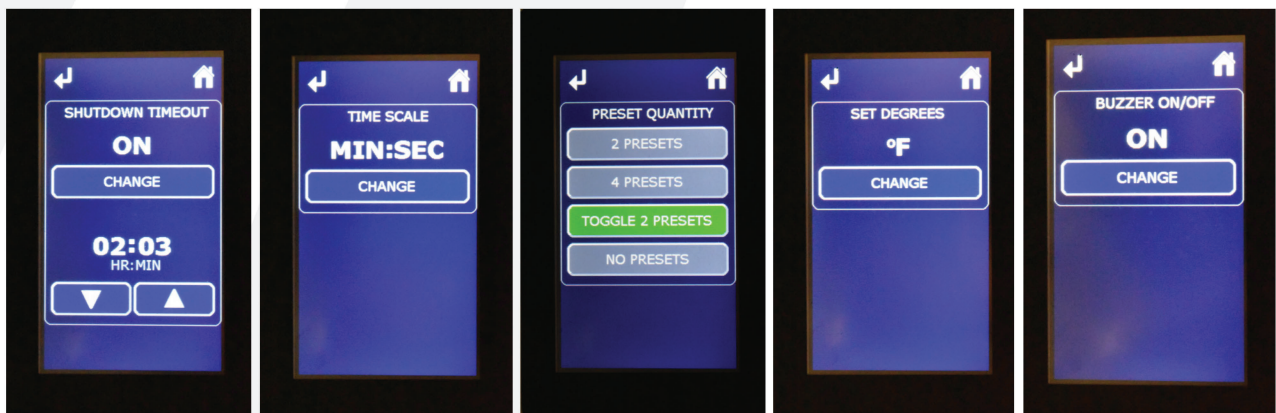

Once you have made the desired adjustments, press the “Back Arrow” or “Home” Icon.

Any changes in any of the settings or values you have made will be automatically stored as you leave that screen.

MACHINE PRESETS

PRESETS FOR TIME & TEMPERATURE SETTINGS

The controller has several Time and Temperature Preset options (No Presets, Two Presets, Four Presets, Toggle Two Presets) which are selectable in the “User Adjustable Settings” as outlined on the previous page.

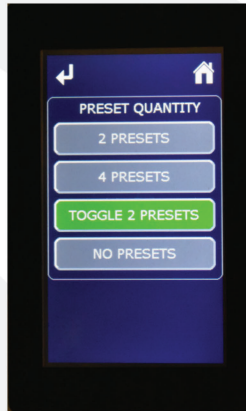

ON THE HOME SCREEN

If one of the buttons is “GREEN” then that button is the ACTIVE time and temperature preset on the controller. See below:

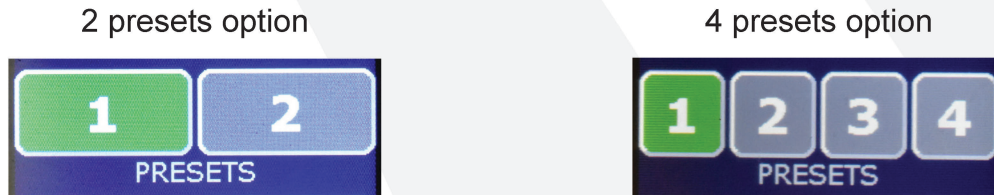

If you wish to make an adjustment to the time or temperature, simply press the UP/DOWN arrows next to the Time or Temperature values to change the number to the new setting desired.

NOTE: You will notice when you change either the Time or the Temperature away from the preset values, all the preset buttons will turn “Gray.”

To store the new Time or Temperature value(s) in a preset button location, simply press and HOLD on the desired preset button for 2 seconds. Once the new values are stored, the button will turn GREEN and the controller will BEEP to acknowledge the new values are stored.

To “recall” a preset, simply touch on the desired preset button and the Time and Temperature setting stored in that location will be recalled and displayed in the Time and Temperature values.

PLATEN PRESSURE

PRESSURE CONTROL KNOB

The pressure control knob, located on the top of the machine, should be set so that the heat will lock down firmly.

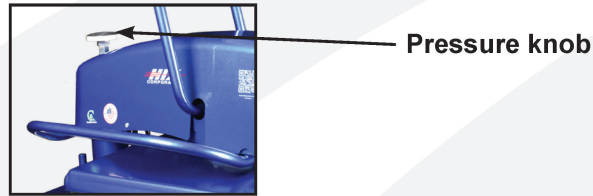

Pressure is reduced by turning knob (with machine open) counter-clockwise and increased by turning is clockwise.

NOTE: Platen Pressure Readout is applicable on presses designated with a “P” at the end of the model number only.

PLATEN PRESSURE READOUT

The amount of platen pressure being exerted on the transfer and substrate can be monitored on the controller. When the machine is closed, the platen pressure is expressed in a numerical value between 0-9 on the controller home screen. Values of 0-3 indicate “light” pressure, 4-6 “medium” pressure and 7-9 “heavy” pressure. If the value exceeds 9, then “Pressure High” will appear on the display indicating that the maximum value can be displayed has been exceeded.

NOTE: Adjustments may be required from one garment to another and will vary to achieve the desired results.

WARNING: Excessive pressure can cause structural damage, voiding the machine warranty!

TRANSFER APPLICATION

The **120 volt models** have a slower heat recovery (i.e. 18-20 seconds @ 375°F).

The **220 volt models** are recommended for quicker cycle times (i.e. 10 seconds @ 375°F).

1. Set the temperature, time, & pressure to the desired settings as instructed. **Always** consult your specific transfer recommendations. Typical settings are; **Cold Peel:** 350°F (177°C), 15 seconds and **Hot Split:** 375°F (190°C), 10-12 seconds.
2. Align substrate on lower platen. Smooth wrinkle from garments.

NOTE: Wrinkles may be removed by bringing the heated platen in contact with the garment for a few seconds before the transfer is positioned.

3. Position the transfer in the desired location on the substrate.

NOTE: The transfer image should be “mirrored” before transferring except when transferring to substrates where the image shows through, i.e. glass tiles and cutting boards.

TIP: When transferring double sided or sublimation transfers to garments, always place a sheet of transfer paper or a PTFE sheet between the layers of the garments to avoid bleed through or reheating of the applied transfer.

TIP: When sublimating to tiles and/or cutting boards, first place a tile blanket or felt pad on lower platen, second the transfer, third the substrate and finally a PTFE blanket or transfer paper to protect the upper platen.

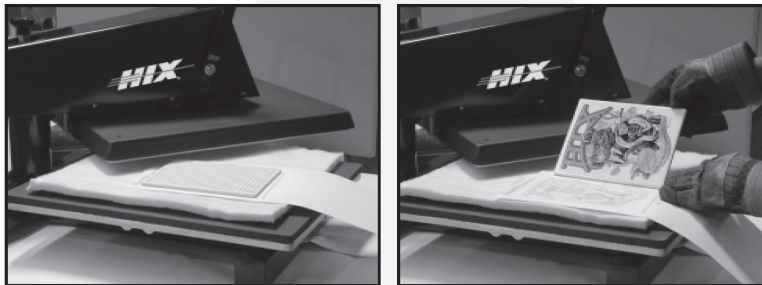

4. Swing the upper heat platen over the lower platen. A stop is installed for perfect alignment between the upper and lower platen.
5. Pull the handle down until the handle locks.
6. Continuously peel the paper off the transfer and garment.

NOTE: Do not fold the transfer back on itself. Successful transfer work depends on the correct balance of time, temperature and pressure. The type and thickness of the material and the kind of transfer being used will determine what settings are necessary.

For hot peel/split transfers, immediately peel the paper after the machine has opened.

DO NOT allow the transfer to cool. For cold peel transfers, rub the transfer with an eraser or cloth and allow to cool for 5-10 seconds before removing the release paper.

TROUBLESHOOTING

NOTE: Specific application instructions are enclosed with transfers.

When you fail to make a successful transfer you can wonder, “Is it the machine’s fault, or the transfer, wrong settings or what?”

FIRST, THE BASICS

1. Be sure to set the heat transfer machine to the transfer manufacturer’s recommended Temperature, Time and Pressure settings. If you don’t have these specifications, contact your transfer supplier for this information and any other special application instructions as many of the new “High Tech” transfers require significantly different settings and/or application techniques than those from years past.
2. When you start up your press for the first time each day, preheat the pad for a minute. If the press has sat for 3-5 minutes without use, be sure to “preheat” the pad for 10-15 seconds before loading the shirt or making the first transfer.
3. After the shirt is positioned and centered on the preheated pad, “pre-press” the shirt for 3 seconds to take the wrinkles out and more importantly, release any excess moisture out of the T-shirt fabric which can reduce the chance of a successful transfer.
4. With all of the above recommendations, try making a transfer.
5. If successful, great! You are on your way to making some serious money with your transfer machine!
6. If you have an area that isn’t transferring completely or as you would like it to, follow these steps to determine the problem.
 - Try increasing the pressure on the machine by 10-20%
 - Recheck your temperature required and the press readout. You may want to increase the temperature 10 degrees.
 - Try increasing the application time by 2-4 seconds
 - If after trying these things there is still a “specific” area (say over in one corner of the transfer) that isn’t coming out as you would like it to, then try the same type transfer on a scrap shirt but rotate the transfer 180 degrees (changing the failure location) If after doing this the problem area is in the same physical location on the machine, then you probably have a problem with the pad or possibly a warped platen if the machine has ever overheated severely. On the other hand if the transfer failed in the same area on the transfer (after changing the location of where the problem had previously been occurring), then you most likely have a problem with the transfer or it’s application settings (Temperature, Time or Pressure) and you should contact your transfer supplier to discuss the problem.

Following these basic guidelines can help you be more successful with each and every transfer!

TROUBLESHOOTING

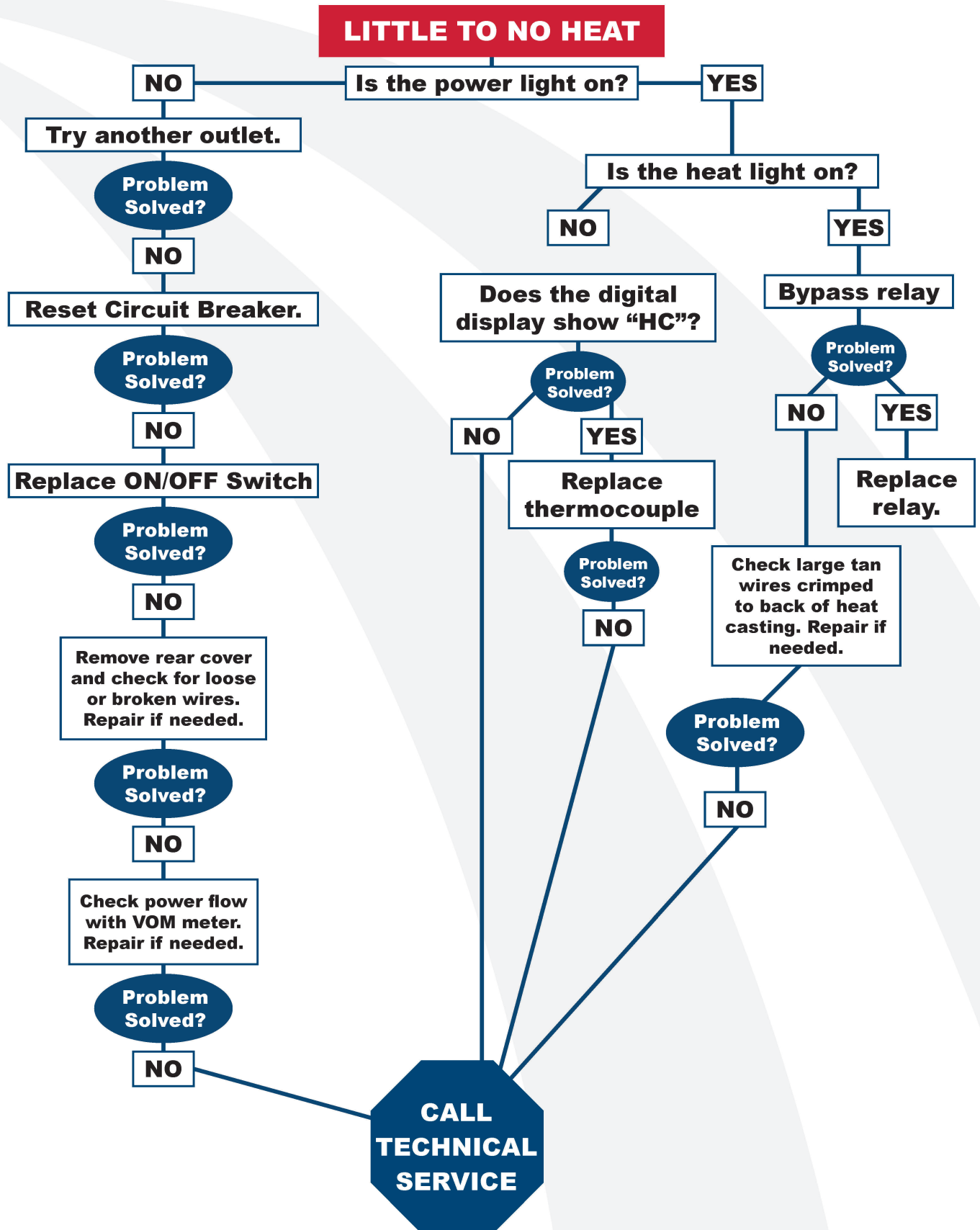

TROUBLESHOOTING

MACHINE OVERHEATS

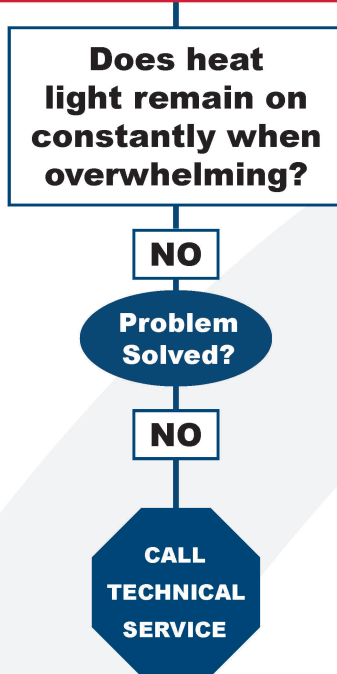

Platen pressure indicator not working properly.

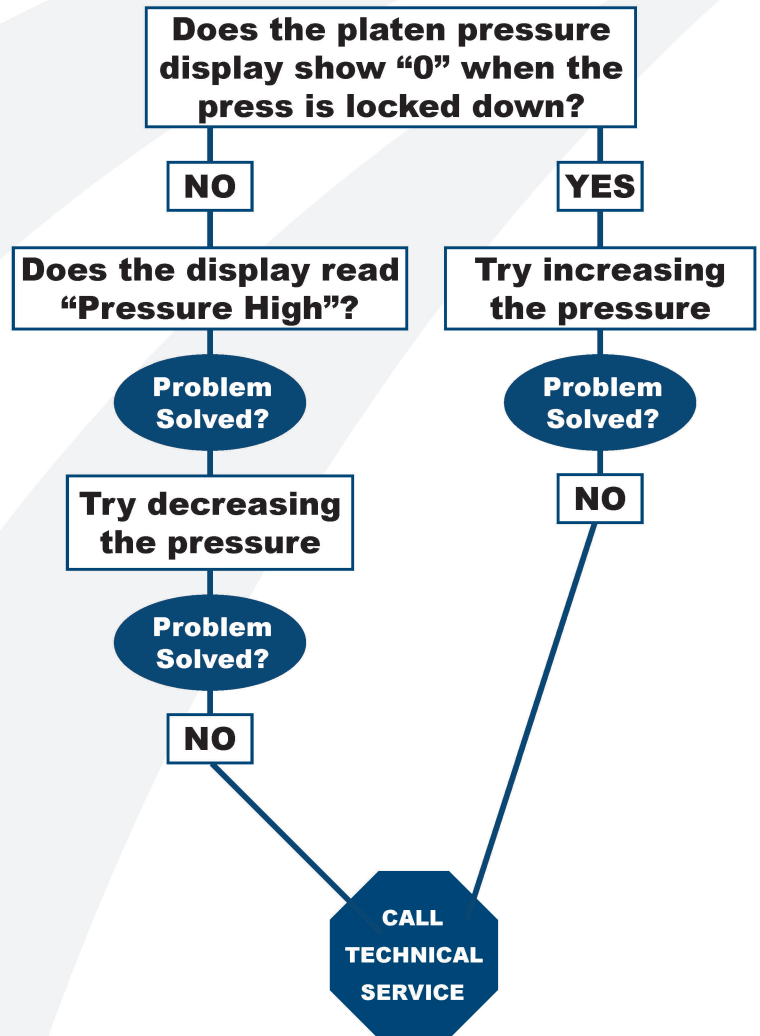

MACHINE WON'T STAY CLOSED

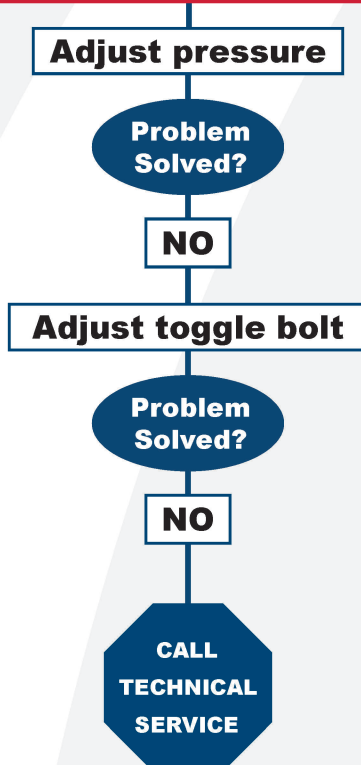

TROUBLESHOOTING

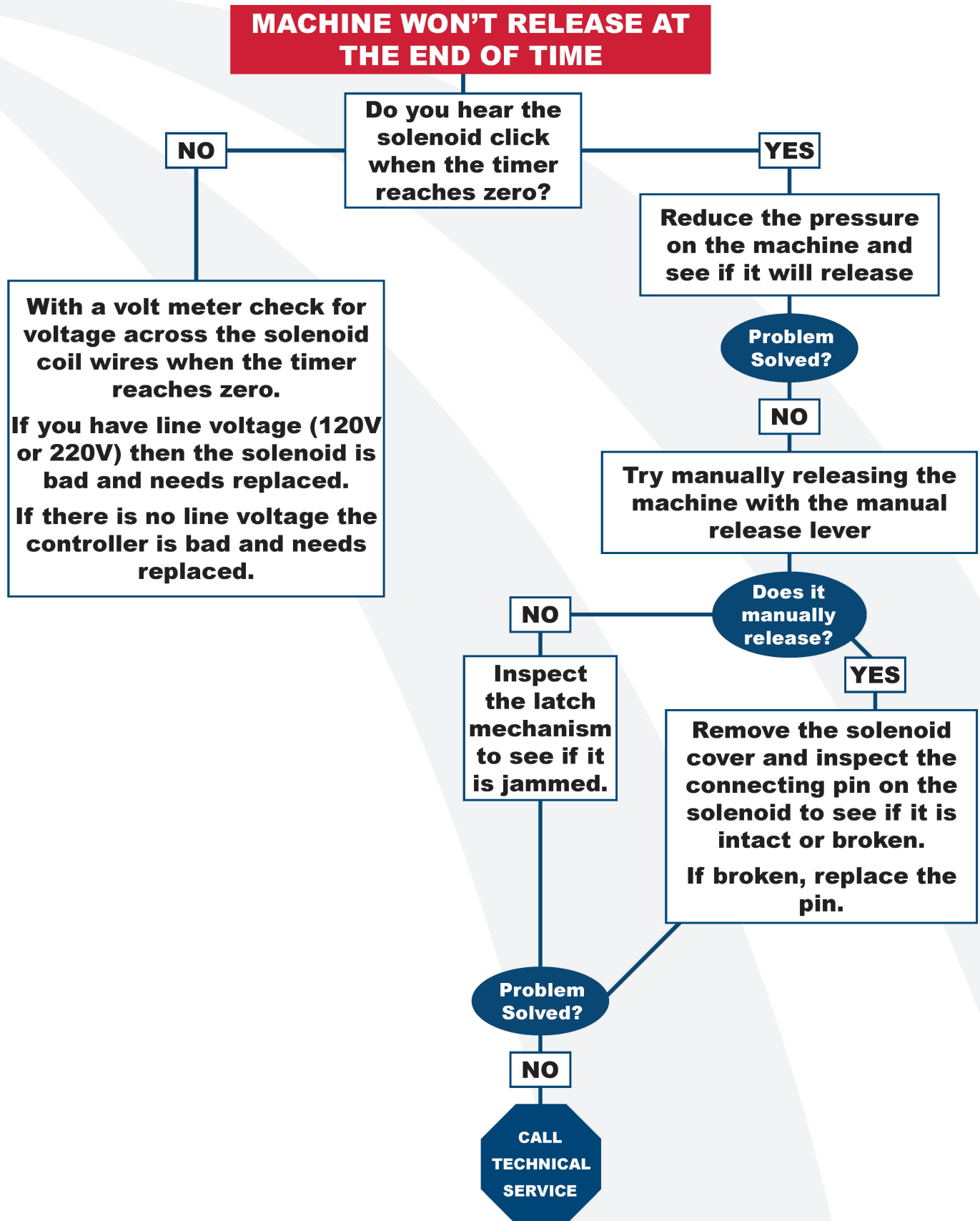

REPAIRS

Your SwingMan press has an electrical interrupter circuit breaker. If your press does not come on, check the breaker located on the right hand side, approximately two inches from the front, underside of the control box. Reset by pushing button.

RELAY BYPASS:

WARNING: Before making repairs, be sure ON/OFF switch is OFF and machine is unplugged!



1. Remove the back cover of the machine.

WARNING: To prevent possible electrical shock, unplug the machine before removing cover to service.

2. Remove wire #26 from terminal #2 on relay.
3. Loosen terminal #1 on relay and replace wire #26 along with wire #12 under terminal #1.
4. Tighten the connection.
5. Plug machine in and turn the power switch on.

NOTE: Replace the relay if the machine starts heating. This is a test only. Do not operate machine with relay bypassed.

MAINTENANCE

LUBRICATION:

Your press requires lubrication every 15,000 cycles or every 6 months.

Lubricate weekly in a heavy use production environment.

Use NSF/NLG12 rated food grade grease (such as Bel-Ray No-Tox #2 or equivalent).

A general purpose food grade machine oil spray is also acceptable such as CRC03055 lubricant (available from retailers such as Amazon).

Lubricate all moving or hinged points.

CLEANING HEAT PLATEN:

Clean the heat platen with steel wool, scrubbing aluminum sponge, or fine wire brush.

REPLACEMENT PARTS LIST (SwingMan 20 MODEL)

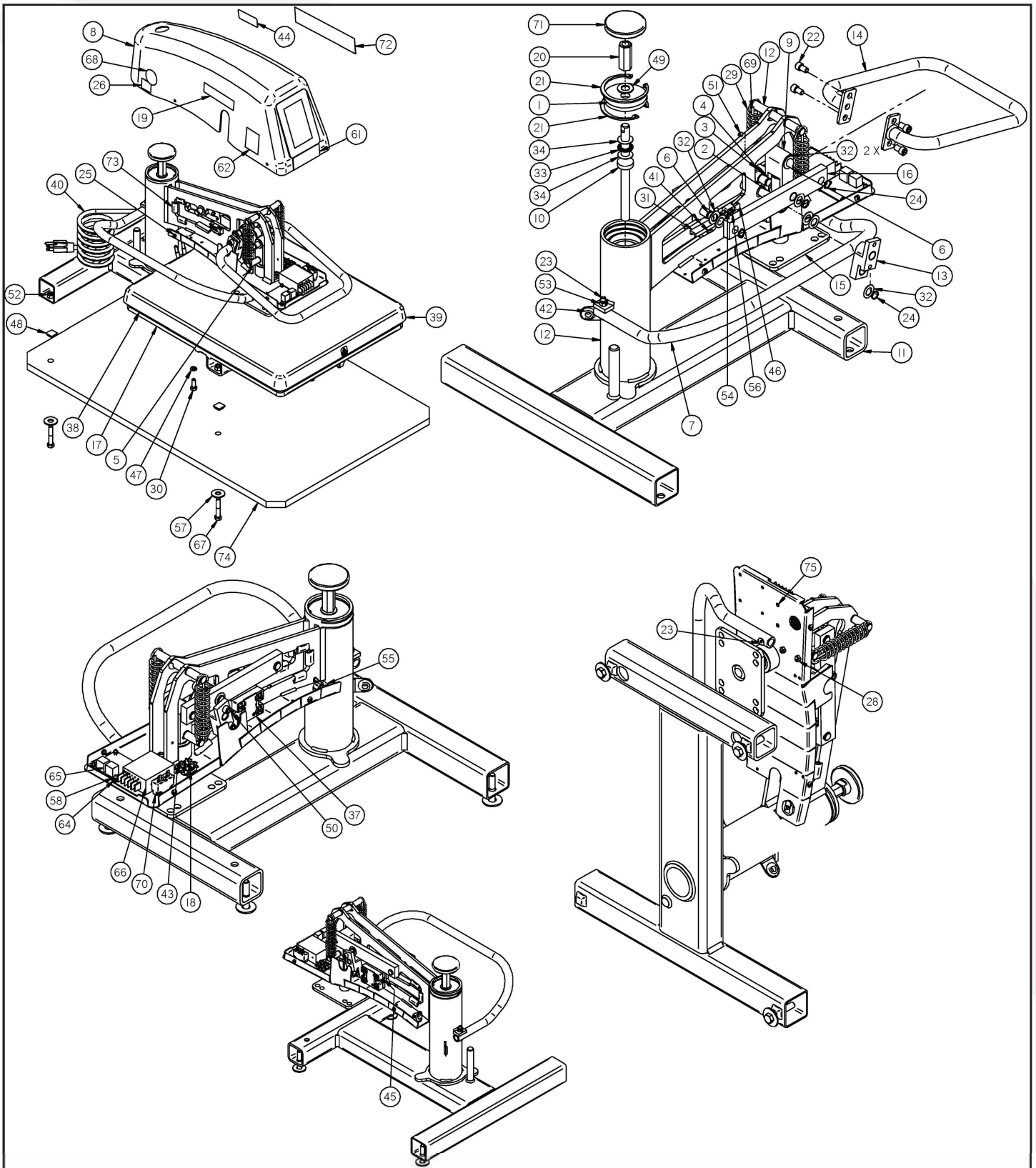

REPLACEMENT PARTS LIST

(SwingMan 20 MODEL)

ITEM#	PART#	TITLE	ITEM#	PART#	TITLE
1	9243009	M-SWG20/25 THRUST PLATE	55	13250	CORD GRIP HEYCO 1857 RDD201
2	9242430	M-SWG20/25 HANDLE LINK PIN	56	13103	SCREW MCH 4-40x0.750 RHSL
3	9242421	M-SWG20/25 C LINK	57	12229	WASHER FLT .500x1.250x.078 ZPS
4	9242320	M-SWG20/25 C LINK PIN	58	11349	NUT 6-32 EXT TOOTH LOCK ZPS
5	9242315	M-SWG20/25 MAIN LINK PIN	59*	11325	MANUAL OWNERS SWG ANT
6	9242314	M-SWG20/25 SHORT LINK PIN	60*	11316	WIRE KIT SWINGMAN 20 120V ANT
7	9242304	M-SWG20/25 RETURN HANDLE TUBE	61	11024	DECAL SILVER/RED EVO TOUCH
8	9241131	P-SWG20/25 HOUSING ASSY ANT	62	10964	O-DECAL QR CODE HTM ANT
9	9241020	M-SWG20/25 TOP LINK	63*	10917	CABLE, CAT5E ETHERNET FLAT, 2FT
10	9240960	M-SWG20/25 ADJ ROD ASSY 1/2-20	64	10914	SPACER .140x.250X.125 NYLON
11	9240940	M-SWG20 FRAME WELDMENT 1/2-20	65	10910	CONTROL TEMP I/O BOARD ANT
12	9240921	M-SWG20/25 MAIN ARM WLDMNT ANT	66	10903	POWER SUPPLY 5VDC 15W
13	9240430	M-SWG20/25 DRIVE LINK ASSY	67	10884	BOLT 3/8-16x2.000
14	9240420	M-SWG20/25 BAIL HANDLE WLDMNT	68	10664	DECAL MADE IN THE USA ROUND
15	9240320	M-SWG20 PLATEN ADAPTER 1620	69	10486	O RING 2.7620Dx2.484x.139
16	9240060	M-SWG20/25 LONG LINK ASSY	70	10347	CIRCUIT BKR 1-POLE PTR 15A ST
17	82768	M-CASTING 16x20 LOWER F	71	10151	KNOB 1/2-20 KNURLED
18	72223	TERM BD 601-2-KT37, 38,39	72	10129	DECAL SWINGMAN 20 LOGO
19	70732	DECAL HIX LOGO 4"x1"	73	10012	TRIM-LOK 150 B2 X 3/16 ALUM
20	70729	NUT COUPLING 1/2-20 x 1-3/4	74	0101012	M-SWG20 MOUNTING BOARD
21	70728	RETAINING RING INT 2.625	75	10909	SCREW MCH M3-0.5X3 PHP ZPS
22	70708	SCREW CPSKT 5/16-24x0.500			
23	70704	SCREW FHSKT 1/4-20x1.500			
24	70702	RETAINING RING EXT 0.500 2HOLE			
25	70630	SCREW MCH 10-24x0.375 PHPH			
26	70362	DECAL CERTIFIED GREEN			
27*	70268	DECAL HIX I.D. 3"x3" SILVER			
28	70129	NUT 8-32 NYLON INSERT ZPS			
29	68918	SPRING EXT 1.000ODX3.000X.105			
30	68055	BOLT 5/16-18x0.875			
31	6505026	M-STRAIN GAUGE COVER SWG20/25			
32	64203	WASHER FLT .515x0.875x.032 SS			
33	63622	BEARING THRUST .500x0.937x.078			
34	63320	BEARING WSHR .500x0.937x.031			
35*	63318	BOX SWINGMAN 20/25/20E LINER			
36*	63317	BOX SWINGMAN 20/25/20E			
37	62731	RELAY SS 25A 3-32VDC INPUT			
38	6010063	M-PAD 16x20x1/2 MED BLK MOLDED			
39	6000101	M-ASSY PLATEN 16x20 120V D SWG			
40	39768	CORDSET 120V 14/3 STOW 5-15P			
41	39179	GAUGE STRAIN			
42	35691	GROMMET .375IDx.625 GRV			
43	34592	SCREW MCH 8-32x0.625 PHPH			
44	33605	DECAL UNPLUG MACHINE			
45	32228	WASHER LOCK HEL SPR #10 ZP			
46	31823	SWITCH MICRO SMALL SEMI-HOOK			
47	30910	WASHER LOCK HEL SPR 5/16 ZP			
48	28010	BUMPON BLACK .81"x.30"			
49	15547	WASHER FLT .531x1.000x.063 ZPS			
50	15339	SCREW MCH 10-24x0.500 PHPH			
51	15131	SCREW SET 1/4-20x0.250			
52	14571	NUT 3/8-16 ZPS			
53	14514	NUT 1/4-20 NYLON INSERT ZPS			
54	13919	WASHER LOCK HEL SPR #4 ZP			

REPLACEMENT PARTS LIST

(SwingMan 25 MODEL)

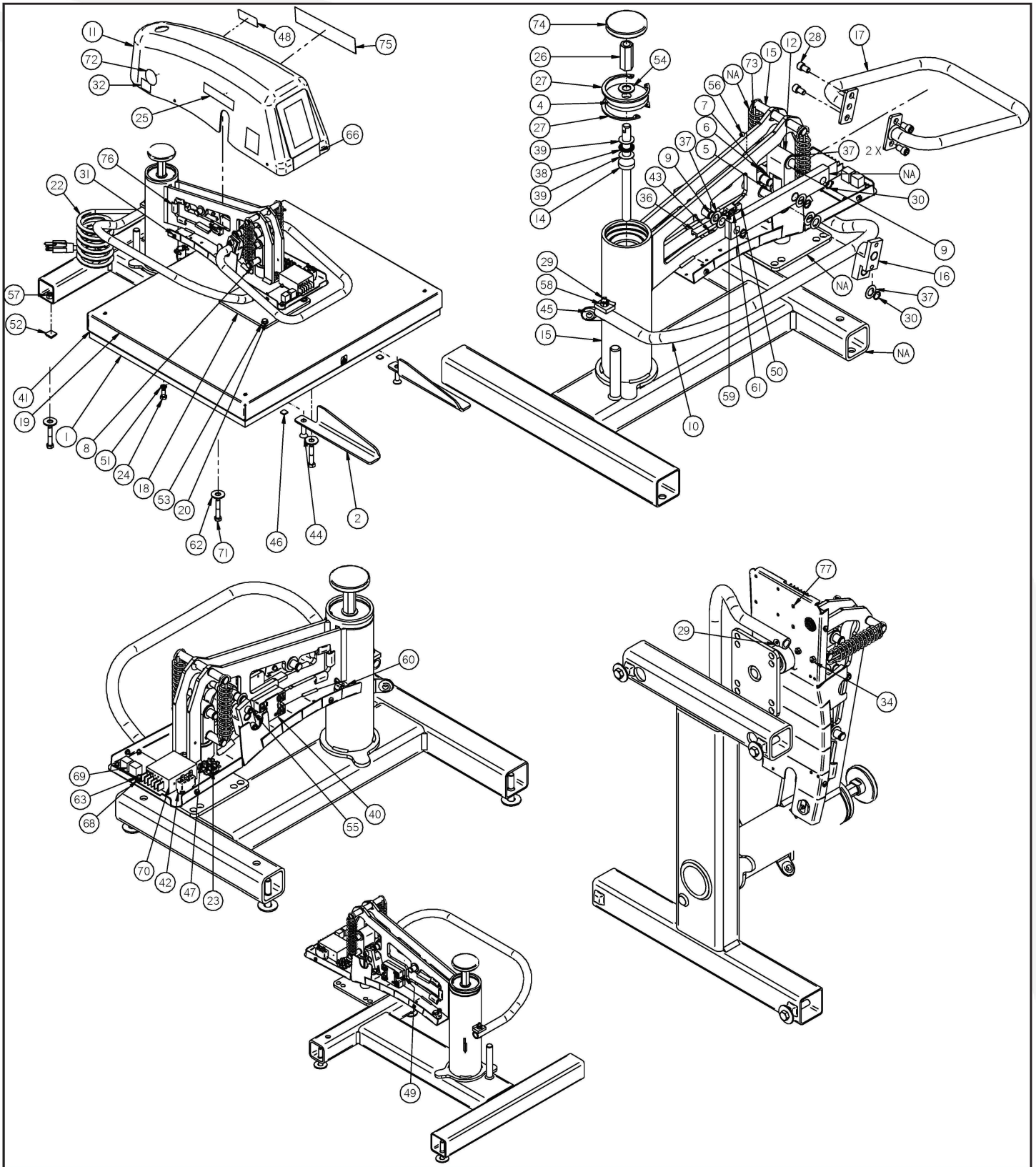

REPLACEMENT PARTS LIST

(SwingMan 25 MODEL)

ITEM#	PART#	TITLE	ITEM#	PART#	TITLE
1	9262304	M-SWG25 LOWER PLATEN	55	15339	SCREW MCH 10-24x0.500 PHPH
2	9253102	M-SWG25 OUTRIGGER LH	56	15131	SCREW SET 1/4-20x0.250
3*	9253101	M-SWG25 OUTRIGGER RH	57	14571	NUT 3/8-16 ZPS
4	9243009	M-SWG20/25 THRUST PLATE	58	14514	NUT 1/4-20 NYLON INSERT ZPS
5	9242430	M-SWG20/25 HANDLE LINK PIN	59	13919	WASHER LOCK HEL SPR #4 ZP
6	9242421	M-SWG20/25 C LINK	60	13250	CORD GRIP HEYCO 1857 RDD201
7	9242320	M-SWG20/25 C LINK PIN	61	13103	SCREW MCH 4-40x0.750 RHSL
8	9242315	M-SWG20/25 MAIN LINK PIN	62	12229	WASHER FLT .500x1.250x.078 ZPS
9	9242314	M-SWG20/25 SHORT LINK PIN	63	11349	NUT 6-32 EXT TOOTH LOCK ZPS
10	9242304	M-SWG20/25 RETURN HANDLE TUBE	64*	11325	MANUAL OWNERS SWG ANT
11	9241131	P-SWG20/25 HOUSING ASSY ANT	65*	11320	WIRE KIT SWINGMAN 25 220V ANT
12	9241020	M-SWG20/25 TOP LINK	66	11024	DECAL SILVER/RED EVO TOUCH
13*	9240970	M-SWG25 FRAME WELDMENT 1/2-20	67*	10964	O-DECAL QR CODE HTM ANT
14	9240960	M-SWG20/25 ADJ ROD ASSY 1/2-20	68	10914	SPACER .140x.250X.125 NYLON
15	9240921	M-SWG20/25 MAIN ARM WLDMNT ANT	69	10910	CONTROL TEMP I/O BOARD ANT
16	9240430	M-SWG20/25 DRIVE LINK ASSY	70	10903	POWER SUPPLY 5VDC 15W
17	9240420	M-SWG20/25 BAIL HANDLE WLDMNT	71	10884	BOLT 3/8-16x2.000
18	9230320	M-SWG20/25 PLATEN ADAPTER	72	10664	DECAL MADE IN THE USA ROUND
19	9230305	M-ASSY PLATEN SM25 220V SGL	73	10486	O RING 2.762ODx2.484x.139
20	89821	BOLT 1/4-20x2.000	74	10151	KNOB 1/2-20 KNURLED
21	8600900	M-DP SHIPPING PALLET	75	10127	DECAL SWINGMAN 25 LOGO
22	72495	CORDSET 220V 14-3 SJTOW 6-20P	76	10012	TRIM-LOK 150 B2 X 3/16 ALUM
23	72223	TERM BD 601-2-KT37, 38,39	77	10909	SCREW MCH M3-0.5X3 PHP ZPS
24	71498	BOLT 5/16-18x0.750 G8	78	0101012	SWINGMAN 20 MOUNTING BOARD
25	70732	DECAL HIX LOGO 4"x1"	79	10909	SCREW MCH M3-0.5X3 PHP ZPS
26	70729	NUT COUPLING 1/2-20 x 1-3/4			
27	70728	RETAINING RING INT 2.625			
28	70708	SCREW CPSKT 5/16-24x0.500			
29	70704	SCREW FHSKT 1/4-20x1.500			
30	70702	RETAINING RING EXT 0.500 2HOLE			
31	70630	SCREW MCH 10-24x0.375 PHPH			
32	70362	DECAL CERTIFIED GREEN			
33*	70268	DECAL HIX I.D. 3"x3" SILVER			
34	70129	NUT 8-32 NYLON INSERT ZPS			
35*	68919	SPRING EXT 1.000ODX3.000X.115			
36	6505026	M-STRAIN GAUGE COVER SWG20/25			
37	64203	WASHER FLT .515x0.875x.032 SS			
38	63622	BEARING THRUST .500x0.937x.078			
39	63320	BEARING WSHR .500x0.937x.031			
40	62731	RELAY SS 25A 3-32VDC INPUT			
41	6010064	M-PAD 20x25x1/2 MED BLK MOLDED			
42	47487	CIRCUIT BKR 1-POLE PTR 8 AMP			
43	39179	GAUGE STRAIN			
44	38598	SCREW FHSKT 3/8-16x1.250			
45	35691	GROMMET .375IDx.625 GRV			
46	35408	BUMPER 1/8X1/2 SQ BLK RUBBER			
47	34592	SCREW MCH 8-32x0.625 PHPH			
48	33605	DECAL UNPLUG MACHINE			
49	32228	WASHER LOCK HEL SPR #10 ZP			
50	31823	SWITCH MICRO SMALL SEMI-HOOK			
51	30910	WASHER LOCK HEL SPR 5/16 ZP			
52	28010	BUMPON BLACK .81"x.30"			
53	16774	WASHER FLT .281x0.625x.063 ZPS			
54	15547	WASHER FLT .531x1.000x.063 ZPS			

WARRANTY

BEFORE warranty repair you MUST get Prior Authorization: Call 1-800-835-0606 Warranty will be voided otherwise.

(Effective 9/1/2021)

HIX® Corporation (HIX) will automatically register the equipment on the date it was shipped to you or your distributor. If the equipment was not purchased directly from HIX, but through a distributor, please keep a copy of their sales invoice showing the serial number and date it was sold/shipped to you with this warranty. In this case, we will use the distributor's invoice date as the beginning warranty date. **STAPLE A COPY OF YOUR PROOF OF PURCHASE TO THIS WARRANTY** and keep in a safe place to provide verification of your warranty should a problem occur. Thank you.

Please fill in the following information and attach a copy of your receipt for your records.

Date Purchased: _____ **From:** _____
Model #: _____ **Serial #:** _____

This warranty applies to Graphics equipment manufactured by the HIX® Corporation (HIX), Pittsburg, Kansas, U.S.A. HIX warrants to the original purchaser, its Heat Transfer Machines, Ovens and Dryers, Printers, Spotholders and Exposure Units, against defects in workmanship and material, except for wear and tear for a period of "One Year" from the date of purchase. HIX warrants Accessories for a period of 90 days from the date of purchase. doughXpress® products are covered under separate warranty.

In the event of a defect, HIX, at its option, will repair, replace or substitute the defective item at no cost during this warranty period subject to the limitations of insurance and shipping costs stated below (excludes labor).

In the case of heat transfer presses (except the Hobby Lite® and Large Format presses), HIX warrants the heat casting for the "Life" of the machine for the original purchaser. If a part becomes obsolete at the time for repair, and/or cannot be reasonably substituted for, HIX will credit, at half the then current list price or last recorded price, only that part toward a new machine or any product HIX offers. This credit offer shall be the sole responsibility of the HIX in the event of an obsolete part.

This warranty does not cover belts, rail tape, pads, mug wraps, canvas, rubber blankets, bulbs, glass. Warranty does not cover damages due to accident, misuse/abuse, alterations or damage due to neglect, shipping or lack of proper lubrication or maintenance. HIX shall not be responsible for repairs or alterations made by any person without the prior written authorization by HIX. This warranty is the sole and exclusive warranty of HIX and no person, agent, distributor, or dealer of HIX is authorized to change, amend or modify the terms set forth herein, in whole or in part.

In the case of a problem with the equipment identified herein, HIX should be contacted during regular business hours to discuss the problem and verify an existing warranty. HIX personnel will assist the customer to correct any problems which can be corrected through operation or maintenance instructions, simple mechanical adjustments, or replacement of parts. In the event the problem cannot be corrected by phone, and upon the issuance of a return authorization by HIX, the equipment shall be returned to HIX or an authorized service representative. All insurance, packaging and shipment/freight costs are solely the responsibility of the customer, and not that of HIX, and HIX shall not be responsible for improper packaging, handling or damage in transit. Contact HIX customer service for complete return authorization information. Correct shipping boxes are available from HIX.

This expressed warranty is given in lieu of any and all other warranties, whether expressed or implied, including but not limited to those of merchantability and fitness for a particular purpose, and constitutes the only warranty made by HIX.

In no event shall HIX's liability for breach of warranty extend beyond the obligation to repair or replace the nonconforming goods. HIX shall not be liable for any other damages, either incidental or consequential, or the action as brought in contract, negligence or otherwise.

This warranty gives you specific legal rights and you may also have other rights which vary from state to state.



1201 E. 27th Terrace • Pittsburg, KS 66762 • U.S.A.

Phone: (800) 835-0606 • Fax: (620) 231-1598

Web site: hixcorp.com • E-Mail: support@hixcorp.com