



**Henny Penny
Open Fryer
Model OFE-884**

**FM05-074-A
07-04-12**

NOTICE

This manual and Wiring diagram should be retained in a convenient location for future reference. The Model OFE884 open fryer cannot be operated without electric power. The unit will automatically return to normal operation when power is restored.



Improper installation, adjustment, alteration, service, or maintenance can cause property damage, injury, or death. Read the installation, operating, and maintenance instructions thoroughly before installing or servicing this equipment.



DO NOT STORE OR USE GASOLINE OR OTHER FLAMMABLE VAPORS AND LIQUIDS IN THE VICINITY OF THIS OR ANY OTHER APPLIANCE. FIRE OR EXPLOSION COULD RESULT.

Section	Page
Section 1. INTRODUCTION	
1-1. Introduction	1-1
1-2. Features	1-1
1-3. Proper Care	1-1
1-4. Assistance.....	1-1
1-5. Safety	1-1
Section 2. INSTALLATION	
2-1. Introduction	2-1
2-2. Unpacking	2-1
2-3. Leveling the Open Fryer	2-1
2-4. Ventilation of Open Fryer	2-1
2-5. Electrical Requirements OFE884.....	2-2
Section 3. OPERATION	
3-1. Operating Components C1500 Controls	3-1
3-2. Filling or Adding Shortening	3-7
3-3. Care of Shortening	3-7
3-4. Filtering of Shortening.....	3-8
3-5. Filter Pump Problem Prevention	3-9
3-6. Filter Pump Motor Protector - Manual Reset.....	3-10
3-7. Changing the Filter Envelope.....	3-10
3-8. Cleaning the Frypot.....	3-11
3-9. Regular Maintenance	3-13
3-10. Wiring Diagram	3-14
3-11. Oil Filter Instructions	3-16
Section 4. PART LIST	
4-1. General Assy	4-1
4-2. Front Shroud Assy	4-3
4-3. Assy-Drain pan	4-4
4-4. Assy-Through.....	4-5
4-5. Piping System	4-6
4-6. Assy-Electrical Parts	4-8
4-7. Assy-Full Elecment & Hub.....	4-9
4-8. Assy Pot&Ctop	4-11
4-9. Assy-Frame	4-13
4-10. Assy-LH Door.....	4-14
4-11. Assy-RH Door.....	4-15
4-12. Assy-MLH Door	4-16
4-13. Assy-MRH Door	4-17
Section 5. TROUBLESHOOTING	
5-1. Troubleshooting Guide	5-1
5-2. Error Codes	5-2

SECTION 1. INTRODUCTION

1-1. INTRODUCTION

The Henny Penny Open Fryer is a basic unit of food equipment designed to cook foods better and easier. This unit is used only in institutional and commercial foodservice operations.

1-2. FEATURES

- Easily cleaned
- 55 lb-65lb. (24.94-29.47 kg.) shortening capacity
- 2 Half size baskets per well (option)
- Stainless steel construction
- Manual reset high limit control
- Gravity drain filter system

1-3. PROPER CARE

As in any unit of food servicing equipment, the open fryer does require care and maintenance. Requirements for the maintenance and cleaning are contained in this manual and must become a regular part of the operation of the unit at all times.

1-4. ASSISTANCE

Should you require outside assistance, call your local independent Henny Penny distributor in your area, call Henny Penny Corp. at 0512-89180268 , or go to Henny Penny online at www.hennypenny.com.

1-5. SAFETY

The Henny Penny Open Fryer has many safety features incorporated. However, the only way to ensure safe operation is to fully understand the proper installation, operation, and maintenance procedures. The instructions in this manual have been prepared to aid you in learning the proper procedures. Where information is of particular importance or is safety related, the words DANGER, WARNING, CAUTION, or NOTE are used. Their usage is described on the next page:

1-5. SAFETY (continued)



SAFETY ALERT SYMBOL is used with DANGER, WARNING or CAUTION which indicates a personal injury type hazard.



NOTICE is used to highlight especially important information.



CAUTION used without the safety alert symbol indicates a potentially hazardous situation which, if not avoided, may result in property damage.



CAUTION used with the safety alert symbol indicates a potentially hazardous situation which, if not avoided, could result in minor or moderate injury.



WARNING indicates a potentially hazardous situation which, if not avoided, could result in death or serious injury.



DANGER INDICATES AN IMMINENTLY HAZARDOUS SITUATION WHICH, IF NOT AVOIDED, WILL RESULT IN DEATH OR SERIOUS INJURY.

2-1. INTRODUCTION

This section provides the installation instructions for the Henny Penny Open Fryer.



Installation of the unit should be performed only by a qualified service technician.



Do not puncture the unit with any objects such as drills or screws as component damage or electrical shock could result.

2-2. UNPACKING

The Henny Penny Open Fryer has been tested, inspected, and expertly packed to ensure arrival at its destination in the best possible condition. The unit is banded to a wooden skid and then packed inside a heavy cardboard carton with sufficient padding to withstand normal shipping treatment.



Any shipping damage should be noted in the presence of the delivery agent and signed prior to his or her departure.

2-3. LEVELING THE OPEN FRYER

For proper operation, the open fryer should be level from side to side and front to back. Using a level placed on the flat areas around the frypot collar, adjust the casters until the unit is level.

2-4. VENTILATION OF OPEN FRYER

The open fryer should be located with provision for venting into an adequate exhaust hood or ventilation system. This is essential to permit efficient removal of the steam exhaust and frying odors. Special precaution must be taken in designing an exhaust canopy to avoid interference with the operation of the open fryer. We recommend you consult a local ventilation or heating company to help in designing an adequate system.

Refer to the table below for supply wiring and fusing.

VOLT (V)	PH	WATTS (KW)	AMP (A)
380-415	3	14.0	21.2







To avoid electrical shock, this fryer must be adequately and safely grounded (earthed). Refer to local electrical codes for correct grounding (earthing) procedures or in absence of local codes, with The National Electrical Code, ANSI/NFPA No. 70-(the current edition).

SECTION 3. OPERATING

3-1-1. Operating Components- C1500 Controls

Reference Figure 3-1.

Fig. No.	Item No.	Description	Function
3-1	1	Digital Display	Shows the shortening temperature, the timer countdown in the Cook Cycle, and the selections in the Program Mode; the temperature of the shortening can be shown by pressing P once, or twice to view set-point temperature; if shortening temperature exceeds 425°F (218°C), the display reads “E-5, FRYER TOO HOT”
3-1	2		This LED lights when the shortening temperature is within 5° of the set-point temperature, signaling the operator that the shortening temperature is now at the proper temperature for dropping product into the frypot
3-1	3		The timer buttons are used to start and stop Cook Cycles; exit the Melt Cycle; press and hold in the “INIT” Special Mode to re-initialize the controls
3-1	4		Used to adjust the value of the currently displayed setting in the Program Mode
3-1	5		The program button is used to access the Program Modes and used to advance to the next parameter; also, once in the Program Mode the LED above the button is lit
3-1	6	Menu Card	The name of the food product associated with each product Window selection button; the menu card strip is located behind the decal
3-1	7	Product Select Buttons	Used to select the product for cooking and the LED above the selected product is lit

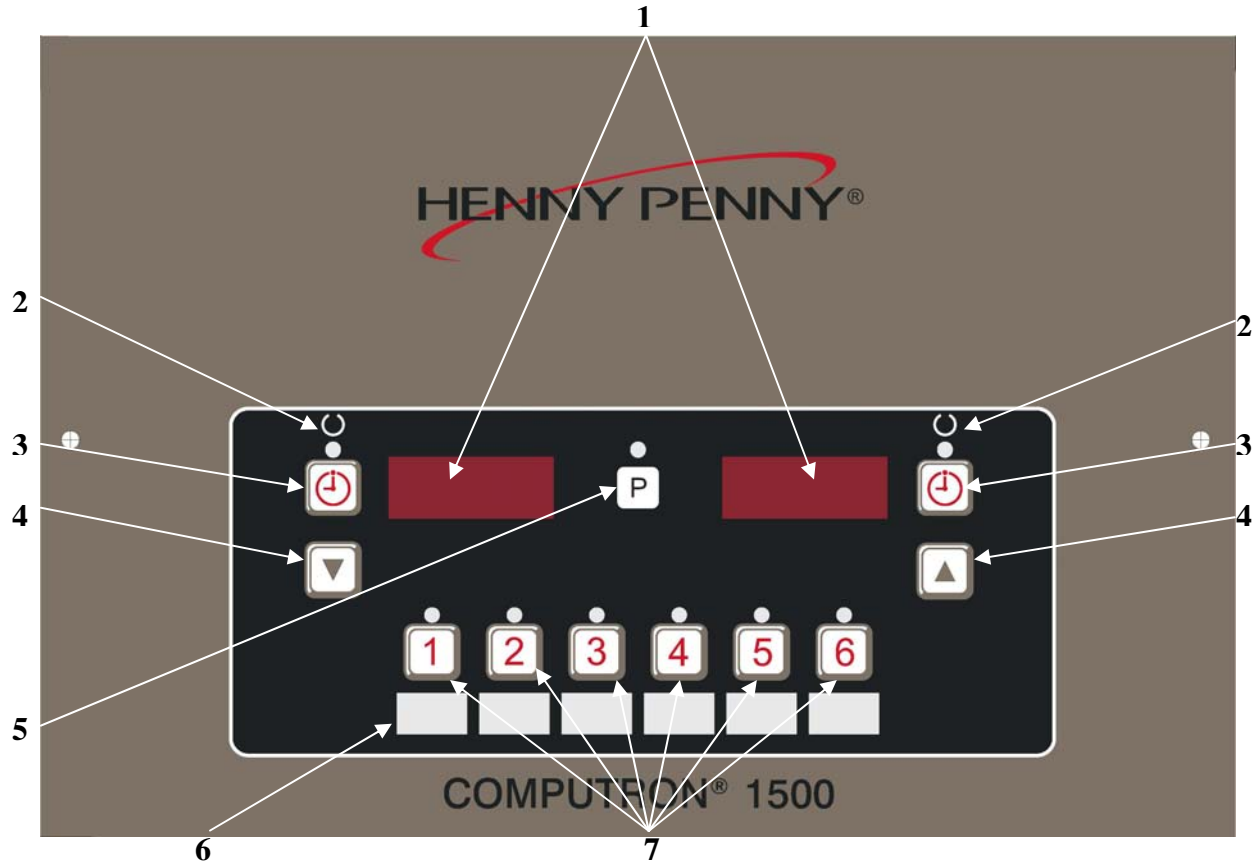

Figure 3-1

C1500 OPERATIONS AND PROCEDURES

The Computron 1500 controls are available on both split frypot and full frypot fryers. The following is a brief description of the operating procedures for fryers with these controls.

1. Be sure the drain valve is in the closed position.
2. Place basket support inside of frypot.
3. Make sure frypot is filled with shortening to the proper level.
4. Display shows “OFF” until power switch is turned to the ON position. Display shows the selected product as “P-1”, “P-2”, “P-3”, etc, and the unit automatically starts the Melt Cycle until the shortening temperature reaches 250°F (121°C). The control automatically exits the Melt Cycle.

To assign a product to a timer button, press product button and then the desired timer button. “XXXX” is displayed if the product doesn’t match (and set-point) press and hold the timer to choose the new set-point. Once the new set-point is chosen, press the timer button to start the cook cycle.

Full vat operation: Only products with the same set-point and LED’s on, can be selected for cooking .

Split vat operation: Products with two different set-points and LED’s on, can be chosen.

NOTICE

The OFE884 series open fryer has several safety devices which shuts-down the electricity supply when they are activated. The above procedures should be followed to restart the open fryer and if the shut down is repeated, a qualified technician should be notified.

The Melt Cycle may be bypassed, if desired, by pressing and holding  for 3 seconds.

CAUTION

Do not bypass the Melt Cycle unless enough shortening on gas fryers and elements on electric fryers. If Melt Cycle is bypassed before all burner tubes or elements are covered, excessive smoking of the shortening, or a fire will result.

**C1500 OPERATIONS
AND PROCEDURES
(Continued)**

5. Once out of the Melt Cycle, the shortening is heated until  lights and the selected product is displayed.

Thoroughly stir shortening to stabilize the temperature throughout the frypots.

6. Before loading product into the baskets, lower baskets into the hot shortening to keep the product from sticking to the baskets.
7. Once the shortening temperature has stabilized at the set-point temperature, lower the basket with product into the frypot.



Do not overload, or place product with extreme moisture content into the basket. 12.5 lbs. (5.7 kg) is the maximum amount of product per frypot (6.25 lbs. (2.8 kg) maximum for the split frypot fryers). Failure to follow these directions can result in shortening overflowing the frypot. Serious burns or damage to the unit could result.

9. If the right basket was dropped into the shortening, then press the right .









If the left basket was dropped, then press the left .

10. The timer on the appropriate side (right or left) starts counting down.











If an alarm sounds during a cook cycle, press  to stop alarm.







11. At the end of the Cook Cycle a tone will sound and the display flashes “DONE”. Press  button and lift the basket from the shortening.

1. Press and hold  until “PROG MODE” shows in the display.
2. Press the desired product button. The LED above the button is on, “TEMP” shows and the set-point temperature flashes.
3. Press   to change the set-point temperature. Press and hold   and the values increases by 5.
4. Once   are released, the set-point is saved after 2 seconds.
5. To reset set-point temperature to default settings, press and hold both   simultaneously.

To change Product Cooking Times





















1. Press and hold  until “PROG MODE” shows in the display.
2. Press the desired product button. The LED above the button is on and the set-point temperature flashes.
3. Press  and “TIME” shows the cook time flashes.
4. Press   to change the product cooking time.
5. Once   are released, the time is saved after 2 seconds
6. To reset cooking time to default settings, press and hold both   simultaneously.

Programming Alarm

1. Press and hold  until “PROG MODE” shows in the display.
2. Press the desired product button. The LED above the button is on and the set-point temperature flashes.
3. Press  twice and “ALRM” shows and 0:00 flashes.
4. Press   to set an alarm in a cook cycle. Example, if an alarm is to sound 30 seconds after starting a 3 minute cook cycle, set alarm to 2:30.
5. Once   are released, the alarm is saved after 2 seconds

Special Programming is used to set the items below:

- Fahrenheit or Celsius
- Initialize System
- Lock or Unlock Controls
- Fryer Type – Open or Pressure

- Heat Source – Electric; Gas w/standing pilot;
Gas w/electronic ignition; Gas-Induced Draft
 - Vat Type - Split or Full Vat (frypot)
 - Oil Type - Solid or Liquid
1. To enter Special Programming, turn off power switch (either side). Press and hold  and turn the power switch back on.
 2. “SPEC” “PROG” followed by, “DEG” “°F” or “°C”. Use   to choose “°F” or “°C”.
 3. Press  and “INIT” shows in the display.
Press and hold the right  and display shows “In-3”, “In-2”, “In-1” followed by “Init Sys” “DONE DONE”. The controls now are reset to factory parameters, the time set to 0:00 and temperature 190°F or 88°C.
 4. Press  and “LOCK” or “UNLOCK” shows in the displays. Use   to choose “LOCK” or “UNLOCK”.
 5. Press  and “FRYR” shows in left display and the right display should show “OPEN”. Use   to change from “OPEN” to “PRES” if needed.
 6. Press  and “HEAT” shows in the left display and the type of heat shows in the right display. Use  
to change the heat type: “ELEC” for electric models; “GAS” for units with standing pilot; “SSI” for units with solid state ignition; “IDG” for units with induced draft gas burners.
 7. Press  and “VAT” shows in the left display and the type of vat shows in the right display . Use   to choose “SPLIT” or FULL” vat (frypot) type.
 8. Press  and “MELT” shows in the left display and Solid” or “LIQD” shows in the right display. Use   to choose “Solid”, if using solid shortening, or “LIQD”, if using liquid shortening.
 9. Press and hold  to exit Special Programming at any time.

3-2. FILLING OR
ADDING SHORTENING

CAUTION

The shortening level must always be above the heating elements when the fryer is heating and at the frypot level indicators on the rear of the frypot. Failure to

follow these instructions could result in a fire and/or damage to the fryer. Less than level will caught fire. When using solid shortening, it is recommended to melt the shortening on an outside heating source before placing it in the frypots. The heating element must be completely submerged in shortening. Fire or damage to the frypot could result.

1. It is recommended that a high quality frying shortening be used in the open fryer. Some low grade shortenings have a high moisture content and will cause foaming and boiling over.



Wear gloves to avoid severe burns when pouring hot shortening into frypot. Shortening and all metal parts that are in contact with the shortening are extremely hot, and take care to avoid splashing.

2. Cold shortening should be filled to the lower indicator when the frypot has 2 indicator lines,

3-3. CARE OF SHORTENING



FOLLOW THE INSTRUCTIONS BELOW TO AVOID SHORTENING OVERFLOWING THE FRYPOT, WHICH COULD RESULT IN SERIOUS BURNS, PERSONAL INJURY, FIRE, AND/OR PROPERTY DAMAGE.

1. Maintain the shortening at the proper cooking level. Add fresh shortening as needed.
2. Discard any shortening which has a bad flavor or shows signs of excessive foaming or boiling. Keep the frypot clean.

3-4. FILTERING OF SHORTENING



WITH PROLONGED USE, THE FLASHPOINT OF

SHORTENING IS REDUCED. DISCARD SHORTENING IF IT SHOWS SIGNS OF EXCESSIVE SMOKING OR FOAMING. SERIOUS BURNS, PERSONAL INJURY, FIRE, AND/OR PROPERTY DAMAGE COULD RESULT.

1. Turn the main switch to the OFF position. Remove and clean the fry basket in soap and water. Rinse thoroughly.



Best results are obtained when shortening is filtered at the normal frying temperature

2. Use a metal spatula to remove any build up from the sides of the frypot. Do not scrape heating elements on electric models.



Scraping the electric fryer elements, produces scratches in these surfaces causing breading to stick and burn.



The filter drain pan must be placed all the way to the front of the fryer. Be sure dairy union is connected .Failure to follow these instructions causes splashing of shortening and could result in personal injury. Surfaces of fryer and baskets will be hot. Use care when filtering to avoid getting burned.

3. Slowly turn drain valve handle a half turn. Leave for a few minutes, then slowly, fully open drain valve. This prevents much splashing of the hot shortening as it drains
4. As the shortening drains from the frypot, use brushes on the heating elements. If the drain fills with breading, use straight white brush to push excess breading into the filter drain pan.



IN THE SHORTENING BEFORE ALL SHORTENING IS PUMPED UP, IT'S POSSIBLE THAT THE FILTER CONNECTION AT THE UNION ON THE FILTER TUBE IS NOT TIGHTENED PROPERLY. IF SO, TURN OFF THE PUMP AND WEAR PROTECTIVE GLOVES OR CLOTH WHEN TIGHTENING THE UNION. THIS UNION WILL BE HOT. SEVERE BURNS COULD RESULT.

5. Pull out the pump handle, pump all of the shortening out of the filter drain pan and back into the frypot. When the pump is pumping air only, move the pump switch from PUMP to OFF
6. Check the level of the shortening in the frypot. Add fresh shortening if necessary, until it reaches the bottom level indicator line on the right wall of the frypot.

NOTICE

About 10 to 12 filterings can be made with one filter paper envelope, depending on:

- the quantity and type of product fried and filtered
 - he type of breading used
 - the amount of crumbs left inside the filter drain pan. When the filter screen assembly and filter paper become clogged, and the pumping flow slows. Clean the filter screen assembly and change the filter envelope.
7. To continue cooking, move the main POWER switch to the ON position, and shortening reheats.

3-5. FILTER PUMP PROBLEM PREVENTION

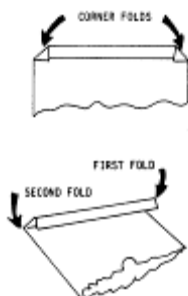

712

To help prevent filter pump problems:

1. Properly install paper envelope over the filter screens. Fold the open end of the envelope, and clamp with retaining clips so that crumbs cannot enter. Figure 3-2.
2. Pump shortening, until you see bubbles in the fry pot.

3-9

3-6. FILTER PUMP MOTOR PROTECTOR – MANUAL RESET



In the event it overheats, the filter pump motor is equipped with a manual reset button located on the rear of the motor. After waiting 5 minutes to allow the motor to cool, press the reset button. It takes some effort to reset the motor. A screwdriver can be used to help press reset button. Figure 3-3.

Figure 3-7



Figure 3-3

To prevent burns caused by splashing shortening, turn the unit's filter PUMP switch to the OFF position before resetting the filter pump motor's manual reset protection device.

3-7. CHANGING THE FILTER ENVELOPE

The filter envelope should be changed after 10-12 filterings or whenever it becomes clogged with crumbs. Proceed as follows:



The filter union could be hot. Wear protective glove or cloth, or severe burns could result.

Use care to prevent burns caused by splashing of hot shortening.

1. Move the main POWER switch to the OFF position.
2. Remove the filter drain pan from beneath the frypot.
3. Remove the filter screen assembly from the drain pan.
4. Wipe the shortening and crumbs from the filter drain pan. Clean the drain pan with soap and water. Thoroughly rinse with hot water.
5. Unthread the standpipe from the filter screen assembly.
6. Remove the crumb catcher and clean with soap and water. Rinse thoroughly with hot water.
7. Remove the filter clips and discard the filter envelope.
8. Clean the top and bottom filter screen with soap and water. Rinse thoroughly with hot water.

3-10

3-8. CLEANING THE FRYPOT

712

After the initial installation of the open fryer, as well as before every change of shortening, the frypot should be thoroughly cleaned as follows:

switch off

1. Turn the main



POWER

The filter drain pan must be as far back under fryer as it will go. Failure to follow these instructions causes splashing of shortening and could result in personal injury.

Moving the fryer or filter drain pan while containing hot shortening is not recommended. Hot shortening can splash out and severe burns could result.



CHEMICAL
SPLASH
GOGGLES



CHEMICAL
RESISTANT
GLOVES

Always wear chemical splash goggles or face shield and protective rubber gloves when cleaning the frypot as the cleaning solution is highly alkaline. Avoid splashing or other contact of the solution with your eyes or skin. Severe burns may result. Carefully read the instructions on the cleaner. If the solution comes in contact with your eyes rinse thoroughly with cool water and see a physician immediately.

2. If hot shortening is present in the frypot, it must be drained by Leave for a few minutes, then slowly open the valve to full open position.
3. Close the drain valve. Discard the shortening .
4. Remove the filter screen assembly from the filter drain pan. **Wear protective glove or cloth, or severe burns could result.**
5. Fill the frypot to the level indicator with hot water. Add 4 ozs. (0.12 liters) of open fryer cleaner to the water and mix thoroughly. The fry basket can be placed inside the frypot for cleaning.
6. Turn the main POWER switch to the ON position and set temperature to 195° F (90.5° C).
7. When the solution reaches 195° F (90.5° C), turn the main POWER switch to the OFF position.
8. Let the cleaning solution stand for 15 to 20 minutes with the power off.
9. Using the open fryer brush (never use steel wool), scrub the inside of the frypot.

3-8. CLEANING THE FRYPOT
(Continued)



If the cleaning solution in the frypot starts to foam and boil over, immediately turn the power switch to OFF or damage to components could result.

Do not use steel wool, other abrasive cleaners or cleaners/sanitizers containing chlorine, bromine, iodine or ammonia chemicals, as these will deteriorate the stainless steel material and shorten the life of the unit.

Do not use a water jet (pressure sprayer) to clean the unit, or component damage could result.

10. After cleaning, open the drain valve and drain cleaning solution from the frypot into the filter drain pan and discard.
11. Replace the empty filter drain pan, close the drain valve, and refill the frypot with plain hot water to the proper level.
12. Add approximately 8 ozs. (0.24 liters) of distilled vinegar and bring the solution back up to 195° F (90.5° C).
13. Using a clean brush, scrub the interior of the frypot. This will neutralize the alkaline left by the cleaning compound.
14. Drain the vinegar rinse water and discard.
15. Rinse down the frypot using clean, hot water.
16. Thoroughly dry the filter drain pan and the frypot interior.

NOTICE

Make sure the inside of the frypot, the drain valve opening, and all the parts that will come in contact with new shortening are as dry as possible.

17. Replace the clean filter screen assembly in the drain pan, and install filter drain pan under open fryer.
18. Refill the frypot with fresh shortening.

3-9. REGULAR MAINTENANCE

As in all food service equipment, the Henny Penny Open Fryer does require care and proper maintenance. The table below provides a summary of scheduled maintenance procedures to be performed by the operator.

Procedure	Frequency
Filtering of shortening	Daily (3-4 loads)

bad	Changing of shortening	When shortening smokes, foams up violently, or tastes
	Changing the filter envelope	After 10-12 filterings, or when envelope is clogged with crumbs
	Lubricate filter o-rings	Every filter pad change
	Cleaning the frypot	Every change of shortening
	Inspect filter pan o-rings	Quarterly



**If moving fryer to perform preventive maintenance:
Electrical supply should be unplugged or wall
circuit breaker turned off to avoid electrical shock.**

3-10. OFE884.100 Wiring Diagram

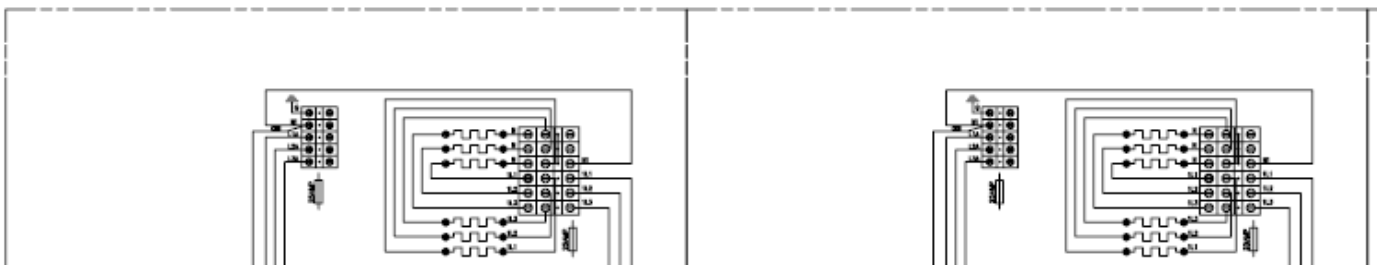

3-10. OFE884.100 Wiring Diagram (Continued)

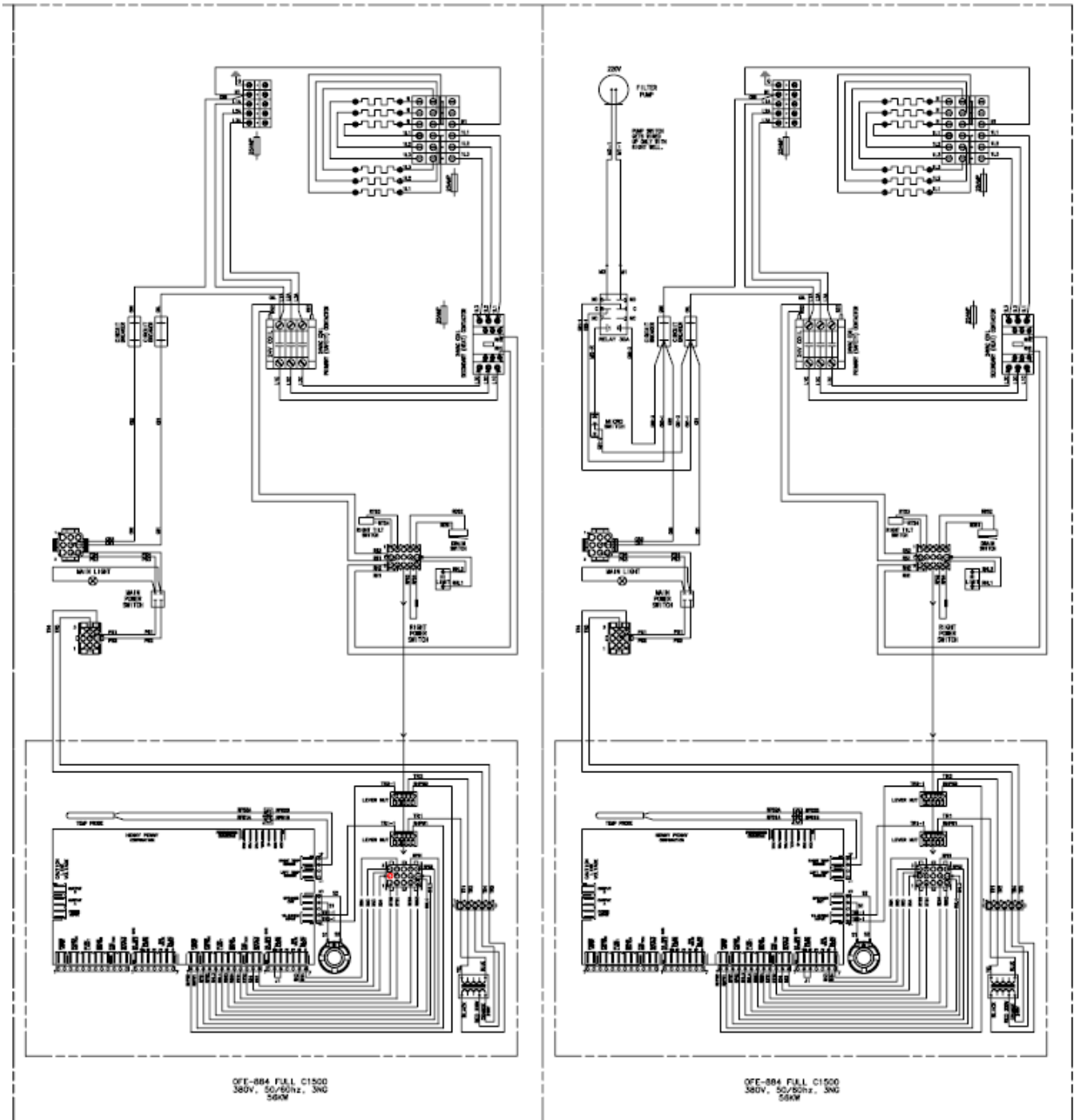

3-11. Oil Filter Instructions

Step 1: Open the drain valve and drop oil into the drain ;

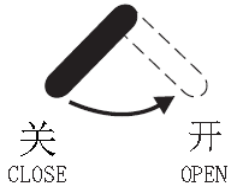

Step 2: Close the drain valve when the vat is empty;

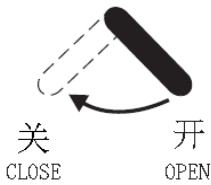

Step 3: Open the return valve;

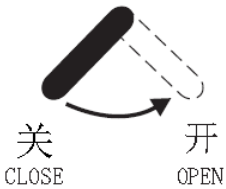

Step 4: Turn on the motor with the handle and pump oil into the vat;

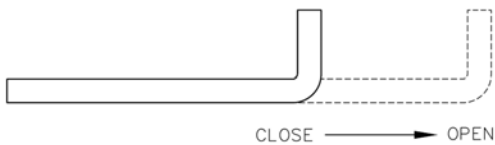

Step 5: Turn off the motor with the handle.

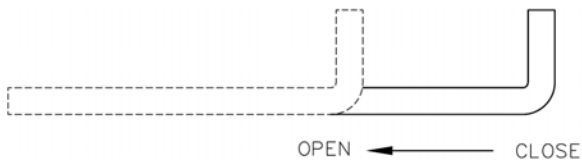

Step 6: Close the return valve.

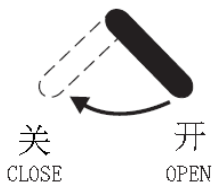

SECTION 4. PART LIST

4-1 GENERAL ASSY-OFE884.100

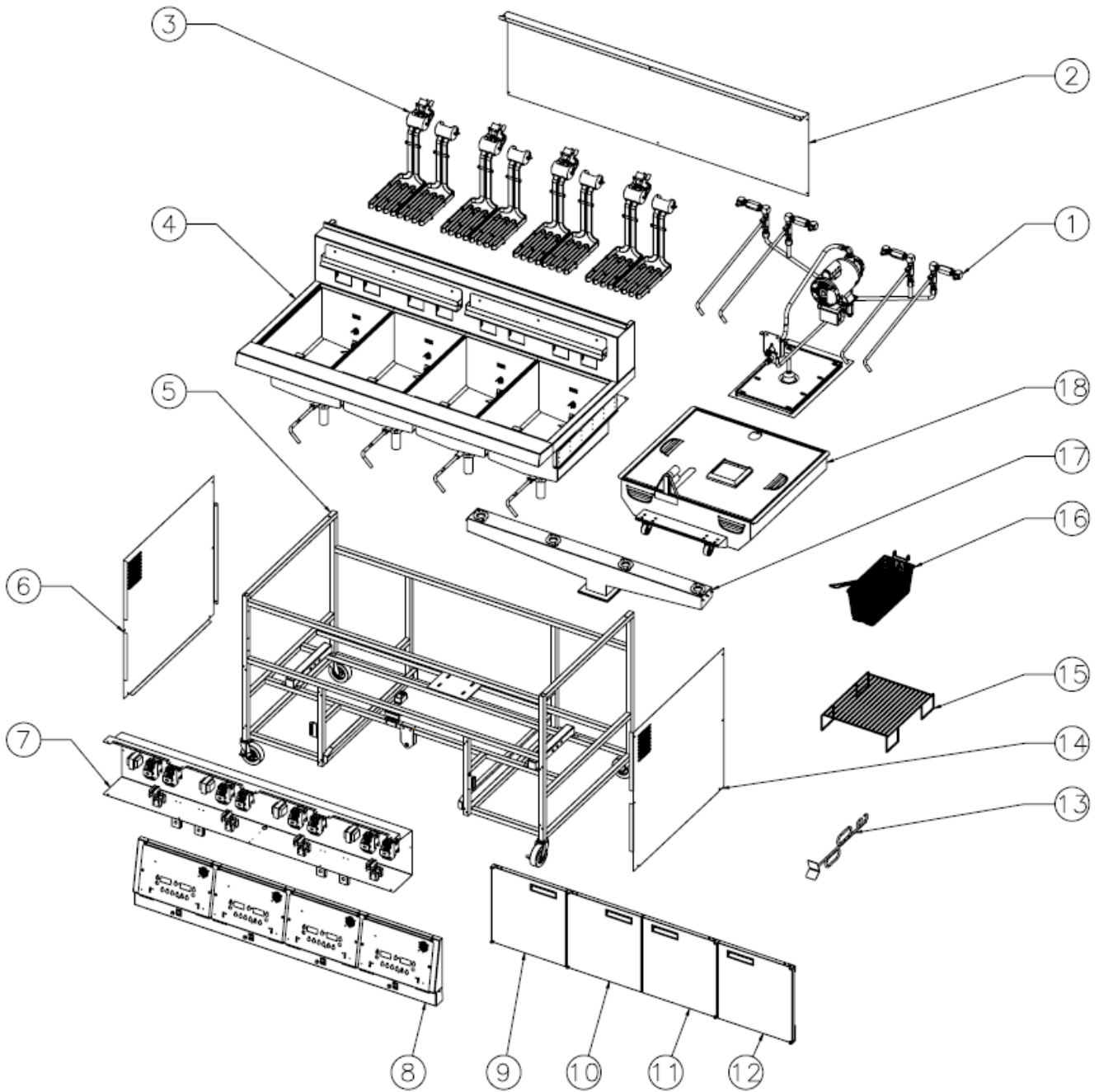

4-1 GENERAL ASSY-OFE884.100

ITEM	PN	DESCRIBE	QUANTITY
1	94959	ASSY-PIPING SYSTEM	1
2	95425	COVER -REAR SHROUD	1
3	92705	ASSY-FULL ELEMENT & HUB	4
4	95109	POT ASSY AND ENCLOSURE	1
5	95702	ASSY-FRAME	1
6	92223	PANEL-LH SIDE	1
7	95148	ASSY-ELECTRICAL PARTS	1
8	94920	FRONT SHROUD ASSY-C1500	1
9	94947	ASSY-LH DOOR	1
10	95595	ASSY-LMH DOOR	1
11	95594	ASSY-RMH DOOR	1
12	94948	ASSY-RH DOOR	1
13	82222	HANDLE-LVE10X ELEMENT LIFT	1
14	92196	PANEL-RH SIDE	1
15	88521	SUPPORT-FRY BASKET	4
16	92476	BASKET - HALF	4
17	95718	ASSY-TROUGH	1
18	95719	ASSY-DRAIN PAN	1

4-2 FRONT SHROUD ASSY

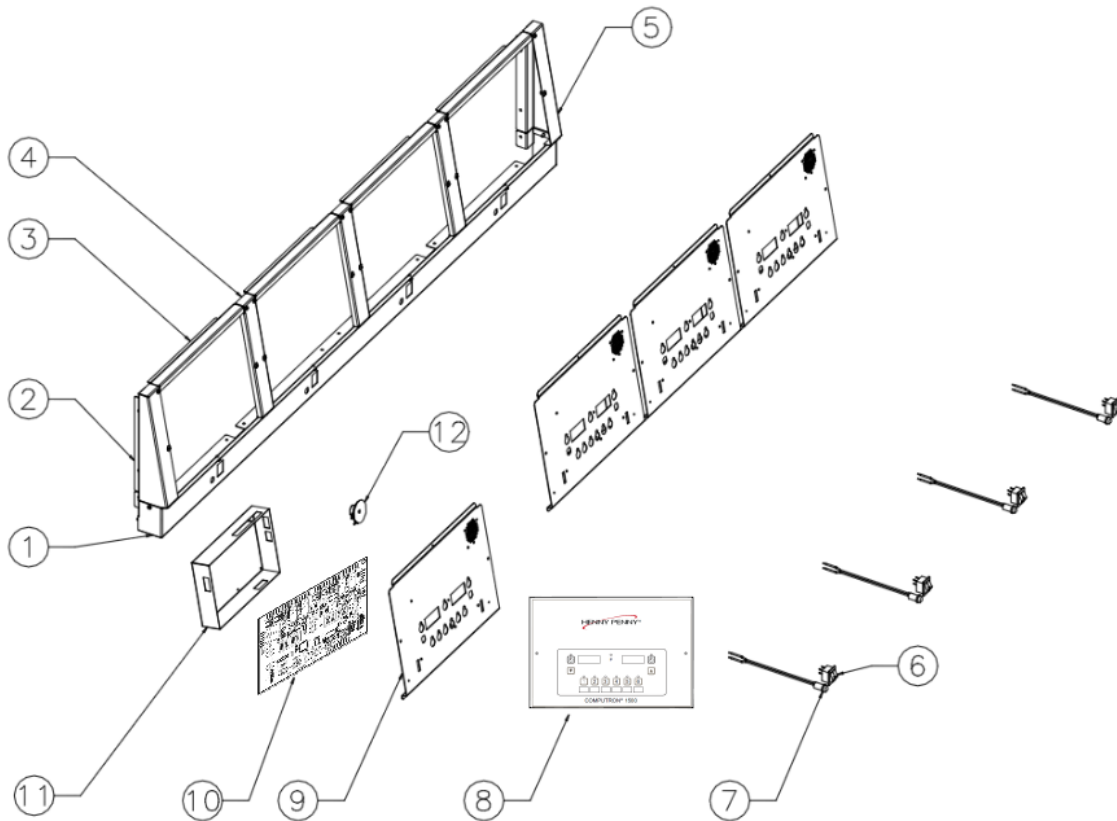

TEM	PN	DESCRIBE	QUANTITY
1	94921	LOWER_SHROUD	1
2	94922	SHROUD-CONTROL- LEFT	1
3	93955	SHROUD-CONTROL UPPER MIDDLE	4
4	94924	SHROUD-CONTROL-DIVIDER	3
5	94923	SHROUD-CONTROL-RIGHT	1
6	52224	COVERED POWER SWITCH	4
7	16624	LIGHT - INDICATOR - 250V	4
8	87332	DECAL-CONTROL PANEL C1500	4
9	88696	PANEL-CONTROL C1500	4
10	88440	CONTROL-BASIC FRYER W/PRODUCTS	4
12	78269	COVER-PCB WENDYS SIMPLE	4
13	ME70-005	SPEAKER-16 OHM-2 INCH	4

4-3 ASSY-DRAIN PAN

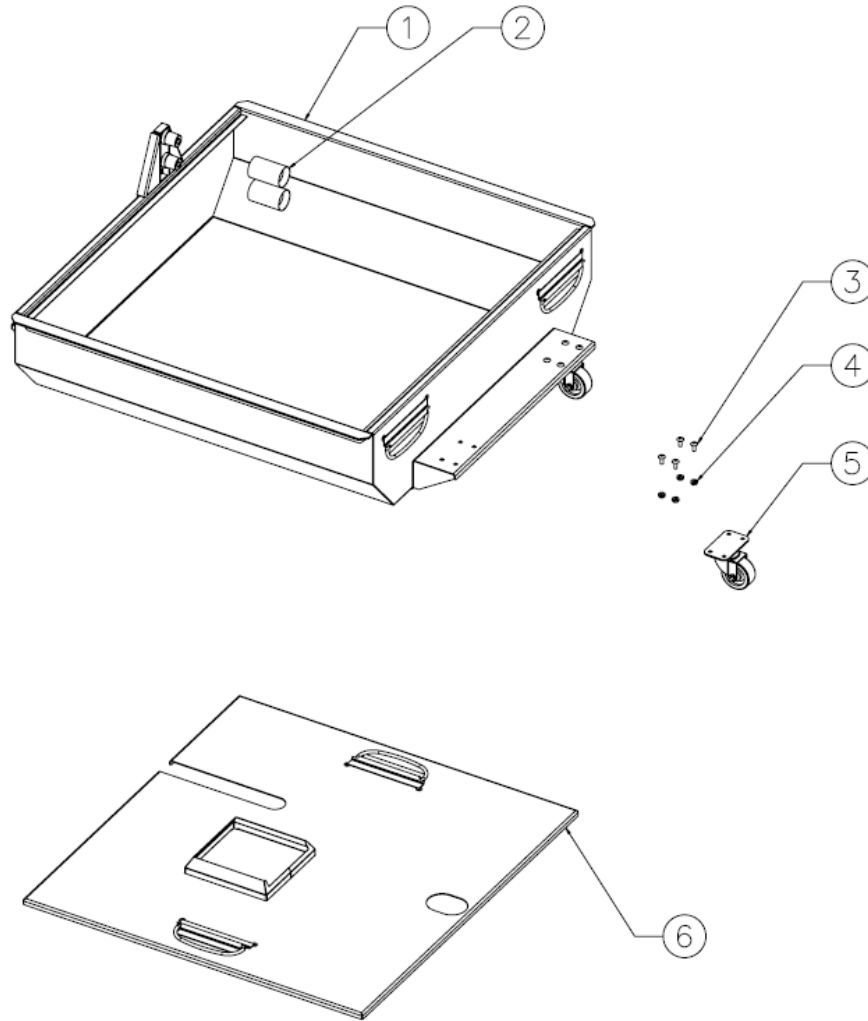

ITEM	PN	DESCRIBE	QUANTITY
1	94955	WELD ASSY-DRAIN PAN	1
2	83429	ADAPTER-TUBE END	2
3	SC01-074	SCREW #10-32 X 1/2 PH THD S	16
4	NS02-001	NUT HEX KEPS #10-32 C	16
5	19004	CASTER-2 IN SWIVEL MTG PLATE	4
6	94958	ASSY PAN COVER	1

4-4 ASSY-TROUGH

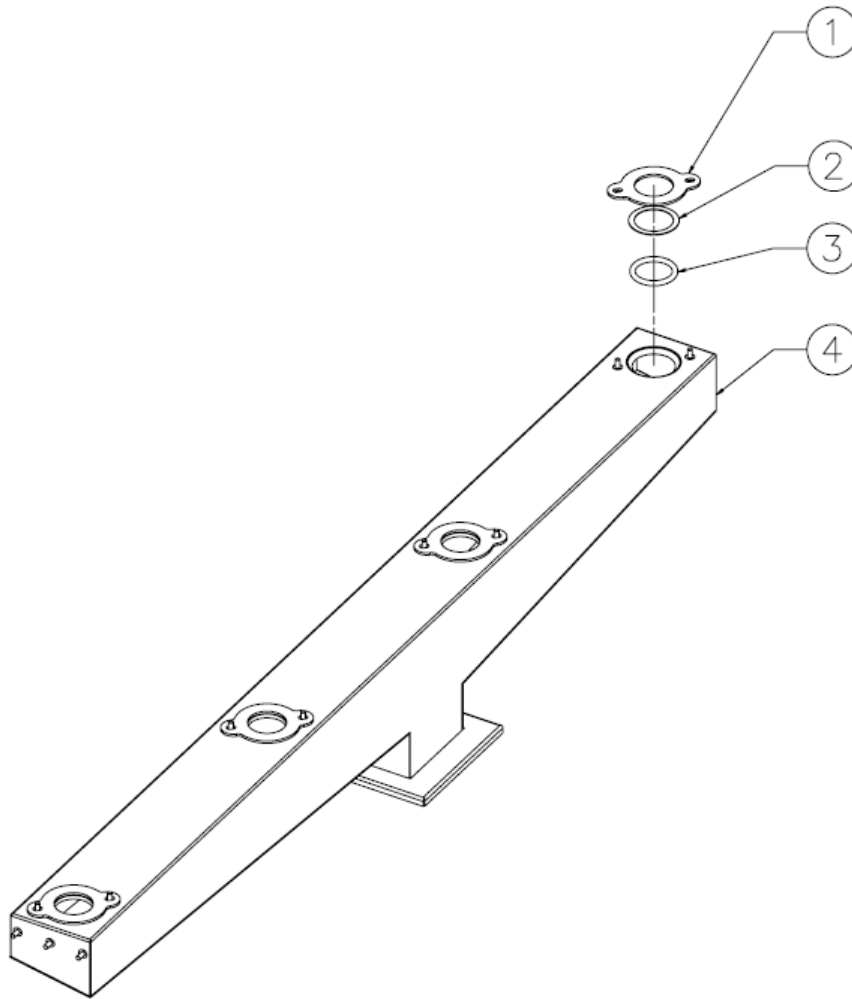

ITEM	PN	DESCRIBE	QUANTITY
1	84419	CLAMP-DRAIN TROUGH SEAL	4
2	86442	SHIM-TROUGH SEAL LVX20X	4
3	76948	O-RING-DRAIN VALVE	4
4	94988	WELD ASSY-TROUGH	1

4-5 PIPING SYSTEM

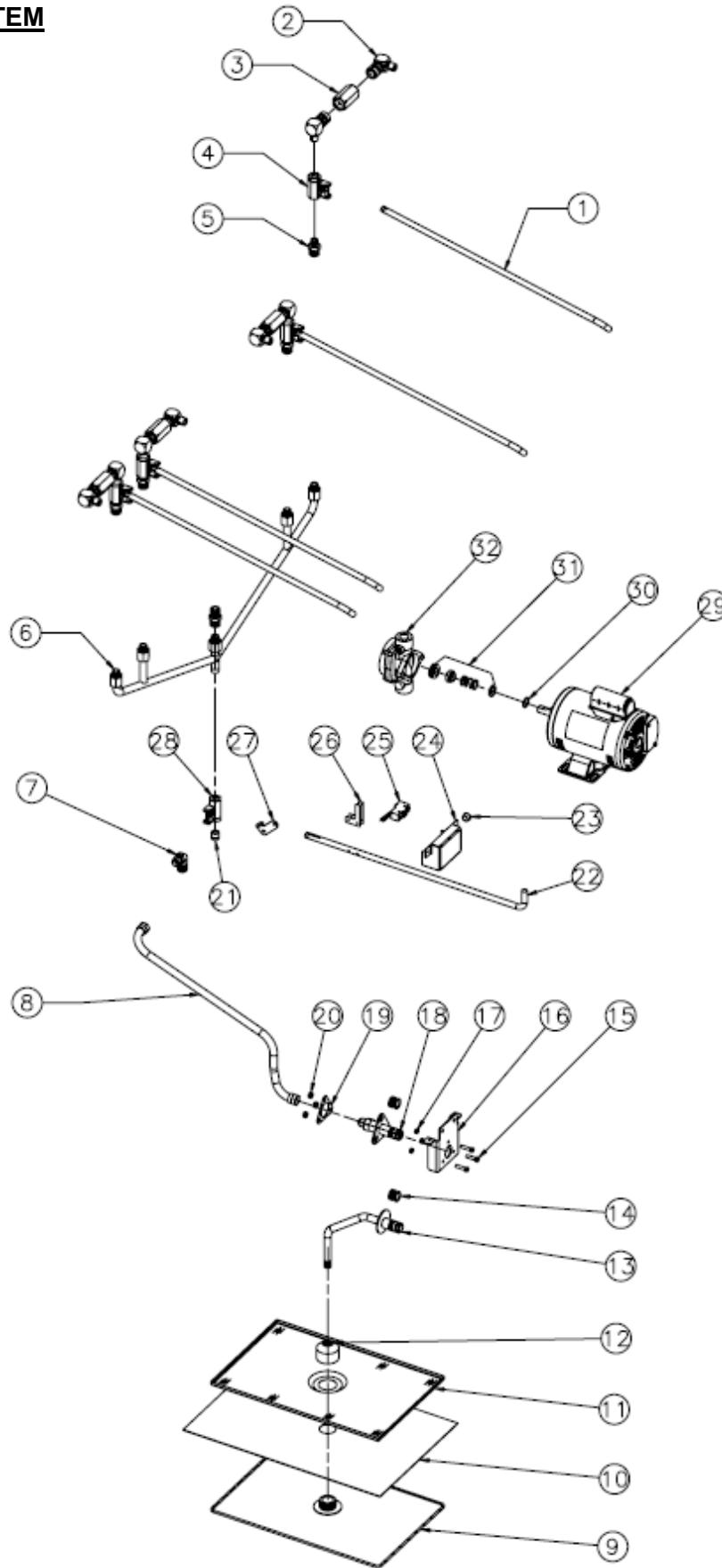

4-5 PIPING SYSTEM

ITEM	PN	DESCRIBE	QUANTITY
1	92161	ROD-RETURN OPEN DRAIN OFE142	4
2	6806-12-6	EACH END	8
3	90506	VALVE-CHECK SAE 12	4
4	17308	VALVE FILTER	4
5	16807	FITTING CONNECTOR MALE	1
6	94981	WELD TUBE ASSY- VALVE TO POT	1
7	FP01-205	ELBOW-1/2 IN NPT MALE 45 FLARE	1
8	77523-004	TUBE-SUCTION 18 IN L DORMONT	1
9	89412	ASSY-FILTER SECTION-WELDMENT	1
10	12102	FILTER ENVELOPE - CT OF 100	1
11	65211	CRUMB CATCHER	1
12	65208	NUT-FILTER-FEMALE	1
13	94994	TUBE C-PICK UP TO PUMP	1
14	86349	O-RING -116 SUCTION LINE LVX	6
15	SC01-039	SCREW 1/4-20 X 1 HEX HD C	3
16	95341	BRACE A-ADAPTER	1
17	95345	LINER	3
18	95424	TUBE B-PICK UP TO PUMP	1
19	95343	BRACE B-ADAPTER	1
20	NS02-002	NUT KEPS 1/4-20 C	3
21	95610	NIPPLE-3/8 NPT	1
22	95028	ROD B-MOTOR SWICH	1
23	EF02-106	BUSHING-SNAP 1/2 ID PLASTIC	1
24	95029	BRACE A-MOTOR ROD SUPPORT	1
25	50764	MICROSWITCH-RIGID LEVER	1
26	95031	BOARD-LIMIT	1
27	93402	COLLAR-CONDENSATE PAN SIDE	1
28	17308	VALVE FILTER	1
29	93080	MOTOR-1/2 HP FILTER PUMP	1
30	17460	SPACER PUMP SEAL	1
31	17445	SEAL - FILTER PUMP	1
32	17437	PUMP SUBASSY 5GPM	1

4-6 ASSY-ELECTRICAL PARTS

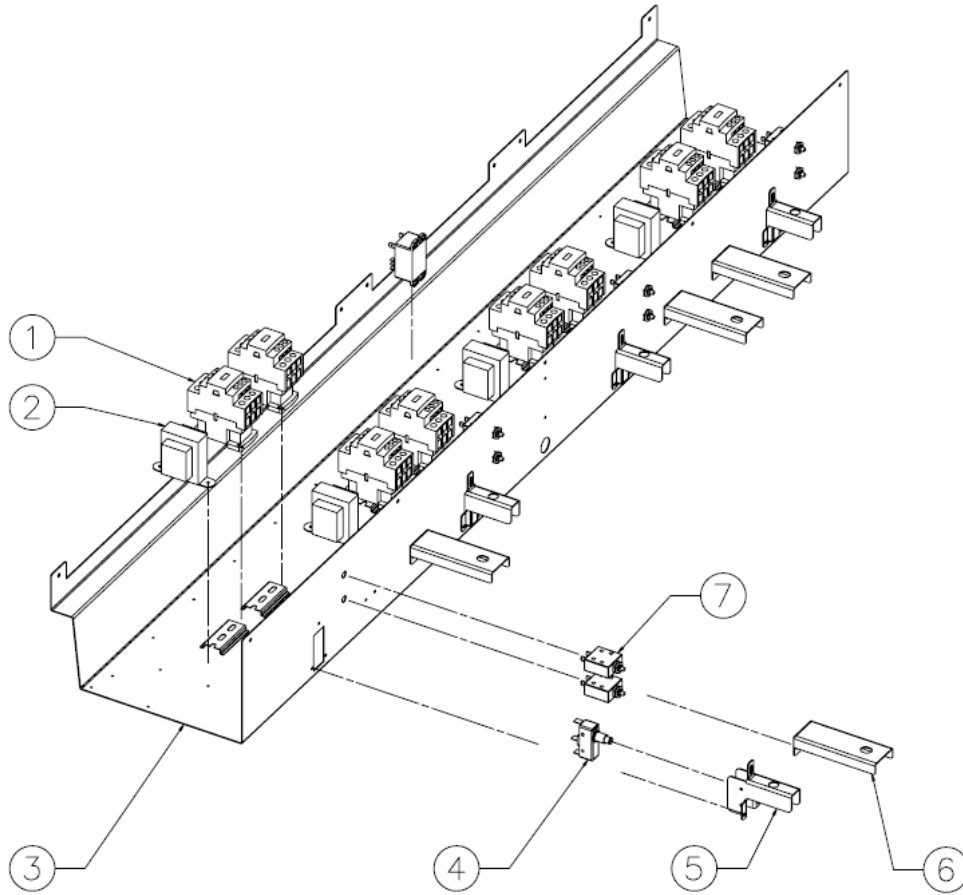

ITEM	PN	DESCRIBE	QUANTITY
1	65073	CONTACTOR-SQUARE D-24V	8
2	60536	ASSY-TRANSFORMER, 24V/230V	4
3	94934	SHROUD-4 WELL COMPONENT	1
4	18227	SWITCH-MICRO-250F	8
5	91347	BRACKET-DRAIN ROD-OFE141	4
6	91973	BRACKET-FILL ROD SUPOORT	4
7	EF02-125	BREAKER-PUSH BUTTON RESET	8

4-7 ASSY-FULL ELEMENT & HUB

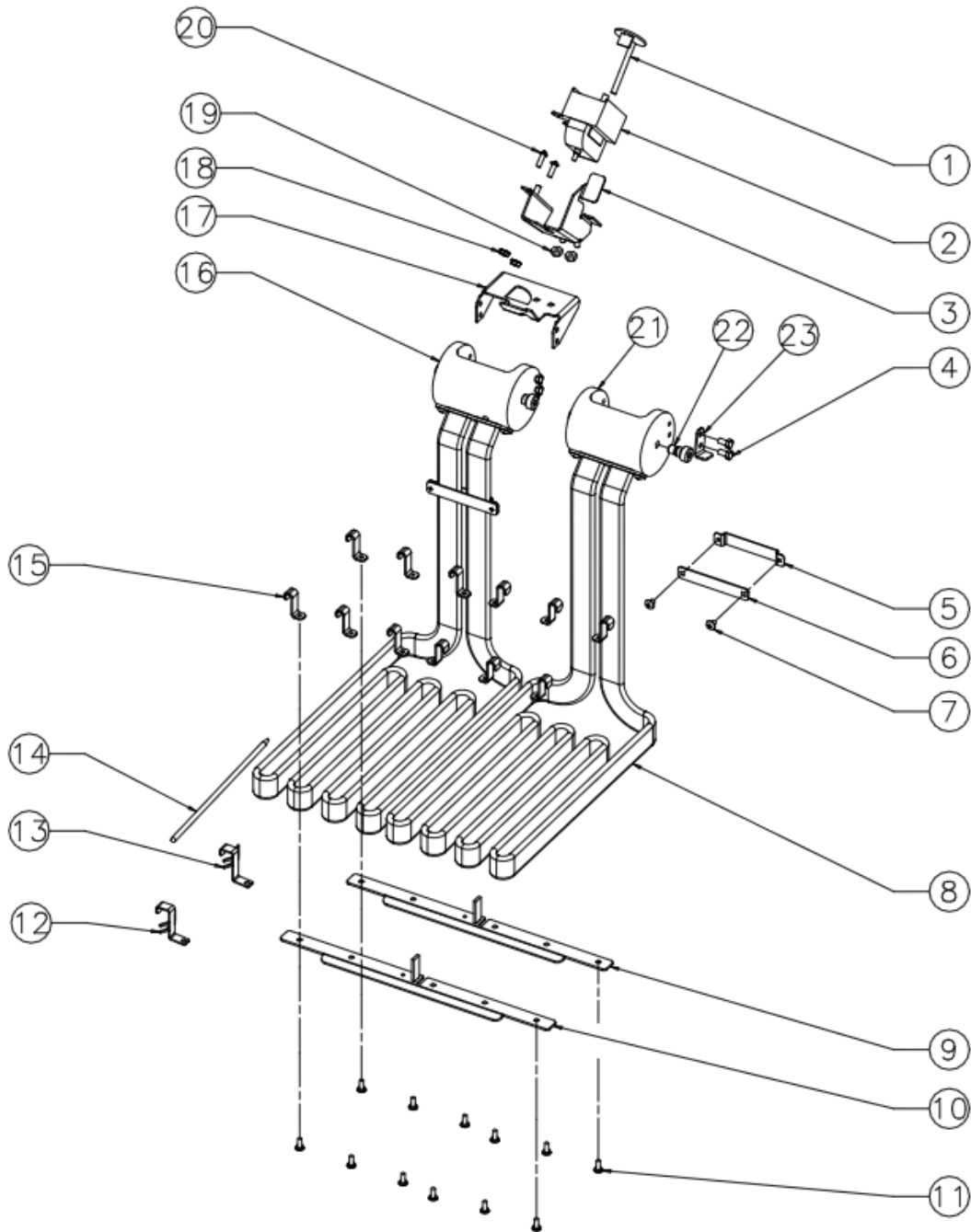

4-7 ASSY-FULL ELEMENT & HUB

ITEM	PN	DESCRIBE	QUANTITY
1	91627	STOP-ROTATION	1
2	60241	HIGH LIMIT-425° CE SETTING	1
3	92397	BRACKET-PIVOT HI LIMIT	1
4	SC01-084	SCREW #10-32 X 3/8 HEX HD S	2
5	75818	BRACKET-REAR CAPILLARY	2
6	75819	PLATE-FRONT CAPILLARY	2
7	SC01-076	SCREW #8-32 X 1/4 PH THD S	4
8	78484-05	ELEMENT-HEATING 7 KW LVE10X	2
9	92444	WELD ASSY-SPREADER FULL OFE142	1
10	92323	WELD ASSY-SPREADER FULL	1
11	SC04-003	SCREW #8-32 X 3/8 PH PHD S	12
12	78614	GUARD-FULL FRONT HI LIMIT LVE	1
13	78615	GUARD-FULL REAR HI LIMIT LVE	1
14	60241	HIGH LIMIT-425° CE SETTING	1
15	78499	STRAP-SPREADER LVE10X	12
16	74209	HOUSING-ELEMENT PIVOT	1
17	92393	BRACKET-HI-LIMIT MOUNTING	1
18	NS02-007	NUT HEX KEPS #8-32 C	2
19	NS02-006	NUT HEX KEPS #10-24 C	2
20	SC01-053	SCREW #8-32 X 1/2 PH RHD S	2
21	82459	HOUSING-ELEMENT PIVOT RH FULL	1
22	75022	SCREW-REWORKED 3/8 SHOULDER	4
23	91599	HEATER LIMIT BRACKET	1

4-8 ASSY POT&CTOP

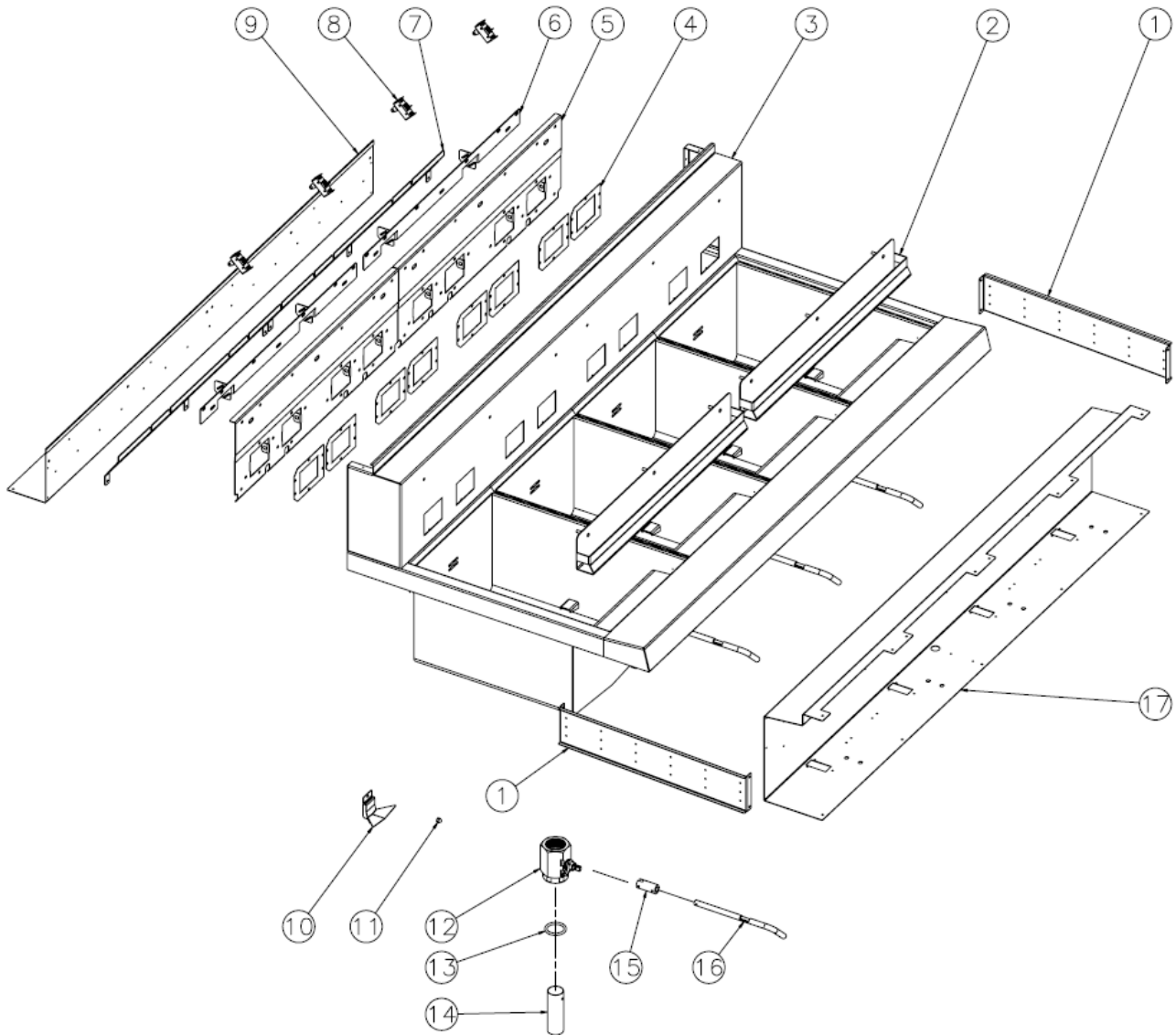

4-8 ASSY POT&CTOP

ITEM	PN	DESCRIBE	QUANTITY
1	93176	PANEL-SUPPORT WIRE	1
2	85935	STUD ASSY-BASKET HANGER	2
3	94864	WELD ASSY POT&CTOP_FULL	1
4	92128	GASKET-PIVOT HUB .015	8
5	87326	BRACE-OFE142F ELEMENT ROTATION	2
6	89484	RALL-INTERLOCK MTG-OFE-142	2
7	85678	BRACKET-SHROUD TO CNTOR OFE142	2
8	18227	SWITCH-MICRO-250F	4
9	94907	ENCLOSURE-CONTROL	1
10	93435	WELD ASSY-OIL DIVERTER	4
11	NS03-030	NUT #10-32 ACORN	4
12	89764	VALVE-DRN 1 1/2NPT & CAM LOCK	4
13	84415	O-RING -326 DRAIN VALVE LVX	4
14	81990	TUBE-S/F VALVE TO TROUGH LVE	4
15	55142	COUPLING - DRAIN VALVE	4
16	91348	ROD-NORMALLY OPEN DRAIN	4
17	94934	SHROUD-4 WELL COMPONENT	1

4-9 ASSY-FRAME

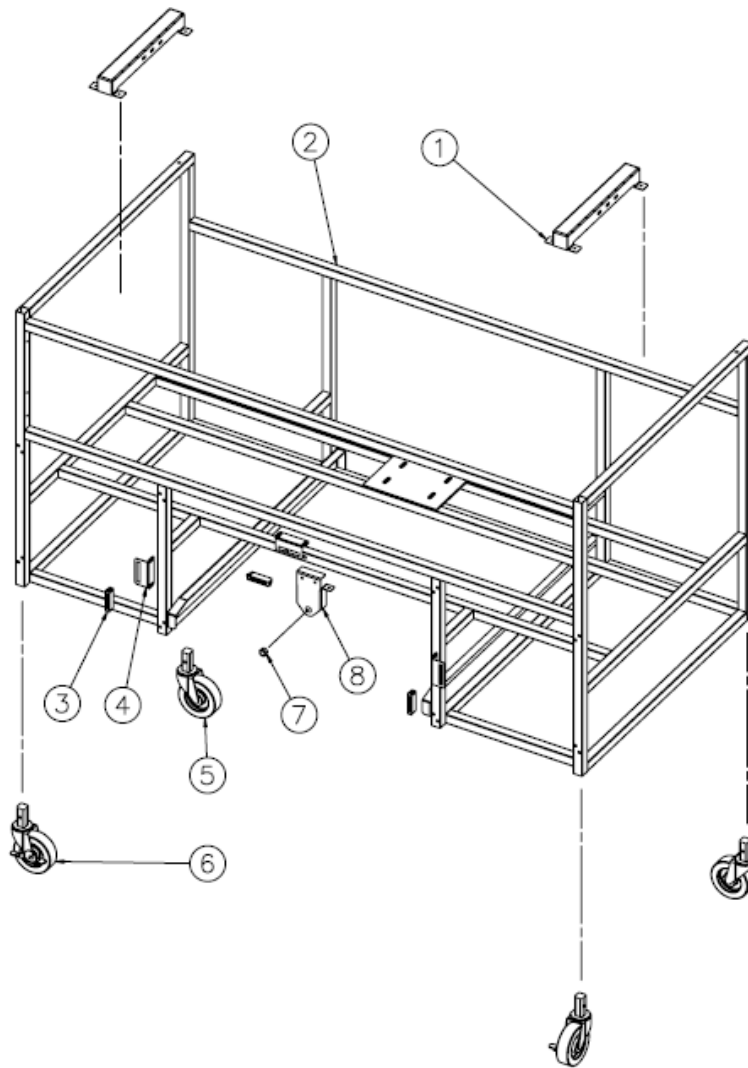

TEM	PN	DESCRIBE	QUANTITY
1	95030	BRACE -TROUGH	2
2	94866	WELD ASSY-FRAME-OFE144	1
3	17002	MAGNET	3
4	60503	BRACKET - MAGNETIC CATCH	3
5	60312	CASTER 4" SWIVEL W/O BRAKE	2
6	52064	CASTER 4" SWIVEL W/BRAKE	2
7	EF02-106	BUSHING-SNAP 1/2 ID PLASTIC	1
8	95033	BRACE B-MOTOR ROD SUPPORT	1

4-10 ASSY-LH DOOR OFE

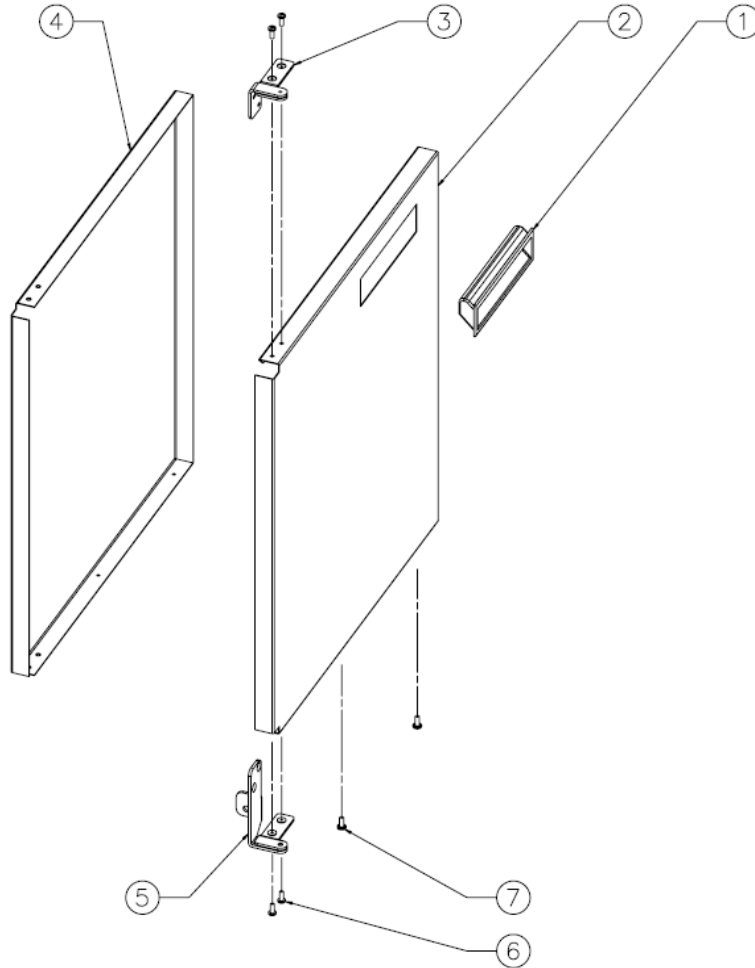

ITEM	PN	DESCRIBE	QUANTITY
1	41836	POCKET PULL	1
2	94950	PANEL-OUTER DOOR LH	1
3	17618	TOP HINGE ASSY	1
4	94949	PANEL-INNER DOOR LH	1
5	21034	BOTTOM HINGE ASSY	1
6	SC01-049	SCREW #6-32 X 3/8 PH PHD C	4
7	SC04-003	SCREW #8-32 X 3/8 PH PHD S	2

4-11 ASSY-RH DOOR OFE

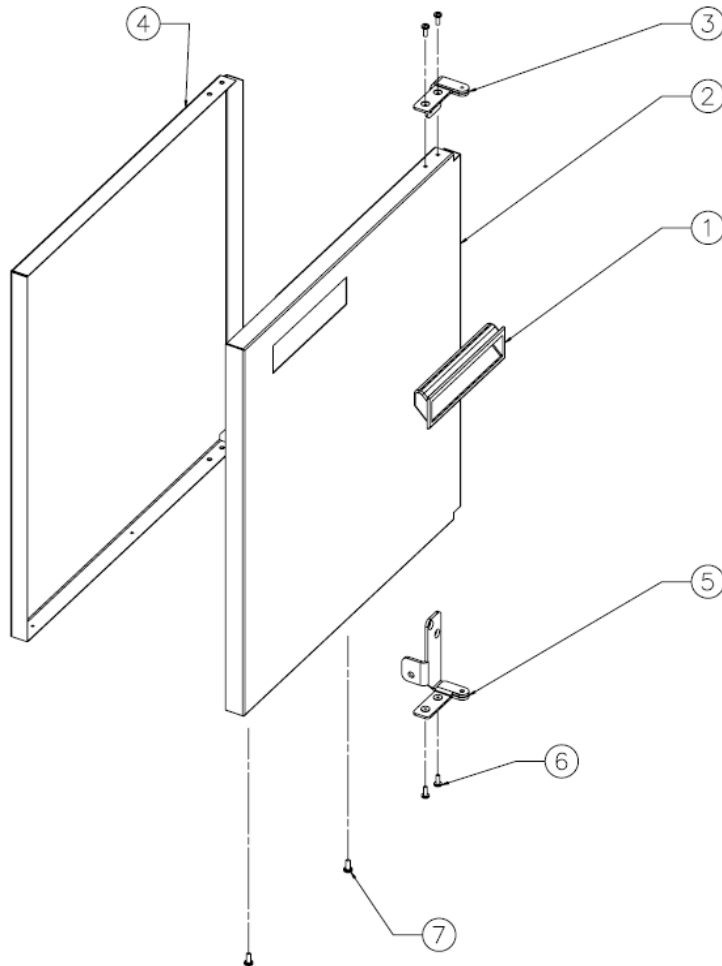

ITEM	PN	DESCRIBE	QUANTITY
1	41836	POCKET PULL	1
2	94954	PANEL-OUTER DOOR RH	1
3	17620	BOTTOM HINGE ASSY	1
4	94953	PANEL-INNER DOOR RH	1
5	21433	BOTTOM HINGE ASSY-RH 342	1
6	SC01-049	SCREW #6-32 X 3/8 PH PHD C	4
7	SC04-003	SCREW #8-32 X 3/8 PH PHD S	2

4-12 ASSY-MLH DOOR OFE

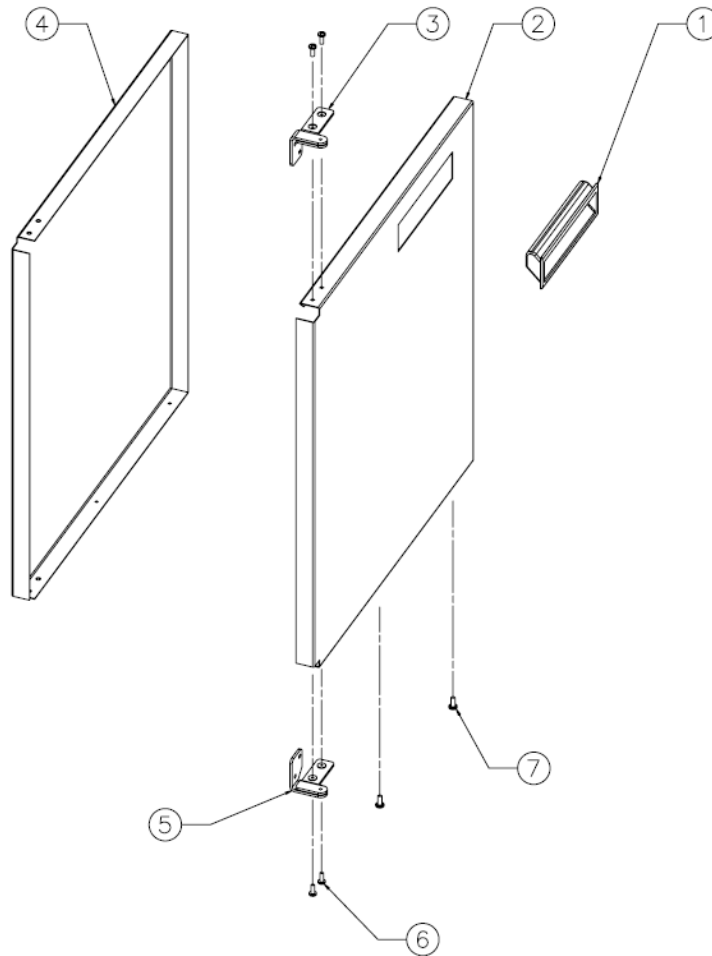

ITEM	PN	DESCRIBE	QUANTITY
1	41836	POCKET PULL	1
2	94950	PANEL-OUTER DOOR LH	1
3	17618	TOP HINGE ASSY	1
4	94949	PANEL-INNER DOOR LH	1
5	17620	BOTTOM HINGE ASSY	1
6	SC01-049	SCREW #6-32 X 3/8 PH PHD C	4
7	SC04-003	SCREW #8-32 X 3/8 PH PHD S	2

4-11 ASSY-MRH DOOR OFE

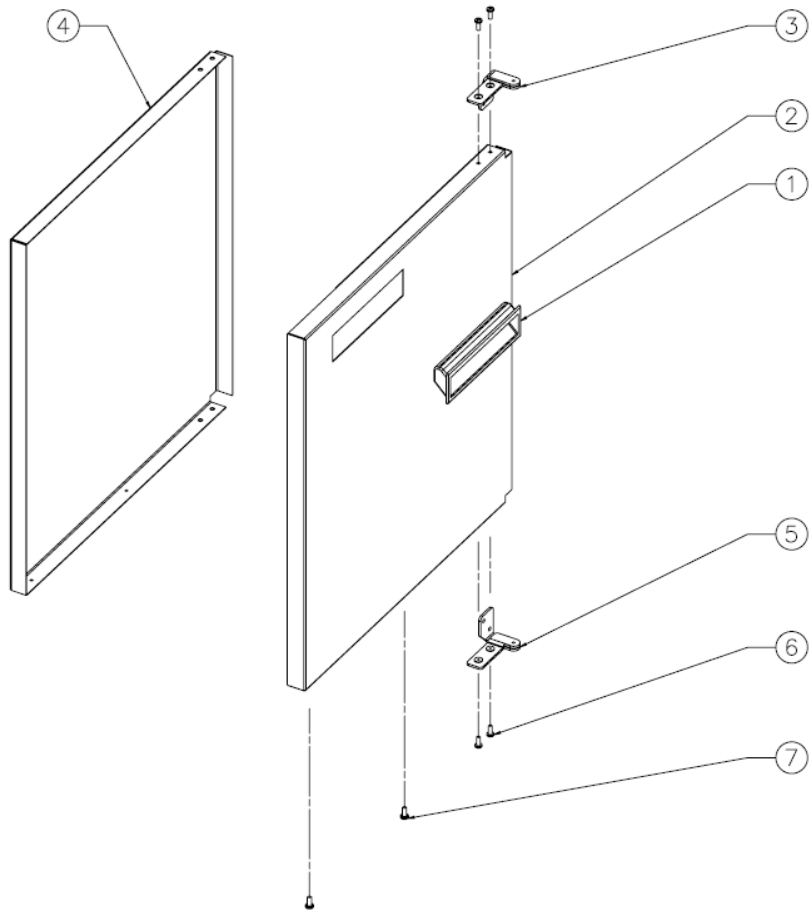

ITEM	PN	DESCRIBE	QUANTITY
1	41836	POCKET PULL	1
2	94954	PANEL-OUTER DOOR RH	1
3	17620	BOTTOM HINGE ASSY	1
4	94953	PANEL-INNER DOOR RH	1
5	17618	TOP HINGE ASSY	1
6	SC01-049	SCREW #6-32 X 3/8 PH PHD C	4
7	SC04-003	SCREW #8-32 X 3/8 PH PHD S	2

SECTION 5. TROUBLESHOOTING

5-1. TROUBLESHOOTING GUIDE

Problem	Cause	Correction
POWER switch ON but fryer completely inoperative	<ul style="list-style-type: none"> • Open circuit 	<ul style="list-style-type: none"> • Plug fryer in • Check breaker or fuse at supply box
Shortening will not heat but lights are on	<ul style="list-style-type: none"> • Open high limit • circuit 	<ul style="list-style-type: none"> • Reset high limit per • Drain valve open • Turn drain valve handle to closed Position
Foaming or boiling of shortening	<ul style="list-style-type: none"> • Water in shortening • Improper or bad shortening • Improper filtering • Improper rinsing after cleaning the fryer 	<ul style="list-style-type: none"> • At end of cook cycle, drain shortening and clean • Use recommended shortening • Refer to the procedure covering filtering the shortening • Clean and rinse the frypot, then dry thoroughly
Shortening will not drain from frypot	<ul style="list-style-type: none"> • Drain valve clogged with crumbs 	<ul style="list-style-type: none"> • Open valve, force cleaning brush through drain
Filter switch ON but motor does not run	<ul style="list-style-type: none"> • Motor thermal protector tripped 	<ul style="list-style-type: none"> • Reset thermal switch per section on Filter Pump Motor Protector – Manual Reset

Or detailed troubleshooting information is available in the Technical Manual, available at www.hennypenny.com, or 0512-89180262 or 1-800-417-8405 , 1-937-456-8405

5-2. ERROR CODES In the event of a control system failure, the digital display shows an error message. The message codes are shown in the DISPLAY column below. A constant tone is heard when an error code is displayed, and to silence this tone, press any button.

DISPLAY	CAUSE	PANEL BOARD CORRECTION
“E-4”	Control board overheating	Turn switch to OFF position, then turn switch back to ON; if display shows “E-4”, the control board is getting too hot; check the louvers on each side of the unit for obstructions
“E-5”	Shortening overheating	Turn switch to OFF position, then turn switch back to ON; if display shows “E-5”, the heating circuits and temperature probe should be checked
“E-6A”	Temperature probe open	Turn switch to OFF position, then turn switch back to ON; if display shows “E-6A”, the temperature probe should be checked; to replace, refer to Technical Manual
“E-6B”	Temperature probe shorted	Turn switch to OFF position, then turn switch back to ON; if display shows “E-6B”, the temperature probe should be checked; to replace, refer to Technical Manual
“E-10”	High limit	Reset the high limit by manually pushing up on the red reset button; if high limit does not reset, high limit must be replaced; refer to Technical Manual
“E-15”	Drain switch failure	Close drain, using the drain valve handle. If display still shows “E-15”, check the drain microswitch; refer to Technical Manual
“E-41”, “E-46”	Programming failure	Turn switch to OFF, then back to ON; if display shows any of the error codes, try to reinitialize the control (Special Program Mode section); if error code persists, replace the control board; refer to Technical Manual
“E-31”	Fan switch jumper wire missing or disconnected	Turn switch to OFF, then back to ON; if “E-31” persists, have jumper wires J2 & J4 on the 12-pin connectors on the PC board; if jumpers are OK, have PC board replaced
“E-54”	Faulty PC board component	Turn switch to OFF, then back to ON; if “E-54” persists, have PC board replaced
“E-70”	Faulty power switch, or switch wiring; faulty I/O board	Have POWER switch checked, along with its wiring. Have Input/Output board replaced if necessary