



# TECHNICAL M A N U A L

---

## SPLIT & FULL VAT ELECTRIC OPEN FRYER

---

MODEL

**MVE-072**

**MVE-073**

**MVE-074**

**HENNY PENNY**  
Engineered to Last

REGISTER WARRANTY ONLINE AT [WWW.HENNYPENNY.COM](http://WWW.HENNYPENNY.COM)

Read instructions before operating the appliance



## TABLE OF CONTENTS

Section	Page
Section 1. INTRODUCTION .....	1
1-1 Introduction .....	1
1-2 Proper Care.....	1
1-3 Assistance.....	1
1-4 Safety.....	2
Section 2. TROUBLESHOOTING / ERROR CODES .....	4
2-1 Troubleshooting.....	4
2-2 Error Codes .....	7
Section 3. INFO, FILTER & TEMP BUTTON STATS .....	9
3-1 INFO Button Stats.....	9
2-2 FILTER Button Stats.....	9
2-3 TEMP Button Stats.....	9
Section 4. LEVEL 1 PROGRAMMING .....	10
4-1 Modifying Product Settings .....	10
4-2 AIF Clock.....	12
4-3 Deep Clean Mode.....	13
4-4 Fryer Setup .....	14
Section 5. LEVEL 2 PROGRAMMING .....	15
5-1 Advanced Product Settings .....	15
5-2 E-Log (error code log).....	16
5-3 Passwords .....	17
5-4 Alert Tone (and volume) .....	17
Section 6. LEVEL 3 PROGRAMMING .....	18
6-1 Additional Advanced Product Settings .....	18
6-2 Special Programming .....	19
6-3 Clock Set .....	21
6-4 Data Comm & Heat Control.....	21
6-5 Tech Mode.....	22
6-6 Stats Mode.....	24
Section 7. INFORMATION MODE.....	25
7-1 Info Mode.....	25

**TABLE OF CONTENTS**

<b>Section</b>		<b>Page</b>
Section 8.	MAINTENANCE SECTION.....	27
8-1	Introduction .....	27
8-2	Maintenance Hints.....	27
8-3	Preventive Maintenance .....	27
8-4	Control Panel and Menu Card Replacement .....	28
8-5	High Temperature Limit System .....	29
8-6	Electric Heating Element .....	31
8-7	Breakers.....	33
8-8	Main Power Switch .....	34
8-9	Temperature Probe Replacement.....	34
8-10	Element Sense Switch .....	37
8-11	Contactors.....	38
8-12	Filter Pump & Motor.....	40
8-13	Transformers .....	43
8-14	Filter Motor Relay .....	44
8-15	Check Valve.....	44
	Plumbing Diagram .....	45
	Wiring Diagrams .....	46

## SECTION 1: INTRODUCTION

### 1-1 INTRODUCTION

The Henny Penny open fryer is a basic unit of food processing equipment. This unit is used only in institutional and commercial food service operations.

### 1-2 PROPER CARE



### NOTICE

As of August 16, 2005, the Waste Electrical and Electronic Equipment directive went into effect for the European Union. Our products have been evaluated to the WEEE directive. We have also reviewed our products to determine if they comply with the Restriction of Hazardous Substances directive (RoHS) and have redesigned our products as needed in order to comply. To continue compliance with these directives, this unit must not be disposed as unsorted municipal waste. For proper disposal, please contact your nearest Henny Penny distributor.

As in any unit of food service equipment, the Henny Penny open fryer does require care and maintenance. Requirements for the maintenance and cleaning are contained in this manual and must become a regular part of the operation of the unit at all times.

### 1-3 ASSISTANCE

Should you require outside assistance, call your local independent distributor in your area, or call Henny Penny Corp. at 1-800-417-8405 or 1-937-456-8405.

**1-4  
SAFETY**

The instructions in this manual have been prepared to aid you in learning the proper procedures for your equipment. Where information is of particular importance or is safety related, the words NOTICE, CAUTION, or WARNING are used. Their usage is described below.

If a problem occurs during the first operation of a new unit, recheck the Installation Section of the Operator's Manual.

Before troubleshooting, always recheck the Operation Section of the Operator's Manual.

Where information is of particular importance or is safety related, the words DANGER, WARNING, CAUTION, or NOTICE are used. Their usage is described as follows:



SAFETY ALERT SYMBOL is used with DANGER, WARNING or CAUTION which indicates a personal injury type hazard.



NOTICE is used to highlight especially important information.



*CAUTION used without the safety alert symbol indicates a potentially hazardous situation which, if not avoided, may result in property damage.*



*CAUTION used with the safety alert symbol indicates a potentially hazardous situation which, if not avoided, could result in minor or moderate injury.*



**WARNING indicates a potentially hazardous situation which, if not avoided, could result in death or serious injury.**



**DANGER INDICATES AN IMMINENTLY HAZARDOUS SITUATION WHICH, IF NOT AVOIDED, WILL RESULT IN DEATH OR SERIOUS INJURY.**

**1-4  
SAFETY  
(CONT.)**



Equipotential Ground Symbol



Waste Electrical and Electronic Equipment (WEEE) Symbol



OR

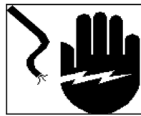

Shock Hazard Symbols



OR



Hot Surface Symbols

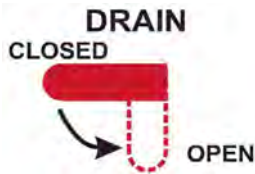

Shows direction to turn the red handle to open the drain valve to drain oil from vat

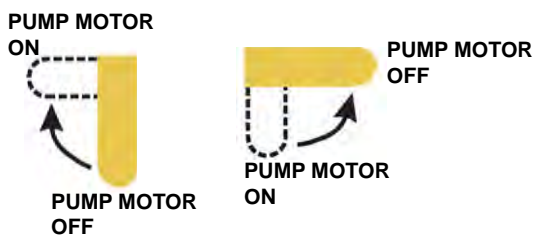

Shows direction to turn the yellow handle to open the fill valve to pump oil into vat

## SECTION 2: TROUBLESHOOTING / ERROR CODES

### 2-1 TROUBLESHOOTING



To isolate a malfunction, proceed as follows:

1. Clearly define the problem (or symptom) and when it occurs.
2. Locate the problem in the Troubleshooting table.
3. Review all possible causes. Then, one-at-a-time work through the list of corrections until the problem is solved.
4. Refer to the maintenance procedures in the Maintenance Section to safely and properly make the checkout and repair needed.



**If maintenance procedures are not followed correctly, injuries and/or property damage could result.**

**2-1  
TROUBLESHOOTING  
(CONT.)**

Problem	Cause	Correction
<p>POWER switch ON but fryer completely inoperative</p>	<ul style="list-style-type: none"> <li>Open circuit</li> </ul>	<ul style="list-style-type: none"> <li>Plug fryer in</li> <li>Check breaker or fuse at supply box</li> <li>(Non-US/some Int'l. locations only) Breakers in fryer tripped-open left door and reset breaker on fryer; See below</li> </ul> 
<p>Oil will not heat but lights are on No Heat error "E-22"</p>	<ul style="list-style-type: none"> <li>All power cords not plugged-in</li> </ul>	<ul style="list-style-type: none"> <li>Unit has 2 power cords; make sure both are plugged-in; have heat circuit checked</li> </ul>
<p>Control error code "E-10"</p>	<ul style="list-style-type: none"> <li>Open high limit circuit</li> </ul>	<ul style="list-style-type: none"> <li>Allow heating elements to cool (15-20 minutes) and reset high limit by pressing down and releasing raised side of the switch for the vat that is not operating; switches are located behind right door; if high limit does not reset, high limit must be replaced</li> </ul> 
<p>Vat is under-filled</p>	<ul style="list-style-type: none"> <li>Filter pan needs cleaned</li> </ul>	<ul style="list-style-type: none"> <li>Clean filter pan and change paper or pad</li> </ul>

**2-1  
TROUBLESHOOTING  
(CONT.)**

Problem	Cause	Correction
Oil foaming or boiling over top of vat	<ul style="list-style-type: none"> <li>• Water in oil</li> <li>• Improper or bad oil</li> <li>• Improper filtering</li> <li>• Improper rinsing after cleaning the vat</li> </ul>	<ul style="list-style-type: none"> <li>• Drain and clean oil</li> <li>• Use recommended oil</li> <li>• Refer to filtering procedures</li> <li>• Clean and rinse vat and then dry thoroughly</li> </ul>
Oil will not drain from vat	<ul style="list-style-type: none"> <li>• Drain valve clogged with crumbs</li> <li>• Drain trough clogged</li> </ul>	<ul style="list-style-type: none"> <li>• Open valve, use straight white brush to force crumbs through drain valve</li> </ul> <div data-bbox="1036 699 1284 772" style="border: 2px solid black; padding: 5px; text-align: center; font-weight: bold; font-size: 1.2em;">NOTICE</div> <p>Do not leave brush in drain valve.</p> <ul style="list-style-type: none"> <li>• Remove right side panel and remove plug from end of trough and clean trough</li> </ul>
Filter motor runs but pumps oil slowly	<ul style="list-style-type: none"> <li>• Filter line connections loose</li> <li>• Filter paper or pad clogged</li> </ul>	<ul style="list-style-type: none"> <li>• Tighten all filter line connections</li> <li>• Change filter paper or pad</li> </ul>
Bubbles in oil during entire filtering process	<ul style="list-style-type: none"> <li>• Filter pan not completely engaged</li> <li>• Filter pan clogged</li> <li>• Damaged O-ring on filter line receiver on fryer</li> </ul>	<ul style="list-style-type: none"> <li>• Make sure filter pan return line is pushed completely into the receiver on the fryer</li> <li>• Clean pan and change paper or pad</li> <li>• Change O-ring</li> </ul>
Control error code “E-31”	<ul style="list-style-type: none"> <li>• Elements are up</li> </ul>	<ul style="list-style-type: none"> <li>• Lower elements back into vat</li> </ul>
Filter motor will not run	<ul style="list-style-type: none"> <li>• Power cord for vat #1 is not plugged-in</li> <li>• Open circuit</li> <li>• The thermal reset button on the rear of the pump motor is tripped</li> </ul>	<ul style="list-style-type: none"> <li>• Plug power cord into receptacle</li> <li>• Breakers in fryer tripped-open left door and reset breaker on fryer</li> <li>• Allow time for the motor to cool; Using a screwdriver, press hard against the button until it clicks</li> </ul> <div data-bbox="956 1577 1442 1948"> </div>

**2-2  
ERROR CODES**

In the event of a control system failure, the digital display shows an error message. The message codes are shown in the DISPLAY column below. A constant tone is heard when an error code is displayed, and to silence this tone, press any button.

DISPLAY	CAUSE	CORRECTION
“E-4”	Control board overheating	Turn switch to OFF position, then turn switch back to ON; if display shows “E-4”, the control board is getting too hot; check the louvers on each side of the unit for obstructions
“E-5”	Oil Overheating	Turn switch to OFF position, then turn switch back to ON; if display shows “E-5”, the heating circuits and temperature probe should be checked
“E-6A”	Temperature probe open	Turn switch to OFF position, then turn switch back to ON; if display shows “E-6A”, the temperature probe should be checked
“E-6B”	Temperature probe shorted	Turn switch to OFF position, then turn switch back to ON; if display shows “E-6B”, the temperature probe should be checked
“E-10”	High limit  A = Trips above 300°F B = Trips below 300°F C = Tripped while cooking D = Tripped within 5 minutes after an Autofiltration F = Tripped while filtering M = Tripped during melt-mode Y = Tripped less than 5 minutes after user responded “YES” to “Is Pot Filled?”	Allow heating elements to cool (15-20 minutes) and reset high limit by pressing down and releasing raised side of the switch for the vat that is not operating; switches are located behind right door; if high limit does not reset, high limit must be replaced
“E-15”	Drain switch	Make sure drain handle is completely turned to the close position; if E-15 persists, have drain switch checked
“E-21”	Slow heat recovery	Have a certified service technician check the fryer for correct voltage to the unit; have the contactors and heating element checked; have unit checked for loose or burnt wires



**2-2  
ERROR CODES  
(CONT.)**

<b>DISPLAY</b>	<b>CAUSE</b>	<b>CORRECTION</b>
"E-22"	Heat Error-No Heat	Check power cord and have heat circuit checked
"E-31"	Elements are up	Lower elements back into the vat
"E-41", "E-46"	Programming failure	Turn switch to OFF, then back to ON; if display shows any of these error codes, have the controls re-initialized; if error code persists, have the control board replaced
"E-47"	Analog converter chip or 12 volt supply failure	Turn switch to OFF, then back to ON; if "E-47" persists, have the PC board replaced
"E-48"	Input system error	Turn switch to OFF, then back to ON; have control PC board replaced if "E-48" persists
"E-54C"	Temperature input error	Turn switch to OFF, then back to ON; have control PC board replaced if "E-54C" persists
"E-70C"	Drain valve jumper wire missing or disconnected	Have the jumper wire checked on the PC board at drain switch interlock position

## SECTION 3: INFO, FILTER & TEMP BUTTON STATS

### 3-1 INFO BUTTON STATS

#### Recovery Information for each Vat

1. Press and release  and REC shows in left display and the recovery time that oil temperature went from 250°F (121°C) to 300°F (149°C) shows in the right display. For example, 

REC	5:30
-----	------

 means it took 5 minutes and 30 seconds for the oil temperature to recover to 300°F (149°C) from 250°F (121°C).



2. Pressing the  button twice shows 1st language in left display and, if programmed, 2nd language in right display.

### NOTICE

If no buttons are pressed within 5 seconds in any of stats modes, the controls revert back to normal operation.

### 3-2 FILTER BUTTON STATS



#### Cook Cycles Remaining before Filtering

1. Press and release either  or  and the left display shows “COOKS REMAIN” and right display shows the number of cook cycles before the next auto filter. For example, 



REMA IN	3	6
---------	---	---

 means after 3 more cook cycles on the left vat, the controls ask operator if they are ready to filter or not. But, 6 more cook cycles remain on the right vat.

#### Time and Date

2. Press either  or  twice and time-of-day and date shows in the displays.

#### Filter Pad Usage

3. Press either  or  three times and number of hours the present filter pad has been used is shown in displays.

### 3-3 TEMP BUTTON STATS

#### Actual Oil Temperature

1. Press  and actual oil temperature shows in display, for each vat.

#### Set-point Temperature



2. Press  twice and SP shows in the display, along with the set-point (preset) temperature of each vat.

## SECTION 4: LEVEL 1 PROGRAMMING



### 4-1 MODIFYING PRODUCT SETTINGS

Level 1 contains the following:

- Modify product settings
- Set the AIF clock for products
- Perform the Deep Clean procedure
- Fryer Setup Mode

1. Press and hold  and  buttons until LEVEL - 1 shows in the display, followed by ENTER CODE.
2. Enter code 1, 2, 3, 4 (first 4 product buttons). “PRODUCT” and “SELECTN” show in the displays.
3. Press right √ button and “SELECT PRODUCT” and “-P 1-” (ex: NUGGETS) show in the displays.

#### Change Product Names

4. Use the ◀ and ▶ buttons to scroll through 40 products, or press desired product button .
5. Press right √ button and product (ex: NUGGETS) shows in the left display and “MODIFY”, and “YES NO” shows in right display. Press the √ button to change this product, or press the X button to choose another product.
6. If √ button was pressed, press and release a product button and the flashing letter changes to the first letter under the product  button that was pressed. For example, if  is pressed, the flashing letter changes to an “A”.

Press the same button again and flashing letter changes to a “B”. Press it again and the flashing letter changes to a “C”. Once the desired letter shows in the display, press ▶ button to continue to the next letter and repeat procedure.

Press and hold the right X button to exit Program Mode, or press ▼ button to continue on to “1. COOK TIME”.

#### To Change Times and Temperatures

7. Press ▼ until “COOK TIME” shows in display, and then use product buttons  to change time in minutes and seconds, to a maximum of 59:59.

**4-1  
MODIFYING PRODUCT  
SETTINGS  
(CONT.)**

- Press and release ▼ button and “TEMP” shows in the display, along with the preset temperature on the right side of the display.

Press the product buttons  to change the temperature. The temperature range is 190°F (88°C) to 380°F (193°C).

**Cook ID Change**

- Press ▼ button until “COOK ID” shows in the display along with the product ID. For example, NUG would be the ID for nuggets. Use the product buttons to change the ID, following the same procedure as Step 6 above.

**Alarms (Duty 1 & 2)**

- Press ▼ button until “DUTY 1” shows in left display, and an alarm time in right display. Press product buttons



to set an alarm.

Ex., If a Cook Cycle was set at 3 minutes, and an alarm was to go off after 30 seconds into the Cook Cycle, “0:30” would be set in display at this time. When the timer counts down to 2:30 the alarm sounds.

After alarm time is set, press ▼ button and “DUTY 2” shows in display, and a second alarm can be programmed.

**Quality Timer**

- Press ▼ button until QUAL TMR shows in display along with preset holding time. Press product buttons to adjust



hold time (2 hrs., 59 min. max.).

**AIF Disable**

- Press ▼ button until “AIF DISABLE” shows in display along with “YES” or “NO”. Using ◀ and ▶ buttons, change display to “YES” if that product is not to be included in automatic intermittent filtration operation, or “NO” if it is to be included.

**Assign Button**

- Press ▼ button until “ASSIGN BTN” shows in display, along with product (ex: NUGGETS). If this product already has a product button assigned to it, that LED will be lit. To assign other product buttons to that product, press and hold product button for 3 seconds and that LED stays lit. To remove a product from a button, press and hold product button with a lit LED and the LED goes out.

**4-2  
AIF CLOCK**



This feature allows the controls to be set for periods of the day that block the automatic “Filter Now” prompts. For example, the controls could be set to not interrupt with “Filter Now” prompts during the lunch rush, and during the supper rush. But, if filtering is desired

during this time, press and hold a  button to access the filter menu.

Each AIF Blocking period is defined by a start time (a time of day, XX:XX A, etc) and a duration in minutes.

Weekdays M-F are all grouped together. Up to four different AIF blocking periods may be programmed throughout the day for Monday - Friday. (All days share the same settings.)

A separate set of four blocking periods may be programmed for Saturdays, and a final set of four blocking periods may be programmed for Sundays.

1. Press and hold  and  buttons until LEVEL - 1 shows in display, followed by ENTER CODE.
2. Enter code 1, 2, 3, 4 (first 4 product buttons). “PRODUCT” and “SELECTN” show in the displays.
3. Press ▼ button once and “AIF CLOCK” shows in the displays.
4. Press √ button and use ◀ and ▶ buttons to scroll through “ENABLE” and “DISABLE” and press √ button again to select one.
5. If “ENABLE” is chosen, ▲ and ▼ buttons can be used to scroll through the following list of blocking periods:

Left Display	Right Display
M-F 1	XX:XX A XX
M-F 2	XX:XX A XX
M-F 3	XX:XX A XX
M-F 4	XX:XX A XX
SAT 1	XX:XX A XX
SAT 2	XX:XX A XX
SAT 3	XX:XX A XX
SAT 4	XX:XX A XX
SUN 1	XX:XX A XX
SUN 2	XX:XX A XX
SUN 3	XX:XX A XX
SUN 4	XX:XX A XX

**4-2  
AIF CLOCK  
(CONT.)**

In 12-hour clock mode, there are three items on each line: the start time “XX:XX”, the A or P (am/pm) setting, and the “XX” duration. Use the ◀ and ▶ buttons to set these items, which flashes when the item is selected.

To set a new start time setting, use the product buttons,



to enter the new value.

Press the ▶ button to step over to the AM/PM setting. The A or P can be toggled by pressing the ‘0’ product button.

Press the ▶ button again to step over to the duration value (in minutes). Enter a new value using the product buttons,



**NOTICE**

In 24-hour clock mode, there are only two items on each line: the time (XX:XX) and the duration (XX). Again, the ◀ and ▶ buttons step you between these items.



Press the right-side **X** button to exit out of AIF Clock programming mode.

**4-3  
DEEP CLEAN MODE**

This procedure allows a thorough cleaning of the vat by removing caramelized oil from vat. See Operator’s Manual for complete set of instructions.

**4-4  
FRYER SETUP**

This mode has the same settings as seen upon initial start-up of the fryer.

1. Press and hold  and  buttons until LEVEL - 1 shows in the display, followed by ENTER CODE.
2. Enter code 1, 2, 3, 4 (first 4 product buttons). “PRODUCT” and “SELECTN” show in the displays.
3. Press ▼ button 3 times and “FRYER SETUP” shows in displays.
4. Press √ button and \*SETUP\* \*MODE\* shows in displays, followed by, “LANGUAGE” on left display, “ENGLISH” on right display.

Use ◀ or ▶ buttons to change the operation display to, “FRANCAIS”, “CAN FREN”, “ESPANOL”, “PORTUG”, “DEUTSCHE”, “SVENSKA”, “РУССКИЙ”.

Press ▼ to continue with other set-up items which include:

- ZONE - USA or NON-USA
- TEMP FORMAT - °F or °C
- TIME FORMAT - 12-HR OR 24-HR
- ENTER TIME - Time of day (use product buttons to change)
- ENTER TIME - AM OR PM
- DATE FORMAT - US OR INTERNATIONAL
- ENTER DATE - Today’s date (use product buttons to change)
- FRYER TYPE - GAS or ELEC
- VAT TYPE - FULL OR SPLIT
- DISPOSE BULK OIL - YES/NO (BULK has RTI system)
- SUPPLY BULK OIL - YES/NO (BULK has RTI system)
- DAYLIGHT SAVING TIME - 1.OFF; 2.US (2007 & after); 3.EURO; 4.FSA (US before 2007)



Unless otherwise indicated, use ◀ or ▶ to change settings.

## SECTION 5: LEVEL 2 PROGRAMMING



### 5-1 ADVANCED PRODUCT SETTINGS

Used to access the following:

- Advanced changes to product settings
- Error code log
- Password programming
- Alert Tone/Volume
- No. of cook cycles before filter is suggested
- Automatic filter time

1. Press and hold  and  buttons until LEVEL - 2 shows in the display, followed by ENTER CODE.
2. Enter code 1, 2, 3, 4 (first 4 product buttons). “PROD” and “COMP” show in the displays.
3. Press right  $\sqrt{\phantom{x}}$  button and ‘SELECT PRODUCT’ and “-P 1-” show in the displays.
4. Use the  $\blacktriangleleft$  and  $\blacktriangleright$  buttons to scroll through 40 products, or press the desired product button
5. Press right  $\sqrt{\phantom{x}}$  button and product (ex: NUGGETS) shows in left display and “MODIFY” “YES NO” shows in right display. Press the  $\sqrt{\phantom{x}}$  button to change this product, or press the X button to choose another product.

>Load Compensation, Load Compensation Reference, Full Heat, PC Factor<

6. If  $\sqrt{\phantom{x}}$  button was pressed, “LD COMP” shows in the display along with the load compensation value. This automatically adjusts the time to account for the size and temperature of the cooking load.
7. Press product buttons  to change this value of 0 to 20.
8. Press  $\blacktriangledown$  button until “LCMP REF” shows in display along with the load compensation average temperature. (If load compensation is set to “OFF”, then “\_ \_ \_” shows in display and setting can’t be programmed.) This is the average cooking temperature for each product. Timer speeds up at temperatures above this setting and slows down at temperatures below this setting. Press product buttons  to change this value.

**5-1  
ADVANCED  
PRODUCT SETTINGS  
(CONT.)**

9. Press ▼ button until “FULL HT” shows in display along with full heat value in seconds, which means the heat is on as soon as a timer button is pressed, for programmed length of time. Press product buttons 

1	2	3	4	5	6	7	8	9	0
ABC	DEF	GHI	JKL	MNO	PQR	STU	VWX	YZ	* *

 to change this value of 0 to 90 seconds.
  
10. Press ▼ button until “PC FACTOR” shows in display along with proportional temperature, which helps to keep oil from over-shooting setpoint temperature. Press product buttons 



1	2	3	4	5	6	7	8	9	0
ABC	DEF	GHI	JKL	MNO	PQR	STU	VWX	YZ	* *

 to change this value of 0 to 50 degrees.

**NOTICE**

- Use ▲ button to go back to previous menu items.
- Press X button when finished with the current product, to return to the PRODUCT SELECTN step.
- Press X button a second time to exit PROD COMP mode.

**5-2  
E-LOG  
(ERROR CODE LOG)**



1. Press and hold  and  buttons until LEVEL - 2 shows in the display, followed by ENTER CODE.
2. Enter code 1, 2, 3, 4 (first 4 product buttons). “PROD” and “COMP” show in the displays.
3. Press ▼ button and “E-LOG” shows in the display.
4. Press right √ button and “A” plus the present date & time flashes on the display, along with “\*NOW\*”.
5. Press ▼ and if an error was recorded, “B” and date, time, and error code information shows in display. This is the latest error code that the controls recorded.
6. Press ▼ and next latest error code information can be seen. Up to 10 error codes (B to K) can be stored in E-Log Section.

**NOTICE**





Press and hold right √ button to view a brief description of the error.

**5-3  
PASSWORDS**

The 4-digit passwords can be changed for access to Set-Up, Usage, Level 1, Level 2, & Get Mgr.)

1. Press and hold  and  buttons until LEVEL - 2 shows in the display, followed by ENTER CODE.
2. Enter code 1, 2, 3, 4 (first 4 product buttons). “PROD” and “COMP” show in the displays.
3. Press ▼ button twice and “PASSWORD” shows in the display.
4. Press right √ button and “SET UP” shows in display. The Set up password can be changed at this time, or press ▼ once to change USAGE password, twice for LEVEL 1 password, 3 times for LEVEL 2 password, or 4 times for GET MGR password. And then, follow instructions below.
5. If password for the Set Up Mode (for example) is to be changed, press right √ button and “MODIFY?” “YES NO” shows in display. Press right √ button to change 4-digit password for Set Up Mode, using the product buttons .
6. Once new password is entered, “CONFIRM PASSWORD” shows in the display. Press √ button to confirm, or press X to choose another password.

**5-4  
ALERT TONE  
(AND VOLUME)**



1. Press and hold  and  buttons until “LEVEL - 2” shows in the display, followed by “ENTER CODE”.
2. Enter code 1, 2, 3, 4 (first 4 product buttons). “PROD” and “COMP” show in the displays.
3. Press ▼ button 3 times and “ALERT TONE” shows in display.
4. Press right √ button and “VOLUME” shows in the display, along with volume value. Use product buttons  to set volume from 1 (softest) to 10 (loudest).
5. Once volume is set, press √ button and “TONE” shows in display, along with the tone value. Use product buttons  to set the tone from 50 to 2000 Hz.
6. Press X to exit Alert Tone Mode.

## SECTION 6: LEVEL 3 PROGRAMMING





**6-1  
ADDITIONAL  
ADVANCED  
PRODUCT  
SETTINGS**

Used to access the following:

- TECH RESETS-Reset Recovery Faults/Passwords to defaults
- SPCL PROG-Program filter control parameters and other items
- CLOCK SET-Set the time-of-day clock / calendar
- DATA COMM-Data Communications, LonWorks, MMC, etc
- HEAT CTRL-Program heat algorithm control parameters
- TECH MODE-Control of outputs, display & button tests, etc.
- STATS MODE-Review, reset operating stats, diagnostic logs, etc

1. Press and hold  and  buttons until LEVEL - 3 shows in the display, followed by ENTER CODE.
2. Enter code 1, 1, 2, 2, 1, 1, 2, 2 (first 2 product buttons), and “A. TECH” & “RESETS” show in the displays.

### >Tech Resets<

3. Press right  button and “RECOVERY FAULTS” shows in the left display. The right display shows “CLR” and the number of recovery error recorded. Press  button to reset the number to “0”.
4. Press  button and “ALL PASSWRDS RESET” shows in the left display. Press  button to reset all the passwords set in the controls.

### **NOTICE**

- Use  button to go back to previous menu items.
- Press X button when finished with the current item, to return to the main menu.
- Press X button a second time to exit Level 3 programming.

**6-2  
SPECIAL  
PROGRAMMING**



The Special Program Mode is used to set more detailed programming, such as:

- SP-1** • ZONE - USA or Non-USA (default setpoints)
- SP-2** • System Initialization
- SP-3** • 2nd Language: English, French, Candian-French, German, Spanish, Portuguese, Swedish, Russian, & NONE
- SP-4** • 2nd Audio Volume
- SP-5** • Quick Configuration - CHKN+FSH; FF/HBR; CHKN; EMPTY
- SP-6** • Polish Duration - X:XX M:SS
- SP-7** • Edit S/N (Serial Number)
- SP-8** • Decal Layout? - UP/DOWN or DOWN/UP
- SP-9** • Recovery Test Limit - XXX SEC
- SP-10** • Melt Cycle Select - 1.LIQUID; 2.SOLID
- SP-11** • Oil Drain Time - XXX SEC
- SP-12** • Heat Error Enabled? - YES or NO
- SP-13** • Enable R&D Displays? - YES or NO

**NOTICE**

Not all Special Program Mode functions are discussed in this section. To ensure proper operation of fryer, please consult Henny Penny Corp. before changing any of these settings. For information on these functions, contact the Service Department at 1-800-417- 8405, or 1-937-456-8405.

To Enter Special Programming:

1. Press and hold  and  buttons until LEVEL - 3 shows in the display, followed by ENTER CODE.
2. Enter code 1, 1, 2, 2, 1, 1, 2, 2 (first 2 product buttons).
3. “A. TECH” & “RESETS” show in displays. Press ▼ and “B. SPCL” & “PROG” show in the displays.

**Zone - USA/Non-USA (SP-1)**

4. Press √ button and “SP-1 ZONE” shows in the left display. Use ◀ and ▶ buttons to set the default set-points to USA specifications or non-USA specifications.

**Initialize System (SP-2)**

5. Press ▼ button and “SP-2 DO SYSTEM INIT” scrolls in left display. To reset the controls to factory default settings, press and hold √ button and controls count down “IN 3”, “IN 2”, “IN 1”. Once display shows “-INIT-” & \*DONE\* the controls are reset to factory defaults.

**6-2  
SPECIAL  
PROGRAMMING  
(CONT.)**

**2nd Language (SP-3)**

6. Press ▼ button and “SP-3 2ND LANGUAGE” scrolls in left display. Use ◀ and ▶ buttons to set to: ENGLISH; FRANCAIS; CAN FREN; ESPANOL; PORTUG; DEUTSHE; SVENSKA; РУССКИЙ or -NONE-.

By setting a second language in the controls, 2 languages can now be easily chosen by pressing  **INFO** button twice during normal operation.

One language shows in left display and a second language shows in the right display. Pressing the √ button selects the language in the displays.

**2nd Volume (SP-4)**

7. Press ▼ button; “SP-4” and “2ND VOLUME” flash on the left display. Press the ◀ or ▶ buttons to select the desired 2nd volume.

By setting a 2nd volume in controls, 2 volumes can now be easily chosen by pressing  **INFO** button 3 times during normal operation.

One volume setting shows in the left display (NONE to 10; 10 being the loudest) and the second volume shows in the right display. To select the volume, press the √ button under the desired volume .





**Quick Configuration (SP-5)**

8. Press ▼ button and “SP-5 QUICK CONFIG” shows in display. Use the ◀ and ▶ buttons to change the menu selection in the controls to: CHKN+FSH; FF/HBR;CHKN or EMPTY.

**Polish Duration (SP-6)**

9. Press ▼ button and “SP-6 POLISH” shows in left display. Use product buttons  to change polish time, from 5 minutes to a maximum of 10 minutes.

**6-3  
CLOCK SET**

1. Press and hold  and  buttons until LEVEL - 3 shows in the display, followed by ENTER CODE.
2. Enter code 1, 1, 2, 2, 1, 1, 2, 2 (first 2 product buttons).
3. “A. TECH” & “RESETS” show in the displays. Press ▼ button twice and “C. CLOCK” and “SET” show in the displays.
4. Press √ button and “CS-1 ENTER DATE MM-DD-YY” shows in the left display. Use the product buttons  to set the date in the right display.
5. Press ▼ button and “CS-2 ENTER TIME” shows in the left display and the time flashes in the right display. Use the product buttons  to change the time.
6. Press ▼ button and “CS-2 ENTER TIME” shows in the left display and “AM” or “PM” flashes in the right display. Use the ◀▶ buttons to change from AM to PM or vice-versa.
7. Press ▼ button and “CS-3 TIME FORMAT” shows in left display and “12-HR” or “24-HR” shows in the right display. Use the ◀▶ buttons to change from a 12 hour time format a 24 hour time format or vice-versa.
8. Press ▼ button and “CS-4 DAYLIGHT SAVING TIME” shows in the left display. Use the ◀▶ right display to daylight saving time for your area: 1.OFF; 2.US (2007 & after); 3.EURO; or 4.FSA (US before 2007).

**6-4  
DATA COMM &  
HEAT CONTROL**

**NOTICE**

Data communications and heat controls settings are shown in Level 3 Program Mode. But, to ensure proper operation of fryer, please consult Henny Penny Corp. before changing any of these settings. For more information on these functions, contact Service Department at 1-800-417- 8405, or 1-937-456-8405.



**6-5  
TECH MODE**

The TECH Mode has self-diagnostic information, which can be used by certified technicians for troubleshooting purposes, such as:

- T-1 • Software
- T-2 • Fryer Type (Split or Full/Gas or Elec.)
- T-3 • Push-Button Test
- T-4 • All-On Display Test
- T-5 • Display Segments Test
- T-6 • Display Digits Test
- T-7 • Display Decimal Points Test
- T-8 • LED's Test
- T-9 • Left Temp. Probe Calibration & Offset
- T-10 • Right Temp. Probe Calibration & Offset
- T-11 • CPU Control Temp. Calibration/Offset/Highest
- T-12 • View A - D Channel
- T-13 • Digital Inputs
- T-14 • Outputs Test
- T-15 • Change Tech Code?
- T-16 • Total Initialization

**NOTICE**

Not all Tech Mode functions are discussed in this section. To ensure proper operation of fryer, please consult Henny Penny Corp. before changing any of these settings. For more information on these functions, contact Service Department at 1-800-417-8405, or 1-937-456-8405.



1. To enter the TECH Mode, press and hold  and  buttons for 5 seconds, until display shows "LEVEL 3", followed by "ENTER CODE".
2. Enter code 1, 1, 2, 2, 1, 1, 2, 2 (first 2 product buttons). "A. TECH" & "RESETS" show in the displays.
3. Press ▼ 5 times, and when display shows "F. TECH", press right √ button and T-1 "SOFTWARE" shows in the display, the first step of the TECH Mode. Use ▼ and ▲ buttons to toggle through the steps.

**NOTICE**

Press the right X button twice, at anytime to return to normal operation.

**6-5  
TECH MODE  
(CONT.)**

**T-1 - SOFTWARE**

- Press  to view HP Part No. of eeprom
- Press  to view software ID
- Press  to view software version

**T-2 - FRYER TYPE - SPLIT VAT OR FULL VAT/GAS or ELEC**

**T-3 - PUSH-BUTTON TEST**

Press any of the control buttons to test operation. You should hear a beep, and the LED should light and/or a display.

**T-4 - ALL-ON DISPLAY TEST**

Press any of the product buttons and all the LEDs and display segments should light.

**T-5 - SEGMENTS TEST**

Press any of the product buttons to view a different segment of the display characters.

**T-6 - DIGITS TEST**

Press any of the product buttons numerous times to view all segments of each digit across the displays.

**T-7 - DECIMAL PTS TEST**

Press any of the product buttons numerous times to view all decimal points across the displays.

**T-8 - LED'S TEST**

Press any of the product buttons numerous times to view each LED across the control panel.

**6-5  
TECH MODE  
(CONT.)**

**T-20 - PUMPS & VALVES (Continued)**









Press  to turn off and on the FILTER light (display shows “FLT\*” when on)

Press  to turn off and on the JIB LOW light (display shows “JLO\*” when on)

**6-6  
STATS MODE**

This mode allows a technician to view advanced information on the operation of the fryer and controls.



1. To enter the TECH Mode, press and hold  and  buttons for 5 seconds, until display shows ”LEVEL 3”, followed by “ENTER CODE”.
2. Enter code 1, 1, 2, 2, 1, 1, 2, 2 (first 2 product buttons). “A. TECH” & “RESETS” show in the displays.
3. Press  6 times, and when display shows “G. STATS”, press right  button and “ST-1 LAST RESET ON  show  the display, first step of the TECH Mode. Use  and  buttons to toggle through the steps.

- ST-1** • Stats Last Reset Date
- ST-2** • Fryer Total Running Hours
- ST-3** • Left Vat Melt Cycle Hours
- ST-4** • Left Vat Cook Cycle Hours
- ST-5** • Left Vat Filter Lockout Hours
- ST-6** • Right Vat Melt Cycle Hours
- ST-7** • Right Vat Cook Cycle Hours
- ST-8** • Right Vat Filter Lockout Hours
- ST-9** • Power-Ups Count
- ST-10** • Errors Count
- ST-11** • Left Vat Heat On Hours
- ST-12** • Right Vat Heat On Hours
- ST-13** • Highest Left Vat Oil Temperature
- ST-14** • Highest Right Vat Oil Temperature
- ST-15** • Highest CPU Temperature
- ST-16** • System RAM Fade Count
- ST-17** • Cook RAM Fade Count
- ST-18** • Product RAM Fade Count
- ST-19** • Stat RAM Fade Count
- ST-20** • RAM Data Error Count
- ST-21** • Data Total Loss Count
- ST-22** • User Intializations Count
- ST-23** • Automatic Initializations Count
- ST-24** • Cook Counts per Product
- ST-25** • Cook Cycle Stop Counts  
- “A” = no. of stops in 1st 30 sec.; - “B” = 0; - “C” = 0;  
- “D” = complete cook cycles counted
- ST-26** • Reset All Stats

## SECTION 7: INFORMATION MODE

### 7-1 INFO MODE

This mode gathers and stores historic information on fryer and operator's performance. Press and hold  for 3 seconds, until \*INFO\* \*MODE\* shows on the displays.

Press ▼ or ▲ buttons to access steps and press √ button to view the statistics within each step.

This mode includes the following information:

1. FILTER STATS - filtering information for the last 7 days
2. REVIEW USAGE- information accumulated since the last time this data was manually reset
3. LAST LOAD - information about the most recent Cook Cycle, or the cycle presently in progress

### NOTICE

Press X button to exit from the Information Mode.

#### 1. **FILTER STATS**

Press √ button to select Filter Stats and press ◀ and ▶ to select day you want to view stats. Then press ▼ or ▲ buttons to view the following stats:

“FILTERED” = No. of times filtered

“FLT BPSD” = No. of times filtering was skipped

“FLT AVG” = Average no. of cook cycles between filters

#### 2. **REVIEW USAGE**

Press √ button to select Review Usage and press ▼ or ▲ buttons to view the following:

FUNCTION	DISPLAY
Day usage data was previously reset	SINCE 9:32P 05-19-10
Total number of cook cycles	TOTAL COOKS 462
Cook Cycles stopped before “PULL”	QUIT COOK 4
Number of hours fryer was on (left)	L ON HRS 165
Number of hours fryer was on (right)	R ON HRS 160
Reset Usage Data	RESET USAGE YES/NO

**7-1  
INFO MODE  
(CONT.)**

3. **LAST LOAD**

Press √ button to select Last Load (ex: -P1- = Product 1; "L1" = left, 1st product) and press ▼ or ▲ buttons to view the following:

FUNCTION	DISPLAY
Product (Last product cooked)	PRODUCT -P1- L1
Time of day last Cook Cycle was started	STARTED 10.25A SEP-08
Actual Elapsed cook Time (Real seconds)	ACTUAL TIME 7:38
Programmed cook Time	PROG TIME 3:00
Max Temp during Cook Cycle	MAX TEMP 327°F
Min Temp during Cook Cycle	MIN TEMP 313°F
Avg Temp during Cook Cycle	AVG TEMP 322°F
Heat On (percentage) during Cook Cycle	HEAT ON 73%
Ready? (Was fryer Ready before start?)	READY? YES

## SECTION 8: MAINTENANCE

### 8-1 INTRODUCTION

This section provides checkout and replacement procedures, for various parts of fryer. Before replacing any parts, refer to Troubleshooting Section to aid you in finding the cause of the malfunction.

### 8-2 MAINTENANCE HINTS

1. A multimeter will help you to check electric components.
2. When the manual refers to the circuit being closed, the multimeter should read zero unless otherwise noted.
3. When the manual refers to a circuit being open, multimeter should read infinity.



**Do not move the fryer with hot oil in the vat or filter pan. Severe burns can result from splashing hot oil.**

### 8-3 PREVENTIVE MAINTENANCE

To ensure a long life of fryers and their components, regular maintenance should be performed. Refer to the chart below.

Frequency	Action
Daily	Maintenance Filter (See Maintenance Filtering Instructions Section in Operator's Manual or PM Guide)
Daily	Change Filter Pad (See Changing Filter Pad Section in Operator's Manual or PM Guide)
Weekly	Clean Behind Fryer
Quarterly	Change Filter Pan O-Rings
Quarterly	Vat Deep Clean (See Deep Clean Mode Section in Operator's Manual or PM Guide)

**8-4  
CONTROL PANEL  
& MENU CARD  
REPLACEMENT**



Should the control panel become inoperative, or the menu card needs changed, follow these instructions:

**Control Panel Replacement**

1. Remove electrical power supplied to the vat.



To avoid electrical shock or property damage, move the power switch to OFF and disconnect main circuit breaker, or unplug cord at wall receptacle.

2. Support control panel with one hand, loosen retaining screw at panel top, slide panel down enough to clear screw, push panel back up, then swing panel top out and down.
3. Unplug connectors on back of control panel.
4. Support control panel bottom with one hand, swing panel top up about 90 degrees, let panel slide down until hinge tabs come out of shroud slots, and remove panel.
5. Install new control panel by inserting hinge tabs in slots.
6. Plug connectors into back of control panel per label on panel or refer to diagram on page 7-29.
7. Support control panel bottom, swing panel top up about 90 degrees, slide panel down slightly to clear screw head, push panel top up to engage screw, then tighten screw.
8. Connect power and check operation of unit

**Menu Card Replacement**

1. Perform steps 1 and 2 above.
2. Loosen tape securing card at right side of control panel and pull card from panel. Carefully slide new menu card back into panel slot and secure with tape.
3. Perform steps 7 and 8 above.



**8-5  
HIGH TEMPERATURE  
LIMIT SYSTEM**

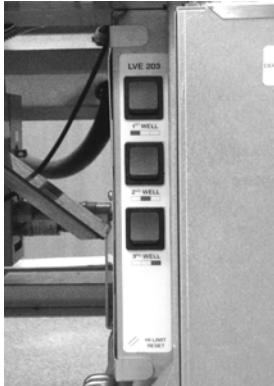

A high limit thermocouple is attached to each element and senses oil temperature. If temperature exceeds 425°F (218°C), a switch opens and shuts off heat to vat, and an E-10 error code is displayed. After oil temperature cools to a safe operating temperature (15-20 min.), high limit control must be manually reset.

Reset switches are located in the front edge of an electrical panel on the right side of the unit beside the JIB. Open the right door, depress the raised part of the rocker switch for the affected well, and release switch. If high limit resets, the oil starts heating. If high limit does not reset, perform following checkout procedure.

**Investigate:**



**To avoid electrical shock or property damage, move power switch to OFF and disconnect main circuit breaker, or unplug cord at wall receptacle.**

1. Remove 1 screw and panel cover.
2. Locate thermocouple wires from element and disconnect from high limit.
3. Using a multimeter and the chart on the next page, check the milivolt reading between the thermocouple wires and compare with the chart of the J-Type thermocouple. If the reading matches the chart, the thermocouple on the element is good and continue onto step 5 of the checkout. If not, go to section 7-6 on replacing the element.

**8-5  
HIGH TEMPERATURE  
LIMIT SYSTEM  
(CONT.)**

**Checkout: (Continued)**

**J°F**

**Table 8. Type J Thermocouple -- thermoelectric voltage as a function of temperature (°F); reference junctions at 32°F**

50	0.507	0.535	0.563	0.592	0.620	0.649	0.677	0.705	0.734	0.762	0.791	50
60	0.791	0.819	0.848	0.876	0.905	0.933	0.962	0.991	1.019	1.048	1.076	60
70	1.076	1.105	1.134	1.162	1.191	1.220	1.249	1.277	1.306	1.335	1.364	70
80	1.364	1.392	1.421	1.450	1.479	1.508	1.537	1.566	1.594	1.623	1.652	80
90	1.652	1.681	1.710	1.739	1.768	1.797	1.826	1.855	1.884	1.913	1.942	90
100	1.942	1.972	2.001	2.030	2.059	2.088	2.117	2.146	2.175	2.205	2.234	100
110	2.234	2.263	2.292	2.322	2.351	2.380	2.409	2.439	2.468	2.497	2.527	110
120	2.527	2.556	2.585	2.615	2.644	2.673	2.703	2.732	2.762	2.791	2.821	120
130	2.821	2.850	2.880	2.909	2.938	2.968	2.997	3.027	3.057	3.086	3.116	130
140	3.116	3.145	3.175	3.204	3.234	3.264	3.293	3.323	3.353	3.382	3.412	140
150	3.412	3.442	3.471	3.501	3.531	3.560	3.590	3.620	3.650	3.679	3.709	150
160	3.709	3.739	3.769	3.798	3.828	3.858	3.888	3.918	3.948	3.977	4.007	160
170	4.007	4.037	4.067	4.097	4.127	4.157	4.187	4.217	4.246	4.276	4.306	170
180	4.306	4.336	4.366	4.396	4.426	4.456	4.486	4.516	4.546	4.576	4.606	180
190	4.606	4.636	4.666	4.696	4.726	4.757	4.787	4.817	4.847	4.877	4.907	190
200	4.907	4.937	4.967	4.997	5.028	5.058	5.088	5.118	5.148	5.178	5.209	200
210	5.209	5.239	5.269	5.299	5.329	5.360	5.390	5.420	5.450	5.480	5.511	210
220	5.511	5.541	5.571	5.602	5.632	5.662	5.692	5.723	5.753	5.783	5.814	220
230	5.814	5.844	5.874	5.905	5.935	5.965	5.996	6.026	6.056	6.087	6.117	230
240	6.117	6.147	6.178	6.208	6.239	6.269	6.299	6.330	6.360	6.391	6.421	240
250	6.421	6.452	6.482	6.512	6.543	6.573	6.604	6.634	6.665	6.695	6.726	250
260	6.726	6.756	6.787	6.817	6.848	6.878	6.909	6.939	6.970	7.000	7.031	260
270	7.031	7.061	7.092	7.122	7.153	7.184	7.214	7.245	7.275	7.306	7.336	270
280	7.336	7.367	7.398	7.428	7.459	7.489	7.520	7.550	7.581	7.612	7.642	280
290	7.642	7.673	7.704	7.734	7.765	7.795	7.826	7.857	7.887	7.918	7.949	290
300	7.949	7.979	8.010	8.041	8.071	8.102	8.133	8.163	8.194	8.225	8.255	300
310	8.255	8.286	8.317	8.347	8.378	8.409	8.439	8.470	8.501	8.532	8.562	310
320	8.562	8.593	8.624	8.654	8.685	8.716	8.747	8.777	8.808	8.839	8.869	320
330	8.869	8.900	8.931	8.962	8.992	9.023	9.054	9.085	9.115	9.146	9.177	330
340	9.177	9.208	9.238	9.269	9.300	9.331	9.362	9.392	9.423	9.454	9.485	340
350	9.485	9.515	9.546	9.577	9.608	9.639	9.669	9.700	9.731	9.762	9.793	350
360	9.793	9.823	9.854	9.885	9.916	9.947	9.977	10.008	10.039	10.070	10.101	360
370	10.101	10.131	10.162	10.193	10.224	10.255	10.285	10.316	10.347	10.378	10.409	370
380	10.409	10.440	10.470	10.501	10.532	10.563	10.594	10.625	10.655	10.686	10.717	380
390	10.717	10.748	10.779	10.810	10.840	10.871	10.902	10.933	10.964	10.995	11.025	390
400	11.025	11.056	11.087	11.118	11.149	11.180	11.211	11.241	11.272	11.303	11.334	400
410	11.334	11.365	11.396	11.426	11.457	11.488	11.519	11.550	11.581	11.612	11.642	410
420	11.642	11.673	11.704	11.735	11.766	11.797	11.828	11.858	11.889	11.920	11.951	420
430	11.951	11.982	12.013	12.044	12.074	12.105	12.136	12.167	12.198	12.229	12.260	430
440	12.260	12.290	12.321	12.352	12.383	12.414	12.445	12.476	12.506	12.537	12.568	440
450	12.568	12.599	12.630	12.661	12.691	12.722	12.753	12.784	12.815	12.846	12.877	450
460	12.877	12.907	12.938	12.969	13.000	13.031	13.062	13.093	13.123	13.154	13.185	460
470	13.185	13.216	13.247	13.278	13.308	13.339	13.370	13.401	13.432	13.463	13.494	470
480	13.494	13.524	13.555	13.586	13.617	13.648	13.679	13.709	13.740	13.771	13.802	480
490	13.802	13.833	13.864	13.894	13.925	13.956	13.987	14.018	14.049	14.079	14.110	490
500	14.110	14.141	14.172	14.203	14.233	14.264	14.295	14.326	14.357	14.388	14.418	500
510	14.418	14.449	14.480	14.511	14.542	14.573	14.603	14.634	14.665	14.696	14.727	510
520	14.727	14.757	14.788	14.819	14.850	14.881	14.911	14.942	14.973	15.004	15.035	520
530	15.035	15.065	15.096	15.127	15.158	15.189	15.219	15.250	15.281	15.312	15.343	530
540	15.343	15.373	15.404	15.435	15.466	15.496	15.527	15.558	15.589	15.620	15.650	540

**NOTICE**

Oil temperature must be below 380°F (193°C) to perform this check.

4. Connect a known good high limit control into wiring for the suspect thermocouple and control.
5. Connect electrical power and operate vat. If vat does not overheat, replace defective control with known good part.
6. If vat overheats, perform more checkouts of other components (relays, contactors, probes, etc.) and replace the heating element as the last resort.

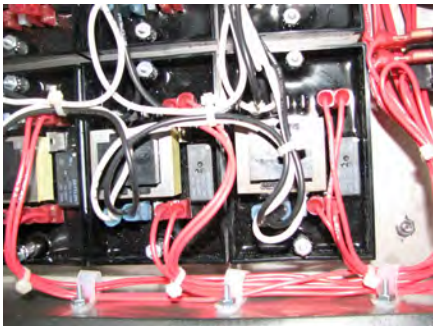

High Limit Controls

- Replacement
7. Tag and remove lead wires to module.
  8. Using 3/8" socket, remove 2 nuts securing control to panel.
  9. Install a new control in reverse order.

**8-6  
ELECTRIC HEATING  
ELEMENT**

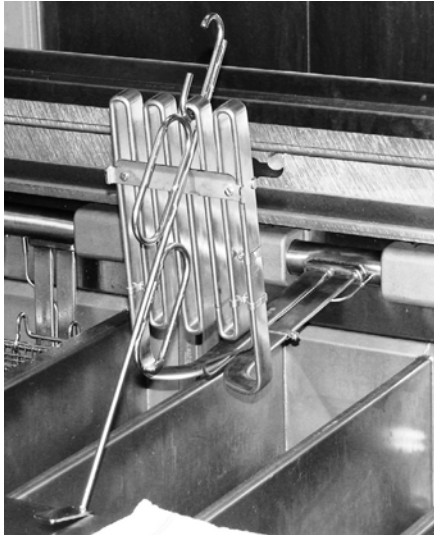

The fryers are equipped with as few as 2 heating elements or as many as 8 elements. If one of the small elements in the middle needs replacement, 1 or 2 of the other elements on either side must also be removed to gain access to the faulty element.

The high temperature limit sensor is an integral part of the heating element. If the sensor requires replacement, the heating element must be replaced.

**Replacement**

1. Drain oil from vat containing faulty element and any adjoining split vats from which heaters must be removed to gain access to defective element.
2. Using lift tool, raise the affected heating elements to assist in replacement of the faulty element and support them using vat lids or piece of lumber.



*Avoid putting the lift tool in the same area as the high limit bulb, or damage to the high limit could result.*



**To avoid electrical shock or property damage, move the power switch to OFF and disconnect main circuit breaker, or unplug cords at wall receptacle.**

3. Using Phillip's-head screwdriver, remove 6 screws and rear shroud.
4. Using a 1/2" wrench, remove 8 cap screws and 2 pivot blocks holding faulty heater in place.



Carefully gather up any slack in the lead wires for the heaters in the adjoining vats at the back of the fryer to minimize the amount of disassembly of the pivot blocks and heaters to keep from disconnecting all the wires but allow the defective heater to be replaced.

As needed, repeat previous step to remove any other pivot blocks for adjoining split vats that help hold the faulty heater in place.

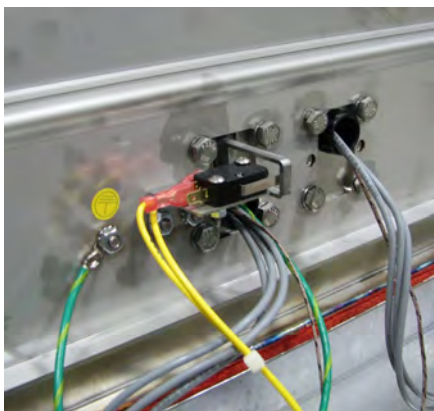

**8-6  
ELECTRIC HEATING  
ELEMENT  
(CONT.)**



**Replacement (continued)**

6. Remove element sense switch arm from heater pin and separate heater from pivot blocks.
7. Using 3/8" socket, remove nut and ground wire from stud.
8. Disconnect 3 heater wires from corresponding contactor in controls area behind control panels. Pull 2 leads to rear of fryer. **Leave 1 lead in place to pull new leads through.**
9. Disconnect 2 sensor wires from high temperature limit control. Pull 1 lead to rear of fryer.
10. Record routing of lead wires through pivot blocks and fryer sheet metal for use when installing new element.
11. Cut the 2 leads left in place and pull all remaining lead wires through pivot block. Remove heating element.
12. Inspect and replace defective pivot block seals and O-rings.

**Reassembly**

1. Position new element between pivot blocks and route lead wires through blocks and sheet metal as recorded earlier.
2. Assemble heating elements, pivot blocks, and switch arms making sure arms fully engage the pins on the elements and that no wire leads are pinched or severely kinked.
3. Working from the center out, install all pivot blocks while making sure switch arms are located over switches. Secure each block with 4 screws; tighten screws finger tight only.
4. Tape new thermocouple leads to old lead left in place, route to panel, and connect lead wires to high limit control.
5. Tape new power leads to old lead left in place and route to controls area at front of fryer and connect to contactor.
6. Align pivot blocks and heaters straight across front of fryer and snug screws. Lower elements into vats and adjust each so no element rubs side of vat. Make sure wires are clear and element sense switches operate properly.
7. Torque each heater retaining bolt to 70 inch pounds.
8. Connect ground wires, install panel, restore power, and test operation of fryer.

**8-6  
ELECTRIC HEATING  
ELEMENT  
(CONT.)**

Part #	Total Wattage per vat	Wattage per Heater	Volt.	System Volt.	System Wiring Config.	Watts per Sq. In.	Element Resistance per Element (Phase to Phase)	Element Resistance (Phase to Neutral)	Color Code
95590-005	7000	7000	220VAC	380VAC	4 WIRE WYE	37	N/A	1976	YELLOW
89899-005	14000	7000	220VAC	380VAC	4 WIRE WYE	37	N/A	1976	YELLOW

**8-7  
BREAKERS**

There are two breakers on the electric fryer which protect the filter pump. To reset the breaker, open the left door and push up on the plunger of the tripped breaker.



**To avoid electrical shock or property damage, move the power switch to OFF and disconnect main circuit breaker, or unplug cord at wall receptacle.**



1. Support control panel bottom with 1 hand, loosen retaining screw at panel top, slide panel down slightly to clear screw, push panel back up, then swing panel top out and down.

**Checkout**

2. Pull wires from breaker. Using a multimeter or continuity light, check across terminals - circuit should be closed. If not, replace the breaker.

**Replacement**

3. Open left door.
4. Using a 9/16" wrench, remove retaining nut from below and remove breaker from controls area.
5. Install new breaker in reverse sequence.
6. Support control panel bottom with 1 hand, swing panel top up about 90 degrees, slide panel down slightly to clear screw head, push panel top up to engage screw, then tighten screw.



**8-8  
MAIN POWER  
SWITCH**

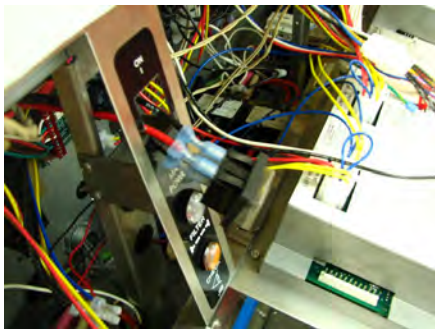

This is a covered rocker switch, which in the ON position, sends power to all the controls and filter motor. However, in some installations, one pair of contacts may be used to control an exhaust hood fan.



**To avoid electrical shock or property damage, move the power switch to OFF and disconnect main circuit breaker, or unplug cord at wall receptacle.**

1. Support control panel bottom with 1 hand, loosen retaining screw at panel top, let panel slide down slightly to clear screw, push panel back up, then swing panel top out and down.
2. From inside of control area, squeeze in on tabs on back of switch and push switch out the front of control area.
3. Label and remove wires from switch.

**Checkout**

4. Check across 2 sets of switch terminals for continuity. With switch in ON position, circuit should be closed. With switch in OFF position, circuit should be open.

If the switch is found to be defective, replace it by connecting the wires to new switch (as labeled) and push switch into place.

**8-9  
TEMPERATURE  
PROBE  
REPLACEMENT**

The temperature probe relays the actual shortening temperature to the control. If it becomes disabled, "E-6" will show in the display. Also, if the temperature is out of calibration more than 10°F, or 10°C, the temperature probe should be replaced.

Temp. F	Temp. C	Resistance Ohms	Temp. F	Temp. C	Resistance Ohms
50	10.00	1039.02	250	121.11	1464.79
60	15.56	1060.65	260	126.67	1485.71
70	21.11	1082.24	270	132.22	1506.58
80	26.67	1103.80	280	137.78	1527.43
90	32.22	1125.32	290	143.33	1548.23
100	37.78	1146.81	300	148.89	1569.00
110	43.33	1168.26	310	154.44	1589.73
120	48.89	1189.67	320	160.00	1610.43
130	54.44	1211.05	325	162.78	1620.77
140	60.00	1232.39	330	165.56	1631.09
150	65.56	1253.70	340	171.11	1651.72
160	71.11	1274.97	350	176.67	1672.31
170	76.67	1296.20	360	182.22	1692.86
180	82.22	1317.40	365	185.00	1703.13
185	85.00	1327.99	370	187.78	1713.38
190	87.78	1338.57	380	193.33	1733.87
200	93.33	1359.69	390	198.89	1754.31
210	98.89	1380.79	400	204.44	1774.72
212	100.00	1385.00	410	210.00	1795.10
220	104.44	1401.84	420	215.56	1815.44
230	110.00	1422.86	430	221.11	1835.74
240	115.56	1443.85	440	226.67	1856.01

An Ohm check can be performed also. See chart at left and Checkout instructions on next page.

**8-9  
TEMPERATURE  
PROBE  
REPLACEMENT  
(CONT.)**



**Checkout:**



To avoid electrical shock or property damage, move the power switch to OFF and disconnect main circuit breaker, or unplug cord at wall receptacle.

1. OHM reading of the suspect temp probe must be taken to determine if it is functioning properly.
2. Support control panel bottom with 1 hand, loosen retaining screw at panel top, slide panel down slightly to clear screw, push panel bottom up, then swing panel top out and down.
3. Disconnect 12-pin connector on left side of control panel.
4. Using multimeter, take ohm reading on appropriate Oil Temp pins. If readings are very different than charts on control panel label or on preceding page, replace probe.

**Replacement:**

1. Support control panel bottom with 1 hand, swing panel to up about 90 degrees, slide panel down slightly to clear screw head, push panel up to engage screw, and tighten.
2. Restore fryer power, and drain oil from vat into drain pan.
3. Using a 1/2" wrench, remove nut on compression fitting, and remove temperature probe from vat.
4. Lower the control panel again for vat with suspect probe, loosen retaining screw with Phillip's head screwdriver and hinge control panel down.
5. Disconnect 12-pin connector at left side of control panel and place connector on flat surface with the open side up.
6. Hold connector in place with one hand, use other hand to insert a small sharp tool into connector notch to depress metal locking tab.
7. Continue to hold locking tab down and pull lead wire out of the rear of connector and remove probe from fryer.



**8-9  
TEMPERATURE  
PROBE  
REPLACEMENT  
(CONT.)**

8. Place nut and new ferrule on new oil level probe and insert probe into compression fitting.
9. Follow probe installation instructions below:

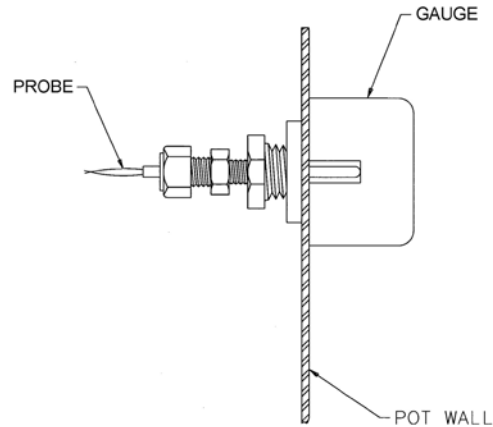

- NOTE:
- 1.) LOCATE TEMPERATURE PROBE THRU POT WALL.
  - 2.) PLACE GAUGE AGAINST POT WALL AS SHOWN.
  - 3.) PUSH TEMPERATURE PROBE THRU UNTIL IT MAKES CONTACT WITH GAUGE.
  - 4.) TIGHTEN TEMPERATURE PROBE IN PLACE.

**CAUTION**

*Excess force will damage temperature probe. Hand-tighten nut and then 1/2 turn with a wrench.*

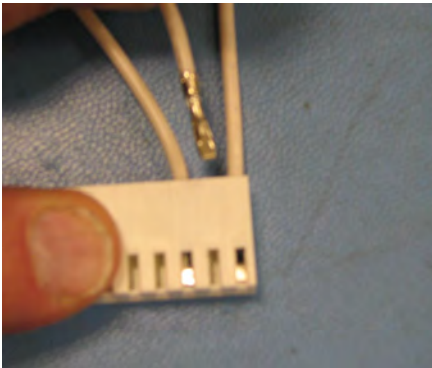

10. With locking tab up, insert pin into connector opening and visually check that tab is fully engaged. Fasten connector to control panel.
11. Support control panel bottom with 1 hand, swing panel top up about 90 degrees, slide panel down slightly to clear screw head, push panel top up to engage screw, then tighten screw.
12. Reconnect power to vat.
13. Return the oil from the drain pan to the appropriate vat.

**8-10  
ELEMENT SENSE  
SWITCH**

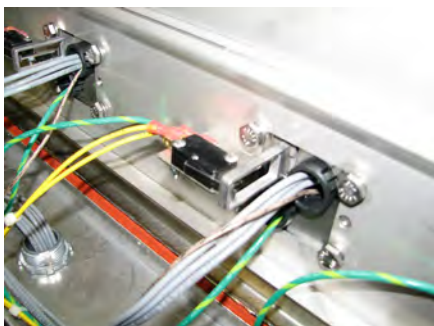
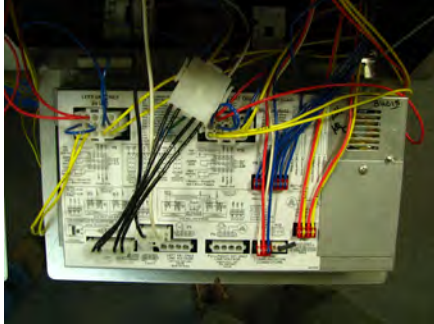

This switch removes power to the element when the element is raised. If a constant “E-31” “HEATING ELEMENTS ARE UP”, is shown on display when elements are lowered into vat, check element safety switch.



**To avoid electrical shock or property damage, move power switch to OFF and disconnect main circuit breaker, or unplug cord at wall receptacle.**

**Checkout:**

1. Support control panel bottom with 1 hand, loosen retaining crew at control panel top, slide panel down slightly to clear screw, push panel up, swing panel top out and down.
2. Refer to decal on control panel back, locate P9 connector (left vat-split vat) or P10 connector (full or right vat).
3. Pull connector from panel and using multimeter, check for continuity between 2 appropriate pins (labeled HEAT SWITCH). With safety switch plunger pushed in (element lowered), circuit should be closed. With element up, circuit should be open. If switch is faulty, replace switch.

**Replacement:**

1. Remove 6 screws and rear shroud.
2. Pull the wires from the switch.
3. Use Phillip’s-head screwdriver and 5/16” nut driver to remove 2 screws and nuts securing the switch.
4. Reassemble with new switch, making sure switch lever is inside hole of element sense arm and the switch is actuated, and then reconnect wires to the switch.
5. Reinstall rear shroud.
6. Reconnect P9 or P10.
7. Support control panel bottom with 1 hand, swing panel top up about 90 degrees, slide panel down slightly to clear screw, push panel up to engage screw, and tighten screw.

**7-11. CONTACTORS**

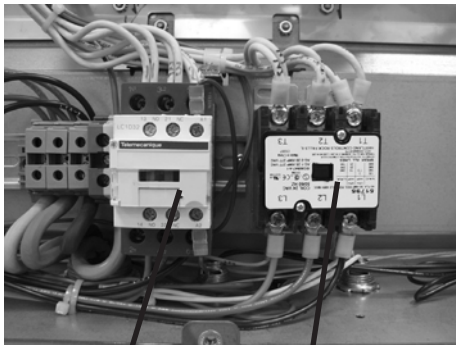

Heat Safety

The open fryer requires two switching, 24V contactors per vat: a primary (safety) and a secondary (heat) contactor. The primary contactor energizes (contacts close) anytime the vat control's power button  is pressed on, and the temperature of the shortening is below 420° F ( 215° C). The high limit cuts power at the primary contactor if the temperature of the shortening is above 420° F ( 215° C). The primary contactor supplies power to one side of the heat contactor.

The heat contactor is controlled by the computer controller. When the controller calls for heat, the heat contactor applies power to one side of the heating elements. When the heat contactor and primary contactor are energized (contacts closed) the electric heating elements heat the shortening.

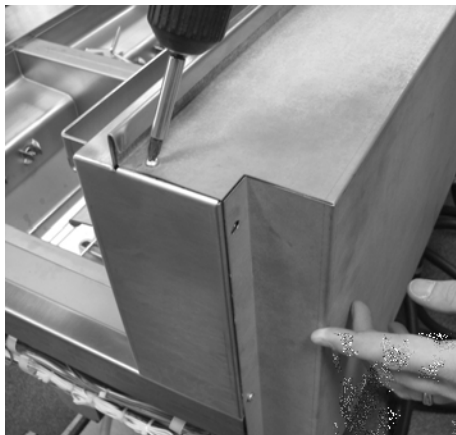

**Checkout:**

1. Remove electrical power supplied to the fryer and then remove the top, rear panel.



**To avoid electrical shock or property damage, move the power switch to OFF and disconnect main circuit breaker, or unplug cord at wall receptacle.**

2. Perform a continuity test across each set of contacts (L1, L2 and L3) on the primary contactor. Perform this test on each vat on the fryer. If continuity is found across any set of contacts, take the vat out of service until the primary contactor is replaced. Notate results.

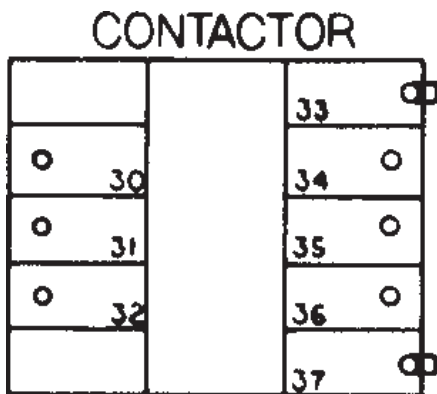

<u>Test Points</u>	<u>Results</u>
From 30 to 34	open circuit
From 31 to 35	open circuit
From 32 to 36	open circuit

3. Connect power to the fryer, and then cycle power three times to each vat using each control's power switch.
4. Repeat step 1. If L1, L2 or L3 has continuity then replace the contactor.

**8-11  
CONTACTORS  
(CONT.)**

**Replacement**

If either contactor proves defective, replace as follows:



**To avoid electrical shock or property damage, move power switch to OFF and disconnect main circuit breaker, or unplug cord at wall receptacle.**

1. Label and remove only those wires directly connected to the contactor being replaced.
2. Using a 3/8" wrench or socket, remove 2 mounting nuts on base plate of contactor being replaced and remove contactor.

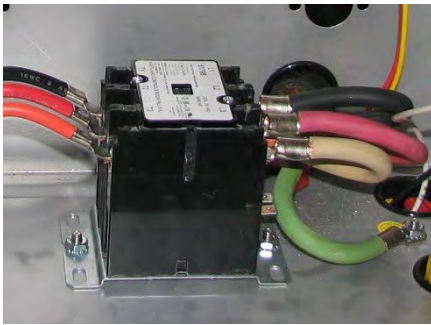

3. When replacing the heat contactor, slide it from the mounting rail.
4. Install new contactor in reverse order.
5. Reconnect power to the fryer and test for proper operation.
6. Support control panel bottom with 1 hand, swing panel top up about 90 degrees, slide panel down slightly to clear screw head, push panel top up to engage screw, then tighten screw.



**8-12  
FILTER PUMP &  
MOTOR**

The 2 most common causes for a fryer not to pump oil are the pump is clogged, or the thermal overload switch has been tripped on the motor. The pump and motor are located behind the middle door above the drain pan.

To remove debris from pump:

1. Loosen four Allen head screws on end of pump and remove cover. (Removing the bottom rear panel may help in accessing the set screws.)
2. The inside is now exposed leaving a rotor and five rollers. Clean the rotor and rollers.
3. To reassemble, place rotor on drive shaft, and place roller into rotor.



**NOTICE**

A small amount of grease might be needed to hold the bottom roller into place until cover plate is put on. Make sure O-ring is in proper position on plate.

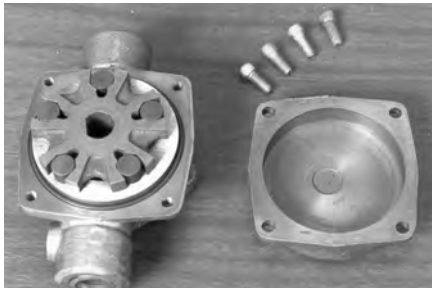

**CAUTION**

*There is an indicator on the side of the two halves of the pump, these marks must be aligned.*



To reset the thermal overload switch:

1. Open middle door, locate pump and motor above drain pan and if the motor is hot, allow it to cool for about 5 minutes.
2. Since it takes some effort to reset the switch, use a tool, such as a Phillip's-head screwdriver, to press against the reset button until an audible "click" is heard.

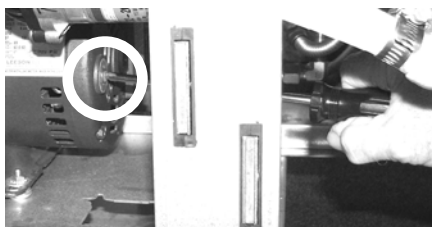

**8-12  
FILTER PUMP &  
MOTOR  
(CONT.)**



To avoid electrical shock or property damage, move the power switch to OFF and disconnect main circuit breaker, or unplug cord at wall receptacle.

Motor Removal:



1. Open the door that houses the drain pan and remove the drain pan from under the unit.
2. Using a 1" wrench, disconnect the line at the elbow or tee on the front of the pump.



3. Using a 1" wrench, disconnect the line at fitting on the rear of the pump.
4. Remove the motor cover.



5. Using Phillip's-head screwdriver, remove the rear cover from motor, exposing the wires.
6. Loosen the conduit clamp, disconnect wires, and pull the wires through the conduit clamp.

**8-12  
FILTER PUMP &  
MOTOR  
(CONT.)**



7. Using 7/16 in. wrenches, remove 3 nuts, lockwashers, flat washers, spacer washer sets, and bolts securing the motor to the motor bracket.
8. Pull the pump and motor assembly from fryer.
9. Re-install pump and motor assembly following the above steps in reverse order; however, leave assembly mounting bolts and nuts loose and perform position adjustment using the drain pan after all electrical and plumbing connections are made.

To replace pump on motor:

1. Using a 1/2 in. wrench, remove 2 bolts securing the pump to the motor and pull the pump from the motor.
2. Install a new seal kit (part no. 17476) onto shaft of motor.
3. Align the motor shaft motor with the pump rotor on the inside of pump body and push pump on motor shaft.
4. Secure the pump to the motor with the 2 bolts.

To adjust pump and motor assembly position:

1. Loosen bolts and nuts securing assembly to bracket.
2. Slide filter pan in under fryer on the rails until it rest against drain trough nozzle so drain pan cover opening is aligned with nozzle.
3. Check to be sure drain pan latch fully engages pan with about 1/16" (2 - 3 mm) of play. Adjust as needed.
4. Move pump and motor assembly so both O rings on drain pan fully engage Plug and Play connector and no O ring is visible.
5. Tighten bolts and nuts securing assembly to bracket.

**8-13  
TRANSFORMERS**

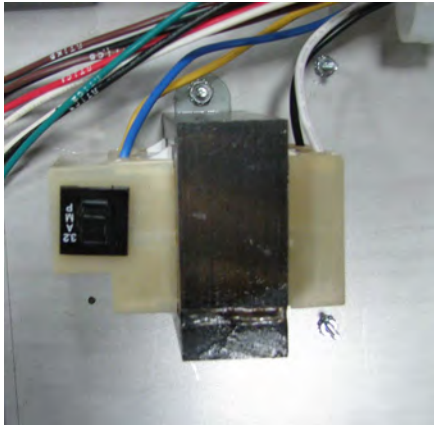

**Control Transformer**

These components drop the line voltage to low voltage components such as, control board, AIF board and contactor coils. Each control transformer is equipped with an integral reset switch.

Checkout:



**To avoid electrical shock or property damage, move the power switch to OFF and disconnect main circuit breaker, or unplug cord at wall receptacle.**

1. Support control panel bottom with 1 hand, loosen retaining screw at top, slide panel down slightly to clear screw, push panel back up, then swing panel top out and down.
2. Press reset button on control transformer. If transformer does not reset, continue with procedure.
3. Pull appropriate connector from the control PC board.



**To avoid electrical shock, use care when checking transformer. The following checks are performed with wall circuit breaker closed and main power switch in ON position.**

4. With power on, take a voltage reading on the appropriate pins. If transformer proves faulty, continue with replacement instructions.

Replacement:

1. Disconnect electrical power and using a 5/16" socket, remove nuts securing transformer and pull transformer from unit.
2. Replace transformer in reverse order.
3. Support control panel bottom with 1 hand, swing panel top up about 90 degrees, slide panel down slightly to clear screw, push panel up to engage screw, and tighten screw.

**8-14  
FILTER MOTOR  
RELAY**

This component is located behind the left control panel and regulates voltage to the filter motor. Part No. is ME90-011.

Replacement



**To avoid electrical shock or property damage, move the power switch to OFF and disconnect main circuit breaker, or unplug cord at wall receptacle.**

1. Support control panel bottom with 1 hand, loosen retaining screw at panel top, slide panel down slightly to clear screw, push panel back up, then swing panel top out and down.
2. Label and remove wires from relay.
3. Using a 5/16" socket, remove nuts securing the relay and remove relay from fryer.
4. Install new relay in reverse order.
5. Support control panel bottom with 1 hand, swing panel top up about 90 degrees, slide panel down slightly to clear screw, push panel up to engage screw, and tighten screw.

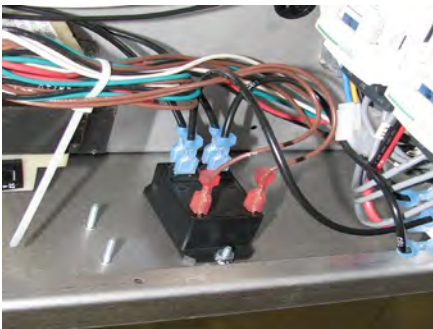

A check valve is installed in the fill line to each vat to keep oil from flowing out of the vat.

**8-15  
CHECK VALVE**

Replacement



**To avoid electrical shock or property damage, move the power switch to OFF and disconnect main circuit breaker, or unplug cord at wall receptacle.**

1. Disassemble flexible oil lines and fittings from valve as necessary.
2. Apply thread sealant to the internal threads of both inlet and outlet sides of the check valve.
3. Reassemble fittings to check valve and install valve and oil lines.

Apply Primer Here



Apply Primer Here

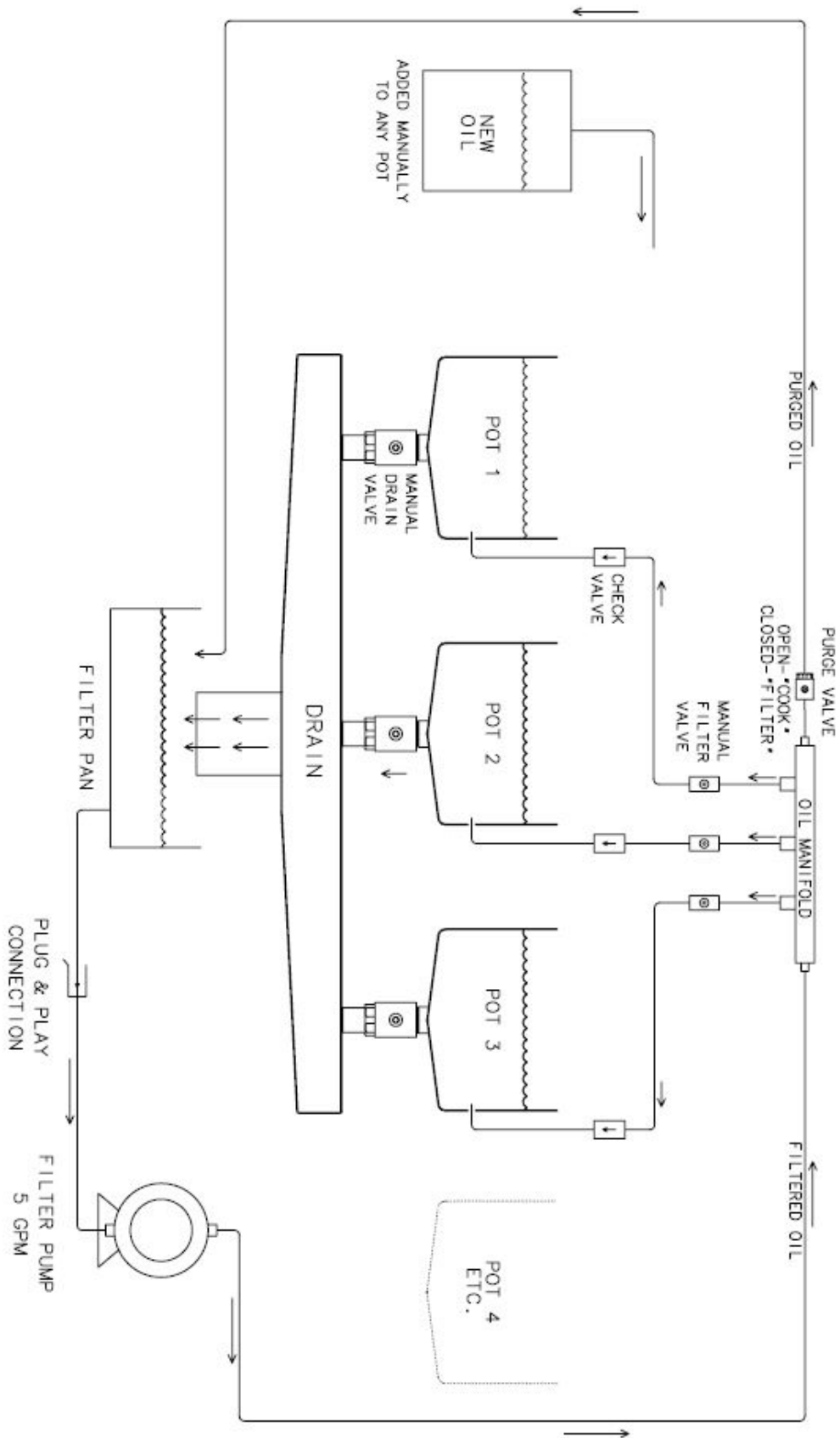

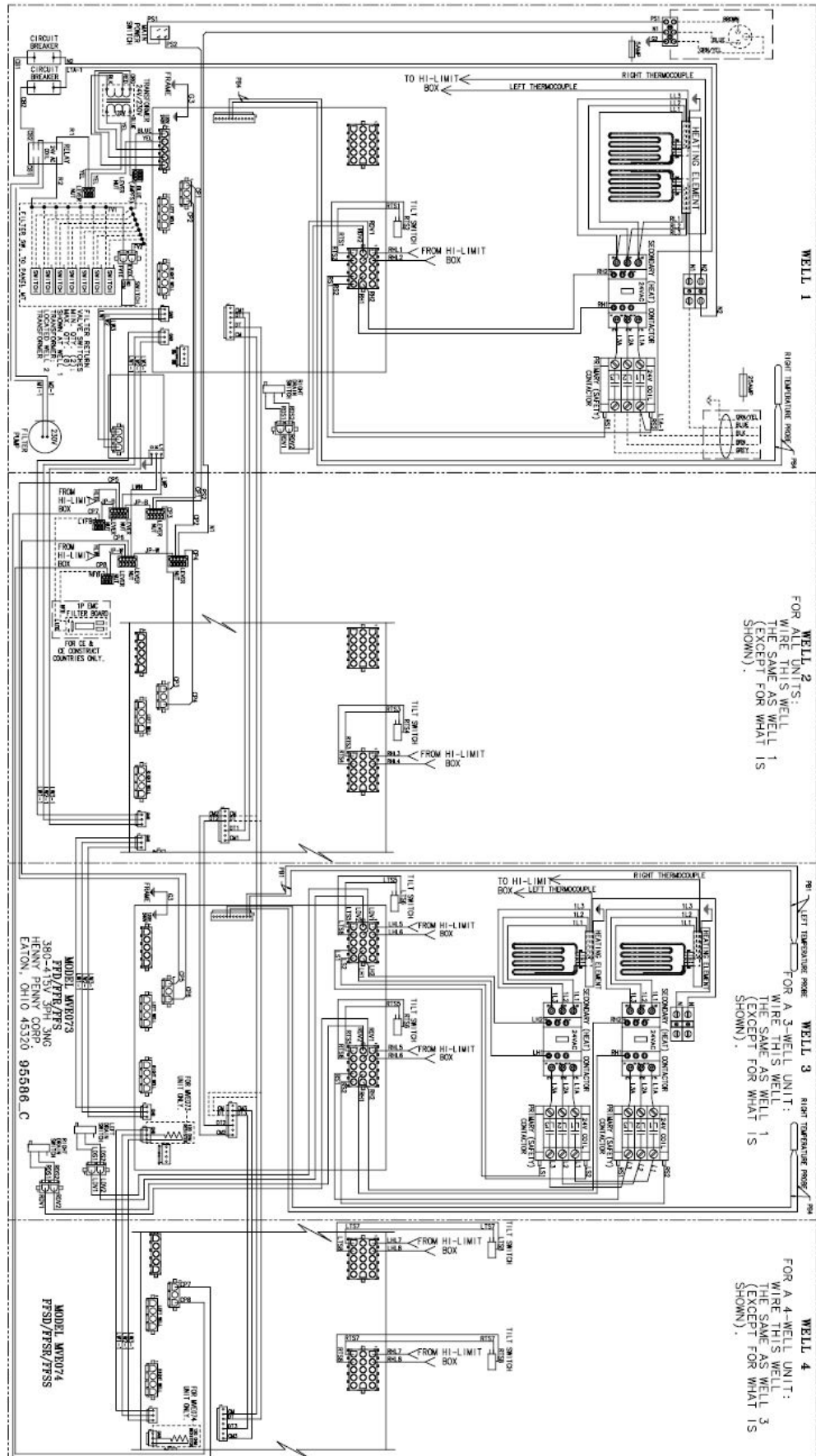

380-415/3 - FFS / FFSS

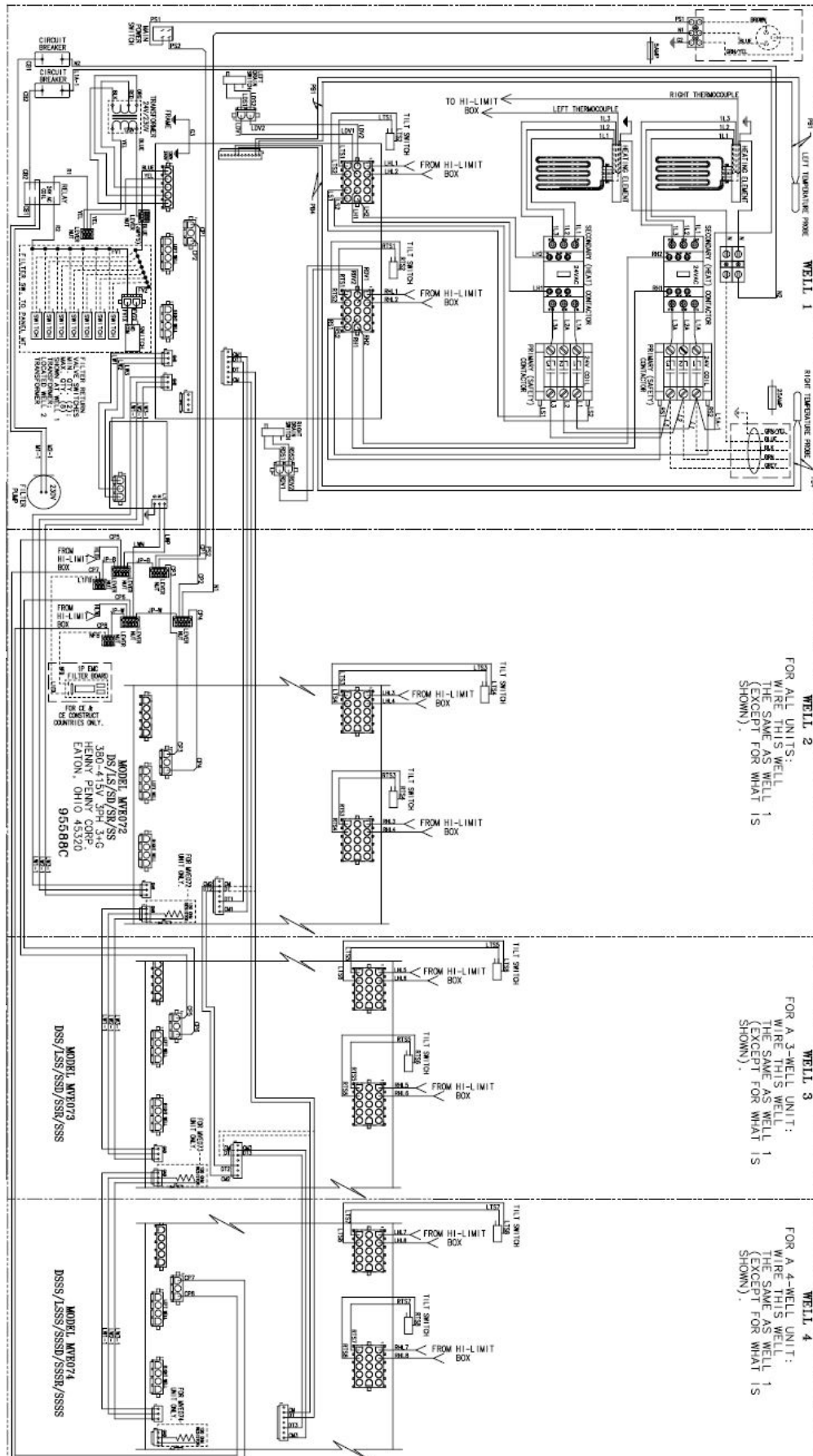

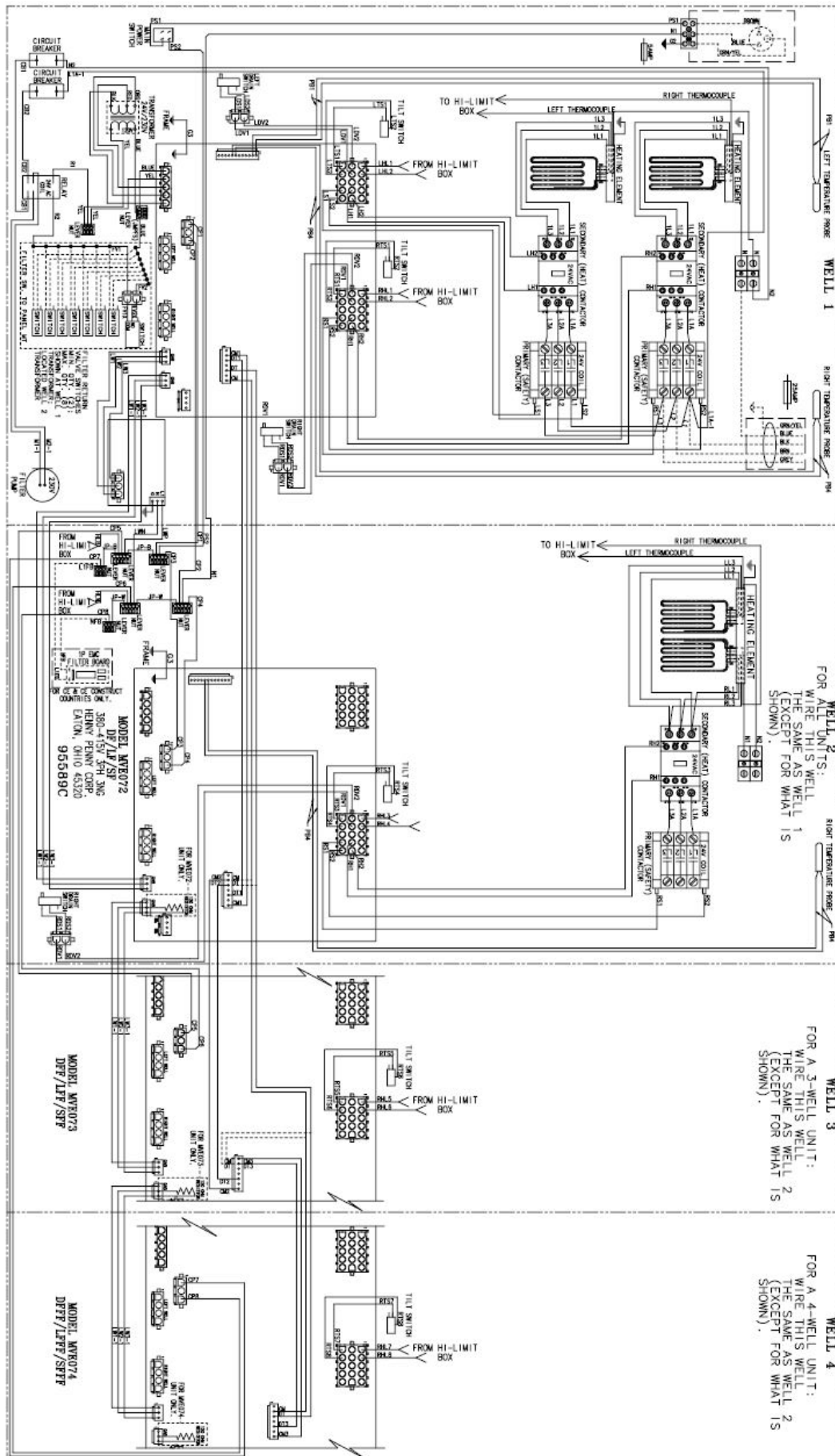

380-415/3 - SF / SFF / SFFF

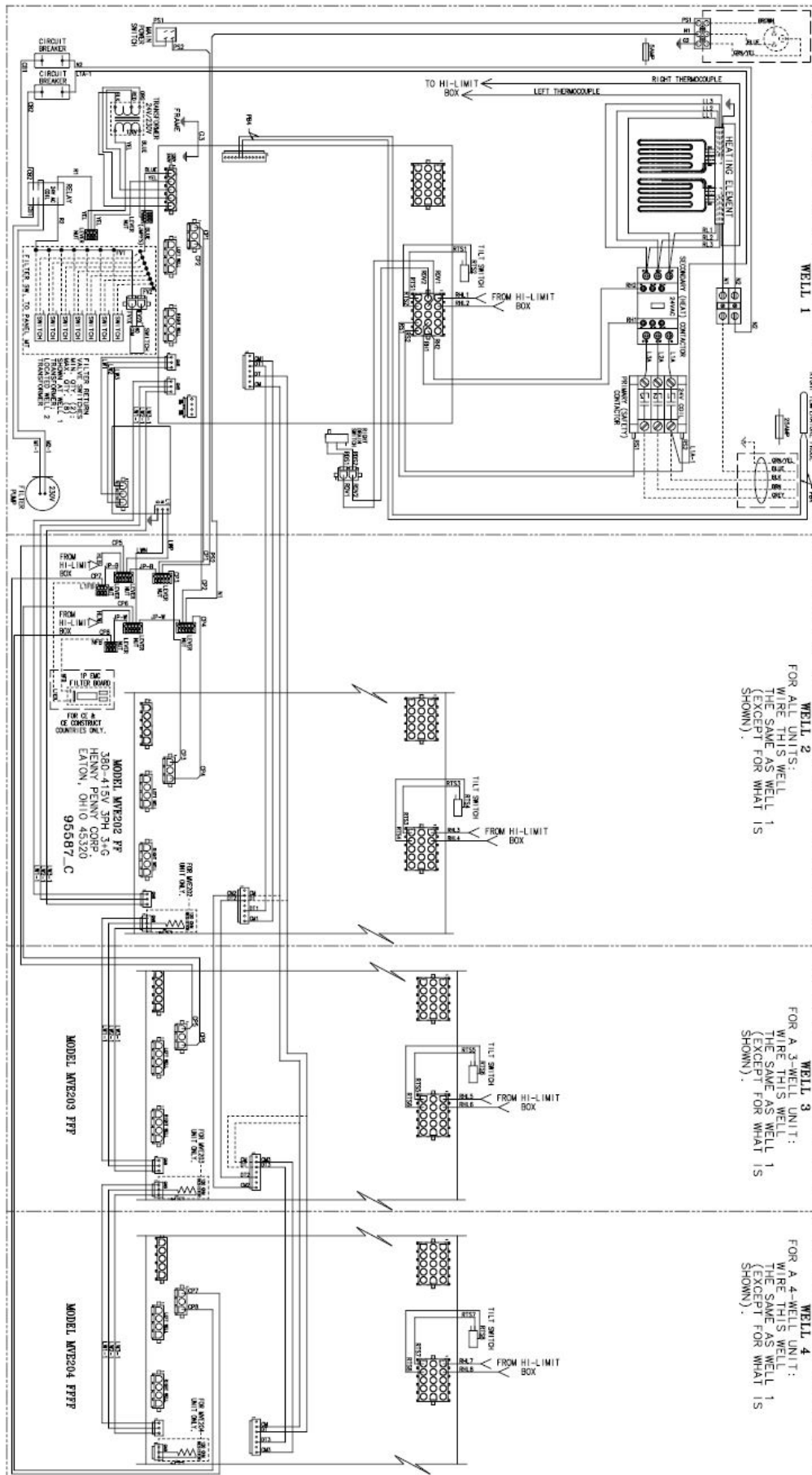

380-415/3 - FF / FFF / FFFF





**Henny Penny Corporation  
P.O.Box 60  
Eaton, OH 45320**

**1-937-456-8400  
1-937-456-8402 Fax**

**Toll free in USA  
1-800-417-8417  
1-800-417-8434 Fax**

**[www.hennypenny.com](http://www.hennypenny.com)**