



# TECHNICAL M A N U A L

## Evolution Elite™ Gas Open Fryer

### MODEL

**EEG-241**

**EEG-242**

**EEG-243**

**EEG-244**



**HENNY PENNY**  
Engineered to Last™

REGISTER WARRANTY ONLINE AT [WWW.HENNYPENNY.COM](http://WWW.HENNYPENNY.COM)



## TABLE OF CONTENTS

Section	Page
Section 1. TROUBLESHOOTING.....	3
1-1 Introduction .....	3
1-2 Safety .....	3
1-3 Troubleshooting.....	4
1-4 Error Code Table .....	7
Section 2. INFO & FILTER BUTTON STATS.....	10
2-1 INFO Button Stats .....	10
2-2 FILTER Button Stats .....	10
Section 3. INFORMATION MODE.....	11
3-1 Information Mode Details .....	11
Section 4. PRODUCT PROGRAM MODE.....	17
4-1 Modifying Product Settings.....	17
Section 5. LEVEL 2 PROGRAMMING .....	20
5-1 Special Program Mode .....	20
5-2 Clock Set .....	29
5-3 Data Logging, Heat Control, Tech, Stat & Filter Control Modes .....	29
5-4 Tech Mode .....	30
5-5 Stats Mode .....	36
5-6 Do Not Disturb .....	37
Section 6. MAINTENANCE SECTION.....	38
6-1 Introduction.....	38
6-2 Maintenance Hints .....	38
6-3 Preventive Maintenance.....	38
6-4 Control Panel and Menu Card Replacement.....	39
6-5 High Temperature Limit Control .....	40
6-6 Main Power switch.....	41
6-7 Probe Replacement .....	42

## TABLE OF CONTENTS

<b>Section</b>	<b>Page</b>
Section 6. MAINTENANCE SECTION (Continued)	
6-8 Solenoid Valves .....	45
6-9 Filter Pump & Motor .....	48
6-10 JIB Pump .....	50
6-11 Blower Replacement .....	51
6-12 Filter Beacon .....	52
6-13 Air Pressure Switches.....	53
6-14 Pilot Replacement .....	54
Section 7. PARTS SECTION	
7-1 Parts .....	63

## SECTION 1. TROUBLESHOOTING

### 1-1. INTRODUCTION

This section provides troubleshooting information in the form of an easy to read table.

If a problem occurs during the first operation of a new fryer, recheck the installation per the Installation Section of this manual.

Before troubleshooting, always recheck the operation procedures per Section 3 of this manual.

### 1-2. SAFETY

Where information is of particular importance or safety related, the words DANGER, WARNING, CAUTION, and NOTICE are used. Their usage is described below.



SAFETY ALERT SYMBOL is used with DANGER, WARNING, or CAUTION which indicates a personal injury type hazard.



NOTICE is used to highlight especially important information.



*CAUTION used without the safety alert symbol indicates a potentially hazardous situation which, if not avoided, may result in property damage.*



*CAUTION indicates a potentially hazardous situation which, if not avoided, may result in minor or moderate injury.*



**WARNING indicates a potentially hazardous situation which, if not avoided, could result in death or serious injury.**



**DANGER INDICATES AN IMMINENTLY HAZARDOUS SITUATION WHICH, IF NOT AVOIDED, WILL RESULT IN DEATH OR SERIOUS INJURY.**

### **1-3. TROUBLESHOOTING**

To isolate a malfunction, proceed as follows:

1. Clearly define the problem (or symptom) and when it occurs.
2. Locate the problem in the Troubleshooting table.
3. Review all possible causes. Then, one-at-a-time work through the list of corrections until the problem is solved.
4. Refer to the maintenance procedures in the Maintenance Section to safely and properly make the checkout and repair needed.



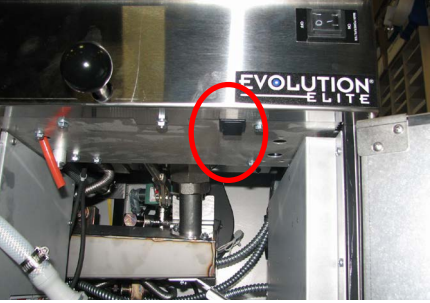

**If maintenance procedures are not followed correctly, injuries and/or property damage could result.**

**7-1. TROUBLE SHOOTING**  
**(Continued)**

<b>Problem</b>	<b>Cause</b>	<b>Correction</b>
POWER switch ON but fryer completely inoperative	<ul style="list-style-type: none"> <li>• Open circuit</li> </ul>	<ul style="list-style-type: none"> <li>• Plug fryer in</li> <li>• Check breaker or fuse at supply box</li> </ul>
"E-10"	<ul style="list-style-type: none"> <li>• High limit</li> </ul>	<p>Let unit cool down (15-20 minutes), push up on metal reset button under right side of the controls; if high limit does not reset, high limit must be replaced</p> 
Vat is under-filled	<ul style="list-style-type: none"> <li>• JIB is low or empty</li> <li>• JIB oil line is clogged or collapsed</li> <li>• Filter pan needs cleaned</li> </ul>	<ul style="list-style-type: none"> <li>• Fill the JIB</li> <li>• Check JIB line</li> <li>• Clean filter pan and change paper or pad</li> </ul>

**7-1. TROUBLE SHOOTING**  
**(Continued)**

<b>Problem</b>	<b>Cause</b>	<b>Correction</b>
Oil foaming or boiling over top of vat	<ul style="list-style-type: none"> <li>• Water in oil</li> <li>• Improper or bad oil</li> <li>• Improper filtering</li> <li>• Improper rinsing after cleaning the vat</li> </ul>	<ul style="list-style-type: none"> <li>• Drain and clean oil</li> <li>• Use recommended oil</li> <li>• Refer to filtering procedures</li> <li>• Clean and rinse vat and then dry thoroughly</li> </ul>
Oil will not drain from vat	<ul style="list-style-type: none"> <li>• Drain valve clogged with crumbs</li> <li>• Drain trough clogged</li> </ul>	<ul style="list-style-type: none"> <li>• Open valve, force cleaning brush through drain</li> <li>• Remove right side panel and remove plug from end of trough and clean trough</li> </ul>
Filter motor runs but pumps oil slowly	<ul style="list-style-type: none"> <li>• Filter line connections loose</li> <li>• Filter paper or pad clogged</li> <li>• Filter not reassembled correctly</li> </ul>	<ul style="list-style-type: none"> <li>• Tighten all filter line connections</li> <li>• Change filter paper or pad</li> <li>• Refer to assembly instructions on inside door</li> </ul>
Bubbles in oil during entire filtering process	<ul style="list-style-type: none"> <li>• Filter pan not completely engaged</li> <li>• Filter pan clogged</li> <li>• Damaged O-ring on filter line receiver on fryer</li> </ul>	<ul style="list-style-type: none"> <li>• Make sure filter pan return line is pushed completely into the receiver on the fryer</li> <li>• Clean pan and change paper or pad</li> <li>• Change O-ring</li> </ul>
Filter motor will not run	<ul style="list-style-type: none"> <li>• The thermal reset button on the rear of the pump motor is tripped</li> </ul> <div data-bbox="501 1125 873 1251" style="border: 1px solid black; padding: 5px; margin: 10px 0;">  </div> <p><b>To prevent burns caused by splashing shortening, turn the unit's POWER switch to the OFF position before resetting the filter pump motor's manual reset protection device.</b></p>	<ul style="list-style-type: none"> <li>• Allow time for the motor to cool and then, using a screwdriver, press hard against the button until it clicks</li> </ul> <div data-bbox="951 1150 1446 1520" style="text-align: center;">  </div>

**1-4. ERROR CODES**

In the event of a control system failure, the digital display shows an error message. The message codes are shown in the DISPLAY column below. A constant tone is heard when an error code is displayed, and to silence this tone, press any button.

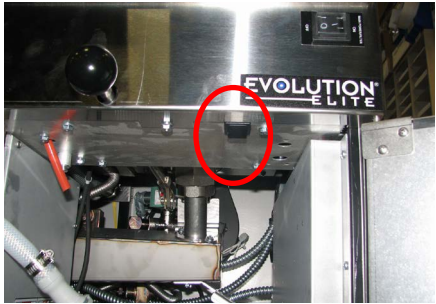
<b><u>DISPLAY</u></b>	<b><u>CAUSE</u></b>	<b><u>CORRECTION</u></b>
"E-4"	<ul style="list-style-type: none"> <li>Control board overheating</li> </ul>	Turn switch to OFF position, then turn switch back to ON; if display shows "E-4", the control board is getting too hot; check the louvers on each side of the unit for obstructions
"E-5"	<ul style="list-style-type: none"> <li>Oil overheating</li> </ul>	Turn switch to OFF position, then turn switch back to ON; if display shows "E-5", the heating circuits and temperature probe should be checked
"E-6A"	<ul style="list-style-type: none"> <li>Temperature probe open</li> </ul>	Turn switch to OFF position, then turn switch back to ON; if display shows "E-6A", the temperature probe should be checked
"E-6B"	<ul style="list-style-type: none"> <li>Temperature probe shorted</li> </ul>	Turn switch to OFF position, then turn switch back to ON; if display shows "E-6B", the temperature probe should be checked
"E-10"	<ul style="list-style-type: none"> <li>Hight limit</li> </ul>	<p>Let unit cool down (15-20 minutes), push up on metal reset button under right side of the controls; if high limit does not reset, high limit must be replaced</p> 
"E-15"	<ul style="list-style-type: none"> <li>Drain switch</li> </ul>	Make sure drain knob is completely pushed-in; if E-15 persists, have drain switch checked
"E-18-A" "E-18-B" "E-18-C"	<ul style="list-style-type: none"> <li>LH level sensor open</li> <li>RH level sensor open</li> <li>Both sensors open</li> </ul>	Turn switch to OFF position, then turn switch back to ON; if display still indicates a failed sensor, have the connectors checked at the control board; have sensor checked & replace if necessary

**1-4. ERROR CODES (Continued)**

<p>“E-20-A” “FAN SENSOR STUCK CLOSED”</p>	<ul style="list-style-type: none"> <li>• Pressure Switch failure</li> <li>• Wiring problem</li> <li>• I/O board failure</li> </ul>	<ul style="list-style-type: none"> <li>• If fan is not running, have pressure switch checked; should be open circuit if no air pressure</li> <li>• If fan is running, wiring error, or relay on I/O board closed</li> </ul>
<p>“E-20-B” “NO DRAFT” “CHECK FAN”</p>	<ul style="list-style-type: none"> <li>• Pressure switch failure/ hose loose</li> <li>• Draft fan failure/ low voltage</li> <li>• Flue or hood obstruction</li> </ul>	<ul style="list-style-type: none"> <li>• Press power button to vat off and back on again, if E-20-B persists, have pressure switch checked; should be open circuit if no air pressure; make sure hose is connected to fan and pressure switch</li> <li>• Have draft fan checked; low voltage going to fan</li> <li>• Check the fryer flue and hood system for obstructions</li> </ul>
<p>“E-20-D” “IGNITION” “FAILURE”</p>	<ul style="list-style-type: none"> <li>• Failure to ignite/ no flame sense</li> <li>• Plugged atmospheric equalization hole in regulator cap resulting in pilot flame slowly fading</li> </ul>	<ul style="list-style-type: none"> <li>• Press power button to vat off and back on again, if E-20-D persists, check gas line connections; check gas shutoff valve; check ignition module; check gas valve; check flame sensor gap; check gas valve, and check ignition module wiring</li> <li>• Clear obstruction from hole</li> </ul> 
<p>“E-21”</p>	<ul style="list-style-type: none"> <li>• Slow heat recovery</li> </ul>	<ul style="list-style-type: none"> <li>• Have a certified service technician check the fryer for correct voltage to the unit; have heat circuit checked; have unit checked for loose or burnt wire</li> </ul>
<p>“E-22” “NO HEAT” “CHECK GAS VALVE”</p>	<ul style="list-style-type: none"> <li>• Burner not igniting</li> </ul>	<ul style="list-style-type: none"> <li>• Have gas valve and heat circuit checked</li> </ul>
<p>“E-41 “ / “E-46”</p>	<ul style="list-style-type: none"> <li>• Programming failure</li> </ul>	<ul style="list-style-type: none"> <li>• Press power button to vat off and back on again, if any of the error codes, have the controls re-initialized; if error code persists, have the control board replaced</li> </ul>
<p>“E-47”</p>	<ul style="list-style-type: none"> <li>• Analog converter chip or 12 volt supply failure</li> </ul>	<ul style="list-style-type: none"> <li>• Press power button to vat off and back on again, if “E-47” persists, have the I/O board, or the PC board replaced; if speaker tones are quiet, probably I/O board failure; have the I/O board replaced</li> </ul>
<p>“E-48”</p>	<ul style="list-style-type: none"> <li>• Input system error</li> </ul>	<ul style="list-style-type: none"> <li>• Have PC board replaced</li> </ul>
<p>“E-54-C”</p>	<ul style="list-style-type: none"> <li>• Temperature input error</li> </ul>	<ul style="list-style-type: none"> <li>• Turn switch to OFF, then back to ON; have control PC board replaced if “E-54C” persists</li> </ul>

**1-4. ERROR CODES (Continued)**

<p>“E-60” “FILTER IN USE”</p>	<ul style="list-style-type: none"> <li>AIF PC board not communicating with control PC board</li> </ul>	<ul style="list-style-type: none"> <li>Press power button to turn vat off, wait 15 seconds, and turn back on again. If “E-60” persists, have connector between the PC boards checked; replace AIF PC board or control PC board, if necessary</li> </ul>
<p>“E-70C”</p>	<ul style="list-style-type: none"> <li>Drain valve jumper wire missing or disconnected</li> </ul>	<ul style="list-style-type: none"> <li>Have the jumper wire checked on the PC board at drain switch interlock position</li> </ul>
<p>“E-83-A”</p>	<ul style="list-style-type: none"> <li>Pressure too high</li> </ul>	<ul style="list-style-type: none"> <li>Check filter system in Vat #1</li> </ul>
<p>“E-83-B”</p>	<ul style="list-style-type: none"> <li>Pressure too high</li> </ul>	<ul style="list-style-type: none"> <li>Check filter system in Vat #2</li> </ul>
<p>“E-83-C”</p>	<ul style="list-style-type: none"> <li>Pressure too high</li> </ul>	<ul style="list-style-type: none"> <li>Check filter system in Vat #3</li> </ul>
<p>“E-83-D”</p>	<ul style="list-style-type: none"> <li>Pressure too high</li> </ul>	<ul style="list-style-type: none"> <li>Check filter system in Vat #4</li> </ul>
<p>“E-83-E”</p>	<ul style="list-style-type: none"> <li>Pressure too high</li> </ul>	<ul style="list-style-type: none"> <li>Check filter system in Vat #5</li> </ul>
<p>“E-83-J”</p>	<ul style="list-style-type: none"> <li>Bulk JIB FILL switch ON when pressure too high</li> </ul>	<ul style="list-style-type: none"> <li>Check JIB fill valves</li> </ul>
<p>“E-83-R”</p>	<ul style="list-style-type: none"> <li>Bulk Dispose switch ON when pressure too high</li> </ul>	<ul style="list-style-type: none"> <li>Check Bulk Dispose quick-disconnect behind fryer</li> </ul>
<p>“E-93-1” “24 VDC SUPPLY TRIPPED”</p>	<ul style="list-style-type: none"> <li>Autolift motor malfunction or failure</li> </ul>	<ul style="list-style-type: none"> <li>If AutoLift feature is not operating, have each of the AutoLift motors checked.</li> </ul>

## SECTION 2. INFO & FILTER BUTTON STATS

### 2-1. INFO BUTTON STATS

#### Actual Oil Temperature

1. Press  and the actual oil temperature shows in the display, for each vat.

#### Set-point Temperature

1. Press  twice and SP shows in the display, along with the set-point (preset) temperature of each vat.

#### Recovery Information for each Vat

1. Press  3 times and REC shows in the left display and the recovery time that oil temperature went from 250°F (121°C) to 300°F (149°C) shows in the right display. For example, 

REC	5:30
-----	------

 means it took 5 minutes and

30 seconds for the oil temperature to recover to 300°F (149°C) from 250°F (121°C).

### NOTICE

If no buttons are pressed within 5 seconds in any of stats modes, the controls revert back to normal operation.

### 2-2. FILTER BUTTON STATS

#### Cook Cycles Remaining before Filtering

1. Press and release either  button and the left display shows “COOKSREMAINING” and the right display shows the number of cook cycles before the next auto filter. For example, 

REMA	INING	3	6
------	-------	---	---

means after 3 more cook cycles on the left vat, the controls asks the operator if they are ready to filter or not. But, 6 more cook cycles remain on the right vat.

#### Time and Date

2. Press either  twice and ‘FILTERED’ shows in the displays, along with the time-of-day and date of the last filter.

#### Filter Pad Hours

3. Press either  three times and ‘FLTR PAD XX HRS’ shows in the displays.

## SECTION 3. INFORMATION MODE

This historic information can be recorded and used for operational and technical help and allows you to view the following:



- |                   |                          |
|-------------------|--------------------------|
| • 1. E-LOG        | • 9. CPU TEMP            |
| • 2. LAST LOAD    | • 10. COMMUNICATION INFO |
| • 3. DAILY STATS  | • 11. ANALOG INFO        |
| • 4. OIL STATS    | • 12. ACTIVITY LOG       |
| • 5. REVIEW USAGE | • 13. OIL LEVELS         |
| • 6. INPUTS       | • 14. PUMP VALVE INFO    |
| • 7. OUTPUTS      | • 15. AIF INFO           |
| • 8. OIL TEMP     |                          |

### NOTICE

Not all Information Mode functions are discussed in this section. To ensure proper operation of fryer, please consult Henny Penny Corp. before changing any of these settings. For more information on these functions, contact Technical Support at 1-800-417- 8405, or 1-937-456-8405.

### 3-1. INFORMATION MODE DETAILS

#### 1. E-LOG (error code log)

Press  and  buttons at the same time and “\*INFO MODE\*” shows in the display, followed by “1. E-LOG”.

### NOTICE

Press  and  to exit Information Mode at any time.

Press  and “A. (date & time) \*NOW\* show in displays. This is the present date and time.

Press  and if a error was recorded, “B. (date, time, and error code information)” shows in display. This is the latest error code that the controls recorded.



Press  and the next latest error code information can be seen.

Up to 10 error codes (B to K) can be stored in the E-LOG section.

**3-1. INFORMATION MODE**  
**DETAILS (Continued)**

**2. LAST LOAD** (Information on recent cook cycles)

Press ► and “2. LAST LOAD” show in displays.

Press a timer button  or  for the product you want to view the cook data and the LED flashes.

Press ▼ button to start viewing the cook data.

For example, if the left  LED is flashing, “PRODUCT FRY L1” show in displays.

If the right  LED is flashing, “PRODUCT FRY R2” show in displays.

Press ▼ button to start viewing the cook data.

FUNCTION	DISPLAY EX:
Product (Last product cooked)	PRODUCT FRY L1
Time of day the last Cook Cycle was started	STARTED FEB 4
2:25P	
Actual Elapsed cook Time (Real seconds)	ACTUAL TIME 1:06
Programmed cook Time	PROG TIME 1:00
Max Temp during Cook Cycle	MAX TEMP 350°F
Min Temp during Cook Cycle	MIN TEMP 313°F
Avg Temp during Cook Cycle	AVG TEMP 322°F
Heat On (percentage) during Cook Cycle	HEAT ON 45%
Ready? (Was fryer Ready before start?)	READY? YES
When Cook Cycle was stopped: Early	QUIT AT 0:10 REM
After complete Cook Cycle	OR
	*DONE* +6 SEC
Difference (%) between actual and programmed cook time	ACT/PROG 1%

**3-1. INFORMATION MODE**  
**DETAILS (Continued)**

**3. DAILY STATS** (Operational info of fryer for last 7 days)

Press ► and “3. DAILY STATS” show in displays.

Press ▼ button to start viewing the cook data.

Press the right  to view data for other days of week.

<b>FUNCTION</b>	<b>DISPLAY EX:</b>
Day this data was recorded for	APR-30 TUE*
Number of Hours:Minutes the fryer was on	(L/R) ON HRS TUE* 3:45
Number of times filtered	(L/R) FILTERED TUE* 4
Number of times filter skipped	(L/R) SKIPPED TUE* 4
Number of times oil added	(L/R) ADD OIL TUE* 4
Number of times oil discarded	(L/R) DISPOSE TUE* 0
Oil temperature recovery time	(L/R) RECOVERY TUE*1:45
Total number of cook cycles that day	(L/R) TOT CK TUE* 38
Number of cycles stopped before *DONE*	QUIT CK TUE* 2
Cook Cycles for Product #1	TUE* COOK -1- 17
Cook Cycles for Product #2	TUE* COOK -2- 9
Cook Cycles for Product #3	TUE* COOK -3- 5
Cook Cycles for Product #4	TUE* COOK -4- 0
Cook Cycles for Product #5	TUE* COOK -5- 0
Cook Cycles for Product #6	TUE* COOK -6- 6
Cook Cycles for Product #7	TUE* COOK -7- 0
Cook Cycles for Product #8	TUE* COOK -8- 0
Cook Cycles for Product #9	TUE* COOK -9- 1
Cook Cycles for Product #0	TUE* COOK -0- 0

**3-1. INFORMATION MODE**  
**DETAILS (Continued)**

**4. OIL STATS**

(info of current oil and avg. of last 4 batches of oil)  
Press ► and “4. OIL STATS” show in displays.

Press ▼ button to start viewing the cook data.

**FUNCTION**

**DISPLAY EX:**

Start date of new oil	NEW OIL	MAR-23
Number of days oil in use	(L/R) OIL USE	4 DAYS
Number of filters on this oil	(L/R) FILTERED	4
Number of times filter skipped	(L/R) SKIPPED	0
Number of cook cycles on this oil	(L/R) TOT CK	38
Average number of days per oil change	(L/R) AVG DAYS PER OIL CHANGE	13.8 DAYS
Average number cook cycles per oil change	(L/R) AVG CKS PER OIL CHANGE	388 CKS

Press and hold a product button (1 to 4) to view the data from one of the previous 4 batches of oil used.

Press  to view oldest oil data: Ex: OIL-4 14 DAYS

Press  to view 3rd oldest oil data: Ex: OIL-3 12 DAYS

Press  to view 2nd oldest oil data: Ex: OIL-2 15 DAYS

Press  to view previous batch of oil: Ex: OIL-1 13 DAYS

**NOTICE**

To obtain the most accurate oil information, use the “3.DISPOSE” step in the Filter Menu (press and hold  ) to drain the oil from the vat.

**3-1. INFORMATION MODE**  
**DETAILS (Continued)**

**5. REVIEW USAGE**

(accumulated info since the data was reset)

Press ► and “5. REVIEW USAGE” show in displays.

Press ▼ button to start viewing the cook data.

**FUNCTION**

**DISPLAY EX:**

Day the usage data was previously reset	SINCE	APR-19 3:00P
Number of Hours the fryer was on	(L/R) ON HRS	4
Number of times filtered	(L/R) FILTERED	4
Number of times filter skipped	(L/R) SKIPPED	0
Number of times oil added	(L/R) ADD OIL	4
Number of times oil discarded	(L/R) DISPOSE	1
Total number of cook cycles	(L/R) TOT CK	38
Number of cycles stopped before *DONE*	QUIT CK	2
Cook Cycles for Product #1	COOK -1-	17
Cook Cycles for Product #2	COOK -2-	9
Cook Cycles for Product #3	COOK -3-	5
Cook Cycles for Product #4	COOK -4-	0
Cook Cycles for Product #5	COOK -5-	0
Cook Cycles for Product #6	COOK -6-	6
Cook Cycles for Product #7	COOK -7-	0
Cook Cycles for Product #8	COOK -8-	0
Cook Cycles for Product #9	COOK -9-	1
Cook Cycles for Product #0	COOK -0-	0
<b>Reset usage data:</b> Enter the Usage Code - 1, 2, 3 on this step to zero out all the usage information	RESET USAGE / ENTER CODE	-----

### **3-1. INFORMATION MODE** **DETAILS (Continued)**

#### **6. INPUTS**

Press ► and “6. INPTS” and “HDF” show in displays.

H = HIGH LIMIT - If “H” is present, the high limit is good. If “-” shows then the high limit is tripped out (overheated) or disconnected.

D = DRAIN SWITCH - If “D” is present, the drain handle (when applicable) is closed. If “-” shows then the drain is open or the switch is faulty.

F = FAN (PRESSURE SWITCH) - If “F” is present, the pressure switch is good. If “-” shows in the display, the switch is faulty.

Press ▼ button and an underscore (“\_”) indicates the input is not presently detected. A Checkmark (“√”) indicates the signal is detecting a normal input. A blinking (“X”) indicates the signal is presently detected, but is detected as a half-wave (partially failed) input.



### **NOTICE**



The H, D, F signals above are wired in series. The first signal missing out of this sequence generally causes all signals to the right of it to be missing as well.



#### **7. OUTPUTS**

Press ► and “7. OUTP” and “F-S-I-H-” show in displays.

F = FAN (PRESSURE SWITCH)- Press  or  to open and close the pressure switches

S = SAFETY GAS VALVE (if available) - Press  or to  open and close the gas safety valves

I = IGNITION MODULE - Press  or  to open and close the outputs on the ignition modules

H = HEAT OUTPUTS - Press  or  to turn on and off the heating outputs (ex: gas valve)

#### **8. OIL TEMPERATURE**

Press ► and “8.OIL TMP” shows in the left display and the oil temperature shows in the right display.

#### **9. CPU TEMPERATURE**

Press ► and “9.CPU TMP” shows in the left display and the current PC board temperature shows in the right display.

## SECTION 4. PRODUCT PROGRAM MODE

This mode allows you to program the following:

- |                       |                                    |
|-----------------------|------------------------------------|
| • Change Product Name | • Include in Filter Count (Global) |
| • Assign Button       | • Filter at X no. of loads (Mixed) |
| • Change Times & Temp | • Load Compensation                |
| • Change Cook ID      | • Load Compensation Reference      |
| • Alarms              | • Full Heat                        |
| • Quality Timers      | • PC Factor                        |

### 4-1. MODIFYING PRODUCT SETTINGS

1. Press and hold  button until “PROG” shows in the display, followed by “ENTER CODE”.

2. Enter code 1, 2, 3 (first 3 product buttons). “PRODUCT” and “PROGRAM” show in the displays, followed by “SELECT PRODUCT” and “-P 1-” (ex: NUG).

#### **Change Product Names**

3. Use the ▲ and ▼ buttons to scroll through the 40 products, or press the desired product button.

4. Press ► button and “NAME” shows in the left display and the product (ex: NUGGETS) shows in the right display.

5. Press √ button and the first letter in the name flashes. Press a product button and the flashing letter changes to the first letter under the product button that was pressed. For example, if  is pressed, the flashing letter changes to an “A”.

Press the same button again and the flashing letter changes to a “B”. Press it again and the flashing letter changes to a “C”. Once the desired letter shows in the display, press ► button to continue to the next letter and repeat the procedure.

Press and hold the right X button to exit Program Mode, or press ► button to continue on to “COOK TIME”.

#### **Assign Button**

6. Press ► button until “ASSIGN BTN” shows in the display, along with the product (ex: NUGGETS). If this product already has a product button assigned to it, that LED will be lit. To assign other product buttons to that product, press and hold the product button for 3 seconds and that LED stays lit. To remove a product from a button, press and hold the product button with a lit LED and the LED goes out.

## **4-1. MODIFYING PRODUCT SETTINGS (Continued)**

### **To Change Times and Temperatures**

7. Press ► button until “COOK TIME” shows in the display, and then use the product buttons, or the ▲ and ▼ buttons, to change the time in minutes and seconds, to a maximum of 59:59.
8. Press ► button and “TEMP” shows in the display, along with the preset temperature on the right side of the display.

Press the product buttons, or the ▲ and ▼ buttons, to change the temperature. The temperature range is 190°F (88°C) to 375°F (191°C).

### **Cook ID Change**

9. Press ► button until “COOK ID” shows in the display along with the product ID. For example, NUG would be the ID for nuggets. Use the product buttons, or the ▲ and ▼ buttons, to change the ID.

### **Alarms (1 & 2)**

10. Press ► button until “ALRM 1” shows in the left display, and an alarm time in the right display. Press the product buttons, or the ▲ and ▼ buttons, to set an alarm.

Ex., If a Cook Cycle was set at 3 minutes, and an alarm was to go off after 30 seconds into the Cook Cycle, “2:30” would be set in the display at this time. When the timer counts down to 2:30 the alarm sounds.

After the alarm time is set, press ► button and “ALRM 2” shows in the display, and a second alarm can be programmed.

### **Quality Timer (hold time)**

11. Press ► button until “QUAL TMR” shows in the display along with the preset holding time. Press the product buttons, or the ▲ and ▼ buttons, to adjust holding time, up to 59:59.

### **Global Filter Tracking**

#### **Include in Filter Count**

12. Press ► button until “INCL IN FLTR CNT” flashes in the display along with “YES” or “NO”. Using ▲ and ▼ buttons, change the display to “YES” if that product’s Cook Cycles are to be counted as part of the recommended filter process. Set to “NO” if it is not to be included. Mixed Filter Tracking

## 4-1. MODIFYING PRODUCT SETTINGS (Continued)

### **Filter After X Number of Loads**

13. Press ► button until “FILTER AFTER...” flashes in the left display along, and the number of cook cycles between filters shows in the right display. Press the product buttons, or the ▲ and ▼ buttons, to change this value of 0 to 99 loads. This needs set for each product.

### **>Load Compensation, Load Compensation Reference, Full Heat, PC Factor<**

14. Press ► button until “LD COMP” shows in the display, along with the load compensation value. This automatically adjusts the time to account for the size and temperature of the cooking load.

Press the product buttons, or the ▲ and ▼ buttons, to change this value of 0 to 20.

15. Press ► button until “LCMP REF” shows in the display along with the load compensation average temperature. (if load compensation is set to “OFF”, then “\_ \_ \_” shows in display and setting cannot be programmed) This is the average cooking temperature for each product. The timer speeds up at temperatures above this setting and slows down at temperatures below this setting. Press the product button, or the ▲ and ▼ buttons, to change this value.

16. Press ► button until “FULL HT” shows in the display along with the full heat value in seconds, which means the heat is on as soon as a timer button is pressed, for the programmed length of time. Press the product buttons, or the ▲ and ▼ buttons, to change this value of 0 to 90 seconds.

17. Press ► button until “PC FACTR” shows in the display along with the proportional temperature, which helps to keep the oil from over-shooting the setpoint temperature. Press the product buttons, or the ▲ and ▼ buttons, to change this value of 0 to 50 degrees.

## **NOTICE**

- Use ◀ button to go back to previous menu items.
- Press ► button when finished with the current product, to return to the “SELECT PRODUCT” step.
- Press and hold **P** button to exit PRODUCT PROGRAM Mode.

## SECTION 5. LEVEL 2 PROGRAMMING

Used to access the following:

- Special Program Mode
- Clock Set
- Data Communication
- Heat Control

### 5-1. SPECIAL PROGRAM MODE

The Special Program Mode is used to set more detailed

programming, such as:

- **SP-1** • Degrees Fahrenheit or Celsius
- **SP-2** • Language: English, Russian, Swedish (SVENSKT), German (DEUTSCHE), Portuguese, Spanish (ESPAÑOL) and French (FRANCAIS)
- **SP-3** • System Initialization (Factory Presets)
- **SP-4** • Audio Volume
- **SP-5** • Audio Tone
- **SP-6** • Melt Cycle Select - 1.LIQUID; 2.SOLID
- **SP-7** • Idle Mode Enabled - YES or NO
- **SP-7A** • Use “0” for IDLE
- **SP-7B** • Auto Idle Minutes
- **SP-7C** • Idle Set-point Temperature
- **SP-8** • Filter Tracking Mode - 1.MIXED or 2.GLOBAL
- **SP-8A** • Suggest Filter At... - 75% to 100% (MIXED)
- **SP-8B** • Filter Lockout Enabled? - YES or NO (MIXED)
- **SP-8A** • Left Vat Filter Cycles - 0 to 99 (GLOBAL)
- **SP-8B** • Right Vat Filter Cycles - 0 to 99 (GLOBAL)
- **SP-8C** • Filter Lockout Enabled? - YES or NO (GLOBAL)
- **SP-9** • Polish Duration - X:XX M:SS
- **SP-10** • Change Pad Reminder Time - XX HRS
- **SP-11** • Clean-Out Time - XX MIN
- **SP-12** • Clean-Out Temperature - XXX °F or °C
- **SP-13** • Cooking User IO - After Cook Cycle, display shows previous menu item or “----”
- **SP-14** • Number of Baskets - 2-BASKETS or 4 BASKETS
- **SP-15** • Show Cooking Indicator - YES or NO
- **SP-16** • 2nd Language: English, Russian, Swedish (SVENSKT), German (DEUTSCHE), Portuguese, Spanish (ESPAÑOL) and French (FRANCAIS)
- **SP-17** • 2nd Audio Volume
- **SP-18** • Energy Save Enabled? - YES or NO
- **SP-19** • Fryer Type - GAS or ELECTRIC
- **SP-20** • Vat Type - SPLIT or FULL
- **SP-21** • Autolift Enabled? - NO LIFT or YES LIFT
- **SP-22** • Bulk Oil Supply? - YES or NO
- **SP-23** • Bulk Oil Dispose? - NO / FRONT / REAR
- **SP-24** • Serial No. of Fryer
- **SP-25** • Change Mgr. Code- 1 = YES
- **SP-26** • Change Usage Code - 1 = YES
- **SP-27** • Dispose Requires Code ? - YES or NO
- **SP-28** • Longer Fill Time Enabled - YES or NO
- **SP-29** • Let User Exit Fill? - YES or NO
- **SP-30** • Skip Skim Prompt? YES or NO
- **SP-31** • Skip Exp Fltr Confirm Prompt? YES or NO
- **SP-32** • 2-Stage Wash Enabled? YES or NO
- **SP-33** • Daily Filter Lockout Enabled? YES or NO
- **SP-34** • Daily Filter Period Start Time (ie: 5:00)
- **SP-35** • Daily Filter Reminder Time (ie: 21:00)

**5-1. SPECIAL PROGRAM  
MODE (Continued)**

Press and hold the **P** button for 5 seconds until “LEVEL 2” followed by, “SP PROG” and “ENTER CODE” show in the display.

Enter code 1,2,3, and “SP-1”, “TEMP”, “FORMAT” show in the displays.

**NOTICE**

If a bad code is entered, a tone sounds and “BAD CODE” shows on the display. Wait a few seconds, the controls revert back to the cook mode, and repeat the above steps.

To exit from the Special Program Mode at any time, press and hold **P** button for 2 seconds.

**Degrees Fahrenheit or Celsius (SP-1)**

The left display flashes “SP-1” and “TEMP”, “FORMAT”. Press the ▲ or ▼ buttons to choose °F or °C.

**NOTICE**

- Use ◀ button to go back to previous menu items
- Press ▶ button when finished with the current Level 2 step

**Language (SP-2)**

Press ▶ button and “SP-2” and “LANGUAGE” flash on the left display. Press the ▲ or ▼ buttons to select the desired language.

**System Initialization (SP-3)**

Press ▶ button and “SP-3” and “DO SYSTEM INIT” flash in the display, along with “INIT” on the right display. To reset the controls to factory default settings, press and hold √ button and control counts down “IN 3”, “IN2”, “IN 1”. Once display shows “-INIT-” & \*DONE\* the controls are reset to factory defaults.

**Audio Volume (SP-4)**

Press ▶ button and “SP-4” and “VOLUME” flash in the left display. Press the ▲ or ▲ or use product buttons, to adjust the volume of the speaker, 10 being the maximum value and 1 the minimum.

## **5-1. SPECIAL PROGRAM**

### **MODE (Continued)**

#### **Audio Tone (SP-5)**

Press ► button and “SP-5” and “TONE” flash in the left display. Press the ▲ or ▼ or use product buttons, to adjust the tone of the speaker, 2000 being the maximum value and 50 the minimum.

#### **Liquid or Solid Cooking Oil Used (SP-6)**

Press ► button until “SP-6 MELT CYCLE SELECT” scrolls in the left display. Unless solid oil is being used in the vats the right display should show “1.LIQUID”.

If solid oil is used, the unit MUST BE equipped to handle solid oil. Use the ▲ and ▼ buttons to change the right display to “2.SOLID”

#### **Idle Mode Enabled (SP-7)**

An Idle Mode allows the oil temperature to drop to a lower temperature when not in use. This saves on oil and utilities.

Press ► button and “SP-7” and “IDLE MODE ENABLED?” flash in the left display. Press the ▲ or ▼ buttons to choose “YES” or “NO”.

With “YES” in the display, press ► button and “SP-7A” and “USE ‘0’ FOR IDLE” flash on the left display. Press the ▲ or ▼ buttons to select “YES” or “NO”. If “YES” is selected, an Idle Mode can be programmed in product button .

Press ► button and “SP-7B” and “AUTOIDLE MINUTES” flash in the left display. Press the ▲ or ▼, or use product buttons, to set the time (0 to 60 minutes) fryer stays idle before the auto-idle is enabled.

Ex., “30” means, if product is not cooked in that vat for 30 minutes, the control automatically cools the oil down to the idle setpoint temperature

Press ► button and “SP-7C” and “IDLE SETPT” flash in the left display. Press the ▲ or ▼, or use product buttons, to set the idle temperature 200° to 375 °F (93 to 191 °C).

**5-1. SPECIAL PROGRAM**  
**MODE (Continued)**

**Filter Tracking Mode (SP-8)**

Filter Tracking signals the operator when the oil needs filtering by counting the number Cook Cycles between filters  
Press ► button and “SP-8” and “FILTER TRACKING MODE” show in the display. Use the ▲ and ▼ buttons to choose either “1.MIXED” filter tracking or “2.GLOBAL”.

**NOTICE**

GLOBAL means all the products have the same number of cook cycles between filters.

<b>Product</b>	<b>No. Cook Cycles</b>	<b>Cycle Count</b>
Fish	2	1/2
French Fries	8	1/8
Chicken	4	1/4

MIXED means each product may be set with different number of cook cycles between filters. The controls adds the cycle counts (see example at left) and when the counts equal 1 or greater, filtering is suggested. Ex: 1 load of fish, 2 loads of french fries, a load of chicken equals 1.  $1/2 + 1/8 + 1/8 + 1/4 = 1$ .

**MIXED**

If MIXED is selected, press ► button and “SP-8A” and “SUGGEST FILTER AT ...” shows in the left display, and a value between 75% and 100% shows on the right display. Press the ▲ and ▼ buttons to change this value.

The lower the value, the sooner the control recommends to filter. Ex: If set to 75%, the control suggest filtering after 3/4 of the programmed cook cycles is met, whereas at 100%, all the cook cycles must be completed before the control suggest filtering.

Press ► and “SP-8B” and “LOCKOUT ENABLED?” shows in the left display. Press the ▲ and ▼ buttons to choose YES or NO.

If set to YES, when the controls suggest filtering, “FILTER LOCKOUT?”/”YOU \*MUST\* FILTER NOW”, shows in the display, and it refuses further cook cycles until the vat is filtered.

Press ► and “SP-8C” and “LOCKOUT AT...” shows in the left display and a value between 100% and 250% shows on the right display. Press the ▲ and ▼ buttons to change this value. The lower the value, the sooner the “lockout” occurs.

Ex: If set at 100%, “lockout” occurs when the cycle counts reaches 1 or greater. Set at 200%, twice as many cycles are counted before “lockout” occurs. See example above.

**5-1. SPECIAL PROGRAM**  
**MODE (Continued)**

**Filter Tracking Mode (SP-8) (Continued)**

**GLOBAL**

If GLOBAL is selected, press ► button.

**Split Vat**

If unit is a split vat, “SP-8A” and “LEFT VAT FILTER CYCLES” shows in the left display, and the number of cook cycles between filters shows on the right display (0 to 99). Use ▲ and ▼ or product buttons to change this number.

Press ► button and “SP-8B” and “RIGHT VAT FILTER CYCLES” shows in the left display, and the number of cook cycles between filters shows on the right display (0 to 99).

Press ► button and “SP-8C” and “LOCKOUT ENABLED?” shows in the left display. Press the ▲ and ▼ buttons to choose YES or NO.

If set to YES, press ► button and the left display shows “SP-8D” and “LEFT VAT LOCKOUT CYCLES” and the number of cook cycles before filter lock-out shows on the right display (0 to 99). Use ▲ and ▼ or product buttons to change this number.

Press ► button and the left display shows “SP-8E” and “RIGHT VAT LOCKOUT CYCLES” and the number of cook cycles before filter lock-out shows on the right display (0 to 99). Use ▲ and ▼ or product numbers to change this number.

Once this number of cook cycles is reached, “FILTER LOCK-OUT”/“YOU \*MUST\* FILTER NOW”, shows in the display, and it refuses further cook cycles until the vat is filtered.

**Full Vat**

If unit is a full vat, “SP-8A” and “FULL VAT FILTER CYCLES” shows in the left display, and the number of cook cycles between filters shows on the right display (0 to 99). Use ▲ and ▼ or product numbers to change this number.

Press ► button and “SP-8B” and “LOCKOUT ENABLED?” shows in the left display. Press the ▲ and ▼ buttons to choose YES or NO.

If set to YES, press ► button and the left display shows “SP-8C” and “FULL VAT LOCKOUT CYCLES” and the number of cook cycles before filter lock-out shows on the right display (0 to 99). Use and or product buttons to change this number.

Once this number of cook cycles is reached, “FILTER LOCK-OUT”/“YOU \*MUST\* FILTER NOW”, shows in the display, and it refuses further cook cycles until the vat is filtered.

**5-1. SPECIAL PROGRAM**  
**MODE (Continued)**

**Polish Duration (SP-9)**

Press ► button and “SP-9” and “POLISH TIME” flash in the left display. Press the ▲ or ▼ , or use product buttons, to change the polish time, from 0 to 10 minutes.

**Change Filter Pad Reminder Time (SP-10)**

Press ► button and “SP-10 “CHANGE PAD’ REMINDER” flash in the left display. Press the ▲ or ▼ , or use product buttons, to change the time, from 0 hours to a maximum of 100 hours.

**Clean-Out Time (SP-11)**

Press ► button and “SP-11 CLEAN-OUT TIME” flashes in the left display. Press the ▲ or ▼ or use product buttons, to change the time from 0 to 99 minutes.

**Clean-Out Temperature (SP-12)**

Press ► button and “SP-12 CLEAN-OUT TEMP” flashes in the left display. Press the ▲ or ▼ or use product buttons, to change the temperature from 0 to 195° F (90° C).

**Cooking User IO (SP-13)**

Press ► button and “SP-11” and “COOKING USER IO” flash in the display. Press the ▲ or ▼ buttons to choose “SHOW-PREV” or “SHOW----”.

Setting SP-11 to SHOWPREV means after a cook cycle the display shows the last menu item cooked. SHOW---- means after a cook cycle “----” shows in the display and a menu item needs selected before starting the next cook cycle.

**Number of Baskets (SP-14)**

Press ► button and “SP-14 NUMBER OF BASKETS” flashes in the left display. Press the ▲ or ▼ buttons to choose 2 or 4 baskets per well.

**Cooking Indicator (SP-15)**

Press ► button and “SP-15 SHOW COOKING INDICATOR” flashes in the left display. Press the ▲ or ▼ buttons to choose YES, and during a cook cycle, “\*” shows which timer is counting-down. Choose NO and “\*” will not show during a cook cycle.

**5-1. SPECIAL PROGRAM**  
**MODE (Continued)**

**2nd Language (SP-16)**

Press ► button and “SP-16 2ND LANGUAGE” flashes on the left display. Press the ▲ or ▼ buttons to select the desired 2nd language.

By setting a 2nd language in the controls, 2 languages can now be chosen by pressing  button during normal operation.

One language shows in the left display and the second language shows in the right display. Pressing the √ button selects the language in the displays.

**2nd Volume (SP-17)**

Press ► button and “SP-17 2ND VOLUME” flashes on the left display. Press the ▲ or ▼ buttons, or the product buttons to select the desired 2nd volume.

By setting a 2nd volume in the controls, 2 volumes can now be chosen by pressing  button twice during normal operation.

One volume setting shows in the left display (NONE to 10; 10 being the loudest) and the second volume shows in the right display. To select the volume, press the √ button under the desired volume .

**Engery Save Mode (SP-18)**

Press ► button and “SP-18 ENERGY SAVE ENABLED?” flashes in the left display. Press the ▲ or ▼ buttons to choose “YES” or “NO”.

If set to YES, during times of non-use the fryer automatically starts an Energy Save Mode, which turns-off the blowers. Then once a product is selected to start a cook cycle, the blowers and heat come back on. If set to NO, the blowers are on constantly.

**Fryer Type (SP-19)**

Press ► button and “SP-19 FRYER TYPE” flashes in the left display. Press the ▲ or ▼ buttons to choose “GAS” or “ELEC”.

**Vat Type (SP-20)**

Press ► button and “SP-20 VAT TYPE” flashes in the left display. Press the ▲ or ▼ buttons to choose “SPLIT” or “FULL”.

**5-1. SPECIAL PROGRAM**  
**MODE (Continued)**

**Autolift Enabled (SP-21)**

Press ► button and “SP-21 AUTOLIFT ENABLED?” flashes in the left display. Press the ▲ or ▼ buttons to choose “YES LIFT” or “NO LIFT”. If fryer is fitted with the auto-lift option, SP-21 must be set to “YES LIFT”, otherwise, set SP-21 to “NO LIFT”.

**Bulk Oil Supply (SP-22)**

Press ► button and “SP-22 BULK OIL SUPPLY?” flashes in the left display. Press the ▲ or ▼ buttons to choose “YES SUPL” or “NO SUPL”. Set to YES if the oil is pumped into the vats from an outside oil reservoir. Otherwise, set SP-22 to NO.

**Bulk Oil Disposal (SP-23)**

Press ► button and “SP-23 BULK OIL DISPOSE?” flashes in the left display. Press the ▲ or ▼ buttons to choose “YES DISP” or “NO DISP”. Set to “YES DISP” if the oil is pumped from the vats to an outside oil reservoir when disarding the oil. Otherwise, set SP-23 to “NO DISP”.

**Serial Number Log (SP-24)**

Press ► button and “SP-24” and “S/N √EDIT” flash in the displays, along with the serial number of the unit. THIS SERIAL NUMBER SHOULD MATCH THE SERIAL NUMBER ON THE DATA PLATE, ON THE DOORS. IF NOT, IT CAN BE RECORDED.

**Program Code Change (SP-25)**

This allows the operator to change the program code (factory set at 1, 2, 3) used to access Product Programming and Level 2 Program Mode.

Press ► button and “SP-25” and “CHANGE MGR CODE? 1=YES” flash in the display. Press  and “ENTER NEW CODE, P=DONE, I=QUIT show scrolls through the display. Press the product buttons for new code.

If satisfied with code, press  and “REPEAT NEW CODE, P=DONE, I=QUIT, shows in display. Press same code buttons.

## **5-1. SPECIAL PROGRAM** **MODE (Continued)**



### **Program Code Change (SP-25) (Continued)**

If satisfied with code, press  and “\*CODE CHANGED\*” shows in display.

If not satisfied with code, press  and “\*CANCEL” shows in display, then reverts back to “SP-25” and “CHANGE, MGR CODE? 1=YES”. Now the above steps can be repeated.

### **Usage Code Change (SP-26)**

This allows the operator to change the reset usage code (factory set at 1, 2, 3) to reset the usage amounts of each product. See Review Usage step in Information Mode.



Press  button and “SP-26 CHANGE USAGE CODE? 1=YES” flashes in the display. Press  and “ENTER NEW CODE, P=DONE, I=QUIT show scrolls through the display. Press the product buttons for new code.

If satisfied with code, press  and “REPEAT NEW CODE, P=DONE, I=QUIT, shows in display. Press same code buttons.



If satisfied with code, press  “\*CODE CHANGED\*” shows in display.

If not satisfied with code, press  and “\*CANCEL” shows in display, then reverts back to “SP-26” and “CHANGE, USAGE CODE? 1=YES”. Now the above steps can be repeated.



### **Dispose Requires Code ? (SP-27)**

Press  button and “SP-27 DISPOSE REQUIRES CODE ?” flashes in the left display. Press the  or  buttons to choose YES or NO. If set to YES, code 1, 2, 3 must be entered to discard the oil from the vat, using the Dispose Mode.

### **Longer Fill Time (SP-28)**

Press  button and “SP-28 LONGER FILLTIME ENABLED?” flashes in the left display. Press the  or  buttons to choose YES or NO.

### **Let User Exit Fill (SP-29)**

Press  button and “SP-29 LET USER EXIT FILL” flashes in the left display. Press the  or  buttons to choose YES or NO. If YES is chosen, the user can exit the Express Filter™ fill operation.

## **5-2. CLOCK SET**

1. Press and hold the **P** button for 5 seconds until “LEVEL 2”, followed by, “SP PROG” and “ENTER CODE” show in the display.
2. Press the **P** button 2 times and “CLK SET” and “ENTER CODE” flash in the left display.
3. Enter code 1, 2, 3 (first 3 product buttons).
4. “CS-1 ENTER DATE MM-DD-YY” flashes in the left display. Use the product buttons to set the date in the right display.
5. Press ► button and “CS-2 ENTER TIME” flashes in the left display and the time flashes in the right display. Press the ▲ or ▼ , or use product buttons, to change the time.
6. Press ► button and “CS-2 ENTER TIME” flashes in the left display and “AM” or “PM” flashes in the right display. Use the ▲ or ▼ buttons to choose AM or PM.
7. Press ► button and “CS-3 TIME FORMAT” flashes in the left display and “12-HR” or “24-HR” shows in the right display. Use the ▲ or ▼ buttons to choose a 12 hour time format or a 24 hour time format.
8. Press ► button and “CS-4 DAYLIGHT SAVING TIME” flashes in the left display. Use the ▲ or ▼ buttons to choose daylight saving time for your area: 1.OFF; 2.US (2007 & after); 3.EURO; or 4.FSA (US before 2007).

## **5-3. DATA LOGGING, HEAT CONTROL, TECH, STAT, AND FILTER CONTROL MODES**

The Data Logging, Heat Control, Tech, Stat and Filter Control Modes are advanced diagnostic and program modes, mainly for Henny Penny use only. For more information on these modes, contact the Service Department at 1-800-417-8405 or 1-937-456-8405.

## **5-4. TECH MODE**



The TECH Mode has self-diagnostic information, which can be used by certified technicians for troubleshooting purposes, such as:

- T-1 • Software**
- T-2 • Fryer Type (Gas or Elec.)**
- T-3 • Push Button Test**
- T-4 • All On Display Test**
- T-5 • Display Segment Test**
- T-6 • Display Digits Test**
- T-7 • Display Decimal Point Test**
- T-8 • LED's Test**
- T-9 • Left Temp. Probe Calibration & Offset**
- T-10 • Left Level 1 Probe Calibration & Offset**
- T-11 • Left Level 2 Probe Calibration & Offset**
- T-12 • Right Temp. Probe Calibration & Offset**
- T-13 • Right Level 1 Probe Calibration & Offset**
- T-14 • Right Level 2 Probe Calibration & Offset**
- T-15 • CPU Control Temp. Calibration/Offset/Highest**
- T-16 • View A - D Channel**
- T-17 • Inputs**
- T-18 • Outputs S-H-S-H**
- T-19 • Basket Lifts**
- T-20 • AIF Info**
- T-21 • Pumps and Valves**
- T-22 • Recovery Test Valves**
- T-23 • Heat Err Enabled?**
- T-24 • Change Tech Code?**
- T-25 • Total Initialization**

### **NOTICE**

Not all Tech Mode functions are discussed in this section. To ensure proper operation of fryer, please consult Henny Penny Corp. before changing any of these settings. For more information on these functions, contact the Service Department at 1-800-417- 8405, or 1-937-456-8405.



#### **5-4. TECH MODE (Continued)**

1. Press and hold the  button for 5 seconds until “LEVEL 2”, followed by, “SP PROG” and “ENTER CODE” show in the display.
2. Press the  button 4 times and “TECH” and “ENTER CODE” flash in the left display.
3. Enter code 1, 1, 2, 2, 1, 1, 2, 2 (first 2 product buttons).
4. “T-1 SOFTWARE” flashes in the left display and “EV-ELITE” shows in the right display. Use the ◀ and ▶ buttons to select the steps.

### **NOTICE**

If a bad code is entered, a tone sounds and “BAD CODE” shows on the display. Wait a few seconds, the controls revert back to the cook mode, and repeat the above steps. Press and hold  button at anytime to return to normal operation.

#### **T-1 - SOFTWARE**

- Press  to view HP Part No. of eprom
- Press  to view software ID
- Press  to view software version

#### **T-2 - FRYER TYPE - GAS or ELEC**

#### **T-3 - PUSH-BUTTON TEST**

Press any of the control buttons to test operation. You should hear a beep, and the LED should light and/or a display.

#### **T-4 - ALL ON DISPLAY TEST**

Press any of the product buttons and all the LEDs and display segments should light.

#### **T-5 - SEGMENTS TEST**

Press  button to view the different segments of the display characters.

#### **T-6 - DIGITS TEST**

Press  button to view all segments of each digit across the displays.

#### 5-4. TECH MODE (Continued)

##### **T-7 - DECIMAL PTS TEST**

Press  button to view all decimal points across the displays.

##### **T-8 - LED'S TEST**

Press  buttons to view each LED across the control panel.

##### **T-17 - INPUTS - HDF**

H = HIGH LIMIT - If “H” is present, the high limit is good. If “-” shows then the high limit is tripped out (overheated) or disconnected.

D = DRAIN SWITCH - If “D” is present, the drain handle (when applicable) is closed. If “-” shows then the drain is open or the switch is faulty.

F = FAN (PRESSURE SWITCH) - If “F” is present, the pressure switch is good. If “-” shows in the display, the switch is faulty.

Press ▼ button and an underscore (“\_”) indicates the input is not presently detected. A Checkmark (“√”) indicates the signal is detecting a normal input. A blinking (“X”) indicates the signal is presently detected, but is detected as a half-wave (partially failed) input.

### **NOTICE**

The H, D, F signals above are wired in series. The first signal missing out of this sequence generally causes all signals to the right of it to be missing as well.

##### **T-18 - OUTPUTS**

S = SAFETY GAS VALVE (if available) - Press  to open and close the gas safety valves

H = HEAT OUTPUTS - Press  to turn on and off the heating outputs (ex: gas valve)

**5-4. TECH MODE (Continued)**

**T-20 - AIF Board Inputs:**

E = Stop button

Ex = E-Stop pressed.

P = Drain Pan

Px = drain pan is missing.

JL = JIB

Jx = JIB oil level is low.

R = RTI



Rx = RTI System NOT Detected

DT = Discard Tank

DTx = tank full

**T-21 - PUMPS & VALVES**

Press ▼ button and “LIGHTS” “DLT\_” shows in displays.

Press  and left Filter Beacon lights (split vats) and press  button and right Filter Beacon lights (display shows “DLTo” when on)

Press ▼ button and “VALVES” “DcRc” shows in displays.

Press  to open and close the return valve.

“DcRc” means valve is closed, “DcRo” means valve is open.  
(Driven by the control board)

Press ▼ button and “DISCARDc” and “JIBFILLc” shows in the displays. (Driven by the AIF board)

Press  to open and close the RTI discard valve (display shows “DISCARD0” when open)

Press  to open and close the RTI JIB fill valve (display shows “JIBFILL0” when open)

Press ▼ button and “PUMP FP\_” and “JP\_ NP\_” shows in the displays. (Driven by the AIF board)

Press  to turn off and on the filter pump (display shows “FP\*” when on)

Press  to turn off and on the JIB pump (display shows “JP\*” when on)

Press  to turn off and on the new oil pump (if available - display shows “NP\*” when on)

**5-4. TECH MODE (Continued)**

Press ▼ button and “AIF REQ” and “RQ=Y OK=Y” shows in the displays.

“REQ=Y” means that this particular control is currently requesting control of the AIF Board outputs.

“OK=Y” means that the AIF Board has granted this control the authority to control the AIF Board outputs.

Press ▼ button and “FILR IN” and “USE BY 1(ex)” shows in the displays. These displays shows which controls are using the filtering system.

“USE = 0” = not in use

“USE = 7” = used by AIF

“USE = 1 to 5” = used by control PCB

Press ▼ button and “CPU POSN” and “1 OF 3(ex)” shows in the displays. These displays shows which controls are plugged into which port on the AIF board.

For example, the left control should be plugged into port 1, and on a 3 control fryer, shows “1 OF 3” on the display.

If the right control is unplugged, then the left control would show “1 OF 2” instead of “1 OF 3”.

Press ▼ button and “INP E\_P\_” and “JL\_Rx DF\_” shows in the displays.

**5-4. TECH MODE (Continued)**

Press ▼ button and “OUT F\_J\_” and “N\_DI\_oJF\_” shows in the displays.

AIF Board Outputs:

Current outputs status from AIF board.

F = Filter Pump. (Fx = Filter pump is on)

J = JIB Pump. (Jx = JIB pump is on)

N = New Oil Pump. (Nx = RTI new oil pump on)  
(if present)

DI = Discard Valve. (DIo = Disc. valve open/DIc=closed)  
(if present)

JF = JIB Fill Valve. (JFo = JIB fill valve open/JFc=closed)

Press ▼ button and “REQ F\_J\_” and “N\_DI\_JF\_” shows in the displays.

AIF Board Outputs Requested by the Control Board:

Current outputs status from AIF board.

F = Filter Pump. (Fx = Filter pump is on)

J = JIB Pump. (Jx = JIB pump is on)

N = New Oil Pump. (Nx = New oil pump on)  
(if present)

DI = Discard Valve. (DIo = Disc. valve open/DIc=closed)  
(if present)

JF = JIB Fill Valve. (JFo = RTI JIB fill valve open/JFc=closed)

**5-5. STATS MODE**

This mode allows a technician to view advanced information on the operation of the fryer and controls.

1. Press and hold the **P** button for 5 seconds until “LEVEL 2”, followed by, “SP PROG” and “ENTER CODE” show in the display.
2. Press the **P** button 5 times and “STATS” and “ENTER CODE” flash in the left display.
3. Enter code 1, 1, 2, 2, 1, 1, 2, 2 (first 2 product buttons).
4. “ST-1 STATS LAST RESET ON...” flashes in the left display and the date shows in the right display. Use the ◀ and ▶ buttons to select the steps.

**NOTICE**

If a bad code is entered, a tone sounds and “BAD CODE” shows on the display. Wait a few seconds, the controls revert back to the cook mode, and repeat the above steps. Press and hold **P** button at anytime to return to normal operation.

- |              |                                     |              |  |
|--------------|-------------------------------------|--------------|--|
| <b>ST-1</b>  | • Stats Last Reset Date             | <b>ST-16</b> | • System RAM Fade Count                      |
| <b>ST-2</b>  | • Fryer Total Running Hours         | <b>ST-17</b> | • Cook RAM Fade Count                        |
| <b>ST-3</b>  | • Left Vat Melt Cycle Hours         | <b>ST-18</b> | • Product RAM Fade Count                     |
| <b>ST-4</b>  | • Left Vat Cook Cycle Hours         | <b>ST-19</b> | • Stat RAM Fade Count                        |
| <b>ST-5</b>  | • Left Vat Idle Hours               | <b>ST-20</b> | • RAM Data Error Count                       |
| <b>ST-6</b>  | • Right Vat Melt Cycle Hours        | <b>ST-21</b> | • Data Total Loss Count                      |
| <b>ST-7</b>  | • Right Vat Cook Cycle Hours        | <b>ST-22</b> | • User Initialization Count                  |
| <b>ST-8</b>  | • Right Vat Idle Hours              | <b>ST-23</b> | • Automatic Initialization Count             |
| <b>ST-9</b>  | • Power-Ups Count                   | <b>ST-24</b> | • Cooks Count per Product                    |
| <b>ST-10</b> | • Error Counts                      | <b>ST-25</b> | • Cook Cycle Stop Counts                     |
| <b>ST-11</b> | • Left Vat Heat On Hours            |              | - “A” = number of stops in the first 30 sec. |
| <b>ST-12</b> | • Right Vat Heat On Hours           |              | - “B” = 0                                    |
| <b>ST-13</b> | • Highest Left Vat Oil Temperature  |              | - “C” = 0                                    |
| <b>ST-14</b> | • Highest Right Vat Oil Temperature |              | - “D” = complete cook cycles counted         |
| <b>ST-15</b> | • Highest CPU Temperature           | <b>ST-26</b> | • Reset All Stats                            |

## **5-6. DO NOT DISTURB**

Time periods of peak operations during which the “FILTER NOW?” message will not appear, may be programmed into the fryer. There are three groupings of days - Monday thru Friday (M-F), Saturday (SAT), and Sunday (SUN). Within each day grouping, up to 4 time periods (M-F 1 thru M-F 4, SAT 1 thru SAT 4, and SUN 1 thru SUN 4) may be programmed. A time period may be anywhere from 1 to 180 minutes in length.

1. Press and hold the **P** button for 5 seconds until “LEVEL 2”, followed by, “SP PROG” and “ENTER CODE” show in the display.
2. Press **P** button once more and “DO NOT DISTURB” and “ENTER CODE” flash in the left display.
3. Enter code 1, 2, 3 (first 3 product buttons).
4. “DO NOT DISTURB ENABLED?” flashes in the left display and YES or NO appears in the right display. Press the ▲ or ▼ buttons to choose YES or NO.
5. Press **P** button and “M-F 1” shows in the left display and the time flashes in the right display. Press the ▲ or ▼, or use product buttons, to change the time.
6. Press **P** button and “M-F 1” shows in the left display and “A” or “P” flashes in the right display. Use the ▲ or ▼ buttons to choose AM or PM.
7. Press **P** button and “M-F 1” shows in left display and far right character display flashes. Press product buttons to enter amount of time (up to 180 minutes) during which filtering will be inhibited, after time entered in step 5.
8. Press **P** button to move to the next timer period, M-F 2.
9. Repeat steps 5, 6, 7, and 8 for other desired time periods.

## SECTION 6. MAINTENANCE

### 6-1. INTRODUCTION

This section provides checkout and replacement procedures, for various parts of the fryer. Before replacing any parts, refer to the Troubleshooting Section to aid you in finding the cause of the malfunction.

### 6-2. MAINTENANCE HINTS

1. A multimeter will help you to check the electric components.
2. When the manual refers to the circuit being closed, the multimeter should read zero unless otherwise noted.
3. When the manual refers to the circuit being open, the multimeter should read infinity.



**Do not move the fryer with hot oil in the vat or filter pan. Severe burns can result from splashing hot oil.**

### 6-3. PREVENTIVE MAINTENANCE

To ensure a long life of the fryers and their components, regular maintenance should be performed. Refer to the chart below.

Frequency	Action
Daily	Filter the oil (See Daily Filtering Instructions Section in Operator's Manual)
Daily	Change Filter Pad (See Changing Filter Pad Section in Operator's Manual)
Every filter pad change	Lubricate filter pan o-rings
Quarterly	Inspect/Change Filter Pan O-Rings (See Check/Replace Filter Drain Pan O-Ring Section)
When oil smokes, foams-up violently, or tastes bad	Change oil
Every change of oil	Clean Vat (See Clean-Out Mode Section in Operator's Manual)
Semi-Annually	Clean blowers & Vents (See Section 3-21 in Operator's Manual)

**6-4. CONTROL PANEL &  
MENU CARD  
REPLACEMENT**

Should the control panel become inoperative, or the menu card needs changed, follow these instructions:

1. Remove electrical power supplied to the vat.



**To avoid electrical shock or property damage, move the power switch to OFF and disconnect main circuit breaker, or unplug cord at wall receptacle.**

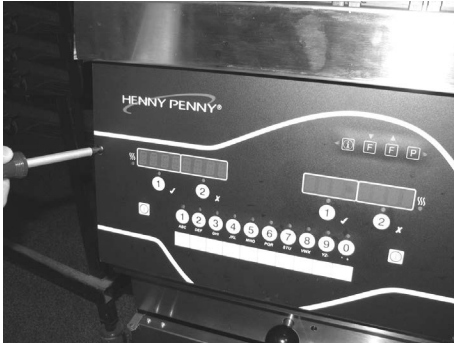

2. Remove the two screws securing the control panel.



3. Pull the top of the panel down, allowing the panel to be supported by the 2 brackets in the slots in the control shroud. (If changing control panel, continue onto step 5.)

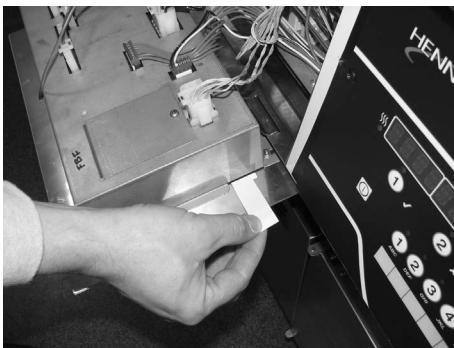

4. If changing the menu card, loosen the tape securing the menu card at the bottom, side of the control panel and pull menu card from panel. Carefully, slide changed menu card back into slot in panel and secure with tape.

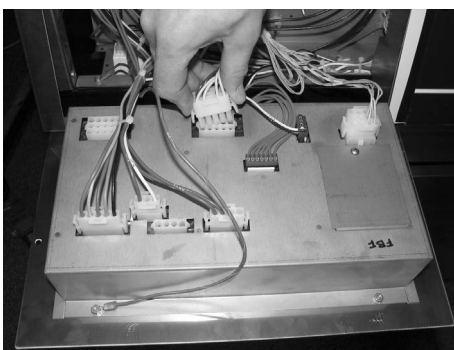

5. Unplug the connectors going to the control board.

6. Install a new control panel in reverse order.

**6-5. HIGH TEMPERATURE  
LIMIT CONTROL**

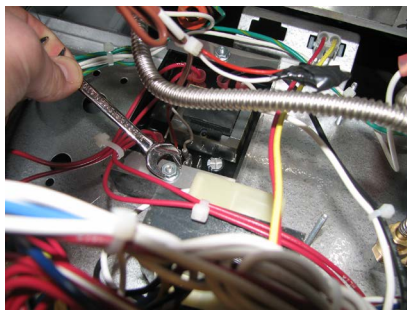
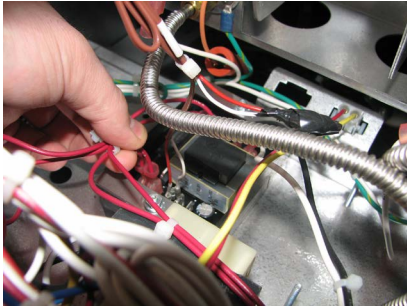

1. Remove electrical power supplied to the unit.



**To avoid electrical shock or property damage, move the POWER switch to OFF and disconnect main circuit breaker, or unplug cord at wall receptacle.**

2. Lower the control board (refer to the Control Board section).
3. Remove the heat shield which covers the high limit control.
4. Mark and disconnect the wires located on the high limit control.
5. Using a 3/8" wrench, remove the nuts.
6. Remove the clamp bars.
7. Slide the high limit control off of mounting studs.
8. Install the new control in reverse order.

## **6-6. MAIN POWER SWITCH**

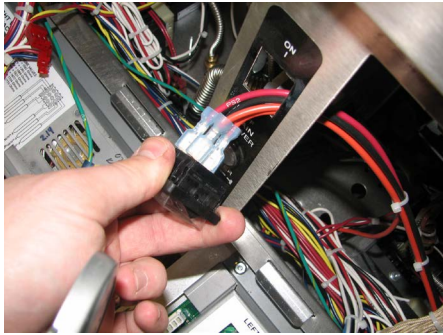

1. Lower the control board (see Control Board Replacement).
2. Press on the switch from the inside of the fryer to release from the metal shroud.
3. Mark and disconnect the wires from the switch.
4. Connect the wires onto the new switch on the correct terminals.
5. Press back into factory location.

## 6-7. PROBE REPLACEMENT



Oil level probe      Temperature probe      Oil level probe

The temperature probe is the center probe inside the vat (see photo at left) and it relays the actual oil temperature to the control. If it becomes disabled, “E-6A or B” shows in the display.

The oil level probes (left & right-see photo at left) monitor the oil level by temperature differences. If they become disabled, the display shows: “E-18A”= left probe; “E18-B”= right probe; “E18C”= both.

Also, if any of the probes are out of calibration more than 5°F, or 5°C, the probe should be replaced. An Ohm check can be performed also. See chart below.

Checkout:



To avoid electrical shock or property damage, move the power switch to OFF and disconnect main circuit breaker, or unplug cord at wall receptacle.

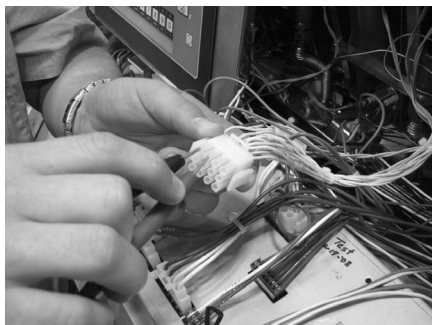

1. Using a Phillip’s-head screwdriver, or cordless drill, loosen the screw securing the top of the control panel and secure control panel in the slots of the shroud.
2. Pull the probe connector from the control panel and locate the terminals in the connector for the probe being tested. Attach meter leads onto those terminals and refer to the chart at left to determine if probe is good or not. (Probe wires are labeled, with #1 being the far left probe.)

Temp. F	Temp. C	Resistance Ohms	Temp. F	Temp. C	Resistance Ohms
50	10.00	1039.02	250	121.11	1464.79
60	15.56	1060.65	260	126.67	1485.71
70	21.11	1082.24	270	132.22	1506.58
80	26.67	1103.80	280	137.78	1527.43
90	32.22	1125.32	290	143.33	1548.23
100	37.78	1146.81	300	148.89	1569.00
110	43.33	1168.26	310	154.44	1589.73
120	48.89	1189.67	320	160.00	1610.43
130	54.44	1211.05	325	162.78	1620.77
140	60.00	1232.39	330	165.56	1631.09
150	65.56	1253.70	340	171.11	1651.72
160	71.11	1274.97	350	176.67	1672.31
170	76.67	1296.20	360	182.22	1692.86
180	82.22	1317.40	365	185.00	1703.13
185	85.00	1327.99	370	187.78	1713.38
190	87.78	1338.57	380	193.33	1733.87
200	93.33	1359.69	390	198.89	1754.31
210	98.89	1380.79	400	204.44	1774.72
212	100.00	1385.00	410	210.00	1795.10
220	104.44	1401.84	420	215.56	1815.44
230	110.00	1422.86	430	221.11	1835.74
240	115.56	1443.85	440	226.67	1856.01

**6-7. TEMPERATURE PROBE  
REPLACEMENT**  
**(Continued)**

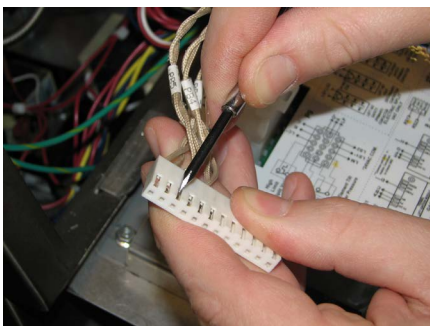
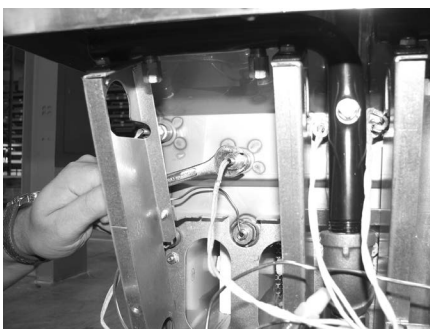
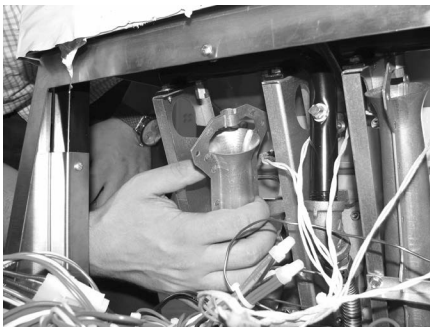
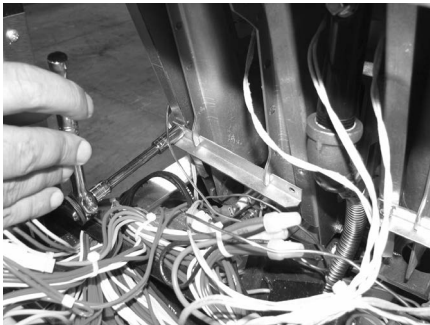

**Replacement:**

1. Pull-out on the drain valve knob and drain the oil from the vat.



**To avoid electrical shock or property damage, move the power switch to OFF and disconnect main circuit breaker, or unplug cord at wall receptacle.**

2. Using a 3/8" socket, remove the 2 screws securing the burner jet bracket and remove bracket.

3. Pull both burner jets from unit.

4. Using a 1/2" wrench, remove the nut on the compression fitting, and remove the temperature probe from the vat.

5. Using a terminal extractor, remove the probe terminals from the connector and pull remove probe from unit

**6-7. TEMPERATURE PROBE  
REPLACEMENT  
(Continued)**

- Place the nut and new ferrule on the new temperature probe and insert the temperature probe into the compression fitting. See drawing below.

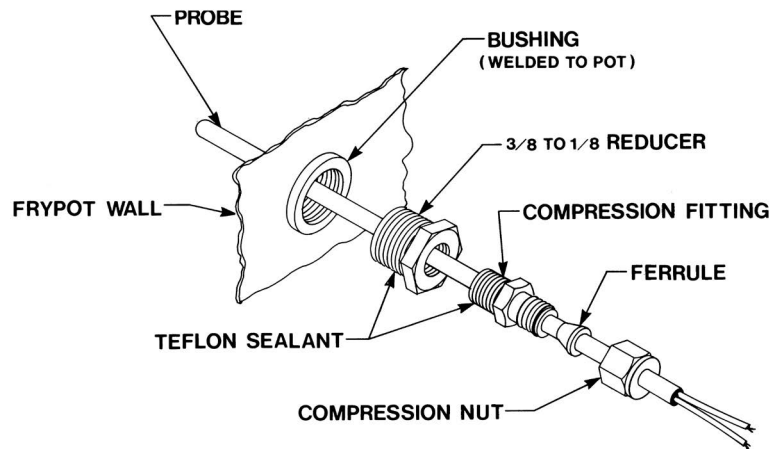

- Using the probe gauge in the kit, follow the instructions on drawing below.
- Hand-tighten compression nut and then a half turn with wrench.

**CAUTION**

*Excess force will damage temperature probe.*

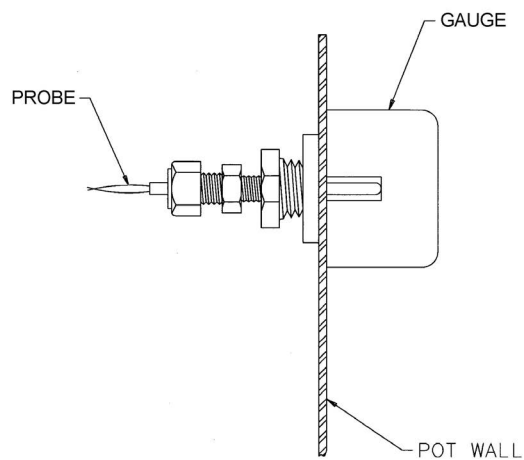

- NOTE:
- LOCATE TEMPERATURE PROBE THRU POT WALL.
  - PLACE GAUGE AGAINST POT WALL AS SHOWN.
  - PUSH TEMPERATURE PROBE THRU UNTIL IT MAKES CONTACT WITH GAUGE.
  - TIGHTEN TEMPERATURE PROBE IN PLACE.

**6-7. TEMPERATURE PROBE  
REPLACEMENT**  
**(Continued)**

9. Connect new temperature probe to the connector and fasten connector onto control panel.
10. Replace control panel and reconnect power to vat.
11. Fill vat by pressing and holding **F** button until \*FILTER\* \*MENU\* shows in the display. Then once “1.EXPRESS FILTER” shows in the display, press **▶** 4 times until “5.FILL FROM PAN” shows in the display. Press **√** button and “PUMP” “EXIT” shows in the display. Press **√** button again, and oil fills vat. Once vat is full, press **X** twice to return to normal operation.

**6-8. SOLENOID VALVES**

Each vat has a solenoid plumbed-into the oil return lines. They are normally closed, but open when power is supplied, such as, the controls are filling the vats.



**To avoid electrical shock or property damage, move the power switch to OFF and disconnect main circuit breaker, or unplug cord at wall receptacle.**

1. Remove both top and bottom rear panels, or a side panel, depending upon the location of the solenoid.

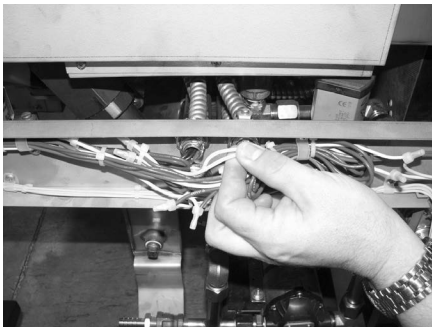

**Checkout**

2. Follow the wires from the solenoid and through the conduit and then cut the wires. Strip the wires back and take an ohm reading:

120 Volts - 60Hertz	50 Ohms
220-240 Volts -50/60 Hertz	230 Ohms

**6-8. SOLENOID VALVES**  
**(Continued)**



**Replacement:**

1. Using an adjustable wrench, loosen the front and rear fittings to solenoid.

2. Remove the conduit from the fryer and pull the solenoid assembly from the fryer.

3. Remove the conduit from the solenoid.

**6-8. SOLENOID VALVES**  
**(Continued)**

4. Remove elbow and fittings from solenoid stem assembly and attach them to the new solenoid, using pipe sealant on the threads.
5. Reattach the conduit to the new solenoid, threading the wires through the conduit.
6. Reattach the solenoid assembly to the fryer.
7. Reattach the conduit to the fryer and connect the wires to the fryer using wire nuts.
8. Replace rear side panels or rear panels and reconnect power to the fryer.

## **6-9. FILTER PUMP & MOTOR**

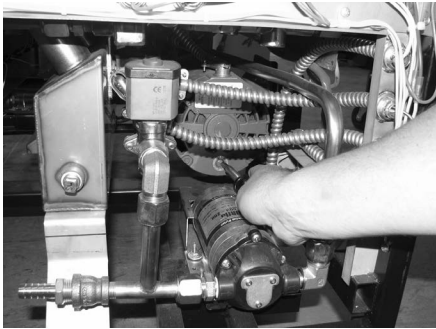

The 2 most common causes for a fryer not to pump oil are that the pump is clogged, or the thermal overload switch has been tripped on the motor. The pump and motor is located on the rear of the fryer.

To reset the thermal overload switch:

1. Remove the right side panel and locate the pump and motor in the rear of the fryer. If the motor is hot, allow it to cool for about 5 minutes.
2. Since it takes some effort to reset the switch, use a tool, such as a Phillip's-head screwdriver, to press against the reset button until a "click" is heard.



To remove debris from pump:

1. Loosen the four Allen head screws on the end of pump and remove the cover. (Removing the bottom rear panel may help in accessing the set screws.)
2. The inside is now exposed leaving a rotor and five teflon rollers. Clean the rotor and rollers.
3. To reassemble, place rotor on drive shaft, and place roller into rotor.

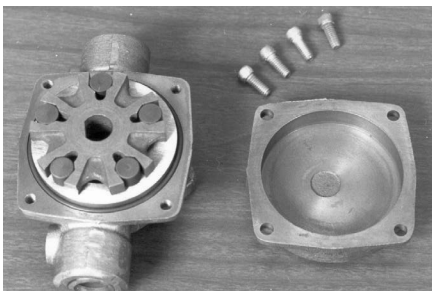

### **NOTICE**

A small amount of grease might be needed to hold the bottom roller into place until cover plate is put on. Make sure O-ring is in proper position on plate.

### **CAUTION**

*Indicators, on the side of the two halves of the pump, must align together.*

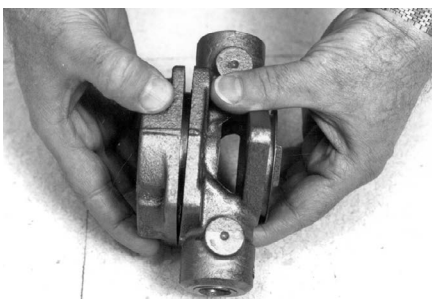

## **6-9. FILTER PUMP & MOTOR** **(Continued)**



To avoid electrical shock or property damage, move the power switch to OFF and disconnect main circuit breaker, or unplug cord at wall receptacle.

### **Removal:**

1. Remove the bottom, rear panel and the right side panel.
2. Using a 5/8" wrench, loosen the front, flexible line fitting, on the pump.
3. Using a 1" wrench, loosen the rear pump fitting.
4. Locate the appropriate conduit on the right side of the unit and disconnect the conduit from the fryer.
5. Using a 1/2 in. wrench, remove the 4 bolts securing the motor to the motor bracket and pull the pump and motor assembly from fryer.

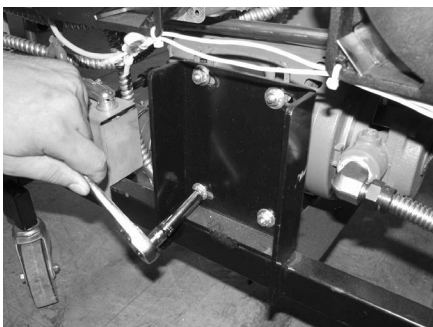
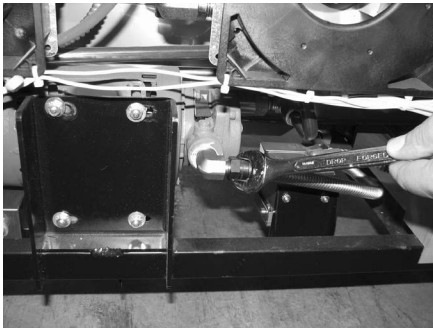

### To replace pump on motor:

1. Using a 1/2 in. wrench, remove the 2 bolts securing the pump to the motor and pull the pump from the motor.
2. Install a new seal kit (part no. [17476](#)) onto shaft of motor.
3. Align the shaft of the motor with the rotor on the inside of the pump and push pump onto shaft of motor.
4. Secure the pump onto the motor with the 2 bolts.

## **6-10. JIB PUMP REPLACEMENT**

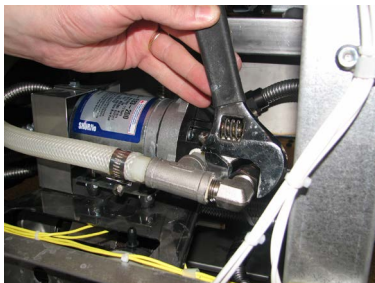
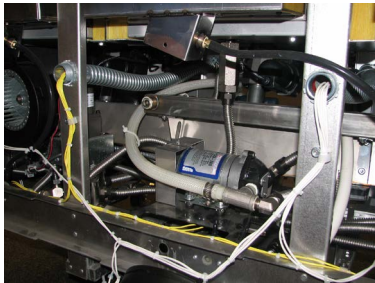

1. Remove electrical power supplied to the unit.



**To avoid electrical shock or property damage, move the POWER switch to OFF and disconnect main circuit breaker, or unplug cord at wall receptacle.**

2. Remove the lower back shroud (See back shroud removal).
3. Remove blower (see blower removal sections).
4. Using an adjustable wrench, remove the flex line from the elbow.
5. Loosen the hose clamp with a flat blade screw driver and disconnect the hose.
6. Use a 3/8 socket or wrench and remove the four nuts and washers from the pumps feet.
7. Pull the pump off of the studs.
8. Remove the wire nuts.
9. Wire the new pump into the existing wires.
10. Place the pump onto the studs. Be sure to have the shield box in place on the studs before placing the pump onto studs.
11. Tighten the pump nuts and washers onto the feet of the pump.
12. Reconnect fittings.
13. Replace blower.

## **6-11. BLOWER REPLACEMENT**

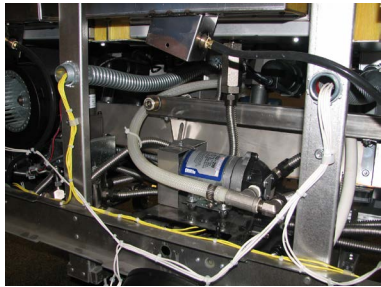
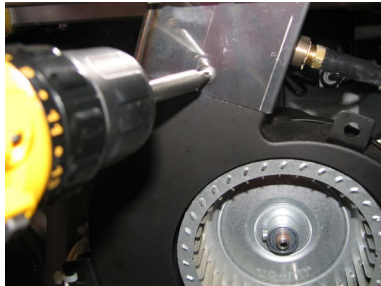
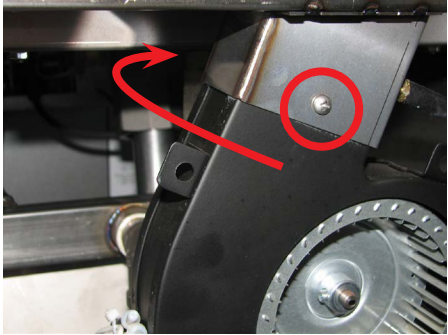

1. Remove electrical power supplied to the unit.



**To avoid electrical shock or property damage, move the POWER switch to OFF and disconnect main circuit breaker, or unplug cord at wall receptacle.**

2. Remove the lower back shroud (See back shroud removal).
3. Using a phillips head screw, remove the two screws that secures the blower to the flue. One screw is located on the back side of the flue.
4. Cut zip ties that are holding the wires to the blower. Remove the wire nuts from the wires.
5. Remove blower.
6. Reconnect new blower wires to the existing wires with wire nuts.
7. Tighten the new blower onto the flue with the two screws.
8. Zip tie wires back to the blower.

## 6-12. FILTER BEACON™

### Replacement



**To avoid electrical shock or property damage, move the power switch to OFF and disconnect main circuit breaker, or unplug cord at wall receptacle.**

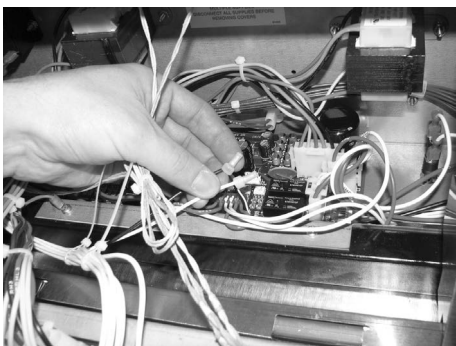
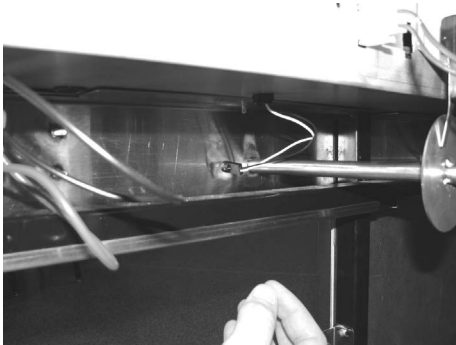

1. Remove right or left side panel for end vats, or hinge-down the control panel for center vats.

2. Pull apart the light by pulling on the rear of the light and removing the front part of the light from the front of the fryer.

3. Locate and cut the light wires and pull the light from unit.

4. Connect new light wires, using wirenuts and install light in reverse order.

5. Restore power to the unit.

### **6-13. AIR PRESSURE SWITCHES**



1. Remove electrical power supplied to the unit.
2. Remove the lower back shroud (See back shroud removal).
3. Remove the pressure switch mounting cover from the frame.
4. Remove the vacuum hose from switch.
5. Using a phillips bit or screwdriver, remove the two screws securing switch to the cover.
6. Disconnect the wires on the switch.
7. Replace switch in reverse order.

## **6-14. PILOT REPLACEMENT**

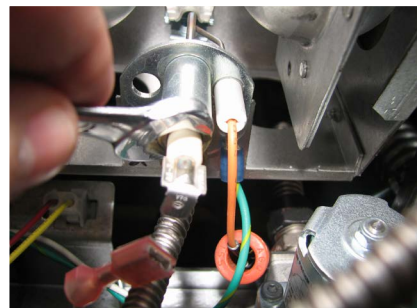
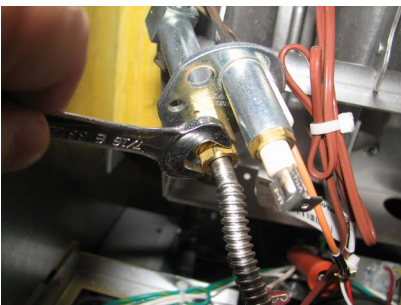
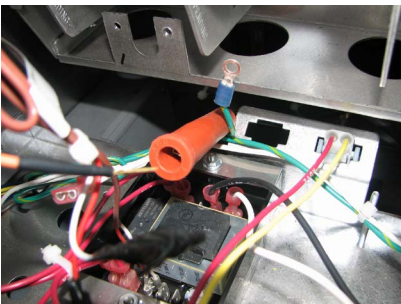
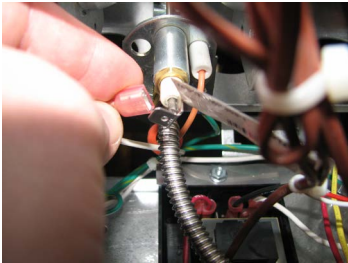

1. Remove electrical power supplied to the unit.
2. Lower the control board (refer to the Control Board section).
3. Remove burner tubes (refer to the Burner Tube Removal section).
4. Remove the flame sensor wire.
5. Remove the two screws securing the pilot to the burner assembly. The right hand screw will have the ground wire.
6. Disconnect the pilot wire located in the orange rubber sleeve.
7. Using a 7/16" wrench, loosen the pilot tube from the pilot.
8. Using a 7/16" wrench loosen and remove flame sensor.
9. Replace pilot in reverse order.
10. When screwing the pilot back to the burner assembly, be sure to connect the ground wire to the right hand screw.

### **NOTICE**

To replace the flame sensor, leave pilot assembly attached to the burner assembly and remove only the flame sensor with a 7/16" wrench.

# SECTION 7: PARTS

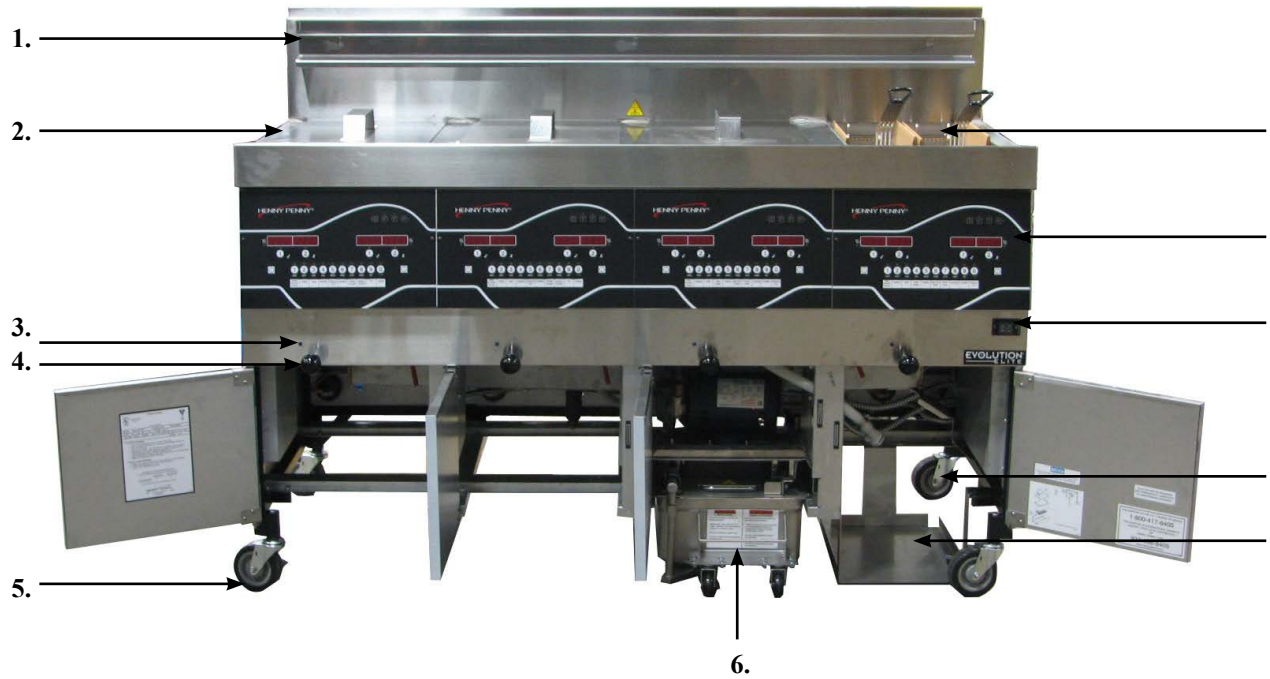

Item No.	Part No.	Description	Quantity
1	152508	HANGER-BASKET-EEGXX4 .....	1/ 4-well
1	152793	HANGER-BASKET-EEGXX3 .....	1/ 3-well
2	76555	WELD ASSY-COVER FULL .....	1/vat
3	81980	LED-5MM BLUE .....	1/vat
4	-----	DRAIN KNOB ASSEMBLY.....	1/vat
		--See DRAIN KNOB drawing for breakdown	
5	77575	CASTER-SWIVEL W/ BRAKE (front).....	2
6	77679	CASTER-SWIVEL W/O BRAKE (back) .....	2
7	151704	STUD ASSY-JIB SHELF .....	1
8	52224	COVERED POWER SWITCH .....	1
9	81915	BASKET-1/2 SIZE BLK FRONT SUPP.....	A/R
9	85136	BASKET-FULL SIZE BLACK FR SPRT.....	A/R
10	152634	DRAIN PAN ASSY .....	1
11	96687	ASSY-CHILI CONTROL-EEX16X .....	1/well
11	96862	ASSY-MAGGIANO CONTROL-EEX16X.....	1/well

Recommend Parts: A=Truck Stock/B=Dist. Stock / \*not shown/ A/R=As Required

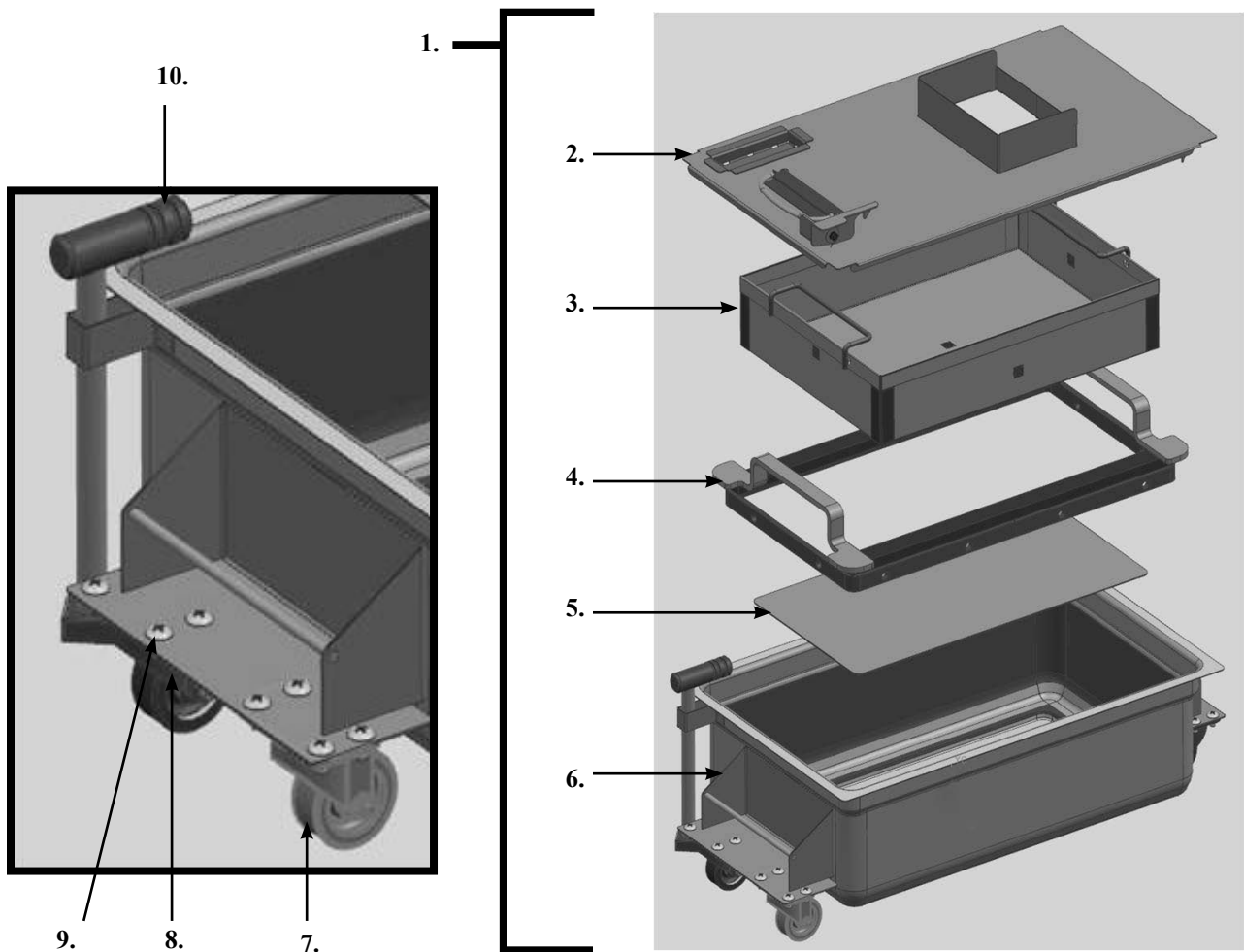

Item No.	Part No.	Description	Quantity
1	152634	ASSY-EEG-16X DRAIN PAN W/ CASTER.....	1
2	152635	--ASSY-EEG-16X DRAIN PAN COVER .....	1
3	85507	--WELD ASSY-CRUMB CATCHER .....	1
4	85503	--WELD ASSY-FILTER WEIGHT .....	1
5	85519	--FILTER SECTION .....	1
6	95842	--ASSY-DRAIN PAN .....	1
7	19004	---CASTER-SWIVEL 2IN .....	4
8	SC01-009	---SCREW 1/4-20 X 1/2 THD .....	4/wheel
9	NS04-005	---LOCKNUT1/4-20 .....	4/wheel
10	86349	O-RING-116 SUCTION LINE .....	3

Recommend Parts: A=Truck Stock/B=Dist. Stock / \*not shown/ A/R=As Required

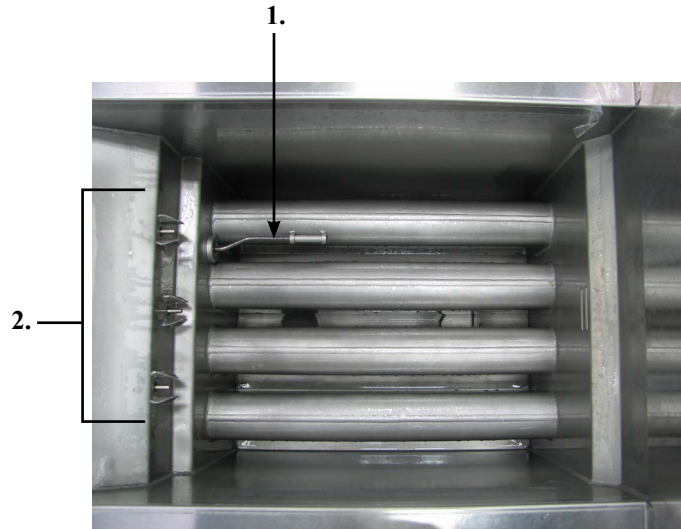

Item No.	Part No.	Description	Quantity
A 1	92717	THERMOCOUPLE- HIGH LIMIT .....	1/vat
2	87739	ASSY-PROBE .....	1/well

**EEG-164 Door Break Down**

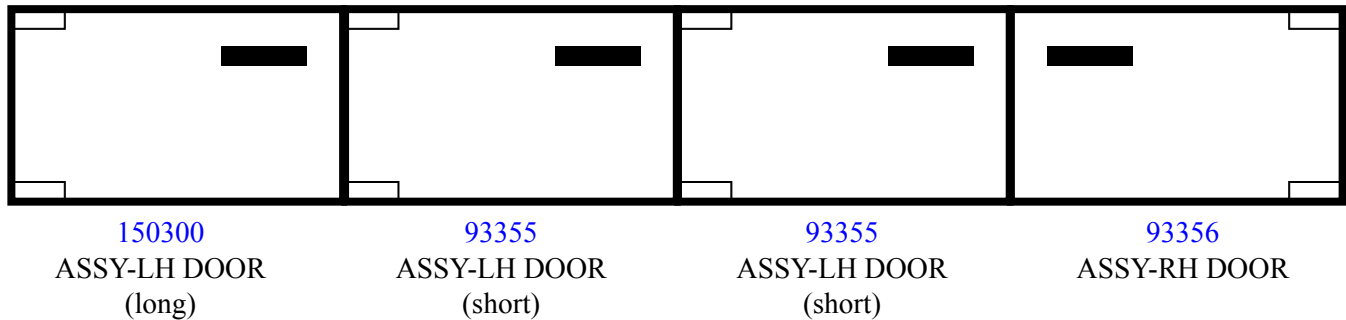

**EEG-163 Door Break Down**

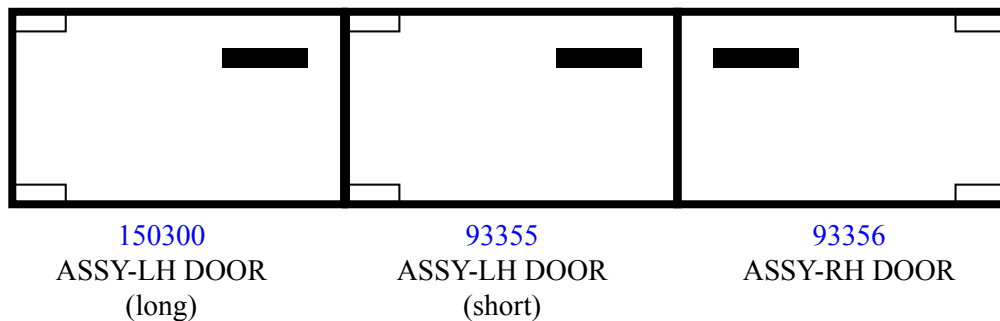

**Door Hinge Chart**

Door	Top Hinge (Door)	Bottom Hinge (Door)	Bottom Hinge (Frame)	Bushing
150300	93370	93369	150624	39752
93355	93370	93369	85409	39752
93355	93370	93369	85409	39752
93356	93369	93370	150625	39752

Recommend Parts: A=Truck Stock/B=Dist. Stock / \*not shown/ A/R=As Required

3.

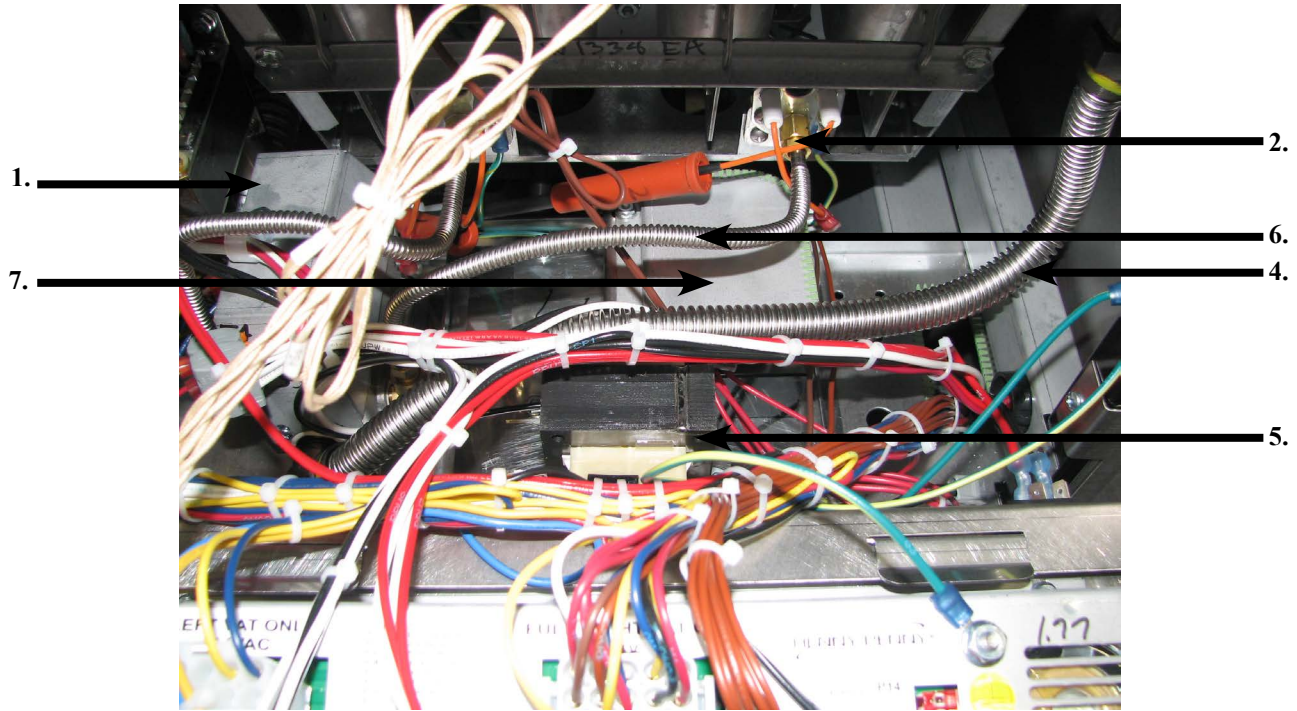
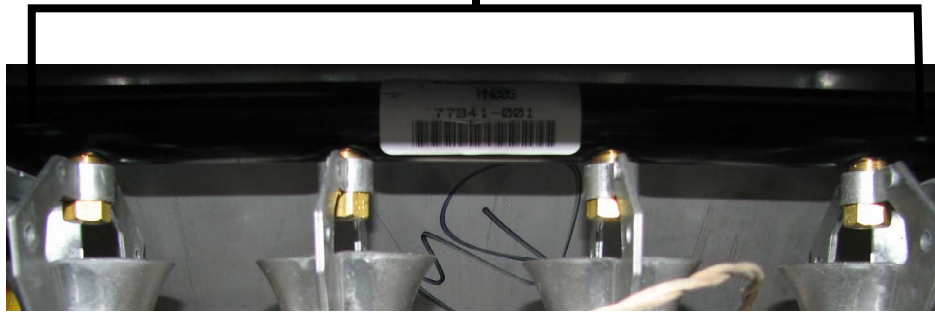

Item No.	Part No.	Description	Quantity
B 1	87648-001	ASSY-GAS VALVE FULL NAT .....	1/vat
B 1	87663-003	ASSY-GAS VALVE FULL LP .....	1/vat
2		PILOT KIT (See next page for kit numbers)	
2	153264-001	--INLET-FITTING PILOT ORIFICE (NAT) .....	1/vat
2	153264-002	--INLET-FITTING PILOT ORIFICE (LP) .....	1//vat
3	76921-001	ORIFICE - MAIN BURNER (NAT).....	4/burner
3	76921-002	ORIFICE - MAIN BURNER (LP).....	4/burner
4	-----	FLEX TUBE (see flex tube chart for length/part number).....	--
5	84391	ASSY-TRANSFORMER-120V .....	1/well
6	82491	TUBE-1/4 X 12 FLEX SS PILOT.....	1/ 2-well
7	89624-001	CONTROL-WATLOW HL .....	1/vat
8*	84987	SWITCH-HL .....	1/well
9*	76978	SENSOR-FLAME.....	1/vat

Recommend Parts: A=Truck Stock/B=Dist. Stock / \*not shown/ A/R=As Required

Kit Number	Description
140282	KIT-EEG16X OIL TST/BOILOUT PKT
<a href="#">140283</a>	KIT-EEG16X FRYER SUPPLY (Chili's)
<a href="#">140289</a>	KIT-REPL FULL POT ASSY-EEG2XX
140290	KIT-NAT TO LP F UP TO 5000 FT
140291	KIT-LP TO NAT F UP TO 5000 FT
140295	KIT-EEG16X FRYER SPLY-MAGGIANO
<a href="#">140296</a>	KIT-EEG16X/2XX NAT BASO PILOT
<a href="#">140297</a>	KIT-EEG16X/2XX LP BASO PILOT
<a href="#">140307</a>	KIT-EEG16X BULK DISPOSE/FILL

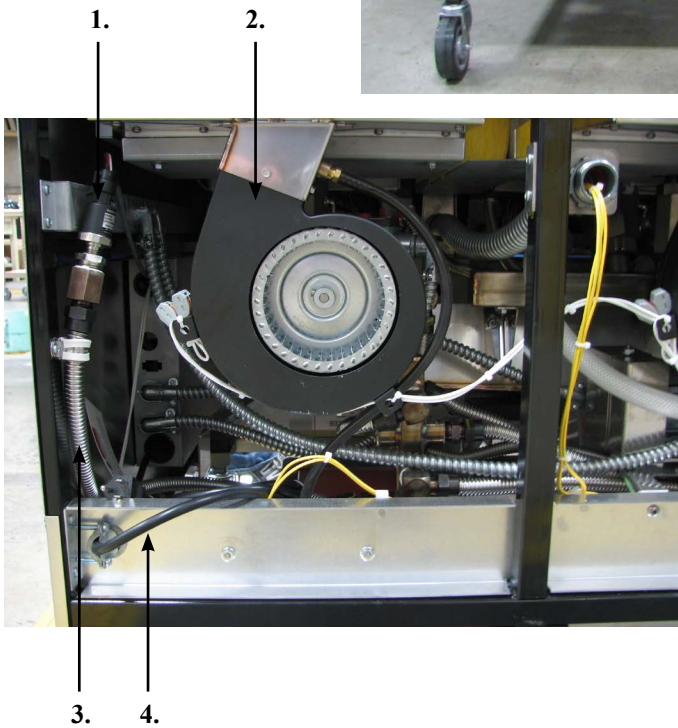

Item No.	Part No.	Description	Quantity
1	79213	TRANSDUCER-PRESSURE 30 PSI.....	1
2	92963-001	BLOWER MOTOR-FLUE EXHAUST 115V .....	1/well
3	-----	FLEX TUBE (see flex tube chart for length/part number).....	--
4	152902-001	CORD-POWER.....	1
5	151744	VALVE-120V SOLENOID 1/2NPT.....	1/vat
6*	151725	ASSY-POT CHECK VALVE .....	1/vat
7*	73473	PUMP-OIL TOP OFF 120V.....	1

Recommend Parts: A=Truck Stock/B=Dist. Stock / \*not shown/ A/R=As Required

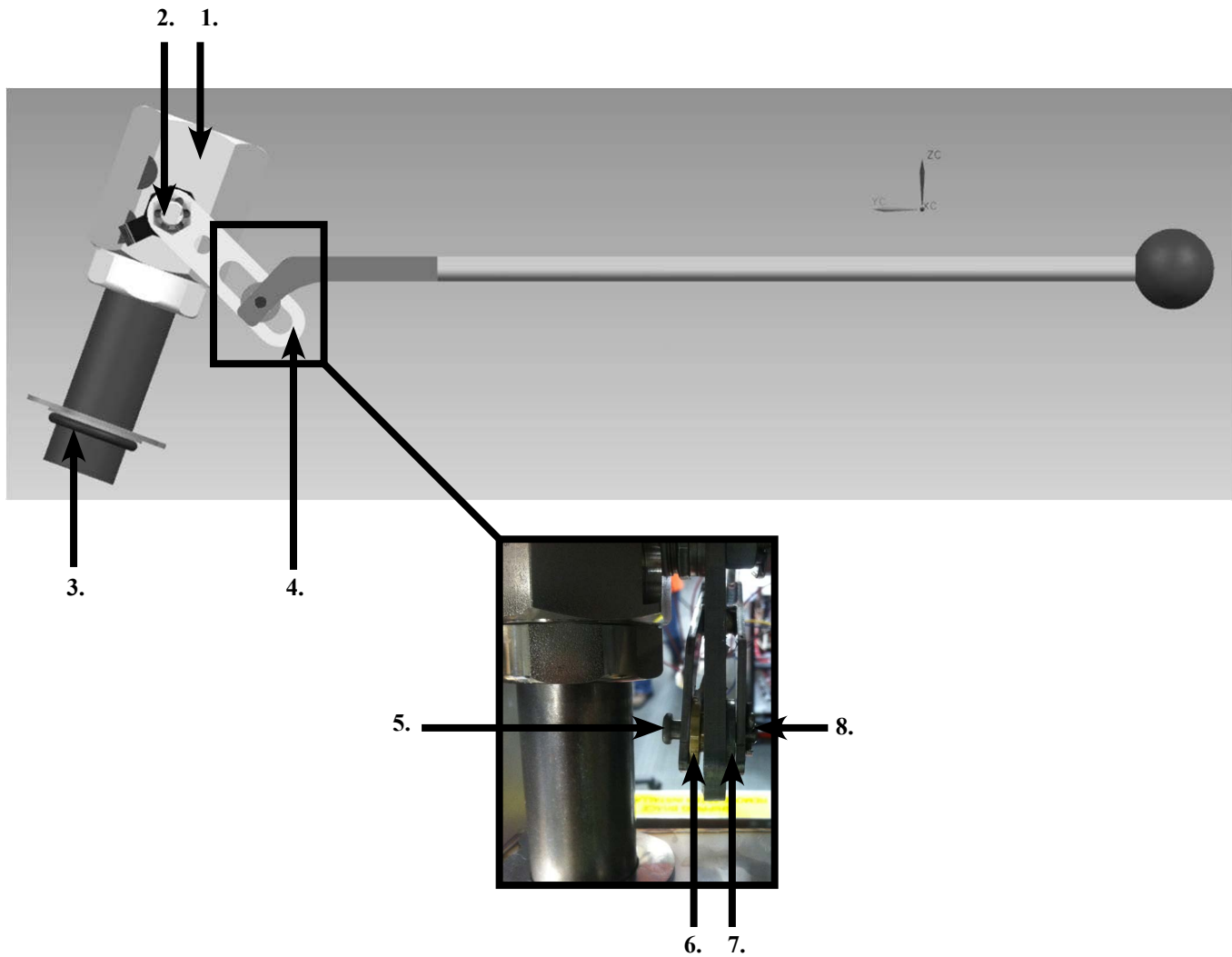

Item No.	Part No.	Description	Quantity
1	151727	VALVE-DRAIN 1 1/2 NPT & CAM LOCK.....	1/vat
2	NS03-103	NUT-CASTLE 1/2-20 18-8 STEEL .....	1/vat
	17255	--PIN-COTTER.....	1/vat
3	76948	O-RING -325.....	1/vat
4	151106	ARM-PIVOT .....	1/vat
5	PN01-012	CLEVIS PIN 1/4 X 1 IN. SS .....	1/vat
6	151156	PIVOT BUSHING ROD LINKAGE .....	1/vat
7	150181	SPACER-DRAIN ROD LINKAGE .....	1/vat
8	PN01-039	PIN-COTTER.....	1/vat
9*	50764	MICROSWITCH-RIGID LEVER .....	1/var

FLEX TUBE NUMBERS	
Part Number	Flex Tube Length (in.)
77523-001	12.0
77523-002	18.0
77523-003	24.0
77523-004	30.0
77523-005	36.0
77523-006	42.0
77523-007	48.0
77523-008	7.0
77523-009	13.0
77523-010	54.0
77523-011	10.0
77523-012	13.0
77523-013	14.0
77523-014	28.0
77523-015	32.0
77523-016	16.0

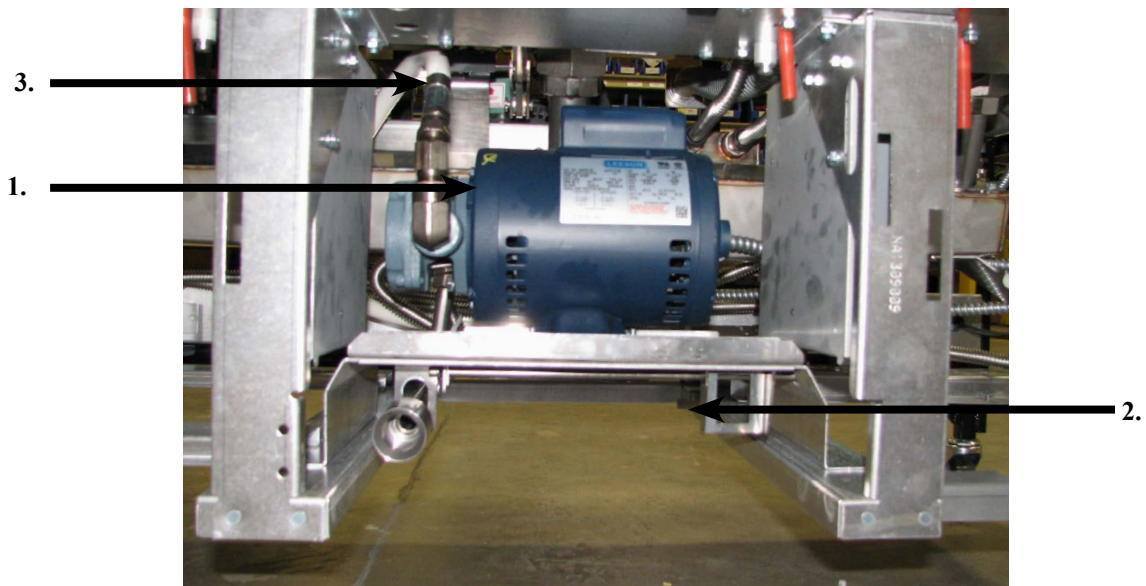

Item No.	Part No.	Description	Quantity
1	151534-001	ASSY-FILTER PUMP MOTOR EEG16X 60HZ.....	1
	67583	--MOTOR-1/2 HP FILTER PUMP.....	1
	17437	--ASSY-SUB PUMP 5 GPM.....	1
	17476	--SEAL KIT.....	1
2	87511	SWITCH-DRAIN PAN.....	1
3	151686-002	HOSE-OIL DISPOSE (34in).....	1
4*	90506-001	VALVE-CHECK SAE 12-3PSI.....	A/R
5*	FP01-256	FTG-12 SAE 1/2 NPT.....	A/R
6*	FP01-283	FTG-12 SAE 8 45 DEG FLARE SWVL.....	A/R

Recommend Parts: A=Truck Stock/B=Dist. Stock / \*not shown/ A/R=As Required

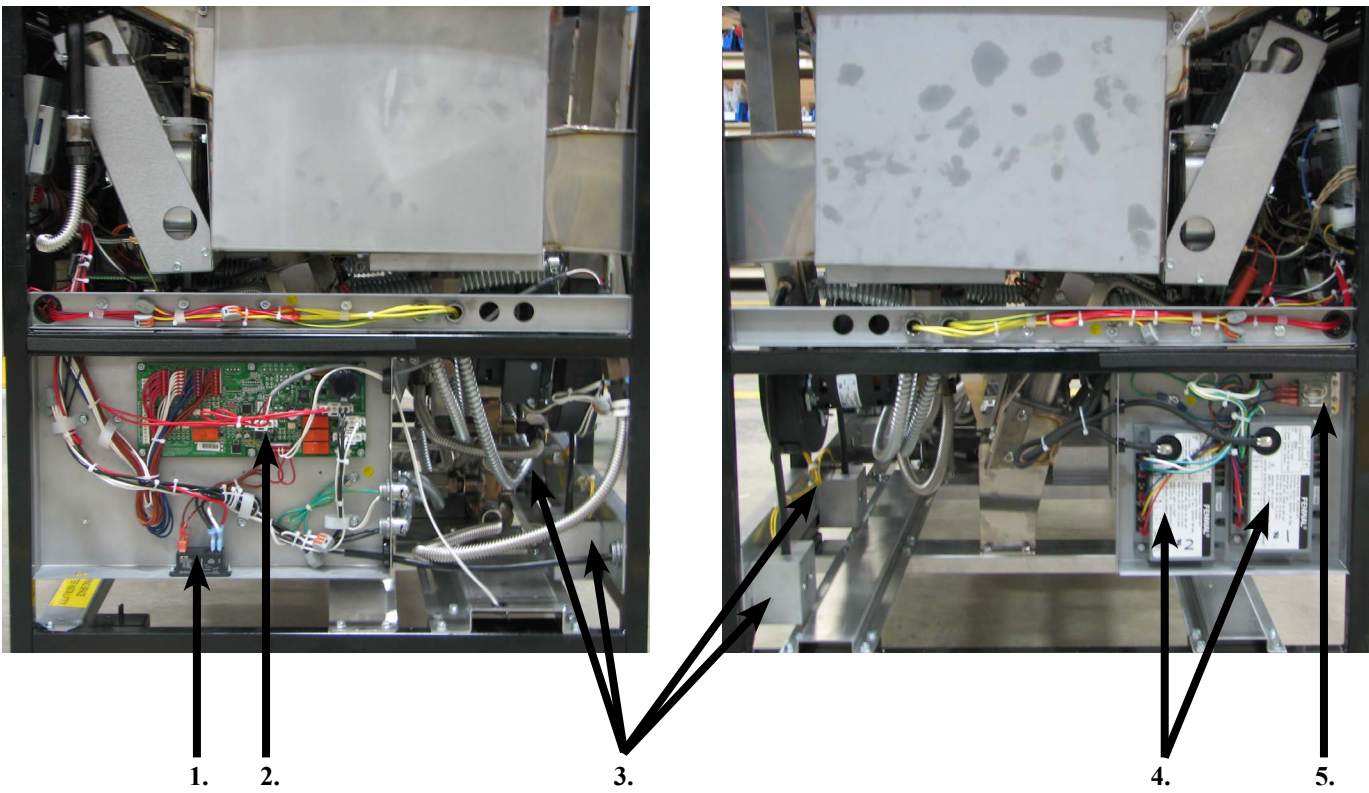

Item No.	Part No.	Description	Quantity
1	ME90-008	P&B T92 RELAY 12VDC COIL 30AMP.....	1
2	84454	ASSY-EVOLUTION ELITE AIF PCB.....	1
3	77992	SWITCH-PRESSURE 0.80.....	1/vat
4	77839	MODULE-IGNITION NON CE.....	2/well
5	60818	RELAY - 24VAC COIL.....	1/well

Recommend Parts: A=Truck Stock/B=Dist. Stock / \*not shown/ A/R=As Required



**Henny Penny Corporation**  
**P.O.Box 60**  
**Eaton, OH 45320**

**1-937-456-8400**  
**1-937-456-8402 Fax**

**Toll free in USA**  
**1-800-417-8417**  
**1-800-417-8434 Fax**

**[www.hennypenny.com](http://www.hennypenny.com)**

\* FMO" - 05\$ - @\* Henny Penny Corp., Eaton, Ohio 45320, Revised 8-25-14