

# SECTION 7: PARTS

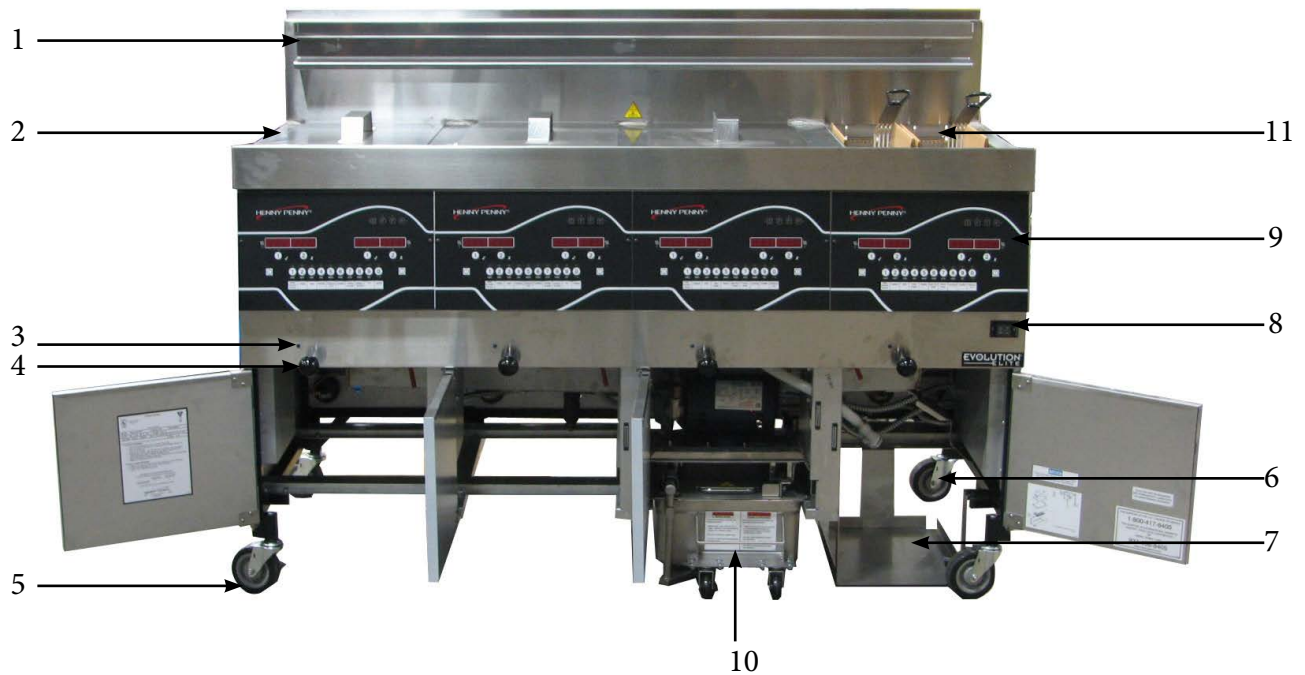

Item No.	Part No.	Description	Quantity
1	151171	WELD ASSY-WENDYS BASKET HANGER .....	1/ well
2	76555	WELD ASSY-COVER FULL .....	1/vat
3	81980	LED-5MM BLUE .....	1/vat
4	-----	DRAIN KNOB ASSEMBLY.....	1/vat
		--See DRAIN KNOB drawing for breakdown	
5	77575	CASTER-SWIVEL W/ BRAKE (front).....	2
6	77679	CASTER-SWIVEL W/O BRAKE (back).....	2
7	151704	STUD ASSY-JIB SHELF .....	1
8	52224	COVERED POWER SWITCH.....	1
9	82016RB	ASSY-EVOL/ELITE FRYER CONTROL.....	1/well
9	84417RB	ASSY-EVOLUTION ELITE AUTO CONT .....	1/well
10	152634	DRAIN PAN ASSY .....	1
11	81915	BASKET-1/2 SIZE BLK FRONT SUPP.....	A/R
11	85136	BASKET-FULL SIZE BLACK FR SPRT.....	A/R

Recommend Parts: A=Truck Stock/B=Dist. Stock / \*not shown/ A/R=As Required

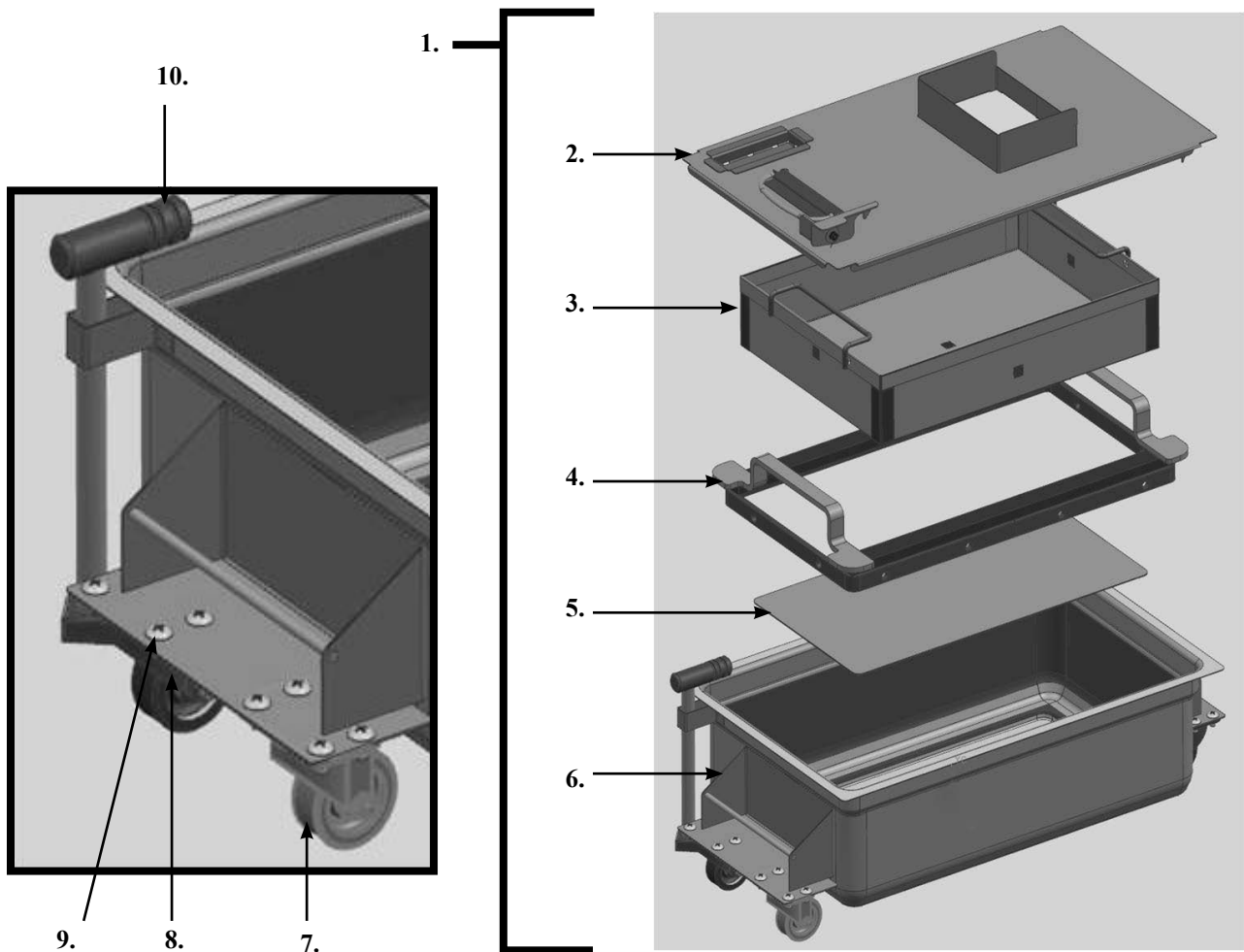

Item No.	Part No.	Description	Quantity
1	152634	ASSY-EEG-16X DRAIN PAN W/ CASTER.....	1
2	152635	--ASSY-EEG-16X DRAIN PAN COVER .....	1
3	85507	--WELD ASSY-CRUMB CATCHER .....	1
4	85503	--WELD ASSY-FILTER WEIGHT .....	1
5	85519	--FILTER SECTION .....	1
6	95842	--ASSY-DRAIN PAN .....	1
7	19004	----CASTER-SWIVEL 2IN .....	4
8	SC01-009	----SCREW 1/4-20 X 1/2 THD .....	4/wheel
9	NS04-005	----LOCKNUT1/4-20 .....	4/wheel
10	86349	O-RING-116 SUCTION LINE .....	3
11*	12074	SMART FILTERS (PAD) - 30 COUNT .....	1
11*	12076	SMART FILTERS (PAPER) .....	1

Recommend Parts: A=Truck Stock/B=Dist. Stock / \*not shown/ A/R=As Required

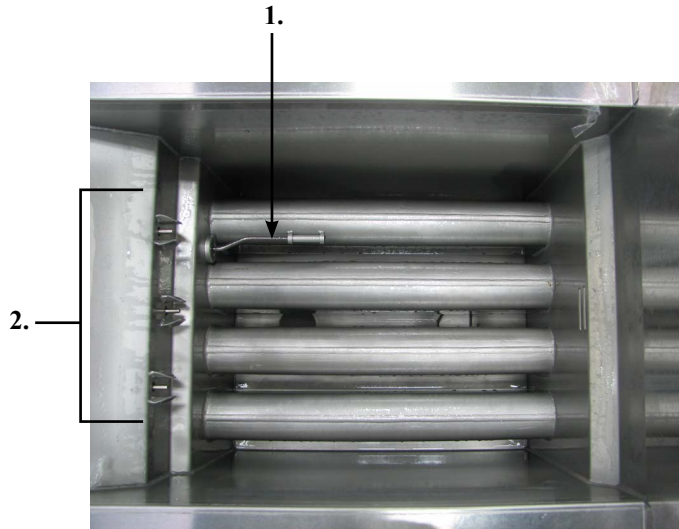

Item No.	Part No.	Description	Quantity
A 1	92717	THERMOCOUPLE- HIGH LIMIT .....	1/vat
2	87739	ASSY-PROBE .....	1/well

**EEG-164 Door Break Down**

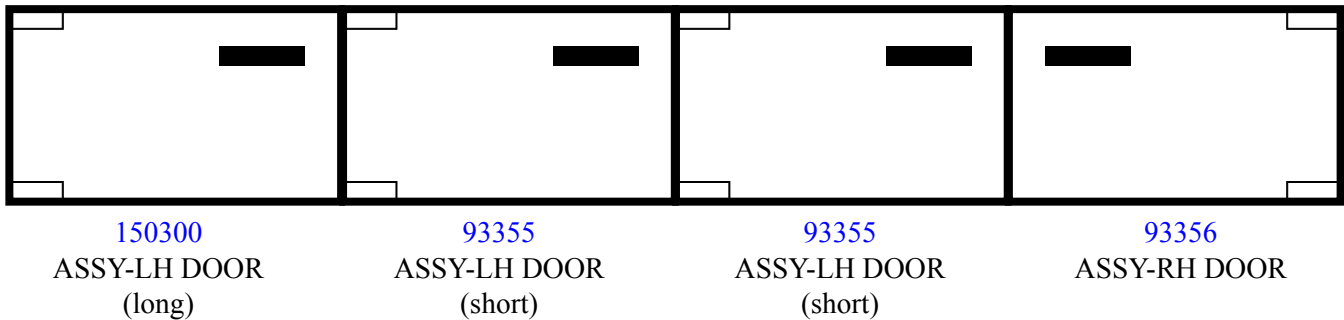

**EEG-163 Door Break Down**

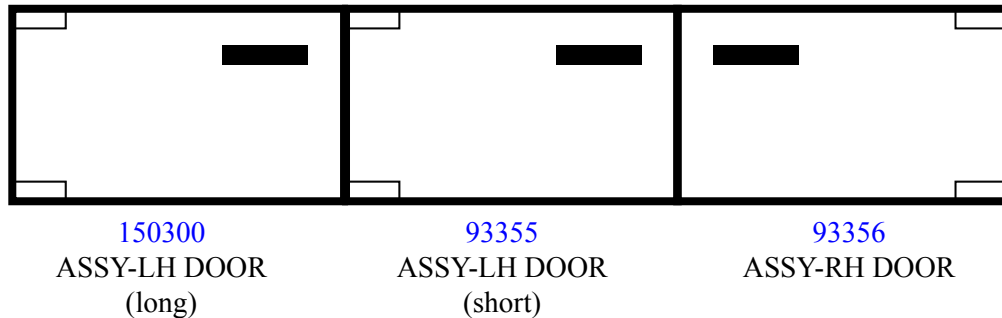

**Door Hinge Chart**

Door	Top Hinge (Door)	Bottom Hinge (Door)	Bottom Hinge (Frame)	Bushing
150300	93370	93369	150624	39752
93355	93370	93369	85409	39752
93355	93370	93369	85409	39752
93356	93369	93370	150625	39752

Recommend Parts: A=Truck Stock/B=Dist. Stock / \*not shown/ A/R=As Required

3.

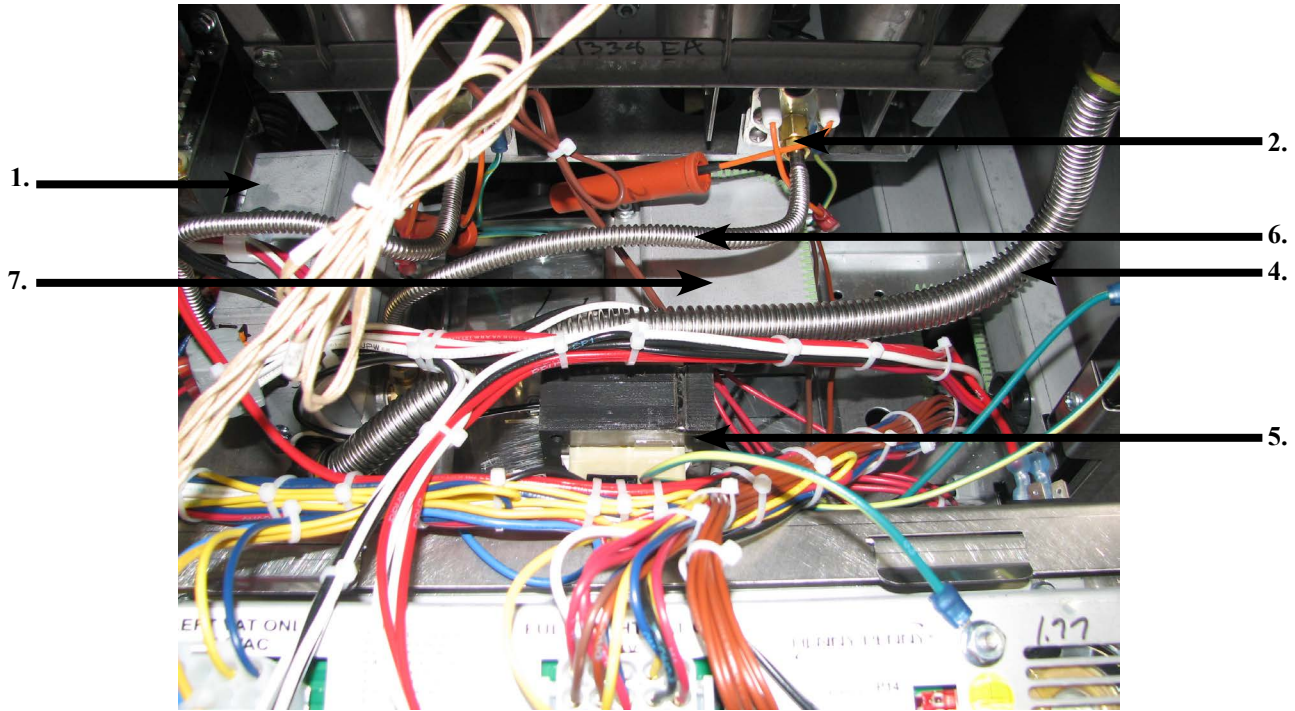

Item No.	Part No.	Description	Quantity
B 1	87648-001	ASSY-GAS VALVE FULL NAT .....	1/vat
B 1	87663-003	ASSY-GAS VALVE FULL LP .....	1/vat
2		PILOT KIT (See next page for kit numbers)	
2	153264-001	--INLET-FITTING PILOT ORIFICE (NAT).....	1/vat
2	153264-002	--INLET-FITTING PILOT ORIFICE (LP).....	1//vat
3	76921-001	ORIFICE - MAIN BURNER (NAT) .....	4/burner
3	76921-002	ORIFICE - MAIN BURNER (LP) .....	4/burner
4	-----	FLEX TUBE (see flex tube chart for length/part number).....	--
5	84391	ASSY-TRANSFORMER-120V.....	1/well
5	83977	TRANSFORMER-208/240 50/60 75VA .....	1/well
5	84135	ASSY-24V/240V 75VA TRANSFORMER .....	1/well
5	83976	TRANSFORMER-120V 50/60HZ 75VA .....	1/well
6	82491	TUBE-1/4 X 12 FLEX SS PILOT .....	1/ 2-well
7	89624-001	CONTROL-WATLOW HL.....	1/vat
7	89624-002	CONTROL-WATLOW HIGH LIMIT 230V .....	1/well
8*	84987	SWITCH-HL.....	1/well
9*	76978	SENSOR-FLAME .....	1/vat

Recommend Parts: A=Truck Stock/B=Dist. Stock / \*not shown/ A/R=As Required

Kit Number	Description
140282	KIT-EEG16X OIL TST/BOILOUT PKT
<a href="#">140283</a>	KIT-EEG16X FRYER SUPPLY (Chili's)
<a href="#">140289</a>	KIT-REPL FULL POT ASSY-EEG2XX
140290	KIT-NAT TO LP F UP TO 5000 FT
140291	KIT-LP TO NAT F UP TO 5000 FT
140295	KIT-EEG16X FRYER SPLY-MAGGIANO
<a href="#">140296</a>	KIT-EEG16X/2XX NAT BASO PILOT
<a href="#">140297</a>	KIT-EEG16X/2XX LP BASO PILOT
<a href="#">140307</a>	KIT-EEG16X BULK DISPOSE/FILL

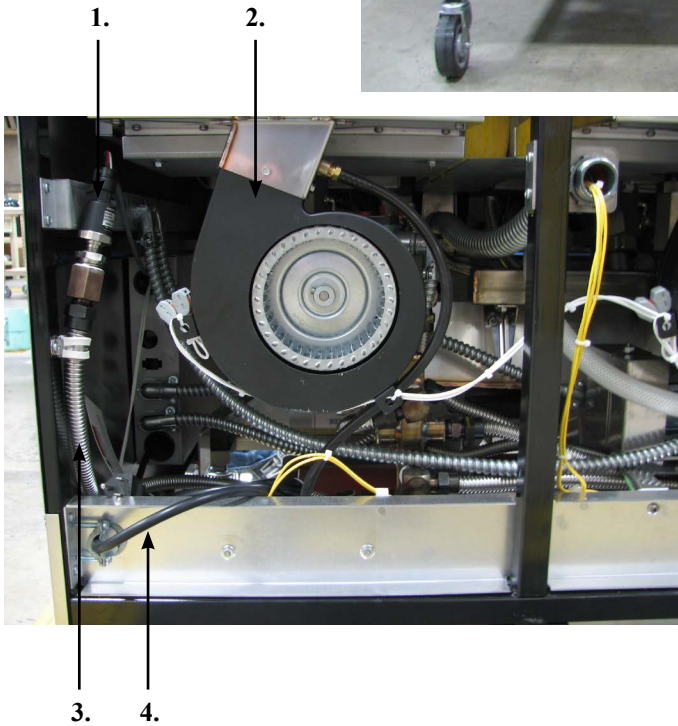

Item No.	Part No.	Description	Quantity
1	79213	TRANSDUCER-PRESSURE 30 PSI.....	1
2	92963-001	BLOWER MOTOR-FLUE EXHAUST 115V.....	1/well
2	92963-002	BLOWER MOTOR-FLUE EXHAUST 230V.....	1/well
3	-----	FLEX TUBE (see flex tube chart for length/part number).....	--
4	152902-001	CORD-POWER.....	1
5	151744	VALVE-120V SOLENOID 1/2NPT.....	1/vat
6*	151725	ASSY-POT CHECK VALVE.....	1/vat
7*	73473	PUMP-OIL TOP OFF 120V.....	1
7*	74583	PUMP-OIL TOP OFF 230V.....	1

Recommend Parts: A=Truck Stock/B=Dist. Stock / \*not shown/ A/R=As Required

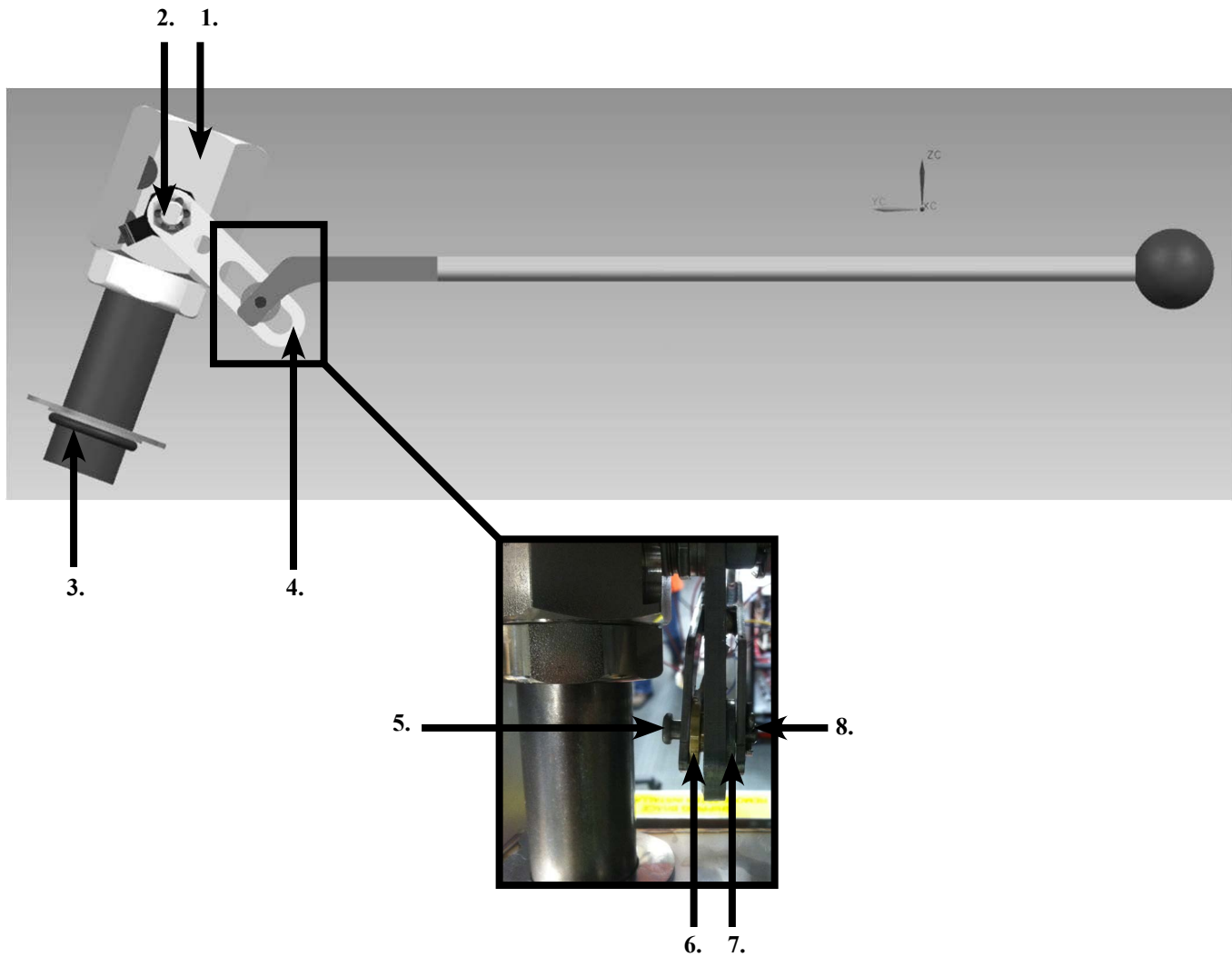

Item No.	Part No.	Description	Quantity
1	151727	VALVE-DRAIN 1 1/2 NPT & CAM LOCK.....	1/vat
2	NS03-103	NUT-CASTLE 1/2-20 18-8 STEEL .....	1/vat
	17255	--PIN-COTTER.....	1/vat
3	76948	O-RING -325.....	1/vat
4	151106	ARM-PIVOT .....	1/vat
5	PN01-012	CLEVIS PIN 1/4 X 1 IN. SS .....	1/vat
6	151156	PIVOT BUSHING ROD LINKAGE .....	1/vat
7	150181	SPACER-DRAIN ROD LINKAGE .....	1/vat
8	PN01-039	PIN-COTTER.....	1/vat
9*	50764	MICROSWITCH-RIGID LEVER .....	1/var

FLEX TUBE NUMBERS	
Part Number	Flex Tube Length (in.)
77523-001	12.0
77523-002	18.0
77523-003	24.0
77523-004	30.0
77523-005	36.0
77523-006	42.0
77523-007	48.0
77523-008	7.0
77523-009	13.0
77523-010	54.0
77523-011	10.0
77523-012	13.0
77523-013	14.0
77523-014	28.0
77523-015	32.0
77523-016	16.0

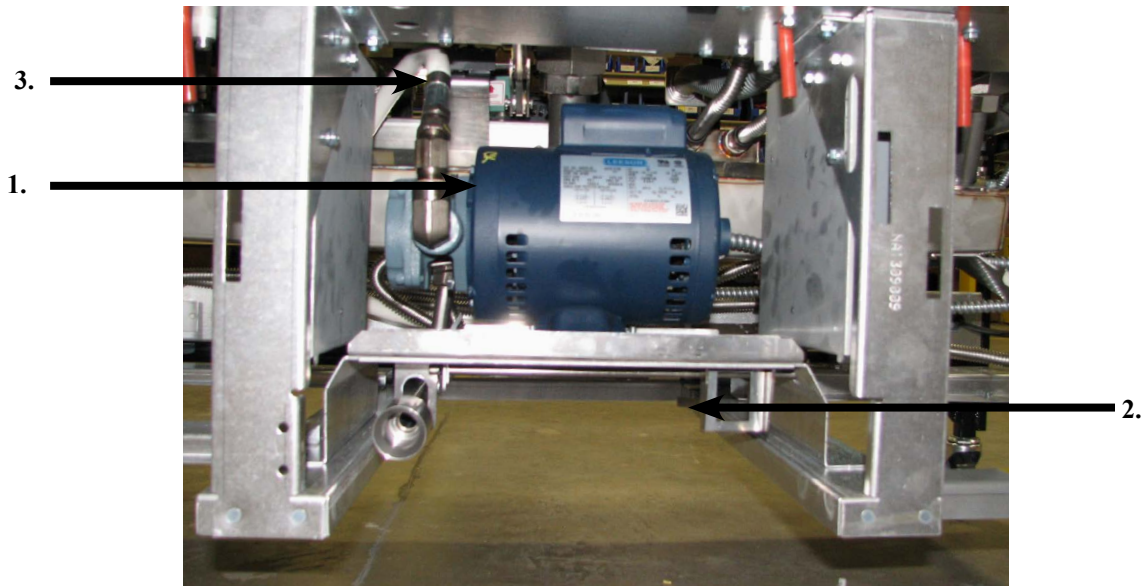

Item No.	Part No.	Description	Quantity
1	-----	(See next page for part breakdown)	
2	87511	SWITCH-DRAIN PAN .....	1
3	151686-002	HOSE-OIL DISPOSE (34in).....	1
4*	90506-001	VALVE-CHECK SAE 12-3PSI.....	A/R
5*	FP01-256	FTG-12 SAE 1/2 NPT .....	A/R
6*	FP01-283	FTG-12 SAE 8 45 DEG FLARE SWVL.....	A/R

Recommend Parts: A=Truck Stock/B=Dist. Stock / \*not shown/ A/R=As Required

Item No.	Part No.	Description	Quantity
1	151534-001	ASSY-FILTER PUMP MOTOR EEG16X 60HZ.....	1
	67583	--MOTOR-1/2 HP FILTER PUMP.....	1
	17437	--ASSY-SUB PUMP 5 GPM.....	1
	17476	--SEAL KIT.....	1
1	151534-002	ASSY-FILTER PUMP MOTOR EEG16X 60HZ.....	1
	92850	--MOTOR-1/2 HP FILTER PUMP 50HZ .....	1
	17437	--ASSY-SUB PUMP 5 GPM.....	1
	17476	--SEAL KIT.....	1

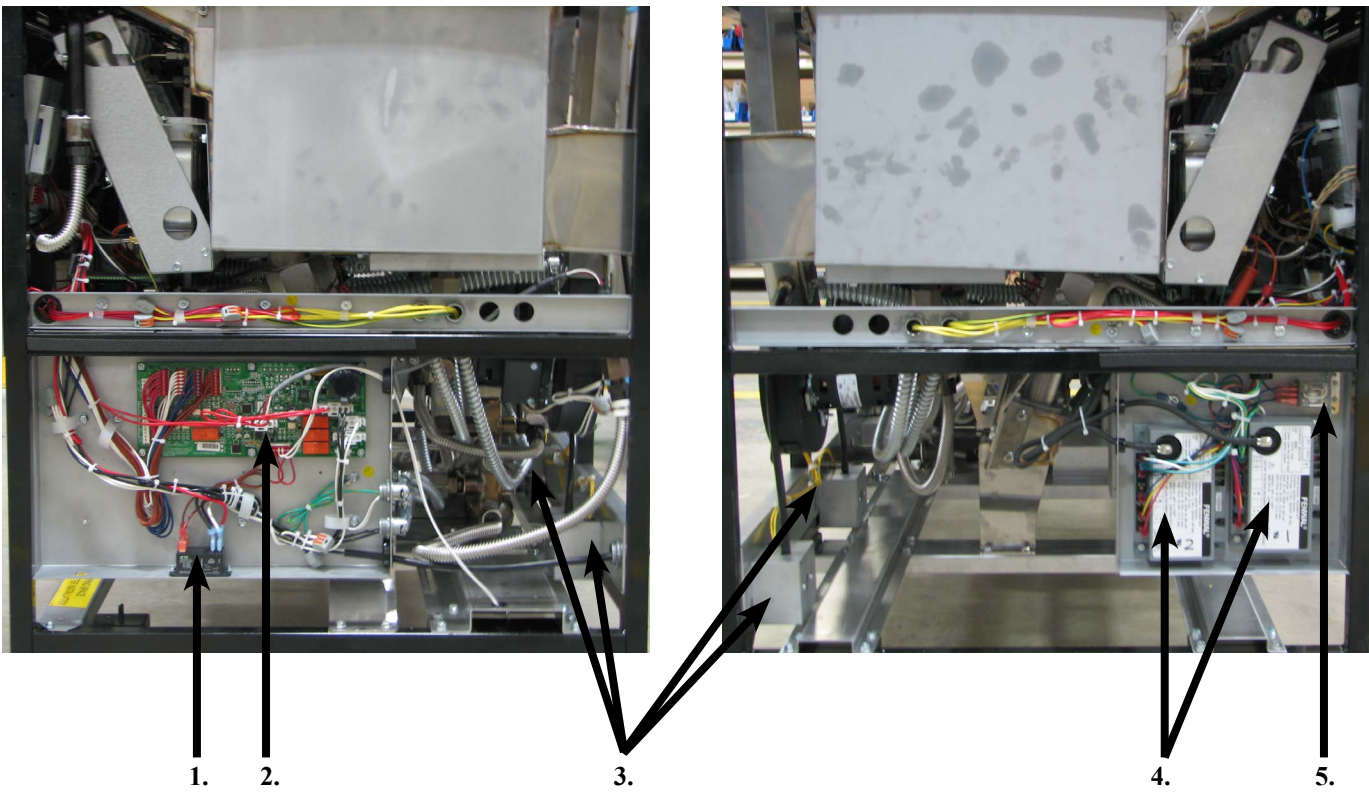

Item No.	Part No.	Description	Quantity
1	ME90-008	P&B T92 RELAY 12VDC COIL 30AMP.....	1
1	ME90-005	RELAY 12V OC COIL SPDT.....	1
2	84454RB	ASSY-EVOLUTION ELITE AIF PCB.....	1
3	77992	SWITCH-PRESSURE 0.80.....	1/vat
4	77839	MODULE-IGNITION NON CE.....	2/well
5	60818	RELAY - 24VAC COIL.....	1/well

Recommend Parts: A=Truck Stock/B=Dist. Stock / \*not shown/ A/R=As Required