

**Henny Penny**  
**Evolution Elite™**

**Reduced Oil Capacity Open Fryers**  
**(Split Vat & Full Vat– Gas)**

**Model EEG-142**

**Model EEG-143**

**Model EEG-144**

**TECHNICAL MANUAL**



**TABLE OF CONTENTS**

<b>Section</b>	<b>Page</b>
Section 1. TROUBLESHOOTING.....	1-1
1-1 Introduction .....	1-1
1-2 Safety .....	1-1
1-3 Troubleshooting.....	1-2
1-4 Error Code Table .....	1-7
Section 2. INFO & FILTER BUTTON STATS.....	2-1
2-1 INFO Button Stats .....	2-1
2-2 FILTER Button Stats .....	2-1
Section 3. INFORMATION MODE.....	3-1
3-1 Information Mode Details .....	3-1
Section 4. Product Program Mode .....	4-1
4-1 Modifying Product Settings.....	4-1
Section 5. LEVEL 2 PROGRAMMING .....	5-1
5-1 Special Program Mode .....	5-1
5-2 Clock Set .....	5-10
5-3 Data Logging, Heat Control, Tech, Stat & Filter Control Modes .....	5-10
5-4 Tech Mode .....	5-11
5-5 Stats Mode .....	5-17
Section 6. MAINTENANCE SECTION.....	6-1
6-1 Introduction.....	6-1
6-2 Maintenance Hints .....	6-1
6-3 Preventive Maintenance.....	6-1
6-4 Control Panel and Menu Card Replacement.....	6-2
6-5 High Temperature Limit Control .....	6-3
6-6 Main Power switch.....	6-5
6-7 Probe Replacement .....	6-6

**TABLE OF CONTENTS**

<b>Section</b>	<b>Page</b>
Section 6. MAINTENANCE SECTION (Continued)	
6-8 Solenoid Valves .....	6-9
6-9 Oil Channel Clean-Out .....	6-11
6-10 Filter Pump & Motor .....	6-12
6-11 JIB Pump .....	6-14
6-12 Express Filter PC Board .....	6-14
6-13 Transformers .....	6-15
6-14 Filter Motor Relay .....	6-16
6-15 Gas Control Valves .....	6-16
6-16 Blower Motor .....	6-18
6-17 Drain Pan Switch .....	6-19
6-18 Filter Beacon .....	6-20
6-19 Air Pressure Switches .....	6-21
6-20 Ignitor & Flame Sensor Assembly .....	6-22
6-21 Ignition Modules .....	6-23
6-22 Pressure Transducer .....	6-24
Wiring Diagrams & Schematics	
Section 7. PARTS SECTION	
7-1 Introduction .....	7-1
7-2 Genuine Parts .....	7-1
7-3 How To Order .....	7-1
7-4 Prices .....	7-1
7-5 Delivery .....	7-1
7-6 Warranty .....	7-1

## SECTION 1. TROUBLESHOOTING

### 1-1. INTRODUCTION

This section provides troubleshooting information in the form of an easy to read table.

If a problem occurs during the first operation of a new fryer, recheck the installation per the Installation Section of this manual.

Before troubleshooting, always recheck the operation procedures per Section 3 of this manual.

### 1-2. SAFETY

Where information is of particular importance or safety related, the words DANGER, WARNING, CAUTION, and NOTICE are used. Their usage is described below.



SAFETY ALERT SYMBOL is used with DANGER, WARNING, or CAUTION which indicates a personal injury type hazard.



NOTICE is used to highlight especially important information.



*CAUTION used without the safety alert symbol indicates a potentially hazardous situation which, if not avoided, may result in property damage.*



*CAUTION indicates a potentially hazardous situation which, if not avoided, may result in minor or moderate injury.*



**WARNING indicates a potentially hazardous situation which, if not avoided, could result in death or serious injury.**



**DANGER INDICATES AN IMMINENTLY HAZARDOUS SITUATION WHICH, IF NOT AVOIDED, WILL RESULT IN DEATH OR SERIOUS INJURY.**

### **1-3. TROUBLESHOOTING**

To isolate a malfunction, proceed as follows:

1. Clearly define the problem (or symptom) and when it occurs.
2. Locate the problem in the Troubleshooting table.
3. Review all possible causes. Then, one-at-a-time work through the list of corrections until the problem is solved.
4. Refer to the maintenance procedures in the Maintenance Section to safely and properly make the checkout and repair needed.



**If maintenance procedures are not followed correctly, injuries and/or property damage could result.**

**7-1. TROUBLE SHOOTING**  
**(Continued)**

<b>Problem</b>	<b>Cause</b>	<b>Correction</b>
POWER switch ON but fryer completely inoperative	<ul style="list-style-type: none"> <li>Open circuit</li> </ul>	<ul style="list-style-type: none"> <li>Plug fryer in</li> <li>Check breaker or fuse at supply box</li> </ul>
Control error code “E-10”	<ul style="list-style-type: none"> <li>Oil temperature too high</li> </ul>	<ul style="list-style-type: none"> <li>Let unit cool down (15-20 minutes), push up on metal reset button under right side of the controls; if high limit does not reset, high limit must be replaced</li> </ul> 
Vat is under-filled	<ul style="list-style-type: none"> <li>JIB is low or empty</li> <li>JIB oil line is clogged or collapsed</li> <li>Filter pan needs cleaned</li> </ul>	<ul style="list-style-type: none"> <li>Fill the JIB</li> <li>Check JIB line</li> <li>Clean filter pan and change paper or pad</li> </ul>

**7-1. TROUBLE SHOOTING**  
**(Continued)**

<b>Problem</b>	<b>Cause</b>	<b>Correction</b>
Oil foaming or boiling over top of vat	<ul style="list-style-type: none"> <li>• Water in oil</li> <li>• Improper or bad oil</li> <li>• Improper filtering</li> <li>• Improper rinsing after cleaning the vat</li> </ul>	<ul style="list-style-type: none"> <li>• Drain and clean oil</li> <li>• Use recommended oil</li> <li>• Refer to filtering procedures</li> <li>• Clean and rinse vat and then dry thoroughly</li> </ul>
Oil will not drain from vat	<ul style="list-style-type: none"> <li>• Drain valve clogged with crumbs</li> <li>• Drain trough clogged</li> </ul>	<ul style="list-style-type: none"> <li>• Open valve, force cleaning brush through drain</li> <li>• Remove right side panel and remove plug from end of trough and clean trough</li> </ul>
Filter motor runs but pumps oil slowly	<ul style="list-style-type: none"> <li>• Filter line connections loose</li> <li>• Filter paper or pad clogged</li> <li>• Filter not reassembled correctly</li> </ul>	<ul style="list-style-type: none"> <li>• Tighten all filter line connections</li> <li>• Change filter paper or pad</li> <li>• Refer to assembly instructions on inside door</li> </ul>
Bubbles in oil during entire filtering process	<ul style="list-style-type: none"> <li>• Filter pan not completely engaged</li> <li>• Filter pan clogged</li> <li>• Damaged O-ring on filter line receiver on fryer</li> </ul>	<ul style="list-style-type: none"> <li>• Make sure filter pan return line is pushed completely into the receiver on the fryer</li> <li>• Clean pan and change paper or pad</li> <li>• Change O-ring</li> </ul>
Filter motor will not run	<ul style="list-style-type: none"> <li>• The thermal reset button on the rear of the pump motor is tripped</li> </ul> <div data-bbox="500 1125 873 1251" data-label="Image"> </div> <p><b>To prevent burns caused by splashing shortening, turn the unit's POWER switch to the OFF position before resetting the filter pump motor's manual reset protection device.</b></p>	<ul style="list-style-type: none"> <li>• Remove the right side panel and allow time for the motor to cool and then, using a screwdriver, press hard against the button until it clicks</li> </ul> <div data-bbox="932 1173 1466 1572" data-label="Image"> </div>

**1-4. ERROR CODES**

In the event of a control system failure, the digital display shows an error message. The message codes are shown in the DISPLAY column below. A constant tone is heard when an error code is displayed, and to silence this tone, press any button.

<b><u>DISPLAY</u></b>	<b><u>CAUSE</u></b>	<b><u>CORRECTION</u></b>
"E-4"	<ul style="list-style-type: none"> <li>Control board overheating</li> </ul>	Turn switch to OFF position, then turn switch back to ON; if display shows "E-4", the control board is getting too hot; check the louvers on each side of the unit for obstructions
"E-5"	<ul style="list-style-type: none"> <li>Oil overheating</li> </ul>	Turn switch to OFF position, then turn switch back to ON; if display shows "E-5", the heating circuits and temperature probe should be checked
"E-6A"	<ul style="list-style-type: none"> <li>Temperature probe open</li> </ul>	Turn switch to OFF position, then turn switch back to ON; if display shows "E-6A", the temperature probe should be checked
"E-6B"	<ul style="list-style-type: none"> <li>Temperature probe shorted</li> </ul>	Turn switch to OFF position, then turn switch back to ON; if display shows "E-6B", the temperature probe should be checked
"E-10"	<ul style="list-style-type: none"> <li>Hight limit</li> </ul>	Let unit cool down (15-20 minutes), push up on metal reset button under right side of the controls; if high limit does not reset, high limit must be replaced
		
"E-15"	<ul style="list-style-type: none"> <li>Drain switch</li> </ul>	Make sure drain knob is completely pushed-in, if E-15 persists, have drain switch checked
"E-18-A" "E-18-B" "E-18-C"	<ul style="list-style-type: none"> <li>LH level sensor open</li> <li>RH level sensor open</li> <li>Both sensors open</li> </ul>	Turn switch to OFF position, then turn switch back to ON; if display still indicates a failed sensor, have the connectors checked at the control board; have sensor checked & replace if necessary

**1-4. ERROR CODES (Continued)**

<p>“E-20-A” “FAN SENSOR STUCK CLOSED”</p>	<ul style="list-style-type: none"> <li>• Pressure Switch failure</li> <li>• Wiring problem</li> <li>• I/O board failure</li> </ul>	<ul style="list-style-type: none"> <li>• If fan is not running, have pressure switch checked; should be open circuit if no air pressure</li> <li>• If fan is running, wiring error, or relay on I/O board closed</li> </ul>
<p>“E-20-B” “NO DRAFT” “CHECK FAN”</p>	<ul style="list-style-type: none"> <li>• Pressure switch failure/ hose loose</li> <li>• Draft fan failure/ low voltage</li> <li>• Flue or hood obstruction</li> </ul>	<ul style="list-style-type: none"> <li>• Press power button to vat off and back on again, if E-20-B persists, have pressure switch checked; should be open circuit if no air pressure; make sure hose is connected to fan and pressure switch</li> <li>• Have draft fan checked; low voltage going to fan</li> <li>• Check the fryer flue and hood system for obstructions</li> </ul>
<p>“E-20-D” IGNITION FAILURE”</p>	<ul style="list-style-type: none"> <li>• Failure to ignite/ no flame sense</li> </ul>	<ul style="list-style-type: none"> <li>• Press power button to vat off and back on again, if E-20-D persists, check gas line connections; check gas shut-off valve; have ignition module checked; gas valve checked; flame sensor gap checked; gas valve and ignition module wiring checked</li> </ul>
<p>“E-21”</p>	<ul style="list-style-type: none"> <li>• Slow heat recovery</li> </ul>	<ul style="list-style-type: none"> <li>• Have a certified service technician check the fryer for correct voltage to the unit; have heat circuit checked; have unit checked for loose or burnt wire</li> </ul>
<p>“E-22” “NO HEAT” “CHECK GAS VALVE”</p>	<ul style="list-style-type: none"> <li>• Burner not igniting</li> </ul>	<ul style="list-style-type: none"> <li>• Have gas valve and heat circuit checked</li> </ul>
<p>“E-41 “ / “E-46”</p>	<ul style="list-style-type: none"> <li>• Programming failure</li> </ul>	<ul style="list-style-type: none"> <li>• Press power button to vat off and back on again, if any of the error codes, have the controls re-initialized; if error code persists, have the control board replaced</li> </ul>
<p>“E-47”</p>	<ul style="list-style-type: none"> <li>• Analog converter chip or 12 volt supply failure</li> </ul>	<ul style="list-style-type: none"> <li>• Press power button to vat off and back on again, if “E-47” persists, have the I/O board, or the PC board replaced; if speaker tones are quiet, probably I/O board failure; have the I/O board replaced</li> </ul>
<p>“E-48”</p>	<ul style="list-style-type: none"> <li>• Input system error</li> </ul>	<ul style="list-style-type: none"> <li>• Have PC board replaced</li> </ul>
<p>“E-54-C”</p>	<ul style="list-style-type: none"> <li>• Temperature input error</li> </ul>	<ul style="list-style-type: none"> <li>• Turn switch to OFF, then back to ON; have control PC board replaced if “E-54C” persists</li> </ul>
<p>“E-60” “FILTER IN USE”</p>	<ul style="list-style-type: none"> <li>• AIF PC board not communicating with control PC board</li> </ul>	<ul style="list-style-type: none"> <li>• Press power button to turn vat off, wait 15 seconds, and turn back on again. If “E-60” persists, have connector between the PC boards checked; replace AIF PC board or control PC board, if necessary</li> </ul>
<p>“E-70C”</p>	<ul style="list-style-type: none"> <li>• Drain valve jumper wire missing or disconnected</li> </ul>	<ul style="list-style-type: none"> <li>• Have the jumper wire checked on the PC board at drain switch interlock position</li> </ul>
<p>“E-83-A”</p>	<ul style="list-style-type: none"> <li>• Pressure too high</li> </ul>	<ul style="list-style-type: none"> <li>• Check filter system in Vat #1</li> </ul>

**1-4. ERROR CODES (Continued)**

“E-83-B”	<ul style="list-style-type: none"> <li>• Pressure too high</li> </ul>	<ul style="list-style-type: none"> <li>• Check filter system in Vat #2</li> </ul>
“E-83-C”	<ul style="list-style-type: none"> <li>• Pressure too high</li> </ul>	<ul style="list-style-type: none"> <li>• Check filter system in Vat #3</li> </ul>
“E-83-D”	<ul style="list-style-type: none"> <li>• Pressure too high</li> </ul>	<ul style="list-style-type: none"> <li>• Check filter system in Vat #4</li> </ul>
“E-83-E”	<ul style="list-style-type: none"> <li>• Pressure too high</li> </ul>	<ul style="list-style-type: none"> <li>• Check filter system in Vat #5</li> </ul>
“E-83-J”	<ul style="list-style-type: none"> <li>• Bulk JIB FILL switch ON when pressure too high</li> </ul>	<ul style="list-style-type: none"> <li>• Check JIB fill valves</li> </ul>
“E-83-R”	<ul style="list-style-type: none"> <li>• Bulk Dispose switch ON when pressure too high</li> </ul>	<ul style="list-style-type: none"> <li>• Check Bulk Dispose quick-disconnect behind fryer</li> </ul>
“E-93-1” “24 VDC SUPPLY TRIPPED”	<ul style="list-style-type: none"> <li>• Autolift motor malfunction or failure</li> </ul>	<ul style="list-style-type: none"> <li>• If AutoLift feature is not operating, have each of the AutoLift motors checked.</li> </ul>

## SECTION 2. INFO & FILTER BUTTON STATS

### 2-1. INFO BUTTON STATS

#### Actual Oil Temperature

1. Press  and the actual oil temperature shows in the display, for each vat.

#### Set-point Temperature

1. Press  twice and SP shows in the display, along with the set-point (preset) temperature of each vat.

#### Recovery Information for each Vat

1. Press  3 times and REC shows in the left display and the recovery time that oil temperature went from 250°F (121°C) to 300°F (149°C) shows in the right display. For example, 

REC	5:30
-----	------

 means it took 5 minutes and

30 seconds for the oil temperature to recover to 300°F (149°C) from 250°F (121°C).

### NOTICE

If no buttons are pressed within 5 seconds in any of stats modes, the controls revert back to normal operation.

### 2-2. FILTER BUTTON STATS

#### Cook Cycles Remaining before Filtering

1. Press and release either  button and the left display shows “COOKSREMAINING” and the right display shows the number of cook cycles before the next auto filter. For example, 

REMA	INING	3	6
------	-------	---	---

means after 3 more cook cycles on the left vat, the controls asks the operator if they are ready to filter or not. But, 6 more cook cycles remain on the right vat.

#### Time and Date

2. Press either  twice and ‘FILTERED’ shows in the diplays, along with the time-of-day and date of the last filter.

## SECTION 3. INFORMATION MODE

This historic information can be recorded and used for operational and technical help and allows you to view the following:



- 1. E-LOG
- 2. LAST LOAD
- 3. DAILY STATS
- 4. OIL STATS
- 5. REVIEW USAGE
- 6. INPUTS
- 7. OUTPUTS
- 8. OIL TEMP
- 9. CPU TEMP
- 10. COMMUNICATION INFO
- 11. ANALOG INFO
- 12. ACTIVITY LOG
- 13. OIL LEVELS
- 14. PUMP VALVE INFO
- 15. AIF INFO

### NOTICE

Not all Information Mode functions are discussed in this section. To ensure proper operation of fryer, please consult Henny Penny Corp. before changing any of these settings. For more information on these functions, contact Technical Support at 1-800-417- 8405, or 1-937-456-8405.

### 3-1. INFORMATION MODE DETAILS

#### 1. E-LOG (error code log)

Press  and  buttons at the same time and “\*INFO MODE\*” shows in the display, followed by “1. E-LOG”.

### NOTICE

Press  and  to exit Information Mode at any time.

Press  and “A. (date & time) \*NOW\* show in displays. This is the present date and time.

Press  and if a error was recorded, “B. (date, time, and error code information)” shows in display. This is the latest error code that the controls recorded.



Press  and the next latest error code information can be seen.

Up to 10 error codes (B to K) can be stored in the E-LOG section.

**3-1. INFORMATION MODE**  
**DETAILS (Continued)**

**2. LAST LOAD** (Information on recent cook cycles)

Press ► and “2. LAST LOAD” show in displays.

Press a timer button  or  for the product you want to view the cook data and the LED flashes.

Press ▼ button to start viewing the cook data.

For example, if the left  LED is flashing, “PRODUCT FRY L1” show in displays.

If the right  LED is flashing, “PRODUCT FRY R2” show in displays.

Press ▼ button to start viewing the cook data.

FUNCTION	DISPLAY EX:
Product (Last product cooked)	PRODUCT FRY L1
Time of day the last Cook Cycle was started	STARTED FEB 4
2:25P	
Actual Elapsed cook Time (Real seconds)	ACTUAL TIME 1:06
Programmed cook Time	PROG TIME 1:00
Max Temp during Cook Cycle	MAX TEMP 350°F
Min Temp during Cook Cycle	MIN TEMP 313°F
Avg Temp during Cook Cycle	AVG TEMP 322°F
Heat On (percentage) during Cook Cycle	HEAT ON 45%
Ready? (Was fryer Ready before start?)	READY? YES
When Cook Cycle was stopped: Early	QUIT AT 0:10 REM
After complete Cook Cycle	OR
	*DONE* +6 SEC
Difference (%) between actual and programmed cook time	ACT/PROG 1%

**3-1. INFORMATION MODE**  
**DETAILS (Continued)**

**3. DAILY STATS** (Operational info of fryer for last 7 days)

Press ► and “3. DAILY STATS” show in displays.

Press ▼ button to start viewing the cook data.

Press the right  to view data for other days of week.

<b>FUNCTION</b>	<b>DISPLAY EX:</b>
Day this data was recorded for	APR-30 TUE*
Number of Hours:Minutes the fryer was on	(L/R) ON HRS TUE* 3:45
Number of times filtered	(L/R) FILTERED TUE* 4
Number of times filter skipped	(L/R) SKIPPED TUE* 4
Number of times oil added	(L/R) ADD OIL TUE* 4
Number of times oil discarded	(L/R) DISPOSE TUE* 0
Oil temperature recovery time	(L/R) RECOVERY TUE*1:45
Total number of cook cycles that day	(L/R) TOT CK TUE* 38
Number of cycles stopped before *DONE*	QUIT CK TUE* 2
Cook Cycles for Product #1	TUE* COOK -1- 17
Cook Cycles for Product #2	TUE* COOK -2- 9
Cook Cycles for Product #3	TUE* COOK -3- 5
Cook Cycles for Product #4	TUE* COOK -4- 0
Cook Cycles for Product #5	TUE* COOK -5- 0
Cook Cycles for Product #6	TUE* COOK -6- 6
Cook Cycles for Product #7	TUE* COOK -7- 0
Cook Cycles for Product #8	TUE* COOK -8- 0
Cook Cycles for Product #9	TUE* COOK -9- 1
Cook Cycles for Product #0	TUE* COOK -0- 0

**3-1. INFORMATION MODE**  
**DETAILS (Continued)**

**4. OIL STATS**

(info of current oil and avg. of last 4 batches of oil)  
Press ► and “4. OIL STATS” show in displays.

Press ▼ button to start viewing the cook data.

**FUNCTION**

**DISPLAY EX:**

Start date of new oil	NEW OIL	MAR-23
Number of days oil in use	(L/R) OIL USE	4 DAYS
Number of filters on this oil	(L/R) FILTERED	4
Number of times filter skipped	(L/R) SKIPPED	0
Number of cook cycles on this oil	(L/R) TOT CK	38
Average number of days per oil change	(L/R) AVG DAYS PER OIL CHANGE	13.8 DAYS
Average number cook cycles per oil change	(L/R) AVG CKS PER OIL CHANGE	388 CKS

Press and hold a product button (1 to 4) to view the data from one of the previous 4 batches of oil used.

Press  to view oldest oil data: Ex: OIL-4 14 DAYS

Press  to view 3rd oldest oil data: Ex: OIL-3 12 DAYS

Press  to view 2nd oldest oil data: Ex: OIL-2 15 DAYS

Press  to view previous batch of oil: Ex: OIL-1 13 DAYS

**NOTICE**

To obtain the most accurate oil information, use the “3.DISPOSE” step in the Filter Menu (press and hold  ) to drain the oil from the vat.

**3-1. INFORMATION MODE**  
**DETAILS (Continued)**

**5. REVIEW USAGE**

(accumulated info since the data was reset)

Press ► and “5. REVIEW USAGE” show in displays.

Press ▼ button to start viewing the cook data.

**FUNCTION**

**DISPLAY EX:**

Day the usage data was previously reset	SINCE	APR-19 3:00P
Number of Hours the fryer was on	(L/R) ON HRS	4
Number of times filtered	(L/R) FILTERED	4
Number of times filter skipped	(L/R) SKIPPED	0
Number of times oil added	(L/R) ADD OIL	4
Number of times oil discarded	(L/R) DISPOSE	1
Total number of cook cycles	(L/R) TOT CK	38
Number of cycles stopped before *DONE*	QUIT CK	2
Cook Cycles for Product #1	COOK -1-	17
Cook Cycles for Product #2	COOK -2-	9
Cook Cycles for Product #3	COOK -3-	5
Cook Cycles for Product #4	COOK -4-	0
Cook Cycles for Product #5	COOK -5-	0
Cook Cycles for Product #6	COOK -6-	6
Cook Cycles for Product #7	COOK -7-	0
Cook Cycles for Product #8	COOK -8-	0
Cook Cycles for Product #9	COOK -9-	1
Cook Cycles for Product #0	COOK -0-	0
<b>Reset usage data:</b> Enter the Usage Code - 1, 2, 3 on this step to zero out all the usage information	RESET USAGE / ENTER CODE	-----

**3-1. INFORMATION MODE**  
**DETAILS (Continued)**

**6. INPUTS**

Press **▶** and “6. INPTS” and “HDF” show in displays.

H = HIGH LIMIT - If “H” is present, the high limit is good. If “-” shows then the high limit is tripped out (overheated) or disconnected.

D = DRAIN SWITCH - If “D” is present, the drain handle (when applicable) is closed. If “-” shows then the drain is open or the switch is faulty.

F = FAN (PRESSURE SWITCH) - If “F” is present, the pressure switch is good. If “-” shows in the display, the switch is faulty.

Press **▼** button and an underscore (“\_”) indicates the input is not presently detected. A Checkmark (“√”) indicates the signal is detecting a normal input. A blinking (“X”) indicates the signal is presently detected, but is detected as a half-wave (partially failed) input.

**NOTICE**

The H, D, F signals above are wired in series. The first signal missing out of this sequence generally causes all signals to the right of it to be missing as well.

**7. OUTPUTS**

Press **▶** and “7. OUTP” and “F-S-I-H-” show in displays.

F = FAN (PRESSURE SWITCH)- Press **1** or **6** to open and close the pressure switches

S = SAFETY GAS VALVE (if available) - Press **2** or **7** to open and close the gas safety valves

I = IGNITION MODULE - Press **3** or **8** to open and close the outputs on the ignition modules

H = HEAT OUTPUTS - Press **4** or **9** to turn on and off the heating outputs (ex: gas valve)

**8. OIL TEMPERATURE**

Press **▶** and “8.OIL TMP” shows in the left display and the oil temperature shows in the right display.

**9. CPU TEMPERATURE**

Press **▶** and “9.CPU TMP” shows in the left display and the current PC board temperature shows in the right display.

## SECTION 4. PRODUCT PROGRAM MODE

This mode allows you to program the following:

- Change Product Name
- Assign Button
- Change Times & Temp
- Change Cook ID
- Alarms
- Quality Timers
- Include in Filter Count (Global)
- Filter at X no. of loads (Mixed)
- Load Compensation
- Load Compensation Reference
- Full Heat
- PC Factor

### 4-1. MODIFYING PRODUCT SETTINGS

1. Press and hold  button until “PROG” shows in the display, followed by “ENTER CODE”.
2. Enter code 1, 2, 3 (first 3 product buttons). “PRODUCT” and “PROGRAM” show in the displays, followed by “SELECT PRODUCT” and “-P 1-” (ex: NUG).

#### **Change Product Names**

3. Use the ▲ and ▼ buttons to scroll through the 40 products, or press the desired product button.
4. Press ► button and “NAME” shows in the left display and the product (ex: NUGGETS) shows in the right display.
5. Press √ button and the first letter in the name flashes. Press a product button and the flashing letter changes to the first letter under the product button that was pressed. For example, if  is pressed, the flashing letter changes to an “A”.

Press the same button again and the flashing letter changes to a “B”. Press it again and the flashing letter changes to a “C”. Once the desired letter shows in the display, press ► button to continue to the next letter and repeat the procedure.

Press and hold the right X button to exit Program Mode, or press ► button to continue on to “COOK TIME”.

#### **Assign Button**

6. Press ► button until “ASSIGN BTN” shows in the display, along with the product (ex: NUGGETS). If this product already has a product button assigned to it, that LED will be lit. To assign other product buttons to that product, press and hold the product button for 3 seconds and that LED stays lit. To remove a product from a button, press and hold the product button with a lit LED and the LED goes out.

## **4-1. MODIFYING PRODUCT SETTINGS (Continued)**

### **To Change Times and Temperatures**

7. Press ► button until “COOK TIME” shows in the display, and then use the product buttons, or the ▲ and ▼ buttons, to change the time in minutes and seconds, to a maximum of 59:59.
8. Press ► button and “TEMP” shows in the display, along with the preset temperature on the right side of the display.

Press the product buttons, or the ▲ and ▼ buttons, to change the temperature. The temperature range is 190°F (88°C) to 375°F (191°C).

### **Cook ID Change**

9. Press ► button until “COOK ID” shows in the display along with the product ID. For example, NUG would be the ID for nuggets. Use the product buttons, or the ▲ and ▼ buttons, to change the ID.

### **Alarms (1 & 2)**

10. Press ► button until “ALRM 1” shows in the left display, and an alarm time in the right display. Press the product buttons, or the ▲ and ▼ buttons, to set an alarm.

Ex., If a Cook Cycle was set at 3 minutes, and an alarm was to go off after 30 seconds into the Cook Cycle, “2:30” would be set in the display at this time. When the timer counts down to 2:30 the alarm sounds.

After the alarm time is set, press ► button and “ALRM 2” shows in the display, and a second alarm can be programmed.

### **Quality Timer (hold time)**

11. Press ► button until “QUAL TMR” shows in the display along with the preset holding time. Press the product buttons, or the ▲ and ▼ buttons, to adjust holding time, up to 59:59.

### **Global Filter Tracking**

#### **Include in Filter Count**

12. Press ► button until “INCL IN FLTR CNT” flashes in the display along with “YES” or “NO”. Using ▲ and ▼ buttons, change the display to “YES” if that product’s Cook Cycles are to be counted as part of the recommended filter process. Set to “NO” if it is not to be included. Mixed Filter Tracking

## 4-1. MODIFYING PRODUCT SETTINGS (Continued)

### **Filter After X Number of Loads**

13. Press ► button until “FILTER AFTER...” flashes in the left display along, and the number of cook cycles between filters shows in the right display. Press the product buttons, or the ▲ and ▼ buttons, to change this value of 0 to 99 loads. This needs set for each product.

### **>Load Compensation, Load Compensation Reference, Full Heat, PC Factor<**

14. Press ► button until “LD COMP” shows in the display, along with the load compensation value. This automatically adjusts the time to account for the size and temperature of the cooking load.

Press the product buttons, or the ▲ and ▼ buttons, to change this value of 0 to 20.

15. Press ► button until “LCMP REF” shows in the display along with the load compensation average temperature. (if load compensation is set to “OFF”, then “\_ \_ \_” shows in display and setting cannot be programmed) This is the average cooking temperature for each product. The timer speeds up at temperatures above this setting and slows down at temperatures below this setting. Press the product button, or the ▲ and ▼ buttons, to change this value.

16. Press ► button until “FULL HT” shows in the display along with the full heat value in seconds, which means the heat is on as soon as a timer button is pressed, for the programmed length of time. Press the product buttons, or the ▲ and ▼ buttons, to change this value of 0 to 90 seconds.

17. Press ► button until “PC FACTR” shows in the display along with the proportional temperature, which helps to keep the oil from over-shooting the setpoint temperature. Press the product buttons, or the ▲ and ▼ buttons, to change this value of 0 to 50 degrees.

## **NOTICE**

- Use ◀ button to go back to previous menu items.
- Press ► button when finished with the current product, to return to the “SELECT PRODUCT” step.
- Press and hold **P** button to exit PRODUCT PROGRAM Mode.

## SECTION 5. LEVEL 2 PROGRAMMING

Used to access the following:

- Special Program Mode
- Clock Set
- Data Communication
- Heat Control

### 5-1. SPECIAL PROGRAM MODE

The Special Program Mode is used to set more detailed programming, such as:

- SP-1** • Degrees Fahrenheit or Celsius
- SP-2** • Language: English, Russian, Swedish (SVENSKT), German (DEUTSCHE), Portuguese, Spanish (ESPANOL) and French (FRANCAIS)
- SP-3** • System Initialization (Factory Presets)
- SP-4** • Audio Volume
- SP-5** • Audio Tone
- SP-6** • Melt Cycle Select - 1.LIQUID; 2.SOLID
- SP-7** • Idle Mode Enabled - YES or NO
- SP-7A** • Use “0” for IDLE
- SP-7B** • Auto Idle Minutes
- SP-7C** • Idle Set-point Temperature
- SP-8** • Filter Tracking Mode - 1.MIXED or 2.GLOBAL
- SP-8A** • Suggest Filter At... - 75% to 100% (**MIXED**)
- SP-8B** • Filter Lockout Enabled? - YES or NO (**MIXED**)
- SP-8A** • Left Vat Filter Cycles - 0 to 99 (**GLOBAL**)
- SP-8B** • Right Vat Filter Cycles - 0 to 99 (**GLOBAL**)
- SP-8C** • Filter Lockout Enabled? - YES or NO (**GLOBAL**)
- SP-9** • Polish Duration - X:XX M:SS
- SP-10** • Change Pad Reminder Time - XX HRS
- SP-11** • Clean-Out Time - XX MIN
- SP-12** • Clean-Out Temperature - XXX °F or °C
- SP-13** • Cooking User IO - After Cook Cycle, display shows previous menu item or “----”
- SP-14** • Number of Baskets - 2-BASKETS or 4 BASKETS
- SP-15** • Show Cooking Indicator - YES or NO
- SP-16** • 2nd Language: English, Russian, Swedish (SVENSKT), German (DEUTSCHE), Portuguese, Spanish (ESPANOL) and French (FRANCAIS)
- SP-17** • 2nd AudioVolume
- SP-18** • Energy Save Enabled? - YES or NO
- SP-19** • Fryer Type - GAS or ELECTRIC
- SP-20** • Vat Type - SPLIT or FULL
- SP-21** • Autolift Enabled? - NO LIFT or YES LIFT
- SP-22** • Bulk Oil Supply? - YES or NO
- SP-23** • Bulk Oil Dispose? - YES or NO
- SP-24** • Serial No. of Fryer
- SP-25** • Change Mgr. Code- 1 = YES
- SP-26** • Change Usage Code - 1 = YES
- SP-27** • Dispose Requires Code ? - YES or NO
- SP-28** • Longer Fill Time Enabled - YES or NO
- SP-29** • Let User Exit Fill? - YES or NO

## **5-1. SPECIAL PROGRAM MODE (Continued)**

Press and hold the **P** button for 5 seconds until “LEVEL 2” followed by, “SP PROG” and “ENTER CODE” show in the display.

Enter code 1,2,3, and “SP-1”, “TEMP”, “FORMAT” show in the displays.

### **NOTICE**

If a bad code is entered, a tone sounds and “BAD CODE” shows on the display. Wait a few seconds, the controls revert back to the cook mode, and repeat the above steps.

To exit from the Special Program Mode at any time, press and hold **P** button for 2 seconds.

### **Degrees Fahrenheit or Celsius (SP-1)**

The left display flashes “SP-1” and “TEMP”, “FORMAT”. Press the ▲ or ▼ buttons to choose °F or °C.

### **NOTICE**

- Use ◀ button to go back to previous menu items
- Press ▶ button when finished with the current Level 2 step

### **Language (SP-2)**

Press ▶ button and “SP-2” and “LANGUAGE” flash on the left display. Press the ▲ or ▼ buttons to select the desired language.

### **System Initialization (SP-3)**

Press ▶ button and “SP-3” and “DO SYSTEM INIT” flash in the display, along with “INIT” on the right display. To reset the controls to factory default settings, press and hold √ button and control counts down “IN 3”, “IN2”, “IN 1”. Once display shows “-INIT-” & \*DONE\* the controls are reset to factory defaults.

### **Audio Volume (SP-4)**

Press ▶ button and “SP-4” and “VOLUME” flash in the left display. Press the ▲ or ▲ or use product buttons, to adjust the volume of the speaker, 10 being the maximum value and 1 the minimum.

## **5-1. SPECIAL PROGRAM**

### **MODE (Continued)**

#### **Audio Tone (SP-5)**

Press ► button and “SP-5” and “TONE” flash in the left display. Press the ▲ or ▼ or use product buttons, to adjust the tone of the speaker, 2000 being the maximum value and 50 the minimum.

#### **Liquid or Solid Cooking Oil Used (SP-6)**

Press ► button until “SP-6 MELT CYCLE SELECT” scrolls in the left display. Unless solid oil is being used in the vats the right display should show “1.LIQUID”.

If solid oil is used, the unit MUST BE equipped to handle solid oil. Use the ▲ and ▼ buttons to change the right display to “2.SOLID”

#### **Idle Mode Enabled (SP-7)**

An Idle Mode allows the oil temperature to drop to a lower temperature when not in use. This saves on oil and utilities.

Press ► button and “SP-7” and “IDLE MODE ENABLED?” flash in the left display. Press the ▲ or ▼ buttons to choose “YES” or “NO”.

With “YES” in the display, press ► button and “SP-7A” and “USE ‘0’ FOR IDLE” flash on the left display. Press the ▲ or ▼ buttons to select “YES” or “NO”. If “YES” is selected, an Idle Mode can be programmed in product button .

Press ► button and “SP-7B” and “AUTOIDLE MINUTES” flash in the left display. Press the ▲ or ▼, or use product buttons, to set the time (0 to 60 minutes) fryer stays idle before the auto-idle is enabled.

Ex., “30” means, if product is not cooked in that vat for 30 minutes, the control automatically cools the oil down to the idle setpoint temperature

Press ► button and “SP-7C” and “IDLE SETPT” flash in the left display. Press the ▲ or ▼, or use product buttons, to set the idle temperature 200° to 375 °F (93 to 191 °C).

**5-1. SPECIAL PROGRAM**  
**MODE (Continued)**

**Filter Tracking Mode (SP-8)**

Filter Tracking signals the operator when the oil needs filtering by counting the number Cook Cycles between filters  
Press ► button and “SP-8” and “FILTER TRACKING MODE” show in the display. Use the ▲ and ▼ buttons to choose either “1.MIXED” filter tracking or “2.GLOBAL”.

**NOTICE**

GLOBAL means all the products have the same number of cook cycles between filters.

<b>Product</b>	<b>No. Cook Cycles</b>	<b>Cycle Count</b>
Fish	2	1/2
French Fries	8	1/8
Chicken	4	1/4

MIXED means each product may be set with different number of cook cycles between filters. The controls adds the cycle counts (see example at left) and when the counts equal 1 or greater, filtering is suggested. Ex: 1 load of fish, 2 loads of french fries, a load of chicken equals 1.  $1/2 + 1/8 + 1/8 + 1/4 = 1$ .

**MIXED**

If MIXED is selected, press ► button and “SP-8A” and “SUGGEST FILTER AT ...” shows in the left display, and a value between 75% and 100% shows on the right display. Press the ▲ and ▼ buttons to change this value.

The lower the value, the sooner the control recommends to filter. Ex: If set to 75%, the control suggest filtering after 3/4 of the programmed cook cycles is met, whereas at 100%, all the cook cycles must be completed before the control suggest filtering.

Press ► and “SP-8B” and “LOCKOUT ENABLED?” shows in the left display. Press the ▲ and ▼ buttons to choose YES or NO.

If set to YES, when the controls suggest filtering, “FILTER LOCKOUT?”/”YOU \*MUST\* FILTER NOW”, shows in the display, and it refuses further cook cycles until the vat is filtered.

Press ► and “SP-8C” and “LOCKOUT AT...” shows in the left display and a value between 100% and 250% shows on the right display. Press the ▲ and ▼ buttons to change this value. The lower the value, the sooner the “lockout” occurs.

Ex: If set at 100%, “lockout” occurs when the cycle counts reaches 1 or greater. Set at 200%, twice as many cycles are counted before “lockout” occurs. See example above.

**5-1. SPECIAL PROGRAM**  
**MODE (Continued)**

**Filter Tracking Mode (SP-8) (Continued)**

**GLOBAL**

If GLOBAL is selected, press ► button.

**Split Vat**

If unit is a split vat, “SP-8A” and “LEFT VAT FILTER CYCLES” shows in the left display, and the number of cook cycles between filters shows on the right display (0 to 99). Use ▲ and ▼ or product buttons to change this number.

Press ► button and “SP-8B” and “RIGHT VAT FILTER CYCLES” shows in the left display, and the number of cook cycles between filters shows on the right display (0 to 99).

Press ► button and “SP-8C” and “LOCKOUT ENABLED?” shows in the left display. Press the ▲ and ▼ buttons to choose YES or NO.

If set to YES, press ► button and the left display shows “SP-8D” and “LEFT VAT LOCKOUT CYCLES” and the number of cook cycles before filter lock-out shows on the right display (0 to 99). Use ▲ and ▼ or product buttons to change this number.

Press ► button and the left display shows “SP-8E” and “RIGHT VAT LOCKOUT CYCLES” and the number of cook cycles before filter lock-out shows on the right display (0 to 99). Use ▲ and ▼ or product numbers to change this number.

Once this number of cook cycles is reached, “FILTER LOCK-OUT”/“YOU \*MUST\* FILTER NOW”, shows in the display, and it refuses further cook cycles until the vat is filtered.

**Full Vat**

If unit is a full vat, “SP-8A” and “FULL VAT FILTER CYCLES” shows in the left display, and the number of cook cycles between filters shows on the right display (0 to 99). Use ▲ and ▼ or product numbers to change this number.

Press ► button and “SP-8B” and “LOCKOUT ENABLED?” shows in the left display. Press the ▲ and ▼ buttons to choose YES or NO.

If set to YES, press ► button and the left display shows “SP-8C” and “FULL VAT LOCKOUT CYCLES” and the number of cook cycles before filter lock-out shows on the right display (0 to 99). Use and or product buttons to change this number.

Once this number of cook cycles is reached, “FILTER LOCK-OUT”/“YOU \*MUST\* FILTER NOW”, shows in the display, and it refuses further cook cycles until the vat is filtered.

**5-1. SPECIAL PROGRAM**  
**MODE (Continued)**

**Polish Duration (SP-9)**

Press ► button and “SP-9” and “POLISH TIME” flash in the left display. Press the ▲ or ▼ , or use product buttons, to change the polish time, from 0 to 10 minutes.

**Change Filter Pad Reminder Time (SP-10)**

Press ► button and “SP-10 “CHANGE PAD’ REMINDER” flash in the left display. Press the ▲ or ▼ , or use product buttons, to change the time, from 0 hours to a maximum of 100 hours.

**Clean-Out Time (SP-11)**

Press ► button and “SP-11 CLEAN-OUT TIME” flashes in the left display. Press the ▲ or ▼ or use product buttons, to change the time from 0 to 99 minutes.

**Clean-Out Temperature (SP-12)**

Press ► button and “SP-12 CLEAN-OUT TEMP” flashes in the left display. Press the ▲ or ▼ or use product buttons, to change the temperature from 0 to 195° F (90° C).

**Cooking User IO (SP-13)**

Press ► button and “SP-11” and “COOKING USER IO” flash in the display. Press the ▲ or ▼ buttons to choose “SHOW-PREV” or “SHOW----”.

Setting SP-11 to SHOWPREV means after a cook cycle the display shows the last menu item cooked. SHOW---- means after a cook cycle “----” shows in the display and a menu item needs selected before starting the next cook cycle.

**Number of Baskets (SP-14)**

Press ► button and “SP-14 NUMBER OF BASKETS” flashes in the left display. Press the ▲ or ▼ buttons to choose 2 or 4 baskets per well.

**Cooking Indicator (SP-15)**

Press ► button and “SP-15 SHOW COOKING INDICATOR” flashes in the left display. Press the ▲ or ▼ buttons to choose YES, and during a cook cycle, “\*” shows which timer is counting-down. Choose NO and “\*” will not show during a cook cycle.

**5-1. SPECIAL PROGRAM**  
**MODE (Continued)**

**2nd Language (SP-16)**

Press ► button and “SP-16 2ND LANGUAGE” flashes on the left display. Press the ▲ or ▼ buttons to select the desired 2nd language.

By setting a 2nd language in the controls, 2 languages can now be chosen by pressing  button during normal operation.

One language shows in the left display and the second language shows in the right display. Pressing the √ button selects the language in the displays.

**2nd Volume (SP-17)**

Press ► button and “SP-17 2ND VOLUME” flashes on the left display. Press the ▲ or ▼ buttons, or the product buttons to select the desired 2nd volume.

By setting a 2nd volume in the controls, 2 volumes can now be chosen by pressing  button twice during normal operation.

One volume setting shows in the left display (NONE to 10; 10 being the loudest) and the second volume shows in the right display. To select the volume, press the √ button under the desired volume .

**Engery Save Mode (SP-18)**

Press ► button and “SP-18 ENERGY SAVE ENABLED?” flashes in the left display. Press the ▲ or ▼ buttons to choose “YES” or “NO”.

If set to YES, during times of non-use the fryer automatically starts an Energy Save Mode, which turns-off the blowers. Then once a product is selected to start a cook cycle, the blowers and heat come back on. If set to NO, the blowers are on constantly.

**Fryer Type (SP-19)**

Press ► button and “SP-19 FRYER TYPE” flashes in the left display. Press the ▲ or ▼ buttons to choose “GAS” or “ELEC”.

**Vat Type (SP-20)**

Press ► button and “SP-20 VAT TYPE” flashes in the left display. Press the ▲ or ▼ buttons to choose “SPLIT” or “FULL”.

**5-1. SPECIAL PROGRAM**  
**MODE (Continued)**

**Autolift Enabled (SP-21)**

Press ► button and “SP-21 AUTOLIFT ENABLED?” flashes in the left display. Press the ▲ or ▼ buttons to choose “YES LIFT” or “NO LIFT”. If fryer is fitted with the auto-lift option, SP-21 must be set to “YES LIFT”, otherwise, set SP-21 to “NO LIFT”.

**Bulk Oil Supply (SP-22)**

Press ► button and “SP-22 BULK OIL SUPPLY?” flashes in the left display. Press the ▲ or ▼ buttons to choose “YES SUPL” or “NO SUPL”. Set to YES if the oil is pumped into the vats from an outside oil reservoir. Otherwise, set SP-22 to NO.

**Bulk Oil Disposal (SP-23)**

Press ► button and “SP-23 BULK OIL DISPOSE?” flashes in the left display. Press the ▲ or ▼ buttons to choose “YES DISP” or “NO DISP”. Set to “YES DISP” if the oil is pumped from the vats to an outside oil reservoir when disarding the oil. Otherwise, set SP-23 to “NO DISP”.

**Serial Number Log (SP-24)**

Press ► button and “SP-24” and “S/N √EDIT” flash in the displays, along with the serial number of the unit. THIS SERIAL NUMBER SHOULD MATCH THE SERIAL NUMBER ON THE DATA PLATE, ON THE DOORS. IF NOT, IT CAN BE RECORDED.

**Program Code Change (SP-25)**

This allows the operator to change the program code (factory set at 1, 2, 3) used to access Product Programming and Level 2 Program Mode.

Press ► button and “SP-25” and “CHANGE MGR CODE? 1=YES” flash in the display. Press  and “ENTER NEW CODE, P=DONE, I=QUIT show scrolls through the display. Press the product buttons for new code.

If satisfied with code, press  and “REPEAT NEW CODE, P=DONE, I=QUIT, shows in display. Press same code buttons.

## **5-1. SPECIAL PROGRAM** **MODE (Continued)**



### **Program Code Change (SP-25) (Continued)**

If satisfied with code, press  and “\*CODE CHANGED\*” shows in display.

If not satisfied with code, press  and “\*CANCEL” shows in display, then reverts back to “SP-25” and “CHANGE, MGR CODE? 1=YES”. Now the above steps can be repeated.

### **Usage Code Change (SP-26)**

This allows the operator to change the reset usage code (factory set at 1, 2, 3) to reset the usage amounts of each product. See Review Usage step in Information Mode.



Press  button and “SP-26 CHANGE USAGE CODE? 1=YES” flashes in the display. Press  and “ENTER NEW CODE, P=DONE, I=QUIT show scrolls through the display. Press the product buttons for new code.

If satisfied with code, press  and “REPEAT NEW CODE, P=DONE, I=QUIT, shows in display. Press same code buttons.



If satisfied with code, press  “\*CODE CHANGED\*” shows in display.

If not satisfied with code, press  and “\*CANCEL” shows in display, then reverts back to “SP-26” and “CHANGE, USAGE CODE? 1=YES”. Now the above steps can be repeated.



### **Dispose Requires Code ? (SP-27)**

Press  button and “SP-27 DISPOSE REQUIRES CODE ?” flashes in the left display. Press the  or  buttons to choose YES or NO. If set to YES, code 1, 2, 3 must be entered to discard the oil from the vat, using the Dispose Mode.

### **Longer Fill Time (SP-28)**

Press  button and “SP-28 LONGER FILLTIME ENABLED?” flashes in the left display. Press the  or  buttons to choose YES or NO.

### **Let User Exit Fill (SP-29)**

Press  button and “SP-29 LET USER EXIT FILL” flashes in the left display. Press the  or  buttons to choose YES or NO. If YES is chosen, the user can exit the Express Filter™ fill operation.

## **5-2. CLOCK SET**

1. Press and hold the **P** button for 5 seconds until “LEVEL 2”, followed by, “SP PROG” and “ENTER CODE” show in the display.
2. Press the **P** button 2 times and “CLK SET” and “ENTER CODE” flash in the left display.
3. Enter code 1, 2, 3 (first 3 product buttons).
4. “CS-1 ENTER DATE MM-DD-YY” flashes in the left display. Use the product buttons to set the date in the right display.
5. Press ► button and “CS-2 ENTER TIME” flashes in the left display and the time flashes in the right display. Press the ▲ or ▼ , or use product buttons, to change the time.
6. Press ► button and “CS-2 ENTER TIME” flashes in the left display and “AM” or “PM” flashes in the right display. Use the ▲ or ▼ buttons to choose AM or PM.
7. Press ► button and “CS-3 TIME FORMAT” flashes in the left display and “12-HR” or “24-HR” shows in the right display. Use the ▲ or ▼ buttons to choose a 12 hour time format or a 24 hour time format.
8. Press ► button and “CS-4 DAYLIGHT SAVING TIME” flashes in the left display. Use the ▲ or ▼ buttons to choose daylight saving time for your area: 1.OFF; 2.US (2007 & after); 3.EURO; or 4.FSA (US before 2007).

## **5-3. DATA LOGGING, HEAT CONTROL, TECH, STAT, AND FILTER CONTROL MODES**

The Data Logging, Heat Control, Tech, Stat and Filter Control Modes are advanced diagnostic and program modes, mainly for Henny Penny use only. For more information on these modes, contact the Service Department at 1-800-417-8405 or 1-937-456-8405.

## **5-4. TECH MODE**



The TECH Mode has self-diagnostic information, which can be used by certified technicians for troubleshooting purposes, such as:

- T-1 • Software**
- T-2 • Fryer Type (Gas or Elec.)**
- T-3 • Push Button Test**
- T-4 • All On Display Test**
- T-5 • Display Segment Test**
- T-6 • Display Digits Test**
- T-7 • Display Decimal Point Test**
- T-8 • LED's Test**
- T-9 • Left Temp. Probe Calibration & Offset**
- T-10 • Left Level 1 Probe Calibration & Offset**
- T-11 • Left Level 2 Probe Calibration & Offset**
- T-12 • Right Temp. Probe Calibration & Offset**
- T-13 • Right Level 1 Probe Calibration & Offset**
- T-14 • Right Level 2 Probe Calibration & Offset**
- T-15 • CPU Control Temp. Calibration/Offset/Highest**
- T-16 • View A - D Channel**
- T-17 • Digital Inputs**
- T-18 • AIF Info**
- T-19 • Outputs Test**
- T-20 • Pumps & Valves Test**
- T-21 • Recovery Test Limit**
- T-22 • Drain Light Stay On?**
- T-23 • Heat Err Enabled?**
- T-24 • Change Tech Code?**
- T-25 • Total Initialization**

### **NOTICE**

Not all Tech Mode functions are discussed in this section. To ensure proper operation of fryer, please consult Henny Penny Corp. before changing any of these settings. For more information on these functions, contact the Service Department at 1-800-417- 8405, or 1-937-456-8405.



### **5-4. TECH MODE (Continued)**

1. Press and hold the  button for 5 seconds until “LEVEL 2”, followed by, “SP PROG” and “ENTER CODE” show in the display.
2. Press the  button 4 times and “TECH” and “ENTER CODE” flash in the left display.
3. Enter code 1, 1, 2, 2, 1, 1, 2, 2 (first 2 product buttons).
4. “T-1 SOFTWARE” flashes in the left display and “EV-ELITE” shows in the right display. Use the ◀ and ▶ buttons to select the steps.

### **NOTICE**

If a bad code is entered, a tone sounds and “BAD CODE” shows on the display. Wait a few seconds, the controls revert back to the cook mode, and repeat the above steps. Press and hold  button at anytime to return to normal operation.

#### **T-1 - SOFTWARE**

- Press  to view HP Part No. of eprom
- Press  to view software ID
- Press  to view software version

#### **T-2 - FRYER TYPE - GAS or ELEC**

#### **T-3 - PUSH-BUTTON TEST**

Press any of the control buttons to test operation. You should hear a beep, and the LED should light and/or a display.

#### **T-4 - ALL ON DISPLAY TEST**

Press any of the product buttons and all the LEDs and display segments should light.

#### **T-5 - SEGMENTS TEST**

Press  button to view the different segments of the display characters.

#### **T-6 - DIGITS TEST**

Press  button to view all segments of each digit across the displays.

**5-4. TECH MODE (Continued)**

**T-7 - DECIMAL PTS TEST**

Press  button to view all decimal points across the displays.

**T-8 - LED'S TEST**

Press  buttons to view each LED across the control panel.

**T-17 - DIGITAL INPUTS - HDF**

H = HIGH LIMIT - If "H" is present, the high limit is good. If "-" shows then the high limit is tripped out (overheated) or disconnected.

D = DRAIN SWITCH - If "D" is present, the drain handle (when applicable) is closed. If "-" shows then the drain is open or the switch is faulty.

F = FAN (PRESSURE SWITCH) - If "F" is present, the pressure switch is good. If "-" shows in the display, the switch is faulty.

Press ▼ button and an underscore ("\_") indicates the input is not presently detected. A Checkmark ("√") indicates the signal is detecting a normal input. A blinking ("X") indicates the signal is presently detected, but is detected as a half-wave (partially failed) input.

**NOTICE**

The H, D, F signals above are wired in series. The first signal missing out of this sequence generally causes all signals to the right of it to be missing as well.

**T-18 - OUTPUTS**

F = FAN (PRESSURE SWITCH)- Press  to open and close the pressure switches

S = SAFETY GAS VALVE (if available) - Press  to open and close the gas safety valves



I = IGNITION MODULE - Press  to open and close the outputs on the ignition modules

H = HEAT OUTPUTS - Press  to turn on and off the heating outputs (ex: gas valve)

**5-4. TECH MODE (Continued)**

**T-20 - PUMPS & VALVES**

Press ▼ button and “LIGHTS” “DLT\_” shows in displays.

Press  and left Filter Beacon lights (split vats) and press  button and right Filter Beacon lights (display shows “DLTo” when on)

Press ▼ button and “VALVES” “DcRc” shows in displays.

Press  to open and close the return valve.

“DcRc” means valve is closed, “DcRo” means valve is open.  
(Driven by the control board)

Press ▼ button and “DISCARDc” and “JIBFILLc” shows in the displays. (Driven by the AIF board)

Press  to open and close the RTI discard valve (display shows “DISCARD0” when open)

Press  to open and close the RTI JIB fill valve (display shows “JIBFILL0” when open)

Press ▼ button and “PUMP FP\_” and “JP\_ NP\_” shows in the displays. (Driven by the AIF board)

Press  to turn off and on the filter pump (display shows “FP\*” when on)

Press  to turn off and on the JIB pump (display shows “JP\*” when on)

Press  to turn off and on the new oil pump (if available - display shows “NP\*” when on)

**5-4. TECH MODE (Continued)**

Press ▼ button and “AIF REQ” and “RQ=Y OK=Y” shows in the displays.

“REQ=Y” means that this particular control is currently requesting control of the AIF Board outputs.

“OK=Y” means that the AIF Board has granted this control the authority to control the AIF Board outputs.

Press ▼ button and “FILR IN” and “USE BY 1(ex)” shows in the displays. These displays shows which controls are using the filtering system.

“USE = 0” = not in use

“USE = 7” = used by AIF

“USE = 1 to 5” = used by control PCB

Press ▼ button and “CPU POSN” and “1 OF 3(ex)” shows in the displays. These displays shows which controls are plugged into which port on the AIF board.

For example, the left control should be plugged into port 1, and on a 3 control fryer, shows “1 OF 3” on the display.

If the right control is unplugged, then the left control would show “1 OF 2” instead of “1 OF 3”.

Press ▼ button and “INP E\_P\_” and “JL\_Rx DF\_” shows in the displays.

AIF Board Inputs:

E = Stop button

P = Drain Pan

JL = JIB

R = RTI

DT = Discard Tank

Ex = E-Stop pressed.

Px = drain pan is missing.

Jx = JIB oil level is low.

Rx = RTI System NOT Detected

DTx = tank full

**5-4. TECH MODE (Continued)**

Press ▼ button and “OUT F\_J\_” and “N\_DI\_oJF\_” shows in the displays.

AIF Board Outputs:

Current outputs status from AIF board.

F = Filter Pump. (Fx = Filter pump is on)

J = JIB Pump. (Jx = JIB pump is on)

N = New Oil Pump. (Nx = RTI new oil pump on)  
(if present)

DI = Discard Valve. (DIo = Disc. valve open/DIc=closed)  
(if present)

JF = JIB Fill Valve. (JFo = JIB fill valve open/JFc=closed)

Press ▼ button and “REQ F\_J\_” and “N\_DI\_JF\_” shows in the displays.

AIF Board Outputs Requested by the Control Board:

Current outputs status from AIF board.

F = Filter Pump. (Fx = Filter pump is on)

J = JIB Pump. (Jx = JIB pump is on)

N = New Oil Pump. (Nx = New oil pump on)  
(if present)

DI = Discard Valve. (DIo = Disc. valve open/DIc=closed)  
(if present)

JF = JIB Fill Valve. (JFo = RTI JIB fill valve open/JFc=-  
closed)

## 5-5. STATS MODE

This mode allows a technician to view advanced information on the operation of the fryer and controls.

1. Press and hold the **P** button for 5 seconds until “LEVEL 2”, followed by, “SP PROG” and “ENTER CODE” show in the display.
2. Press the **P** button 5 times and “STATS” and “ENTER CODE” flash in the left display.
3. Enter code 1, 1, 2, 2, 1, 1, 2, 2 (first 2 product buttons).
4. “ST-1 STATS LAST RESET ON...” flashes in the left display and the date shows in the right display. Use the ◀ and ▶ buttons to select the steps.

### NOTICE

If a bad code is entered, a tone sounds and “BAD CODE” shows on the display. Wait a few seconds, the controls revert back to the cook mode, and repeat the above steps. Press and hold **P** button at anytime to return to normal operation.

<b>ST-1</b>	• Stats Last Reset Date	<b>ST-16</b>	• System RAM Fade Count
<b>ST-2</b>	• Fryer Total Running Hours	<b>ST-17</b>	• Cook RAM Fade Count
<b>ST-3</b>	• Left Vat Melt Cycle Hours	<b>ST-18</b>	• Product RAM Fade Count
<b>ST-4</b>	• Left Vat Cook Cycle Hours	<b>ST-19</b>	• Stat RAM Fade Count
<b>ST-5</b>	• Left Vat Idle Hours	<b>ST-20</b>	• RAM Data Error Count
<b>ST-6</b>	• Right Vat Melt Cycle Hours	<b>ST-21</b>	• Data Total Loss Count
<b>ST-7</b>	• Right Vat Cook Cycle Hours	<b>ST-22</b>	• User Initialization Count
<b>ST-8</b>	• Right Vat Idle Hours	<b>ST-23</b>	• Automatic Initialization Count
<b>ST-9</b>	• Power-Ups Count	<b>ST-24</b>	• Cooks Count per Product
<b>ST-10</b>	• Error Counts	<b>ST-25</b>	• Cook Cycle Stop Counts
<b>ST-11</b>	• Left Vat Heat On Hours		- “A” = number of stops in the first 30 sec.
<b>ST-12</b>	• Right Vat Heat On Hours		- “B” = 0
<b>ST-13</b>	• Highest Left Vat Oil Temperature		- “C” = 0
<b>ST-14</b>	• Highest Right Vat Oil Temperature		- “D” = complete cook cycles counted
<b>ST-15</b>	• Highest CPU Temperature	<b>ST-26</b>	• Reset All Stats

## SECTION 6. MAINTENANCE

### 6-1. INTRODUCTION

This section provides checkout and replacement procedures, for various parts of the fryer. Before replacing any parts, refer to the Troubleshooting Section to aid you in finding the cause of the malfunction.

### 6-2. MAINTENANCE HINTS

1. A multimeter will help you to check the electric components.
2. When the manual refers to the circuit being closed, the multimeter should read zero unless otherwise noted.
3. When the manual refers to the circuit being open, the multimeter should read infinity.



**Do not move the fryer with hot oil in the vat or filter pan. Severe burns can result from splashing hot oil.**

### 6-3. PREVENTIVE MAINTENANCE

To ensure a long life of the fryers and their components, regular maintenance should be performed. Refer to the chart below.

Frequency	Action
Daily	Filter the oil (See Daily Filtering Instructions Section in Operator's Manual)
Daily	Change Filter Pad (See Changing Filter Pad Section in Operator's Manual)
Every filter pad change	Lubricate filter pan o-rings
Quarterly	Inspect/Change Filter Pan O-Rings (See Check/Replace Filter Drain Pan O-Ring Section)
When oil smokes, foams-up violently, or tastes bad	Change oil
Every change of oil	Clean Vat (See Clean-Out Mode Section in Operator's Manual)
Semi-Annually	Clean blowers & Vents (See Section 3-21 in Operator's Manual)

## 6-4. CONTROL PANEL & MENU CARD REPLACEMENT

Should the control panel become inoperative, or the menu card needs changed, follow these instructions:

1. Remove electrical power supplied to the vat.



**To avoid electrical shock or property damage, move the power switch to OFF and disconnect main circuit breaker, or unplug cord at wall receptacle.**

2. Remove the two screws securing the control panel.

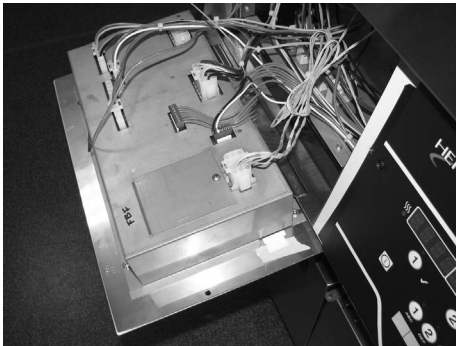
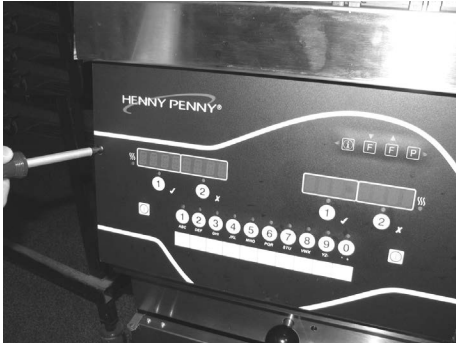

3. Pull the top of the panel down, allowing the panel to be supported by the 2 brackets in the slots in the control shroud. (If changing control panel, continue onto step 5.)

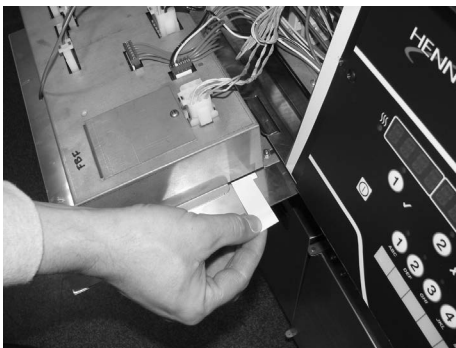

4. If changing the menu card, loosen the tape securing the menu card at the bottom, side of the control panel and pull menu card from panel. Carefully, slide changed menu card back into slot in panel and secure with tape.

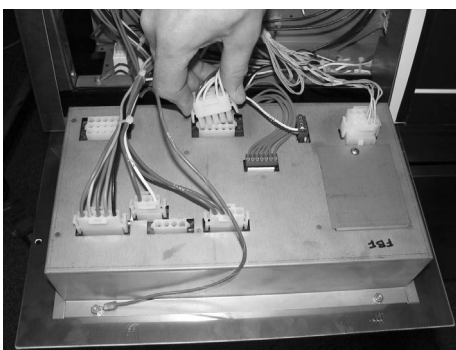

5. Unplug the connectors going to the control board.

6. Install a new control panel in reverse order.

## **6-5. HIGH TEMPERATURE LIMIT CONTROL**

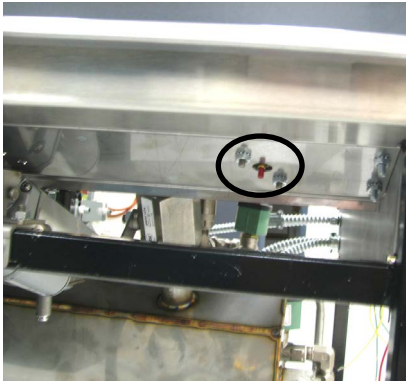

This is a safety, manual reset control, which senses the temperature of the oil. If the oil temperature exceeds 425°F (218°C), this switch opens and shuts off the heat to the vat and “E-10” shows in the display. When the temperature of the oil drops to a safe operation limit, manually reset the control by pressing the red reset button.

The red reset button is located behind the doors, underneath the controls; find the appropriate high limit and press the red reset button; if high limit does not reset, high limit must be replaced; If high limit resets, the oil starts heating.

### **Checkout**

Before replacing a high temperature limit control, check to see that its circuit is closed.

### **NOTICE**

The oil temperature must be below 380°F (193°C) to accurately perform this check.

1. Remove electrical power supplied to the fryer.



**To avoid electrical shock or property damage, move the power switch to OFF and disconnect main circuit breaker, or unplug cord at wall receptacle.**

2. Using a Phillip’s-head screwdriver, or cordless drill, loosen the screw securing the top of the control panel and secure control panel in the slots of the shroud.
3. Open the front door, and using a 3/8” socket or nut-driver, remove the 2 nuts securing the high limit bracket to the unit.
4. Pull the high limit and bracket from inside of control panel and remove the two screws securing the high limit to the bracket.
5. Pull the high limit from the bracket, pull back the cardboard protector, and remove the two electrical wires from the high-limit control.
6. Manually reset the control, then check for continuity between the two terminals after resetting the control. If the circuit is open, replace the control, then continue with this procedure. (If the circuit is closed, the high limit is not defective. Reconnect the two electrical wires.)

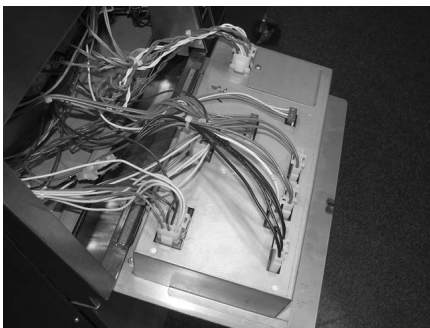

**6-5. HIGH TEMPERATURE  
LIMIT CONTROL  
(Continued)**

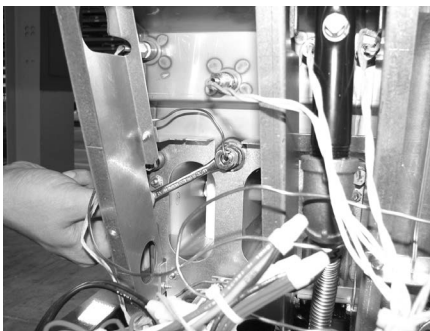
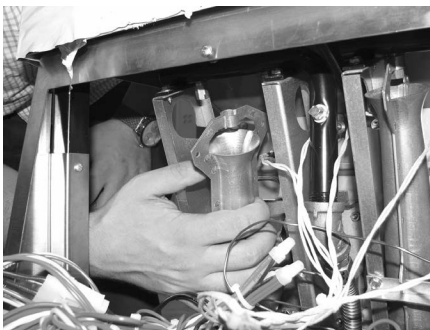
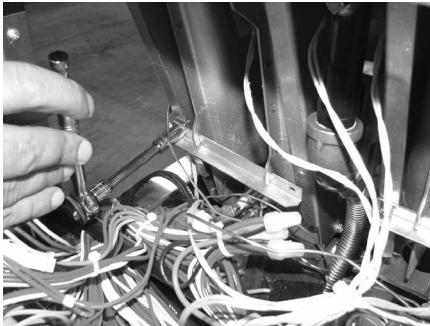

**Replacement**

If the tube is broken or cracked, the control opens, shutting off electrical power. The control cannot be reset.

1. Pull-out on the drain valve knob and drain the oil from the vat.
2. Remove electrical power supplied to the fryer.



**To avoid electrical shock or property damage, move the power switch to OFF and disconnect main circuit breaker, or unplug cord at wall receptacle.**

3. Using a 3/8" socket, remove the 2 screws securing the burner jet bracket and remove bracket.
4. Pull both burner jets from unit.
5. Using a 5/16" wrench, loosen small inside screw nut on capillary tube.
6. Using a Phillip's-head screwdriver, remove the 2 screws the capillary bulb bracket and pull bracket from unit.
7. Using an 11/16" crows-foot remove the large high limit fitting in vat wall, and pull the high limit from inside the control area.

**6-5. HIGH TEMPERATURE  
LIMIT CONTROL  
(Continued)**



8. Using an 11/16” crows-foot remove the large high limit fitting in vat wall, and pull the high limit from inside the control area.
9. Install new high limit in reverse order and restore power to unit.
10. 9.Fill vat by pressing and holding **F** button until \*FILTER\* \*MENU\* shows in the display. Then once “1.EXPRESS FILTER” shows in the display, press ► 4 times until “5.FILL FROM PAN” shows in the display. Press √ button and “PUMP” “EXIT” shows in the display. Press √ button again, and oil fills vat. Once vat is full, press X twice to return to normal operation.

**6-6. MAIN POWER SWITCH**

This is a covered rocker switch, which in the ON position, sends power to all the controls and filter motor.



**To avoid electrical shock or property damage, move the power switch to OFF and disconnect main circuit breaker, or unplug cord at wall receptacle.**



1. Remove right side panel.
2. Label and remove wires from the switch.
3. From the inside of the control area, squeeze in on the tabs on the back of the switch and push the switch out the front of the control area.

**Checkout**

4. Check across the two sets of terminals of the switch for continuity. With the switch in the ON position, the circuit should be closed. With the switch in the OFF position, the circuit should be open.

If the switch is found to be defective, replace it by connecting the wires to it (as labeled) and push new switch into place.



**6-7. PROBE REPLACEMENT**



**Oil level probe**      **Temperature probe**      **Oil level probe**

The temperature probe is the center probe inside the vat (see photo at left) and it relays the actual oil temperature to the control. If it becomes disabled, “E-6A or B” shows in the display.

The oil level probes (left & right-see photo at left) monitor the oil level by temperature differences. If they become disabled, the display shows: “E-18A”= left probe; “E18-B”= right probe; “E18C”= both.

Also, if any of the probes are out of calibration more than 5°F, or 5°C, the probe should be replaced. An Ohm check can be performed also. See chart below.

**Checkout:**



**To avoid electrical shock or property damage, move the power switch to OFF and disconnect main circuit breaker, or unplug cord at wall receptacle.**

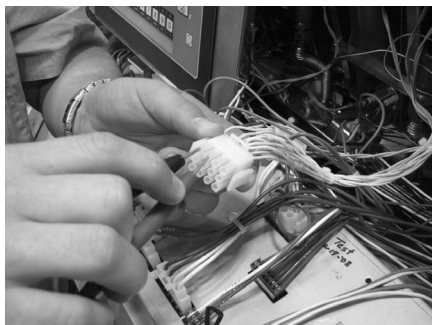

1. Using a Phillip’s-head screwdriver, or cordless drill, loosen the screw securing the top of the control panel and secure control panel in the slots of the shroud.
2. Pull the probe connector from the control panel and locate the terminals in the connector for the probe being tested. Attach meter leads onto those terminals and refer to the chart at left to determine if probe is good or not. (Probe wires are labeled, with #1 being the far left probe.)

Temp. F	Temp. C	Resistance Ohms	Temp. F	Temp. C	Resistance Ohms
50	10.00	1039.02	250	121.11	1464.79
60	15.56	1060.65	260	126.67	1485.71
70	21.11	1082.24	270	132.22	1506.58
80	26.67	1103.80	280	137.78	1527.43
90	32.22	1125.32	290	143.33	1548.23
100	37.78	1146.81	300	148.89	1569.00
110	43.33	1168.26	310	154.44	1589.73
120	48.89	1189.67	320	160.00	1610.43
130	54.44	1211.05	325	162.78	1620.77
140	60.00	1232.39	330	165.56	1631.09
150	65.56	1253.70	340	171.11	1651.72
160	71.11	1274.97	350	176.67	1672.31
170	76.67	1296.20	360	182.22	1692.86
180	82.22	1317.40	365	185.00	1703.13
185	85.00	1327.99	370	187.78	1713.38
190	87.78	1338.57	380	193.33	1733.87
200	93.33	1359.69	390	198.89	1754.31
210	98.89	1380.79	400	204.44	1774.72
212	100.00	1385.00	410	210.00	1795.10
220	104.44	1401.84	420	215.56	1815.44
230	110.00	1422.86	430	221.11	1835.74
240	115.56	1443.85	440	226.67	1856.01

**6-7. TEMPERATURE PROBE  
REPLACEMENT**  
**(Continued)**

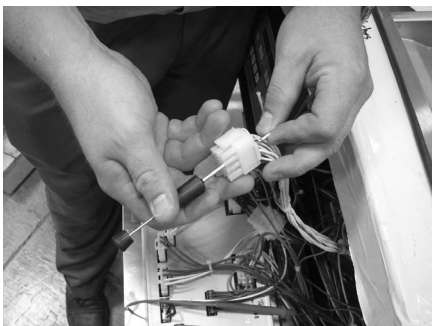
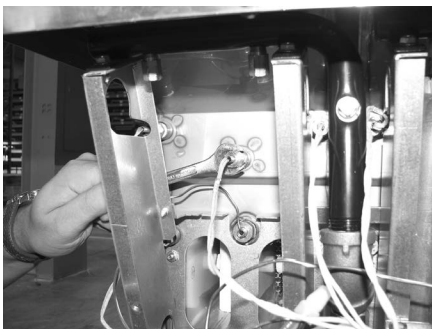
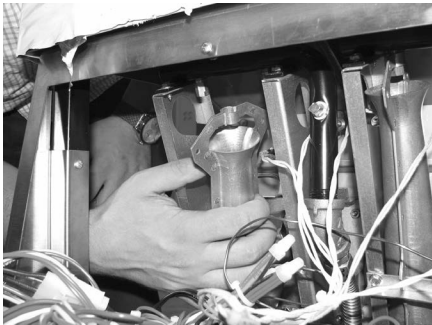
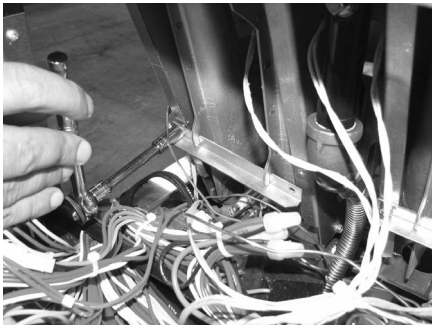

**Replacement:**

1. Pull-out on the drain valve knob and drain the oil from the vat.



**To avoid electrical shock or property damage, move the power switch to OFF and disconnect main circuit breaker, or unplug cord at wall receptacle.**

2. Using a 3/8" socket, remove the 2 screws securing the burner jet bracket and remove bracket.

3. Pull both burner jets from unit.

4. Using a 1/2" wrench, remove the nut on the compression fitting, and remove the temperature probe from the vat.

5. Using a terminal extractor, remove the probe terminals from the connector and pull remove probe from unit

**6-7. TEMPERATURE PROBE  
REPLACEMENT  
(Continued)**

- Place the nut and new ferrule on the new temperature probe and insert the temperature probe into the compression fitting. See drawing below.

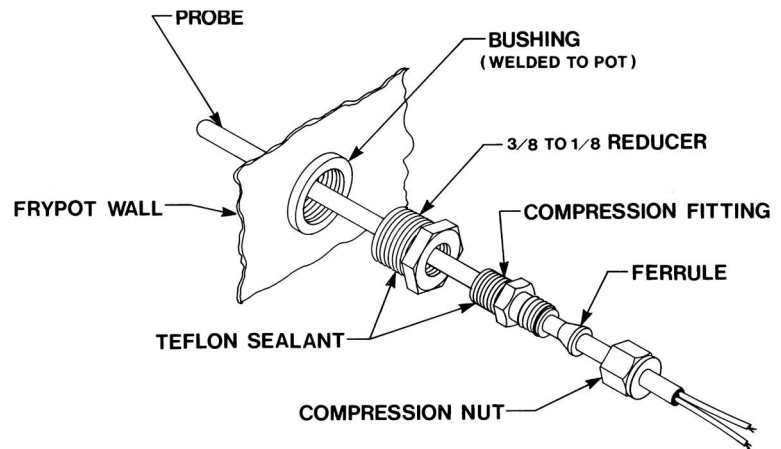

- Using the probe gauge in the kit, follow the instructions on drawing below.
- Hand-tighten compression nut and then a half turn with wrench.

**CAUTION**

*Excess force will damage temperature probe.*

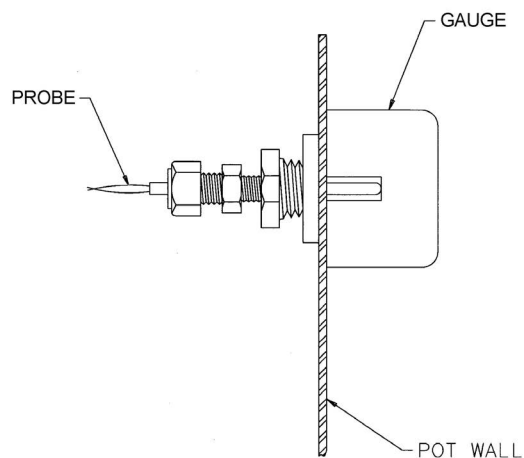

- NOTE:
- LOCATE TEMPERATURE PROBE THRU POT WALL.
  - PLACE GAUGE AGAINST POT WALL AS SHOWN.
  - PUSH TEMPERATURE PROBE THRU UNTIL IT MAKES CONTACT WITH GAUGE.
  - TIGHTEN TEMPERATURE PROBE IN PLACE.

**6-7. TEMPERATURE PROBE  
REPLACEMENT**  
**(Continued)**

9. Connect new temperature probe to the connector and fasten connector onto control panel.

10. Replace control panel and reconnect power to vat.

11. Fill vat by pressing and holding **F** button until \*FILTER\* \*MENU\* shows in the display. Then once “1.EXPRESS FILTER” shows in the display, press **▶** 4 times until “5.FILL FROM PAN” shows in the display. Press **√** button and “PUMP” “EXIT” shows in the display. Press **√** button again, and oil fills vat. Once vat is full, press **X** twice to return to normal operation.

**6-8. SOLENOID VALVES**

Each vat has a solenoid plumbed-into the oil return lines. They are normally closed, but open when power is supplied, such as, the controls are filling the vats.



**To avoid electrical shock or property damage, move the power switch to OFF and disconnect main circuit breaker, or unplug cord at wall receptacle.**

1. Remove both top and bottom rear panels, or a side panel, depending upon the location of the solenoid.

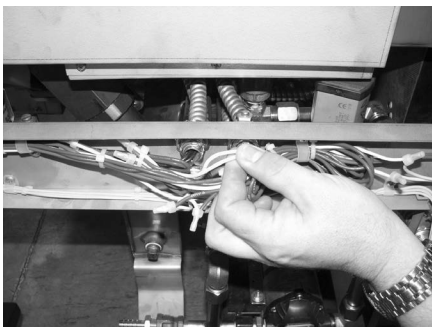

**Checkout**

2. Follow the wires from the solenoid and through the conduit and then cut the wires. Strip the wires back and take an ohm reading:

120 Volts - 60Hertz	50 Ohms
220-240 Volts -50/60 Hertz	230 Ohms

**6-8. SOLENOID VALVES**  
**(Continued)**



**Replacement:**

1. Using a 1 in. wrench, loosen the front and rear fittings to solenoid.



2. Remove the conduit from the fryer and pull the solenoid assembly from the fryer.



3. Remove the conduit from the solenoid.

**6-8. SOLENOID VALVES**  
**(Continued)**

4. Remove elbow and fittings from solenoid stem assembly and attach them to the new solenoid, using pipe sealant on the threads.
5. Reattach the conduit to the new solenoid, threading the wires through the conduit.
6. Reattach the solenoid assembly to the fryer.
7. Reattach the conduit to the fryer and connect the wires to the fryer using wire nuts.
8. Replace rear side panels or rear panels and reconnect power to the fryer.

**6-9. OIL CHANNEL**  
**CLEAN-OUT**

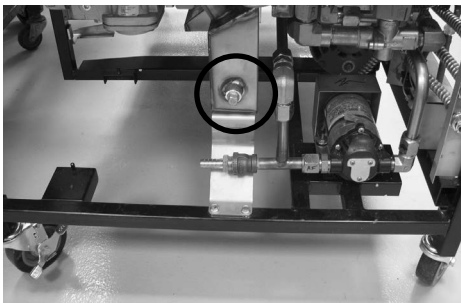

Should the drain channel, under the vats, become clogged, access to a clean-out plug is available on both right and left sides of the unit.

## **6-10. FILTER PUMP & MOTOR**

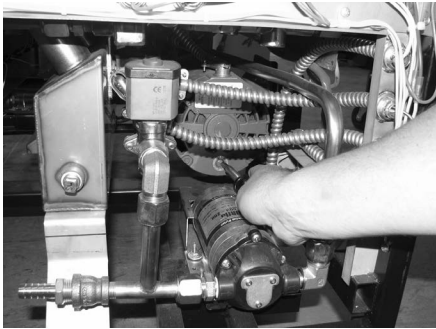

The 2 most common causes for a fryer not to pump oil are that the pump is clogged, or the thermal overload switch has been tripped on the motor. The pump and motor is located on the rear of the fryer.

To reset the thermal overload switch:

1. Remove the right side panel and locate the pump and motor in the rear of the fryer. If the motor is hot, allow it to cool for about 5 minutes.
2. Since it takes some effort to reset the switch, use a tool, such as a Phillip's-head screwdriver, to press against the reset button until a "click" is heard.



To remove debris from pump:

1. Loosen the four Allen head screws on the end of pump and remove the cover. (Removing the bottom rear panel may help in accessing the set screws.)
2. The inside is now exposed leaving a rotor and five teflon rollers. Clean the rotor and rollers.
3. To reassemble, place rotor on drive shaft, and place roller into rotor.

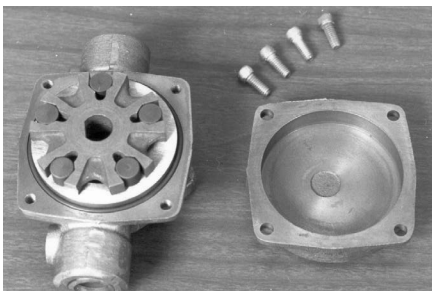

### **NOTICE**

A small amount of grease might be needed to hold the bottom roller into place until cover plate is put on. Make sure O-ring is in proper position on plate.

### **CAUTION**

*Indicators, on the side of the two halves of the pump, must align together.*

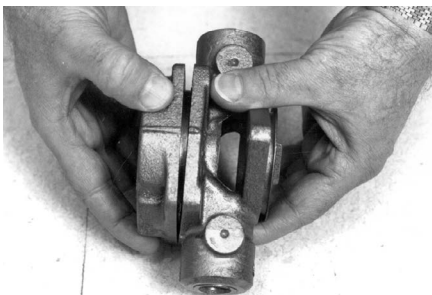

## **6-10. FILTER PUMP & MOTOR** **(Continued)**



To avoid electrical shock or property damage, move the power switch to OFF and disconnect main circuit breaker, or unplug cord at wall receptacle.

### **Removal:**

1. Remove the bottom, rear panel and the right side panel.
2. Using a 5/8" wrench, loosen the front, flexible line fitting, on the pump.
3. Using a 1" wrench, loosen the rear pump fitting.
4. Locate the appropriate conduit on the right side of the unit and disconnect the conduit from the fryer.
5. Using a 1/2 in. wrench, remove the 4 bolts securing the motor to the motor bracket and pull the pump and motor assembly from fryer.

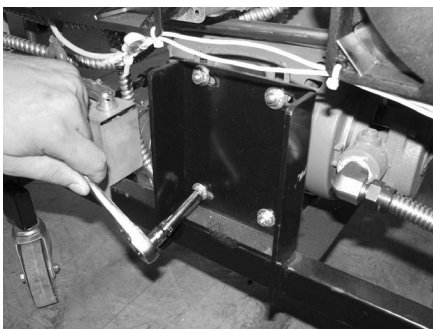
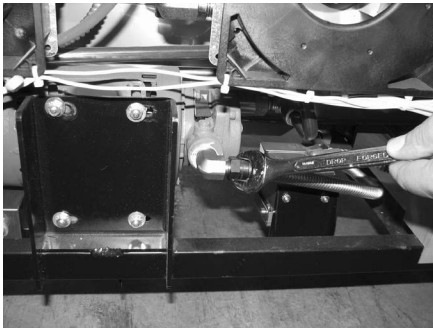

### To replace pump on motor:

1. Using a 1/2 in. wrench, remove the 2 bolts securing the pump to the motor and pull the pump from the motor.
2. Install a new seal kit (part no. [17476](#)) onto shaft of motor.
3. Align the shaft of the motor with the rotor on the inside of the pump and push pump onto shaft of motor.
4. Secure the pump onto the motor with the 2 bolts.

## 6-11. JIB PUMP

This pump keeps the vats filled and is used in the Automatic Intermittant Filter process.

### Replacement



**To avoid electrical shock or property damage, move the power switch to OFF and disconnect main circuit breaker, or unplug cord at wall receptacle.**

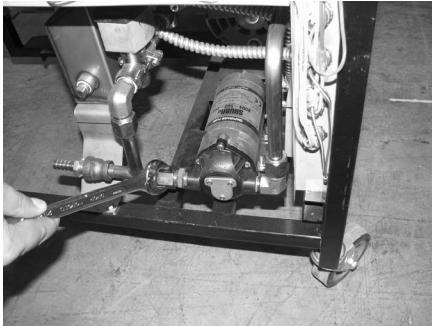

1. Remove the right side panel.
2. Using a 1" wrench, loosen both fitting on each side of the pump.
3. Using a Phillip's-head screwdriver, remove the 4 screws securing the bottom of pump.
4. Disconnect the wires in the rear of the pump and pull assembly from fryer.
5. Pull fittings from faulty pump and attach the fittings to the new pump, in the same orientation.
6. Install new pump assembly in fryer, in reverse order and then reconnect power to fryer.

## 6-12. EXPRESS FILTER PC BOARD

This electronic board controls the Automatic Intermittant Filtering process.

### Replacement



**To avoid electrical shock or property damage, move the power switch to OFF and disconnect main circuit breaker, or unplug cord at wall receptacle.**

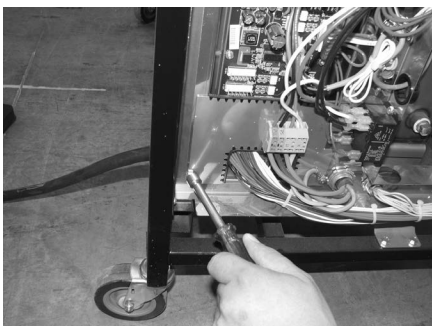

1. Remove the left side panel.
2. Using a 3/8" socket or nut driver, remove the nuts securing the cover and remove cover.
3. Pull connectors from PC board.
4. Using a 5/16" socket, remove the 6 nuts securing the board and remove it from the fryer.
5. Install in reverse order. The control connectors are colored-coded; Left-Red; Middle-White; Right-Blue.

## **6-13. TRANSFORMERS**

These components drop the line voltage to low voltage components such as, control board, AIF board and gas valves.

### **Replacement**



**To avoid electrical shock or property damage, move the power switch to OFF and disconnect main circuit breaker, or unplug cord at wall receptacle.**



**AIF Transformer**



**Control Transformer Connector**

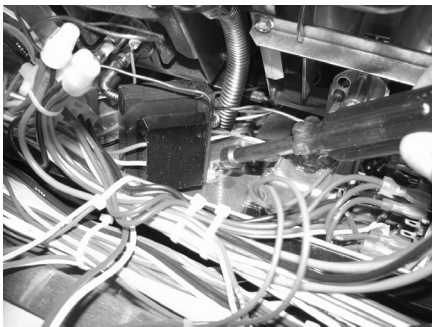

**Control Transformer**

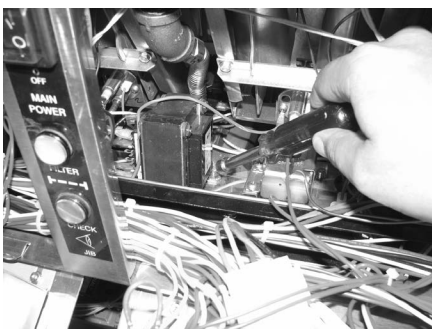

**AIF Transformer**

1. Pull-down the control panel to access the desired transformer.
2. Label and remove wires from (AIF) transformer, or disconnect the white connector on the control transformer.
3. Using a 5/16" socket, remove the nuts securing the transformer and pull the transformer from unit.
4. Replace transformer in reverse order.

### **6-14. FILTER MOTOR RELAY**

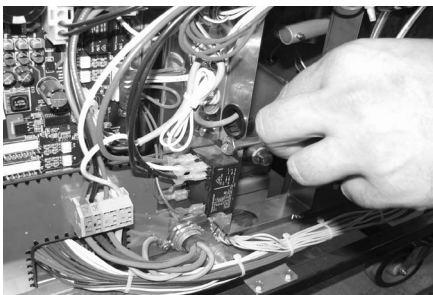
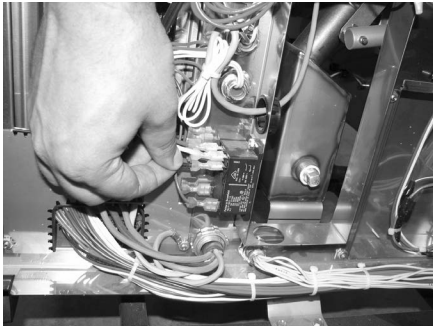

This component is located behind the left control panel and regulates voltage to the filter motor.

Replacement



To avoid electrical shock or property damage, move the power switch to OFF and disconnect main circuit breaker, or unplug cord at wall receptacle.

1. Remove left side panel.
2. Label and remove wires from relay.
3. Using a 5/16" wrench, remove the nuts securing the relay and remove relay from fryer.
4. Install new relay in reverse order.

### **6-15. GAS CONTROL VALVES**



The gas control valve assembly controls the flow of gas to the pilot and the main burner. The valve has two 24 volt coils, which are regulated by terminals PV and MV on the valve. For gas flow to the pilot, 24 VAC must be present between the PV and COM terminals. For gas flow to the main burner, 24 VAC must be present between the MV and COM terminals.



**TO AVOID INJURY, PROPERTY DAMAGE, OR EXPLOSION, BEFORE REPLACING STARTING THIS PROCEDURE, DO THE FOLLOWING:**

- **MOVE THE POWER/PUMP SWITCH TO THE "OFF" POSITION.**
- **DISCONNECT THE MAIN CIRCUIT BREAKER AT THE WALL, OR UNPLUG THE POWER CORD.**
- **TURN OFF THE MAIN GAS SUPPLY TO THE FRYER AND DISCONNECT AND CAP THE SUPPLY LINE TO FRYER.**

**6-15. GAS CONTROL VALVES**  
**(Control)**

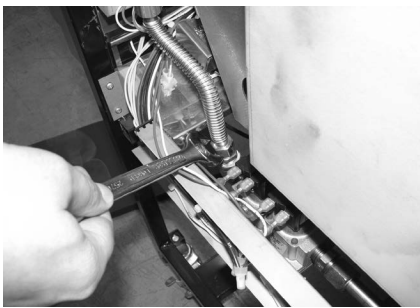

**Replacement:**

1. Remove the appropriate side panel and/or open the doors.
2. Label and remove wires from gas valve.
3. Using a 5/8" wrench, loosen the flexible gas line fitting.
4. Using a 1" wrench, loosen the rear fitting and pull assembly from the unit.
5. Pull fittings from gas valve and attach the fittings to the new gas valve, in the same orientation.
6. Install new gas valve in reverse order.

## 6-16. BLOWER MOTORS

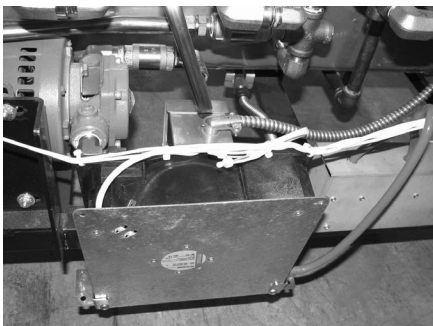
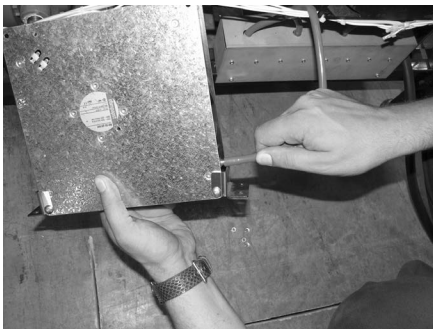
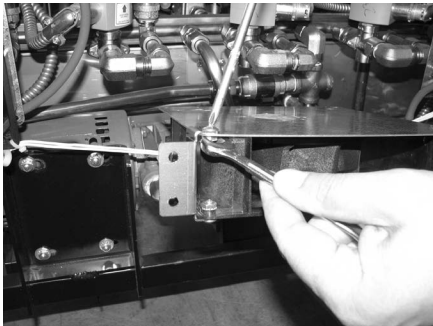
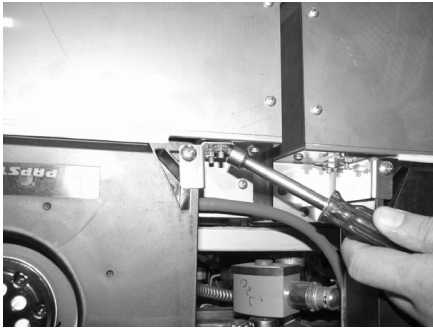

The blower motor assembly creates the draft for the burners. If the blower motor fails, the air switch fails to close, causing an “E-20B” error code in the display.

### Replacement



**To avoid electrical shock or property damage, move the power switch to OFF and disconnect main circuit breaker, or unplug cord at wall receptacle.**

1. Remove the bottom, rear panel.
2. Using a 3/8” socket or nut driver, remove the nuts securing the blower brackets to the fryer.
3. Remove the brackets from the blower.
4. Remove the pressure tube from the blower.
5. Locate and cut wires and remove blower from unit.
6. Connect the new blower motor wires to the fryer using wire nuts, and install the new blower motor in reverse order as above.

### NOTICE

Before installing the bottom, rear cover, clean the blower intake slots to ensure sufficient air flow to the blowers.



## **6-17. DRAIN PAN SWITCH**

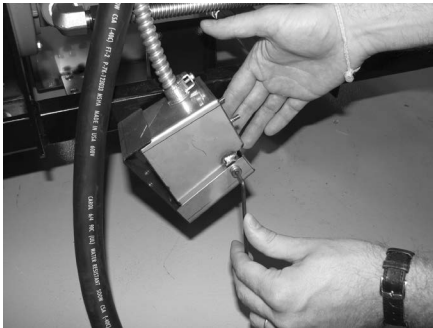
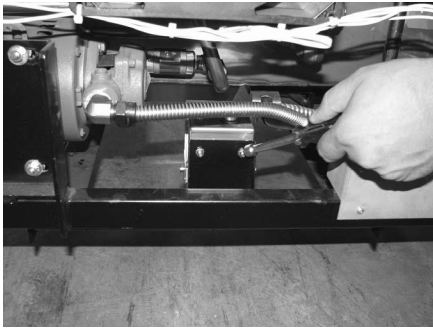

This switch closes when the drain pan is pushed properly in place under the fryer. If the drain pan is not properly in place, or the drain switch is faulty, display prompts such as, “CHECK PAN”; “FILTER PAN MISSING”; “CHANGE FILTER PAD” shows in the display.

### **Removal:**

1. Drain pan switch is located on the rear of the fryer. Using a 3/8” socket or nut driver, remove the nuts securing the drain switch bracket to the fryer.
2. Using a 1/8” Allen wrench, remove the shoulder bolt securing the cover and remove cover.
3. Using a Phillips-Head screwdriver, remove the screws securing the switch to the bracket and remove switch from bracket.
4. Label and remove wires from switch

### **Checkout:**

5. Check for continuity across the normally open and the common terminals of the drain switch. The circuit should show open and when the plunger is pressed, show closed. Replace switch if faulty, placing wires on new switch on the normally open and common terminals.

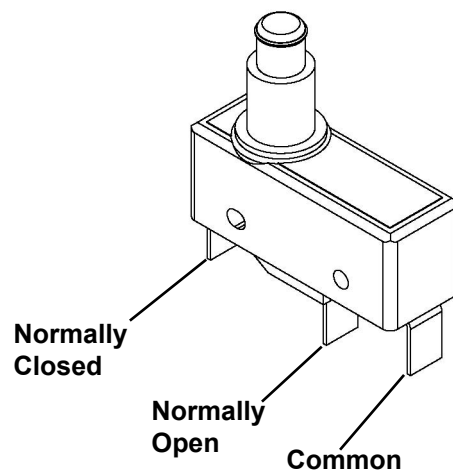

**6-18. FILTER BEACON™**

**Replacement**



**To avoid electrical shock or property damage, move the power switch to OFF and disconnect main circuit breaker, or unplug cord at wall receptacle.**

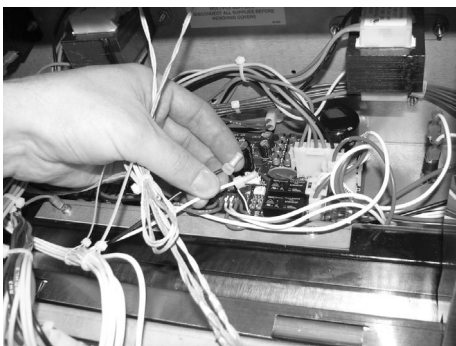
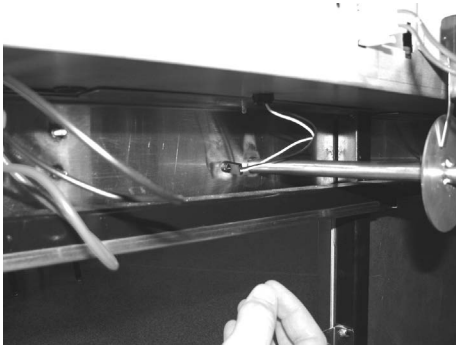

1. Remove right or left side panel for end vats, or hinge-down the control panel for center vats.

2. Pull apart the light by pulling on the rear of the light and removing the front part of the light from the front of the fryer.

3. Locate and cut the light wires and pull the light from unit.

4. Connect new light wires, using wirenuts and install light in reverse order.

5. Restore power to the unit.

## **6-19. AIR PRESSURE SWITCHES**

The vacuum switch senses the flow of air coming from the blower. If the airflow is reduced below a set amount, the switch cuts power to the control valve, which shuts the burners down.

### **Replacement:**



**To avoid electrical shock or property damage, move the power switch to OFF and disconnect main circuit breaker, or unplug cord at wall receptacle.**

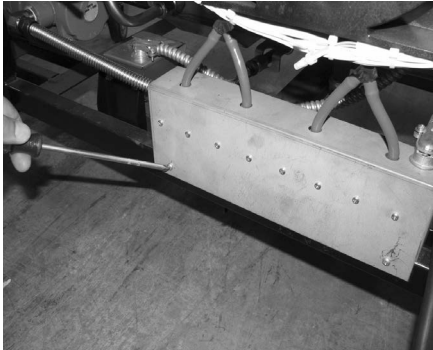

1. Air switches are located on the rear of the fryer. Using a Phillip's-Head screwdriver, remove the 2 screws securing the outer cover and remove cover.

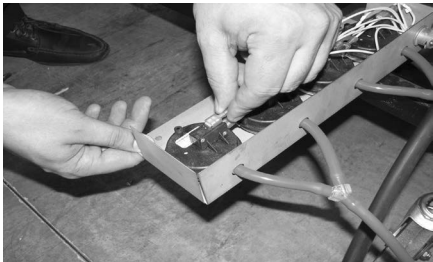

2. Label and pull wires from switch.

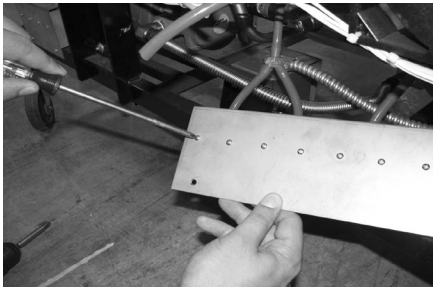

3. Pull tube from switch and using a Phillip's-Head screwdriver, remove the 2 screws securing the switch to the bracket and remove switch.

4. Install new switch in reverse order and restore power to unit.

## 6.20. IGNITOR & FLAME SENSOR ASSEMBLY

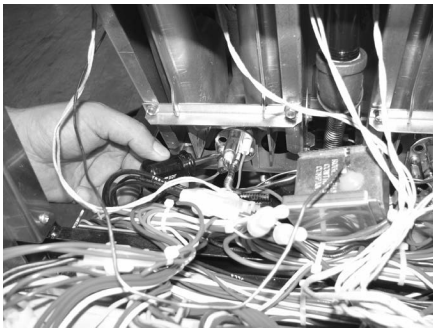
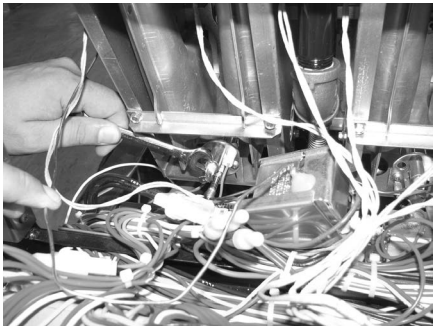
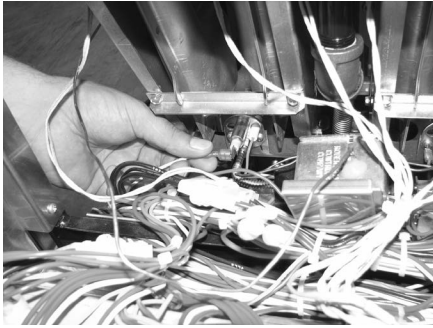

The flame sensor should glow a bright red when the pilot is lit and allows the gas control valve to open. If it does not sense a flame, it shuts off the gas control valve.

### **Flame Sensor Replacement:**

1. Remove control panel.
2. Pull wire from flame sensor.
3. Using a 7/16" wrench, remove the nut securing the flame sensor and pull the sensor from the unit.
4. Install new flame sensor in reverse order.

### **Ignitor Replacement:**



**TO AVOID INJURY, PROPERTY DAMAGE, OR EXPLOSION, BEFORE STARTING THIS PROCEDURE, DO THE FOLLOWING:**

- **MOVE THE POWER/PUMP SWITCH TO THE "OFF" POSITION.**
  - **DISCONNECT THE MAIN CIRCUIT BREAKER AT THE WALL, OR UNPLUG THE POWER CORD.**
  - **TURN OFF THE MAIN GAS SUPPLY TO THE FRYER AND DISCONNECT AND CAP THE SUPPLY LINE TO FRYER.**
1. Follow steps 1 to 3 above.
  2. Using a 7/16" wrench, loosen the pilot, gas line fitting.
  3. Using a small Phillip's-Head remove the 2 screws securing the ignitor assembly.
  4. Pull wire from ignition module and remove ignitor assembly from unit.
  5. Install new ignitor assembly in reverse order.

## **6-21. IGNITION MODULES**

During normal operation, the ignition modules send 24 volts to the ignitors and gas control valve. If a module does not sense a pilot flame, the module starts the ignition process again. But, if a pilot light goes out for longer than 15 seconds, or it goes out 3 times within 15 seconds, the module keeps the 24 volts from reaching the gas control valve. The burners shut down.

**Replacement:**



**To avoid electrical shock or property damage, move the power switch to OFF and disconnect main circuit breaker, or unplug cord at wall receptacle.**

1. Open the left door and using a Phillip's-Head screwdriver, remove the screws securing the module cover and remove cover.

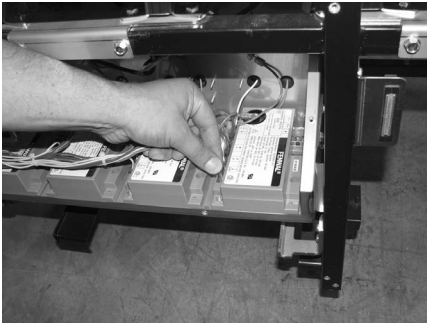

2. Label and pull the wires from the module.

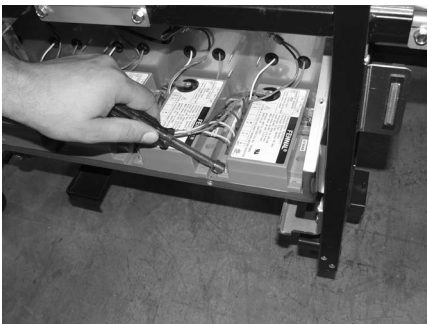

3. Using a 3/8" socket or nut driver remove the nuts securing the module and remove module from unit.
4. Install new module in reverse order and restore power to the unit.

**6-22. PRESSURE  
TRANSDUCER**

This component controls the AIF filter pump by sensing the pressure in the expansion chamber.

Voltage range is 0.5 to 4.5 VDC, corresponding to a pressure range of 0 to 30 PSIG

A measured pressure below -1.5 PSI or above 32 PSI may indicate a failed transducer, it has become disconnected, or a clogged expansion chamber.

**NOTICE**

To view the the pressure, press ◀ ▶ at the same time and “\*INFO\* \*MODE\*” shows in the display, followed by “1. E-LOG”. Press ▶ until “15. AIF” shows in the display. Press ▼ until “PRESSURE SENSOR” shows in the left display. Press X button to show pressure in PSI.

An over-pressure issue can also indicate a return valve failing to open, instead of a faulty transducer or a clogged chamber.

In case of a clogged expansion chamber, remove the clean-out plugs at each end of the chamber to clean the obstructions inside the chamber. Photo at left.

Extra long fill times or oil bubbling at the end of an AIF cycle may be signs of a clogged expansion chamber or faulty transducer.

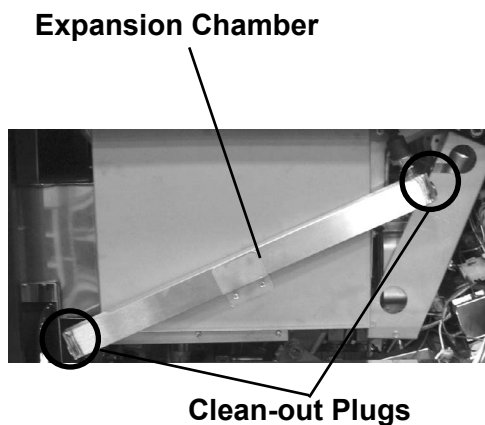

**Replacement:**



**To avoid electrical shock or property damage, move the power switch to OFF and disconnect main circuit breaker, or unplug cord at wall receptacle.**

1. Remove the left side panel.
2. Pull-out on the clip, while pushing up on the wire harness connector, at the top of the transducer, to remove wires.
3. Using a 1-1/16” wrench, remove the transducer from the expansion chamber.
4. Using pipe thread sealant, install new transducer in reverse order and restore power to the unit.

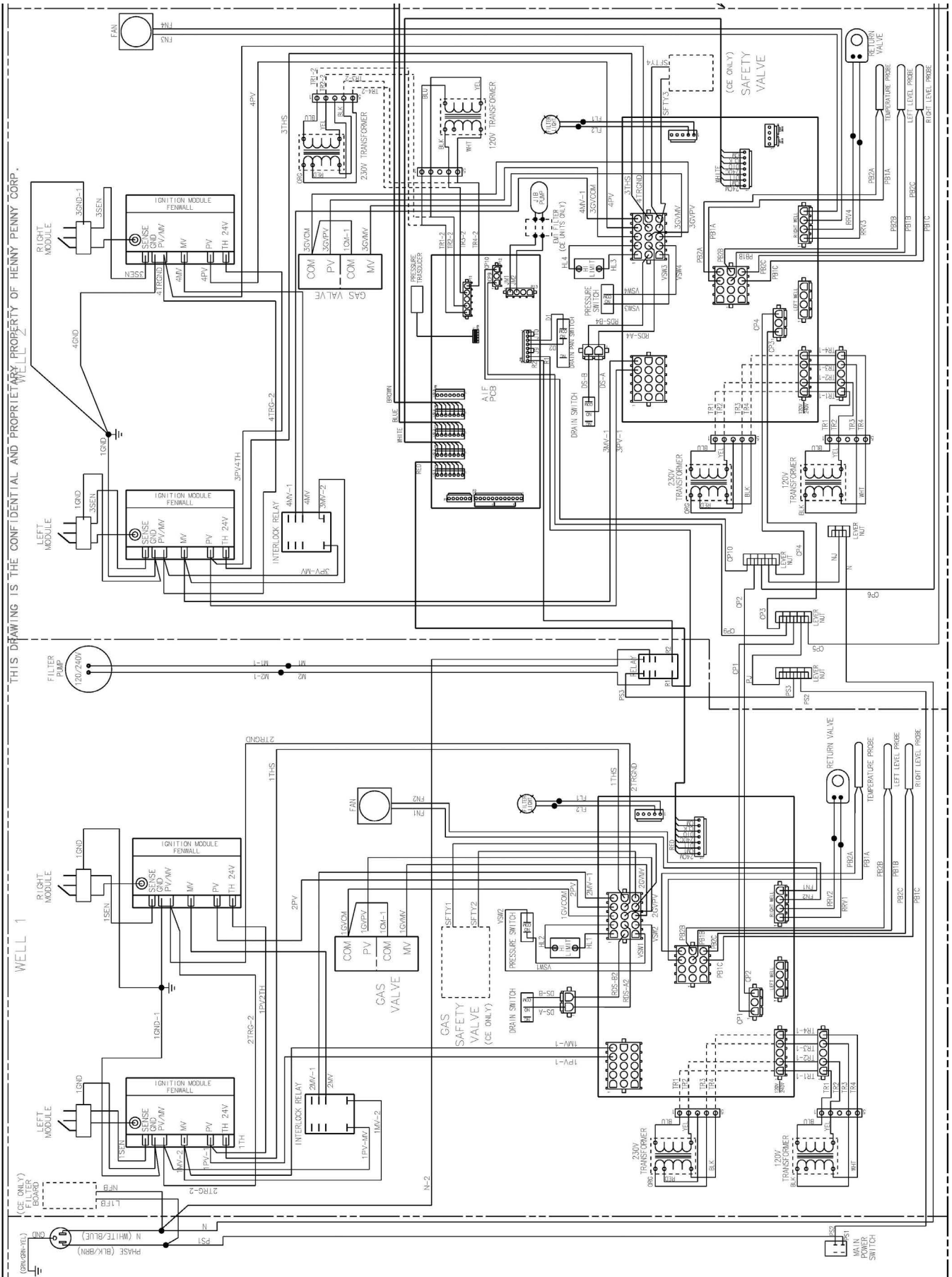

**83289 - 1 & 2 WELL - FULL VAT (3 & 4 WELL SEE NEXT PAGE)**



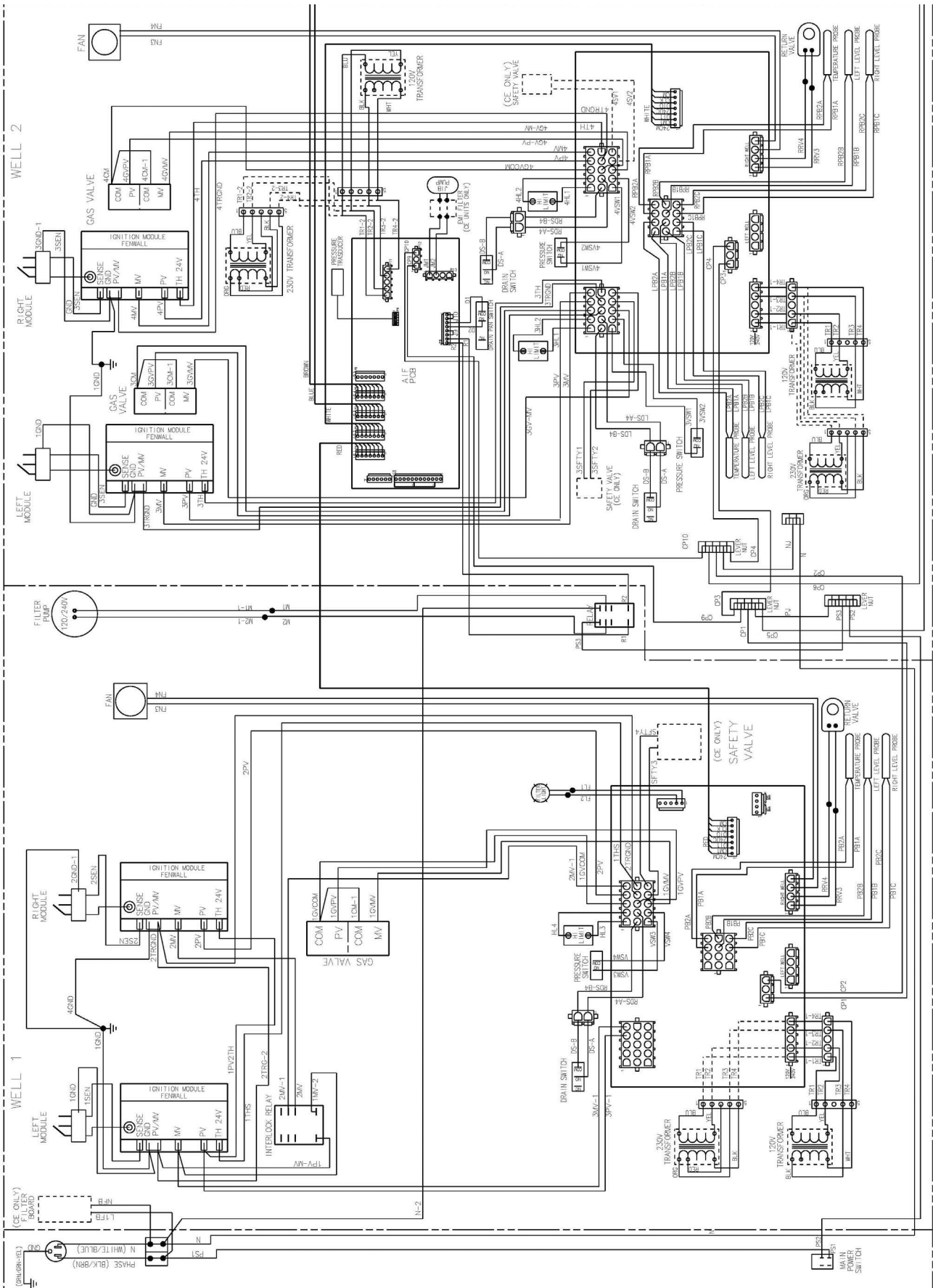

**84138 - 1 & 2 WELL - FS (3 & 4 WELL SEE NEXT PAGE)**



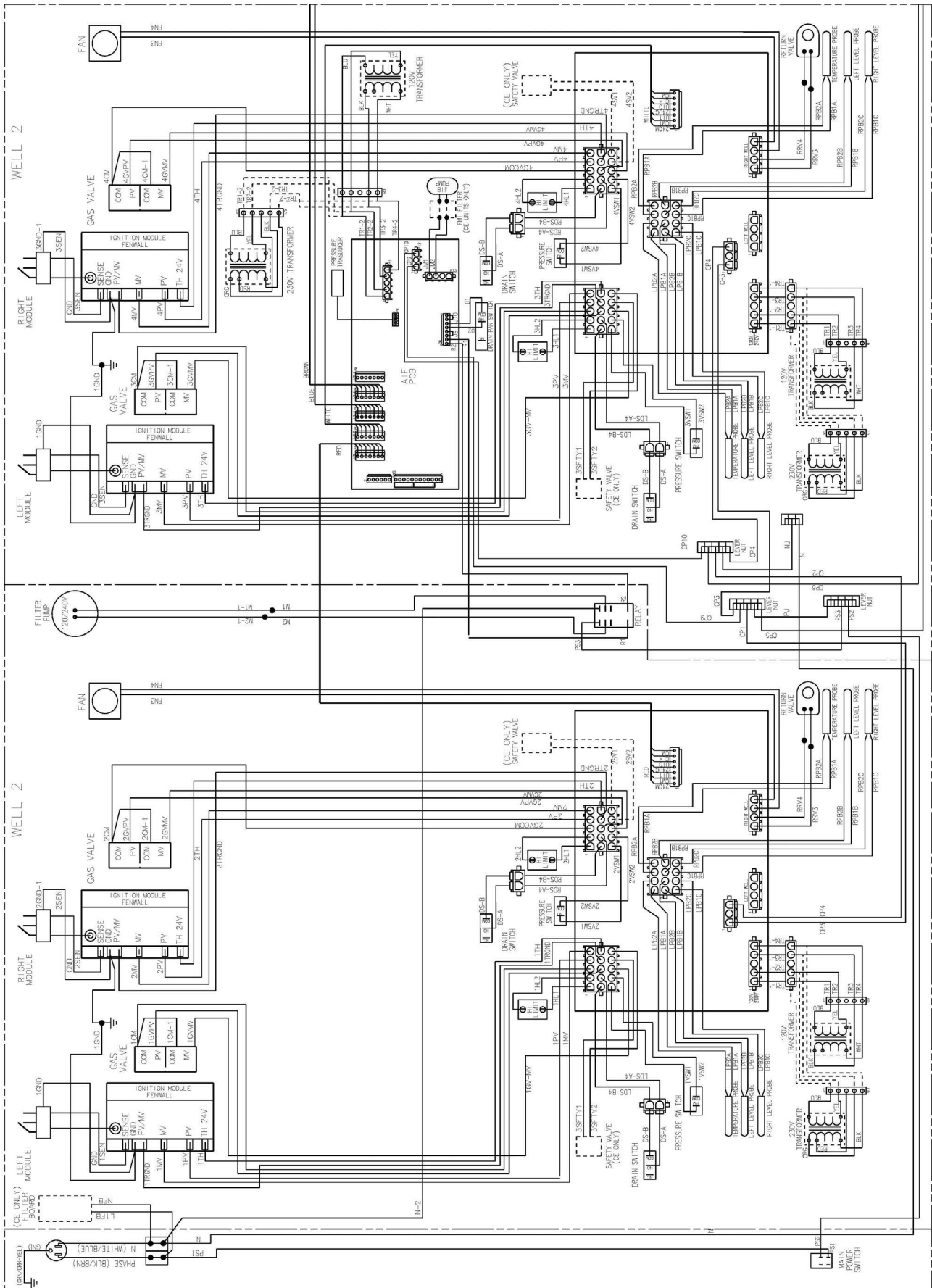

**84248 - 1 & 2 WELL - SPLIT VAT (3 & 4 WELL SEE NEXT PAGE)**



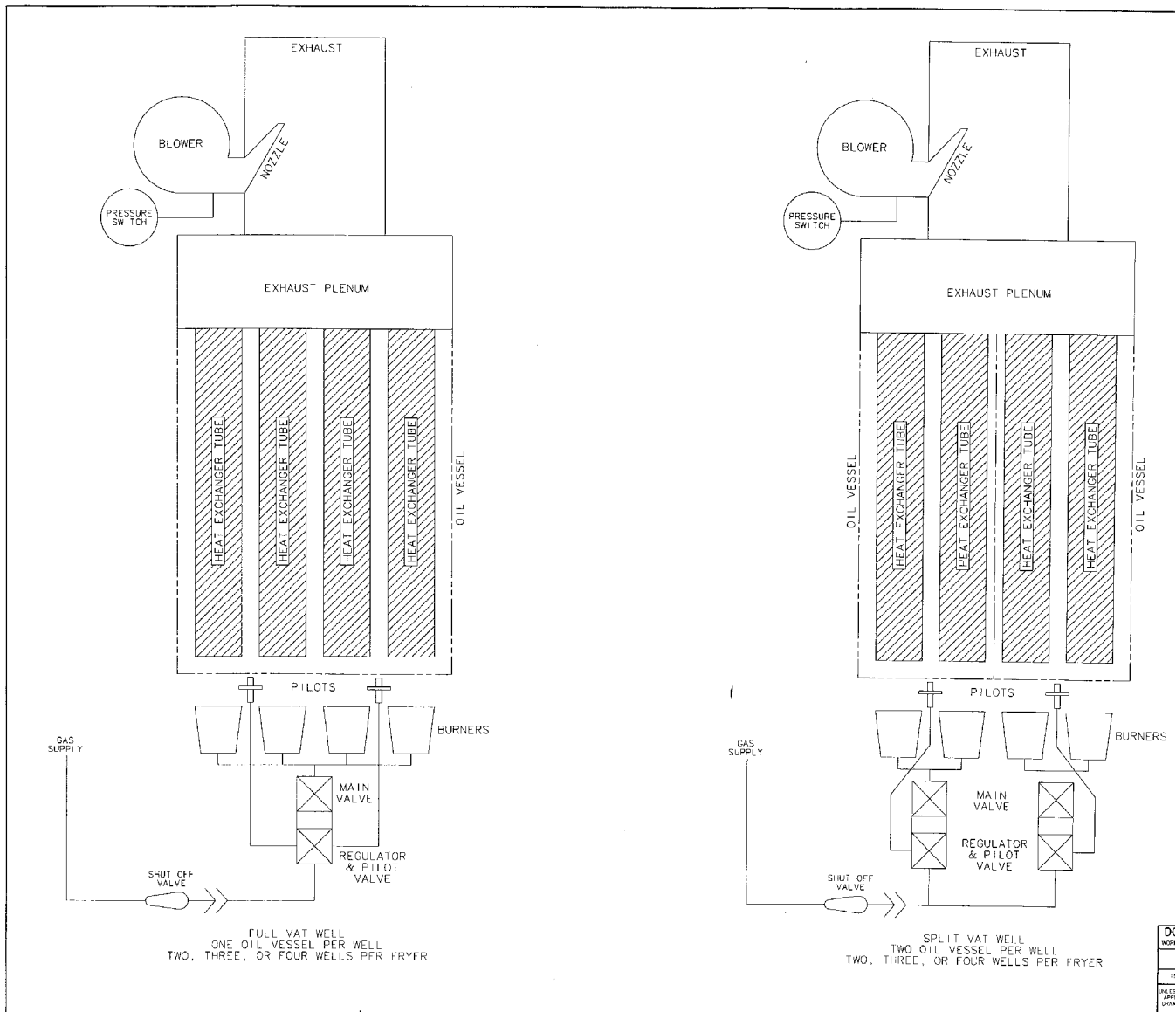

## **SECTION 7. PARTS INFORMATION**

### **7-1. INTRODUCTION**

This section lists the replaceable parts of the Henny Penny Model EEG fryer.

### **7-2. GENUINE PARTS**

Use only genuine Henny Penny parts in your fryer. Using a part of lesser quality or substitute design may result in damage to the unit or personal injury.

### **7-3. WHEN ORDERING PARTS**

Once the parts that you want to order have been found in the parts list, write down the following information:

Example:

Item Number	2
Part Number	60241
Description	High Limit

From the data plate, list the following information:

Example:

Product Number	01100
Serial Number0	001
Voltage	208

### **7-4. PRICES**

Your distributor has a price parts list and will be glad to inform you of the cost of your parts order.

### **7-5. DELIVERY**

Commonly replaced items are stocked by your distributor and will be sent out when your order is received. Other parts will be ordered, by your distributor, from Henny Penny Corporation. Normally, these will be sent to your distributor within three working days.

### **7-6. WARRANTY**

All replacement parts (except lamps and fuses) are warranted for 90 days against manufacturing defects and workmanship. If damage occurs during shipping, notify the carrier at once so that a claim may be properly filed. Refer to warranty in the front of this manual for other rights and limitations.

### **7-7. RECOMMENDED SPARE PARTS FOR DISTRIBUTORS**

Recommended replacement parts, stocked by your distributor, are indicated with √ in the parts lists. Please use care when ordering recommended parts, because all voltages and variations are marked. Distributors should order parts based upon common voltages and equipment sold in their territory.

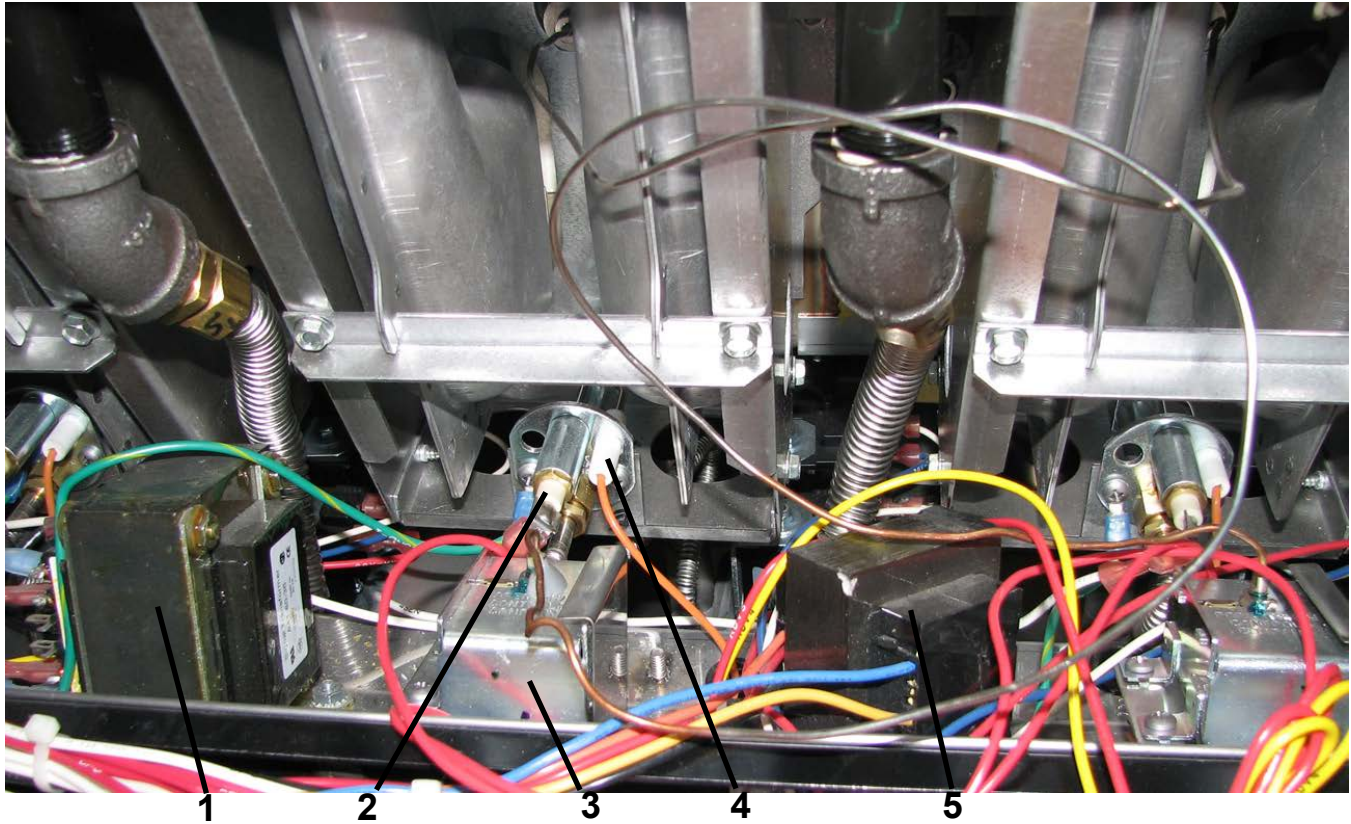

Item No.	Part No.	Description	Quantity
√ 1	TS22-012	TRANSFORMER - AIF .....	1
√ 2	76978	FLAME SENSOR.....	1/vat
√ 3	16738	HIGH LIMIT - 450°F.....	1/vat
√ 4	75854	ASSY - SPARK IGNITOR (PILOT) .....	1/vat
√ 5	84391	TRANSFORMER - 120 VOLT .....	1/vat
√ 5	80375	TRANSFORMER - 230 VOLT .....	1/vat
6	76921	ORIFICE - BRASS (See chart below).....	4/VAT

PART NO.	DIMENSION "A" ORIFICE DRILL SIZE (ORIFICE DIAMETER)	GAS TYPE	ALTITUDE
76921-001	#45 (ø.082)	NATURAL	<5301
		I2H, I2E	
76921-002	1.30mm (ø.0512)	PROPANE	ALL
		I3P	
76921-003	#44 (ø.086)	NATURAL	5302 - 7701
76921-004	#43 (ø.089)	NATURAL	7702 - 10101
76921-005	#42 (ø.0935)	I2S	
76921-006	#51 (ø.067)	I2E+	
76921-007	2.30mm (ø.0906)	I2L	
76921-008	1.25mm (ø.0492)	I3B/P	

√ recommended parts

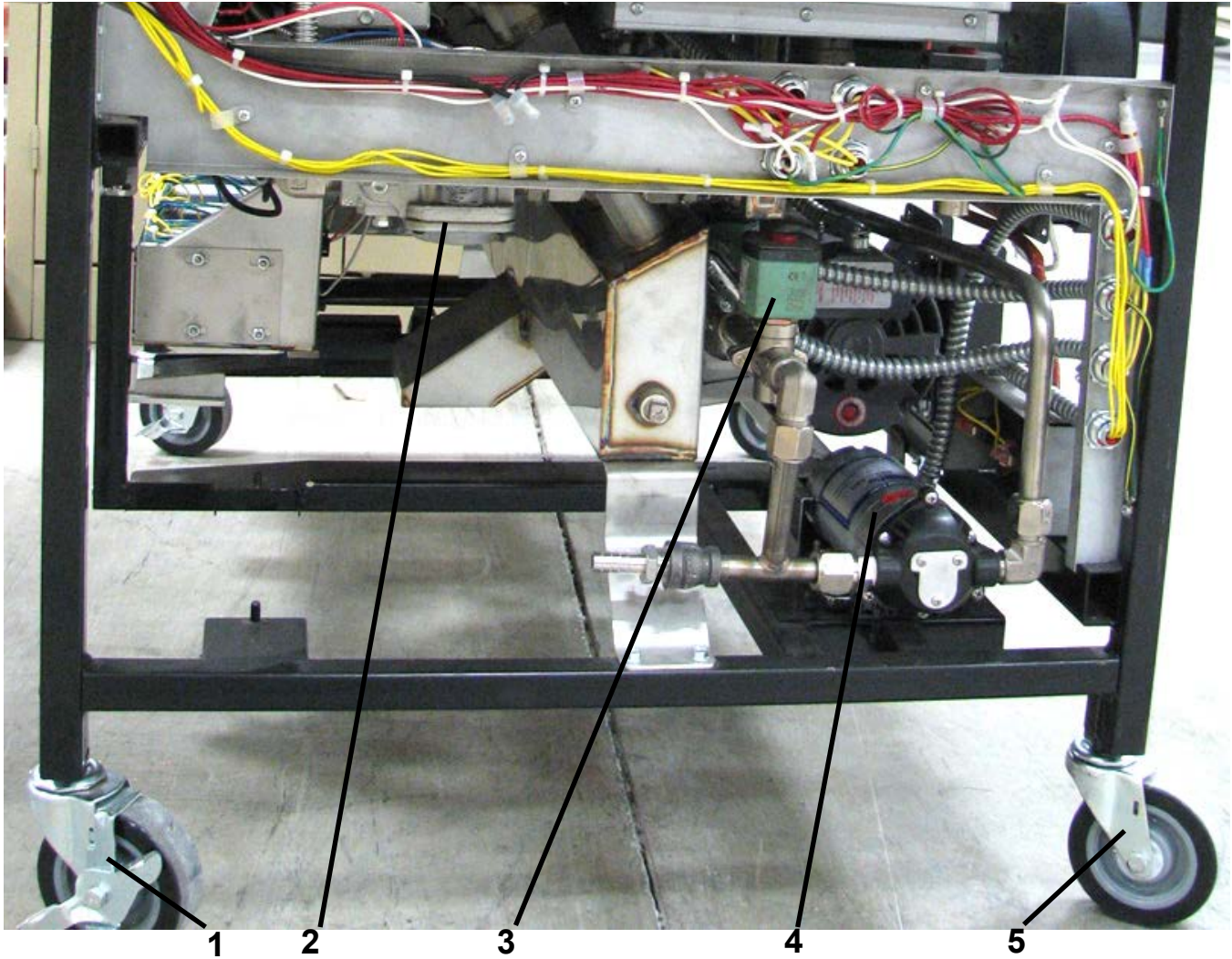

Item No.	Part No.	Description	Quantity
1	77679	CASTER - 4" .....	2
√ 2	78118	VALVE - GAS CONTROL - NAT .....	1/vat
√ 2	78517	VALVE - GAS CONTROL - LP .....	1/vat
√ 3	73647	SOLENOID - ASCO - 120V (JIB Solenoids) .....	2
√ 3	74582	SOLENOID - ASCO - 230V (JIB Solenoids) .....	2
√ 4	73473	PUMP - OIL TOP OFF - 120V .....	1
√ 4	74583	PUMP - OIL TOP OFF - 230V .....	1
5	77575	CASTER - 4" - W/BRAKE .....	2

√ recommended parts

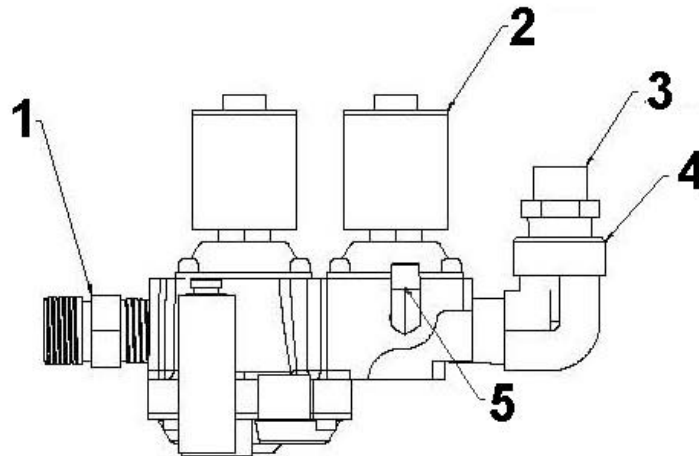

**NON-CE GAS VALVE ASSEMBLY**

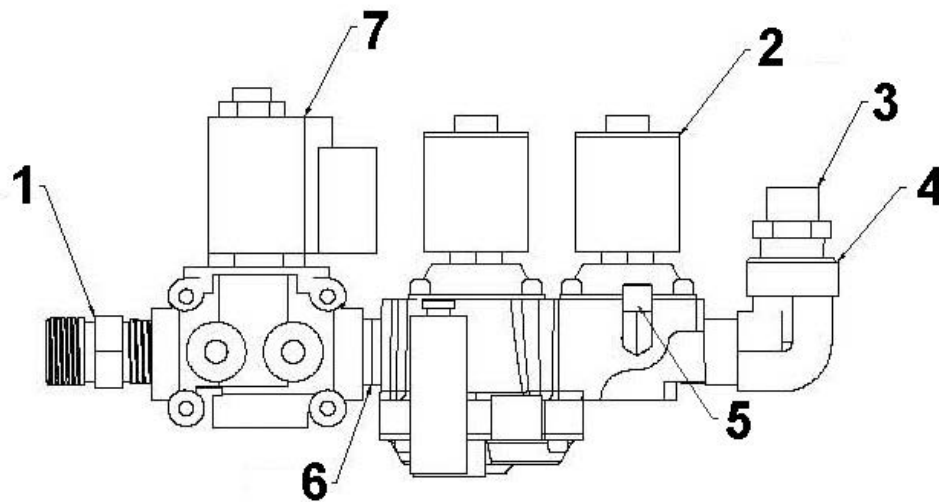

**CE GAS VALVE ASSEMBLY**

Item No.	Part No.	Description	Quantity (per assy)
1	16807	FITTING - MALE CONNECTOR.....	1
√ 2	78118	VALVE - GAS CONTROL - NAT.....	1
√ 2	78517	VALVE - GAS CONTROL - LP.....	1
3	FP01-211	CONNECTOR - MALE 1/2 TUBE TO 1/2 NPT.....	1
4	16239	ELBOW - STREET - 90 DEGREES.....	1
5	FP05-004	ELBOW - 1/4 TUBE TO 1/8 PIPE Z.....	2
6	FP01-028	NIPPLE - CLOSE 1/2 NPT SS 1 LG.....	1
√ 7	34802	VALVE - SOLENOID GAS - 24V - 50/60 HZ.....	2



Item No.	Part No.	Description	Quantity
√ 1	84454RB	PC BOARD - AIF FILTER .....	1
√ 2	79213	TRANSDUCER - PRESSUER 30 PSI .....	1
√ 3	ME90-008	RELAY - PUMP MOTOR - 12 VDC - 30 AMP .....	1
4	84384	HARNESS - PRESSURE TRANSDUCER .....	1
5	51065	ASSY-EMC FILTER BOARD (not shown).....	1
6	80373	BLOCK - TERMINAL POWER - CE (not shown).....	1

√ recommended parts

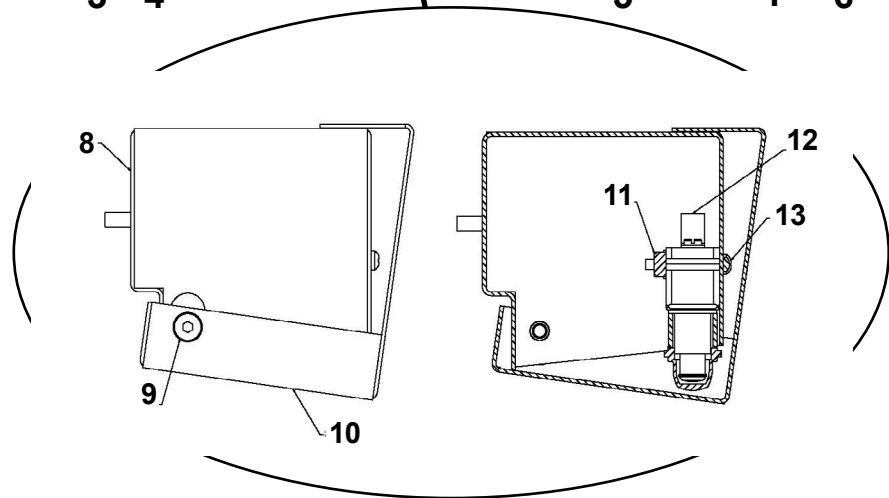
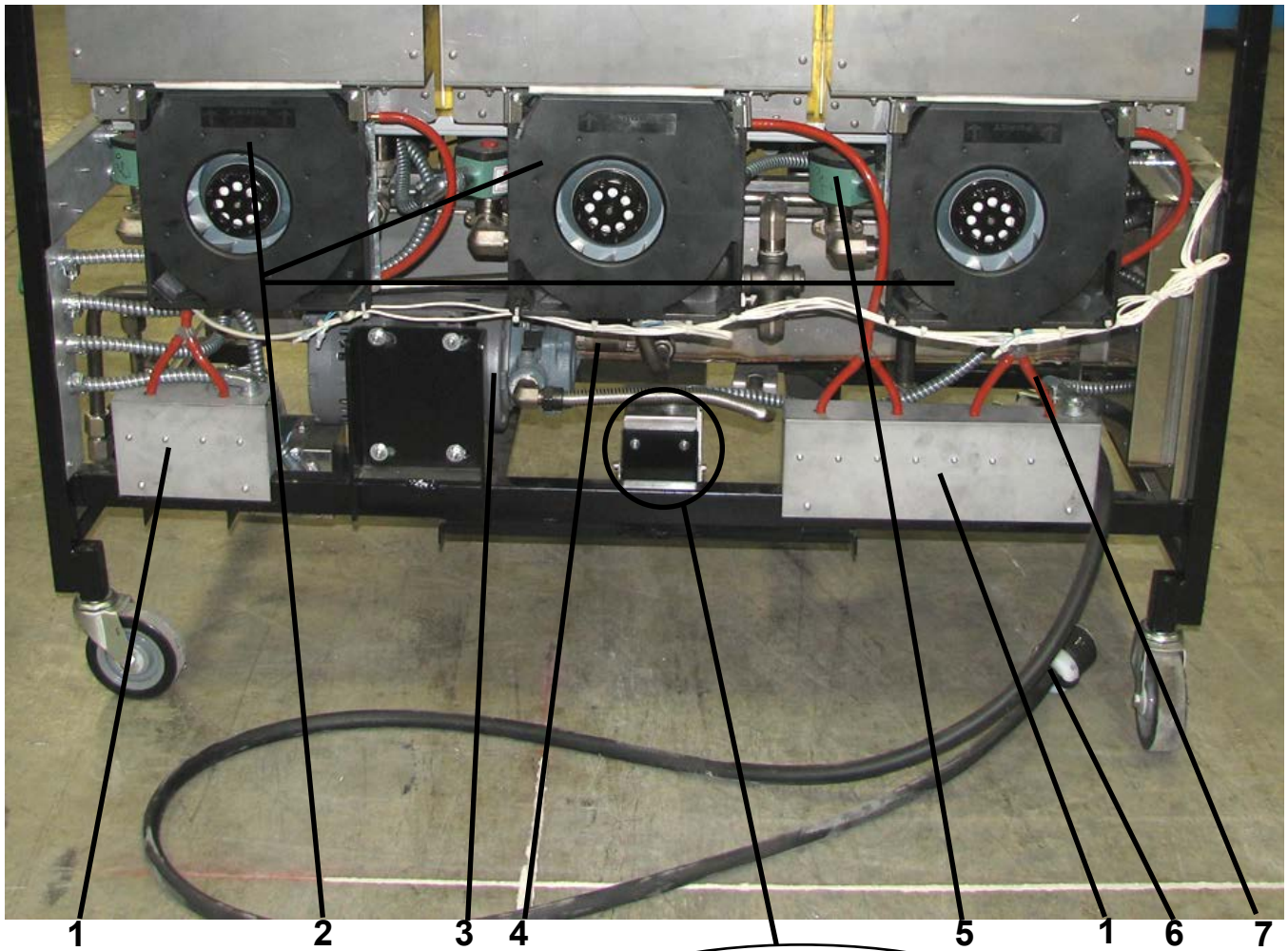

<b>Item No.</b>	<b>Part No.</b>	<b>Description</b>	<b>Quantity</b>
√ 1	77992	SWITCH - PRESSURE - 0.80 (behind covers).....	1/vat
√ 2	77826-001	MOTOR - BLOWER - 230V.....	1/full; 1/split
√ 2	77826-002	MOTOR - BLOWER - 120V.....	1/full; 1/split
3	67589	PUMP & MOTOR ASSY...(See page 8-18 for details).....	1
√	67583	MOTOR - 1/2 HORSE.....	1
	17437	PUMP - FILTER.....	1
	17476	SEAL KIT.....	1
√ 4	74469	VALVE - CHECK - 1/2" (Vat Fill).....	1/vat
√ 5	73647	SOLENOID - ASCO - 120V (return valves).....	1/vat
√ 5	74582	SOLENOID - ASCO - 230V (return valves).....	1/vat
	140229	---KIT- SOLENOID REPAIR.....	A/R
6	73517	ASSY - POWER CORD 120V.....	1
7	79443	TUBE - PRESSURE SWITCH (see chart below).....	AR
8	80154	WELD ASSY - SWITCH HSG W/BOOT.....	1
9	SC06-070	SCREW - 1/4 DIA X 1/8 L SHLDR SS.....	2
10	80156	COVER - SWITCH HOUSING W/BOOT.....	1
11	NS02-005	NUT - HEX KEPS #6-32 C.....	2
√ 12	80148	ASSY-DRAIN SWITCH W/BOOT.....	1
13	SC01-058	SCREW - #6-32 X 1 PH PHD C.....	2
√ 14	MS01-572*	PRIMER - LOCTITE - .8 OZ. CAN (for check valve threads).	1
√ 15*	76095	VALVE-DRAIN ORING SEAL.....	A/R
16	50764	MICROSWITCH-RIGID LEVER.....	A/R

PART NO.	" A "
79443-1	2.500
79443-2	13.000
79443-3	19.000
79443-4	16.000
79443-5	26.000
79443-6	14.000

√ recommended parts  
\*not shown

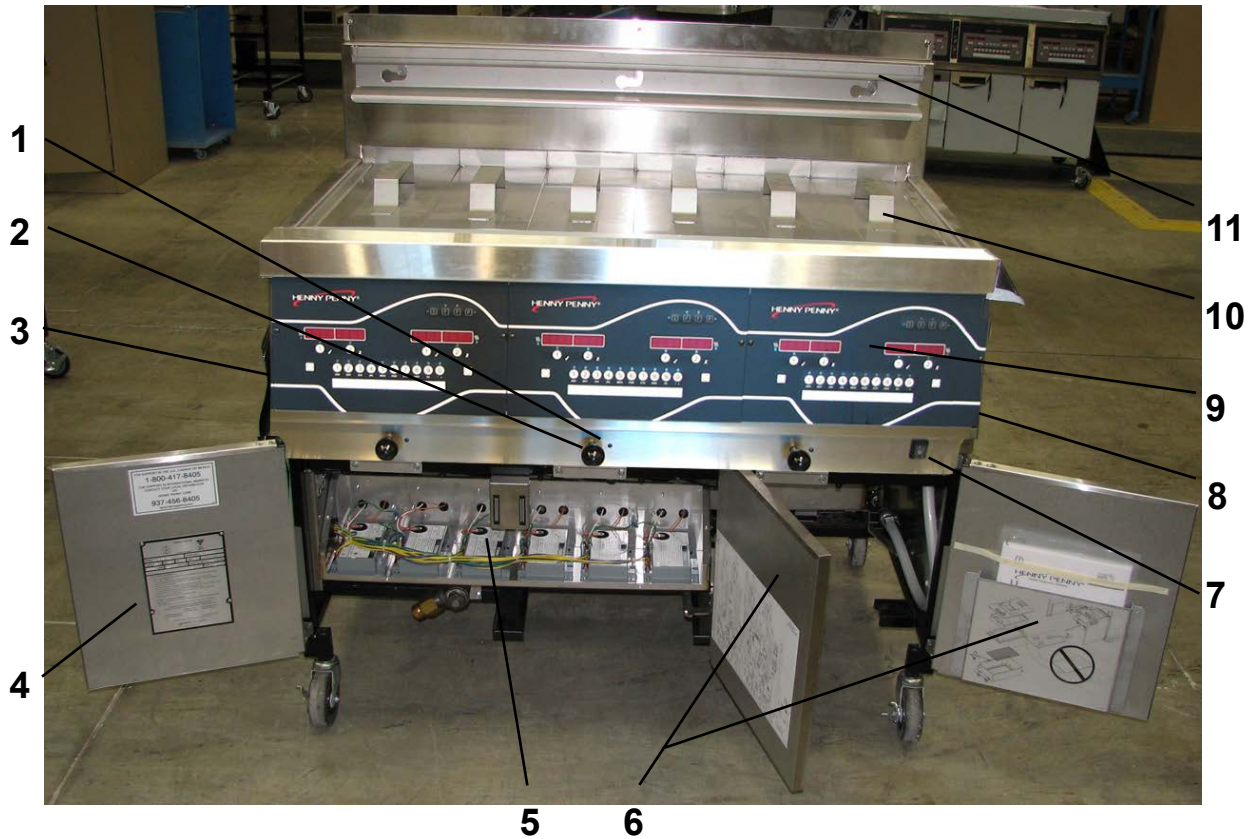

Item No.	Part No.	Description	Quantity
√ 1	81980	LED - 5 mm BLUE .....	1/vat
2	16101	KNOB - SPINDLE - BLACK.....	1/vat
3	76930	PANEL-LH SIDE .....	1
4	81185	ASSY-LH DOOR .....	1
4	81847	ASSY-LH DOOR - EEG-144 ONLY.....	1
√ 5	77839	MODULES - IGNITION.....	1/vat
6	81190	ASSY - RH DOOR .....	1 or 2
√ 7	52224	SWITCH - POWER.....	1
8	76931	PANEL-RH SIDE .....	1
√ 9	81943RB	ASSY - CONTROL - EEX .....	A/R
9	84417RB	ASSY-EVOLUTION ELITE AUTO CONT.....	A/R
10	03647	COVER - SPLIT VAT.....	1/vat
10	03646	COVER - FULL VAT.....	1/vat
11	77842	HANGER-BASKET - EEG-142.....	1
11	77709	HANGER-BASKET - EEG-143.....	1
11	77934	HANGER-BASKET - EEG-144.....	1

√ recommended parts

Pivot Stop Drain Handle				
Models	Kit / Part Numbers			
		74626 17255 NS03-103	81753 17255 NS03-103	140175
<i>Full &amp; Split Vats:</i> EEg-141, 142, 143 & 144		SN: BW1201006 & After (Jan. 23, 2012)		Before SN: BW1201006

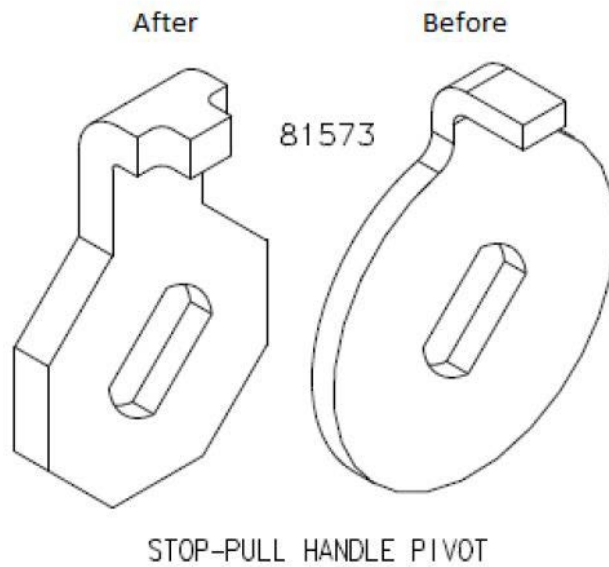

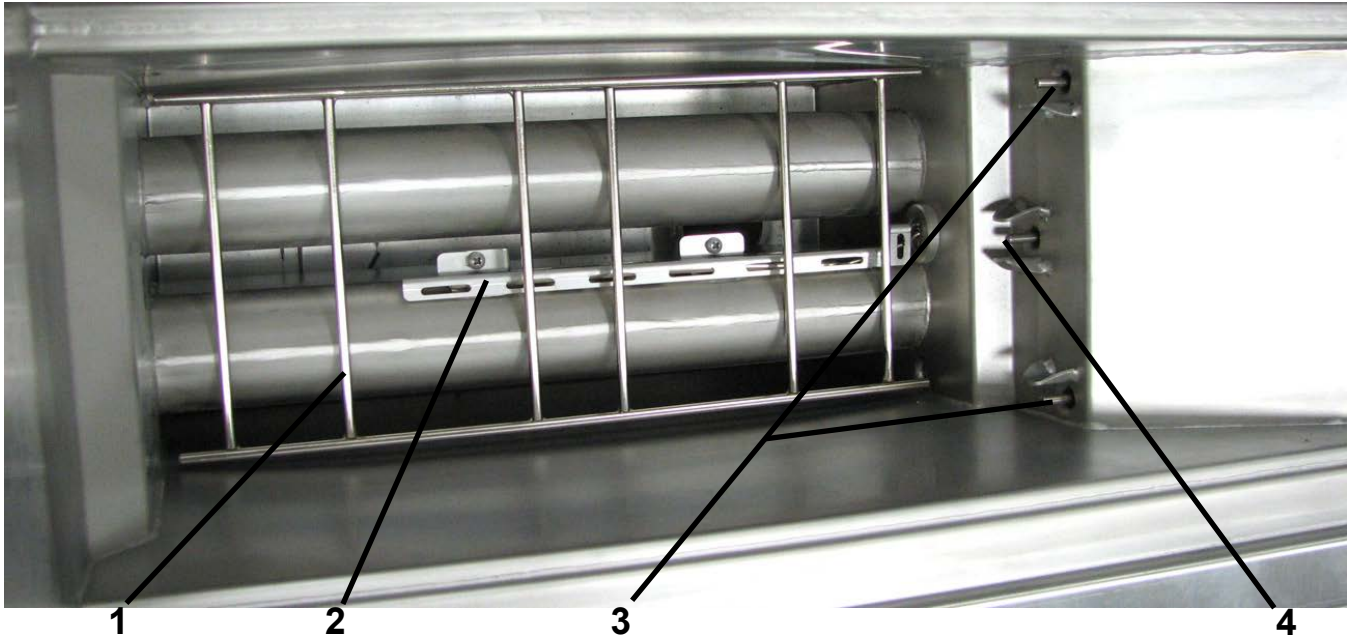

Item No.	Part No.	Description	Quantity
√ 1	76980	RACK - SPLIT VAT .....	1/vat
√ 1	76982	RACK - FULL VAT .....	1/vat
2	77061	GUARD - HIGH LIMIT .....	1/vat
√ 3	14974	PROBE - LEVEL SENSE - 2.5 in. ....	2/vat
√ 4	14974	PROBE - TEMPERATURE - 2.5 in. ....	1/vat

√ recommended parts

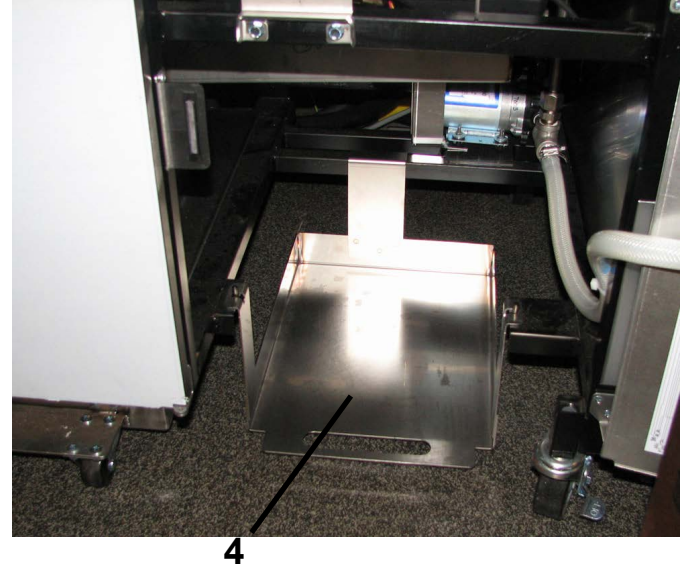
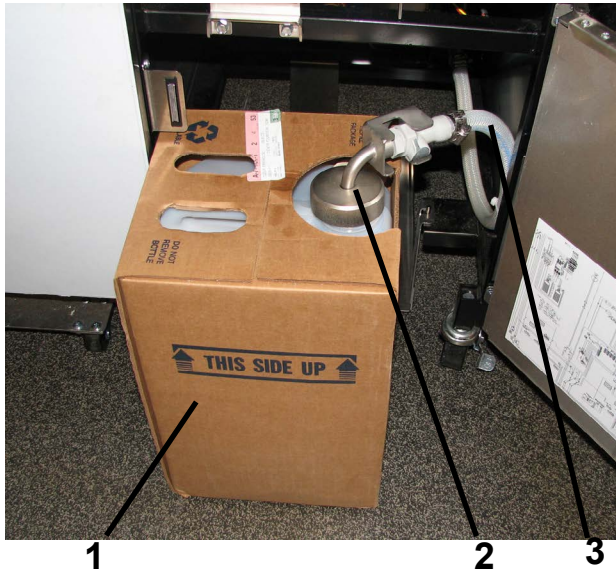

Item No.	Part No.	Description	Quantity
1	03617	ACCESSORY-JUG-AUTO TOP OFF (EMPTY).....	1
2	78992	ASSY-JIB TUBE & QUICK DISC.....	1
2	80490	ASSY-INT'L. JIB TUBE & QUICK DISC .....	1
√	MS01-561	O-RING - JIB TUBE (not shown) .....	1
√ 3	77288	ASSY - HOSE.....	1
4	77630	WELD ASSY - JIB SHELF .....	1

√ recommended parts

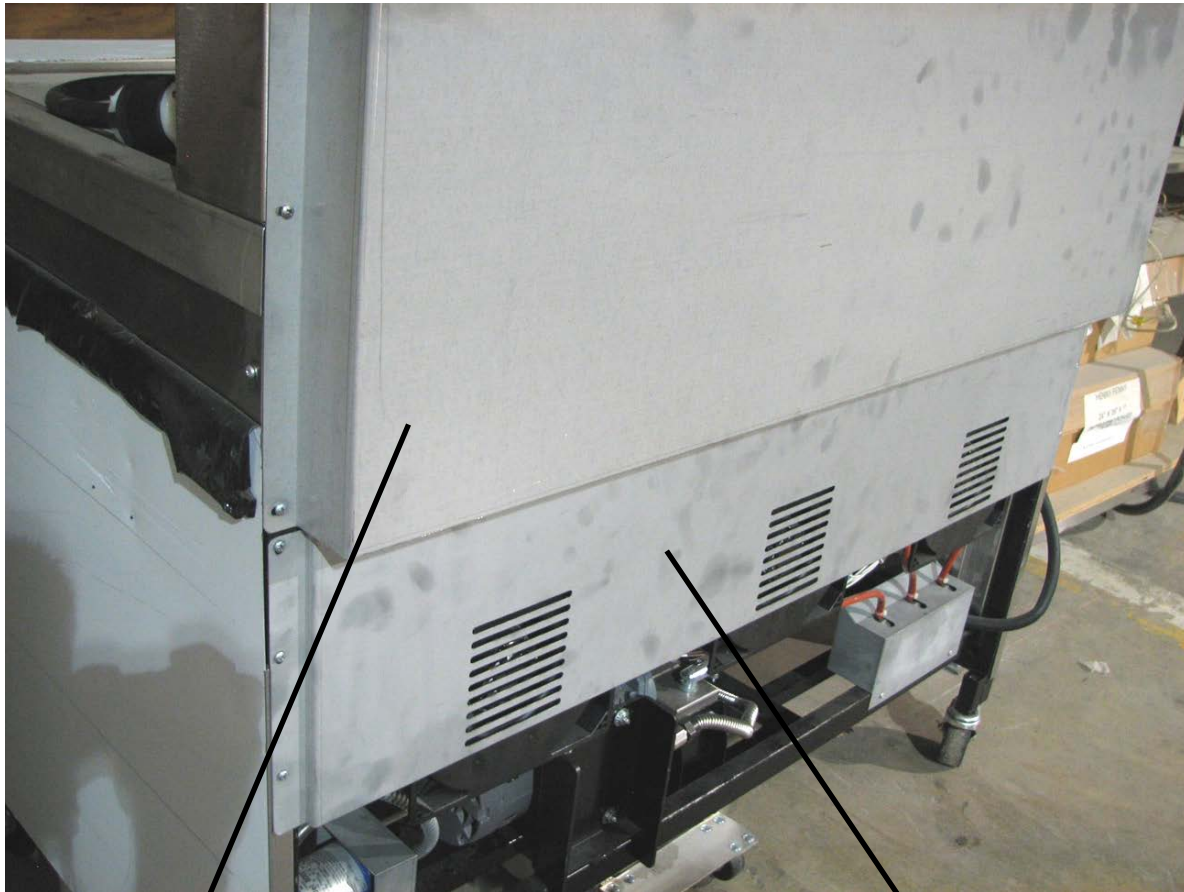

1

2

Item No.	Part No.	Description	Quantity
1	78305	COVER - REAR SHROUD - EEG-142 .....	1
1	77664	COVER - REAR SHROUD - EEG-143 .....	1
1	79565	COVER - REAR SHROUD - EEG-144 .....	1
2	<a href="#">83700</a>	COVER - REAR - LOWER - EEG-142 .....	1
2	<a href="#">84161</a>	COVER - REAR - LOWER - EEG-143 .....	1
2	<a href="#">84162</a>	COVER - REAR - LOWER - EEG-144 .....	1

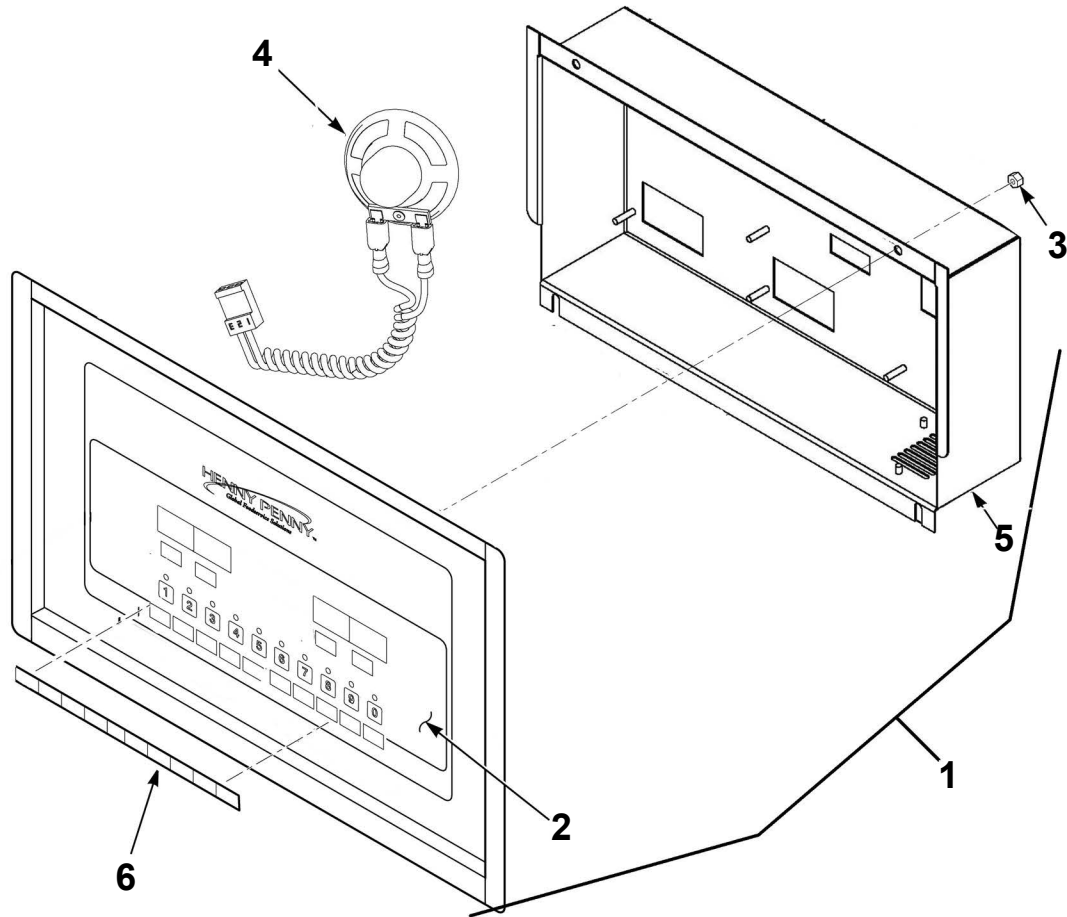

Item No.	Part No.	Description	Quantity
√ 1	81943RB	ASSY - EEE14X CONTROL.....	*
√ 2	81354	DECAL - EVOLUTION ELITE CONTROL.....	1/control
3	NS02-005	NUT - HEX KEPS #6-32 C.....	23/control
√ 4	26974	ASSY - SPEAKER.....	1/control
5	82085	STUD ASSY - CONTROL PANEL COVER.....	1/control
6	81612	MENU CARD - EVOLUTION.....	1/control
6	81613	MENU CARD - BLANK - EVOLUTIO.....	1/control
7	MS01-571	TOOL - TERMINAL EXTRACTOR (not shown).....	1

\*EEG142=2; EEG143=3; EEG144=4

√ recommended parts

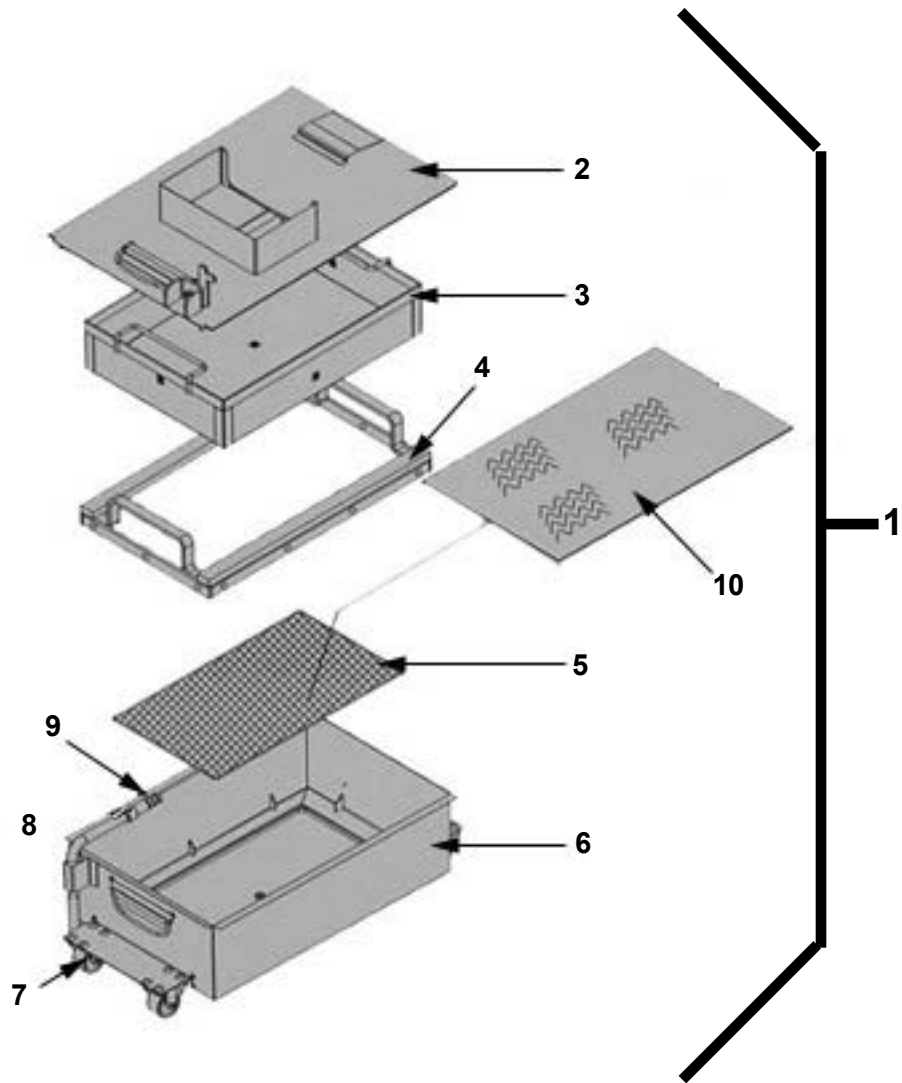

Item No.	Part No.	Description	Quantity
1	78456	ASSY - DRAIN PAN .....	1
2	82674	ASSY-DRAIN PAN COVER.....	1
3	76259	WELD ASSY-CRUMB CATCHER .....	1
4	76179	WELD ASSY-FILTER WEIGHT .....	1
5	76375	FILTER-SECTION .....	1
6	82672	WELD ASSY-DRAIN PAN (Less Cover) .....	1
7	52487	CASTER - DRAIN PAN.....	4
8	74573	ADAPTOR - PUMP TO PICKUP TUBE.....	1
√ 9	74189	O-RING-PICKUP TUBE.....	3
√ 10	*12074	SMART FILTERS (PAD) - 30 COUNT- .....	1
√ 10	*12076	SMART FILTERS (PAPER).....	1
√ 11	12126	BRUSH - BLACK L.....	1
√ 12	12112	BRUSH - STRAIGHT WHITE .....	1
√ 13	12116	BRUSH - FRYER - LONG HANDLE .....	1

\*12074- 11.25"X 19.125"

\*12076- 25.5"X 16.5"

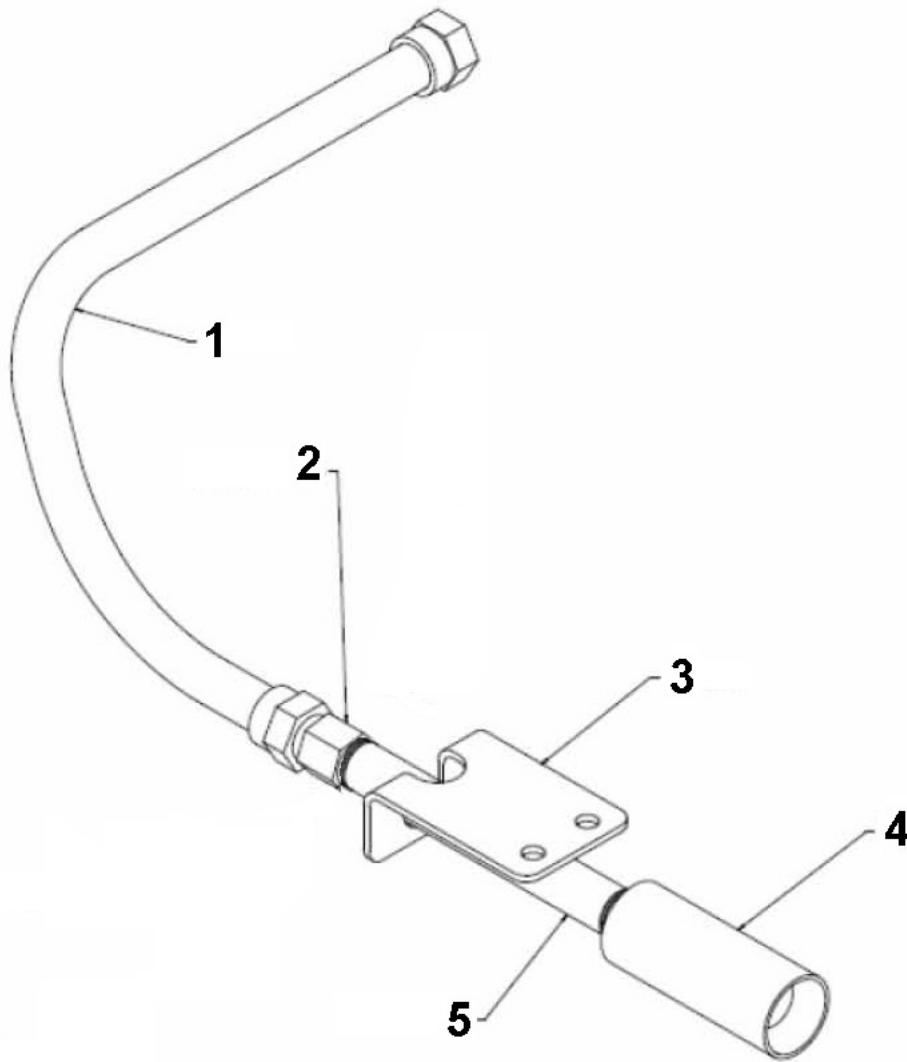

Item No.	Part No.	Description	Quantity
1	77523	TUBE-SUCTION 18 IN L DORMONT.....	1
2	FP01-206	CONNECTOR-3/8 NPT FEM 45 FLARE .....	1
3	77259	BRACKET-PLUG AND PLAY .....	1
4	77248	ADAPTER-TUBE END .....	1
5	FP01-204	NIPPLE-3/8 NPT X 6IN L BLACK.....	1

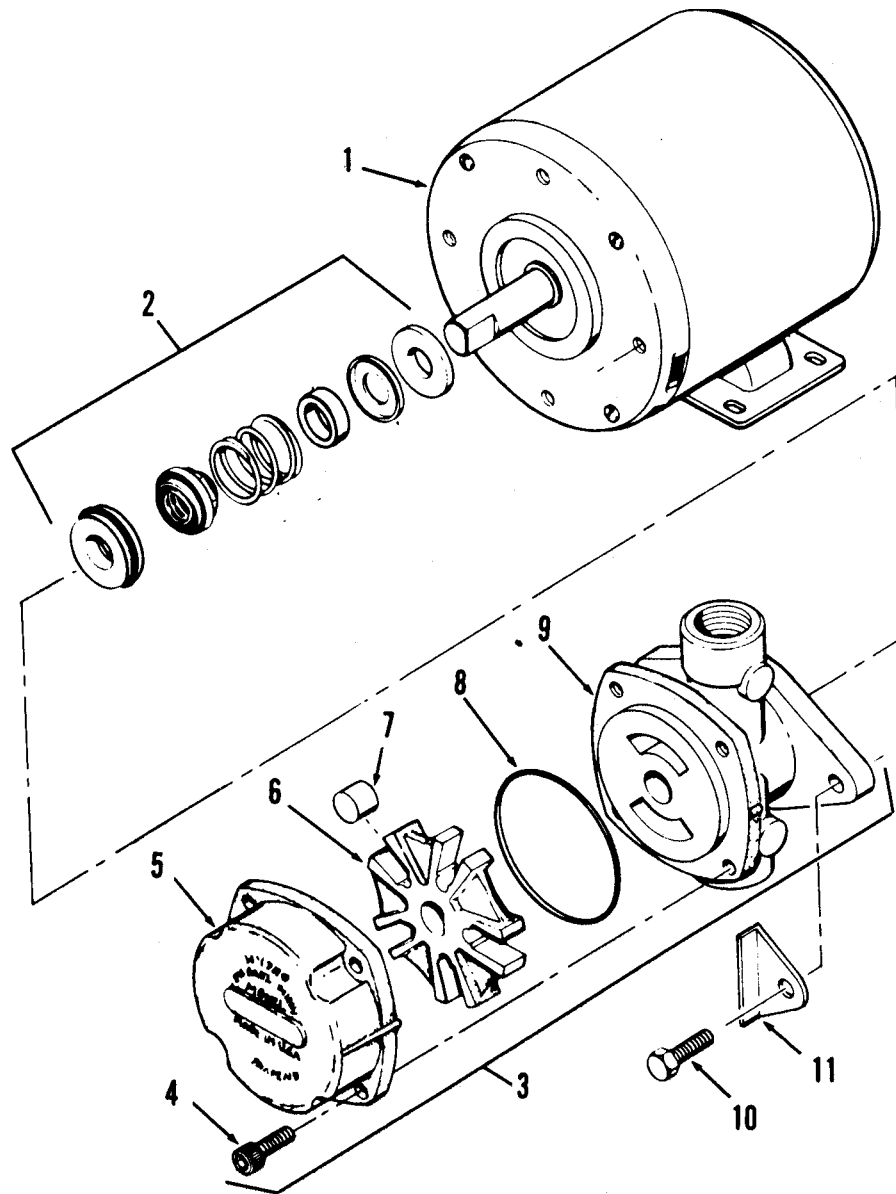

**Filter Motor and Pump**

Item No.	Part No.	Description	Quantity
√ 1	67583	MOTOR, 1/2 HP - 50/60 Hz.....	1
√ 2	17476	SEAL KIT.....	1
3	17437	PUMP ASSEMBLY.....	1
√ 4	SC01-132	SCREW, Pump Cover.....	1
√ 5	17451	COVER, Pump.....	1
√ 6	17447	ROTOR, Pump.....	1
√ 7	17446	ROLLER, Pump.....	5
√ 8	17453	O-RING.....	1
√ 9	17454	BODY, Pump.....	1
√ 10	17456	SHIELD, Pump.....	2
√ 11	SC01-026	SCREW, Pump Shield.....	1

# AUTO-LIFT PARTS

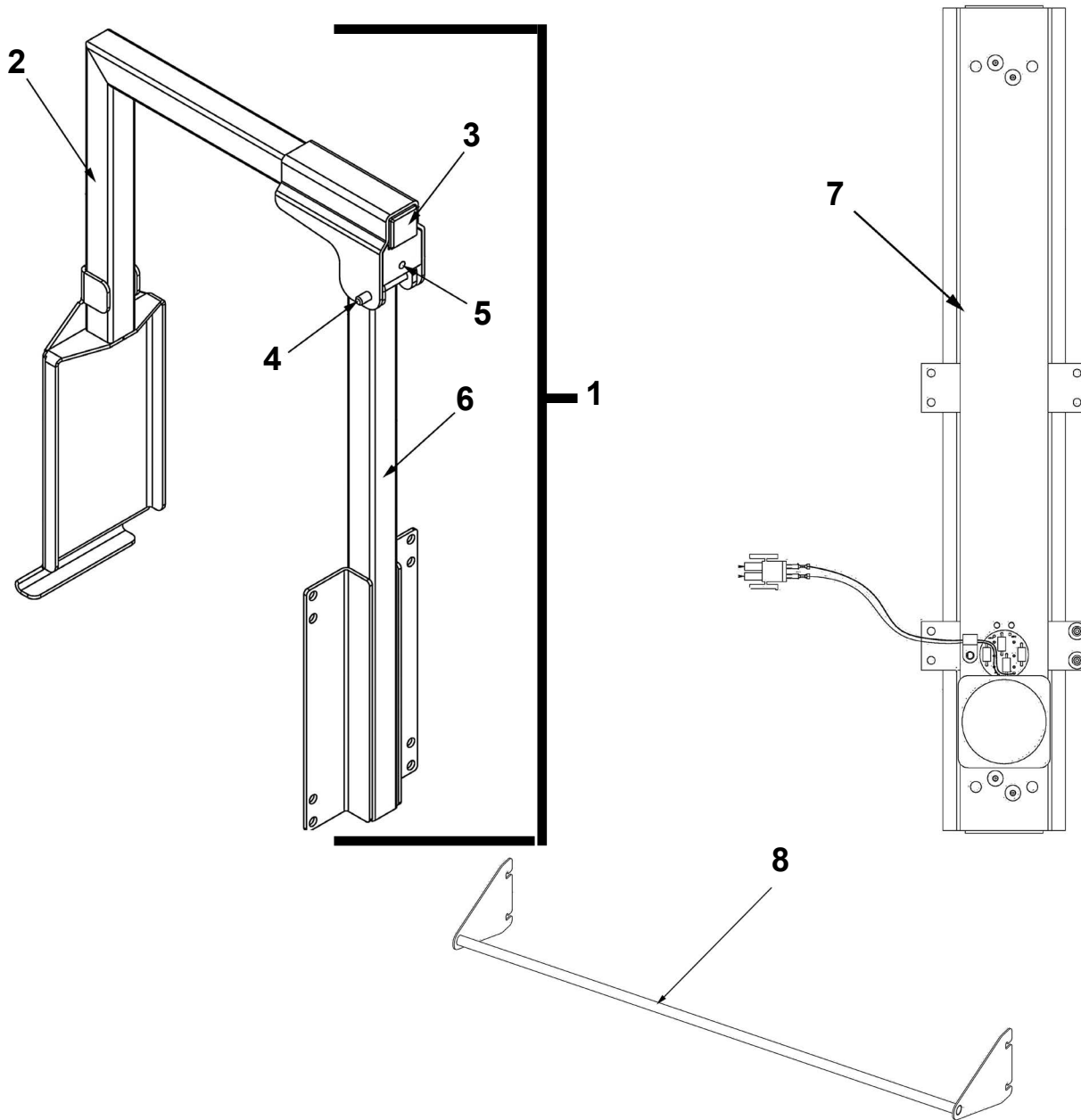

Item No.	Part No.	Description	Quantity/Vat
1	83982	ASSY - BREAKAWAY HINGE.....	2/full; 1/split
2	84279	WELD ASSY - HINGED BASKET HANGER .....	2/full; 1/split
3	15212	PLUG - TUBING SQUARE.....	2/full; 1/split
4	83925	PIN - 1/4 x 2.25 HINGE.....	2/full; 1/split
4*	MS01-578	SHIM .....	6/full; 3/split
5*	SC01-267	SCREW - 1/4-28 x 1 HEX HD SS .....	2/full; 1/split
5*	NS01-018	NUT .....	2/full; 1/split
6	83680	WELD ASSY - BREAKAWAY HINGE .....	2/full; 1/split
B 7	85022	ASSY - EE AUTOLIFT ACTUATOR & CONNECTOR.....	2/full; 1/split
8	84470	WELD ASSY - AUTOLIFT REAR GUARD - 2 WELL .....	1
8	84913	WELD ASSY - AUTOLIFT REAR GUARD - 3 WELL .....	1
8	84918	WELD ASSY - AUTOLIFT REAR GUARD - 4 WELL .....	1
9*	140273	EE-AUTOLIFT ACTUATOR MOTOR .....	A/R
9*	140274	EE-AUTOLIFT ACTUATOR SWITCH.....	A/R

Recommend Parts: A=Truck Stock/B=Dist. Stock / \*not shown