



# Henny Penny High Volume Open Fryer

**Model OFE/OFG-341**  
**Model OFE/OFG-342**  
**Model OEA/OGA-341**  
**Model OEA/OGA-342**

# TECHNICAL MANUAL

## NOTICE

This manual should be retained in a convenient location for future reference.

A wiring diagram for this appliance is located on the inside of the right side panel.

Post in a prominent location, instructions to be followed in event user smells gas. This information shall be obtained by consulting the local gas supplier.

Do not obstruct the flow of combustion and ventilation air. Adequate clearance must be left all around appliance for sufficient air to the combustion chamber.

The Model OFG/OGA-34X open fryer is equipped with a continuous pilot. But the open fryer can not be operated without electric power. The unit will automatically return to normal operation when power is restored.

## CAUTION

*To avoid a fire, keep appliance area free and clear from combustibles.*



**Improper installation, adjustment, alteration, service or maintenance can cause property damage, injury or death. Read the installation, operating and maintenance instructions thoroughly before installing or servicing this equipment.**



**FOR YOUR SAFETY, DO NOT STORE OR USE GASOLINE OR OTHER FLAMMABLE VAPORS AND LIQUIDS IN THE VICINITY OF THIS OR ANY OTHER APPLIANCE.**

**TABLE OF CONTENTS**

<b>Section</b>	<b>Page</b>
Section 1. TROUBLESHOOTING.....	1-1
1-1. Introduction.....	1-1
1-2. Safety.....	1-1
1-3. Troubleshooting.....	1-2
1-4. Error Codes.....	1-4
 Section 2. MAINTENANCE.....	 2-1
2-1. Introduction.....	2-1
2-2. Maintenance Hints.....	2-1
2-3. High Temperature Limit Control (Gas Units).....	2-1
2-4. Complete Control Panel Replacement.....	2-4
2-5. Power Switch.....	2-4
2-6. Temperature Probe Replacement (Gas).....	2-5
2-7. Temperature Probe Replacement (Electric).....	2-6
2-8. Flame Sensor/Pilot/Ignitor Assembly (Gas).....	2-7
2-9. Ignition Module.....	2-9
2-10. Transformer Replacement.....	2-10
2-11. Control & I/O Boards Replacement.....	2-10
2-12. Vacuum Switch Replacement.....	2-11
2-13. Drain Microswitch Replacement.....	2-12
2-14. Filter Switch Replacement.....	2-12
2-15. Gas Control Valve Replacement.....	2-13
2-16. Blower Motor Replacement.....	2-15
2-17. Heating Elements (Electric).....	2-17
2-18. Heating Contactors (Electric).....	2-19
2-19. Speaker Assembly.....	2-22
2-20. High Temperature Limit Control (Electric).....	2-23
2-21. Filter Pump and Motor Removal.....	2-26
2-22. Autolift Transformer Replacement (if applicable).....	2-27
2-23. Autolift PC Board Replacement (if applicable).....	2-28
2-24. Autolift Actuator (Motor) Replacement (if applicable).....	2-28
Wiring Diagrams	
 Section 3. PARTS INFORMATION.....	 3-1
3-1. Introduction.....	3-1
3-2. Genuine Parts.....	3-1
3-3. When Ordering Parts.....	3-1
3-4. Prices.....	3-1
3-5. Delivery.....	3-1
3-6. Warranty.....	3-1
3-7. Recommended Spare Parts for Distributors.....	3-1

## SECTION 1. TROUBLESHOOTING

### 1-1. INTRODUCTION

This section provides troubleshooting information in the form of an easy to read table.

If a problem occurs during the first operation of a new fryer, recheck the Installation Section of the Operator's Manual.

Before troubleshooting, always recheck the Operation Section of the Operator's Manual.

### 1-2. SAFETY

Where information is of particular importance or is safety related, the words DANGER, WARNING, CAUTION, or NOTE are used. Their usage is described on the next page:



SAFETY ALERT SYMBOL is used with DANGER, WARNING or CAUTION which indicates a personal injury type hazard.



NOTICE is used to highlight especially important information.



*CAUTION used without the safety alert symbol indicates a potentially hazardous situation which, if not avoided, may result in property damage.*



*CAUTION used with the safety alert symbol indicates a potentially hazardous situation which, if not avoided, could result in minor or moderate injury.*



**WARNING indicates a potentially hazardous situation which, if not avoided, could result in death or serious injury.**



**DANGER INDICATES AN IMMINENTLY HAZARDOUS SITUATION WHICH, IF NOT AVOIDED, WILL RESULT IN DEATH OR SERIOUS INJURY.**

**1-3. TROUBLESHOOTING**

To isolate a malfunction, proceed as follows:

1. Clearly define the problem or symptom and when it occurs.
2. Locate the problem in the Troubleshooting table.
3. Review all possible causes, then one at a time work through the list of corrections until the problem is solved.



**If maintenance procedures are not followed correctly, injuries and/or property damage could result.**

PROBLEM	CAUSE	CORRECTION
<p>With the switch in the ON position, fryer is completely inoperative</p>	<ul style="list-style-type: none"> <li>• Open circuit</li> </ul>	<ul style="list-style-type: none"> <li>• Check to see if unit is plugged in</li> <li>• Check breaker or fuse at supply box</li> <li>• Check power switch per Power Switch Section; replace if defective</li> <li>• Check voltage at wall receptacle</li> <li>• Check cord and plug</li> </ul>
<p>Shortening will not heat but lights are on</p>	<ul style="list-style-type: none"> <li>• Faulty contactor (elec. model)</li> <li>• Faulty gas control valve (gas model)</li> <li>• Faulty temperature probe</li> <li>• Faulty high limit</li> <li>• Faulty drain switch</li> </ul>	<ul style="list-style-type: none"> <li>• Check contactor per Heating Contactors Section</li> <li>• Check gas control valve per Gas Control Valve Assembly Section</li> <li>• Check temperature probe per Temperature Probe Replacement Section; “E6”</li> <li>• Check high limit per the appropriate High Temperature Limit Control Section; “E10”</li> <li>• Check drain switch per Drain Microswitch Section; “E15”</li> </ul>

**1-3. TROUBLESHOOTING(Continued)**

PROBLEM	CAUSE	CORRECTION
<p>Heating of shortening too slow</p>	<ul style="list-style-type: none"> <li>• Low or improper voltage (elec. unit)</li> <li>• Weak or burnt out elements (elec. unit)</li> <li>• Wire(s) loose</li> <li>• Burnt or charred wire connection</li> <li>• Faulty contactor</li> <li>• Supply line too small - low gas volume (gas unit)</li> <li>• Improper ventilation</li> </ul>	<ul style="list-style-type: none"> <li>• Use a meter and check the receptacle voltage against the data plate</li> <li>• Check heating elements per Heating Elements Section</li> <li>• Tighten</li> <li>• Replace wire and clean connectors</li> <li>• Check contactor per Heating Contactors Section</li> <li>• Increase supply line size; refer to Installation Section of Operator's Manual</li> <li>• Refer to Installation Section of Operator's Manual</li> </ul>
<p>Shortening overheating</p>	<ul style="list-style-type: none"> <li>• Temperature probe needs calibrated</li> <li>• Mercury contactor stuck closed</li> <li>• Bad control board</li> </ul>	<ul style="list-style-type: none"> <li>• Calibrate temperature probe if <math>\pm 10^\circ</math> off; if more than <math>\pm 10^\circ</math> off, replace temperature probe</li> <li>• Check mercury contactor for not opening; replace if necessary (elec. unit)</li> <li>• Replace control board if heat indicator stays on past ready temperature</li> </ul>
<p>Foaming or boiling over of shortening</p>	<ul style="list-style-type: none"> <li>• Water in shortening</li> <li>• Improper or bad shortening</li> <li>• Improper filtering</li> <li>• Improper rinsing after cleaning the fryer</li> </ul>	<ul style="list-style-type: none"> <li>• At end of cook cycle, drain shortening and clean</li> <li>• Use recommended shortening</li> <li>• Refer to the Filtering the Shortening Section in Operator's Manual</li> <li>• Clean and rinse the frypot; then dry thoroughly</li> </ul>

**1-2. TROUBLESHOOTING**  
**(Continued)**

PROBLEM	CAUSE	CORRECTION
Shortening will not drain from frypot	<ul style="list-style-type: none"> <li>• Drain valve clogged with crumbs</li> <li>• Drain valve will not open by turning handle</li> </ul>	<ul style="list-style-type: none"> <li>• Open valve, force cleaning brush through drain</li> <li>• Replace cotter pins in valve coupling</li> </ul>
Filter motor runs but pumps shortening slowly	<ul style="list-style-type: none"> <li>• Pump clogged</li> <li>• Filter line connection loose</li> <li>• Solidified shortening in lines</li> </ul>	<ul style="list-style-type: none"> <li>• Remove pump cover and clean</li> <li>• Tighten all filter line connections</li> <li>• Clear all filter lines of solidified shortening</li> </ul>
Filter switch on, motor does not run	<ul style="list-style-type: none"> <li>• Defective switch</li> <li>• Defective motor</li> <li>• Motor thermal protector tripped</li> </ul>	<ul style="list-style-type: none"> <li>• Check/replace switch per Filter Switch Section</li> <li>• Check/replace motor</li> <li>• Reset thermal switch on filter motor</li> </ul>
Motor hums but will not pump	<ul style="list-style-type: none"> <li>• Clogged lines or pump</li> </ul>	<ul style="list-style-type: none"> <li>• Remove and clean pump and lines</li> <li>• Replace pump seal, rotor and rollers</li> </ul>

**1-4. ERROR CODES**

In the event of a control system failure, the digital display shows An error message. These messages are coded: “E4”, “E5”, “E6”, “E10”, “E15”, “E20”, “E31”, “E41”, “E46”, and “E92”. A Constant tone is heard when an error code is displayed, and to silence this tone, press any button.

<b>DISPLAY</b>	<b>CAUSE</b>	<b>PANEL BOARD CORRECTION</b>
“E4”	Control board overheating	Turn switch to OFF position, then turn switch back to ON; if display shows “E4”, the control board is getting too hot; check the louvers on each side of the unit for obstructions
“E5”	Shortening overheating	Turn switch to OFF position, then turn switch back to ON; if display shows “E5”, the heating circuits and temperature probe should be checked
“E6-A”	Temperature probe open	Turn switch to OFF position, then turn switch back to ON; if display shows “E6” the temperature probe should be checked
“E6-B”	Temperature probe shorted	Turn switch to OFF position, then turn switch back to ON; if display shows “E6” the temperature probe should be checked to replace, per Temperature Probe Replacement Section
“E10”	High limit	Reset the high limit by manually pushing up on the red reset button; if high limit does not reset, high limit must be replaced per High Limit Temperature Control Section
“E15”	Drain switch failure	Close drain, using the drain valve handle; if display still shows “E-15”, check the drain microswitch per Drain Microswitch Section
“E31”	Elements not hinged all the way down	Check to make sure the elements are hinged all way down into the frypot; check for obstructions under elements
“E41”, “E46”	Programming failure	Turn switch to OFF, then back to ON; if display shows any of the error codes, try to reinitialize the control (Special Program Mode Section of Operator’s Manual); if error code persists, replace the control panel per Complete Control Panel Replacement Section

**1-4. ERROR CODES**  
**(Continued)**

<b>DISPLAY</b>	<b>CAUSE</b>	<b>PANEL BOARD CORRECTION</b>
“E-20 A”	Vacuum switch failure (stuck closed)	Press the timer button to try the ignition process again, and if “E-20 A” persists, check the air switch per Vacuum Switch Section
“E-20 B”	Draft fan or vacuum switch failure (stuck open)	Press the timer button to try the ignition process again, and if “E-20 B” persists, check the vacuum switch per Vacuum Switch Section or the blower motor per Blower Motor Assembly Section
“E-20 C”	Ignition modules not responding	Press the timer button to try the ignition process again; if “E-20 C” persists, check the ignition module per Ignitor Module Section, the spark ignitor per Pilot/Ignitor Assembly Section, or the I/O board per Control & I/O Boards Section
“E-20 D”	Pilots not lit or no flame sense	Press the timer button to try the ignition process again; if “E-20 D” persists, check the ignition module per Ignition Module Section, the I/O board per Control & I/O Boards Section, or the flame sensor per Flame Sensor Section
“E-47”	Analog converter chip or 12 volt supply failure	Turn switch to OFF, then back to ON; if “E47” persists, replace the I/O board, or the PC board; if speaker tones are quiet, probably I/O board failure
“E-48”	Input system error	Replace PC board
“E-70”	Faulty power switch or switch wiring; faulty I/O board	Check power switch, along with its wiring; replace I/O board if necessary
“E-92”	24 VAC fuse on I/O open	Check for shorted component in 24 volt circuit; (i.e., high limit, drain switch, vacuum switch)

## SECTION 2. MAINTENANCE

### 2-1. INTRODUCTION

This section provides procedures for the check out and replacement of the various parts used within the fryer. Before replacing any parts refer to the Troubleshooting Section. It will aid you in determining the cause of the malfunction.

### 2-2. MAINTENANCE HINTS

1. You may need to use a multimeter to check the electric components.
2. When the manual refers to the circuit being closed, the multimeter should read zero unless otherwise noted.
3. When the manual refers to the circuit being open, the multimeter will read infinity.

### 2-3. HIGH TEMPERATURE LIMIT CONTROL (Gas Units)

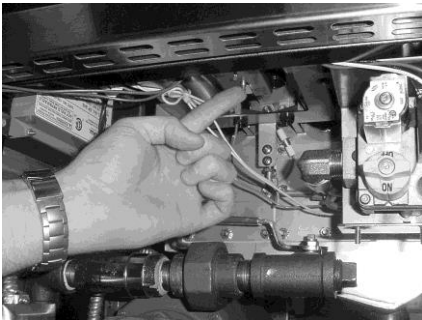

**Figure 2-1**

This high temperature control is a safety, manual reset control, which senses the temperature of the shortening. If the shortening temperature exceeds 425°F (218°C), this switch opens and shuts off heat to the frypot. When the temperature of the shortening drops to a safe operation limit, the control must be manually reset by pressing the red reset button. The red reset button is located under the control panel, in the front of the fryer. (Figure 2-1). This allows heat to be supplied to the frypot.

Before replacing a high temperature limit control, check to see that its circuit is closed.

### NOTICE

The shortening temperature must be below 380°F (193°C) to accurately perform this check.

### Checkout



**Figure 2-2**



**To avoid electrical shock or property damage, move the power switch to OFF and disconnect main circuit breaker, or unplug cord at wall receptacle.**

1. Remove the control panel. Figure 2-2.

**1-3. HIGH TEMPERATURE  
LIMIT CONTROL  
(Gas Units) (Continued)**

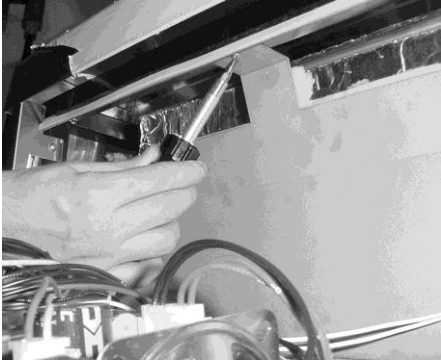

**Figure 2-3**

2. Using a Phillip's head screwdriver, remove the screws securing the inner heat shield and remove from unit. Figure 2-3.

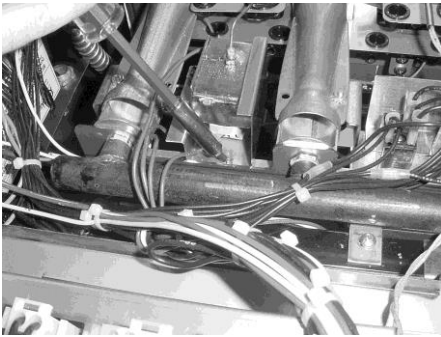

**Figure 2-4**

3. Remove the screw securing the high limit bracket to the frame and remove the high limit and bracket from unit. Figure 2-4.

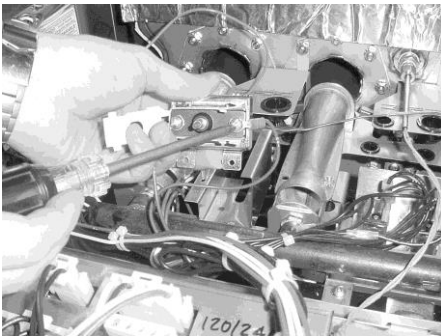
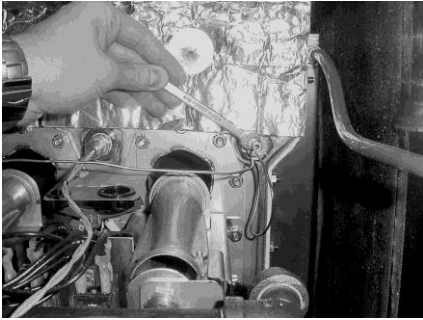

**Figure 2-5**

4. Remove the two screws securing the high limit to the bracket and remove the high limit from bracket.
5. Remove the two electrical wires from the high temperature limit control. Figure 2-5.
6. Manually reset the control, then check for continuity between the two terminals after resetting the control. If the circuit is open, replace the control, then continue with this procedure. (If the circuit is closed, the high limit is not defective. Re-connect the two electrical wires.)

**2-3. HIGH TEMPERATURE  
LIMIT CONTROL  
(Gas Units) (Continued)**

**Replacement**



**Figure 2-6**



**Figure 2-7**

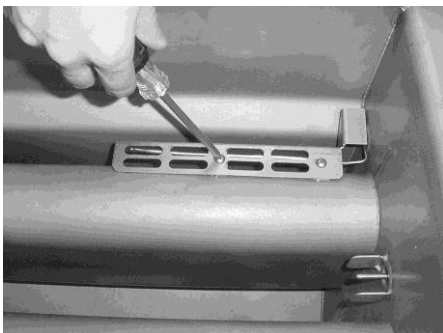

**Figure 2-8**



**To avoid electrical shock or property damage, move the power switch to OFF and disconnect main circuit breaker, or unplug cord at wall receptacle.**

1. If the tube is broken or cracked, the control opens, shutting off electrical power to the heat circuit. The control cannot be reset, and it continuously clicks when pushed.
2. Drain the shortening from the frypot and discard. A substance from the tube could contaminate the shortening.
3. Remove the control panel.
4. Using a 5/16” wrench, loosen small inside screw nut on capillary tube. Figure 2-6.
5. Using a 11/16” crows-foot, remove the larger nut securing the capillary tube to the pot. Figure 2-7.
6. Remove the two screws securing the high limit guard and remove guard. Figure 2-8
7. Straighten the capillary tube inside the frypot, and pull the capillary tube through the frypot, from behind the control panel. Remove the defective high limit from the control panel area.
8. Replace new high limit in reverse order.



**To avoid electrical shock or other injury, run the capillary line under and away from all electrical power wires and terminals. The tube must never be in such a position where it could accidentally touch the electrical power terminals.**

**2-4. COMPLETE CONTROL PANEL REPLACEMENT**

Should the control board become inoperative, follow these instructions for replacing the board.



**Figure 2-9**

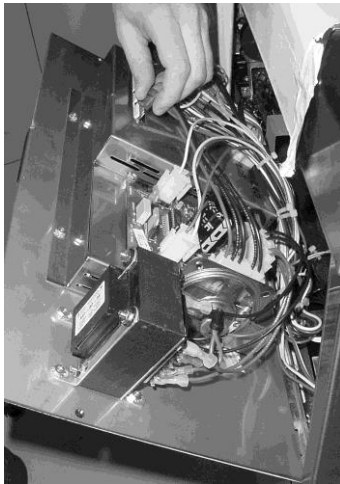

**Figure 2-10**

1. Remove electrical power supplied to the unit.



**To avoid electrical shock or property damage, move the power switch to OFF and disconnect main circuit breaker, or unplug cord at wall receptacle.**

2. Remove the two screws securing the control panel and lift out. Figure 2-9.
3. Unplug the wire connectors going to the control panel. Figure 2-10.
4. Remove transformer(s) from control panel. They must be installed on the replacement panels.
5. Install new control panel in reverse order.



*When plugging connectors onto new control panel, be sure the connectors are inserted onto all of the pins, and that the connectors are not forced onto the pins backwards. If not connected properly, damage to the board could result.*

**2-5. POWER SWITCH**

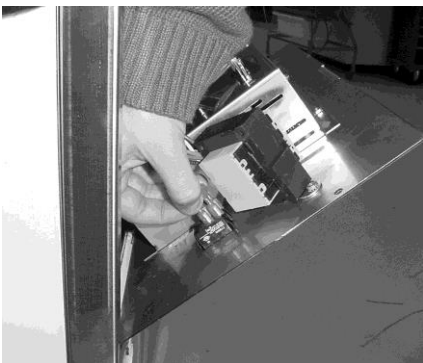

**Figure 2-11**

1. Remove electrical power supplied to fryer.



**To avoid electrical shock or property damage, move the power switch to OFF and disconnect main circuit breaker, or unplug cord at wall receptacle.**

2. Remove control panel.
3. Label and remove wires from the switch. With test instrument check across the terminals of the switch with switch in the on position, and the circuit should be closed. In the off position, the circuit should be open. If the switch checks defective, replace by continuing with this procedure. Figure 2-11.

**2-5. POWER SWITCH (Continued)**



**Figure 2-12**

4. With control panel removed, and the wires off the switch, push in on tabs on the switch to remove from panel. Figure 2-12.
5. Replace with new switch, and reconnect wires to switch.
6. Replace the control panel.

**2-6. TEMPERATURE PROBE REPLACEMENT (Gas)**

The temperature probe relays the actual shortening temperature to the control board. If it becomes disabled, “E06” shows in the display. Also, if the shortening temperature is out of calibration more than 10°F or C°, the probe should be replaced. An Ohm check can be performed also. See chart below.

Temp. F	Temp. C	Resistance Ohms	Temp. F	Temp. C	Resistance Ohms
50	10.00	1039.02	250	121.11	1464.79
60	15.56	1060.65	260	126.67	1485.71
70	21.11	1082.24	270	132.22	1506.58
80	26.67	1103.80	280	137.78	1527.43
90	32.22	1125.32	290	143.33	1548.23
100	37.78	1146.81	300	148.89	1569.00
110	43.33	1168.26	310	154.44	1589.73
120	48.89	1189.67	320	160.00	1610.43
130	54.44	1211.05	325	162.78	1620.77
140	60.00	1232.39	330	165.56	1631.09
150	65.56	1253.70	340	171.11	1651.72
160	71.11	1274.97	350	176.67	1672.31
170	76.67	1296.20	360	182.22	1692.86
180	82.22	1317.40	365	185.00	1703.13
185	85.00	1327.99	370	187.78	1713.38
190	87.78	1338.57	380	193.33	1733.87
200	93.33	1359.69	390	198.89	1754.31
210	98.89	1380.79	400	204.44	1774.72
212	100.00	1385.00	410	210.00	1795.10
220	104.44	1401.84	420	215.56	1815.44
230	110.00	1422.86	430	221.11	1835.74
240	115.56	1443.85	440	226.67	1856.01

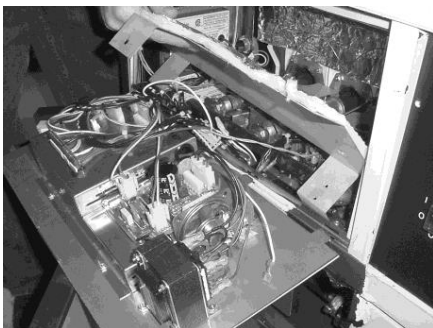

**Figure 2-13**

1. Remove electrical power supplied to the fryer.



**To avoid electrical shock or property damage, move the power switch to OFF and disconnect main circuit breaker, or unplug cord at wall receptacle.**



**Figure 2-14**

2. Drain the shortening from the frypot.
3. Remove the control panel and heat shield from control area. Figure 2-13.
4. Using a ½ inch wrench, remove the nut on the compression fitting. Figure 2-14.

**2-6. TEMPERATURE PROBE REPLACEMENT (GAS)**  
**(Continued)**

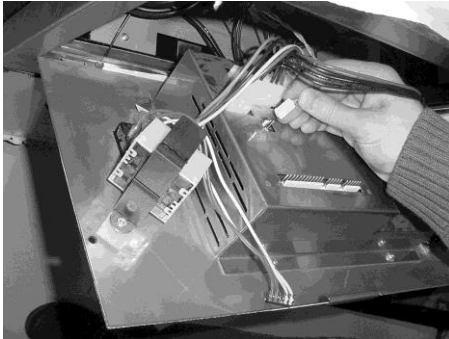

Figure 2-15

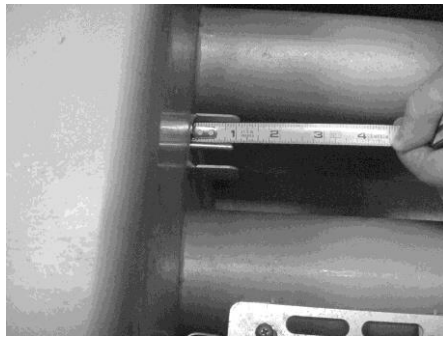

Figure 2-16

**2-7. TEMPERATURE PROBE REPLACEMENT (Gas)**  
**REPLACEMENT (ELECTRIC)**



Figure 2-17

5. Remove the probe from the frypot, and disconnect wire connector from the control panel. Figure 2-15.
6. Place the nut and new ferrule on the new probe and insert the probe into the compression fitting until it extends one (1) inch (2.54cm) into the frypot. Figure 2-16.
7. Tighten hand tight and then a half turn with wrench.



*Excess force will damage probe.*

8. Connect new probe to PC board and replace control panel.
9. Replace shortening, and turn power on to check out fryer.

The temperature probe relays the actual shortening temperature to the control board. If it becomes disabled, “E06” shows in the display. Also, if the shortening temperature is out of calibration more than 10°F or C°, the probe should be replaced. An Ohm check can also be performed. See chart on page 2-5.

1. Remove electrical power supplied to the fryer.



**To avoid electrical shock or property damage, move the power switch to OFF and disconnect main circuit breaker, or unplug cord at wall receptacle.**

2. Drain the shortening from the frypot.
3. Remove screws securing rear cover of fryer, and remove rear cover. Figure 2-17.

**2-7. TEMPERATURE PROBE REPLACEMENT (ELECTRIC) (Continued)**



**Figure 2-18**

4. Using a ½ inch wrench, remove the nut on the compression fitting. Figure 2-18.
5. Remove the probe from the frypot, and disconnect probe.
6. Place the nut and new ferrule on the new probe and insert the probe into the compression fitting until it extends one (1) inch (2.54cm) into the frypot.
7. Reconnect new probe onto wires, replace rear cover, and fryer is now ready for use.

**2-8. FLAME SENSOR/ PILOT / IGNITOR ASSEMBLY (GAS)**

The Henny Penny open fryer (gas) has electronic spark ignition that lights a standing pilot. The gap between the spark electrode and the pilot hood should be 1/8 of an inch (3.18 mm). The flame sensor recognizes the pilot flame and allows gas to continue to the pilot. The flame sensor must send a minimum of two (2) micro amps to the ignition module. The pilot flame should be split in two by the flame sensor, causing the flame sensor to be bright red in color.

1. Remove electrical power supplied to the unit.



**To avoid electrical shock or property damage, move the power switch to OFF and disconnect main circuit breaker, or unplug cord at wall receptacle.**



**TO AVOID PERSONAL INJURY OR PROPERTY DAMAGE, BEFORE STARTING THIS PROCEDURE, MOVE THE MAIN POWER SWITCH TO THE OFF POSITION. DISCONNECT THE MAIN CIRCUIT BREAKERS AT THE CIRCUIT BREAKER BOX OR UNPLUG SERVICE CORD FROM WALL RECEPTACLE. TURN OFF THE MAIN GAS SUPPLY TO THE FRYER AND DISCONNECT AND CAP THE MAIN SUPPLY LINE TO FRYER, OR POSSIBLE EXPLOSION COULD RESULT.**

**2-8. FLAME SENSOR/  
PILOT / IGNITOR  
ASSEMBLY (Gas)**  
**(Continued)**

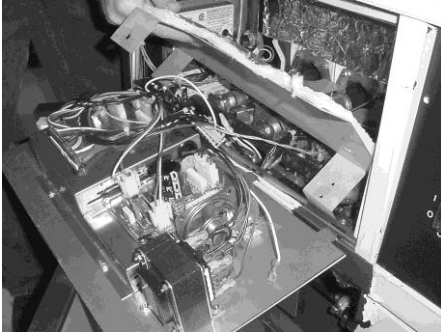

**Figure 2-19**

2. Remove the control panel and heat shield from control area. Figure 2-19.

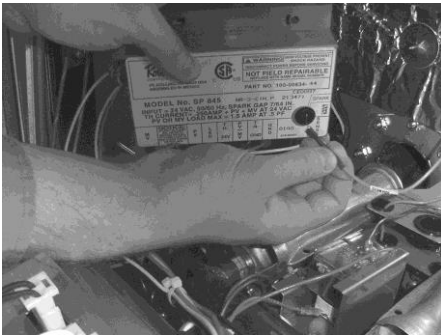

**Figure 2-20**

3. Disconnect the flame sense wire from ignition module. Figure 2-20.

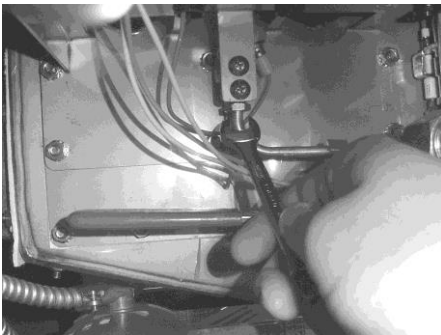

**Figure 2-21**

4. Using a 7/16" wrench, loosen the nut on the pilot tube and pull tube from assembly. Figure 2-21.

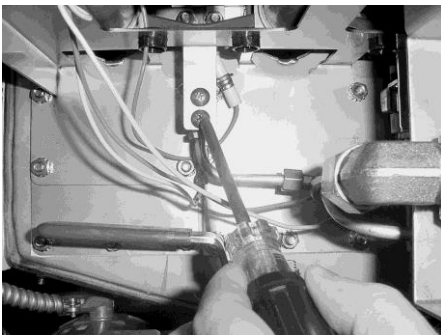

**Figure 2-22**

5. Remove the two screws securing the assembly and pull assembly from unit. Figure 2-22.
6. Now the flame sensor or or pilot assembly can be removed from bracket.

## **2-9. IGNITION MODULE**

During normal operation, the ignition modules send 24 volts to the ignitors and gas valve. If a module does not sense a pilot flame, the module starts the ignition process again. But, if a pilot light goes out for longer than 10 seconds, or it goes out 3 times within 10 seconds, the module keeps the 24 volts from reaching the gas valve. The burners shut down.

1. Remove electrical power supplied to the unit.



**To avoid electrical shock or property damage, move the power switch to OFF and disconnect main circuit breaker, or unplug cord at wall receptacle.**

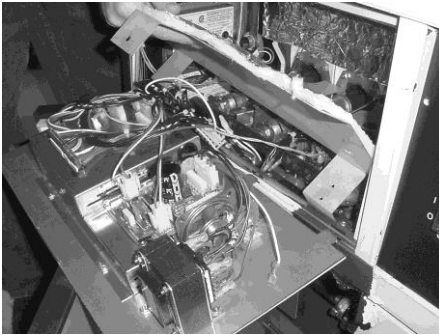

**Figure 2-23**

2. Remove the control panel and heat shield from control area. Figure 2-23.



**Figure 2-24**

3. Using a 3/8 inch socket, remove the two nuts securing the module. Figure 2-24.

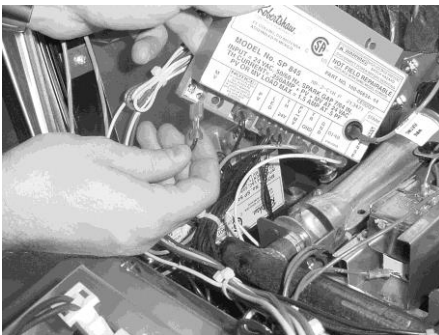
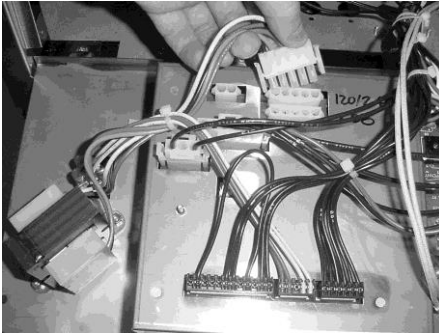

**Figure 2-25**

4. Label and remove the wires at module. Figure 2-25.
5. Install new module in reverse order.

**2-10. TRANSFORMER REPLACEMENT**

The transformer reduces voltage down (to 24V) to accommodate those components with low voltage.



**Figure 2-26**

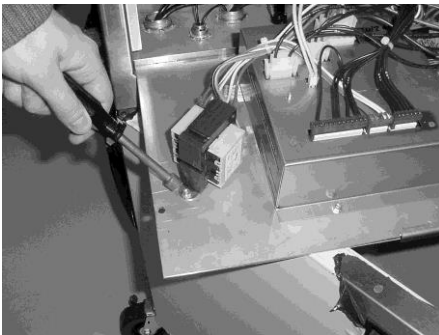

**Figure 2-27**

**2-11. CONTROL & I/O BOARDS REPLACEMENT**

I/O Power Supply      Control

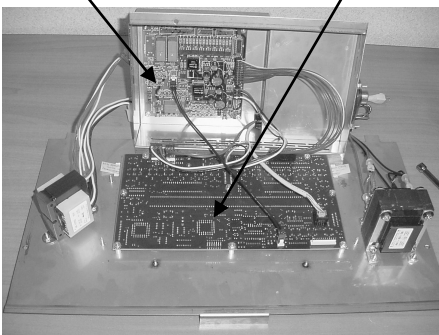

**Figure 2-28**

1. Remove electrical power supplied to the unit.



**To avoid electrical shock or property damage, move the power switch to OFF and disconnect main circuit breaker, or unplug cord at wall receptacle.**

2. Remove the control panel
3. Remove the two wire connectors to disconnect transformer From panel. Figure 2-26.
4. Using a 3/8” nut-driver, remove the two nuts securing the transformer to the panel and remove transformer. Figure 2-27.
5. Install the new transformer in reverse order.

1. Remove electrical power supplied to the unit.



**To avoid electrical shock or property damage, move the power switch to OFF and disconnect main circuit breaker, or unplug cord at wall receptacle.**

2. Remove the control.
3. Using a 5/16” nut-driver or wrench, remove the 4 nuts securing the PC shield and remove shield. Figure 2-28.
4. Disconnect the wire assemblies from the appropriate board.
5. Using a 5/16” nut-driver or wrench, remove the 4 nuts securing the appropriate board to the shroud.
6. Install the new board in reverse order.

## **2-12. VACUUM SWITCH REPLACEMENT**

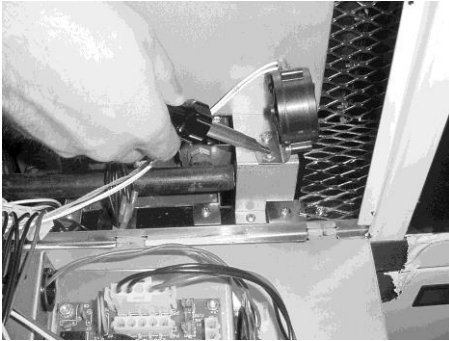

**Figure 2-29**

This switch senses the airflow from the induction blower. If the airflow is reduced below a set amount, the switch opens and the I/O board cuts power to the gas control valve, which shuts the pilot flame off.

1. Remove electrical power supplied to the unit.



**To avoid electrical shock or property damage, move the power switch to OFF and disconnect main circuit breaker, or unplug cord at wall receptacle.**

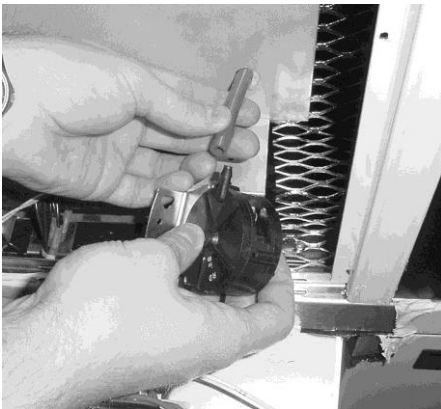

**Figure 2-30**

2. Remove the control panel.
3. Remove the 2 screws securing the switch to the heat shield. Figure 2-29.

4. Remove the air hose from the air switch. Figure 2-30.

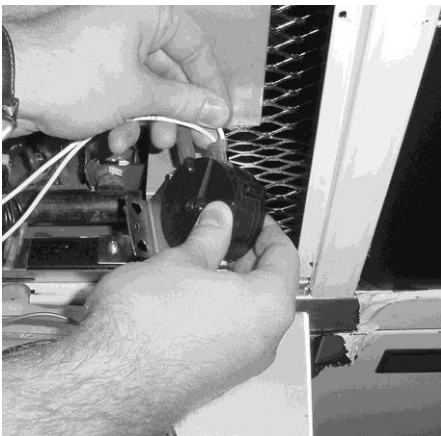

**Figure 2-31**

5. Label and remove wires from air switch. Figure 2-31.

6. Install new vacuum switch in reverse order.

**CAUTION**

*To avoid property damage, do not tamper with, or disassemble this component. It is set and sealed from the factory and is not to be adjusted.*

**2-13. DRAIN MICROSWITCH REPLACEMENT**

Upon turning the drain handle, the drain microswitch should “open”, cutting off the pilot flame. This will prevent the fryer from heating while shortening is being drained from the frypot.

1. Remove electrical power supplied to the unit.



**To avoid electrical shock or property damage, move the power switch to OFF and disconnect main circuit breaker, or unplug cord at wall receptacle.**

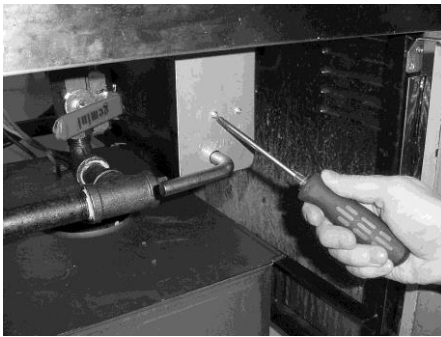

**Figure 2-32**

2. The following check should be made to determine if the drain microswitch is defective.
  - a. Remove the two screws and nuts securing the microswitch to the drain rod valve bracket, and remove microswitch. Figure 2-32.
  - b. Remove wires from the switch. Figure 2-33.
  - c. Check for continuity across the two outside terminals of the drain switch. If the circuit is open, the drain switch is defective. The circuit opens by pressing on the actuator of the microswitch.



**Figure 2-33**

3. If defective, replace switch in reverse order.

**2-14. FILTER SWITCH REPLACEMENT**

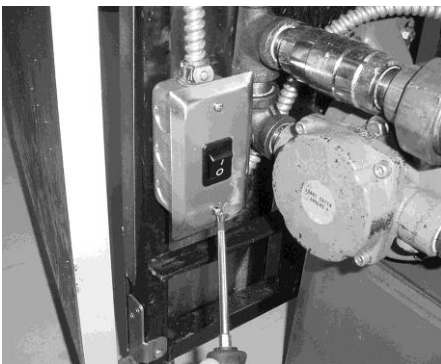

**Figure 2-34**

1. Remove electrical power supplied to the unit.



**To avoid electrical shock or property damage, move the power switch to OFF and disconnect main circuit breaker, or unplug cord at wall receptacle.**

2. Open the door (left door on 2 well units), and remove the 2 screws securing the switch box cover. Figure 2-34.

**2-14. FILTER SWITCH  
REPLACEMENT**  
(Continued)



Figure 2-35



Figure 2-36

3. Label and remove the wires from the switch. With test instrument check across the terminals of the switch. With the switch in the on position, the circuit should be closed. With the switch in the off position, the circuit should be open. If the switch is defective, replace by continuing with this procedure. Figure 2-35.

4. With wires removed from the switch, push in on tabs on the switch and remove switch from front of switch box cover. Figure 2-36.

5. Push new switch into panel and reconnect wires.

**2-15. GAS CONTROL VALVE  
REPLACEMENT**

The gas valve assembly controls the flow of gas to the pilot and the main burner. The valve has two 24-volt coils, which are regulated by the P and M terminals on the valve. The C terminal is the common terminal. For gas flow to the pilot, 24 VAC must be present between the P and C terminals. For gas flow to the main burner, 24 VAC must be present between the M and C terminals.



**TO AVOID PERSONAL INJURY OR PROPERTY DAMAGE, BEFORE STARTING THIS PROCEDURE, MOVE THE MAIN POWER SWITCH TO THE OFF POSITION. DISCONNECT THE MAIN CIRCUIT BREAKERS AT THE CIRCUIT BREAKER BOX OR UNPLUG SERVICE CORD FROM WALL RECEPTACLE. TURN OFF THE MAIN GAS SUPPLY TO THE FRYER AND DISCONNECT AND CAP THE MAIN SUPPLY LINE TO FRYER, OR POSSIBLE EXPLOSION COULD RESULT.**

**2-15. GAS CONTROL VALVE  
REPLACEMENT  
(Continued)**

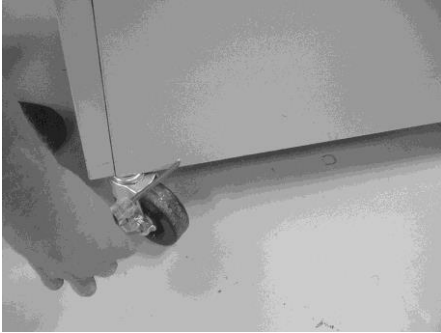

**Figure 2-37**

1. Remove right side panel. Figure 2-37.

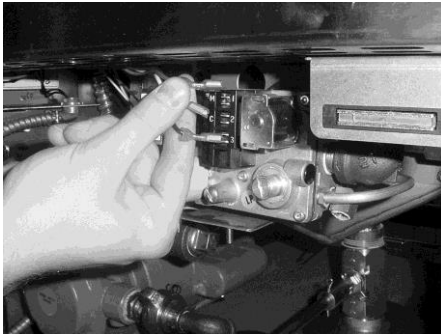

**Figure 2-38**

2. Label and remove wires from gas valve. Figure 2-38

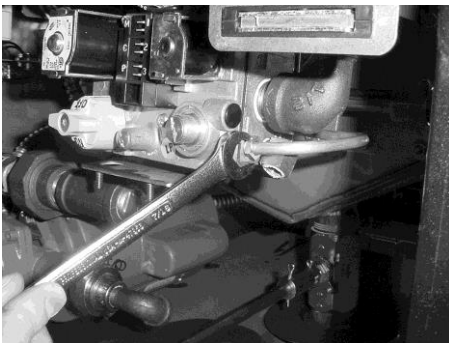

**Figure 2-39**

3. Using a 7/16 wrench, remove the pilot line from the gas valve. Figure 2-39.



**Figure 2-40**

4. Using a 1-inch wrench, loosen the nut securing the main gas inlet line to the gas valve. Figure 2-40.

**2-15. GAS CONTROL VALVE  
REPLACEMENT  
(Continued)**

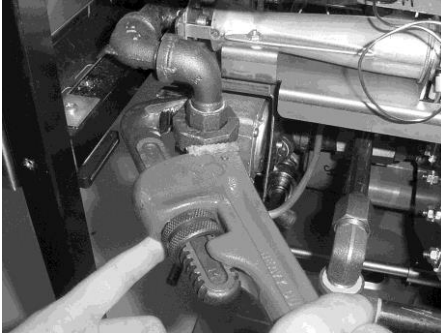

**Figure 2-41**

5. Using a pipe wrench, loosen the outlet fitting to the burner.  
Figure 2-41.

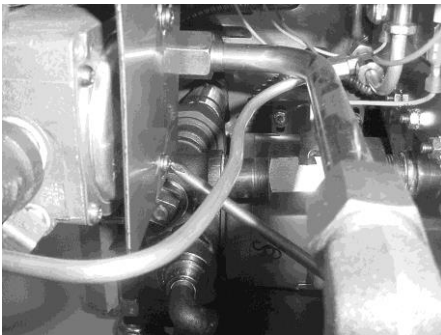

**Figure 2-42**

6. Using a Phillips screwdriver, remove the 2 screws securing the gas valve to the bracket and remove gas valve from unit.  
Figure 2-42.

7. Remove the fittings from the gas valve and install in new gas valve.

8. Install the new gas valve in reverse order.

**2-16. BLOWER MOTOR  
REPLACEMENT**

The blower motor assembly induces the draft for the burners. If the blower motor fails, the air switch will fail to close, causing an “E-20B” error code in the display.

1. Remove electrical power supplied to the unit.



**To avoid electrical shock or property damage, move the power switch to OFF and disconnect main circuit breaker, or unplug cord at wall receptacle.**



**Figure 2-43**

2. Remove screws securing the rear cover to the unit.  
Figure 2-43.

**2-16. BLOWER MOTOR  
REPLACEMENT  
(Continued)**



**Figure 2-44**

3. Remove the wire cover from the blower motor housing. Figure 2-44.

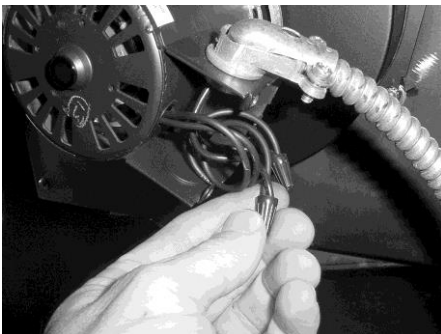

**Figure 2-45**

4. Remove wire nuts connecting blower motor wires to wires in conduit. Figure 2-45.

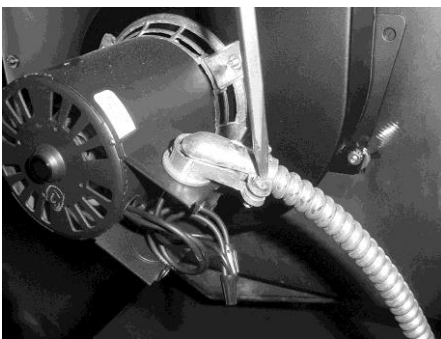

**Figure 2-46**

5. Loosen conduit from blower motor. Figure 2-46.



**Figure 2-47**

7. Remove screws connecting flue to blower. Figure 2-47.

**2-16. BLOWER MOTOR  
REPLACEMENT  
(Continued)**

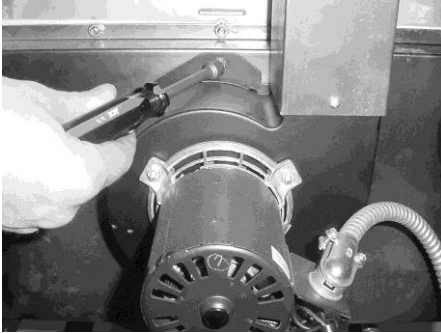

**Figure 2-48**

8. Using 3/8 inch nut driver, remove nuts securing blower to the unit. Figure 2-48. Pull blower from unit.

9. Install new blower in reverse order.

**2-17. HEATING ELEMENTS  
(ELECTRIC)**

**NOTICE**

Heating elements are available for 208 and 230 voltage. Check data plate to determine correct voltage.

**Checkout**

If the shortening temperature recovery is very slow or at a slower rate than required, this may indicate defective heating element(s). An ohmmeter quickly indicates if the elements are shorted or open.



**Figure 2-49**

1. Remove electrical power supplied to the frypot to be checked



**To avoid electrical shock or property damage, move the power switch to OFF and disconnect main circuit breaker, or unplug cord at wall receptacle, to the frypot to be worked on. Be aware the other control on 2-frypot units will have power.**

2. Remove rear cover. Figure 2-49.

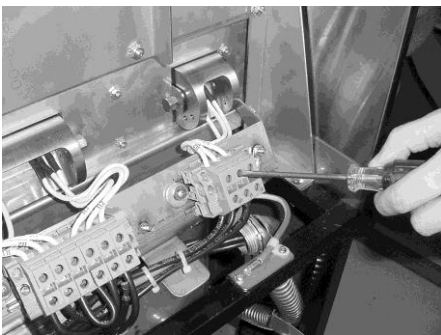

**Figure 2-50**

3. Using a flat-head screwdriver, remove the appropriate wires from the terminal blocks. Figure 2-50.

**2-17. HEATING ELEMENTS**  
**(ELECTRIC)**  
**(Continued)**

4. Perform an ohm check on one element at a time, with wires disconnected. The 2 elements actually have 3 small heating elements inside the outer plate. It's important to check between the correct wires to obtain an accurate ohm reading. The wires are labeled for your convenience. If the resistance is not within tolerance, replace the element.

Wire Nos.	Voltage	Wattage	Ohms (cold)
1L1 to 1L1	208	11000	11.7
1L2 to 1L2	208	11000	11.7
1L3 to 1L3	208	11000	11.7
1L1 to 1L1	240	11000	15.7
1L2 to 1L2	240	11000	15.7
1L3 to 1L3	240	11000	15.7

**Replacement**



**Figure 2-51**

1. Drain the shortening from the frypot
2. Remove the high limit bulb holder from the heating element inside the frypot. See High Limit Temperature Control-Electric Section.
3. Using a Phillip's-head screwdriver, remove the screws securing the element to the element hinges. Figure 2-51.
4. Pull element from fryer and replace with new element, following steps in reverse order.
5. Connect the power cord to the wall receptacle or close wall circuit breaker.

**CAUTION**

*Heating elements should never be energized without shortening in the frypot, or damage to the elements could result.*

6. Replace the shortening in the frypot, and unit is ready for operation.

**2-18. HEATING CONTACTORS (ELECTRIC)**

Each well of an electric fryer requires two switching contactors. The first in line is the primary contactor and the second in line is the heat contactor. When open, the primary contactor does not allow power to flow to the heat contactor. When closed, the primary supplies voltage to the heat contactor. When the heat contactor is open, no voltage is supplied to the heating elements. When the heat contactor closes, voltage is supplied to the heating elements.

**Checkout (Power Removed)** 1. Remove electrical power supplied to frypot to be worked on.



**To avoid electrical shock or property damage, move the power switch to OFF and disconnect main circuit breaker, or unplug cord at wall receptacle, to the frypot to be worked on. Be aware the other control on 2-frypot units will have power.**

**Heat Contactor (Mercury)**

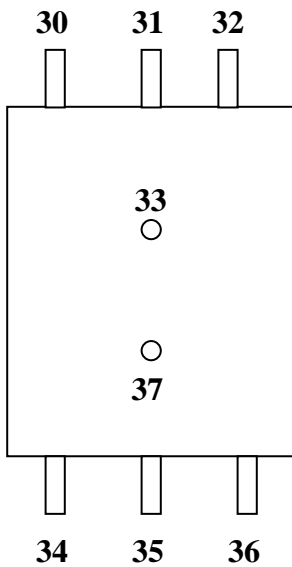

**Figure 2-52**

2. Remove the control panel.
3. Perform a check on the contactor as follows:

Test Points

Results

From 23 to 29	open circuit
From 24 to 28	open circuit
From 25 to 27	open circuit
From 30 to 34	open circuit
From 31 to 35	open circuit
From 32 to 36	open circuit
From 33 to 37	ohm reading 1700
From 22 to 26	ohm reading 415

**Primary Contactor**

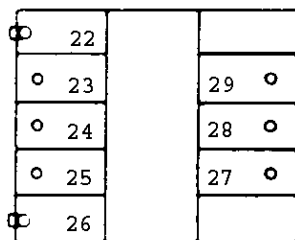

**Figure 2-53**



Wires should be removed and labeled to obtain an accurate check of contactors.

**2-18. HEATING CONTACTORS (ELECTRIC) (Continued)**



To avoid electrical shock, make connections before applying power, take reading, and remove power before removing meter leads. The following checks are performed with the wall circuit breaker closed and the main power switch in the ON position.

1. Re-apply power to unit and turn power switch to ON.
2. Using illustrations from previous page, check voltage as follows:

<u>Test Points</u>	<u>Results</u>
<u>Heat Contactor</u>	
From terminal 34 to 35	The voltage should read the same at each terminal
From terminal 35 to 36	
From terminal 34 to 36	

<u>Test Points</u>	<u>Results</u>
<u>Primary Contactor</u>	
From terminal 27 to 28	It should correspond to the voltage stated on the data plate.
From terminal 28 to 29	
From terminal 27 to 29	

**Replacement (Heat Contactor)**

If neither contactor is defective it must be replaced as follows:



To avoid electrical shock or property damage, move the power switch to OFF and disconnect main circuit breaker, or unplug cord at wall receptacle, to the frypot to be worked on. Be aware the other control on 2-frypot units will have power.

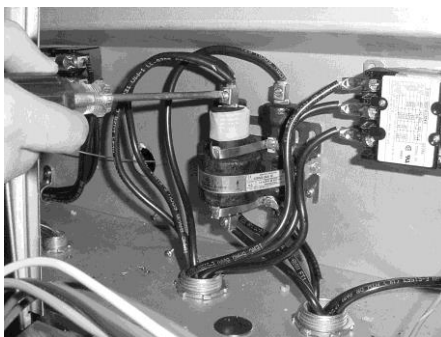

**Figure 2-54**

1. Remove only the wires directly connected to the contactor being replaced. Label the wires for replacement. Figure 2-54.

**2-18. HEATING**  
**CONTACTORS**  
**(ELECTRIC)**  
**Continued)**

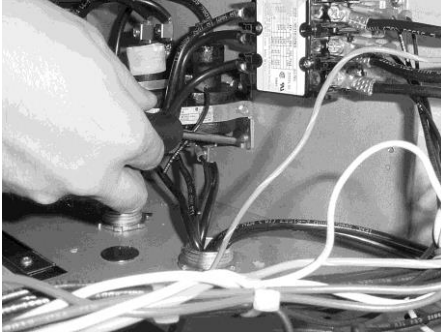

**Figure 2-55**

2. Remove the screws securing the contactor to the shroud, and remove contactor. Figure 2-55.
3. Install new contactor, and see steps 4 and 5.

**Replacement**  
**(Primary Contactor)**

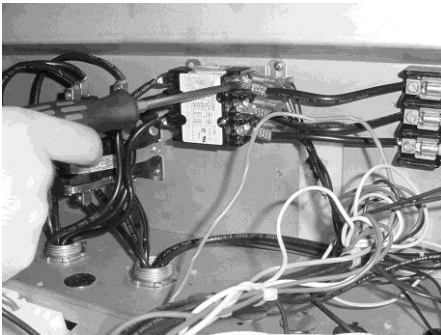

**Figure 2-56**

1. Remove only the wires directly connected to the contactor being replaced. Label the wires for replacement. Figure 2-56.
2. Remove screws securing contactor to unit and remove contactor. Figure 2-57.

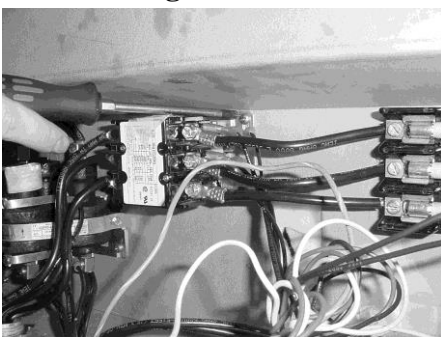
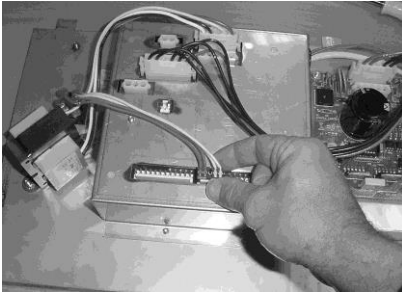

**Figure 2-57**

3. Install new contactor.
4. Reinstall the control panel.
5. Reconnect power to the fryer and test for proper operation.

## **2-19. SPEAKER ASSEMBLY**

The speaker assembly emits audible signals to let the operator know when cooking and hold times are finished.



**Figure 2-58**

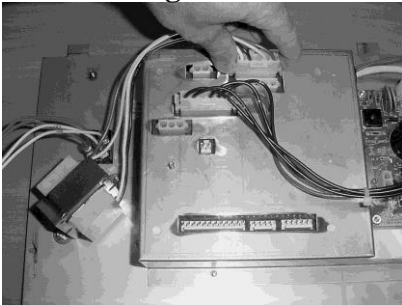

**Figure 2-59**

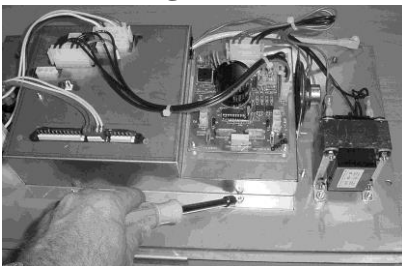

**Figure 2-60**

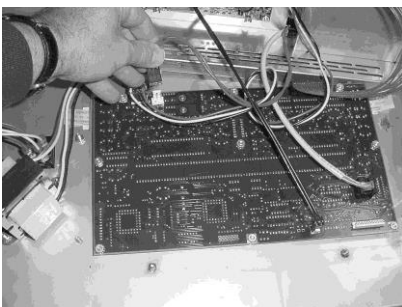

**Figure 2-61**



**Figure 2-62**

1. Remove electrical power supplied to unit.



**To avoid electrical shock or property damage, move the power switch to OFF and disconnect main circuit breaker, or unplug cord at wall receptacle.**

2. Remove control panel.
3. Pull the power switch connector from back of panel. Figure 2-58.
4. Pull the transformer connectors from back of panel. Figure 2-59.
5. Using a 5/16" nutdriver or wrench, remove the 4 nuts securing the PC board shield and pull shield from studs. Figure 2-60.
6. Pull the speaker connector from control board. Figure 2-61.
7. Using a 5/16" nut-driver or wrench, remove the 2 nuts securing the speaker to the shield and remove speaker from panel. Figure 2-62.
8. Install new speaker in reverse order.

**2-20. HIGH TEMPERATURE  
LIMIT CONTROL  
(ELECTRIC)**



**Figure 2-63**

This high temperature control is a safety, manual reset control, which senses the temperature of the shortening. If the shortening temperature exceeds 425°F (218°C), this switch opens and shuts off heat to the frypot, and E10 shows in control display. When the temperature of the shortening drops to a safe operation reset the high limit by pressing the reset button. The reset button is located behind the frypot, in the element hinge. A small instrument, such as a Phillip's head screwdriver, or Allen wrench must be used to reset the high limit. This allows heat to be supplied to the frypot once again. See Figure 2-63.

Before replacing a high temperature limit control, check to see that its circuit is closed.

**NOTICE**

The shortening temperature must be below 380°F (193°C) to accurately perform this check.

1. Remove electrical power supplied to fryer.



**To avoid electrical shock or property damage, move the power switch to OFF and disconnect main circuit breaker, or unplug cord at wall receptacle.**

**Checkout**



**Figure 2-64**

2. Remove rear cover of fryer. Figure 2-64.

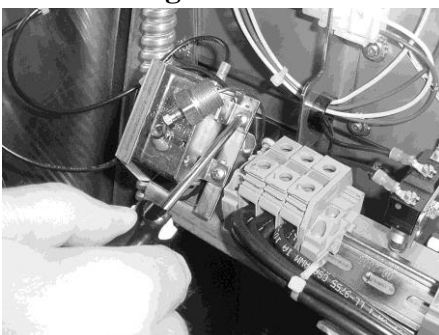

**Figure 2-65**

3. Remove the two screws securing the high limit to the bracket and pull high limit from bracket. Figure 2-65.

**2-20. HIGH TEMPERATURE  
LIMIT CONTROL  
(ELECTRIC)  
(Continued)**



**Figure 2-66**

4. Pull back cardboard cover and remove the two electrical wires from the high temperature limit control. Figure 2-66.

5. Manually reset the control, then check for continuity between the two terminals after resetting the control. If the circuit is open, replace the control, then continue with this procedure. (If the circuit is closed, the high limit is not defective. Reconnect the two electrical wires.)

**Replacement**



**To avoid electrical shock or property damage, move the power switch to OFF and disconnect main circuit breaker, or unplug cord at wall receptacle, to the frypot to be worked on. Be aware the other control on 2-frypot units will have power.**

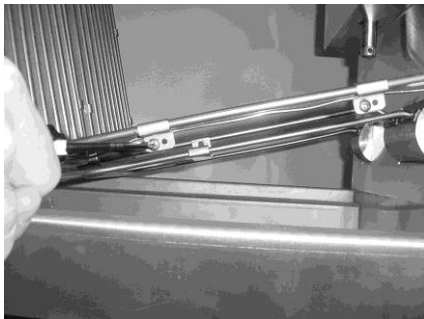

**Figure 2-67**

1. Drain the shortening from the frypot.
2. Remove capillary from brackets on upper part of element. Figure 2-67.



**Figure 2-68**

3. Remove capillary bulb from bulb holder inside the frypot.

**2-20. HIGH TEMPERATURE**  
**LIMIT CONTROL**  
**(ELECTRIC)**  
**(Continued)**

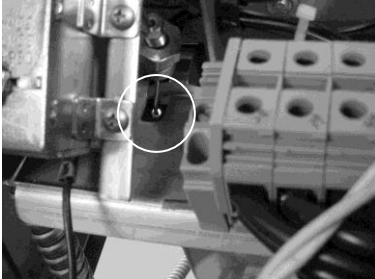

**Figure 2-69**

4. Straighten the capillary tube, and pull capillary tube through the hole in the element hinge, from the rear of the fryer.
5. Remove the defective control from the fryer.
6. Straighten the capillary tube on the new high limit, and thread the capillary tube through the hole in the element hinge.  
Figure 2-69.
7. Reattach the capillary to the brackets on the upper and lower parts of the elements.

**CAUTION**

*DO NOT crimp or kink the capillary tube during installation. Also, keep capillary tube behind element to protect from damage from the basket or during cleaning. Damage to the capillary tube reduces the life of the high limit, or causes the high limit to fail.*

8. Connect wires to new high limit body and fasten to bracket, using the two screws removed in the checkout part of this section.

**NOTICE**

Make sure red reset button of high limit lines up with the plunger that inserts into the element hinge.



**To avoid electrical shock or other injury, run the capillary line under and away from all electrical power wires and terminals. The tube must never be in such a position where it could accidentally touch the electrical power terminals**

9. Re-install the rear cover and unit is now ready for use.

**2-21. FILTER PUMP AND MOTOR REMOVAL**



**Figure 2-70**

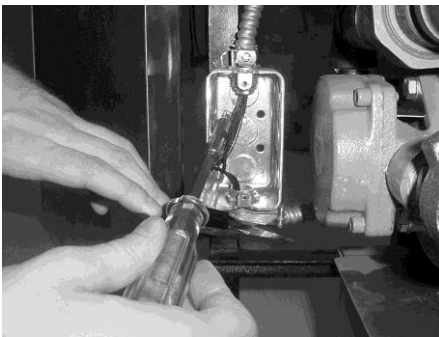

**Figure 2-71**

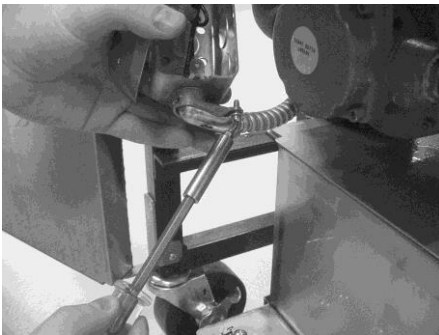

**Figure 2-72**



**Figure 2-73**

1. Remove electrical power supplied to unit.



**To avoid electrical shock or property damage, move the power switch to OFF and disconnect main circuit breaker, or unplug cord at wall receptacle.**

2. Open the door (left door on 2 well units), and remove the 2 screws securing the switch box cover and pull filter motor wires from filter switch. Figure 2-70.

3. Remove the 2 screws securing the switch box to the frame. Figure 2-71

4. Loosen screws on conduit connector and pull conduit from the connector. Figure 2-72.

5. Disconnect filter union to filter in drain pan.

6. Using a pipe wrench, disconnect the outlet pipe to frypot. Figure 2-73.

**2-21. FILTER PUMP AND  
MOTOR REMOVAL  
(Continued)**

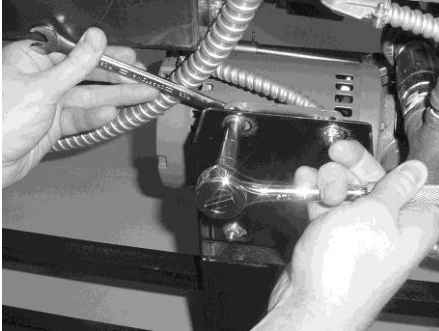

**Figure 2-74**

7. Remove left side panel.
8. Using 9/16" socket or wrenches, remove the bolts and nuts securing the motor to the bracket and pull pump, motor, and piping from unit. Figure 2-74.

**2-22. AUTOLIFT  
TRANSFORMER  
REPLACEMENT  
(if applicable)**

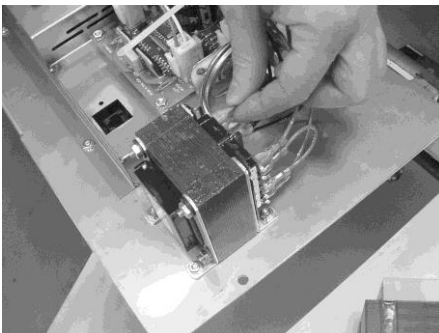

**Figure 2-75**

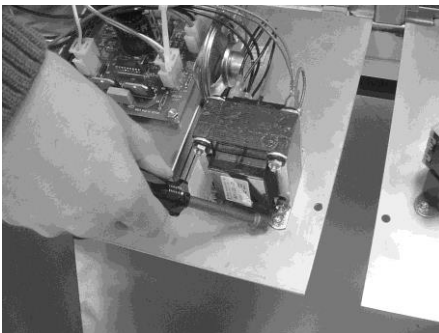

**Figure 2-76**

1. Remove electrical power supplied to unit.



**To avoid electrical shock or property damage, move the power switch to OFF and disconnect main circuit breaker, or unplug cord at wall receptacle.**

2. Remove control panel.
3. Label and remove wires from transformer. Figure 2-75.
4. Using 3/8" nut-driver or wrench, remove nuts securing transformer to panel and remove transformer from panel. Figure 2-76.
5. Install new transformer in reverse order.

**2-23. AUTOLIFT PC BOARD  
REPLACEMENT  
(if applicable)**

Autolift PC Board

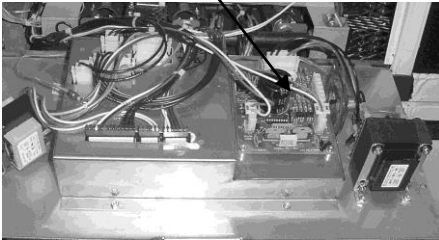

**Figure 2-77**

1. Remove electrical power supplied to unit.



To avoid electrical shock or property damage, move the power switch to OFF and disconnect main circuit breaker, or unplug cord at wall receptacle.

2. Remove control panel
3. Disconnect connectors from PC board.
4. Using 5/16” nut-driver or wrench, remove the 4 nuts securing the autolift PC board to the panel and remove PC board from panel.
5. Install new panel in reverse order.

**2-24. AUTOLIFT  
ACTUATOR (MOTOR)  
REPLACEMENT  
(if applicable)**



**Figure 2-78**

1. Remove electrical power supplied to unit.



To avoid electrical shock or property damage, move the power switch to OFF and disconnect main circuit breaker, or unplug cord at wall receptacle.

2. Drain shortening from frypot.
3. Remove basket and knock pin from basket hanger. Figure 2-78.
4. Remove rear cover. Figure 2-79.



**Figure 2-79**

**2-24. AUTOLIFT**  
**ACTUATOR (MOTOR)**  
**REPLACEMENT**  
**(if applicable)**

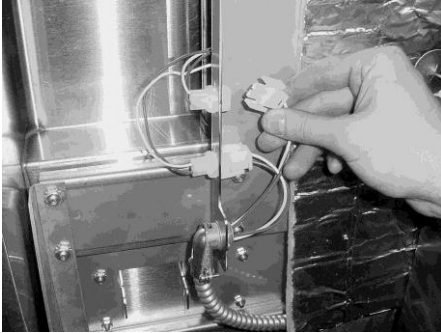

**Figure 2-80**

5. Disconnect actuator connector. Figure 2-80.

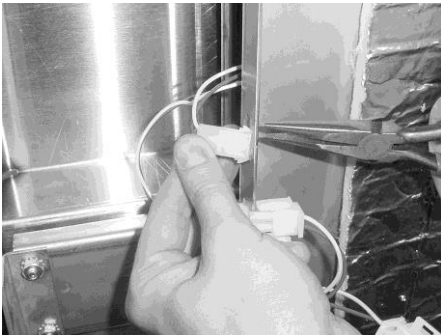

**Figure 2-81**

6. Remove female connector from plate. Figure 2-81.

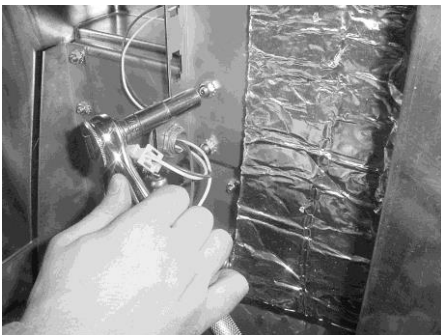

**Figure 2-82**

7. Using 7/16" socket, remove the 4 nuts securing the support plate. 2 nuts are behind the insulation. Figures 2-82 & 2-83.



**Figure 2-83**

**2-24. AUTOLIFT**  
**ACTUATOR (MOTOR)**  
**REPLACEMENT**  
**(if applicable)**



**Figure 2-84**

8. Remove the 2 top screws securing the support plate and remove the plate from the unit. Figure 2-84.



**Figure 2-85**

9. Using a 15T torx driver, remove the 2 torx screws from the back shroud, and pull the actuator from the unit. Figure 2-85.

10. Install new actuator in reverse order.

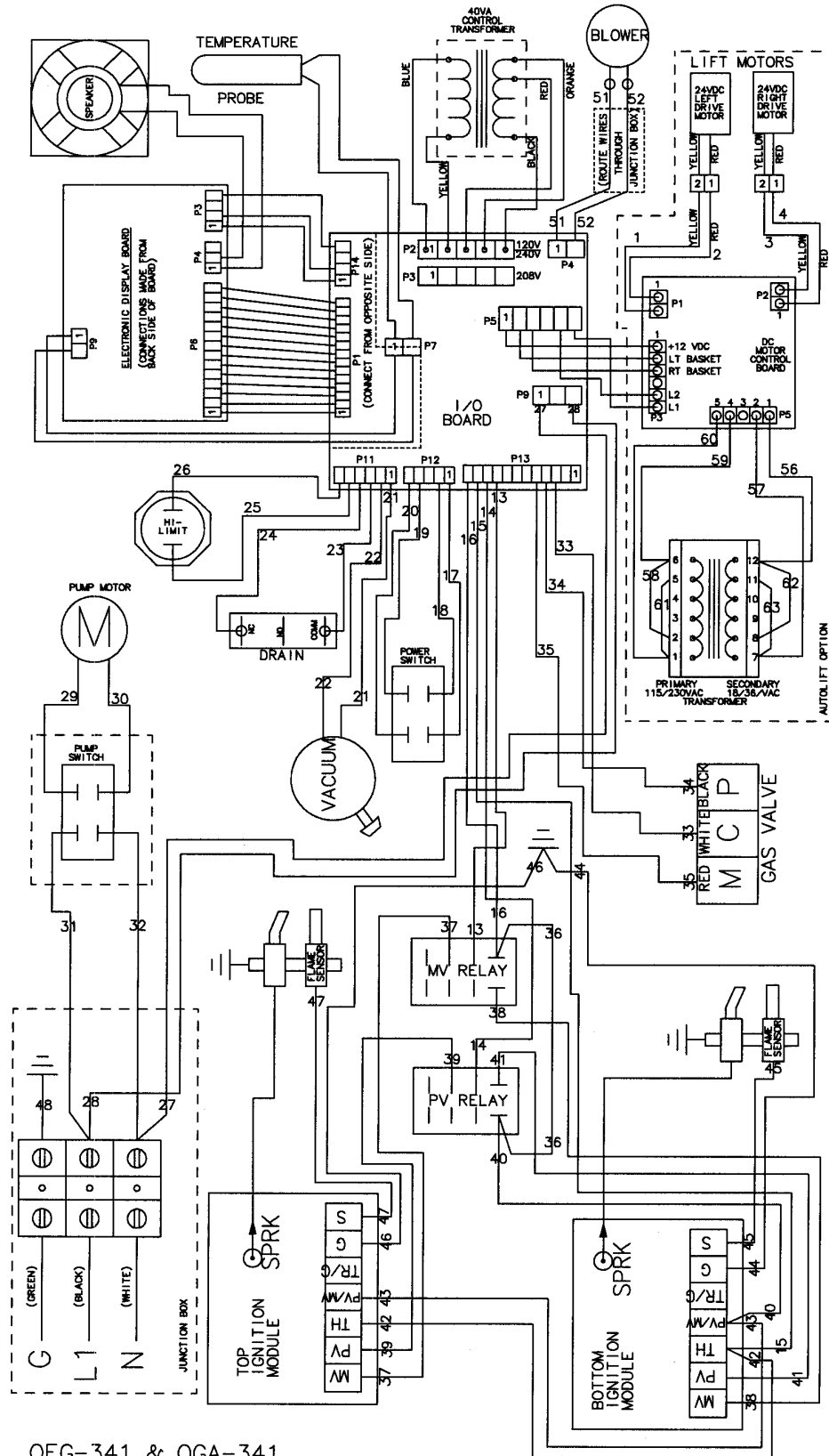

OFG-341 & OGA-341  
OPEN FRYER  
120V, 60HZ, 2W+G

21640

**Drain switch wired N/C**

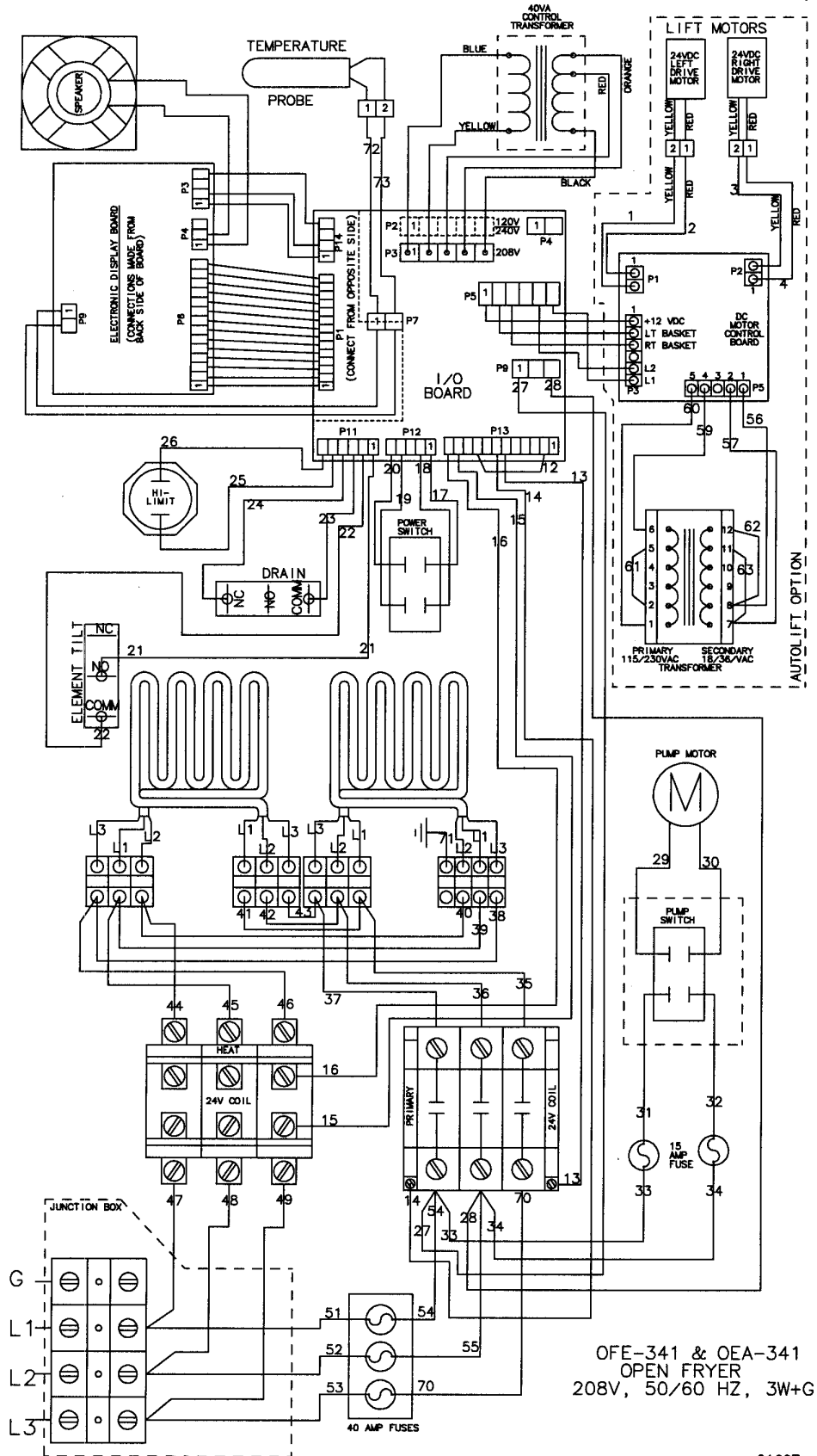

OFE-341 & OEA-341  
OPEN FRYER  
208V, 50/60 HZ, 3W+G

21607

**Drain switch wired N/C**

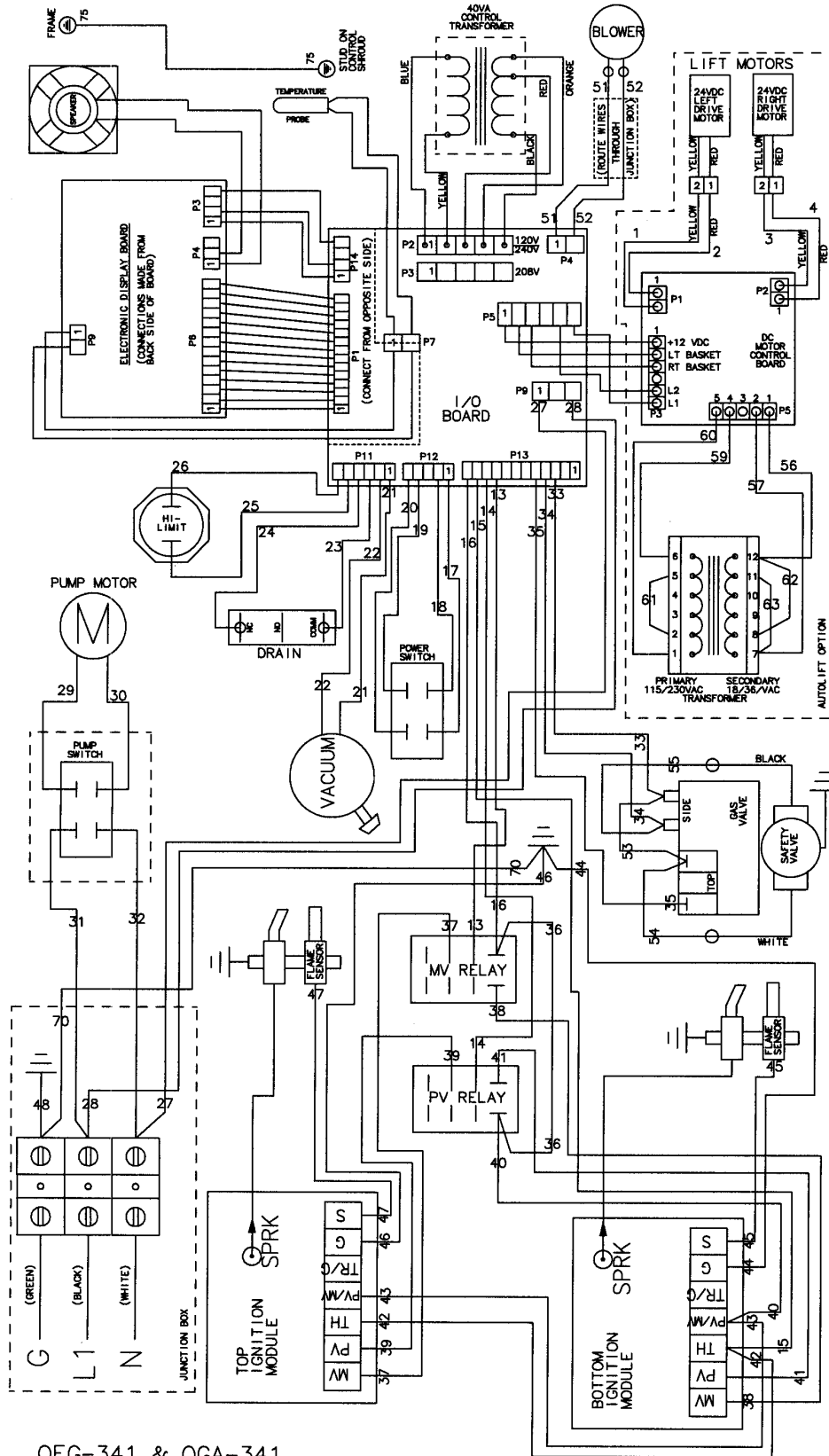

OFG-341 & OGA-341  
OPEN FRYER  
230V, 50HZ, 1N+G

21659

**Drain switch wired N/C**

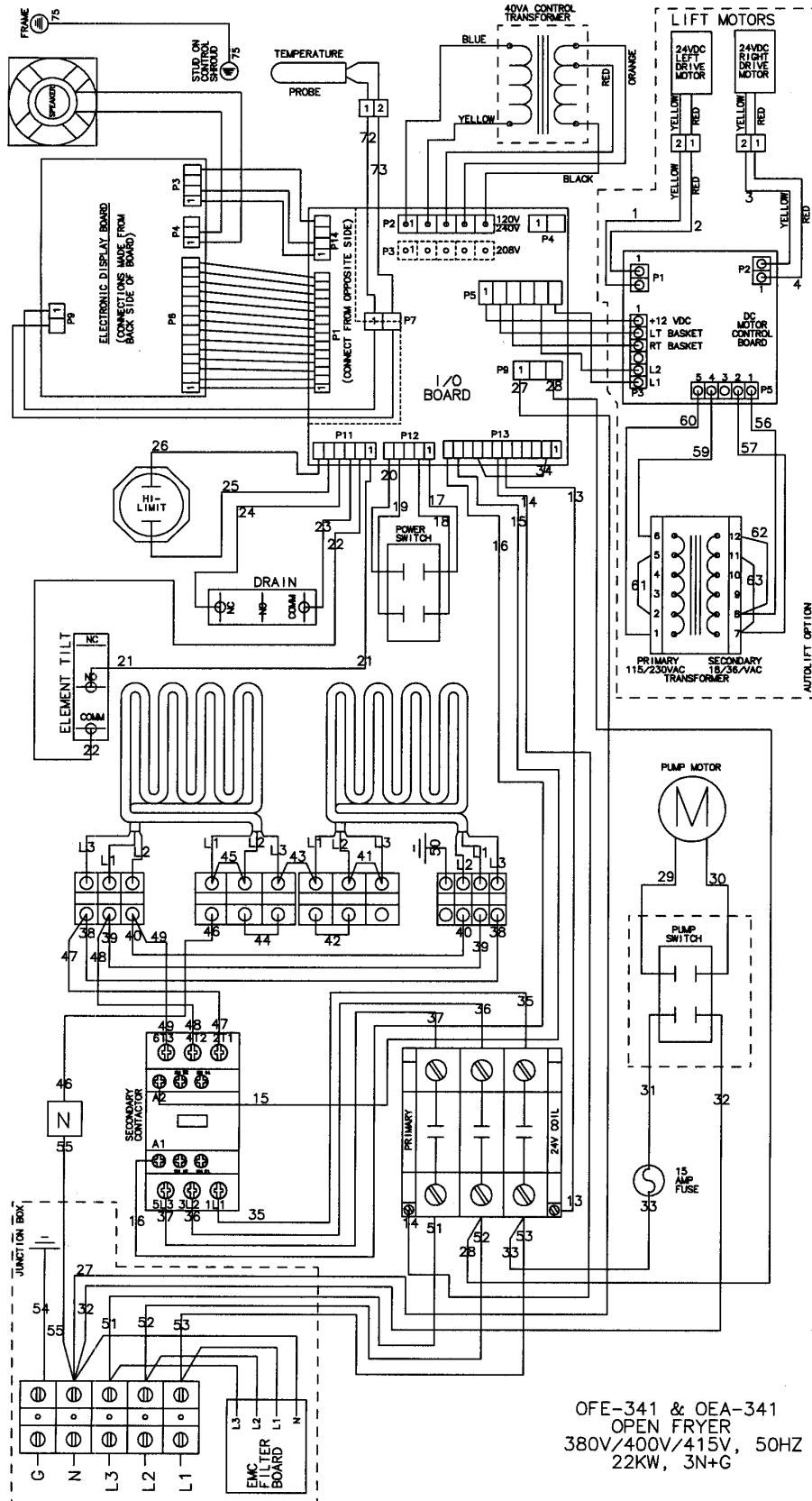

OFE-341 & OEA-341  
OPEN FRYER  
380V/400V/415V, 50HZ  
22KW, 3N+G

21702

Drain switch wired N/C

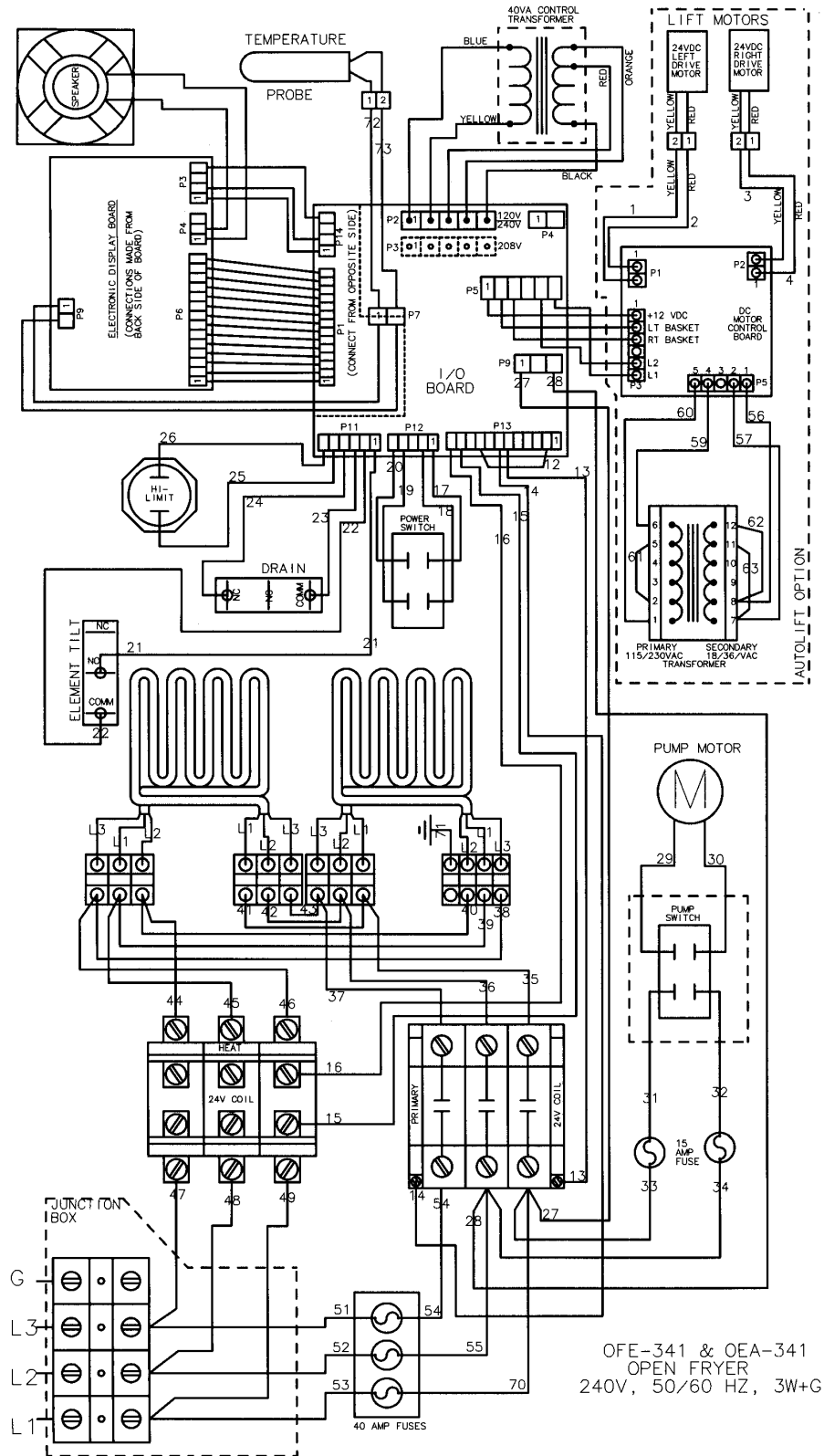

OFE-341 & OEA-341  
OPEN FRYER  
240V, 50/60 HZ, 3W+G

21857

**Drain switch wired N/C**

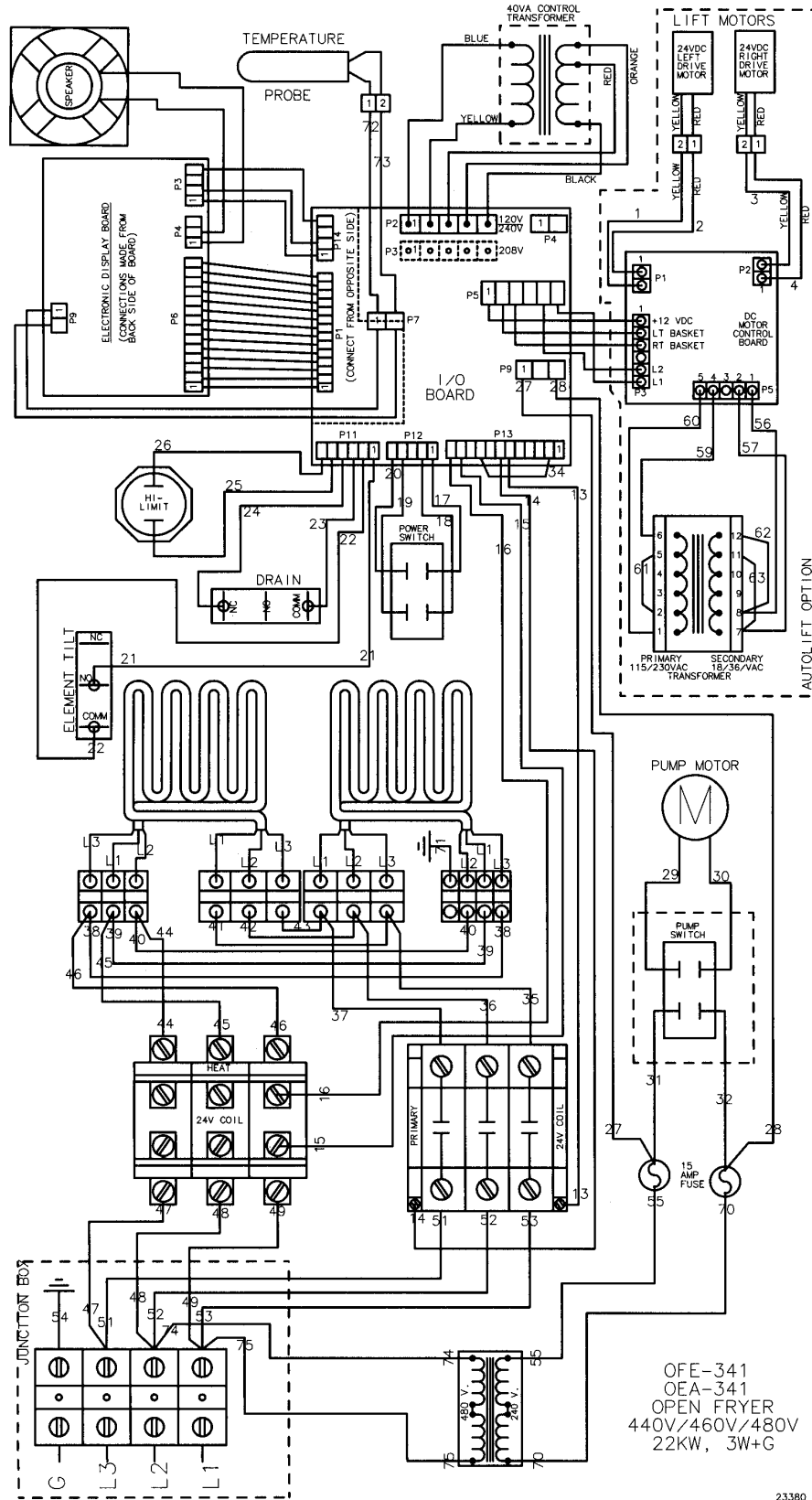

23380

Drain switch wired N/C

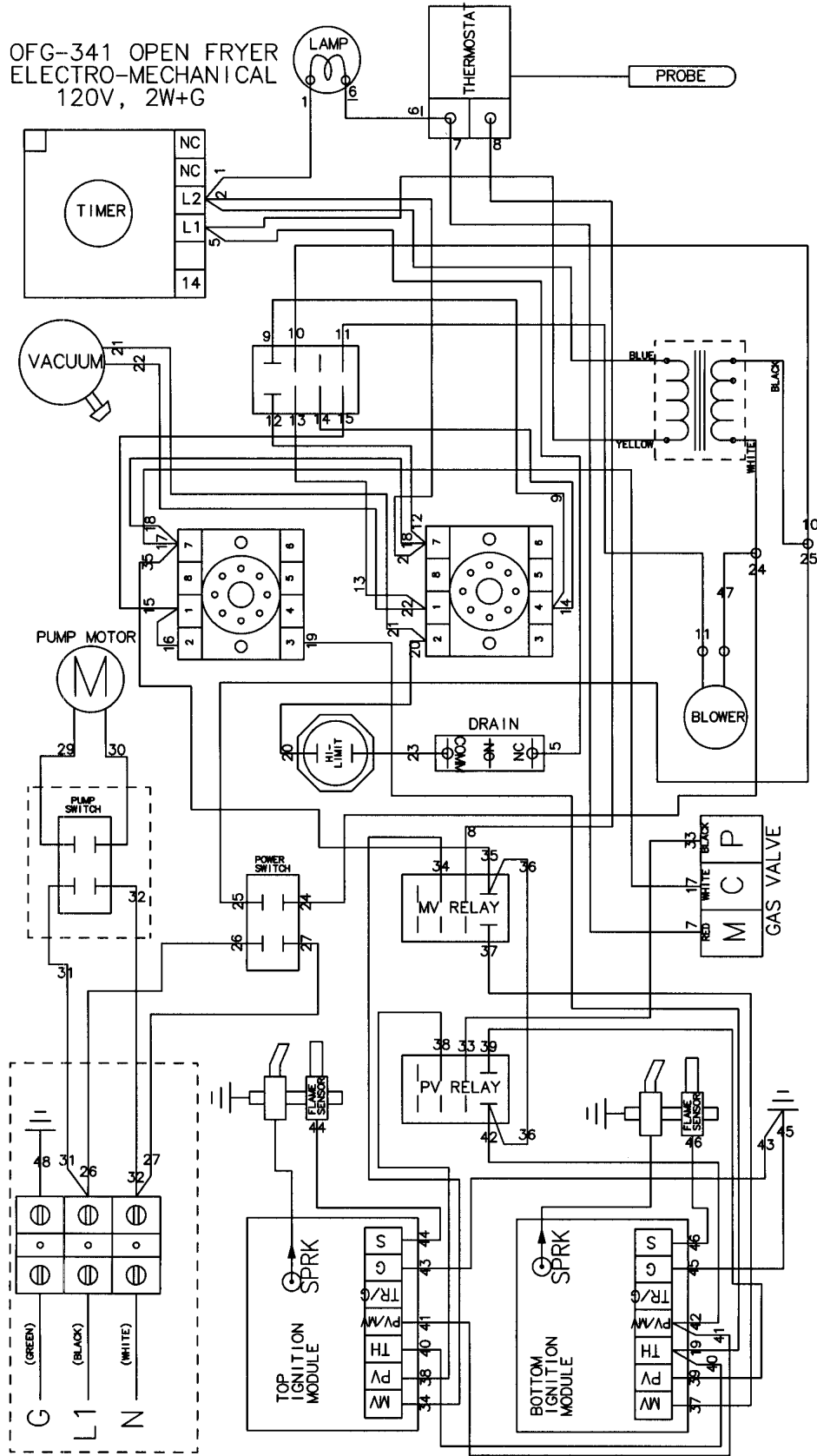

21941

Drain switch wired N/C

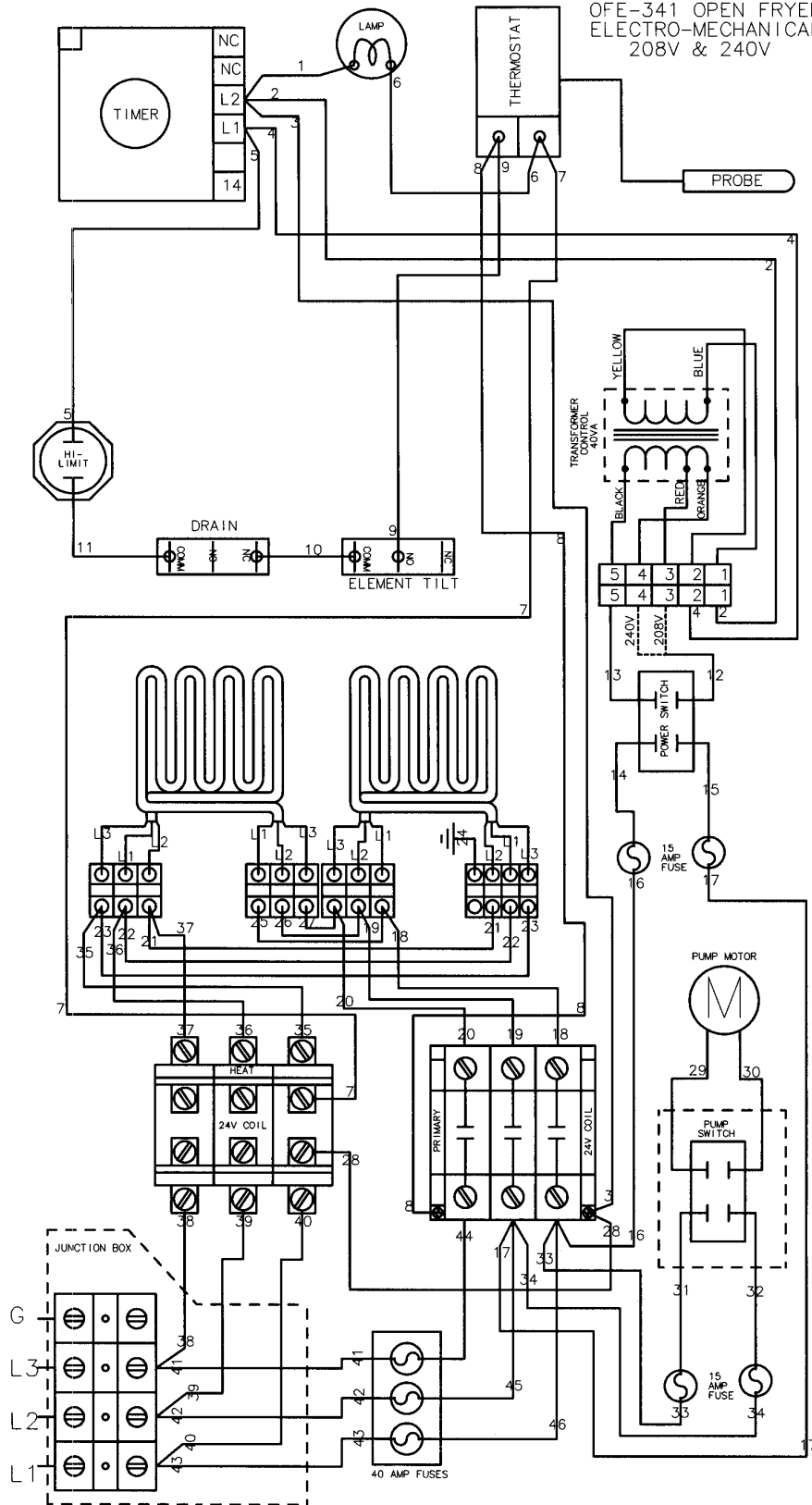

21858

**Drain switch wired N/C**

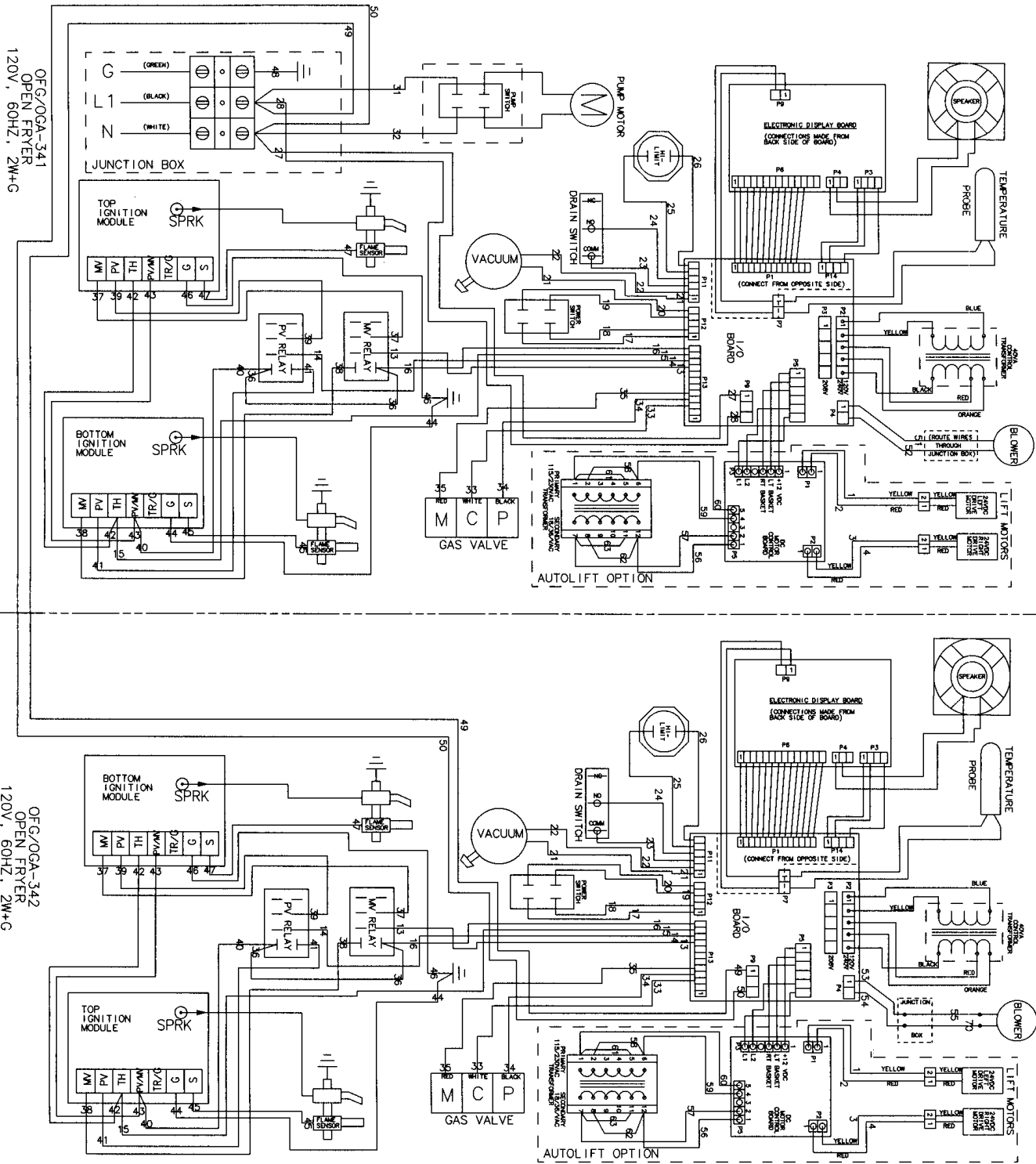

Drain switch wired N/O

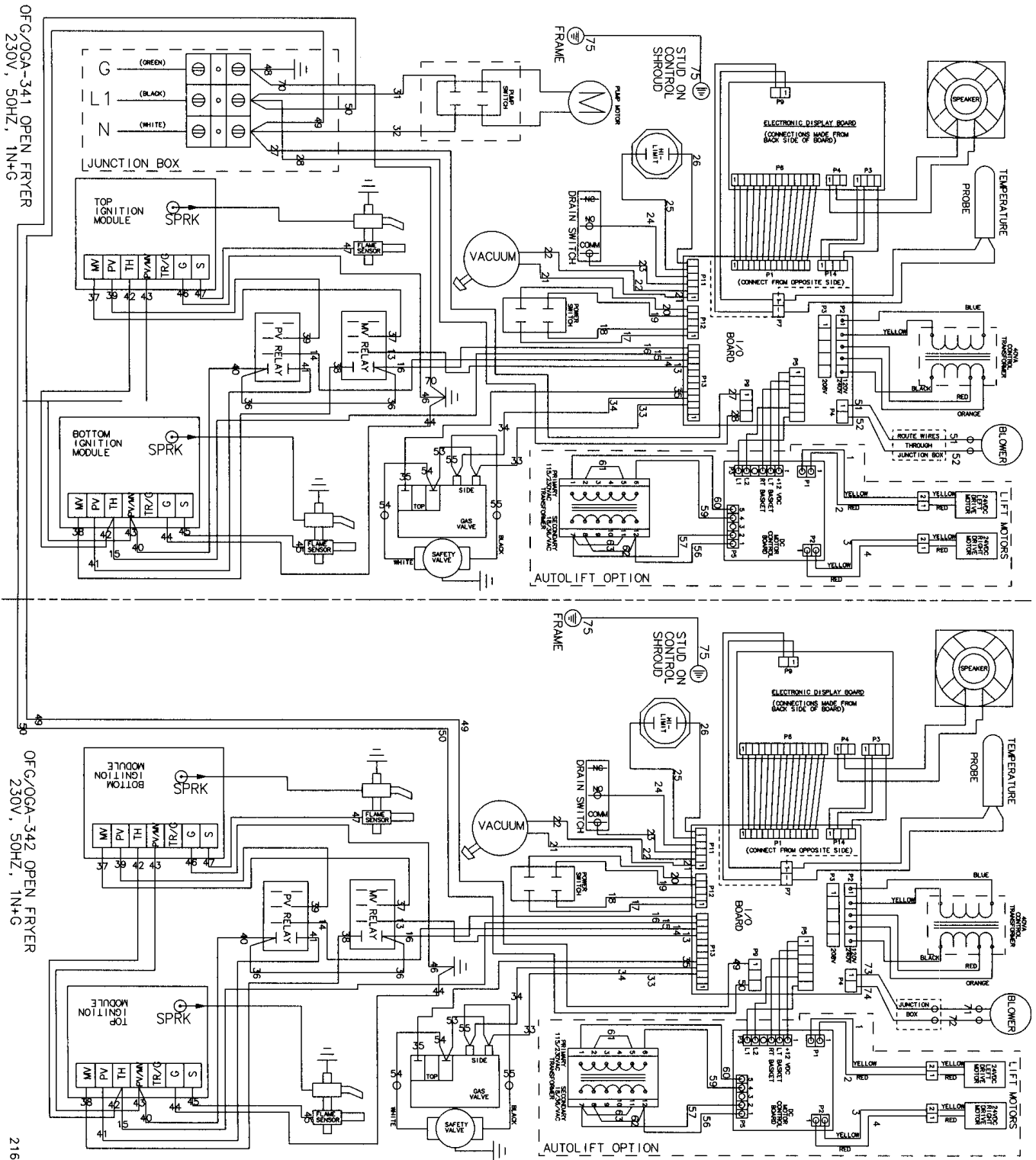

Drain switch wired N/O

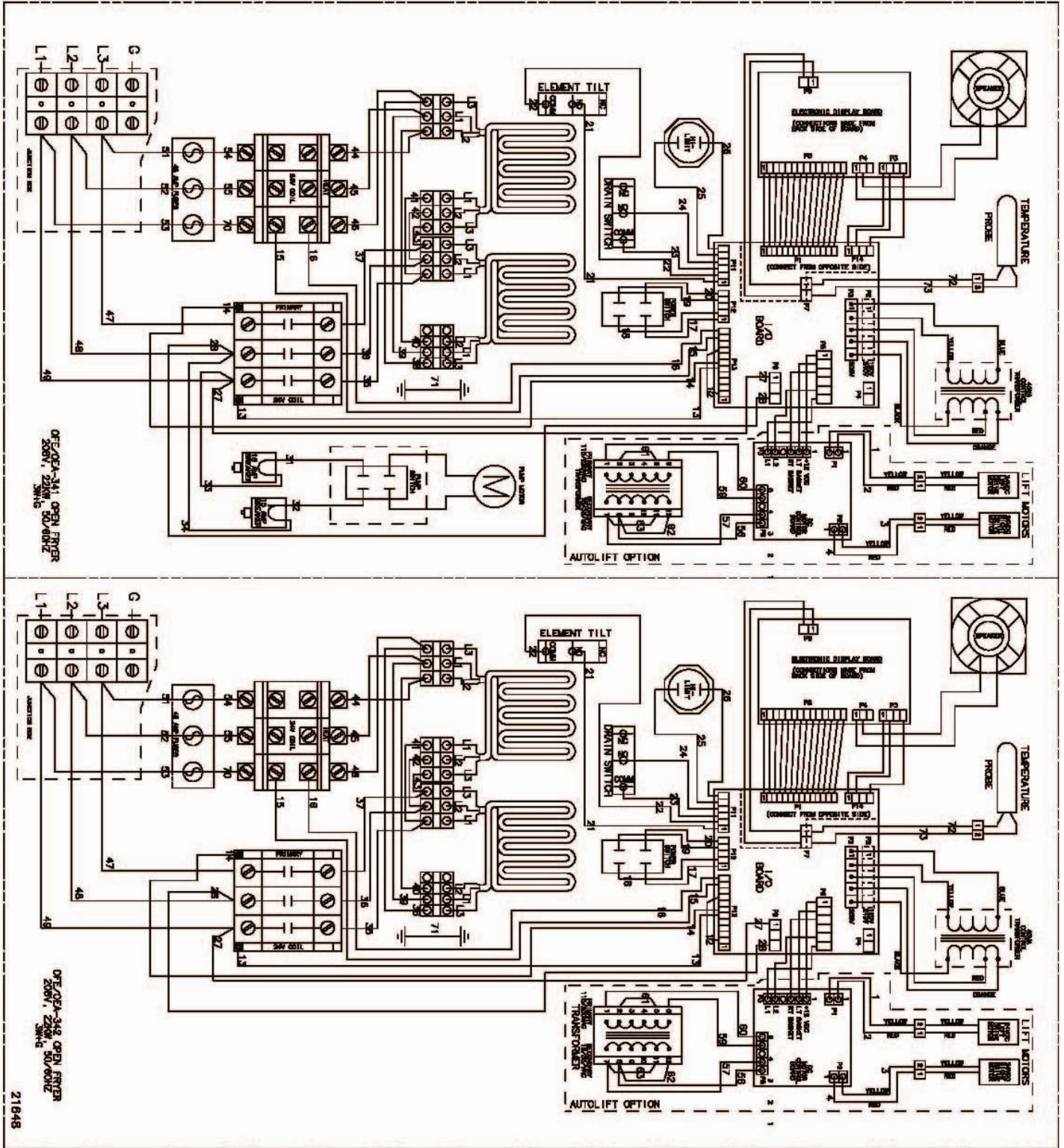

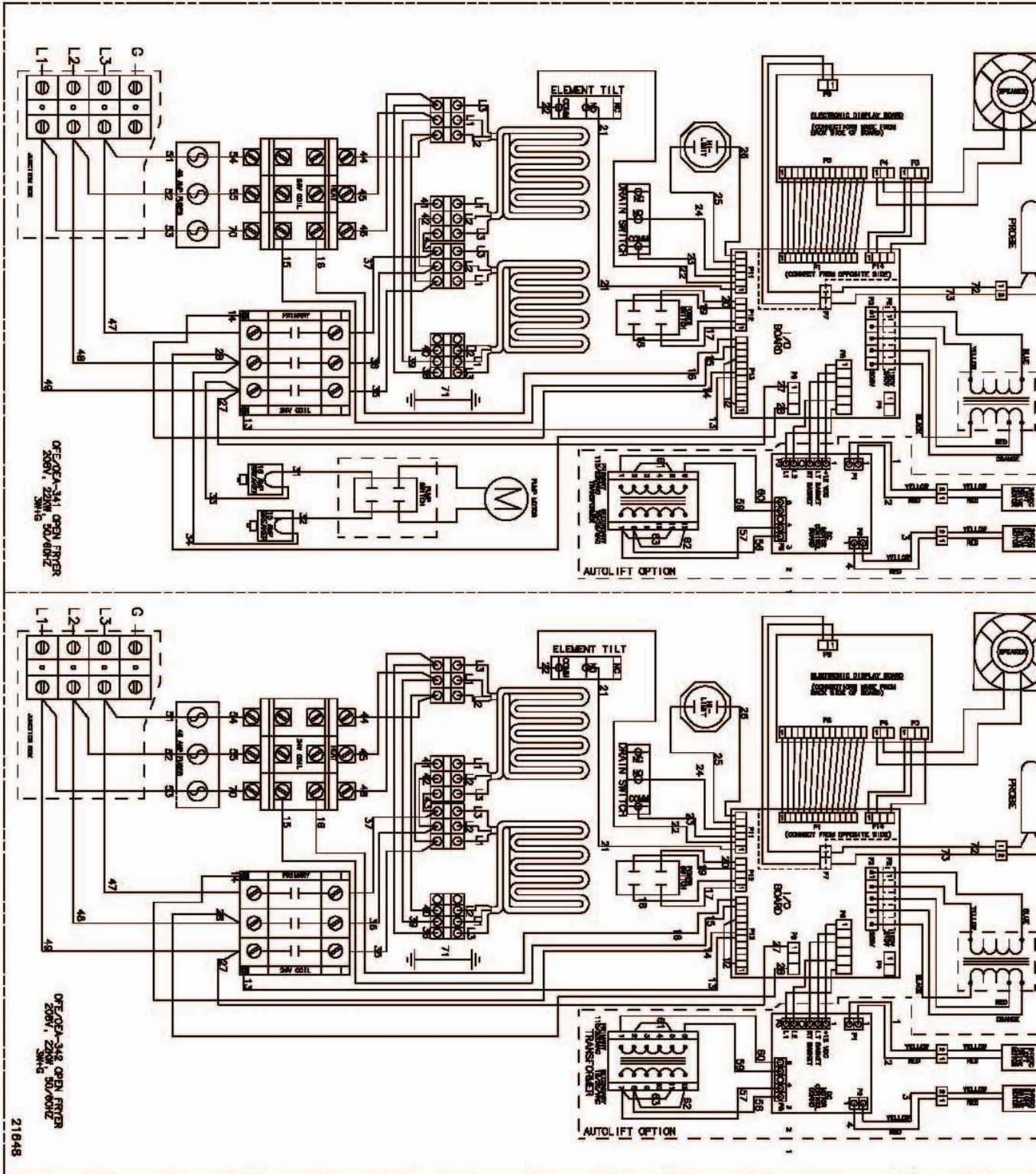

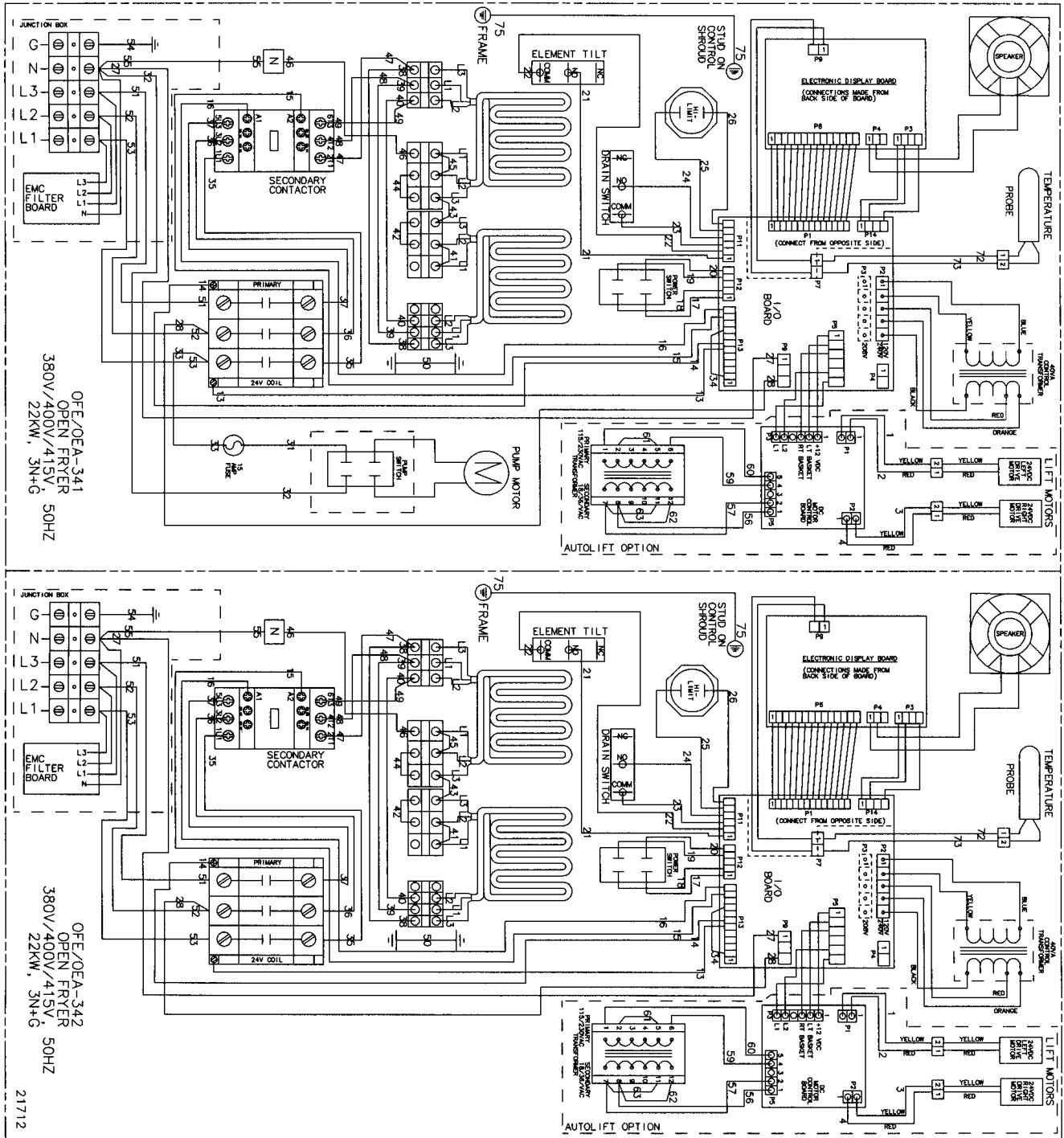

Drain switch wired N/O



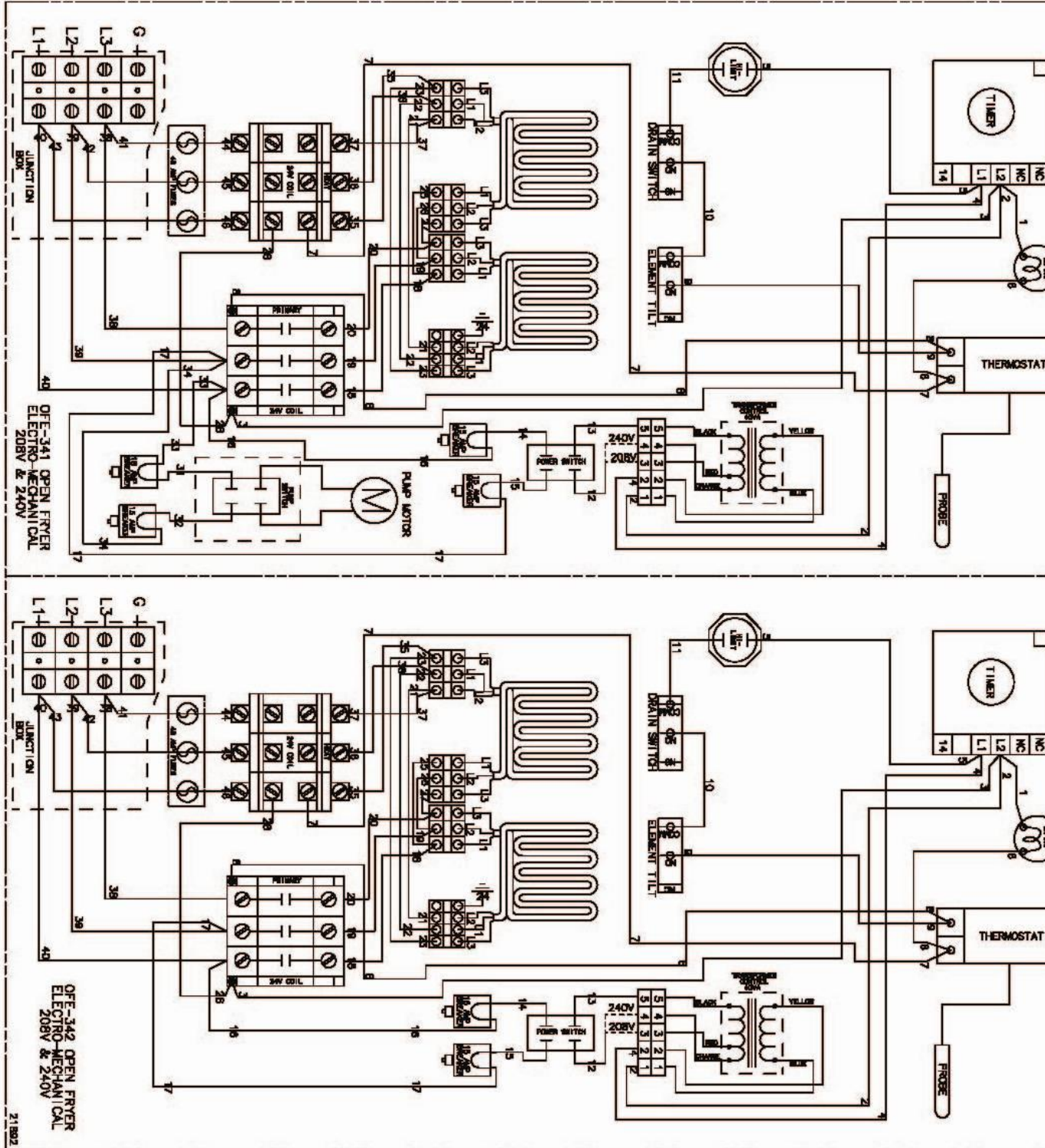

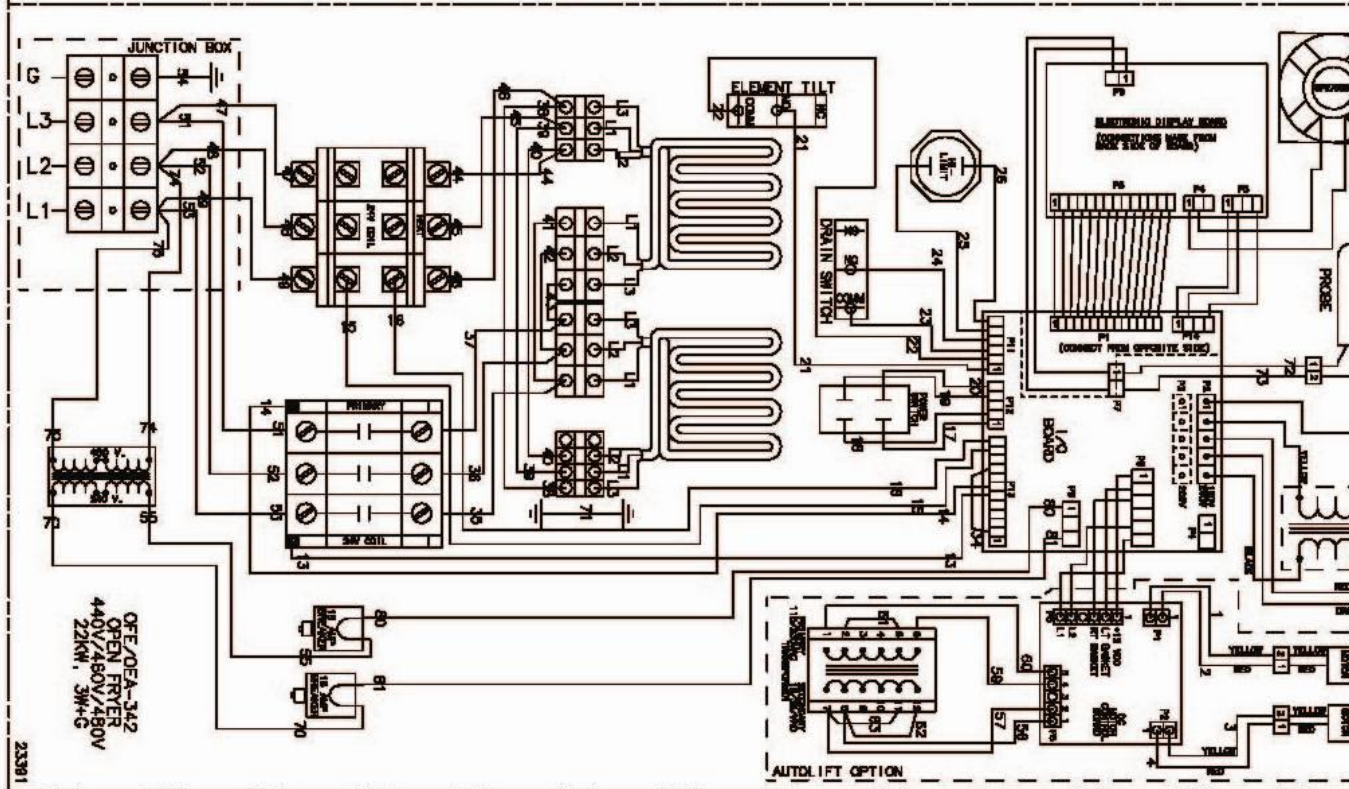
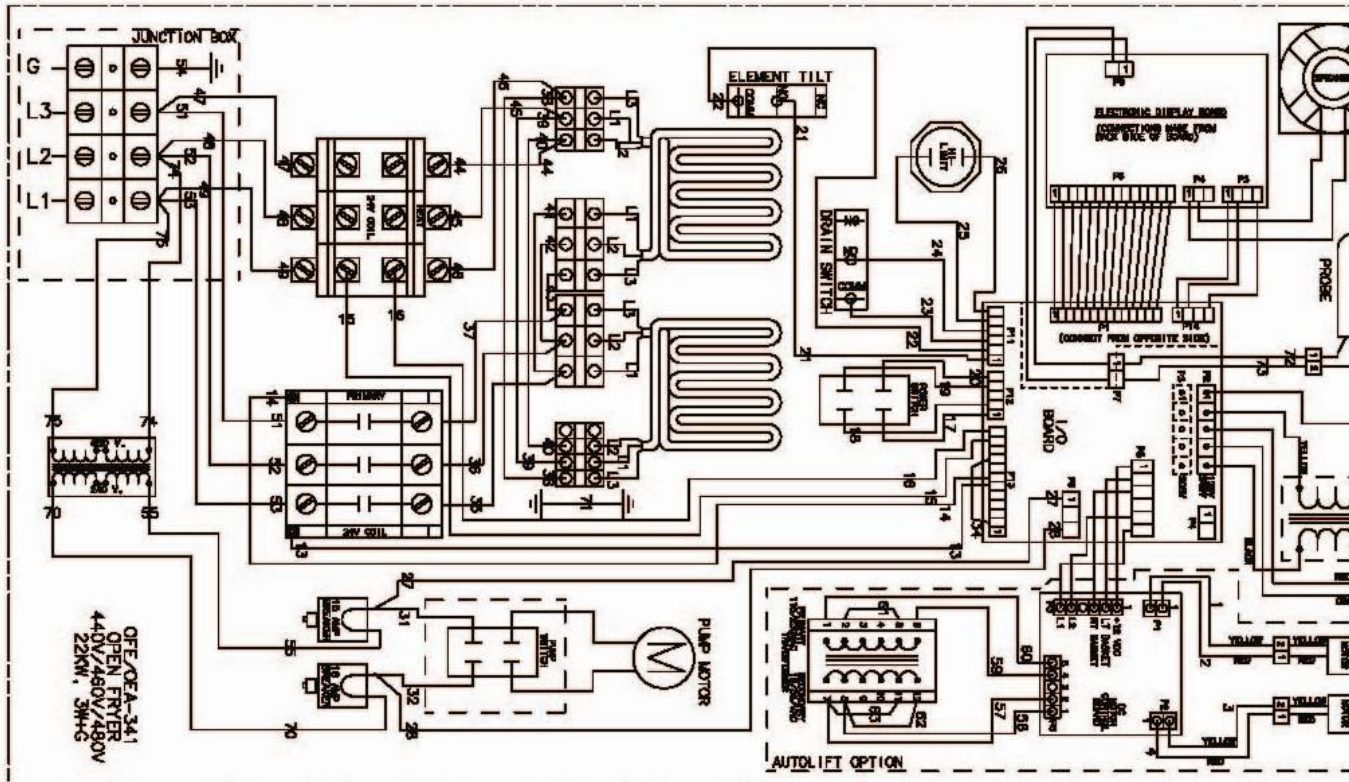

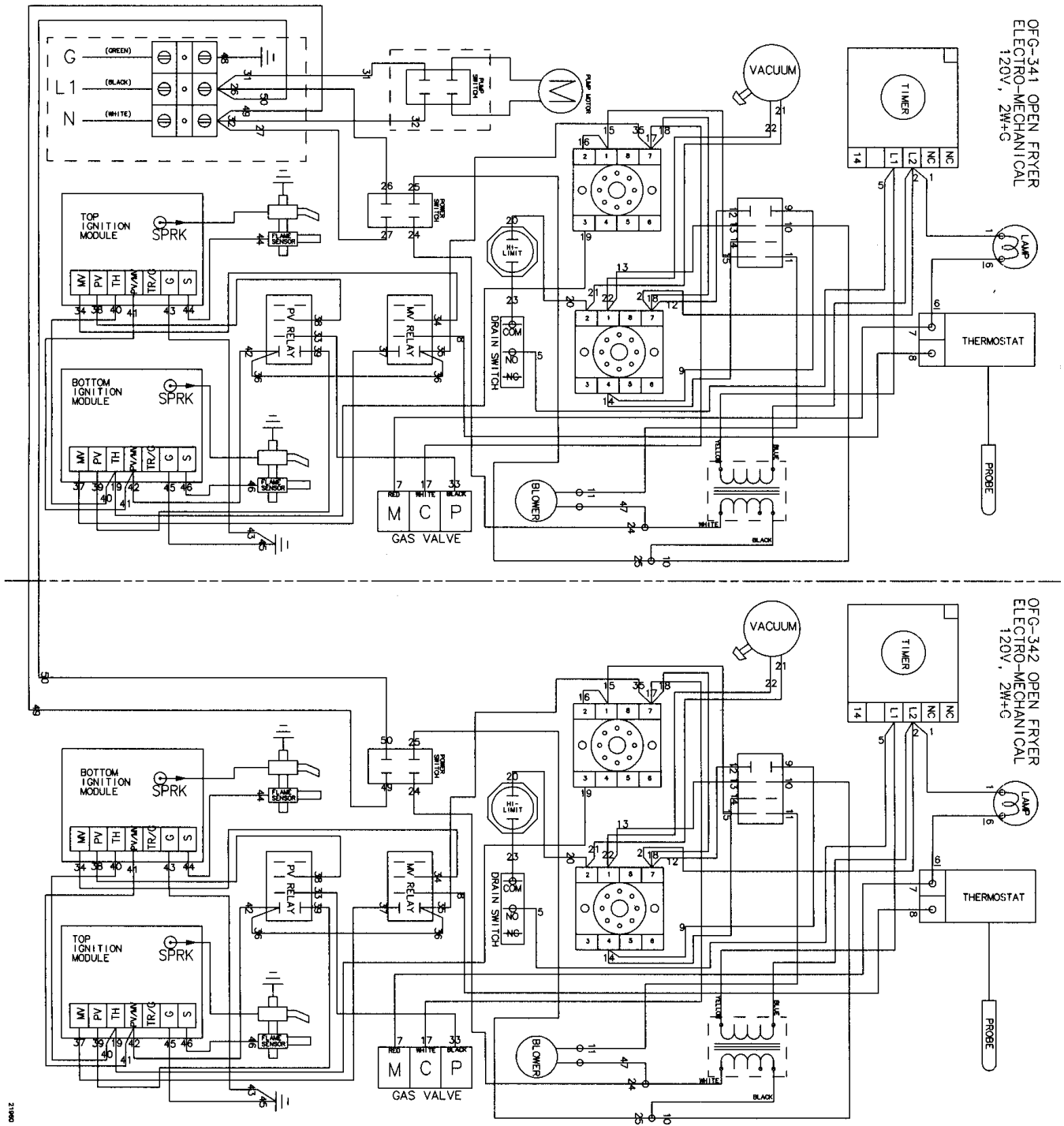

Drain switch wired N/O

## SECTION 3. PARTS INFORMATION

### 3-1. INTRODUCTION

This section list the replaceable parts of the Henny Penny OFE/OFG- 32X Open Fryers.

### 3-2. GENUINE PARTS

Use only genuine Henny Penny parts in your fryer. Using a part of lesser quality or substitute design may result in damage to the unit or personal injury.

### 3-3. WHEN ORDERING PARTS

Once the parts that you want to order have been found in the parts list; write down the following information:

Item number	<u>3</u>	
Part number	<u>60783</u>	example:
Description	<u>Vacuum Switch</u>	

From the data plate, list the following information:

Product number	<u>OFG341.0</u>	
Serial number	<u>0001</u>	example:
Voltage	<u>120</u>	

### 3-4 PRICES

Your distributor has a price parts list and will be glad to inform you of the cost of your parts order.

### 3-5 DELIVERY

Commonly replaced items are stocked by your distributor and will be sent to you when your order is received. Other parts will be ordered, by your distributor, from Henny Penny Corporation. Normally, these will be sent to your distributor within three working days.

### 3.6 WARRANTY

All replacement parts (except lamps and fuses) are warranted for 90 days against manufacturing defects and workmanship. If damage occurs during shipping, notify the carrier at once so that a claim may be properly filed. Refer to warranty in the front of this manual for other rights and limitations.

### 3.7 RECOMMENDED SPARE PARTS FOR DISTRIBUTORS

Recommended replacement parts, stocked by your distributor, are indicated with √ in the parts lists. Please use care when ordering recommended parts, because all voltages and variations are marked. Distributors should order parts based upon common voltages and equipment sold in their territory.

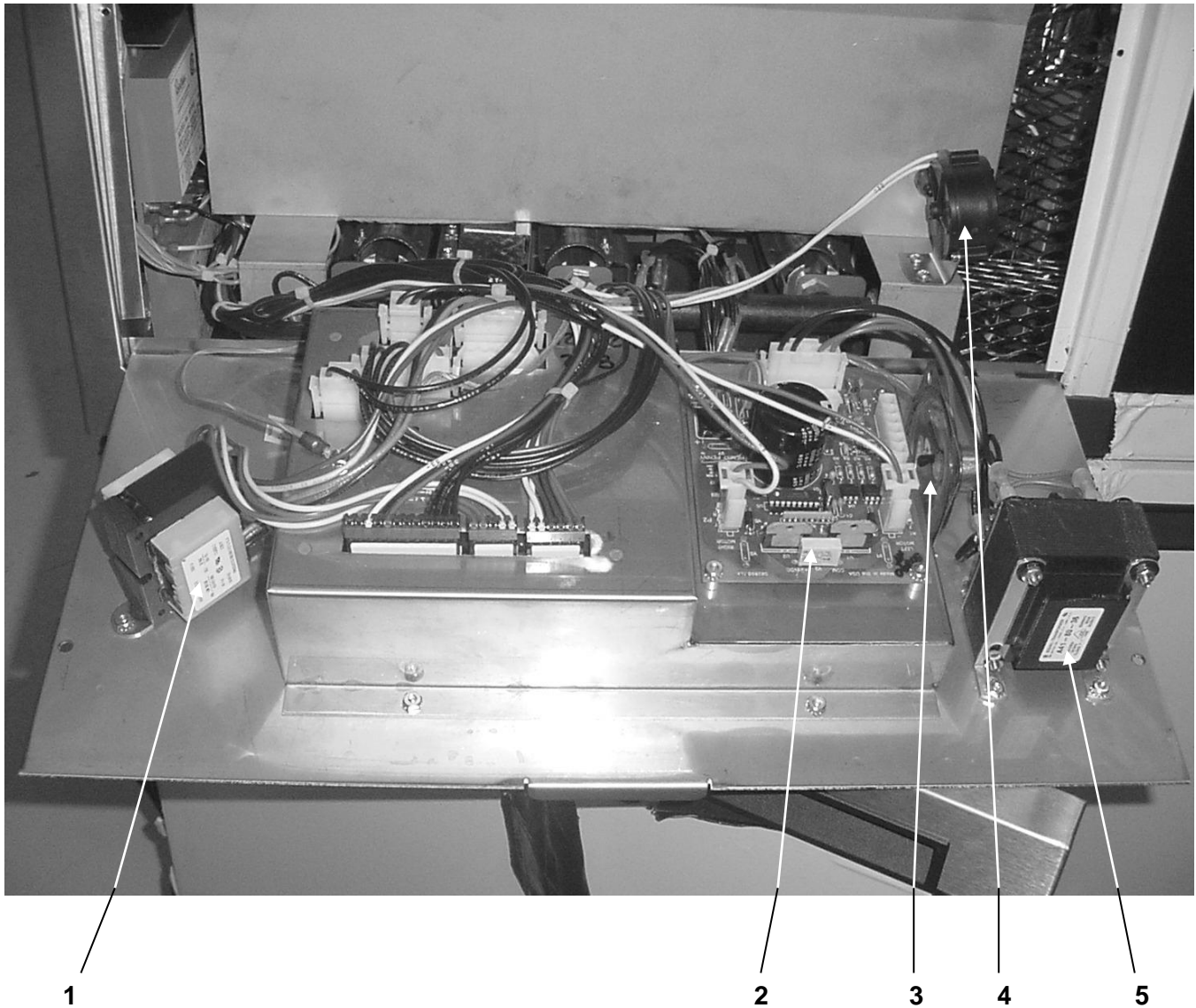

Item No.	Part No.	Description	Qty. per Well
√ 1	60207	Transformer – 120-24V	1
√ 1	60536	Transformer – 230-24V	1
√ 2	50290RB	Autolift PC Board	1
√ 3	54561	Speaker Assy.	1
√ 4	72514	Vacuum Switch (Gas Only)	1
√ 5	TS22-012	Transformer-Autolift	1
√ recommended parts			

**Gas Components**

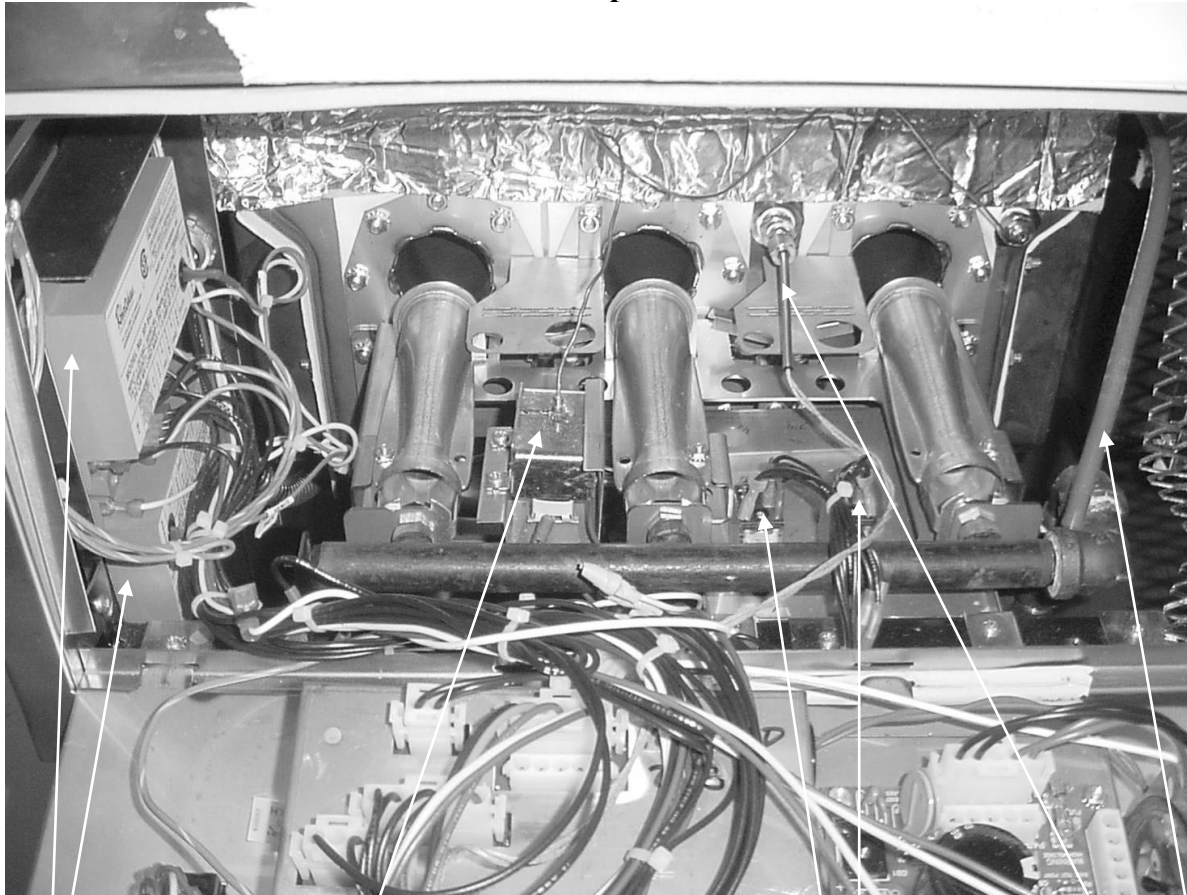

Item No.	Part No.	Description	Qty. per Well
√ 1	77602	Ignition Module – CE (OFG-SN: BR0804001 & Above) (OGA-SN: BS0805001 & Above)	2
√ 1	77839	Ignition Module – Non -CE (OFG-SN: BR0804001 & Above) (OGA-SN: BS0805001 & Above)	2
√ 1	14933	Kit - Ignition Module – Non-CE (OFG-SN: BR0803010 & Below) (OGA-SN: BS0804002 & Below)	1
√ 1	14920	Kit - Ignition Module – CE (OFG-SN: BR0803010 & Below) (OGA-SN: BS0804002 & Below)	1
√ 2	60241	High Limit	1
√ 3	60818	Relay – 10A-24V	2
√ 4	14849	Temperature Probe Assy.	1
5	60202	Vacuum Switch Hose	1
6*	32792	Assy – Gas Line (Flex) – 342	1

√ recommended parts/\*not shown

**Gas Burner Assembly**

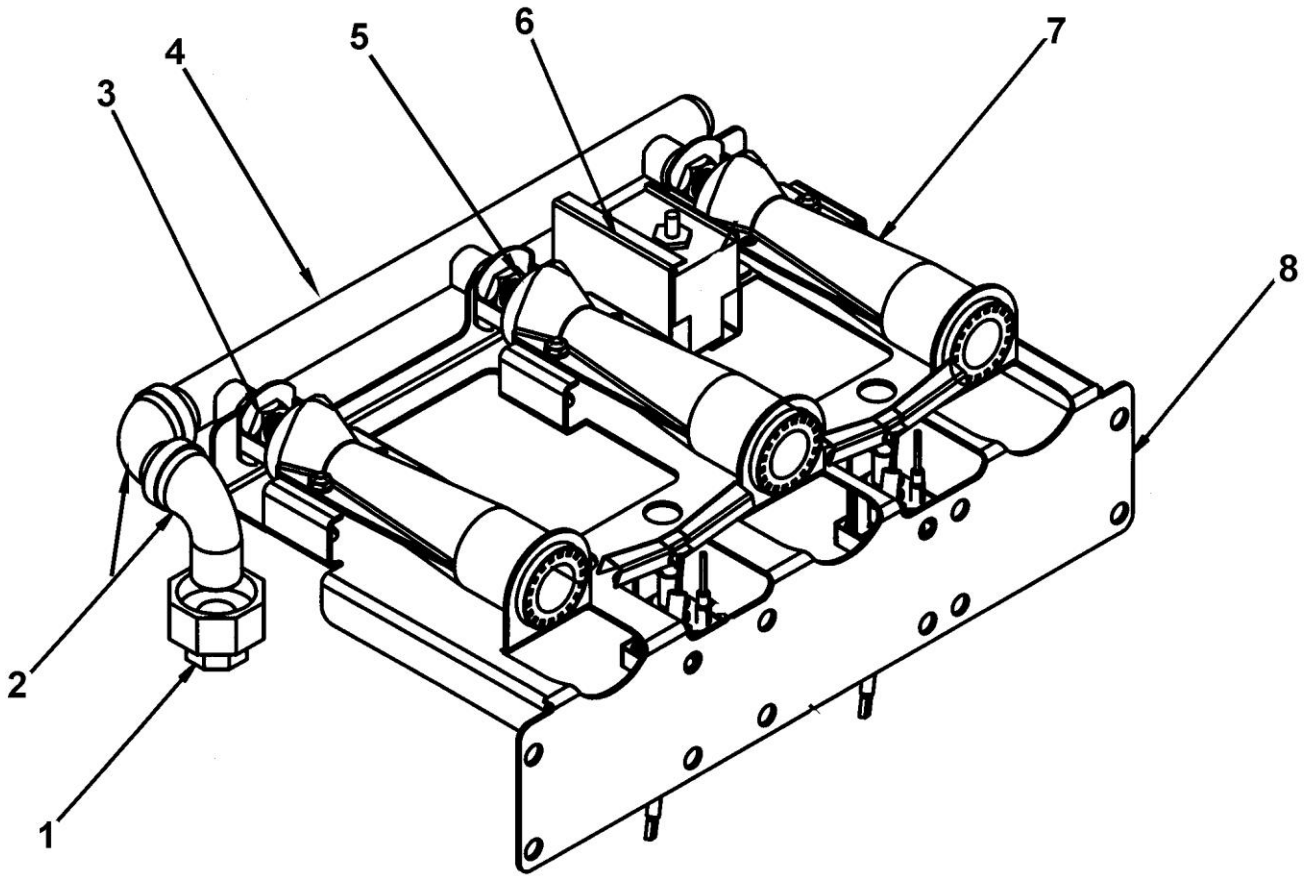

Item No.	Part No.	Description	Qty. per Well
1	<a href="#">FP01-091</a>	Union – ½ NPT Female - BI	1
2	<a href="#">FP01-088</a>	Elbow – Street ½ x 90 BI	2
3	NS03-067	Nut – Locking ½-20 x 3/16 LON	3
4	23389	Weldment - Manifold	1
5	<a href="#">64055-03</a>	Orifices – Burner - LP	3
5	<a href="#">64055-16</a>	Orifices – Burner – Nat.	3
6	21629	Bracket – High Limit Mounting	1
7	<a href="#">60032</a>	Burner – Inshot	3
8	23118	Stud Assy – Burner Bracket – 34X	1

**Electric Components**

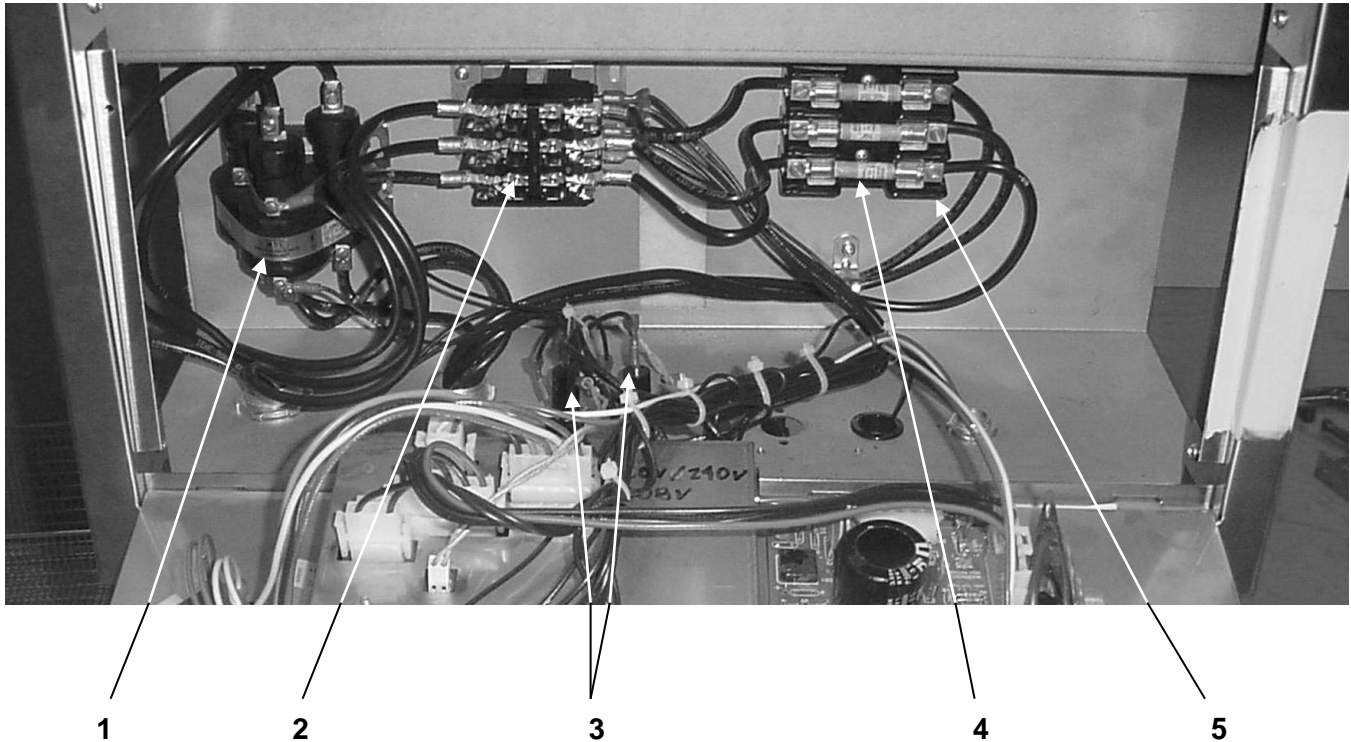

Item No.	Part No.	Description	Qty. per Well
√ 1	29510	Mercury Contactor – 24V	1
√ 2	51795	Standard Contactor – 24V	1
√ 2	65075	Assy.-240v E/M Heat Contactor-CE-240V (UK)	1
√ 2	65074	Assy.-240v E/M Heat Contactor-CE-230V	1
√ 3	18364	Fuse and Holder Assembly (SN: BC0707002 & below)	2
√ 3	EF02-007	Fuse – 15 Amp	2
√ 3	EF02-006	Fuse Holder – 15 Amp	2
√ 3	EF02-125	Breaker – Push Button Reset (SN: BC0707003 & above)	2
√ 3	EF02-105	Fuse – 15 Amp – CE	2
√ 3	EF02-104	Fuse Holder – 20 Amp – CE	2
√ 4	14970	Fuse-Class “G” – 60 Amp (Set of 3)	1
5	60722	Block-Fuse – 60 Amp	1
6*	19923	Transformer – Large – 480V	1(per unit)
7*	60838	Transformer-.05 KVA, 480-240V	1(per 342)

√ recommended parts/\*not shown  
707



1

2

Item No.	Part No.	Description	Qty. per Well
1	60367	Guard - High Limit	1
√ 2	14849	Temperature Probe Assembly (Gas units)	1

√ recommended parts

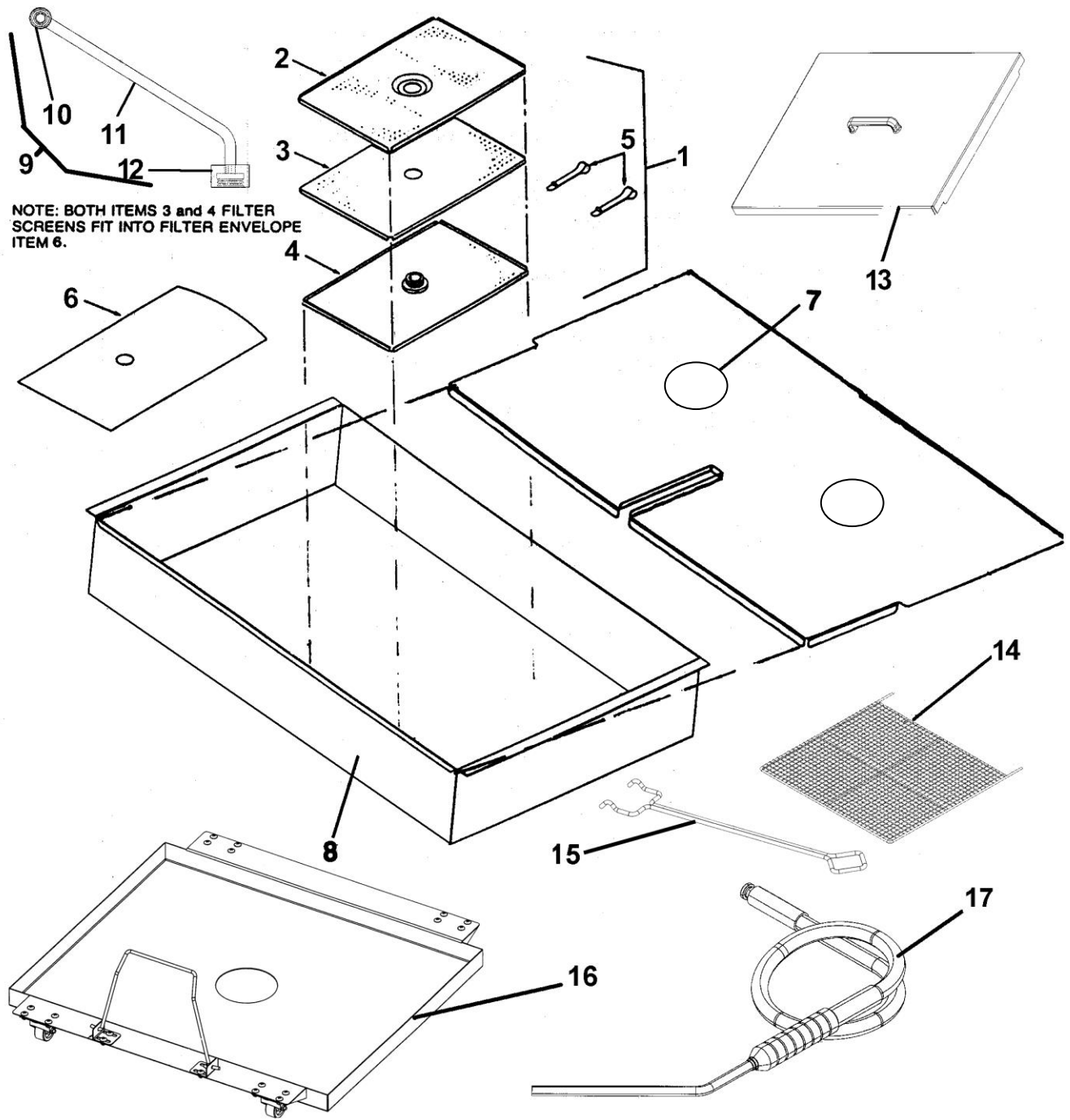

<b>Item No.</b>	<b>Part No.</b>	<b>Description</b>	<b>Qty. per Unit</b>
1	14671	Screen Assembly, Filter	1
2	65211	Crumb Catcher	1
3	use 14671	Top Filter Screen	1
4	use 14671	Bottom Filter Screen - SN: BR0502006 & below)	1
4	65447	Bottom Filter Screen - SN: BR0502007 & above)	1
5	17505	Filter Envelope Clips	2
√ 6	12102	Filter Envelope Paper (100 per Carton)	1
7	24769	Drain Pan Cover - 341-Before Jan. 1, 2006	1
7	70491	Drain Pan Cover - 341-Jan. 1, 2006 & After	1
7	24770	Drain Pan Cover - 342-Before Jan. 1, 2006	1
7	70493	Drain Pan Cover - 342-Jan. 1, 2006 & After	1
7	36223	Cover-Single Capacity Pan-342-Before Jan. 1, 2006	1
7	70587	Cover-Single Capacity Pan-342-Jan. 1, 2006 & After	1
8	24297	Drain Pan/Handle Assy. - 341-Before Jan. 1, 2006	1
8	70378	Drain Pan/Handle Assy. - 341-Jan. 1, 2006 & After	1
8	24298	Drain Pan/Handle Assy. - 342-Before Jan. 1, 2006	1
8	70245	Drain Pan/Handle Assy. - 342-Jan. 1, 2006 & After	1
8	36225	Assy.-342 Single Well Capacity Pan-Before Jan. 1, 2006	1
8	70581	Assy.-342 Single Well Capacity Pan-Jan. 1, 2006 & After	1
9	14656	Kit - Tube - Pick-up - 341-Before Jan. 1, 2006	1
9	14726	Kit-Tube-Pick-up-341-Short-Jan. 1, 2006 & After	1
9	14657	Kit - Tube - Pick-up - 342-Before Jan. 1, 2006	1
9	14727	Kit-Tube-Pick-up-342-Short-Jan. 1, 2006 & After	1
√ 10	use 69289	Union - Female Fitting	1
11	67799	Tube - Pick-up - 341-Before Jan. 1, 2006	1
11	70382	Tube - Pick-up - 341-Short-Jan. 1, 2006 & After	1
11	21044	Tube - Pick-up - 342-Before Jan. 1, 2006	1
11	70384	Tube - Pick-up - 342-Short-Jan. 1, 2006 & After	1
12	65208	Nut - Filter	1
13	03638	Cover - Frypot – Gas & Electric	1/ well
14	21039	Rack - Electric	1/ well
14	21040	Rack - Gas	1/ well
15	32794	Handle – Wire Rack Removal	1
16	03498	Filter Pan Dolly – 341 - Before Jan. 1, 2006	1
16	03551	Filter Pan Dolly – 341-Short - Jan. 1, 2006 & After	1
16	03499	Filter Pan Dolly – 342 - Before Jan. 1, 2006	1
16	03552	Filter Pan Dolly – 342-Short - Jan. 1, 2006 & After	1
17	03003	Assy - Filter Rinse Hose	1

√ recommended parts

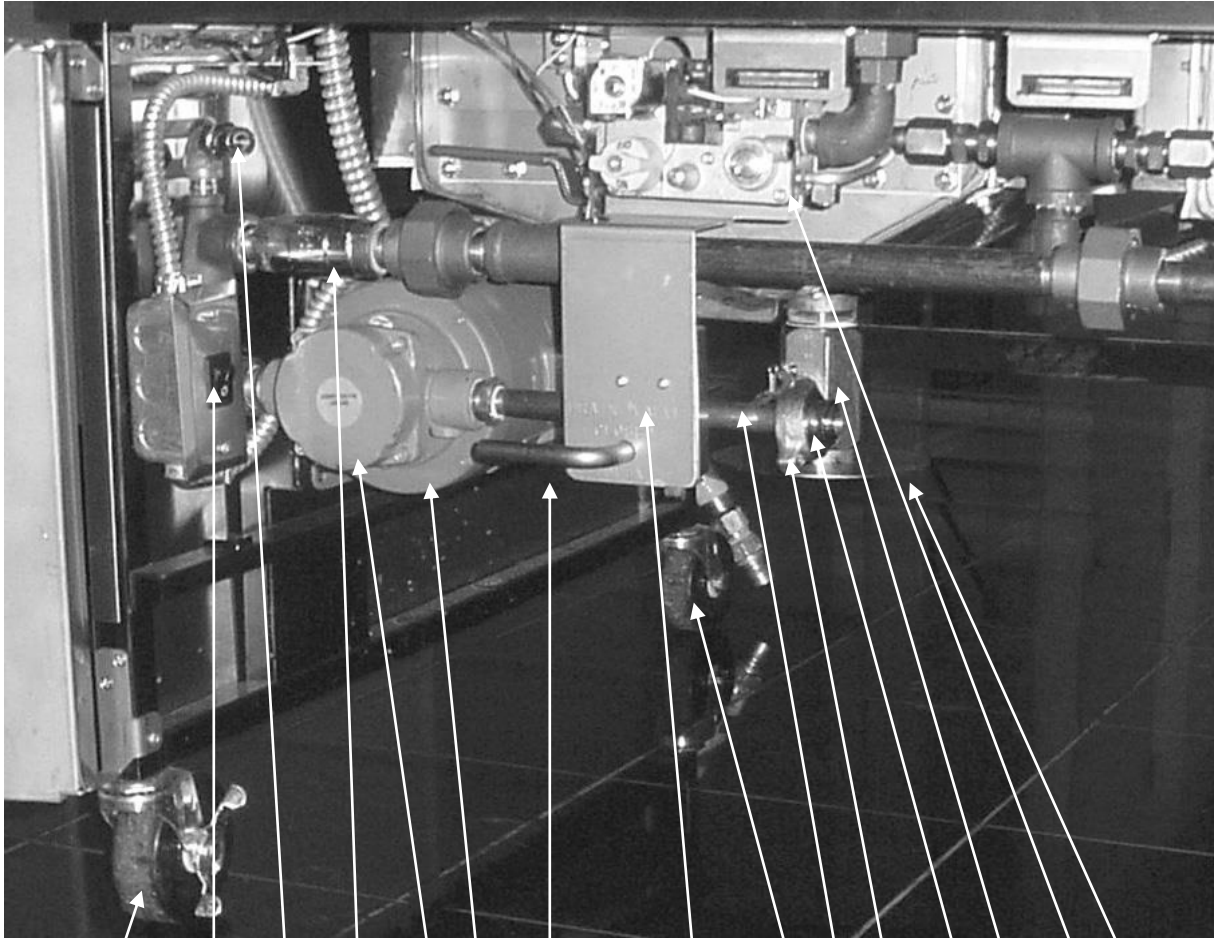

Item No.	Part No.	Description	Qty. per Unit
1	52064	Caster-4 inch – swivel w/brake	2
√ 2	43768	Switch - Power DPST 125-250V (Filter)	1
√ 2	52224	Covered Power Switch - CE	1
3	17334	Quick Disconnect – Male - 341	1
3	17333	Quick Disconnect – Female - 342	1
4	21800	Valve-3/4 inch Check	1
5	67589	Assy. - 5 GPM Pump & Motor - 4/1/06 & After	1
5	69357	Assy. - 8 GPM Pump & Motor - Before 4/1/06	1
5	64218	Filter Pump Assy. – 8 GPM - Before 4/1/06	1
5	17437	Filter Pump Assy. – 5 GPM - 4/1/06 & After	1
6	67583	Filter Pump Motor – ½ hp	1
√ *	17476	Seal Kit	1
7	21816	Rod - Drain Valve (normally closed)	1
7	66124	Rod - Drain Valve - Elec. (normally open)	1
7	68558	Rod - Drain Valve - Gas (normally open)	1
7	70963	Rod - Drain Valve - Gas (normally open) - CE	1
√ 8	18227	Microswitch – Drain (behind bracket)	1 / well
9	60312	Caster-4 inch	2
√ 10	17432(use 69289)	Union - Handle Fitting	1
11	55152	Drain Valve and Coupling Assy.	1 / well

√ recommended parts/\*not shown

(Continued)

Item No.	Part No.	Description	Qty. per Unit
√ 12	52129	Gas Valve - 24V - Nat.	1 / well
√ 12	60632	Gas Valve - 24V - Nat. - CE	1 / well
√ 12	21332	Gas Valve - 24 V - LP	1 / well
√ 12	60633	Gas Valve - 24V - LP - CE	1 / well
13	23443	Weld Assy. – Drain Extension – Elec.	1 / well
13	24420	Weld Assy. – Drain Extension – Gas	1 / well
14	17431(use 69289)	Union - Male Fitting	1
15	32734	Flexible Hose (before 4-26-04)	1
15	67621	341 Pump Tube (SN: BR0406001 & after)	1
15	67622	342 Pump Tube (SN: BR0405001)	1
15	68378	342 Pump Tube (SN: BS0406002 & after)	1
16*	14416	Kit – Nat. to LP Conversion	1 / well
16*	14417	Kit – LP to Nat. Conversion	1 / well

√ recommended parts

\*not shown

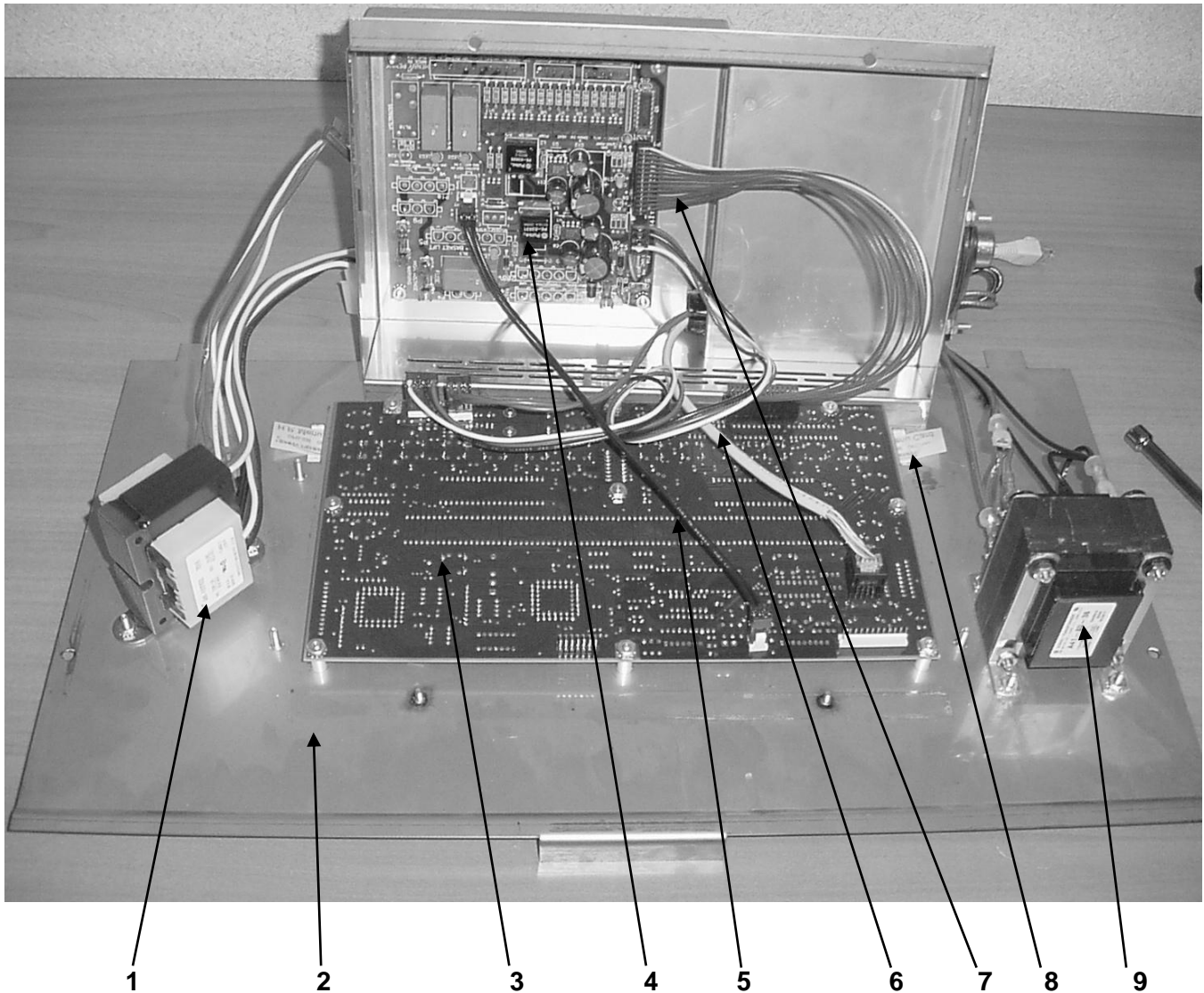

Item No.	Part No.	Description	Qty. per Well
√ 1	60207	Transformer – 120-24V	1
√ 1	60536	Transformer – 230-24V	1
√ 2	14950	C1000 Control Panel Assy	1
√ 2	74127RB	Control Panel Assy. less transformers	1
√ 3	71029RB	Control Board Assy – China	1
√ 4	58790RB	I/O Board w/Power Supply Assy.	1
5	21645	Assy -Wire-Temp Interconnect - 2 pin	1
6	60810	Power Cable - I/O to Control - 4 pin	1
7	21643	Wire Assembly - I/O to Control - 14 pin	1
8	59565	Menu Card	1
√ 9	TS22-012	Transformer-Autolift (when applicable)	1
√ recommended parts			

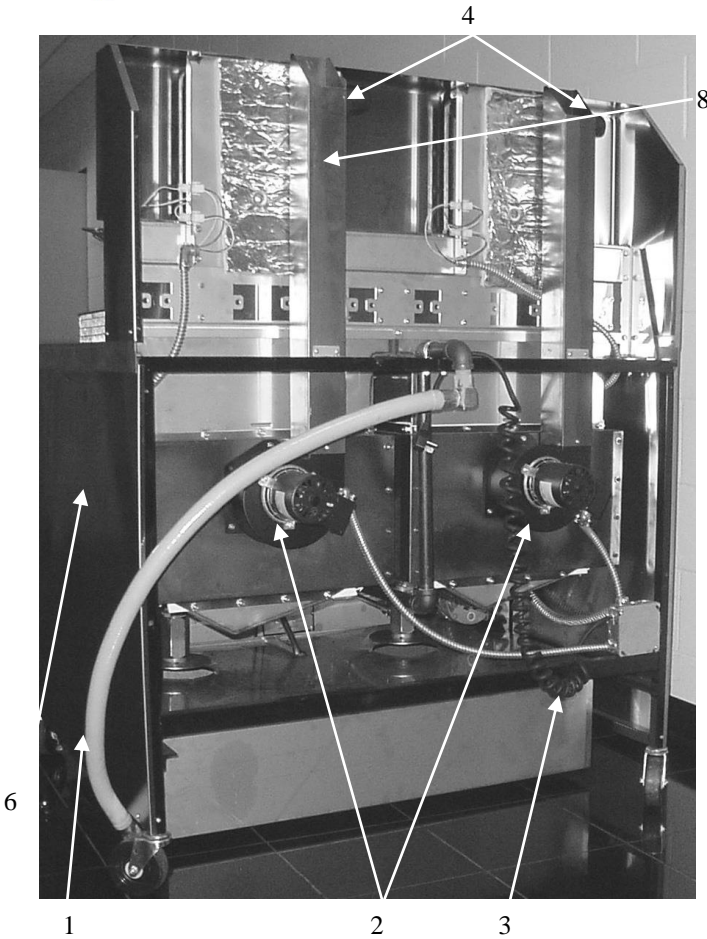

**		
NON Auto-Lift Units		
Desc.	120V-SN: before BR0912001 240V-SN: before BR1210002	120V-SN: BR0912001 & After 240V-SN: BR1210002 & After
Blower	(120V) 64197 / (240V) 21037	(120V) 14420 / (240V) 67713
Flue	69889	82533
Brace	21632	82545
Duct	23115	80545

**		
Auto Lift Units		
Desc.	120V-SN: before BR0912001 240V-SN: before BR1210002	120V-SN: BR0912001 & After 240V-SN: BR1210002 & After
Blower	(120V) 64197 / (240V) 21037	(120V) 14420 / (240V) 67713
Flue	21066	80542
Brace	21632	82545
Duct	23115	80545

Item No.	Part No.	Description	Qty. per Unit	
	1	33501	Gas Line – ¾ in. w/Double Swivel – 341	1
	1	33167	Gas Line – 1 in. w/Double Swivel – 342	1
√	2**	64197	Blower Motor Assy – 120V (before SN: BR0912001)	1 / well
√	2**	14420	Kit- Blower-120V (SN: BR0912001 & after)	1 / well
√	2**	21037	Blower Motor Assy- 220V (before SN: BR1210002)	1 / well
√	2**	14422	KIT-390/690-BLOWER-240V (SN: BR1210002 & after)	1/ well
	3	33353	120V Coiled Power Cord	1
√	4	63602	Actuator-Auto-lift (Before SN: BS/BD0812001)	2/ well
√	4	80091	Actuator-Auto-lift (SN: BS/BD0812001 & After)	2/well
	5*	21006	Panel – Left Side - before 4/27/05	1
	5*	67854	Panel – Left Side - 4/27/05 to Dec. 31, 2005	1
	5	70225	Panel – Left Side - Jan. 1, 2006 & After	1
	6	21005	Panel – Right Side - Before Jan. 1, 2006	1
	6	70226	Panel – Right Side -Jan. 1, 2006 & After	1
	7*	31421	Bearing – Auto-Lift (when applicable)	4/ well
	8**	See Chart at top of page for breakdown of flue		

√ recommended parts/\*not shown/ \*\*See chart

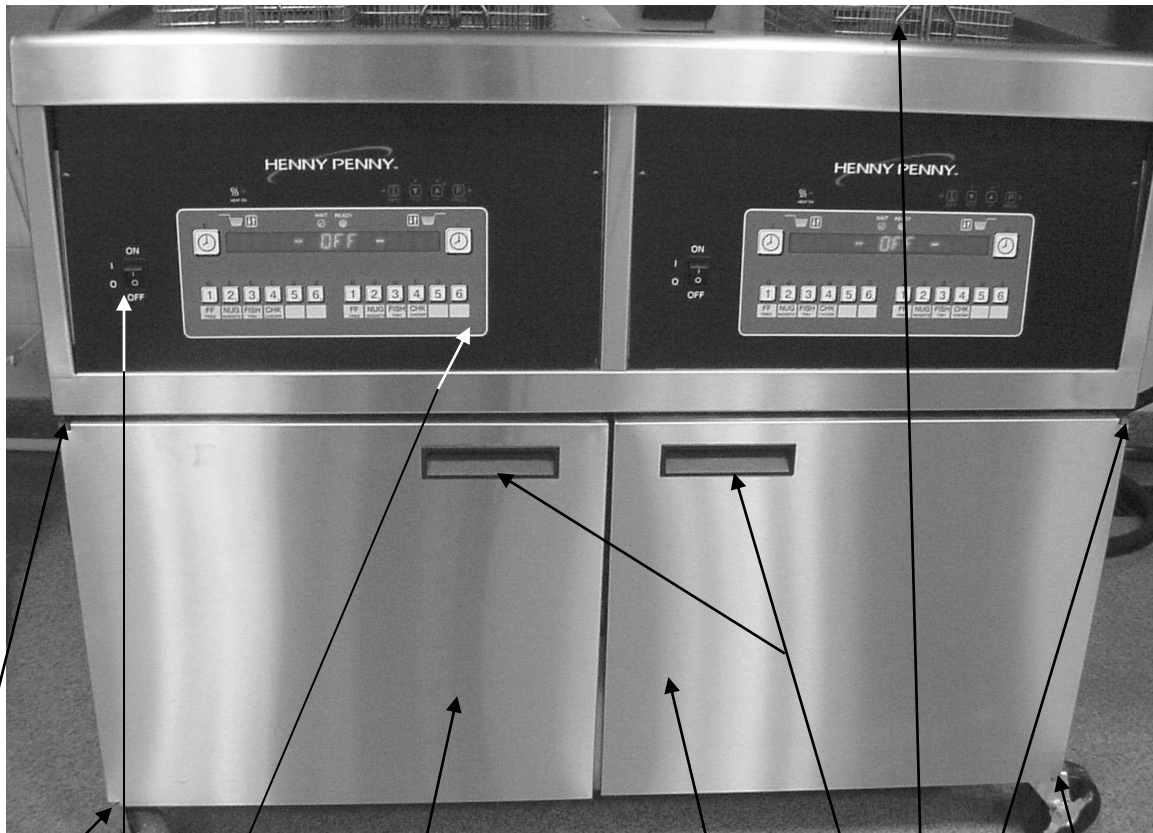

Item No.	Part No.	Description	Qty. per Well
√ 1	43768	Power Switch	1
√ 1	52224	Covered Power Switch - CE	1
2	21687	Decal - Control - 34X	1
3	21008	Door Assembly - 341- Before Jan. 1, 2006	1
3	70207	Door Assembly - 341-Jan. 1, 2006 & After	1
3	21086	Door Assembly - LH - 342 - Before Jan. 1, 2006	1 (per unit)
3	70238	Door Assembly - LH - Jan. 1, 2006 & After	1 (per unit)
4	41836	Pocket Pull	1
5	17618	Hinge Assembly - Top - LH	1
6	21034	Hinge Assembly - Bottom - LH	1
7	21426	Door Assembly - RH - 342 - Before Jan. 1, 2006	1 (per unit)
7	70240	Door Assembly - RH-342-Jan. 1, 2006 & After	1 (per unit)
4	41836	Pocket Pull	1
8	17620	Hinge Assembly - Top - RH	1
9	21433	Hinge Assembly - Bottom - RH	1
10	21036	½ Size Basket	2
10	21038	1/3 Size Basket	3
10	64211	Full Size Basket	1
10	81584	Basket, 1/2 Size, Reduced Weight	2
11*	23850	Skimmer - Square Mesh	1
12*	14784	Kit – Joining (Non-Auto-Lift fryers only!)	1

√ recommended parts/\*not shown  
410



Item No.	Part No.	Description	Qty. per Well
√ 1	64210-01	Element – OFE34X – 208V	2
√ 1	64210-02	Element – OFE34X – 220V	2
√ 1	64210-03	Element – OFE34X – 230V	2
√ 1	64210-04	Element – OFE34X – 240V	2
√ 1	64210-07	Element – OFE34X – 480V	2
2	24194	Spreader - Front - 34X	1
3	21978	Strap - Spreader - 34X	10
4	24176	Weldment - Spreader - 34X	2
5	23929	Strap - Vertical - Rear	1
6	23928	Strap - Brace Vertical - Rear	1
7	23507	Strap - Capillary Tube	2
8	23854	Guard - Position Hi Limit	1
9*	24236	Weldment-Element Hook (Before 4-1-06)	1 per unit
9*	71252	Weldment- Element Hook (After 4-1-06)	1 per unit

√ recommended parts/ \*not shown

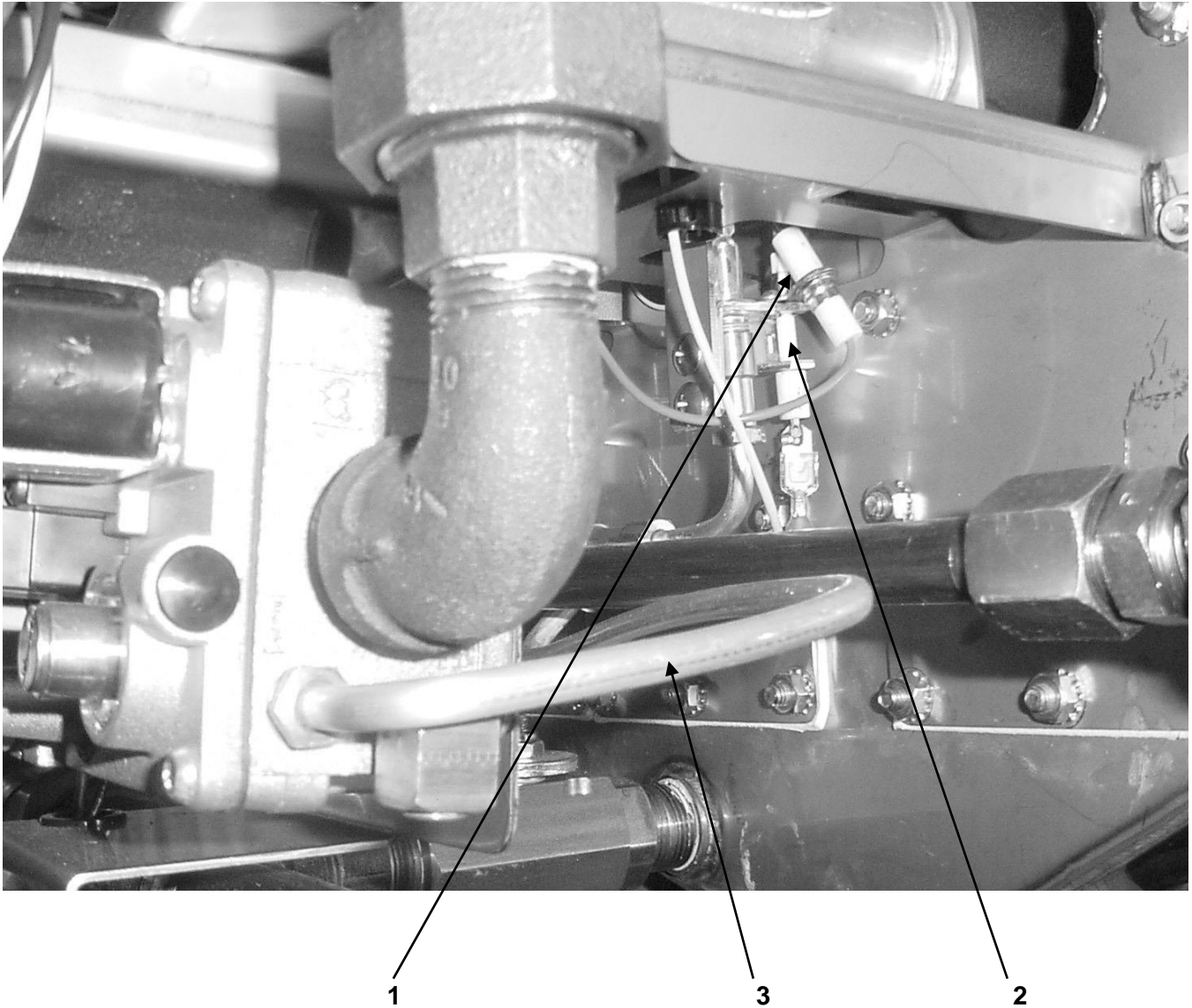

Item No.	Part No.	Description	Qty. per Well
√ 1	60266	Pilot - Tee Style & Ignitor Assy.	1
	23735	Orifice - Pilot - Nat.	1
	60614	Orifice - Pilot - LP	1
√ 2	60292	Sensor - Flame - Pilot	1
3	21827	Tube - Pilot	1
3	67817	Tube - Pilot - CE	1

√ recommended parts

**Electric Components**

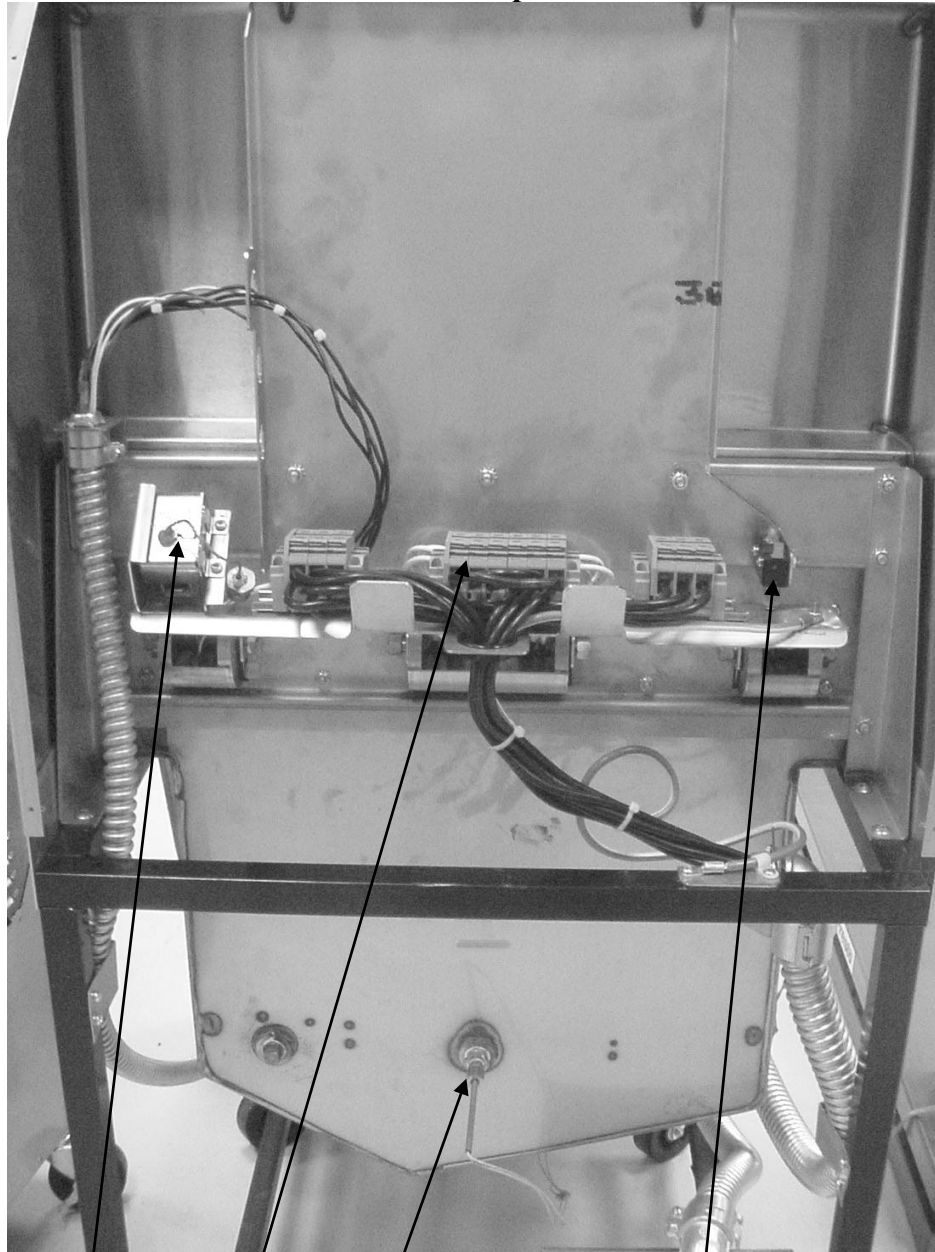

Item No.	Part No.	Description	Qty. per Well
√ 1	60241	High Limit - 425° F	1
2	23823	Assy-Heater Terminal Block	1
√ 3	14973	Temperature Probe Assembly	1
√ 4	18227	Microswitch	1
√ 5*	32497	EMC Filter Board - CE	1
√ 6*	32498	Assy - 4 Inch Terminal Block	1

√ recommended parts/\*not shown

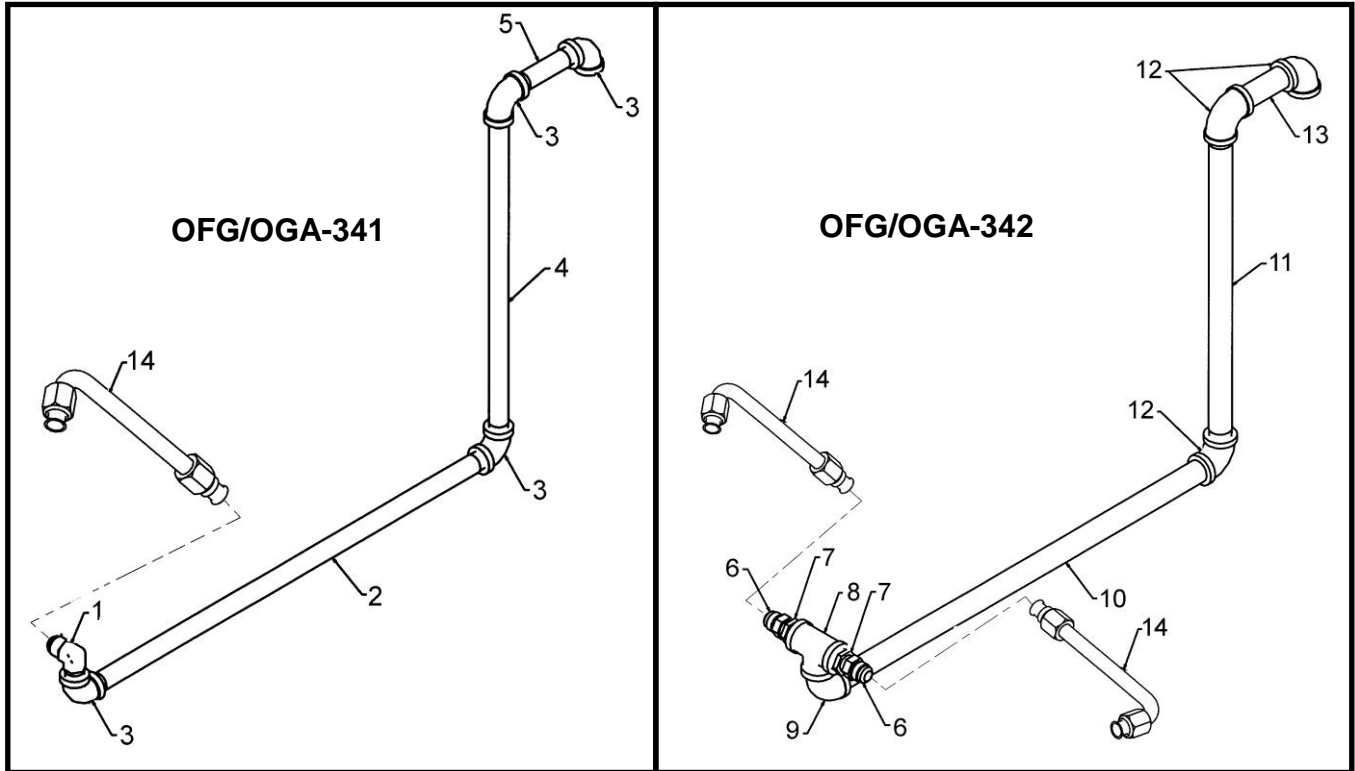

Item No.	Part No.	Description	Qty. per Unit
1	16336	Elbow – Male	1
2	FP02-050	Nipple – ½ x 24 LG BI	1
3	FP01-090	Elbow – ½ NPT x 90 Female - BI	4
4	FP02-051	Nipple – ½ x 17 LG BI	1
5	FP02-052	Nipple – ½ x 4 LG BI	1
6	16335	Male Connector – 37 Flare	2
7	FP01-089	Bushing – Reducing – ¾M to 1/2F BL	2
8	FP01-097	Tee – ¾ NPT – Female Pipe – BI	1
9	FP01-100	Elbow – Street – ¾ NPT BI	1
10	FP02-040	Nipple – ¾ x 24 LG BI	1
11	FP02-032	Nipple – ¾ x 17 LG BI	1
12	FP01-098	Elbow – ¾ NPT x 90 Female - BI	3
13	FP02-023	Pipe – ¾ NPT x 19-1/4 LG BI	1
14	21801	Tube Assy – Valve Inlet – 34X	341- 1 342- 2
15*	FP01-200	Fitting – Gas Inlet BSPT	1

\*not shown

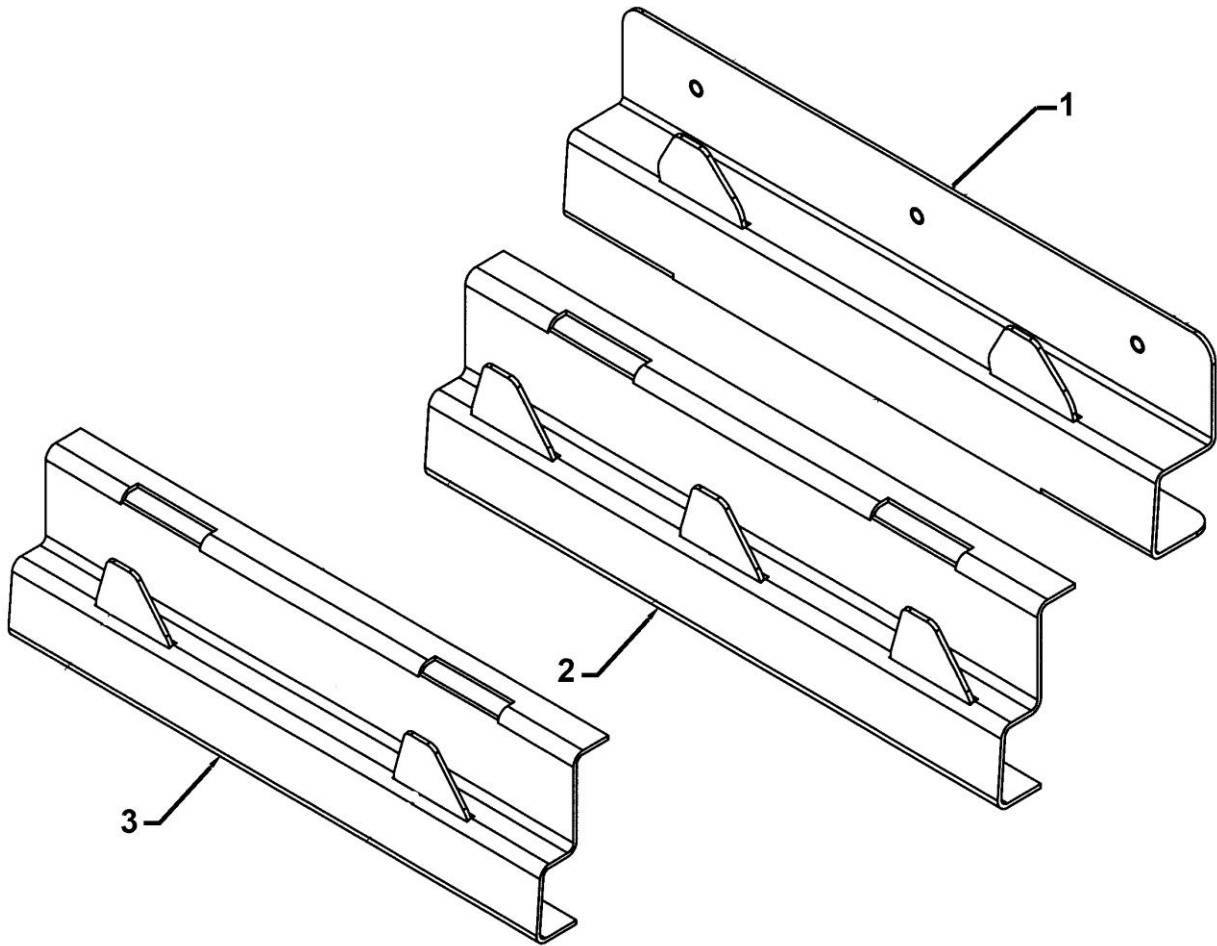

Item No.	Part No.	Description	Qty. per Well
1	24809	Hook – Basket Hanger – ½-Size (before 06/01/05)	1
1	70102	Hook – Basket Hanger – ½-Size (06/01/05 & after)	1
2	36030	Bracket – 1/3-Size Basket	1
3	38912	Bracket – 1/2-Size Basket (before 06/01/05)	1

**OFG/OFE ELECTRO MECHANICAL PARTS LIST**

<b><u>PART NUMBER</u></b>	<b><u>DESCRIPTION</u></b>
√ 60816	Adjustable Relay Base
√ 60817	Adjustable Time Delay Relay
√ 60818	24VAC Coil Relay
√ 60765	24V Dual Face Timer
√ 14851	Thermostat Kit
60814	E/M Bulb Mounting Clip (Gas)
√ 35916	Transformer 120V to 24V (Gas)
√ 60536	Transformer 24V/230V (Electric)
√ 60792	Indicator Light – 24 V
√ 51795	24v Mechanical Contactor (Elec. Only)
√ 65098	Assy. - Heat Contactor – 24V - CE
√ 65567	Assy. – Timer Buzzer Coil-24V
36224	Decal – E/M Controls – 34X

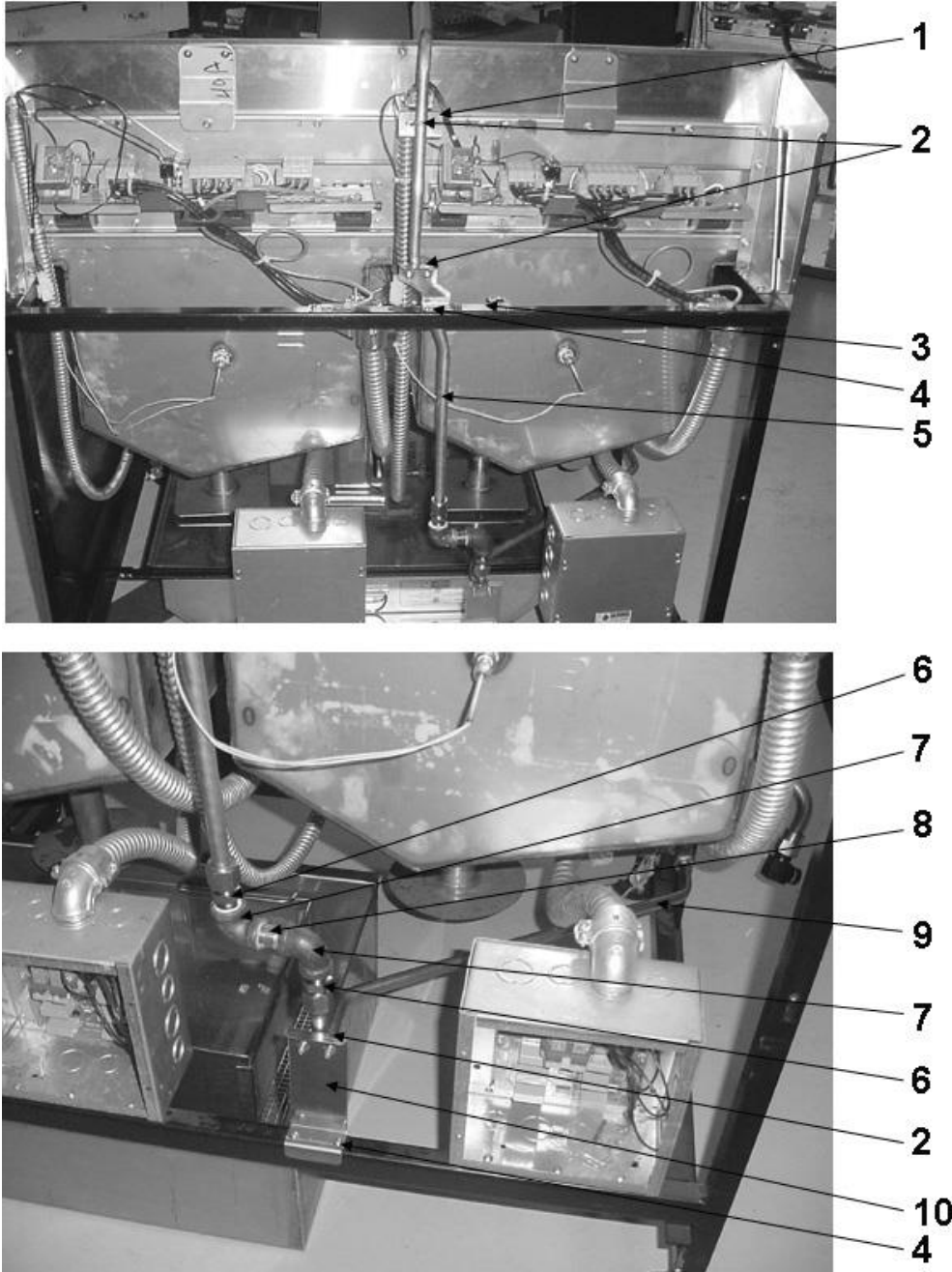

**OVER-THE-TOP PUMBING W/O D.C. PARTS (March 1, 2006 & After)**

Item No.	Part No.	Description	Qty.
1	73370	HANGER-ACTUATOR CONDUIT	1
2	SC06-013	U BOLT 1/4-20 FOR 3/4 DIA	3
3	71185	BRACKET-TUBE	1
4	SC03-001	SCREW #10 X 1/2 PH PHD TEK 2 C	4
5	71139	ASSY-TUBE RETURN LINE	1
6	16807	FITTING CONNECTOR MALE	2
7	FP01-090	ELBOW-1/2NPT X 90 FEMALE BI	2
8	FP02-018	NIPPLE-1/2 NPT X 2.00L BI	1
9	71063	ASSY-PUMP RETURN TUBE	1
10	71142	BRACKET-TUBE REAR SUPPORT	1



**OVER-THE-TOP FAUCET ASSY. (March 1, 2006 & After)**

Item No.	Part No.	Description	Qty.
1	71899	ASSY. – 341 FAUCET	1
--Dimensions: approximately 16.184"			
	17333	FEMALE DISCONNECT	1
1	71665	ASSY. – 342 FAUCET	1
--Dimensions: approximately 8"			
	17334	MALE DISCONNECT	1
2	71830	HANDLE – DIVERTER VALVE (Direct-Connect units)	1
3*	03621	ASSY-90' FEMALE FILTER HOSE	A/R

**341 DIRECT-CONNECT PARTS LIST (Before March 1, 2006)**

<b>Part No.</b>	<b>Description</b>	<b>Qty.</b>
16282	NIPPLE 3/4 X CLOSE	1
21611	DISCONNECT-MALE	1
21612	DISCONNECT-FEMALE	1
21753	HOSE-SHORTENING DISCARD	1
21800	VALVE-3/4 CHECK	1
23430	VALVE-3/4 INLET-E34X	1
67850	BRACKET-34X D/C REAR SUPPORT	1
FP01-140	PLUG-3/4 PIPE-BI	2
FP01-142	CROSS-3/4 NPT BI	1
FP02-039	NIPPLE-3/4 X 6 LG-BI	1
FP02-059	NIPPLE-3/4 X 27 LG-BI	1
SC03-001	SCREW #10 X 1/2 PH PHD TEK 2 C	2

**342 DIRECT-CONNECT PARTS LIST (Before March 1, 2006)**

<b>Part No.</b>	<b>Description</b>	<b>Qty.</b>
16282	NIPPLE 3/4 X CLOSE	1
21611	DISCONNECT-MALE	1
21612	DISCONNECT-FEMALE	1
21753	HOSE-SHORTENING DISCARD	1
21800	VALVE-3/4 CHECK	1
67850	BRACKET-34X D/C REAR SUPPORT	1
FP02-059	NIPPLE-3/4 X 27 LG-BI	1
SC03-001	SCREW #10 X 1/2 PH PHD TEK 2 C	2
FP01-140	PLUG-3/4 PIPE-BI	1
FP02-033	NIPPLE-3/4 NPT X 4 IN LONG BI	1
FP02-039	NIPPLE-3/4 X 6 LG-BI	1

**341 W/DIRECT-CONNECT PARTS LIST (March 1, 2006 & After)**

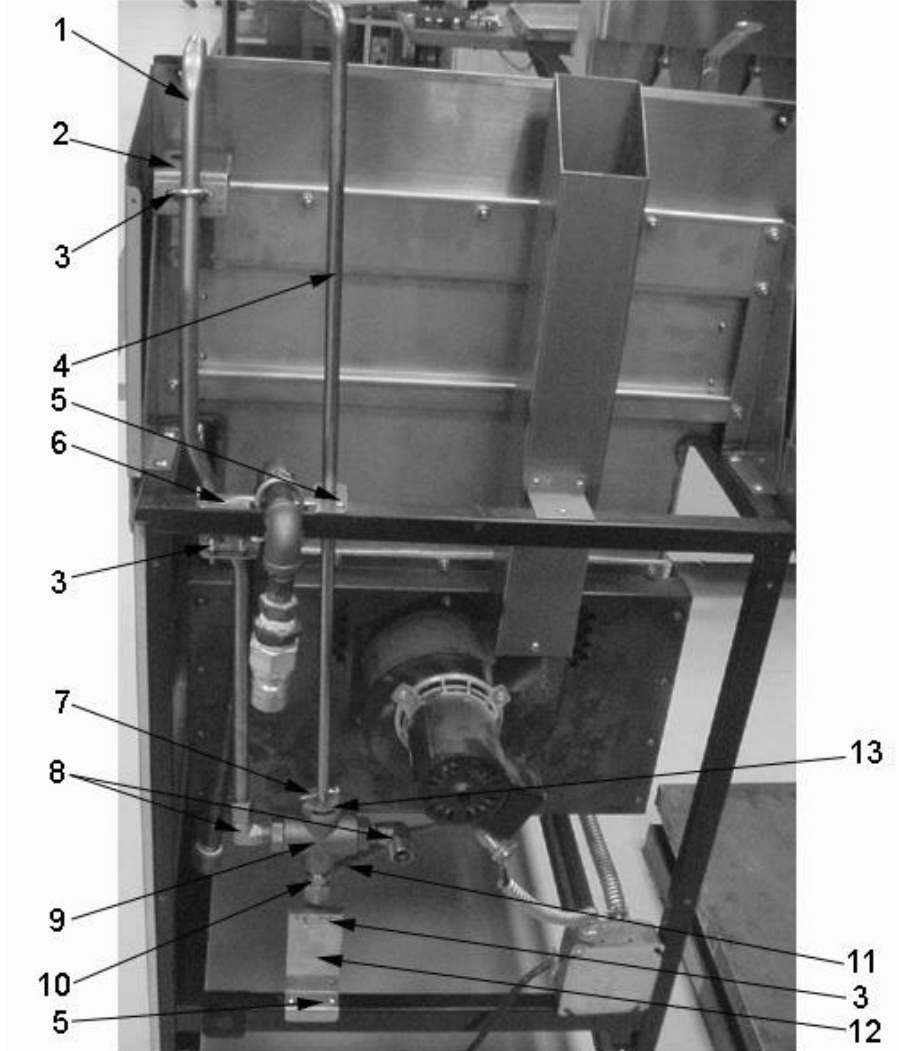

Item No.	Part No.	Description	Qty.
1	71139	ASSY-TUBE RETURN LINE	1
2	73370	HANGER-ACTUATOR CONDUIT	1
3	SC06-013	U BOLT 1/4-20 FOR 3/4 DIA	3
4	71070	ROD - EXTENSION FILTER VALVE	1
5	SC03-001	SCREW #10 X 1/2 PH PHD TEK 2 C	4
6	71185	BRACKET-TUBE	1
7	17255	COTTER PIN	1
8	17407	CONNECTOR - 1/2 MALE ELBOW	2
9	21613	VALVE - DIVERTER	1
10	16807	FITTING CONNECTOR MALE	1
11	71063	ASSY - PUMP RETURN TUBE	1
12	71142	BRACKET-TUBE REAR SUPPORT	1
13	67492	STOP - D/C EXTENSION ROD	1

**341 AUTO-LIFT W/DIRECT-CONNECT PARTS LIST (March 1, 2006 & After)**

<b>Part No.</b>	<b>Description</b>	<b>Qty.</b>
16807	FITTING CONNECTOR MALE	3
17255	PIN-COTTER	1
19811	1/2" 90 STRT ELL,S.S.	1
21613	VALVE-DIVERTER	1
21800	VALVE-3/4 CHECK	1
67492	STOP-D/C EXTENSION ROD	1
71063	ASSY-PUMP RETURN TUBE	1
71142	BRACKET-TUBE REAR SUPPORT	1
71185	BRACKET-TUBE	1
71652	ASSY-TUBE RETURN LINE A/LIFT	1
71653	ASSY-DIV TUBE RS A/LIFT	1
71830	HANDLE-DIVERTER VALVE	1
71921	ROD-EXTENSION A/LIFT FLTR V	1
FP01-018	1/2 STR PIPE COUPLING CONDUIT	1
FP01-029	REDUCER 1/2NPT M-3/8NPT F SS*S	1
FP01-089	BUSHNG-REDUCNG 3/4M TO 1/2F BL	1
FP01-090	ELBOW-1/2NPT X 90 FEMALE BI	1
FP02-018	NIPPLE-1/2 NPT X 2.00L BI	2
SC01-209	#10-32 X3/8 PH THD SS	2
SC03-001	SCREW #10 X 1/2 PH PHD TEK 2 C	4
SC06-013	U BOLT 1/4-20 FOR 3/4 DIA	2
17333	RINSE HOSE DISCONNECT FEMALE	1
17334	RINSE HOSE DISCONNECT MALE	1
FP02-001	NIPPLE 3/8 CLOSE	1
60610	RETURN LINE - UPPER	1
71462	WELD ASSY-TUBE COUPLING PLATE	1

**341 AUTO-LIFT W/O DIRECT-CONNECT PARTS LIST (March 1, 2006 & After)**

<b>Part No.</b>	<b>Description</b>	<b>Qty.</b>
71185	BRACKET-TUBE	1
71652	ASSY-TUBE RETURN LINE A/LIFT	1
71653	ASSY-DIV TUBE RS A/LIFT	1
FP01-018	1/2 STR PIPE COUPLING CONDUIT	1
FP01-029	REDUCER 1/2NPT M-3/8NPT F SS	1
FP01-090	ELBOW-1/2NPT X 90 FEMALE BI	3
FP02-018	NIPPLE-1/2 NPT X 2.00L BI	1
SC03-001	SCREW #10 X 1/2 PH PHD TEK 2 C	4
SC06-013	U BOLT 1/4-20 FOR 3/4 DIA	2
17333	RINSE HOSE DISCONNECT FEMALE	1
17334	RINSE HOSE DISCONNECT MALE	1
FP02-001	NIPPLE 3/8 CLOSE	1
60610	RETURN LINE - UPPER	1
71462	WELD ASSY-TUBE COUPLING PLATE	1

**342 AUTO-LIFT W/DIRECT-CONNECT PARTS LIST (March 1, 2006 & After)**

<b>Part No.</b>	<b>Description</b>	<b>Qty.</b>
16807	FITTING CONNECTOR MALE	4
17255	PIN-COTTER	2
17407	CONNECTOR 1/2 MALE ELBOW	3
19811	1/2" 90 STRT ELL,S.S.	1
21613	VALVE-DIVERTER	2
21800	VALVE-3/4 CHECK	1
67492	STOP-D/C EXTENSION ROD	2
71063	ASSY-PUMP RETURN TUBE	1
71142	BRACKET-TUBE REAR SUPPORT	1
71185	BRACKET-TUBE	1
71652	ASSY-TUBE RETURN LINE A/LIFT	1
71653	ASSY- DIV TUBE RS A/LIFT	1
71670	TUBE-LINE OIL RETURN	1
71740	ASSY-DIV TUBE LS A/LIFT	1
71777	LABEL-OIL RETURN 34X	1
71790	ROD-EXTENSION DIVERTER	1
71830	HANDLE-DIVERTER VALVE	1
71921	ROD-EXTENSION A/LIFT FLTR V	1
FP01-018	1/2 STR PIPE COUPLING CONDUIT	2
FP01-089	BUSHNG-REDUCNG 3/4M TO 1/2F BL	1
FP01-090	ELBOW-1/2NPT X 90 FEMALE BI	1
FP02-018	NIPPLE-1/2 NPT X 2.00L BI	2
SC01-209	#10-32 X3/8 PH THD SS	2
SC03-001	SCREW #10 X 1/2 PH PHD TEK 2 C	4
SC06-013	U BOLT 1/4-20 FOR 3/4 DIA	2
17333	RINSE HOSE DISCONNECT FEMALE	1
17334	RINSE HOSE DISCONNECT MALE	1
FP02-001	NIPPLE 3/8 CLOSE	2
60610	RETURN LINE - UPPER	1
71462	WELD ASSY-TUBE COUPLING PLATE	2
73188	ASSY-DIV TUBE A/LIFT - GAS	2

**342 AUTO-LIFT W/O DIRECT-CONNECT PARTS LIST (March 1, 2006 & After)**

<b>Part No.</b>	<b>Description</b>	<b>Qty.</b>
16807	FITTING CONNECTOR MALE	4
17255	PIN-COTTER	1
17407	CONNECTOR 1/2 MALE ELBOW	1
21613	VALVE-DIVERTER	1
71063	ASSY-PUMP RETURN TUBE	1
71142	BRACKET-TUBE REAR SUPPORT	1
71185	BRACKET-TUBE	1
71652	ASSY-TUBE RETURN LINE A/LIFT	1
71670	TUBE-LINE OIL RETURN	1
71740	ASSY-DIV TUBE LS A/LIFT	1
71777	LABEL-OIL RETURN 34X	1
71790	ROD-EXTENSION DIVERTER	1
FP01-018	1/2 STR PIPE COUPLING CONDUIT	2
FP01-090	ELBOW-1/2NPT X 90 FEMALE BI	1
FP02-018	NIPPLE-1/2 NPT X 2.00L BI	2
SC03-001	SCREW #10 X 1/2 PH PHD TEK 2 C	4
SC06-013	U BOLT 1/4-20 FOR 3/4 DIA	2
17333	RINSE HOSE DISCONNECT FEMALE	1
17334	RINSE HOSE DISCONNECT MALE	1
FP02-001	NIPPLE 3/8 CLOSE	2
60610	RETURN LINE - UPPER	1
71462	WELD ASSY-TUBE COUPLING PLATE	2
73188	ASSY-DIV TUBE A/LIFT - GAS	2