

Parts & Accessories Diagram

PROPRIETARY RIGHTS NOTICE This document and all information contained within it is the property of Hamilton Beach Brands, Inc. (HBB). It is confidential and proprietary and has been provided to you for a limited purpose. It must be returned or destroyed upon request. Disclosure, reproduction or use of this document and any information contained within it, in full or in part, for any purpose is forbidden without the prior written consent of HBB. No photographs may be taken of any article fabricated or assembled from this document without the prior written consent of HBB.

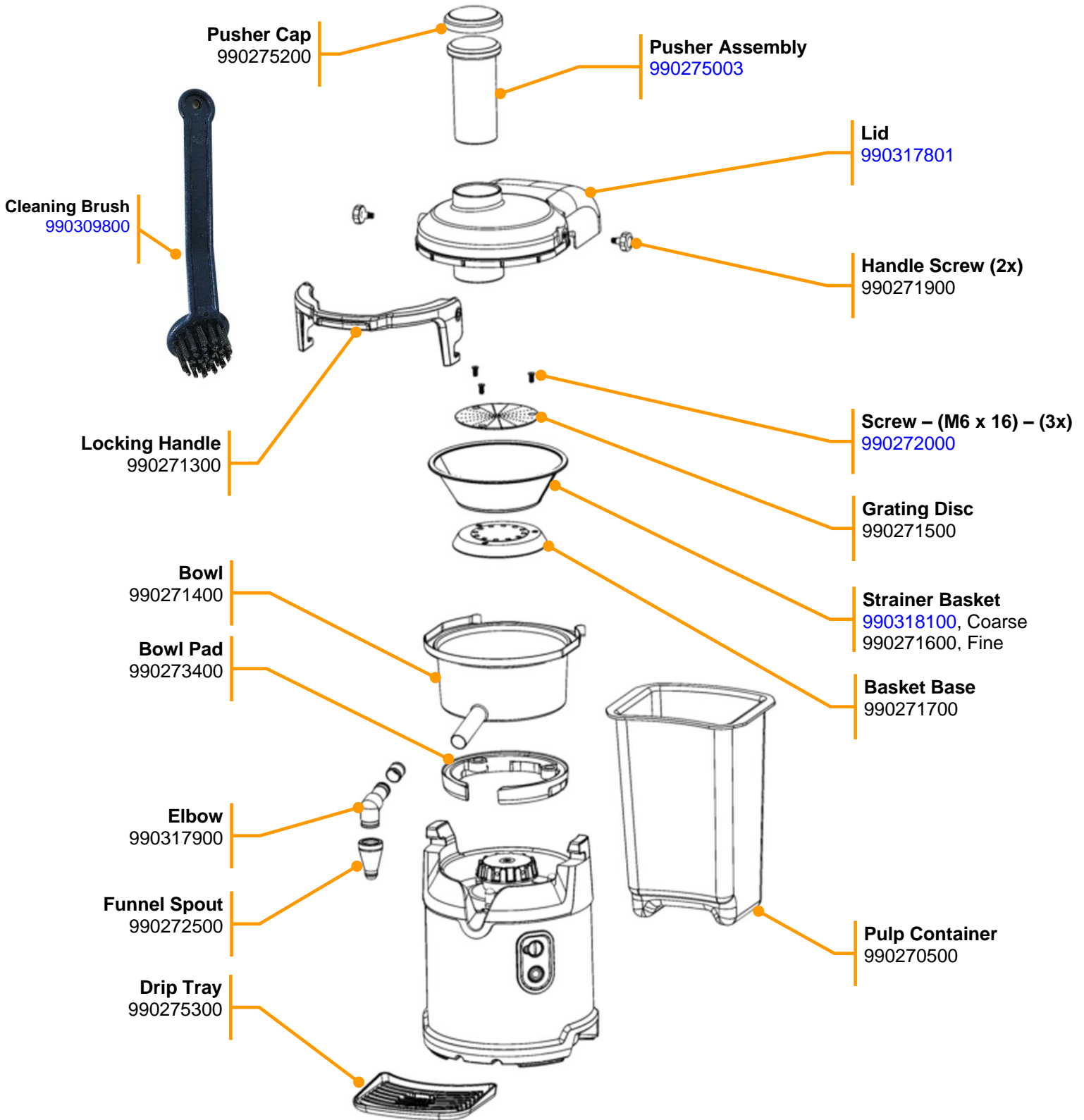

<p>Hamilton Beach 4421 Waterfront Drive Glen Allen, VA 23060</p>	Revision Description:	Add SB960 and SB961 images and call outs to PAD.				Rev. Date:
	Request #:	DOC11607	Page:	1 of 17	Document #:	540095500
						Rev: H

Parts & Accessories Diagram

PROPRIETARY RIGHTS NOTICE This document and all information contained within it is the property of Hamilton Beach Brands, Inc. (HBB). It is confidential and proprietary and has been provided to you for a limited purpose. It must be returned or destroyed upon request. Disclosure, reproduction or use of this document and any information contained within it, in full or in part, for any purpose is forbidden without the prior written consent of HBB. No photographs may be taken of any article fabricated or assembled from this document without the prior written consent of HBB.

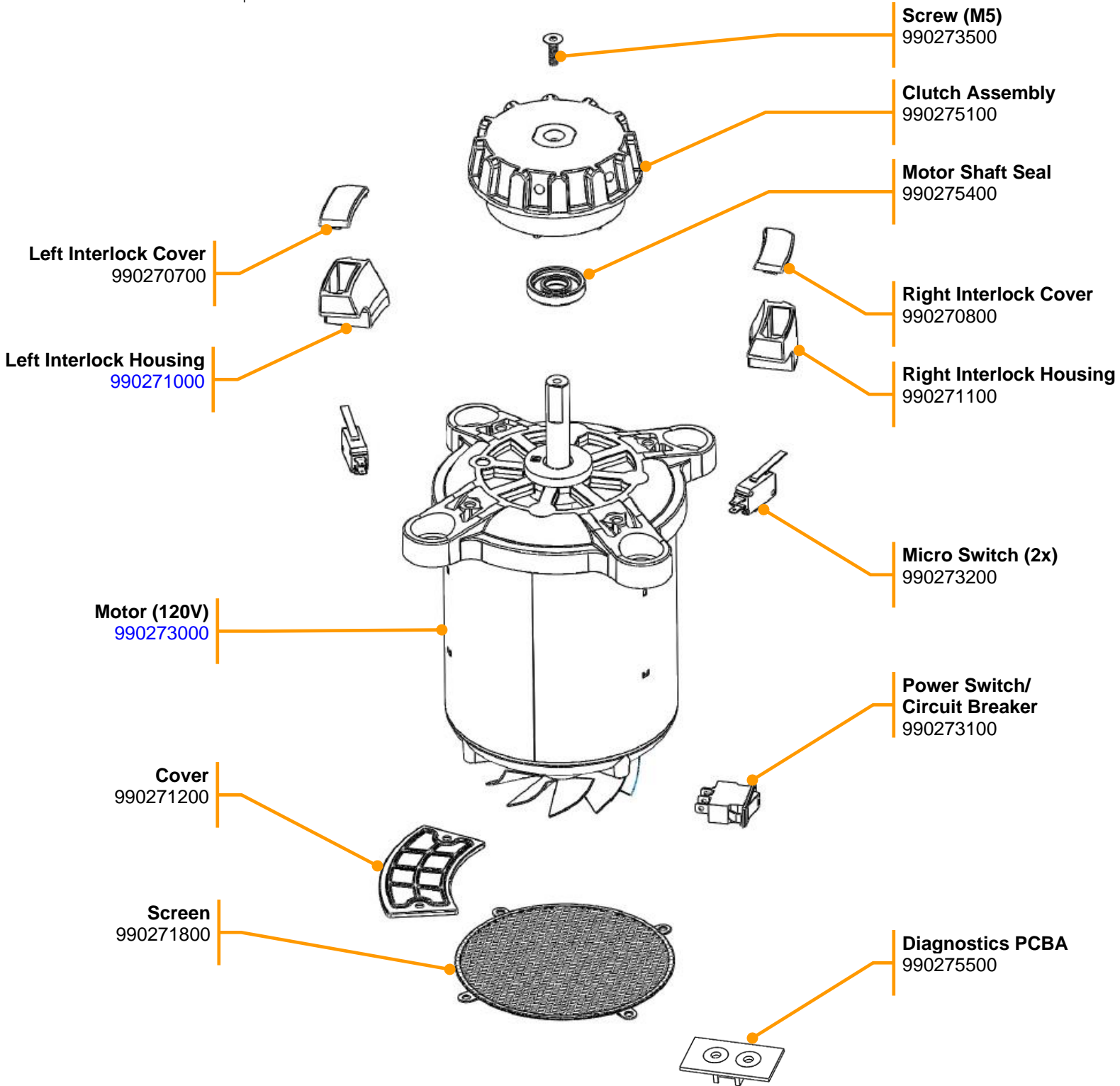



	Revision Description:	Add SB960 and SB961 images and call outs to PAD.				Rev. Date:
	Request #:	DOC11607	Page:	2 of 17	Document #:	540095500
						Rev: H

Parts & Accessories Diagram

PROPRIETARY RIGHTS NOTICE This document and all information contained within it is the property of Hamilton Beach Brands, Inc. (HBB). It is confidential and proprietary and has been provided to you for a limited purpose. It must be returned or destroyed upon request. Disclosure, reproduction or use of this document and any information contained within it, in full or in part, for any purpose is forbidden without the prior written consent of HBB. No photographs may be taken of any article fabricated or assembled from this document without the prior written consent of HBB.

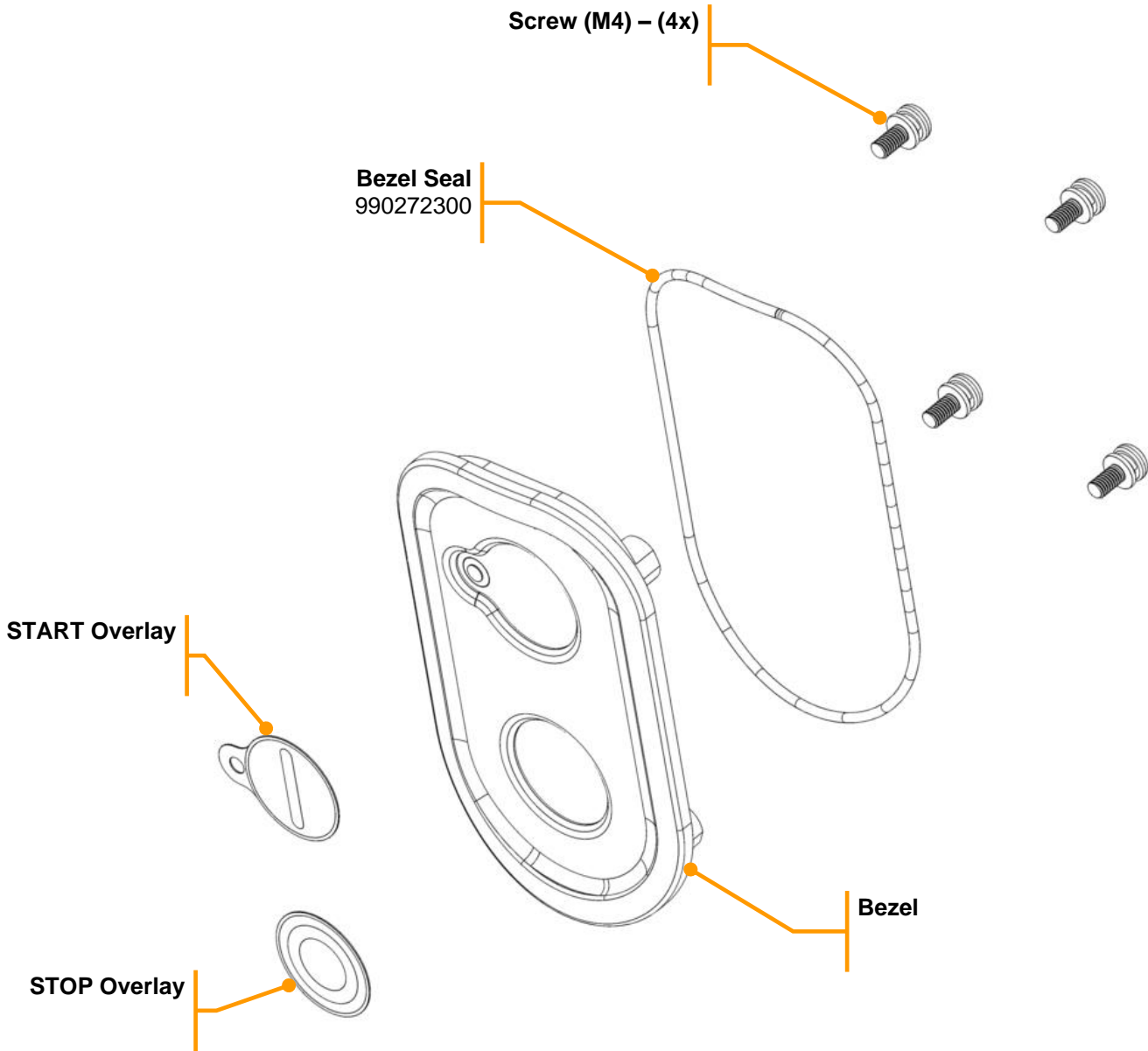
990273700 Bezel Service Kit – Includes all components as pictured below





 4421 Waterfront Drive Glen Allen, VA 23060	Revision	Add SB960 and SB961 images and call outs to PAD.				Rev. Date:	
	Description:					04/02/21	
Request #:	DOC11607	Page:	3 of 17	Document #:	540095500	Rev:	H

Parts & Accessories Diagram

PROPRIETARY RIGHTS NOTICE This document and all information contained within it is the property of Hamilton Beach Brands, Inc. (HBB). It is confidential and proprietary and has been provided to you for a limited purpose. It must be returned or destroyed upon request. Disclosure, reproduction or use of this document and any information contained within it, in full or in part, for any purpose is forbidden without the prior written consent of HBB. No photographs may be taken of any article fabricated or assembled from this document without the prior written consent of HBB.

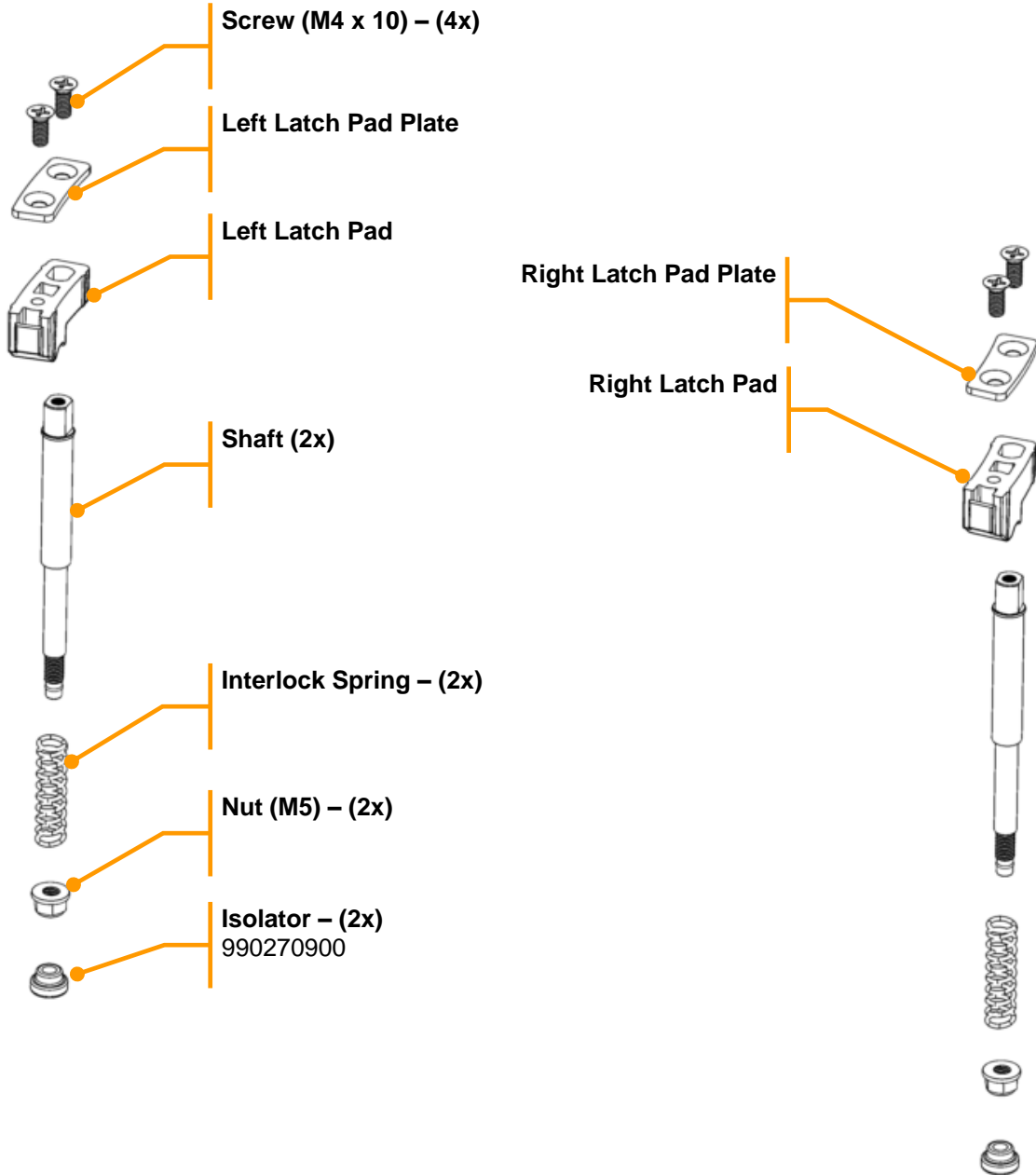
990273800 Latch Service Kit – Includes all components as pictured below





 <p>Hamilton Beach 4421 Waterfront Drive Glen Allen, VA 23060</p>	Revision	Add SB960 and SB961 images and call outs to PAD.				Rev. Date:	
	Description:					04/02/21	
Request #:	DOC11607	Page:	4 of 17	Document #:	540095500	Rev:	H

Parts & Accessories Diagram

PROPRIETARY RIGHTS NOTICE This document and all information contained within it is the property of Hamilton Beach Brands, Inc. (HBB). It is confidential and proprietary and has been provided to you for a limited purpose. It must be returned or destroyed upon request. Disclosure, reproduction or use of this document and any information contained within it, in full or in part, for any purpose is forbidden without the prior written consent of HBB. No photographs may be taken of any article fabricated or assembled from this document without the prior written consent of HBB.

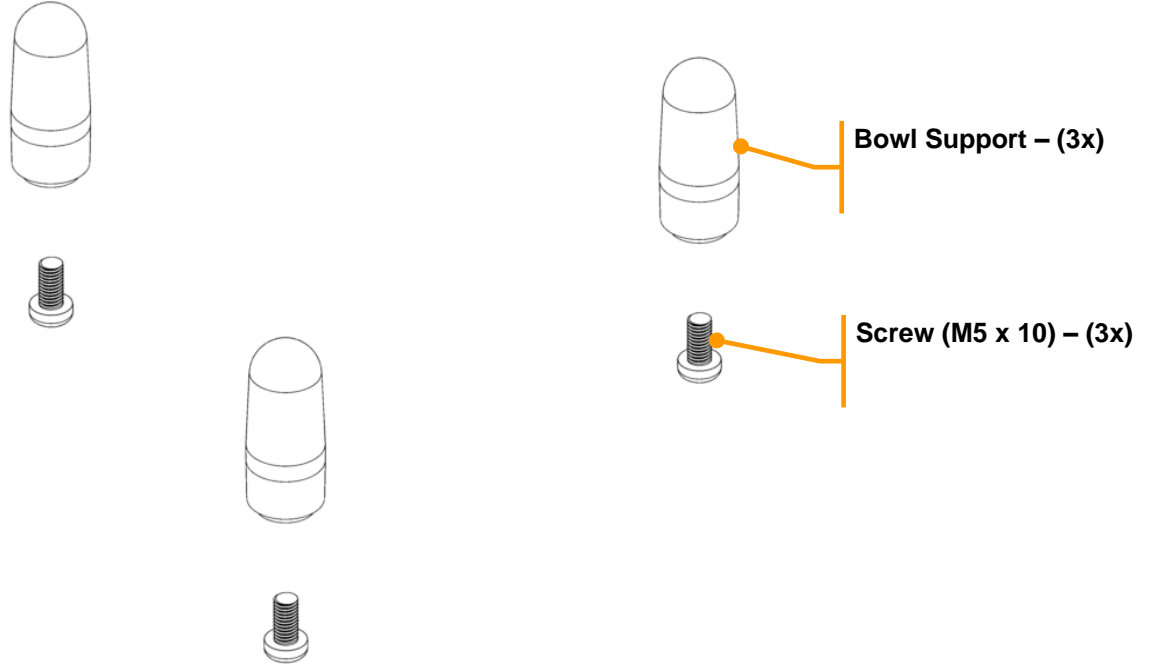
990273900 Bowl Support Service Kit – Includes all components as pictured below





 4421 Waterfront Drive Glen Allen, VA 23060	Revision	Add SB960 and SB961 images and call outs to PAD.				Rev. Date:	
	Description:					04/02/21	
Request #:	DOC11607	Page:	5 of 17	Document #:	540095500	Rev:	H

Parts & Accessories Diagram

PROPRIETARY RIGHTS NOTICE This document and all information contained within it is the property of Hamilton Beach Brands, Inc. (HBB). It is confidential and proprietary and has been provided to you for a limited purpose. It must be returned or destroyed upon request. Disclosure, reproduction or use of this document and any information contained within it, in full or in part, for any purpose is forbidden without the prior written consent of HBB. No photographs may be taken of any article fabricated or assembled from this document without the prior written consent of HBB.

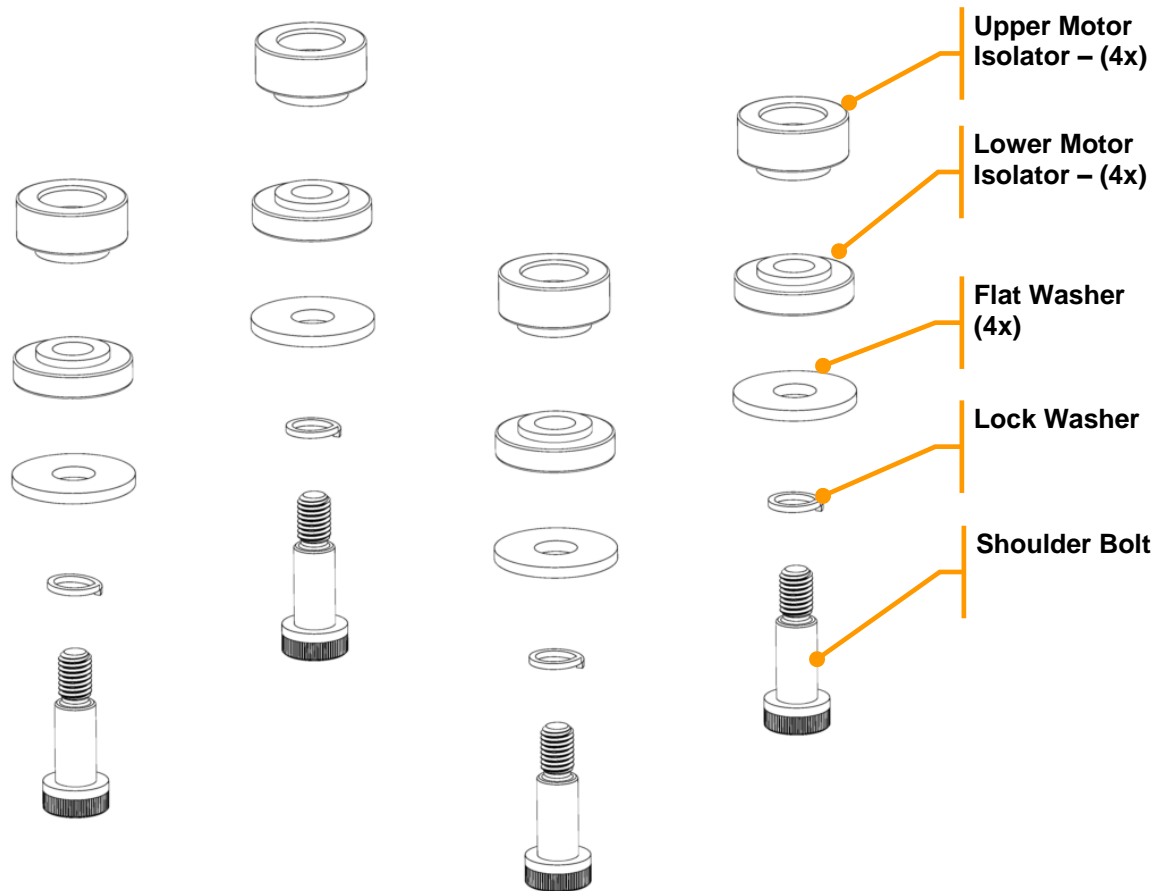
990274000 Motor Hardware Kit – Includes all components as pictured below





 <p>Hamilton Beach 4421 Waterfront Drive Glen Allen, VA 23060</p>	Revision	Add SB960 and SB961 images and call outs to PAD.				Rev. Date:	
	Description:					Rev. Date:	
Request #:	DOC11607	Page:	6 of 17	Document #:	540095500	Rev:	H

Parts & Accessories Diagram

PROPRIETARY RIGHTS NOTICE This document and all information contained within it is the property of Hamilton Beach Brands, Inc. (HBB). It is confidential and proprietary and has been provided to you for a limited purpose. It must be returned or destroyed upon request. Disclosure, reproduction or use of this document and any information contained within it, in full or in part, for any purpose is forbidden without the prior written consent of HBB. No photographs may be taken of any article fabricated or assembled from this document without the prior written consent of HBB.

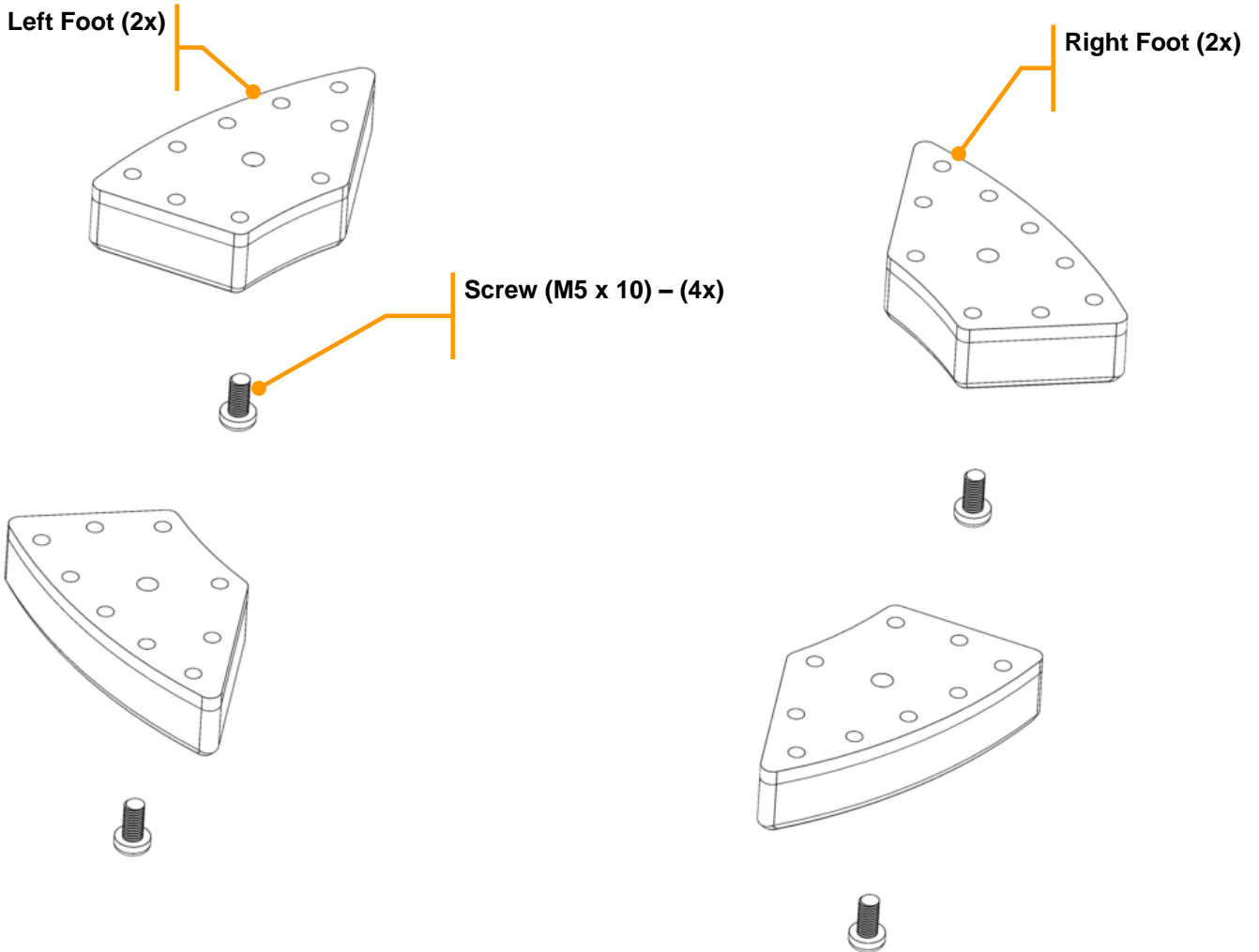
990274101 Rubber Foot Kit – Includes all components as pictured below





 4421 Waterfront Drive Glen Allen, VA 23060	Revision Description:	Add SB960 and SB961 images and call outs to PAD.				Rev. Date:
	Request #:	DOC11607	Page:	7 of 17	Document #:	04/02/21
					540095500	Rev: H

Parts & Accessories Diagram

PROPRIETARY RIGHTS NOTICE This document and all information contained within it is the property of Hamilton Beach Brands, Inc. (HBB). It is confidential and proprietary and has been provided to you for a limited purpose. It must be returned or destroyed upon request. Disclosure, reproduction or use of this document and any information contained within it, in full or in part, for any purpose is forbidden without the prior written consent of HBB. No photographs may be taken of any article fabricated or assembled from this document without the prior written consent of HBB.

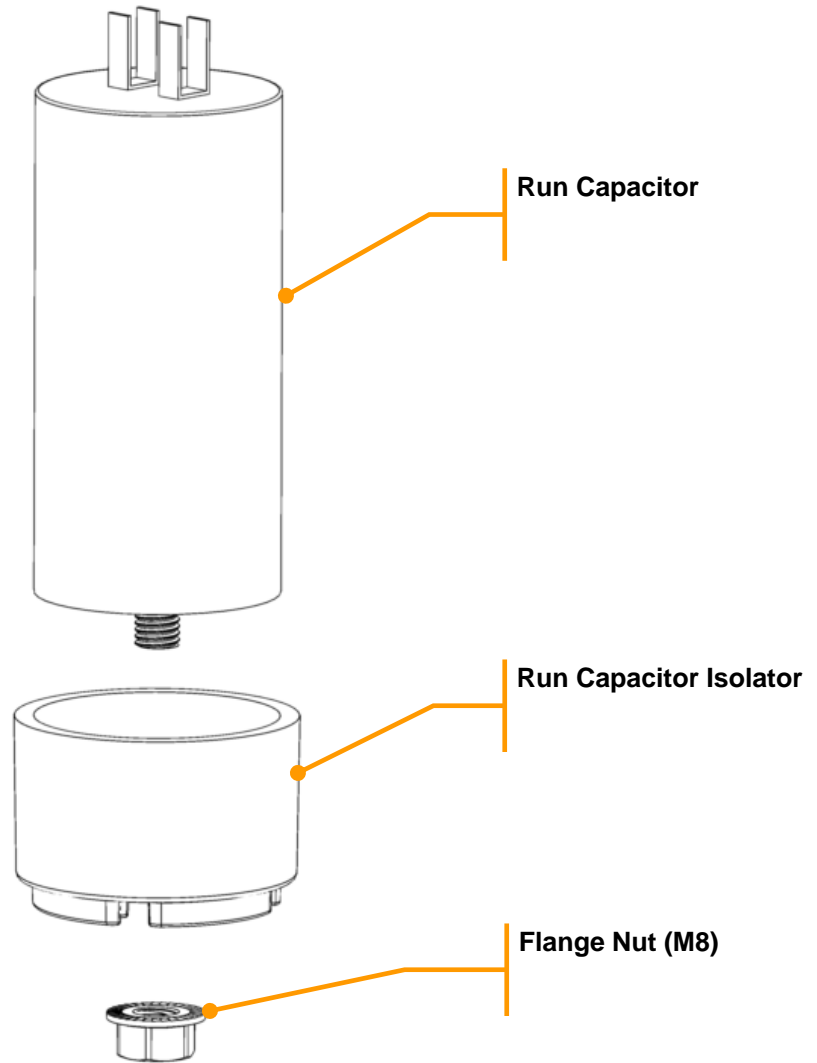
990274200 Run Capacitor Kit – Includes all components as pictured below





 4421 Waterfront Drive Glen Allen, VA 23060	Revision	Add SB960 and SB961 images and call outs to PAD.				Rev. Date:
	Description:					04/02/21
Request #:	DOC11607	Page:	8 of 17	Document #:	540095500	Rev: H

Parts & Accessories Diagram

PROPRIETARY RIGHTS NOTICE This document and all information contained within it is the property of Hamilton Beach Brands, Inc. (HBB). It is confidential and proprietary and has been provided to you for a limited purpose. It must be returned or destroyed upon request. Disclosure, reproduction or use of this document and any information contained within it, in full or in part, for any purpose is forbidden without the prior written consent of HBB. No photographs may be taken of any article fabricated or assembled from this document without the prior written consent of HBB.

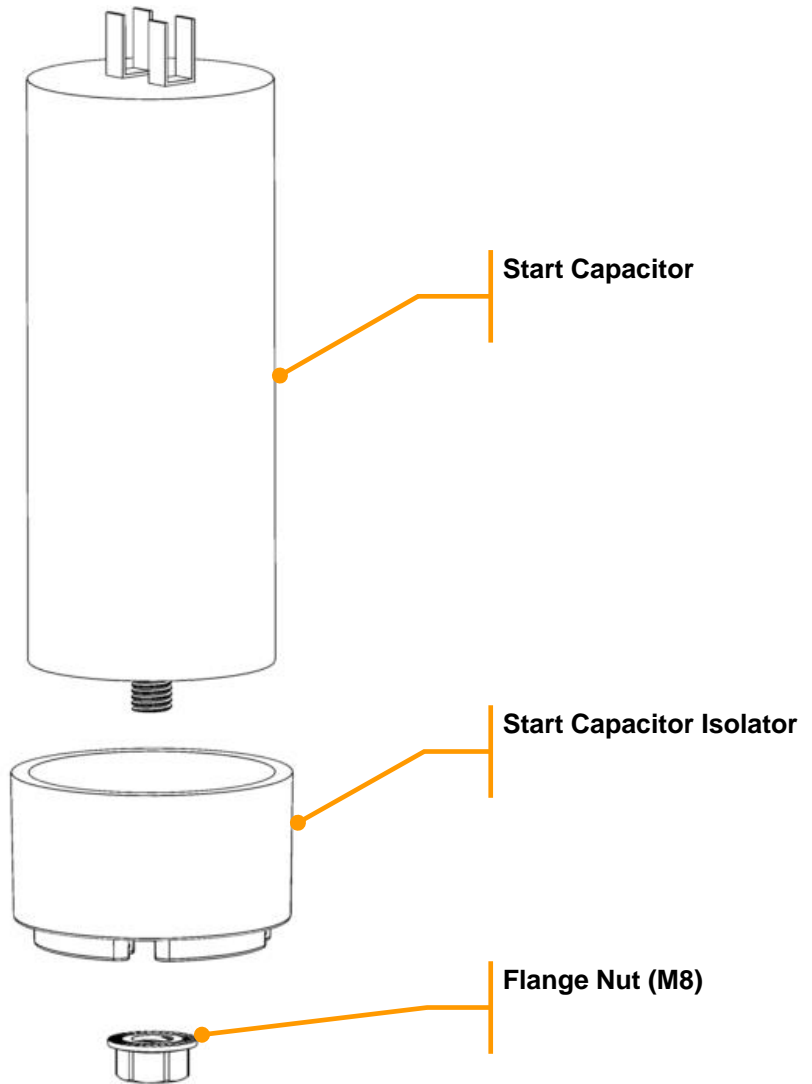
990274300 Start Capacitor Kit – Includes all components as pictured below





 4421 Waterfront Drive Glen Allen, VA 23060	Revision	Add SB960 and SB961 images and call outs to PAD.				Rev. Date:	
	Description:					04/02/21	
Request #:	DOC11607	Page:	9 of 17	Document #:	540095500	Rev:	H

Parts & Accessories Diagram

PROPRIETARY RIGHTS NOTICE This document and all information contained within it is the property of Hamilton Beach Brands, Inc. (HBB). It is confidential and proprietary and has been provided to you for a limited purpose. It must be returned or destroyed upon request. Disclosure, reproduction or use of this document and any information contained within it, in full or in part, for any purpose is forbidden without the prior written consent of HBB. No photographs may be taken of any article fabricated or assembled from this document without the prior written consent of HBB.

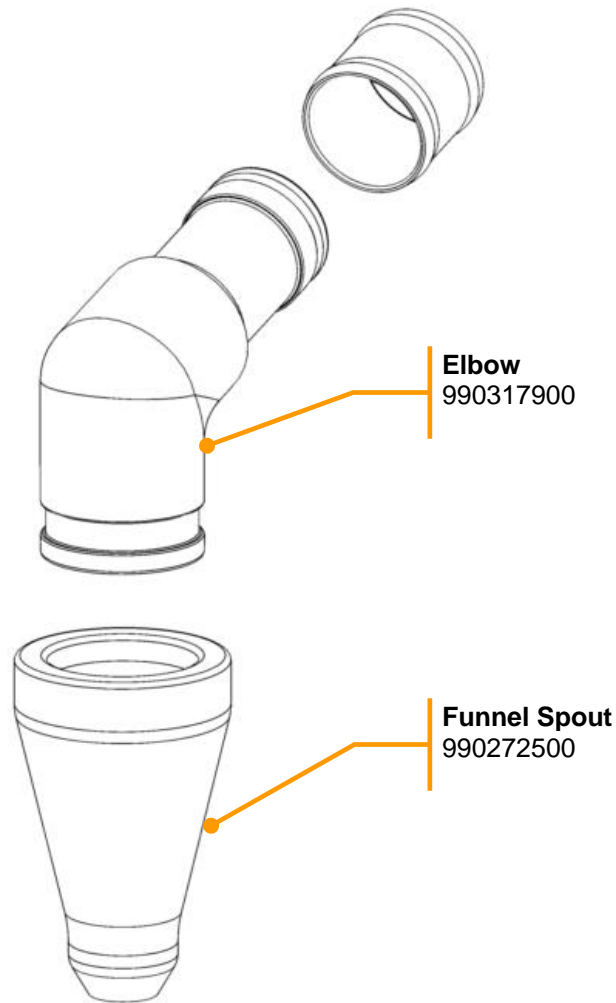
990318000 Spout Kit – Includes all components as pictured below





 4421 Waterfront Drive Glen Allen, VA 23060	Revision	Add SB960 and SB961 images and call outs to PAD.				Rev. Date:	
	Description:					04/02/21	
Request #:	DOC11607	Page:	10 of 17	Document #:	540095500	Rev:	H

Parts & Accessories Diagram

PROPRIETARY RIGHTS NOTICE This document and all information contained within it is the property of Hamilton Beach Brands, Inc. (HBB). It is confidential and proprietary and has been provided to you for a limited purpose. It must be returned or destroyed upon request. Disclosure, reproduction or use of this document and any information contained within it, in full or in part, for any purpose is forbidden without the prior written consent of HBB. No photographs may be taken of any article fabricated or assembled from this document without the prior written consent of HBB.

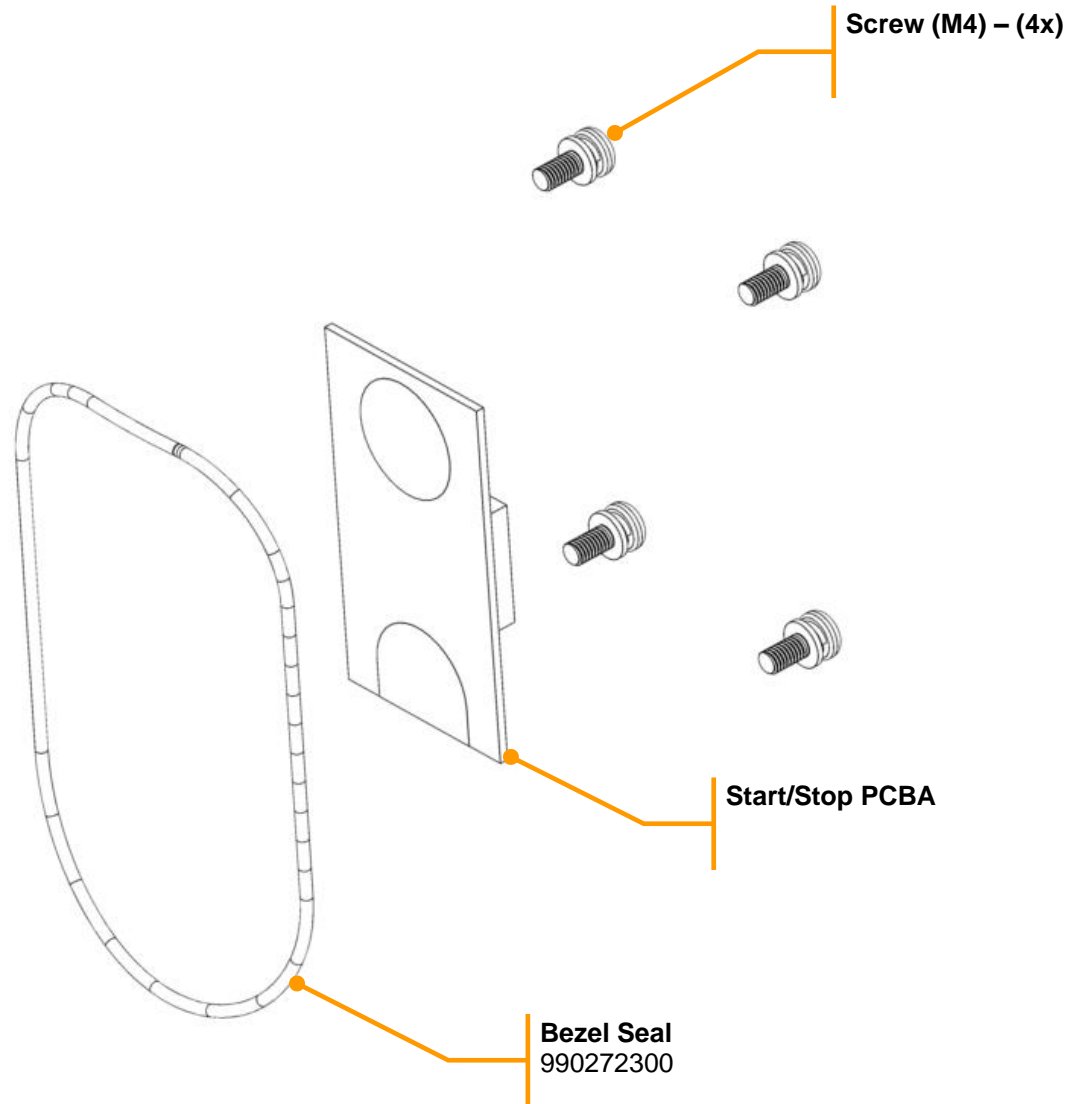
990274500 Start/Stop PCBA Kit – Includes all components as pictured below



 4421 Waterfront Drive Glen Allen, VA 23060	Revision	Add SB960 and SB961 images and call outs to PAD.				Rev. Date:	
	Description:					04/02/21	
Request #:	DOC11607	Page:	11 of 17	Document #:	540095500	Rev:	H

Parts & Accessories Diagram

PROPRIETARY RIGHTS NOTICE This document and all information contained within it is the property of Hamilton Beach Brands, Inc. (HBB). It is confidential and proprietary and has been provided to you for a limited purpose. It must be returned or destroyed upon request. Disclosure, reproduction or use of this document and any information contained within it, in full or in part, for any purpose is forbidden without the prior written consent of HBB. No photographs may be taken of any article fabricated or assembled from this document without the prior written consent of HBB.

990274600 Cord Kit (120V) – Includes all components as pictured below



Cord (120V)
990273300



Strain Relief Grommet
990273600

 4421 Waterfront Drive Glen Allen, VA 23060	Revision	Add SB960 and SB961 images and call outs to PAD.				Rev. Date:
	Description:					04/02/21
Request #:	DOC11607	Page:	12 of 17	Document #:	540095500	Rev: H

Parts & Accessories Diagram

PROPRIETARY RIGHTS NOTICE This document and all information contained within it is the property of Hamilton Beach Brands, Inc. (HBB). It is confidential and proprietary and has been provided to you for a limited purpose. It must be returned or destroyed upon request. Disclosure, reproduction or use of this document and any information contained within it, in full or in part, for any purpose is forbidden without the prior written consent of HBB. No photographs may be taken of any article fabricated or assembled from this document without the prior written consent of HBB.

990274700 PCBA Assembly – Includes all components as pictured below

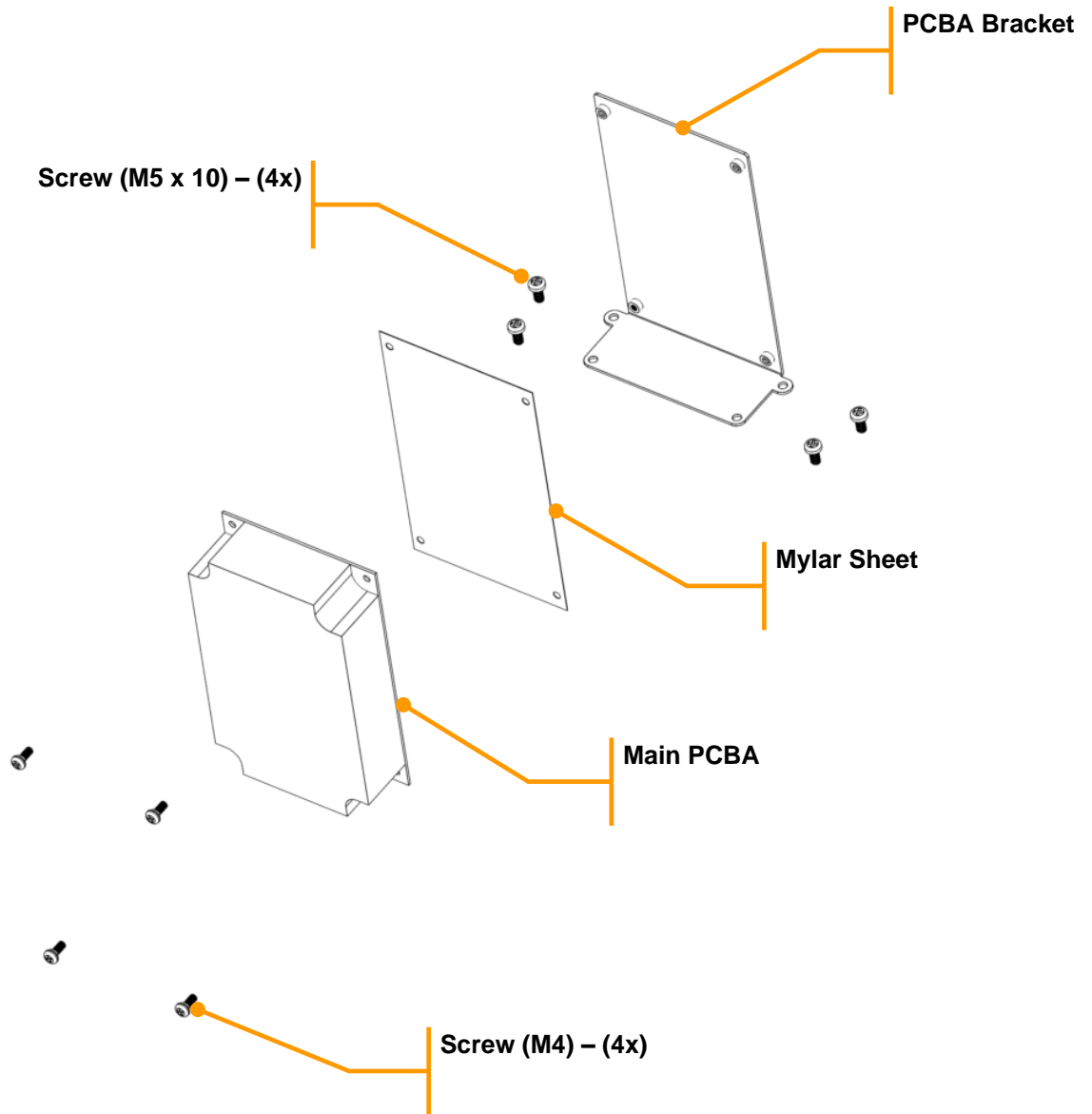



 4421 Waterfront Drive Glen Allen, VA 23060	Revision	Add SB960 and SB961 images and call outs to PAD.				Rev. Date:
	Description:	DOC11607	Page:	13 of 17	Document #:	04/02/21
Request #:	DOC11607	Page:	13 of 17	Document #:	540095500	Rev: H

Parts & Accessories Diagram

PROPRIETARY RIGHTS NOTICE This document and all information contained within it is the property of Hamilton Beach Brands, Inc. (HBB). It is confidential and proprietary and has been provided to you for a limited purpose. It must be returned or destroyed upon request. Disclosure, reproduction or use of this document and any information contained within it, in full or in part, for any purpose is forbidden without the prior written consent of HBB. No photographs may be taken of any article fabricated or assembled from this document without the prior written consent of HBB.

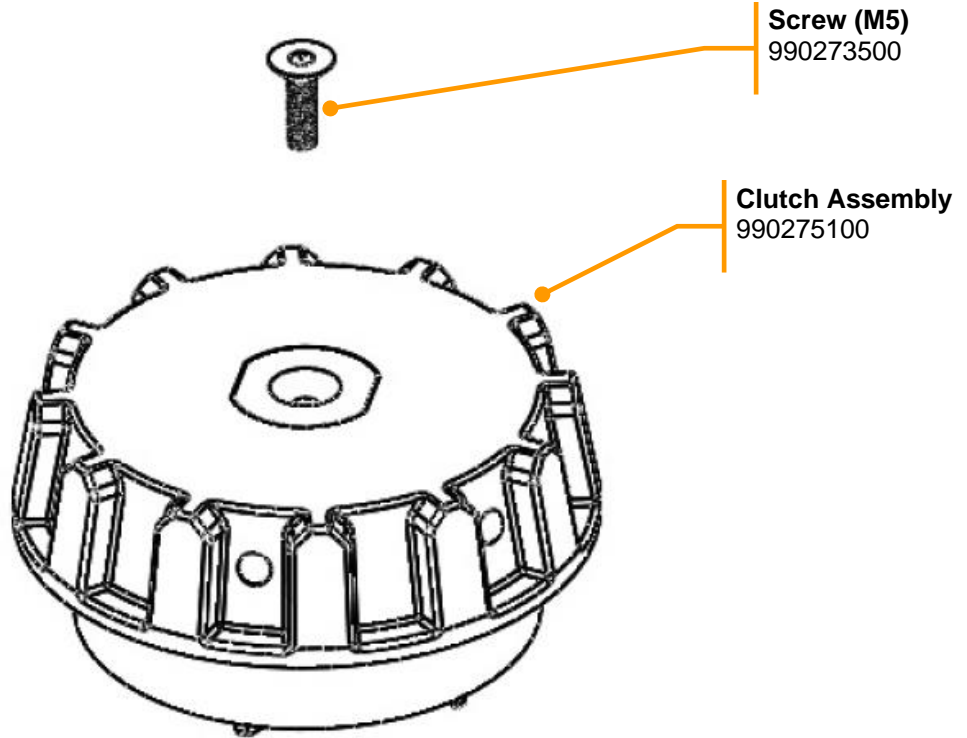
990272200 Clutch Kit – Includes all components as pictured below



 4421 Waterfront Drive Glen Allen, VA 23060	Revision	Add SB960 and SB961 images and call outs to PAD.				Rev. Date:	
	Description:					04/02/21	
Request #:	DOC11607	Page:	14 of 17	Document #:	540095500	Rev:	H

Parts & Accessories Diagram

PROPRIETARY RIGHTS NOTICE This document and all information contained within it is the property of Hamilton Beach Brands, Inc. (HBB). It is confidential and proprietary and has been provided to you for a limited purpose. It must be returned or destroyed upon request. Disclosure, reproduction or use of this document and any information contained within it, in full or in part, for any purpose is forbidden without the prior written consent of HBB. No photographs may be taken of any article fabricated or assembled from this document without the prior written consent of HBB.

UTC960 – Includes all components as pictured below

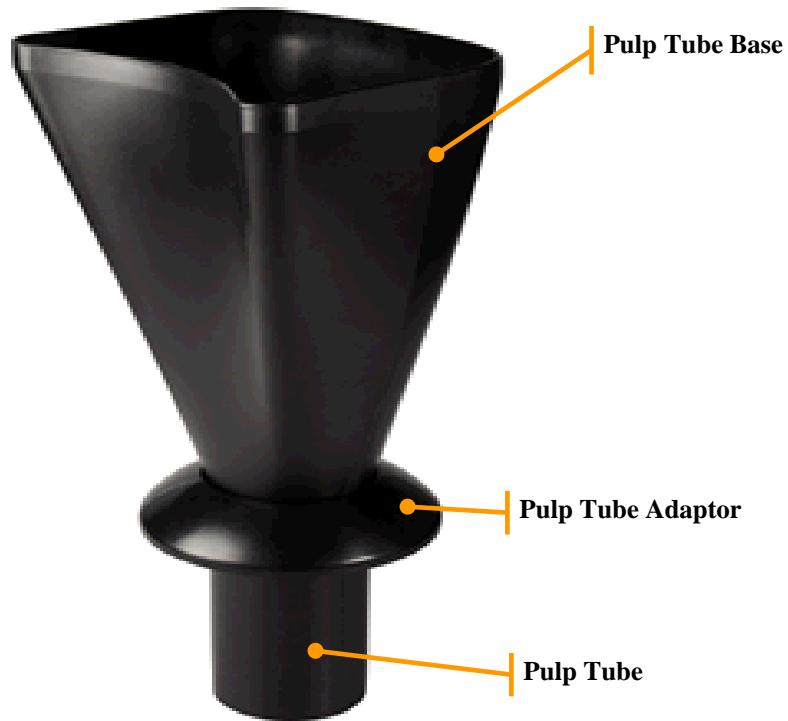

Hamilton Beach 4421 Waterfront Drive Glen Allen, VA 23060	Revision	Add SB960 and SB961 images and call outs to PAD.				Rev. Date:	
	Description:					04/02/21	
Request #:	DOC11607	Page:	15 of 17	Document #:	540095500	Rev:	H

Parts & Accessories Diagram

PROPRIETARY RIGHTS NOTICE This document and all information contained within it is the property of Hamilton Beach Brands, Inc. (HBB). It is confidential and proprietary and has been provided to you for a limited purpose. It must be returned or destroyed upon request. Disclosure, reproduction or use of this document and any information contained within it, in full or in part, for any purpose is forbidden without the prior written consent of HBB. No photographs may be taken of any article fabricated or assembled from this document without the prior written consent of HBB.

Accessories

Strainer Baskets:

SB960 for Normal “Wet” Foods

SB961 for Green Leafy Vegetables (i.e. Kale, Spinach, etc.)



SB960

Enlarged view of SB960 hole pattern.



SB961

Enlarged view of SB961 hole pattern.



Hamilton Beach 4421 Waterfront Drive Glen Allen, VA 23060	Revision	Add SB960 and SB961 images and call outs to PAD.				Rev. Date:
	Description:					04/02/21
Request #:	DOC11607	Page:	16 of 17	Document #:	540095500	Rev: H

Parts & Accessories Diagram

PROPRIETARY RIGHTS NOTICE This document and all information contained within it is the property of Hamilton Beach Brands, Inc. (HBB). It is confidential and proprietary and has been provided to you for a limited purpose. It must be returned or destroyed upon request. Disclosure, reproduction or use of this document and any information contained within it, in full or in part, for any purpose is forbidden without the prior written consent of HBB. No photographs may be taken of any article fabricated or assembled from this document without the prior written consent of HBB.

SB960 & SB961 Accessory Strainer Baskets – Parts Breakdown

Please Note: SB960 & SB961 – Include all components as pictured below

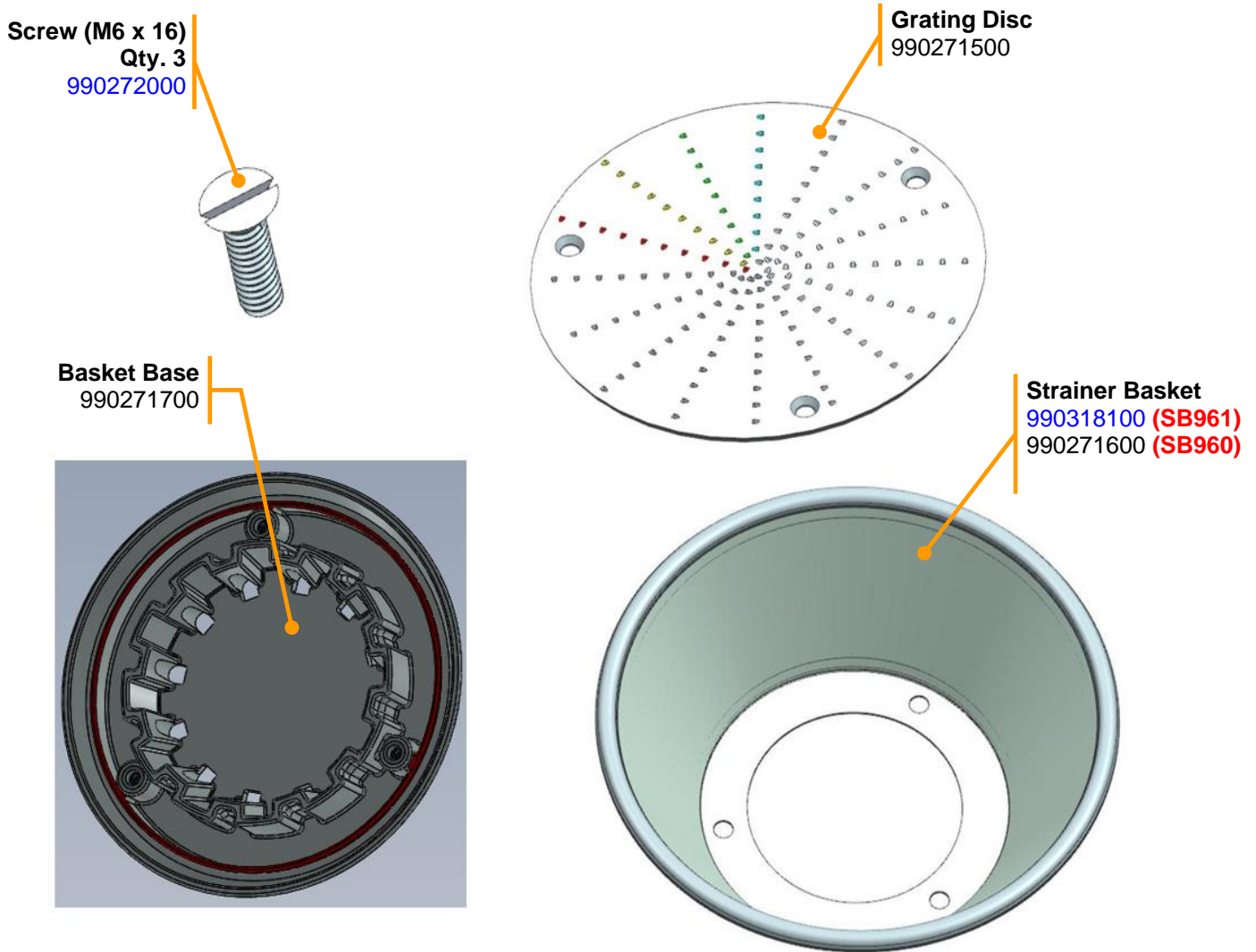

 4421 Waterfront Drive Glen Allen, VA 23060	Revision Description:	Add SB960 and SB961 images and call outs to PAD.				Rev. Date:
	Request #:	DOC11607	Page:	17 of 17	Document #:	540095500
						Rev: H