

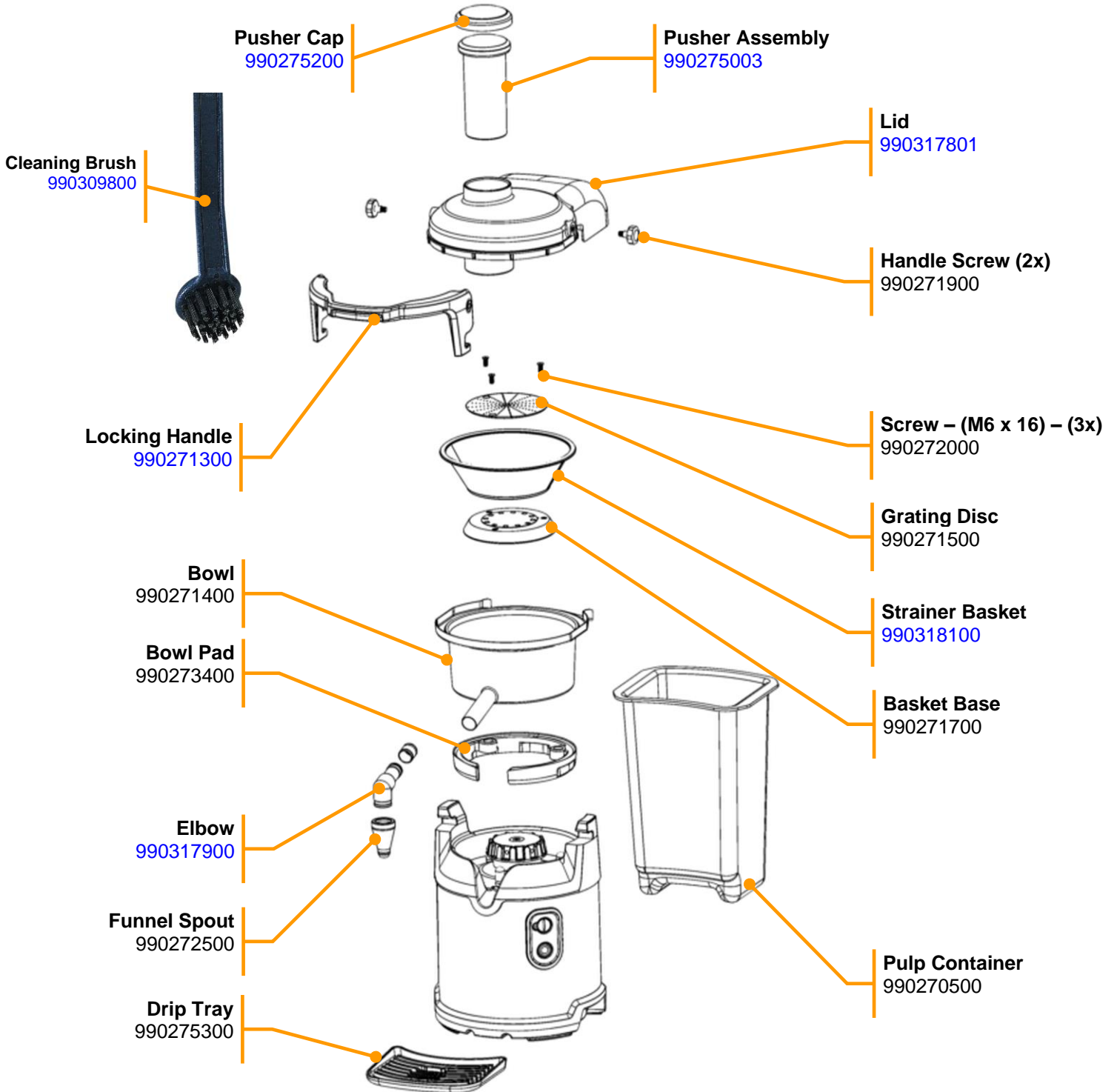

Parts & Accessories Diagram - Model **HJE960-CE** – Series E Industrial Relays

PROPRIETARY RIGHTS NOTICE This document and all information contained within it is the property of Hamilton Beach Brands, Inc. (HBB). It is confidential and proprietary and has been provided to you for a limited purpose. It must be returned or destroyed upon request. Disclosure, reproduction or use of this document and any information contained within it, in full or in part, for any purpose is forbidden without the prior written consent of HBB. No photographs may be taken of any article fabricated or assembled from this document without the prior written consent of HBB.

Replacement Parts



 4421 Waterfront Drive Glen Allen, VA 23060	Revision Description:	Production Release				Rev. Date:
	Request #:	DOC11715	Page:	1 of 22	Document #:	540102300
						Rev: A

Parts & Accessories Diagram - Model **HJE960-CE** – Series E Industrial Relays

PROPRIETARY RIGHTS NOTICE This document and all information contained within it is the property of Hamilton Beach Brands, Inc. (HBB). It is confidential and proprietary and has been provided to you for a limited purpose. It must be returned or destroyed upon request. Disclosure, reproduction or use of this document and any information contained within it, in full or in part, for any purpose is forbidden without the prior written consent of HBB. No photographs may be taken of any article fabricated or assembled from this document without the prior written consent of HBB.

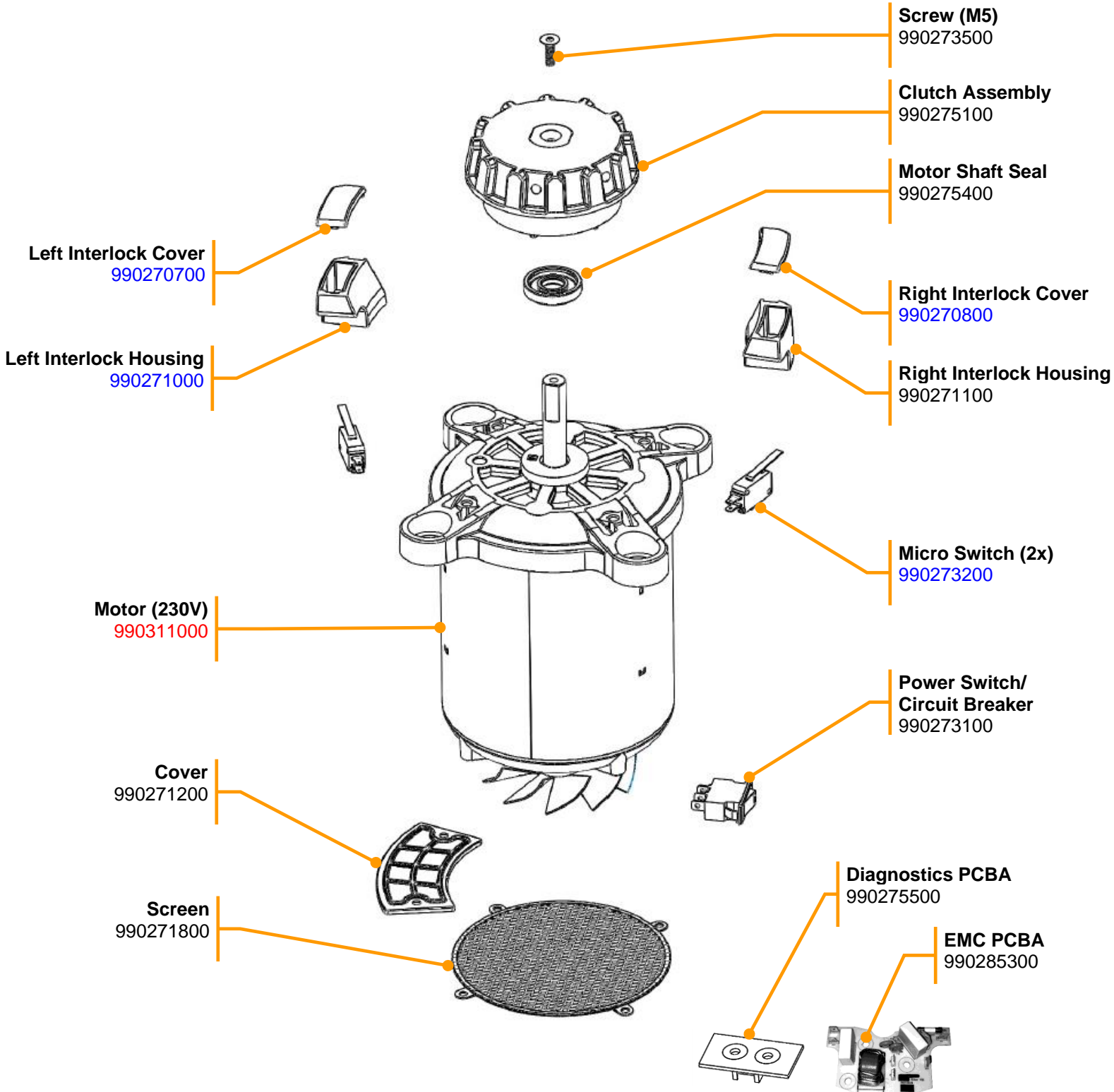



 <p>Hamilton Beach 4421 Waterfront Drive Glen Allen, VA 23060</p>	Revision Description:	Production Release				Rev. Date:
	Request #:	DOC11715	Page:	2 of 22	Document #:	540102300
						Rev: A

Parts & Accessories Diagram - Model **HJE960-CE** – Series E Industrial Relays

PROPRIETARY RIGHTS NOTICE This document and all information contained within it is the property of Hamilton Beach Brands, Inc. (HBB). It is confidential and proprietary and has been provided to you for a limited purpose. It must be returned or destroyed upon request. Disclosure, reproduction or use of this document and any information contained within it, in full or in part, for any purpose is forbidden without the prior written consent of HBB. No photographs may be taken of any article fabricated or assembled from this document without the prior written consent of HBB.

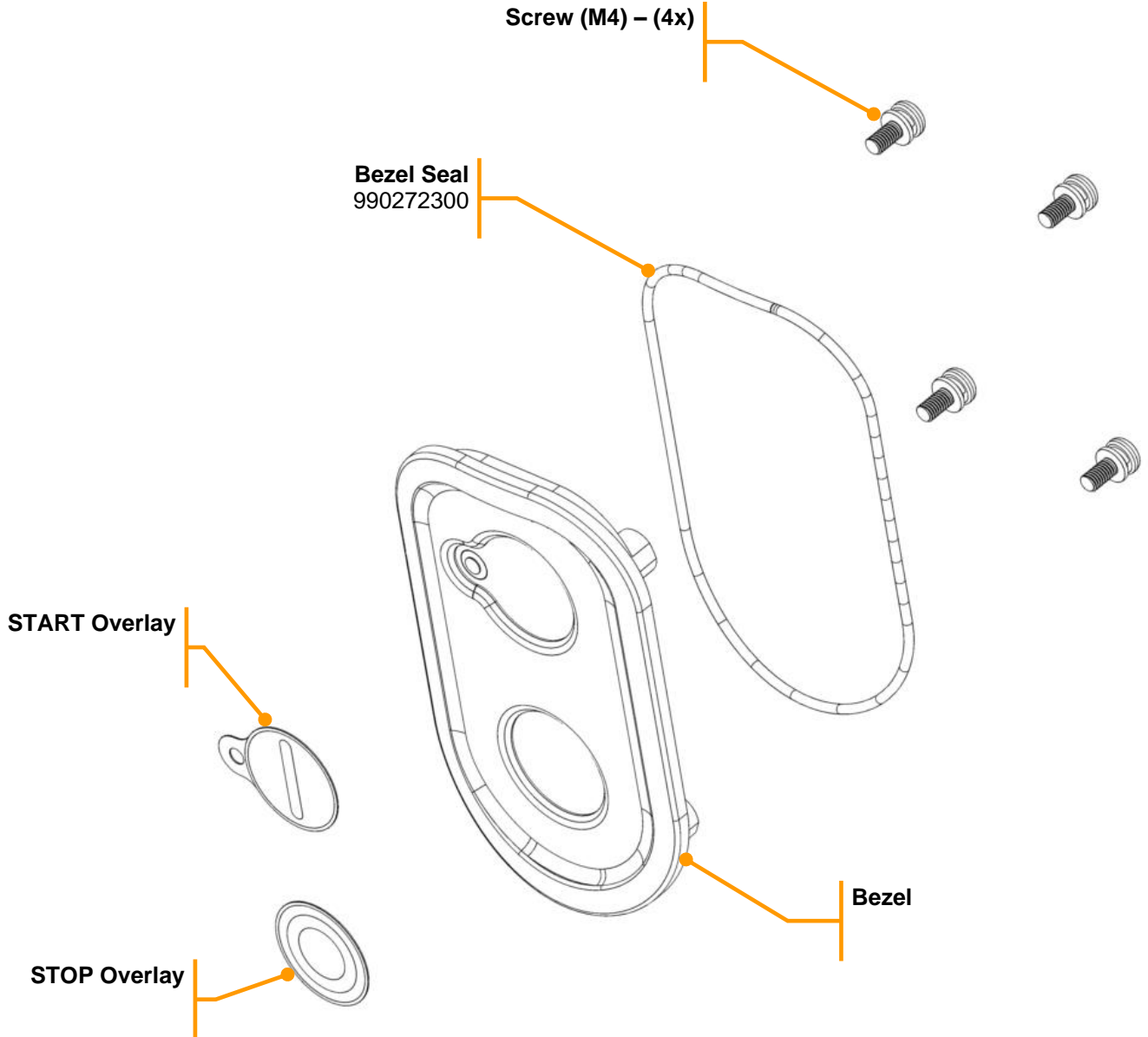
990273700 Bezel Service Kit – Includes all components as pictured below





 4421 Waterfront Drive Glen Allen, VA 23060	Revision	Production Release				Rev. Date:	
	Description:					04/21/2021	
Request #:	DOC11715	Page:	3 of 22	Document #:	540102300	Rev:	A

Parts & Accessories Diagram - Model **HJE960-CE** – Series E Industrial Relays

PROPRIETARY RIGHTS NOTICE This document and all information contained within it is the property of Hamilton Beach Brands, Inc. (HBB). It is confidential and proprietary and has been provided to you for a limited purpose. It must be returned or destroyed upon request. Disclosure, reproduction or use of this document and any information contained within it, in full or in part, for any purpose is forbidden without the prior written consent of HBB. No photographs may be taken of any article fabricated or assembled from this document without the prior written consent of HBB.

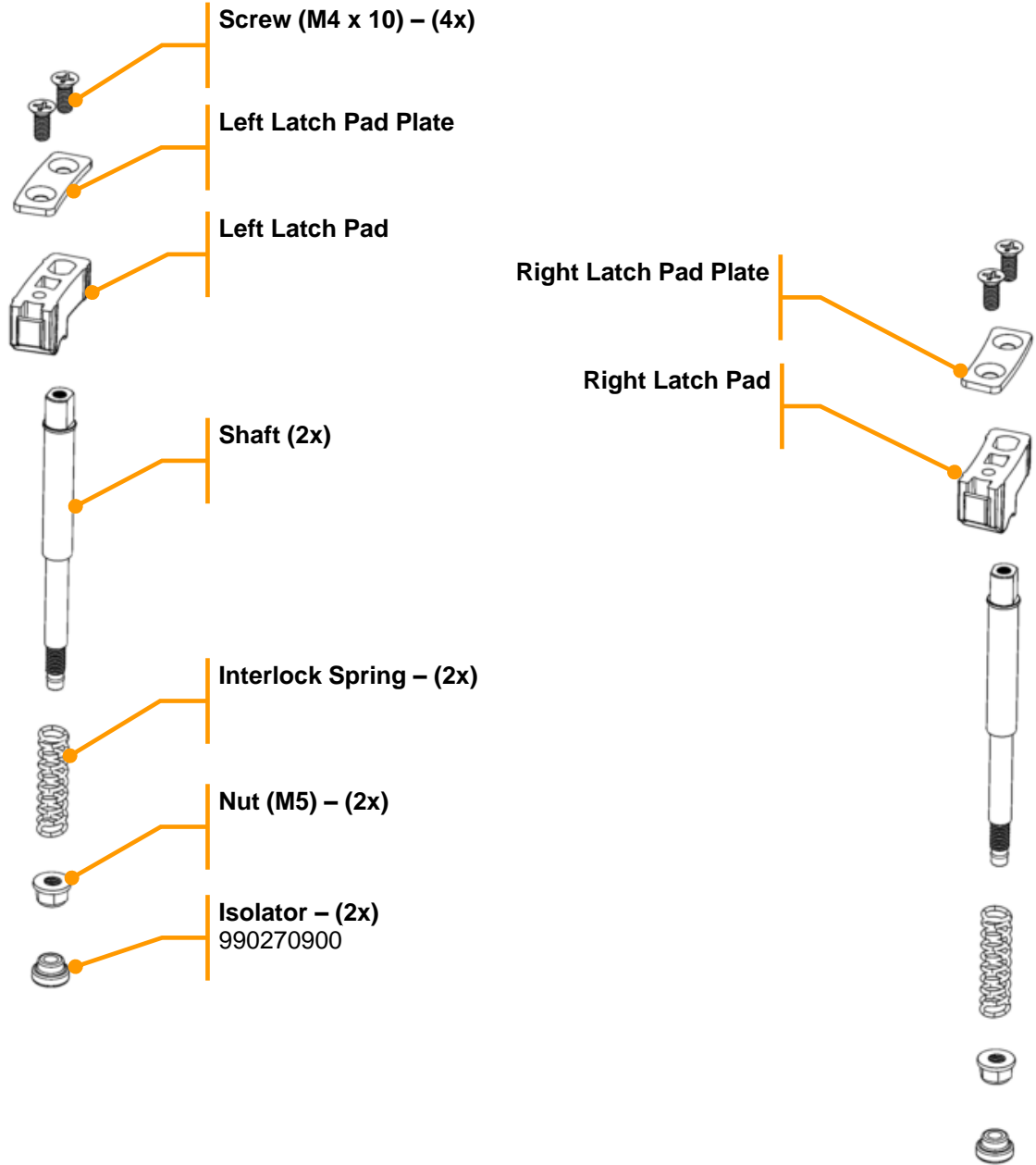
990273800 Latch Service Kit – Includes all components as pictured below





 4421 Waterfront Drive Glen Allen, VA 23060	Revision Description:	Production Release				Rev. Date:
	Request #:	DOC11715	Page:	4 of 22	Document #:	540102300
						Rev: A

Parts & Accessories Diagram - Model **HJE960-CE** – Series E Industrial Relays

PROPRIETARY RIGHTS NOTICE This document and all information contained within it is the property of Hamilton Beach Brands, Inc. (HBB). It is confidential and proprietary and has been provided to you for a limited purpose. It must be returned or destroyed upon request. Disclosure, reproduction or use of this document and any information contained within it, in full or in part, for any purpose is forbidden without the prior written consent of HBB. No photographs may be taken of any article fabricated or assembled from this document without the prior written consent of HBB.

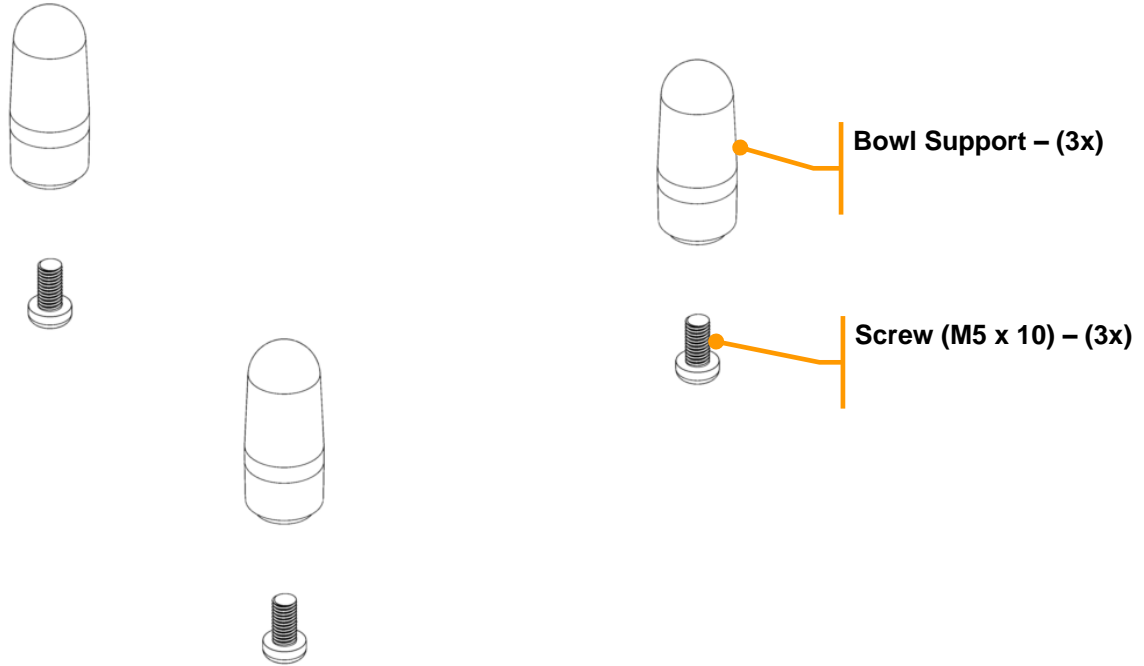
990273900 Bowl Support Service Kit – Includes all components as pictured below





 4421 Waterfront Drive Glen Allen, VA 23060	Revision	Production Release					Rev. Date:
	Description:						04/21/2021
Request #:	DOC11715	Page:	5 of 22	Document #:	540102300	Rev:	A

Parts & Accessories Diagram - Model **HJE960-CE** – Series E Industrial Relays

PROPRIETARY RIGHTS NOTICE This document and all information contained within it is the property of Hamilton Beach Brands, Inc. (HBB). It is confidential and proprietary and has been provided to you for a limited purpose. It must be returned or destroyed upon request. Disclosure, reproduction or use of this document and any information contained within it, in full or in part, for any purpose is forbidden without the prior written consent of HBB. No photographs may be taken of any article fabricated or assembled from this document without the prior written consent of HBB.

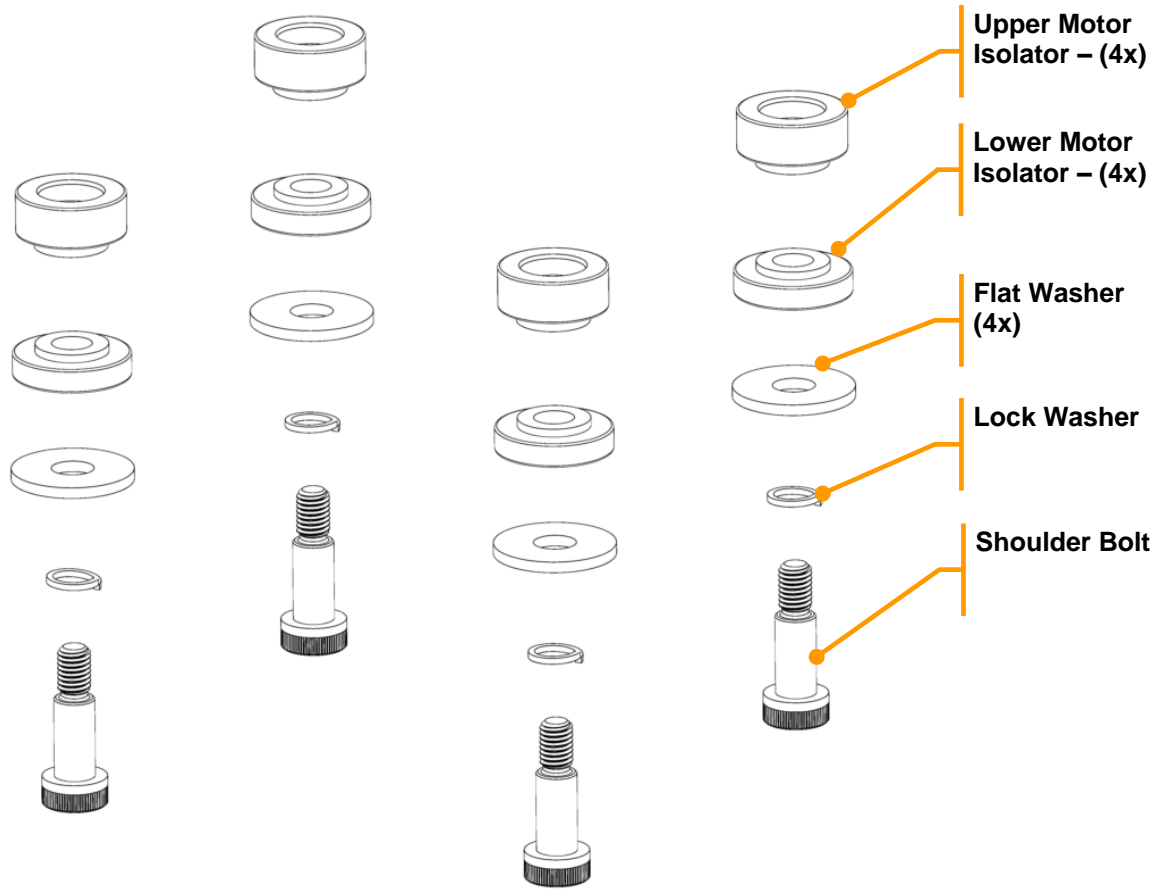
990274000 Motor Hardware Kit – Includes all components as pictured below





 4421 Waterfront Drive Glen Allen, VA 23060	Revision Description:	Production Release				Rev. Date:	
	Request #:	DOC11715	Page:	6 of 22	Document #:	540102300	Rev: A

Parts & Accessories Diagram - Model **HJE960-CE** – Series E Industrial Relays

PROPRIETARY RIGHTS NOTICE This document and all information contained within it is the property of Hamilton Beach Brands, Inc. (HBB). It is confidential and proprietary and has been provided to you for a limited purpose. It must be returned or destroyed upon request. Disclosure, reproduction or use of this document and any information contained within it, in full or in part, for any purpose is forbidden without the prior written consent of HBB. No photographs may be taken of any article fabricated or assembled from this document without the prior written consent of HBB.

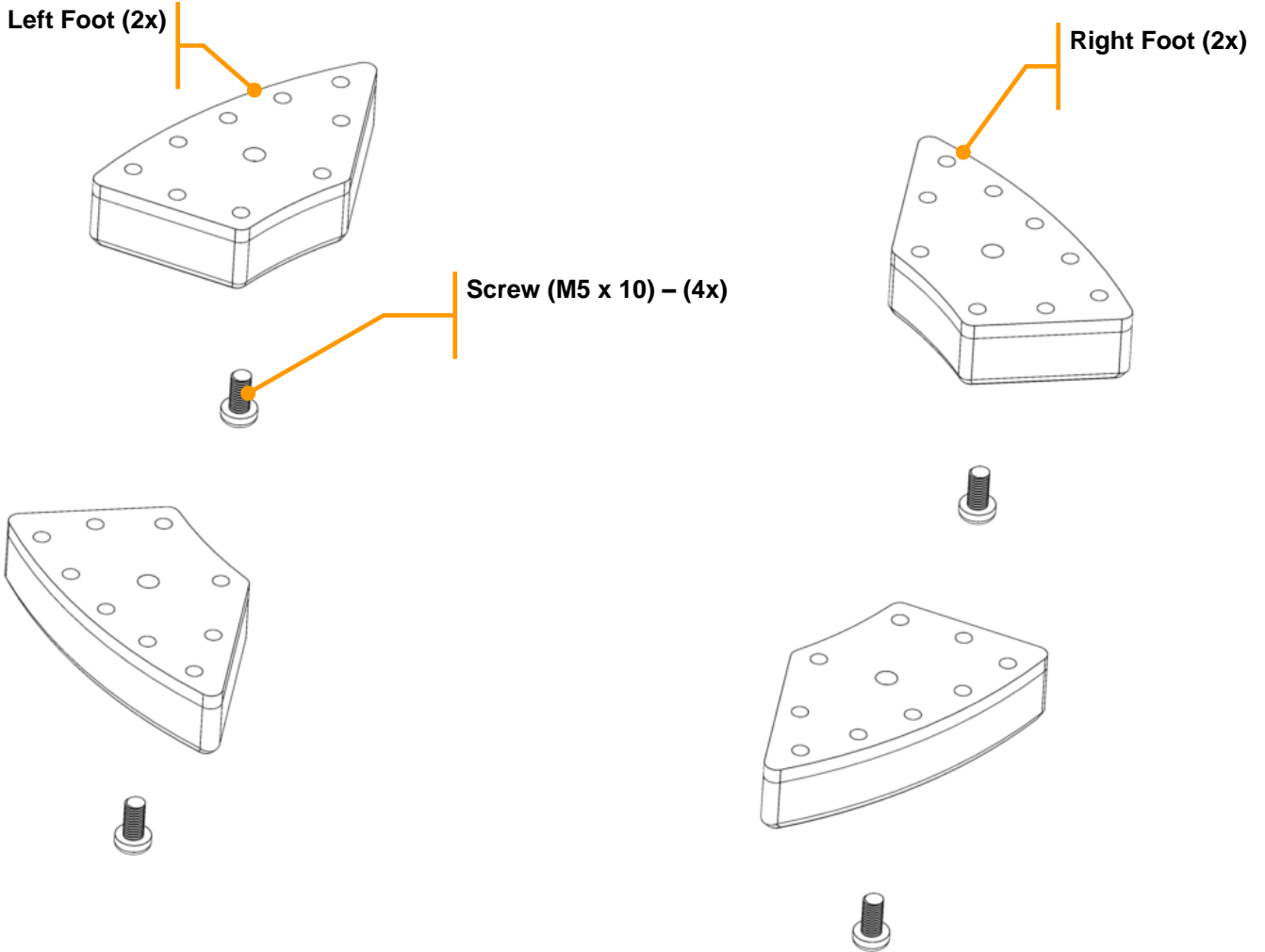
990274101 Rubber Foot Kit – Includes all components as pictured below





 4421 Waterfront Drive Glen Allen, VA 23060	Revision	Production Release					Rev. Date:
	Description:						04/21/2021
Request #:	DOC11715	Page:	7 of 22	Document #:	540102300	Rev:	A

Parts & Accessories Diagram - Model **HJE960-CE** – Series E Industrial Relays

PROPRIETARY RIGHTS NOTICE This document and all information contained within it is the property of Hamilton Beach Brands, Inc. (HBB). It is confidential and proprietary and has been provided to you for a limited purpose. It must be returned or destroyed upon request. Disclosure, reproduction or use of this document and any information contained within it, in full or in part, for any purpose is forbidden without the prior written consent of HBB. No photographs may be taken of any article fabricated or assembled from this document without the prior written consent of HBB.

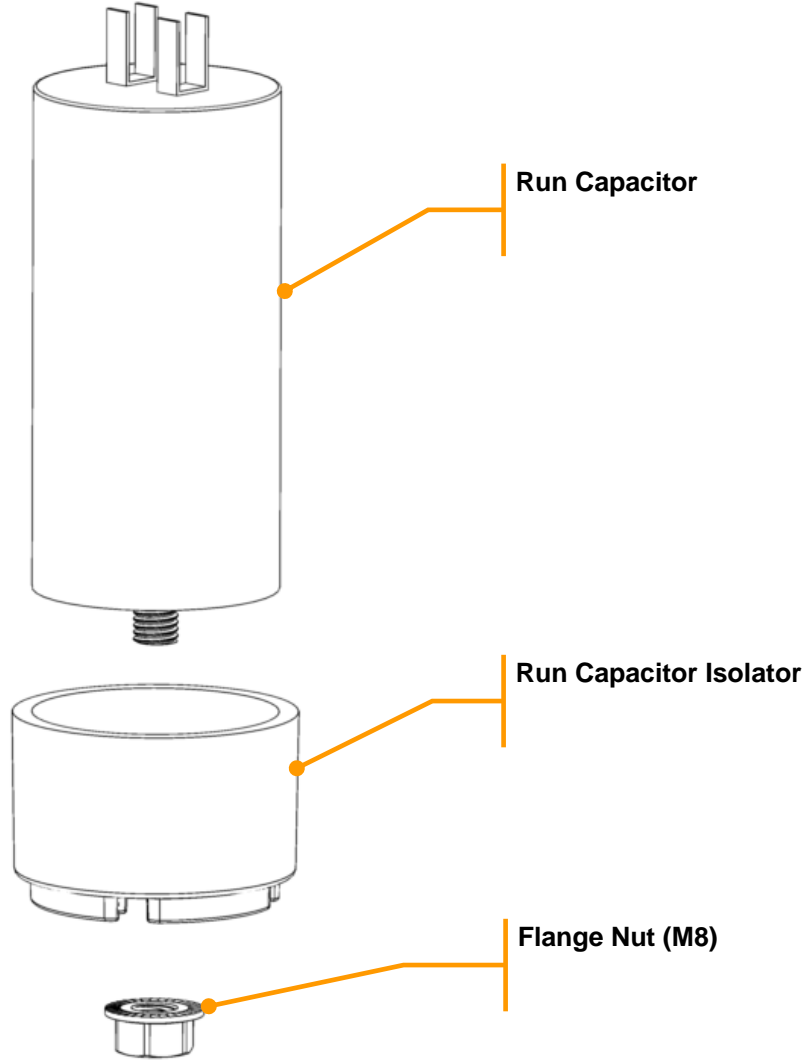
990274201 Run Capacitor Kit – Includes all components as pictured below



 4421 Waterfront Drive Glen Allen, VA 23060	Revision Description:	Production Release				Rev. Date:	
	Request #:	DOC11715	Page:	8 of 22	Document #:	540102300	Rev: A

Parts & Accessories Diagram - Model **HJE960-CE** – Series E Industrial Relays

PROPRIETARY RIGHTS NOTICE This document and all information contained within it is the property of Hamilton Beach Brands, Inc. (HBB). It is confidential and proprietary and has been provided to you for a limited purpose. It must be returned or destroyed upon request. Disclosure, reproduction or use of this document and any information contained within it, in full or in part, for any purpose is forbidden without the prior written consent of HBB. No photographs may be taken of any article fabricated or assembled from this document without the prior written consent of HBB.

990274301 Start Capacitor Kit – Includes all components as pictured below

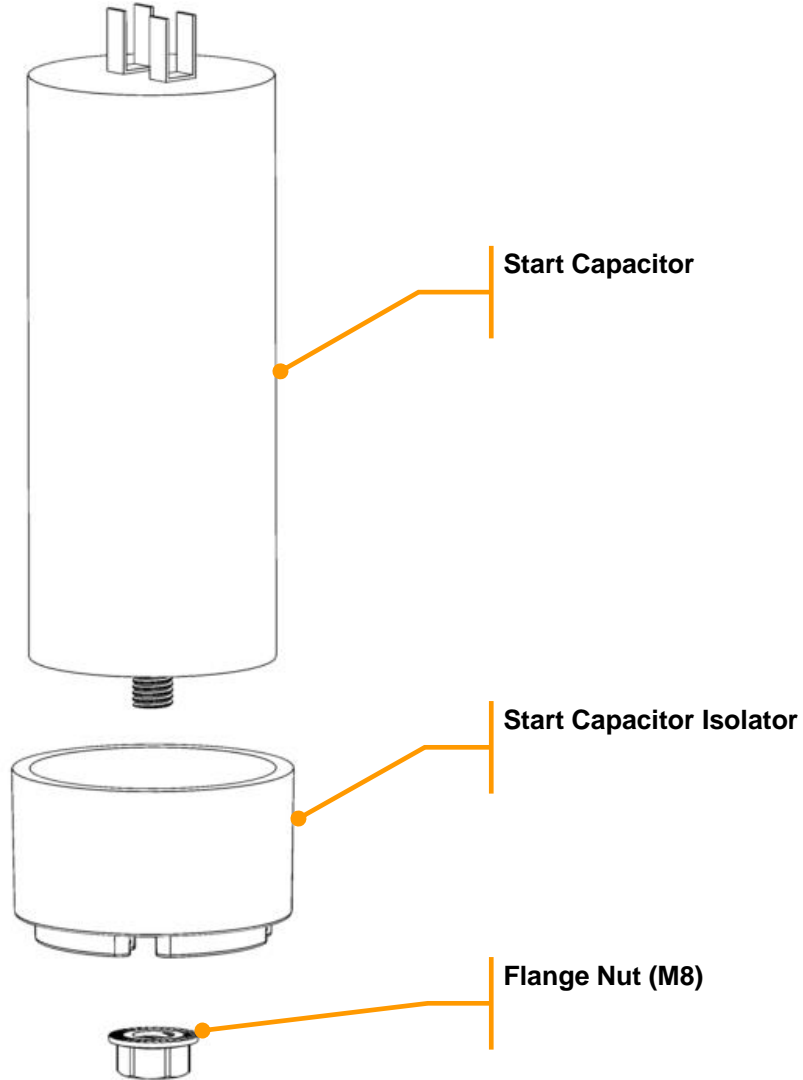



4421 Waterfront Drive Glen Allen, VA 23060	Revision Description: Production Release					Rev. Date: 04/21/2021
	Request #:	DOC11715	Page:	9 of 22	Document #:	540102300

Parts & Accessories Diagram - Model **HJE960-CE** – Series E Industrial Relays

PROPRIETARY RIGHTS NOTICE This document and all information contained within it is the property of Hamilton Beach Brands, Inc. (HBB). It is confidential and proprietary and has been provided to you for a limited purpose. It must be returned or destroyed upon request. Disclosure, reproduction or use of this document and any information contained within it, in full or in part, for any purpose is forbidden without the prior written consent of HBB. No photographs may be taken of any article fabricated or assembled from this document without the prior written consent of HBB.

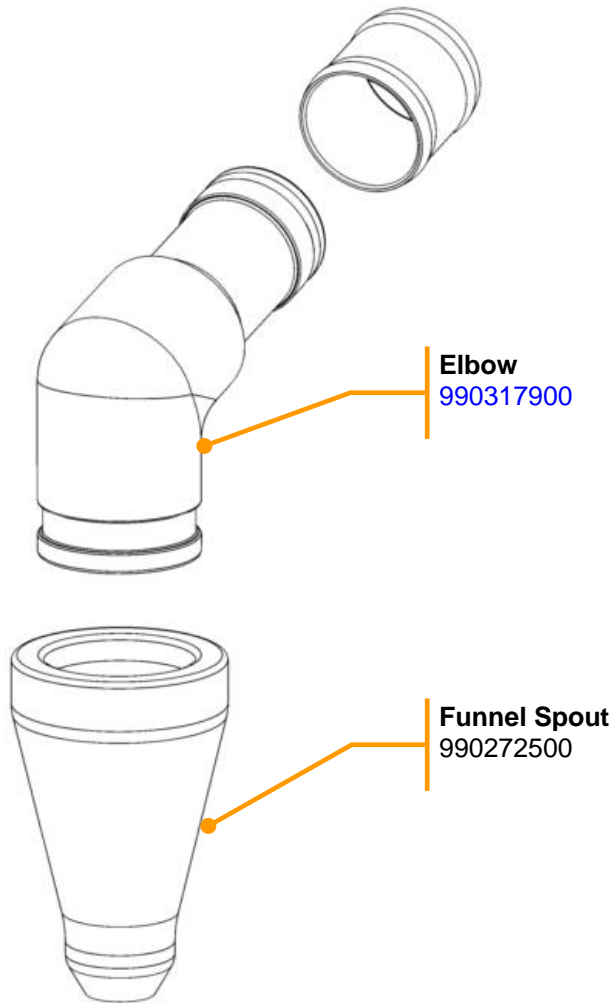
990318000 Spout Kit – Includes all components as pictured below



 4421 Waterfront Drive Glen Allen, VA 23060	Revision	Production Release					Rev. Date:	
	Description:						04/21/2021	
	Request #:	DOC11715	Page:	10 of 22	Document #:	540102300	Rev:	A

Parts & Accessories Diagram - Model HJE960-CE – Series E Industrial Relays

PROPRIETARY RIGHTS NOTICE This document and all information contained within it is the property of Hamilton Beach Brands, Inc. (HBB). It is confidential and proprietary and has been provided to you for a limited purpose. It must be returned or destroyed upon request. Disclosure, reproduction or use of this document and any information contained within it, in full or in part, for any purpose is forbidden without the prior written consent of HBB. No photographs may be taken of any article fabricated or assembled from this document without the prior written consent of HBB.

990309000 Start/Stop PCBA Kit – Includes all components as pictured below

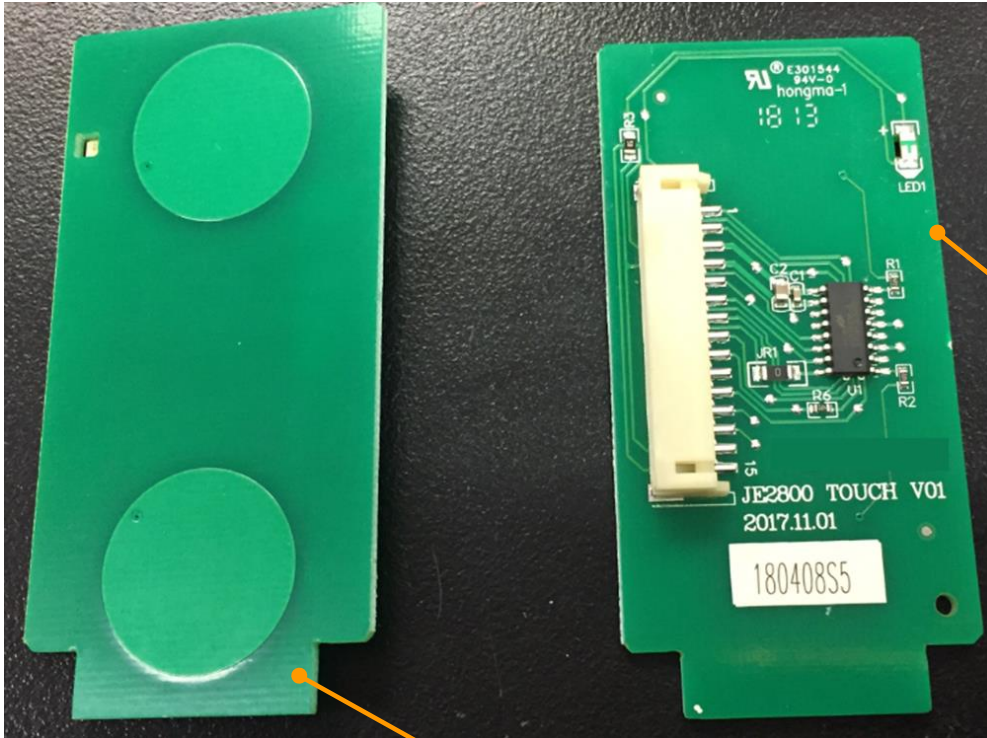

Start/Stop PCBA
230V version w/
15pin Connector
220-240V version

Start/Stop PCBA
Opposite side view



Bezel Seal

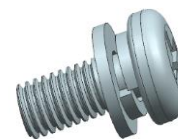

Screw (M4)
(Qty. 4)

 4421 Waterfront Drive Glen Allen, VA 23060	Revision Description:	Production Release				Rev. Date:
	Request #:	DOC11715	Page:	11 of 22	Document #:	540102300
						Rev: A

Parts & Accessories Diagram - Model HJE960-CE – Series E Industrial Relays

PROPRIETARY RIGHTS NOTICE This document and all information contained within it is the property of Hamilton Beach Brands, Inc. (HBB). It is confidential and proprietary and has been provided to you for a limited purpose. It must be returned or destroyed upon request. Disclosure, reproduction or use of this document and any information contained within it, in full or in part, for any purpose is forbidden without the prior written consent of HBB. No photographs may be taken of any article fabricated or assembled from this document without the prior written consent of HBB.

Industrial Relay – Series E – 220-240V Components

1. Single Relay (Brake) Assembly – 990374200

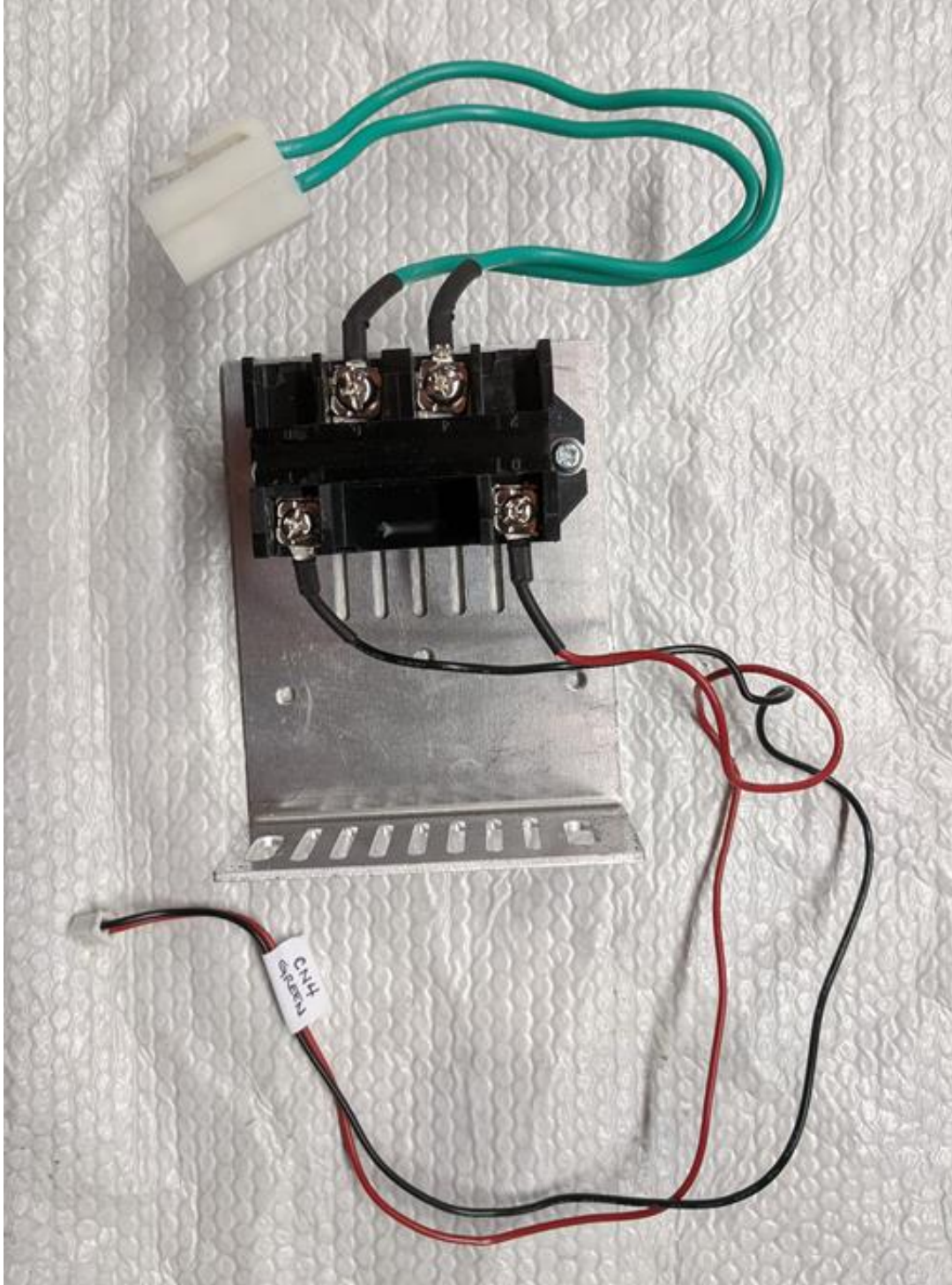



 4421 Waterfront Drive Glen Allen, VA 23060	Revision	Production Release				Rev. Date:	
	Description:					04/21/2021	
	Request #:	DOC11715	Page:	12 of 22	Document #:	540102300	Rev:

Parts & Accessories Diagram - Model HJE960-CE – Series E Industrial Relays

PROPRIETARY RIGHTS NOTICE This document and all information contained within it is the property of Hamilton Beach Brands, Inc. (HBB). It is confidential and proprietary and has been provided to you for a limited purpose. It must be returned or destroyed upon request. Disclosure, reproduction or use of this document and any information contained within it, in full or in part, for any purpose is forbidden without the prior written consent of HBB. No photographs may be taken of any article fabricated or assembled from this document without the prior written consent of HBB.

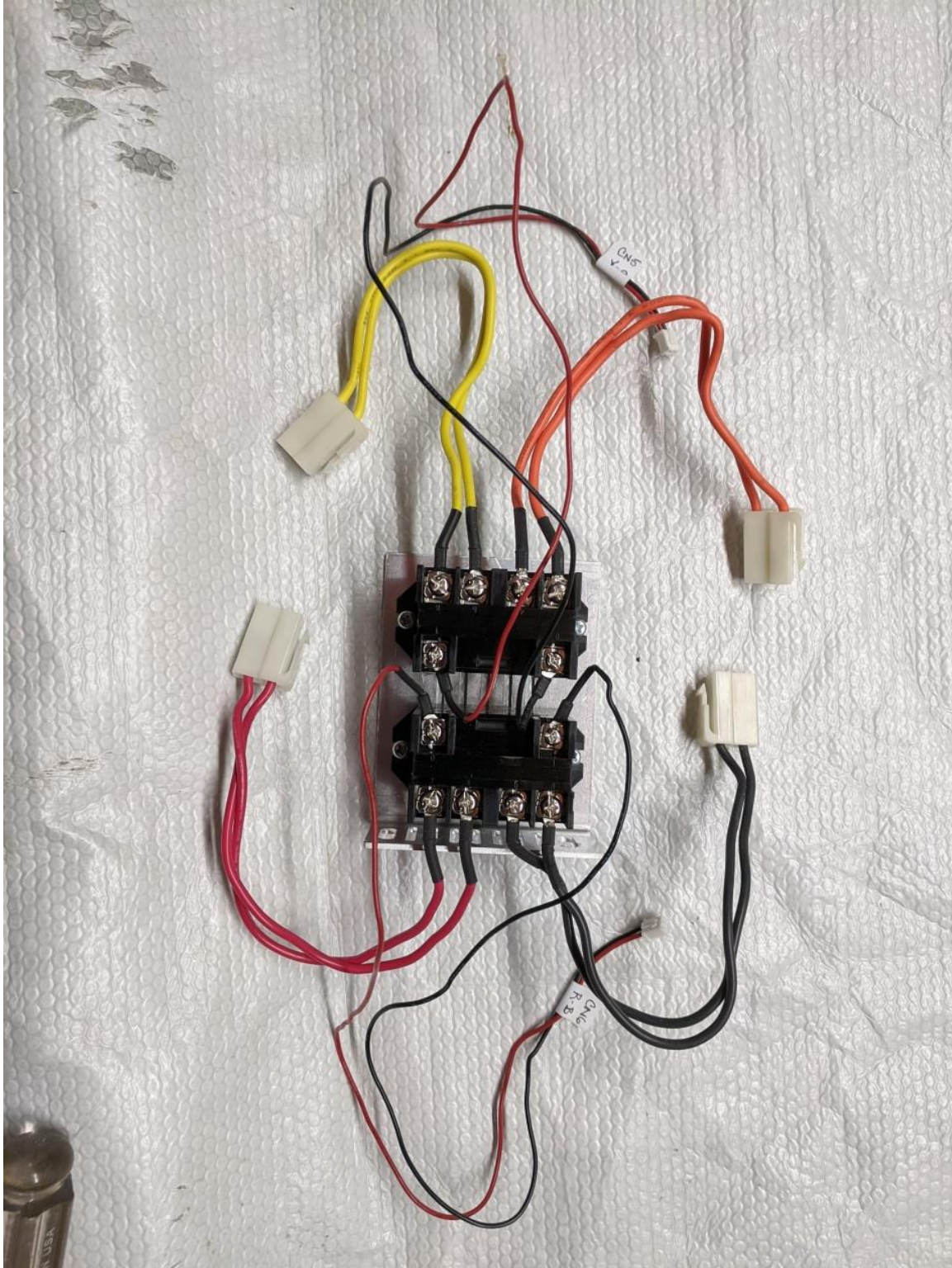
2. Dual Relay (Motor Starting / Running) Assembly – 990374300





 4421 Waterfront Drive Glen Allen, VA 23060	Revision	Production Release				Rev. Date:	
	Description:					04/21/2021	
	Request #:	DOC11715	Page:	13 of 22	Document #:	540102300	Rev:

Parts & Accessories Diagram - Model **HJE960-CE** – Series E Industrial Relays

PROPRIETARY RIGHTS NOTICE This document and all information contained within it is the property of Hamilton Beach Brands, Inc. (HBB). It is confidential and proprietary and has been provided to you for a limited purpose. It must be returned or destroyed upon request. Disclosure, reproduction or use of this document and any information contained within it, in full or in part, for any purpose is forbidden without the prior written consent of HBB. No photographs may be taken of any article fabricated or assembled from this document without the prior written consent of HBB.

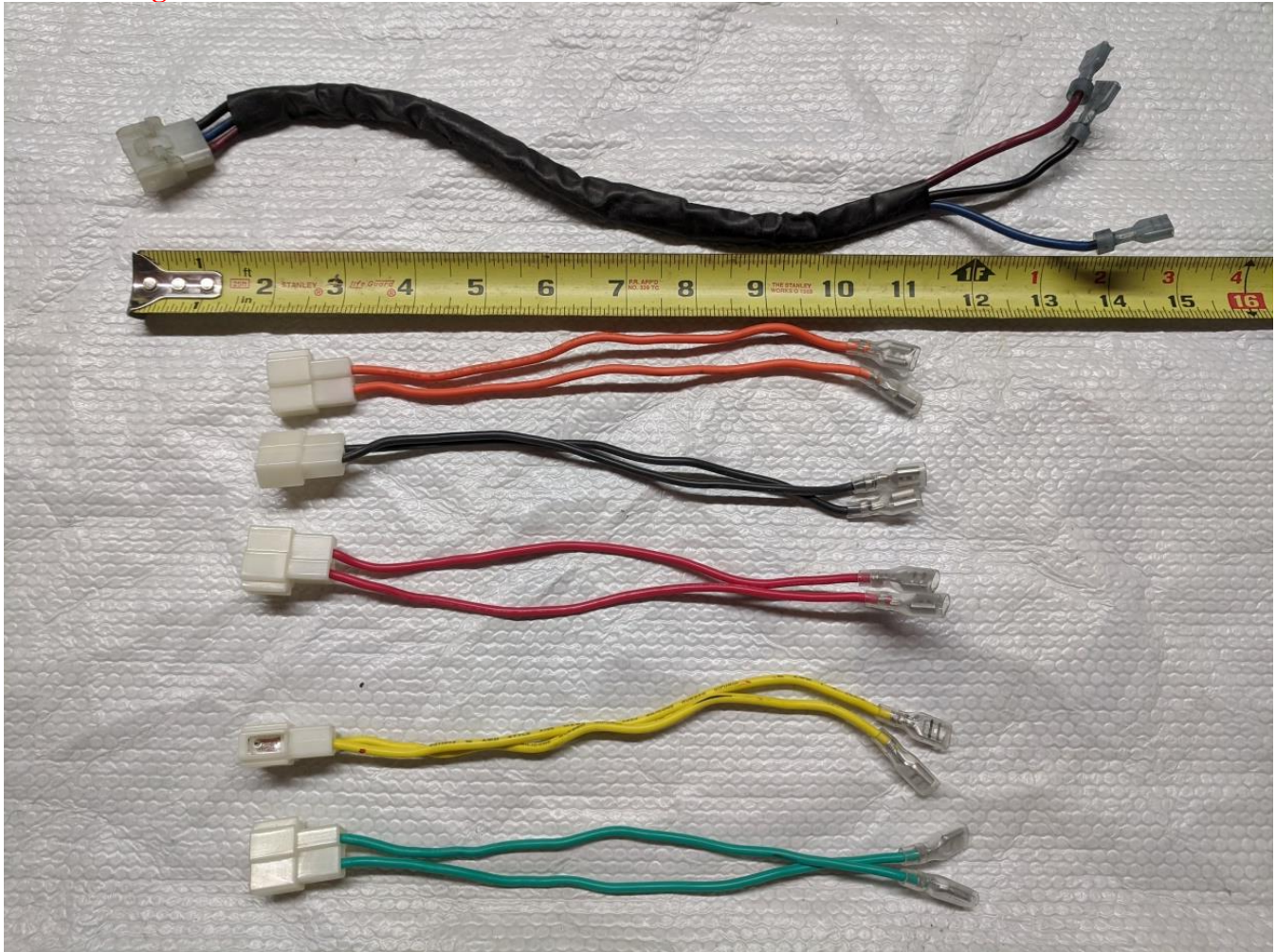
3. Wiring Harness – 990374400





 4421 Waterfront Drive Glen Allen, VA 23060	Revision	Production Release				Rev. Date:		
	Description:					Request #:		Page:

Parts & Accessories Diagram - Model HJE960-CE – Series E Industrial Relays

PROPRIETARY RIGHTS NOTICE This document and all information contained within it is the property of Hamilton Beach Brands, Inc. (HBB). It is confidential and proprietary and has been provided to you for a limited purpose. It must be returned or destroyed upon request. Disclosure, reproduction or use of this document and any information contained within it, in full or in part, for any purpose is forbidden without the prior written consent of HBB. No photographs may be taken of any article fabricated or assembled from this document without the prior written consent of HBB.

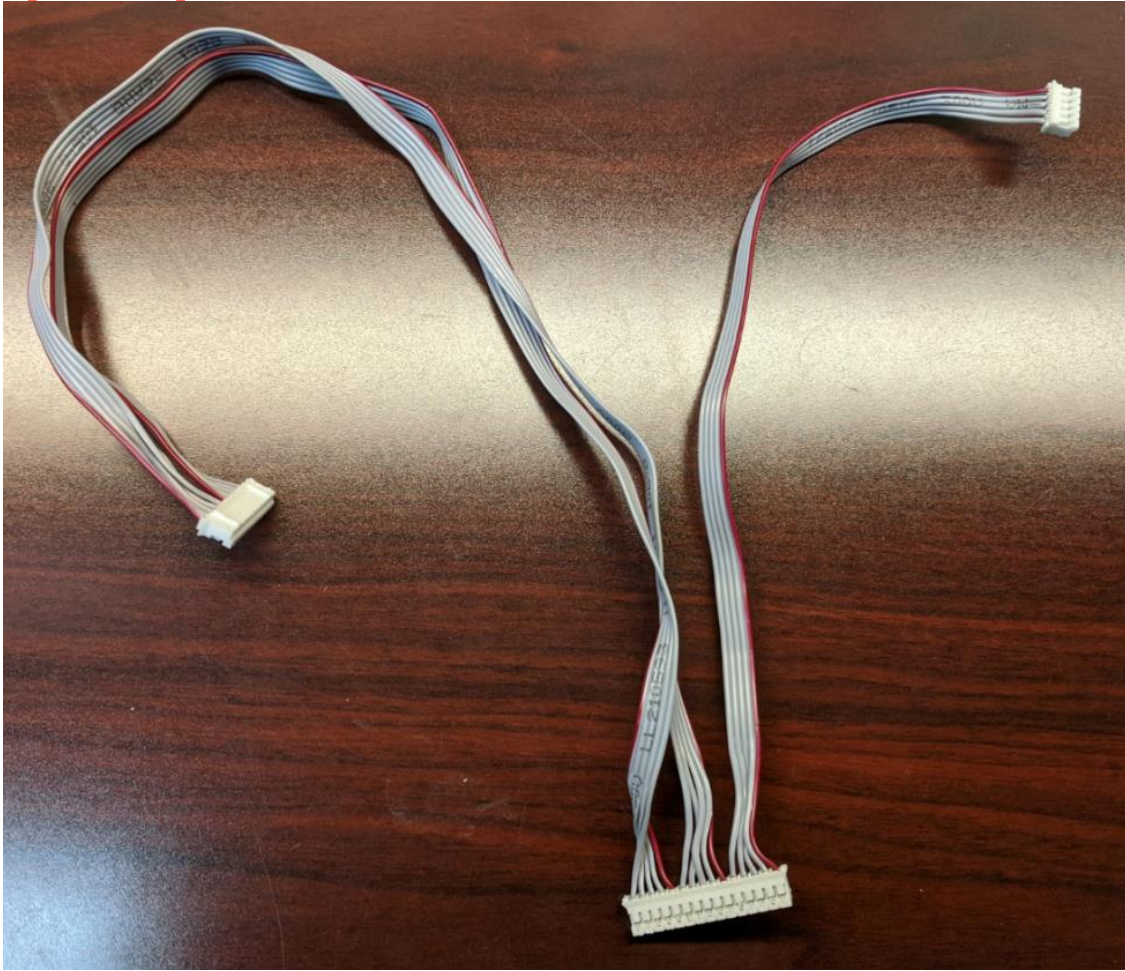
4. Ribbon Harness – 990374600 (ribbon assembly provided with 3 connectors – (1) 15pin, (1) 10pin & (1) 5pin)





 4421 Waterfront Drive Glen Allen, VA 23060	Revision	Production Release					Rev. Date:	
	Description:						Rev. Date:	
	Request #:	DOC11715	Page:	15 of 22	Document #:	540102300	Rev:	A

Parts & Accessories Diagram - Model HJE960-CE – Series E Industrial Relays

PROPRIETARY RIGHTS NOTICE This document and all information contained within it is the property of Hamilton Beach Brands, Inc. (HBB). It is confidential and proprietary and has been provided to you for a limited purpose. It must be returned or destroyed upon request. Disclosure, reproduction or use of this document and any information contained within it, in full or in part, for any purpose is forbidden without the prior written consent of HBB. No photographs may be taken of any article fabricated or assembled from this document without the prior written consent of HBB.

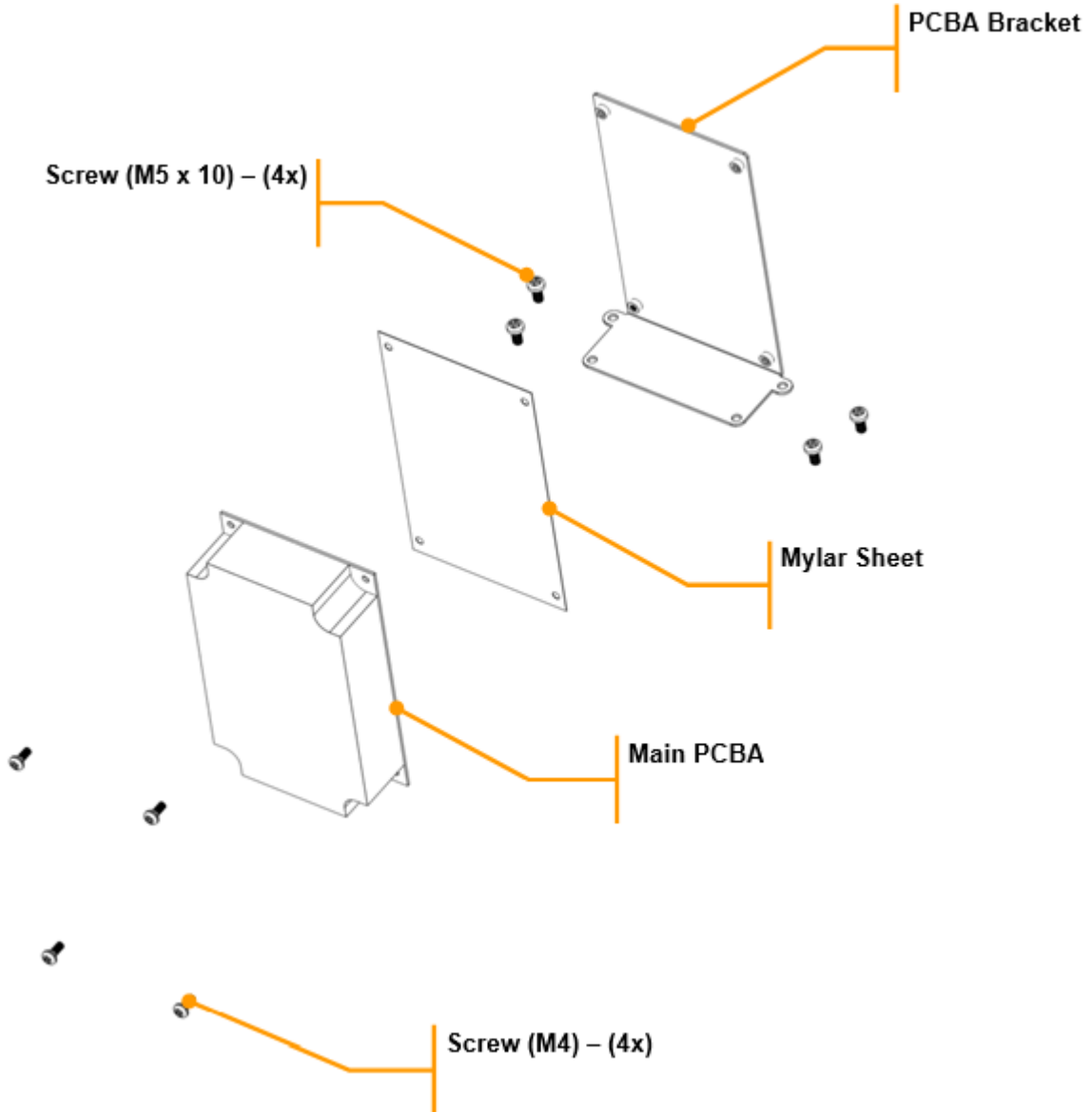
5. Main PCB Assembly – 990374000



 4421 Waterfront Drive Glen Allen, VA 23060	Revision Description:	Production Release				Rev. Date:
	Request #:	DOC11715	Page:	16 of 22	Document #:	540102300
					Rev:	A

Parts & Accessories Diagram - Model HJE960-CE – Series E Industrial Relays

PROPRIETARY RIGHTS NOTICE This document and all information contained within it is the property of Hamilton Beach Brands, Inc. (HBB). It is confidential and proprietary and has been provided to you for a limited purpose. It must be returned or destroyed upon request. Disclosure, reproduction or use of this document and any information contained within it, in full or in part, for any purpose is forbidden without the prior written consent of HBB. No photographs may be taken of any article fabricated or assembled from this document without the prior written consent of HBB.



Picture showing 220-240V Main PCB Assembly

 4421 Waterfront Drive Glen Allen, VA 23060	Revision Description:	Production Release				Rev. Date:
	Request #:	DOC11715	Page:	17 of 22	Document #:	540102300
						Rev: A

Parts & Accessories Diagram - Model HJE960-CE – Series E Industrial Relays

PROPRIETARY RIGHTS NOTICE This document and all information contained within it is the property of Hamilton Beach Brands, Inc. (HBB). It is confidential and proprietary and has been provided to you for a limited purpose. It must be returned or destroyed upon request. Disclosure, reproduction or use of this document and any information contained within it, in full or in part, for any purpose is forbidden without the prior written consent of HBB. No photographs may be taken of any article fabricated or assembled from this document without the prior written consent of HBB.

990274601 Cord Kit (230V) – Includes all components as pictured below



Strain Relief Grommet
990273600

 4421 Waterfront Drive Glen Allen, VA 23060	Revision	Production Release					Rev. Date:
	Description:						04/21/2021
	Request #:	DOC11715	Page:	18 of 22	Document #:	540102300	Rev: A

Parts & Accessories Diagram - Model **HJE960-CE** – Series E Industrial Relays

PROPRIETARY RIGHTS NOTICE This document and all information contained within it is the property of Hamilton Beach Brands, Inc. (HBB). It is confidential and proprietary and has been provided to you for a limited purpose. It must be returned or destroyed upon request. Disclosure, reproduction or use of this document and any information contained within it, in full or in part, for any purpose is forbidden without the prior written consent of HBB. No photographs may be taken of any article fabricated or assembled from this document without the prior written consent of HBB.

990272200 Clutch Kit – Includes all components as pictured below

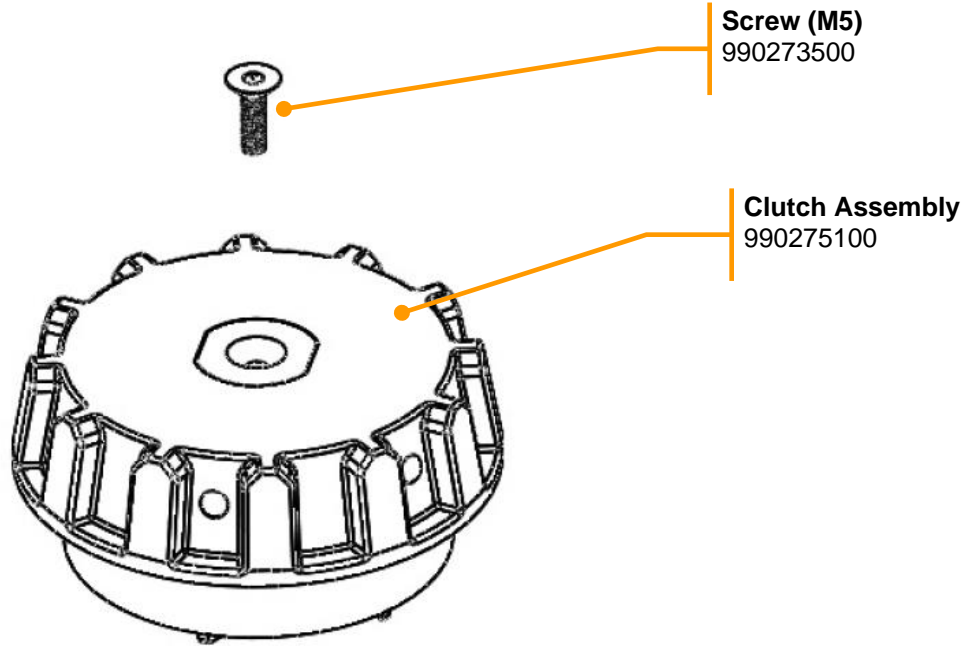

Accessories

UTC960 – Includes all components as pictured below

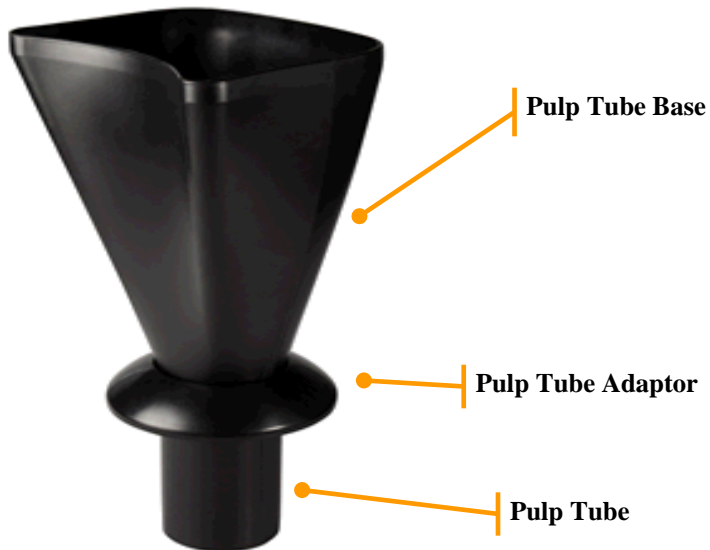

 4421 Waterfront Drive Glen Allen, VA 23060	Revision	Production Release					Rev. Date:
	Description:						04/21/2021
	Request #:	DOC11715	Page:	19 of 22	Document #:	540102300	Rev: A

Parts & Accessories Diagram - Model HJE960-CE – Series E Industrial Relays

PROPRIETARY RIGHTS NOTICE This document and all information contained within it is the property of Hamilton Beach Brands, Inc. (HBB). It is confidential and proprietary and has been provided to you for a limited purpose. It must be returned or destroyed upon request. Disclosure, reproduction or use of this document and any information contained within it, in full or in part, for any purpose is forbidden without the prior written consent of HBB. No photographs may be taken of any article fabricated or assembled from this document without the prior written consent of HBB.

Strainer Baskets:

SB960 for Normal “Wet” Foods

SB961 for Green Leafy Vegetables (i.e. Kale, Spinach, etc.)

SB960 (shown below)



Enlarged view of SB960 hole pattern

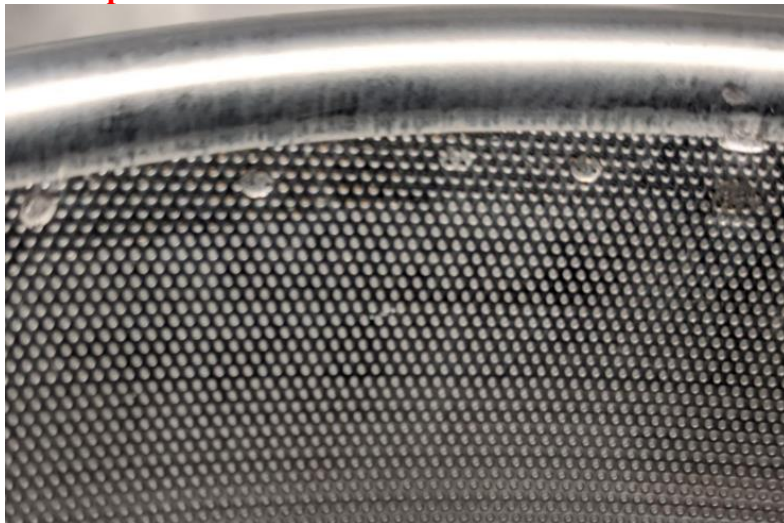

 4421 Waterfront Drive Glen Allen, VA 23060	Revision	Production Release					Rev. Date:
	Description:						04/21/2021
	Request #:	DOC11715	Page:	20 of 22	Document #:	540102300	Rev: A

Parts & Accessories Diagram - Model HJE960-CE – Series E Industrial Relays

PROPRIETARY RIGHTS NOTICE This document and all information contained within it is the property of Hamilton Beach Brands, Inc. (HBB). It is confidential and proprietary and has been provided to you for a limited purpose. It must be returned or destroyed upon request. Disclosure, reproduction or use of this document and any information contained within it, in full or in part, for any purpose is forbidden without the prior written consent of HBB. No photographs may be taken of any article fabricated or assembled from this document without the prior written consent of HBB.

SB961 (shown below)



Enlarged View of SB961 Hole Pattern





 4421 Waterfront Drive Glen Allen, VA 23060	Revision Description:	Production Release					Rev. Date:
	Request #:	DOC11715	Page:	21 of 22	Document #:	540102300	Rev: A

Parts & Accessories Diagram - Model HJE960-CE – Series E Industrial Relays

PROPRIETARY RIGHTS NOTICE This document and all information contained within it is the property of Hamilton Beach Brands, Inc. (HBB). It is confidential and proprietary and has been provided to you for a limited purpose. It must be returned or destroyed upon request. Disclosure, reproduction or use of this document and any information contained within it, in full or in part, for any purpose is forbidden without the prior written consent of HBB. No photographs may be taken of any article fabricated or assembled from this document without the prior written consent of HBB.

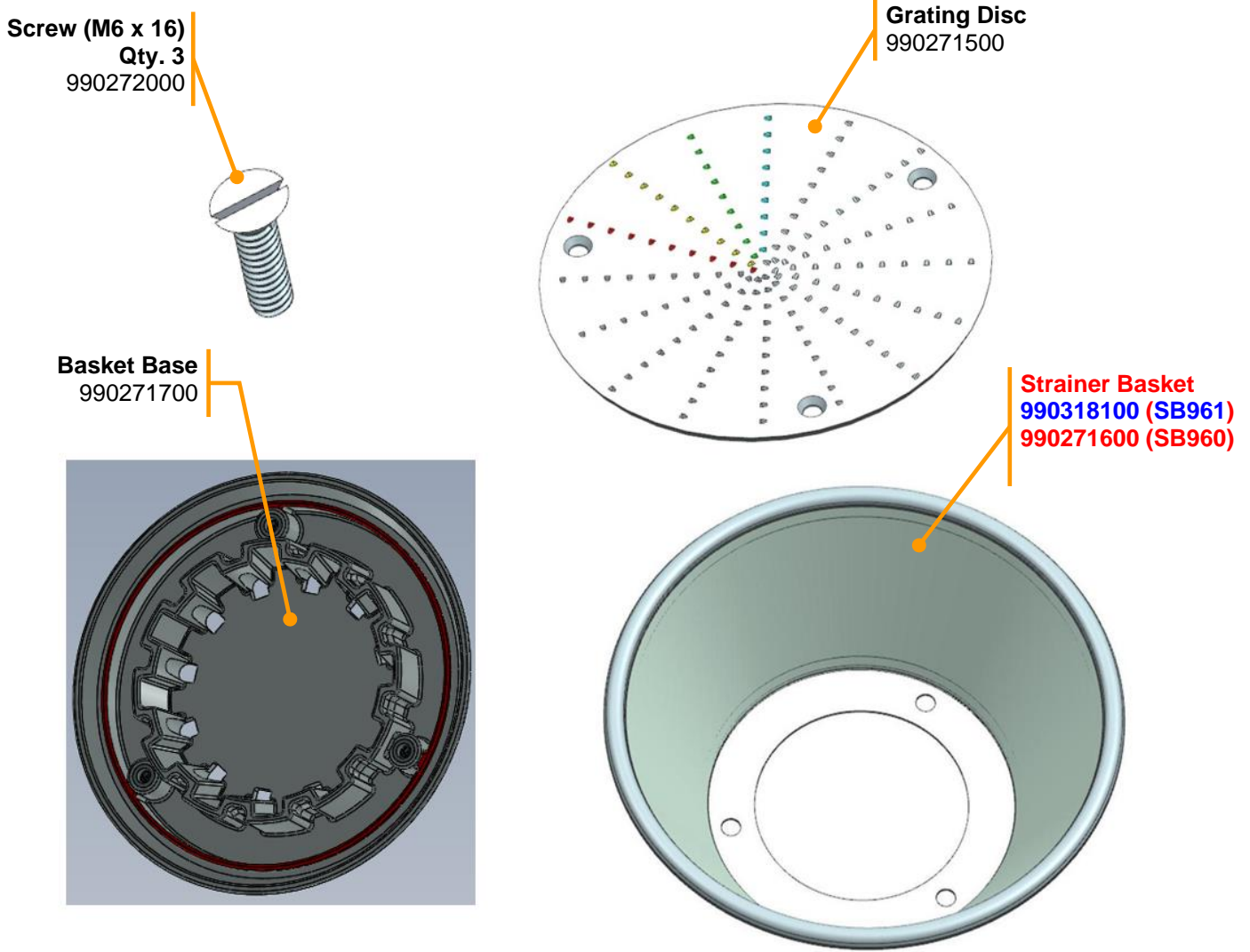
SB960 & SB961 Accessory Strainer Baskets – Parts Breakdown



 4421 Waterfront Drive Glen Allen, VA 23060	Revision	Production Release					Rev. Date:
	Description:						04/21/2021
	Request #:	DOC11715	Page:	22 of 22	Document #:	540102300	Rev: A