

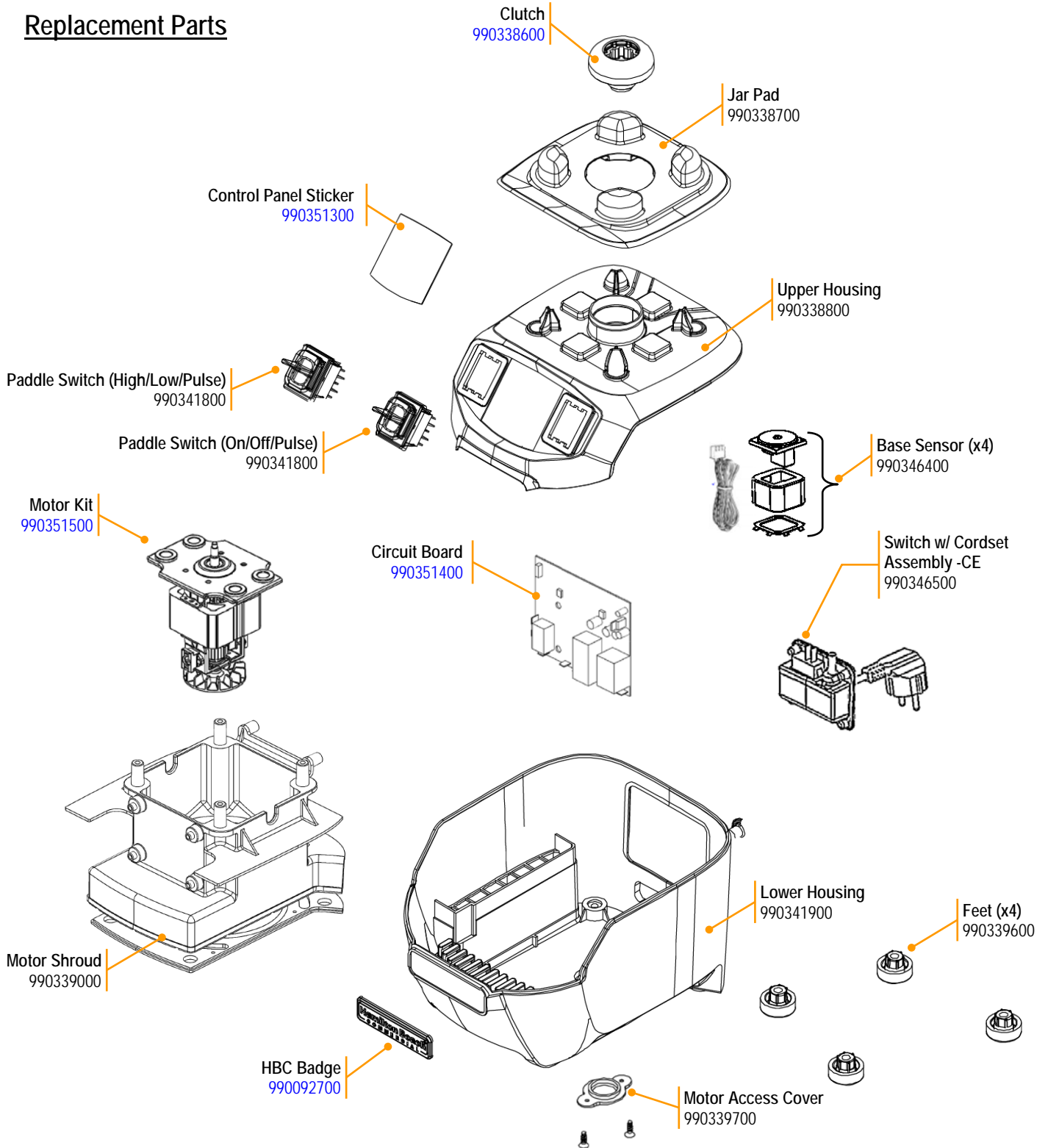

Parts & Accessories Diagram

PROPRIETARY RIGHTS NOTICE This document and all information contained within it is the property of Hamilton Beach Brands, Inc. (HBB). It is confidential and proprietary and has been provided to you for a limited purpose. It must be returned or destroyed upon request. Disclosure, reproduction or use of this document and any information contained within it, in full or in part, for any purpose is forbidden without the prior written consent of HBB. No photographs may be taken of any article fabricated or assembled from this document without the prior written consent of HBB.

Replacement Parts



 <p>Hamilton Beach 4421 Waterfront Drive Glen Allen, VA 23060</p>	Revision Description:	Production Release.					Rev. Date:
	Request #:	DOC10624	Page:	1 of 3	Document #:	540101001	2/21/2020
							Rev: A

Parts & Accessories Diagram

PROPRIETARY RIGHTS NOTICE This document and all information contained within it is the property of Hamilton Beach Brands, Inc. (HBB). It is confidential and proprietary and has been provided to you for a limited purpose. It must be returned or destroyed upon request. Disclosure, reproduction or use of this document and any information contained within it, in full or in part, for any purpose is forbidden without the prior written consent of HBB. No photographs may be taken of any article fabricated or assembled from this document without the prior written consent of HBB.

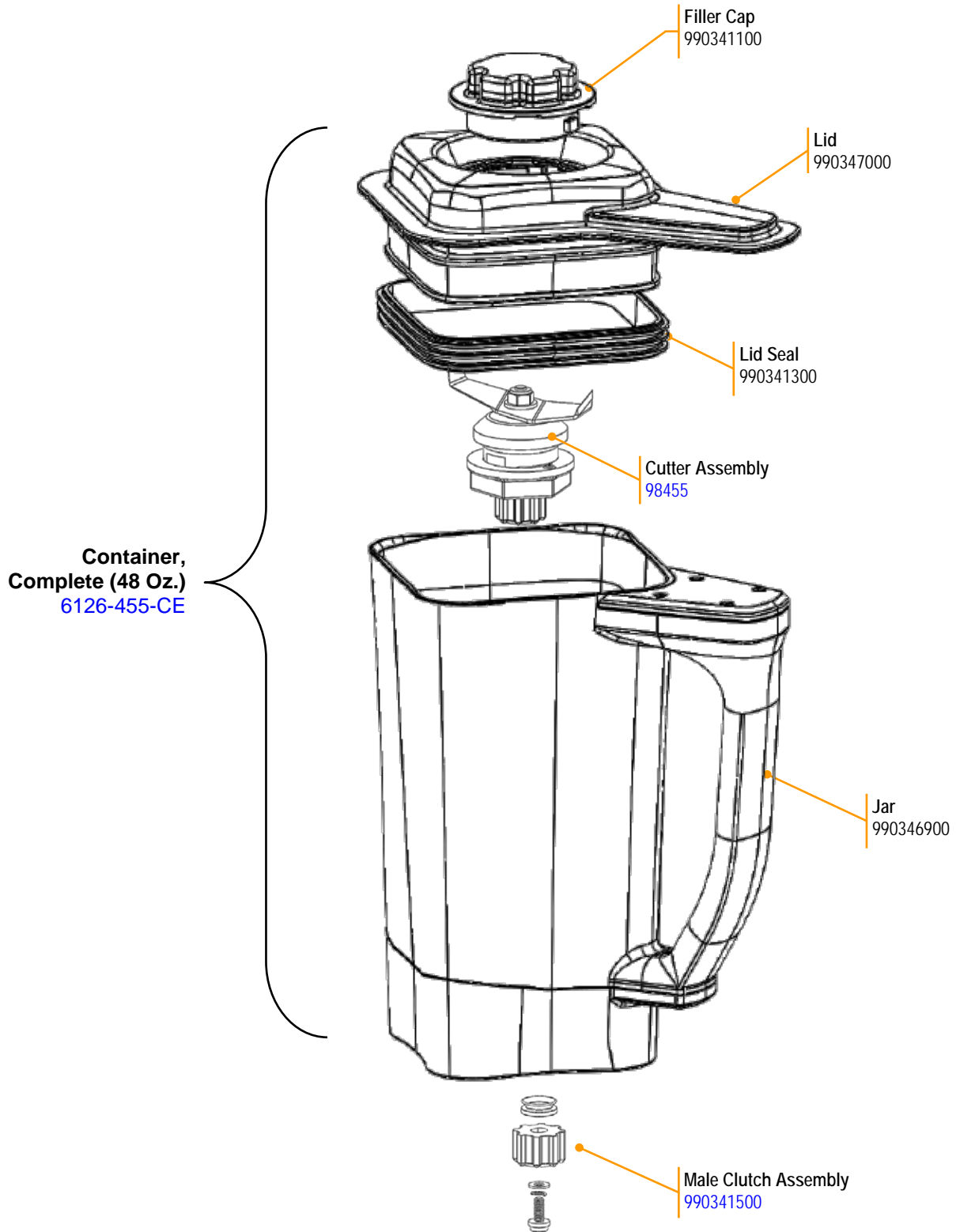



 4421 Waterfront Drive Glen Allen, VA 23060	Revision Description:	Production Release.					Rev. Date:
	Request #:	DOC10624	Page:	2 of 3	Document #:	540101001	Rev: A

Parts & Accessories Diagram

PROPRIETARY RIGHTS NOTICE This document and all information contained within it is the property of Hamilton Beach Brands, Inc. (HBB). It is confidential and proprietary and has been provided to you for a limited purpose. It must be returned or destroyed upon request. Disclosure, reproduction or use of this document and any information contained within it, in full or in part, for any purpose is forbidden without the prior written consent of HBB. No photographs may be taken of any article fabricated or assembled from this document without the prior written consent of HBB.

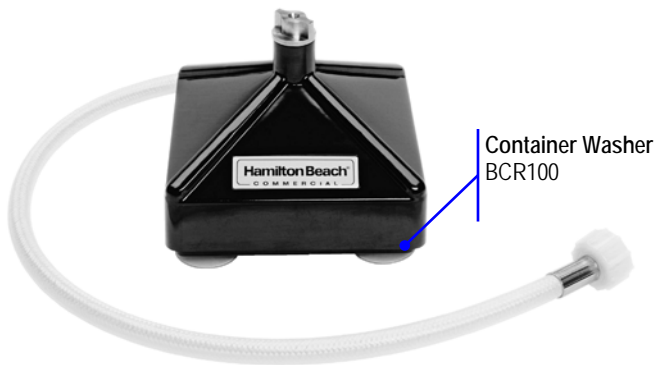
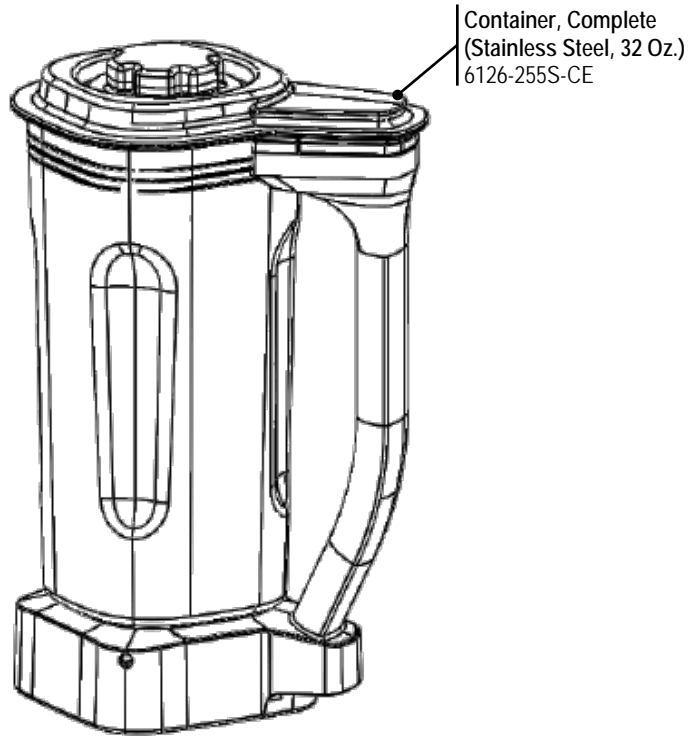
Accessories



 4421 Waterfront Drive Glen Allen, VA 23060	Revision	Production Release.					Rev. Date:	
	Description:						DOC10624	
	Request #:						Rev:	A