



Model 4913N



## OWNER & OPERATOR INSTRUCTION MANUAL

Model #: \_\_\_\_\_

Serial #: \_\_\_\_\_



Intertek



2010

# ARBY'S® SLICER MODEL 4913N

## For Service on Your Slicer

1. Visit our website at [www.globeslicers.com](http://www.globeslicers.com) (select the Parts / Support drop down).
2. Or call the Globe Service Department at 937-299-8625 and ask for contact information for your local service company.

## - IMPORTANT SAFETY NOTICE -

This manual contains important safety instructions which must be strictly followed when using this equipment.

Visit our website for information on additional products available from Globe.

[www.globeslicers.com](http://www.globeslicers.com)

*Slicers, Mixers, Countertop Cooking Equipment, Meat Choppers & Scales*

WARRANTY REGISTRATION  
SCAN THE QR CODE WITH YOUR MOBILE DEVICE OR GO TO  
[WWW.GLOBESLICERS.COM](http://WWW.GLOBESLICERS.COM) TO FILL OUT AND SUBMIT YOUR  
WARRANTY REGISTRATION.

<http://www.globeslicers.com/site/warranty.asp>





# Index

ATTENTION OWNERS AND OPERATORS.....	4
KEY COMPONENTS OF THE SLICER .....	5
GLOBE SLICER SAFETY TIPS .....	6
INSTALLATION AND PROPER GROUNDING .....	7-8
OPERATING INSTRUCTIONS.....	9-10
CLEANING .....	11-14
KNIFE SHARPENING .....	15-17
INSPECTIONS, SIMPLE MAINTENANCE, AND REPAIR .....	18-19
OPTIMAL SLICING PERFORMANCE .....	20
SERVICE AND TROUBLESHOOTING .....	21
NOTES .....	22-23
LIMITED WARRANTY .....	24



**GLOBE FOOD EQUIPMENT COMPANY**  
2153 DRYDEN RD  
DAYTON, OH 45439  
PHONE: 937-299-5493  
TOLL FREE: 800-347-5423  
FAX: 937-299-8623  
E-MAIL: [globeinfo@globeslicers.com](mailto:globeinfo@globeslicers.com)  
WEBSITE: [www.globeslicers.com](http://www.globeslicers.com)

# Attention Owners and Operators

Globe's equipment is designed to provide years of safe and productive processing of food products as long as the equipment is used in accordance with the instructions in this manual and is properly maintained. Importantly, unless the operator is adequately trained and supervised, there is a possibility of serious injury. Owners of this equipment bear the responsibility to make certain that this equipment is used properly and safely. Strictly follow all of the instructions contained in this manual and the requirements of local, state and federal law.

Owners should not permit anyone to touch this equipment unless they are over 18 years of age, are adequately trained and supervised, and have read and understand this manual. Owners should also ensure that no customers, visitors or other unauthorized personnel come in contact with this equipment. Please remember that Globe cannot anticipate every circumstance or environment in which its equipment will be operated. It is the responsibility of the owner and the operator to remain alert to any hazards posed by the function of this equipment, particularly the sharp knife blade and all moving parts. If you are ever uncertain about a particular task or the proper method of operating this equipment, ask your supervisor.

To prevent illness caused by the spread of food-borne pathogens, it is important to properly clean and sanitize the entire slicer as any surface of the slicer can become contaminated. It is the responsibility of the slicer owner/operator to follow all guidelines, instructions and laws as established by your local and state health departments and the manufacturers of chemical sanitizers.

When cleaning your slicer, pay particular attention to cracks, broken seams and any area that may collect food debris. If your slicer, or any of its parts, are damaged or broken, it may become more difficult to properly clean and sanitize the unit. If your slicer is damaged or needs repair, contact an experienced service individual immediately to ensure the slicer can be properly sanitized. If you have any questions, please contact Globe at 937-299-5493.

This manual offers information to supplement your procedures to improve the sanitization of your machine and contains safety tips including a number of precautions to follow to help promote safe use of this equipment. Throughout the manual you will see additional warnings to help alert you to potential hazards.

**Warnings affecting your personal safety are indicated by:**



**Warnings related to possible damage to the equipment are indicated by:**



A wall chart with safety instructions is included with this equipment. This wall chart should be posted near the slicer within easy view of the operator. You should make certain that this manual is available for easy reference by any operator. Globe has put several warning labels in the English language on its slicers. Spanish labels are also available and can replace the English labels at the owner's discretion. If the warning labels, the wall chart, or this manual are misplaced, damaged or illegible, or if you require additional copies, please contact your nearest representative or contact Globe directly at 937-299-5493 to order replacement parts at no charge.

Please remember that this manual, the wall chart and the warning labels do not replace the need to be alert, to properly train and supervise operators, and to use common sense when using this equipment.

# Key Components of the Slicer

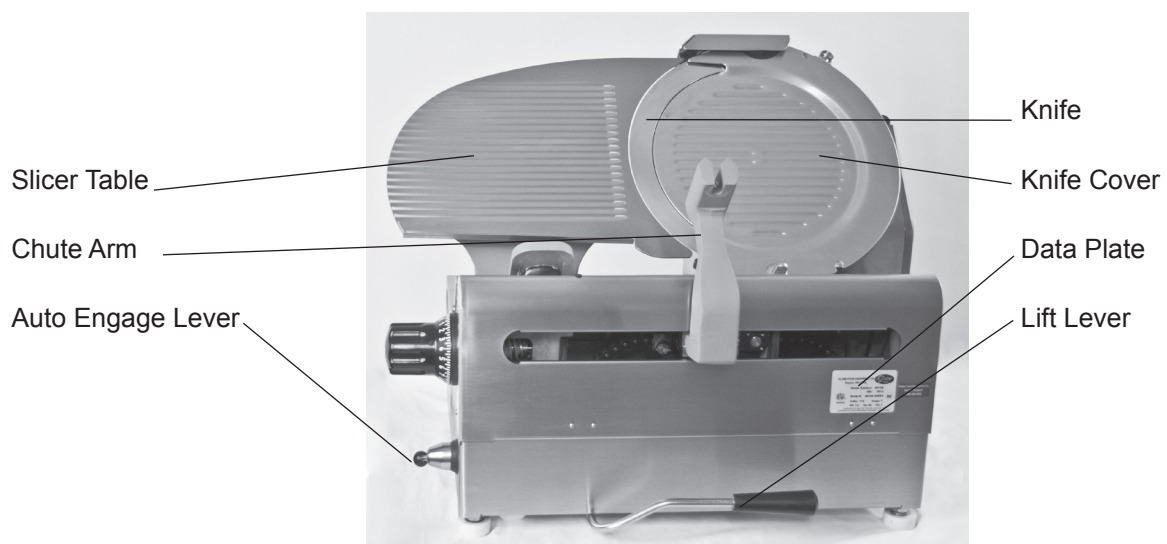
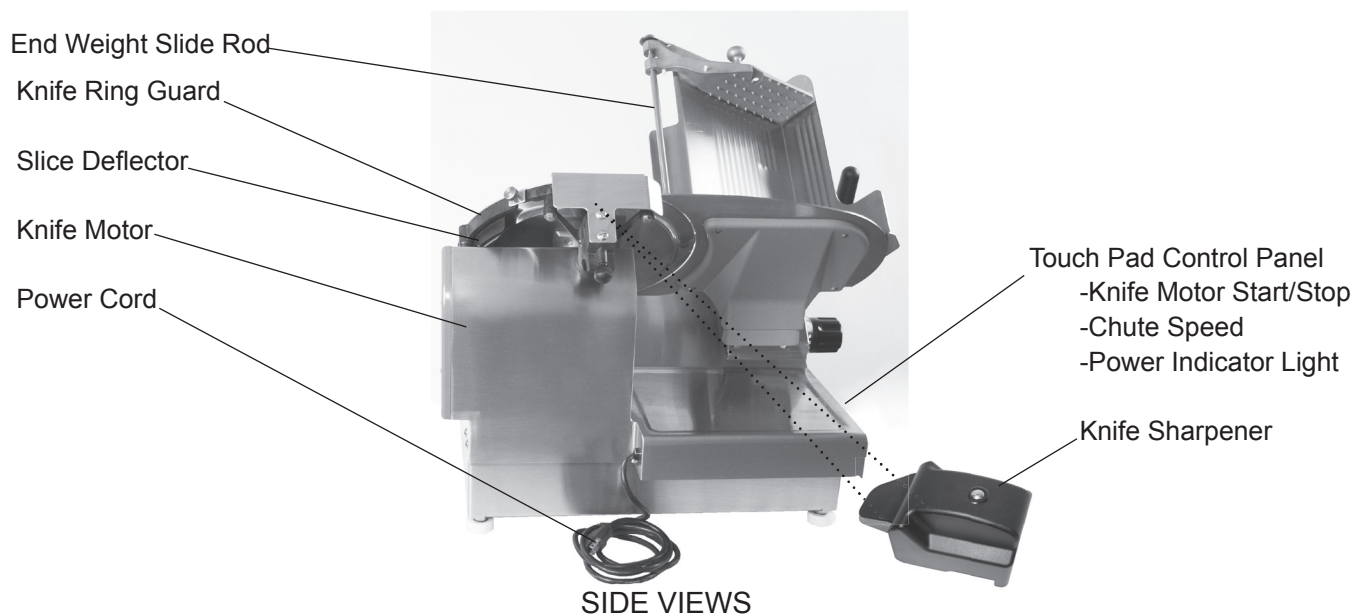
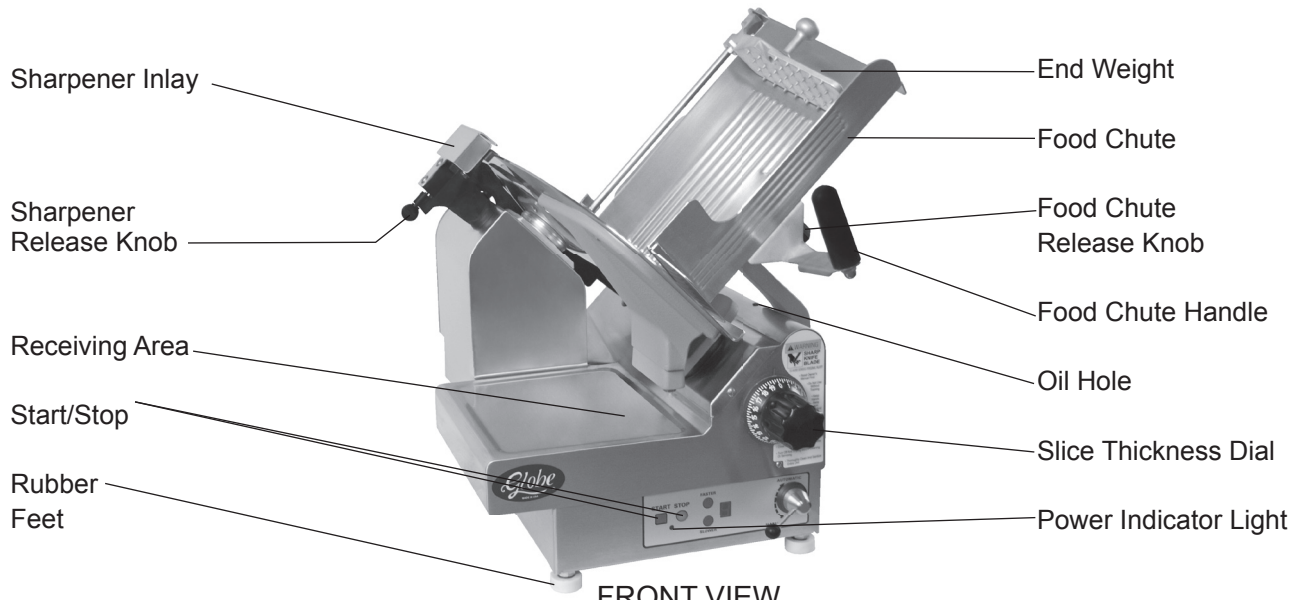

# Globe Slicer Safety Tips

## **WARNING**



## SHARP KNIFE BLADE

### TO AVOID SERIOUS PERSONAL INJURY:

- **READ THIS ENTIRE INSTRUCTION MANUAL FIRST.**
- **NEVER** touch this slicer without training and authorization from your supervisor.
- **NEVER** touch this slicer if you are under 18 years of age.
- **ONLY** install the slicer on a level, nonskid surface that is nonflammable and is located in a clean, well-lighted work area away from children and visitors.
- **ALWAYS** ground slicer utilizing proper power source.
- **NEVER TOUCH KNIFE.** Keep hands and arms away from all moving parts.
- **NEVER OPERATE** slicer without knife cover, knife inlay, and knife ring guard securely installed.
- **BE ALERT.** The food chute moves back and forth during automatic operation and can move in either direction on start up.
- **USE ONLY THE END WEIGHT HANDLE OR THE FOOD CHUTE HANDLE** to push the food chute during manual slicing.
- **NEVER** hold the food product with your hand while slicing.
- **DO NOT CATCH SLICES WITH YOUR HAND.** Let slices drop onto the receiving area.
- After each use **ALWAYS** turn slicer off. Turn the slice thickness dial clockwise past zero "0" until it stops.
- **BEFORE CLEANING, SHARPENING, SERVICING OR REMOVING ANY PARTS,** always turn slicer off, turn the slice thickness dial clockwise past zero (0) until it stops, remove the food chute and unplug the power cord.
- **ALWAYS wear stainless steel mesh safety gloves and single-use gloves** during disassembly, cleaning and sanitizing, reassembly, and sharpening of the slicer.
- **ALWAYS properly clean and sanitize your slicer.** To prevent illness or death caused by the spread of food-borne pathogens, it is important to properly clean and sanitize the entire slicer as any surface of the slicer can become contaminated. It is the responsibility of the slicer owner/operator to follow all guidelines, instructions and laws as established by your local and state health departments and the manufacturers of chemical sanitizers.
- **USE ONLY PROPERLY INSTALLED GLOBE SLICER ACCESSORIES.**

# Installation and Proper Grounding

## **UNPACKING:**

1. Unpack the slicer immediately after receipt. If the machine is found to be damaged, save the packaging material and contact the carrier within fifteen (15) days of delivery and immediately contact your source of the equipment. **You have no recourse for damage after fifteen (15) days of receipt.**
2. With the slicer you should receive: A knife sharpener, sharpener basket, a bottle of Globe oil, a wall chart, an instruction manual and within the manual, instructions to register your product warranty at [www.globeslicers.com](http://www.globeslicers.com). Contact Globe, or your local supplier, if you did not receive all of these items.



### **TO AVOID SERIOUS PERSONAL INJURY PROPERLY INSTALL SLICER IN ADEQUATE WORK AREA**

- **ALWAYS** install equipment in a work area with adequate light and space.
- **ONLY** operate the slicer on a solid, level, nonskid surface that is nonflammable.
- **NEVER** bypass, alter, or modify this equipment in any way from its original condition. Doing so may create hazards and will void the warranty.
- **NEVER** operate the slicer without knife cover and knife ring guard securely installed.
- **NEVER** operate the slicer without all warning labels attached and the Globe wall chart posted.

## **INSTALLATION:**

1. Read this manual thoroughly before installation and operation. **DO NOT** proceed with installation and operation if you have any questions or if you do not understand anything in the manual. Contact your local representative or Globe **first**. ***Make sure to clean and sanitize your entire slicer before use. Refer to this manual for cleaning and sanitizing guidelines.***
2. Remove the slicer from the corrugated box.



**NEVER USE SLICER WITHOUT RUBBER FEET INSTALLED.**

3. Select a location for the slicer that has a level, solid, nonskid surface that is nonflammable and is in a well-lit work area away from children and visitors.



**USE AT LEAST TWO PEOPLE TO LIFT SLICER UP TO OPERATING LOCATION.  
NEVER ATTEMPT TO LIFT SLICER ALONE.**

4. Make sure the slicer is level. If the slicer wobbles or rocks once it has been placed on the table or counter, adjust the rubber feet until the slicer is level.
5. Post Globe's wall chart in a location within easy view of operator.
6. Inspect slicer to ensure all parts have been provided.
7. Make sure knife ring guard, slice deflector, knife cover and sharpener inlay are in place.
8. Locate the slicer's sharpener packaged in its own box. The 4913N slicer sharpener is to be maintained in a manager's location/possession until it is needed for use. After slicer sharpening, the sharpener is to be cleaned, sanitized and returned to management until it is needed. Once the sharpener is removed, the knife is exposed and the sharpener inlay is to be placed back on the unit before use. Refer to the Knife Sharpening section of this manual for further details.

# Installation and Proper Grounding

9. Locate the sharpener basket. Affix the sharpener basket in the desired location. NOTE: The slicer sharpener is to be returned to this basket after use only after it has been cleaned and sanitized.



**GROUNDING PLUG. THE OUTLET TO WHICH THIS PLUG IS CONNECTED MUST BE PROPERLY GROUNDED. IF THE RECEPTACLE IS NOT THE PROPER GROUNDING TYPE, CONTACT AN ELECTRICIAN. DO NOT, UNDER ANY CIRCUMSTANCES, CUT OR REMOVE THE THIRD GROUND PRONG FROM THE POWER CORD OR USE ANY ADAPTER PLUG (Fig. 8-1 and Fig. 8-2).**

10. Make sure warning labels are properly positioned and legible and the instruction manual is available near the slicer. Place the Spanish labels on the slicer if your work force requires them.
11. Complete the warranty registration online at [www.globeslicers.com/warranty.asp](http://www.globeslicers.com/warranty.asp).
12. Post the provided wall chart in a visible area near the slicer to be referred to often for cleaning, sanitizing, and inspecting your slicer. Refer to the wall chart and this Owner's Manual for proper cleaning, sanitizing and inspection of your slicer.
12. Clean the slicer using the procedures outlined in the cleaning section (pages 11 through 14) prior to using the slicer.
13. Contact your local representative, or Globe directly, if you have any questions or problems with the installation or operation of this slicer.

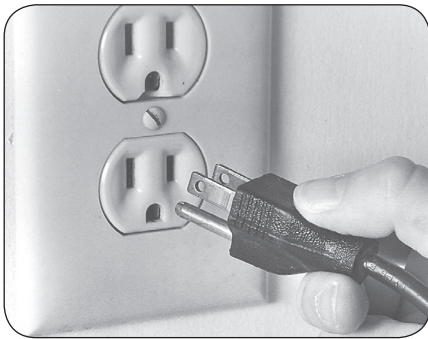

Figure 8-1 Correct

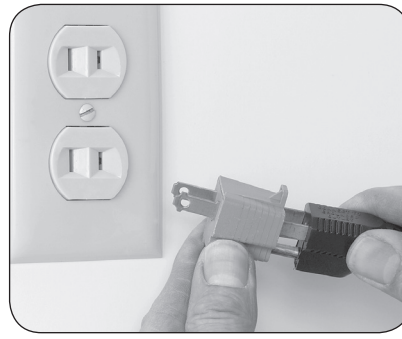

Figure 8-2 Incorrect

# Operating Instructions

## **WARNING**



## **SHARP KNIFE BLADE** **TO AVOID SERIOUS PERSONAL INJURY:**

- **NEVER** touch this slicer without training and authorization from your supervisor. Read this instruction manual first.
- **NEVER** touch this slicer if you are under 18 years of age.
- **NEVER TOUCH KNIFE.** Keep hands and arms away from all moving parts.
- **NEVER OPERATE** slicer without knife cover and knife ring guard securely installed.
- **BE ALERT.** The food chute moves back and forth during automatic operation and can move in either direction on start up.
- **USE ONLY THE END WEIGHT HANDLE OR THE FOOD CHUTE HANDLE** to push the food chute during manual slicing.
- **NEVER** hold the food product with your hand while slicing.
- **DO NOT CATCH SLICES WITH YOUR HAND.** Let slices drop onto the receiving area.
- After each use **ALWAYS** turn slicer off. Return auto engage lever to the “Manual” position. Turn the slice thickness dial clockwise past zero “0” until it stops.
- **ALWAYS wear stainless steel mesh safety gloves and single-use gloves** during disassembly, cleaning and sanitizing, reassembly, and sharpening of the slicer.
- **BEFORE CLEANING, SHARPENING, SERVICING, OR REMOVING ANY PARTS,** always turn slicer off, turn the slice thickness dial clockwise past zero “0” until it stops, unplug the power cord, and remove the food chute.

### **MANUAL USE OF AUTOMATIC SLICER** *(for slicing ham, turkey, tomatoes, & onions ONLY)*

1. Automatic slicers can be used manually when slicing any of the items listed above (NOT for beef).
2. When manually operating an automatic slicer, the auto engage lever **MUST** be in the “Manual” position before turning the slicer on. The lever should not be moved out of the “Manual” position at any time during use.
3. Pull the food chute completely towards you.
4. Turn the slicer on by pressing the start button.  
**NOTE:** If the slicer does not start and there is a flashing 4, the food chute is not in the home position. Pull the food chute completely towards you and restart the slicer.

**NOTE:** If the slicer does not start and there is a flashing 2, the knife cover is not on or is on incorrectly. Make sure the knife cover is securely in place and restart the slicer.

# Operating Instructions

## AUTOMATIC SLICER OPERATION



**Automatic slicer operation: NEVER put hand into food chute opening. Keep hands and arms away from all moving parts.**

1. Pull the food chute completely towards you to load the product onto the chute. Move the end weight up to its resting position. Note: The pin on the end weight goes into the hole on the food chute.
2. Place the product onto the food chute and then set the end weight against the product.
3. Rotate the slice thickness dial counter clockwise to the desired setting. If you happen to go past the desired setting, you must first rotate the slice thickness dial clockwise past zero "0" and then rotate the dial back to the desired slice thickness setting. After slicing is complete, always turn the slice thickness dial clockwise past zero "0" until it stops to close the slicer table.
4. Make sure the auto engage lever is in the "Automatic" position.



**BE ALERT. The next step will cause the food chute to move automatically and it can move either direction on start up.**



**NEVER attempt to adjust, load or unload food chute when slicer is in automatic operation.**

5. Press the start button. The power indicator light will illuminate.

**NOTE:** If the slicer does not start and there is a flashing 4, the food chute is not in the home position. Pull the food chute completely towards you and restart the slicer.

**NOTE:** If the slicer does not start and there is a flashing 2, the knife cover is not on or is on incorrectly. Make sure the knife cover is securely in place and restart the slicer.

6. To adjust the chute speed, press the slower or faster buttons. The slicer defaults to speed 5 when the power cord is unplugged and plugged back in. If the slicer is turned off but not unplugged, it will return to the last speed used.
7. When slicing is complete, press the stop button. The food chute will return to the home position.

8. Turn the slice thickness dial clockwise past zero until it stops. Note: The dial will bounce back some. Make sure the food chute is completely towards the operator.

9. Remove the product from the food chute.

For your safety, when changing product, turn the slicer off, make sure the food chute is in the home position and close the slicer table.

### AUTOMATIC SPEED SETTINGS

<u>Model #</u>	<u>Chute Speed Setting</u>	<u>Strokes Per Minute</u>
4913N	1	20
	2	28
	3	32
	4	38
	5	40
	6	50
	7	52
	8	58
	9	60

Note: Strokes per minute may vary +/- 10%.

# Cleaning & Sanitizing

## WARNING





## SHARP KNIFE BLADE

**TO AVOID SERIOUS PERSONAL INJURY TO THE SLICER OPERATOR AND YOUR CUSTOMERS:**

- **ALWAYS** wear stainless steel mesh safety gloves and single-use gloves during disassembly, cleaning and sanitizing, reassembly, and sharpening of the slicer.
- **BEFORE CLEANING, SHARPENING, SERVICING OR REMOVING ANY PARTS**, always turn slicer off, turn the slice thickness dial clockwise until it stops, and unplug the power cord.
- **NEVER** attempt to clean slicer with the knife running.
- **NEVER** attempt to remove the knife or knife ring guard from the slicer. They must remain on the slicer for proper operation, sharpening, and cleaning.

** WARNING** To prevent illness or death caused by the spread of food-borne pathogens, it is important to properly clean and sanitize the entire slicer as any surface of the slicer can become contaminated. It is the responsibility of the slicer owner/operator to follow all guidelines, instructions and laws as established by your local and state health departments and the manufacturers of chemical sanitizers.

** Once your slicer makes contact with food product, the entire slicer, including removable parts, must be thoroughly cleaned and sanitized. This process is to be repeated at least every 4 hours using these procedures and information; and must comply with additional laws from your state and local health departments.**

** As with all food contact surfaces, it is extremely important to properly sanitize the entire slicer and to closely follow the instructions on your quaternary sanitizer container to ensure proper sanitation is achieved to kill potentially harmful bacteria.**

** Arby's® policy requires that all associates must wear stainless steel mesh safety gloves and single-use gloves during disassembly, cleaning and sanitizing, reassembly, and sharpening of the slicer.**

**IMPORTANT: If a chemical sanitizer other than chlorine, iodine or quaternary ammonium is used, it shall be applied in accordance with the EPA-registered label use instructions.** Excessive amounts of sanitizer and use of products not formulated for stainless steel or aluminum may VOID your warranty.

Sanitizer concentration shall comply with section 4-501.114, Manual and Mechanical Warewashing Equipment, Chemical Sanitization - Temperature, pH, Concentration, and Hardness of the FDA Food Code.

**For more information on proper kitchen and equipment sanitation, visit [www.servsafe.com](http://www.servsafe.com) provided by the National Restaurant Association (NRA).**

## CAUTION

- **DO NOT** hose down, pressure wash, or pour water on the slicer.
- **NEVER** use a scrubber pad, steel wool, or abrasive material to clean the slicer.
- **NEVER** try to clean, sharpen, or operate the slicer with the lift lever in the raised position.
- **ALWAYS** turn slicer OFF and unplug the power cord BEFORE cleaning.
- It is extremely important to follow the instructions on the sanitizer container to ensure proper sanitation is achieved. **Allow the parts to air dry before placing them back on the slicer!**

# Cleaning & Sanitizing

## DISASSEMBLY & CLEANING

**ALWAYS wear stainless steel mesh safety gloves and single-use gloves** during disassembly, cleaning and sanitizing, reassembly, and sharpening of the slicer.

1. Turn slicer off.
2. Turn slice thickness dial clockwise past zero (0) until it stops so the table covers the knife edge.
3. Unplug the power cord.
4. With a clean cloth, wipe off the slicer to remove liquids and food particles.
5. Remove the food chute's end weight. Hold the end weight and unscrew the slide rod (Fig. 12-1). Pull the slide rod out of the end weight, releasing both the rod and the end weight (Fig 12-2).
6. Remove the food chute by loosening the food chute release knob that fastens the food chute to the chute arm.



Figure 12-1



Figure 12-2

**BE ALERT.** The next steps will expose the knife.

7. Remove the sharpener inlay by loosening the sharpener release knob located on the sharpener neck. Lift and remove the sharpener inlay off of the slicer and place it off to the side of the slicer (Fig. 12-3).
8. Remove the knife cover. Unscrew the knob on top of the knife cover. Hold the knife cover at the tabs, located on the top and bottom of the knife cover (Fig. 12-4A). Carefully rock the knife cover away from the bottom pin and pull the cover away from the knife (Fig. 12-4B).

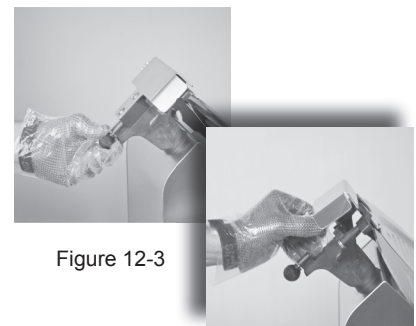

Figure 12-3

**BE ALERT.** The slicer knife edge is exposed. Always be aware of the placement of your hands/fingers in relationship to the knife.

9. Attached to the ring guard is a removable, flexible slice deflector. At the center of the ring guard is a locking tab (Fig. 12-5). Carefully pull the bottom of the tab outward with two fingers while securing the top of the tab, in place, with your thumb.

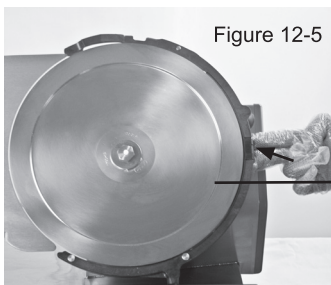

Figure 12-5

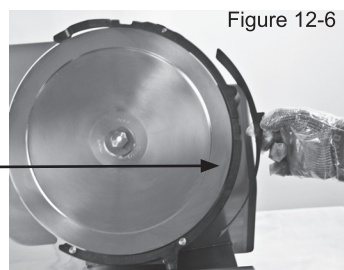

Figure 12-6

10. Carefully lift the slice deflector from between the knife and the ring guard (Fig 12-6).
11. Place all removable parts in a three compartment sink with warm water and mild detergent solution; soak, clean, and thoroughly scrub all surfaces using a solution of mild detergent and warm water. (Removable parts include: food chute, end weight, slide rod, knife cover, and slice deflector.) Clean and sanitize the attached sharpener inlay.

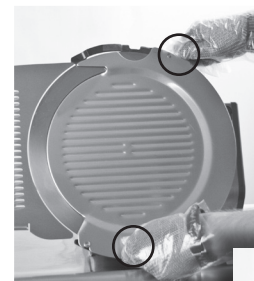

Figure 12-4A

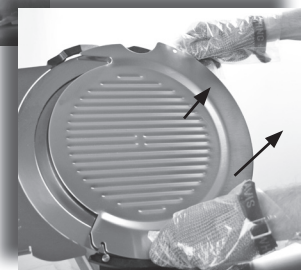

Figure 12-4B

**An important step to kill bacteria is to allow the parts to air dry before reinstalling!**

Continues ---

# Cleaning & Sanitizing

Rinse removable parts with fresh, clean water. Following the instructions on your Arby's approved quaternary sanitizer label, soak the food chute, knife cover, and slice deflector in a proper solution of quaternary sanitizer for a minimum of two minutes. Allow these parts to air dry.

12. Next, clean and sanitize the knife ring guard. Insert a nylon brush into a mild detergent and warm water solution. Work the brush along the outer edge of the knife (Fig. 13-1). Also work the brush along the entire back side of the knife. Repeat both procedures using a nylon brush inserted into the Arby's® specified sanitizer.
13. Clean, wash, and rinse both the inlay and the attached lanyard with Arby's approved slicer cleaner. Let air dry. Sanitize sharpener inlay and the attached lanyard with approved Arby's sanitizer.
14. The knife must also be cleaned and sanitized. **Carefully** wash and rinse the top and bottom of the knife by wiping from the center of the knife outward with Arby's approved slicer cleaner (Fig. 13-2).
15. Spray both sides of the knife, slicer table, entire slicer base, the sharpener inlay and attached lanyard with the Arby's approved quaternary sanitizer following the instructions on the container to ensure proper sanitation is achieved. Allow the slicer parts to air dry.



Figure 13-1



Figure 13-2

**CAUTION** An important step to kill bacteria is to allow the parts to air dry before reassembly!

**DO NOT** allow moisture to get into knife hub.

After cleaning and sanitizing the knife, the rest of the entire slicer must be fully cleaned, sanitized and left to air dry before reattaching slicer parts and using the slicer.

**BE ALERT.** The slicer knife is fully exposed. Always be aware of the placement of your hands/fingers in relationship to the knife.

16. Soak a clean cloth in a mild detergent and warm water solution. Ring out excess water from cloth. With the slicer table completely closed, wipe the slicer table off by starting at the knife and pulling towards you. Never wipe the slicer table towards the knife. Spray or wipe the approved Arby's sanitizer on the table and allow it to air dry.
17. With a clean cloth soaked in mild detergent, wipe down all remaining surfaces of the slicer to remove any food, debris and grease/oil. Use a nylon brush to scrub difficult areas. Use a clean wet cloth to rinse the entire slicer. Finish by spraying sanitizer on all surfaces and then let air dry.
18. Arby's® automatic slicers have a lift lever that raises the slicer to allow cleaning underneath.
  - a. With the auto engage lever in the "Manual" position, push the chute arm to the back of the slicer.
  - b. Pull the lift lever knob towards you with your right hand while gently lifting up on the slice thickness dial with the other (Fig. 13-3).
  - c. Pull the lift lever all the way towards you until it stops.
19. After cleaning the counter area under the slicer, lower the slicer back to its operating position.

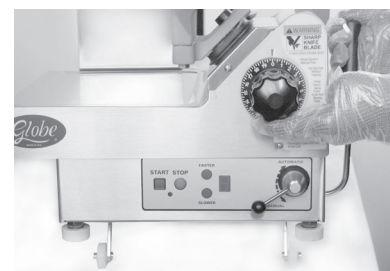

Figure 13-3

# Cleaning & Sanitizing

## **REINSTALL REMOVABLE PARTS**

Arby's® policy requires that all associates **must** wear non-cutting safety gloves and single-use gloves during the cleaning operation.

After cleaning, sanitizing, and allowing the parts to air dry, they must be reinstalled.

**⚠ BE ALERT.** The slicer knife is exposed. Always be aware of the placement of your hands/fingers in relationship to the knife.

1. **Carefully** insert the slice deflector into place between the knife and the ring guard (Fig 14-1). Align the tab over the lock notch and, with two fingers, press the tab over the lock notch (Fig 14-2). You will hear it “click” when it has securely locked into place. (Note: if the slice deflector does not securely “click” into place, the slice deflector is not properly reinstalled. **Do not** operate the slicer unless the slice deflector has been properly installed.)
2. Reinstall the knife cover by aligning the notches of the knife cover with the pins located at the bottom and one at the top of the knife ring guard (Fig 14-3). The locator pin at the top of the knife ring guard must be set through the knife cover and pressed into place. Once the locator pin is seated over the pin, screw the knife cover knob back into place on the top of the slicer.  
Note: The slicer will not operate unless the knife cover is secured in place.
3. Reinstall the clean, dry sharpener inlay. Attach it (Fig 14-4) back into its home position on top of the slicer and then tighten the sharpener release knob located underneath the sharpening compartment.
4. Place the cleaned and sanitized food chute back onto the chute arm. Securely tighten the food chute release knob to prevent any “play” between the food chute and the chute arm.
5. Reinstall the end weight. Align the end weight with the chute and insert the slide rod through the chute and end weight's pivot point (Fig 14-5). Allow the end weight to rest in the locked position and securely screw in the slide rod to the slicer chute (Fig 14-6).



Figure 14-1

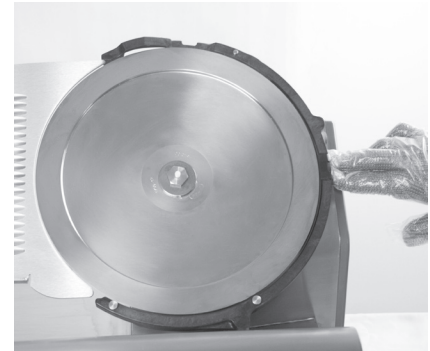

Figure 14-2



Figure 14-3



Figure 14-5



Figure 14-6

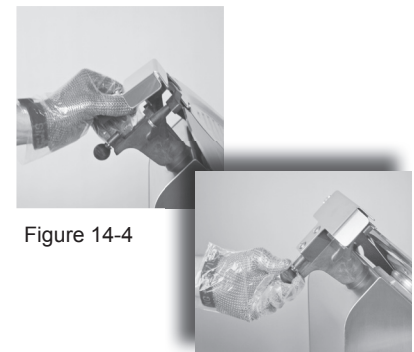

Figure 14-4

6. Plug in the power cord.

## **INSPECTION**

INSPECTING THE SLICER FOR DAMAGED OR BROKEN PARTS INCLUDING GASKETS & SEALS. A thorough visual inspection should be made of the entire slicer and its parts. Globe urges the owner/operator to inspect all components often and for an authorized service agent to inspect the entire slicer at least every 6 months, including all parts that are detachable for cleaning and sanitizing. This inspection should include: looking for damaged parts, broken seals or gaskets, and areas that may be more difficult to clean and sanitize.

## **⚠ WARNING**

IF A SEAL OR GASKET IS FOUND TO NOT PROPERLY SEAL, IS DAMAGED, OR IS MISSING, THE SLICER MUST BE REMOVED FROM SERVICE UNTIL IT IS REPAIRED BY AN AUTHORIZED SERVICER.

# Knife Sharpening, Sharpener Cleaning & Sanitizing

**⚠️ WARNING**



## SHARP KNIFE BLADE

### TO AVOID SERIOUS PERSONAL INJURY:

Arby's® policy requires that all associates **must** wear non-cutting safety gloves and single-use gloves during the cleaning operation

- **NEVER** touch rotating knife.
- **ALWAYS** keep hands clear of all moving parts.
- **ALWAYS** turn slicer off, return auto engage lever to the “Manual” position (automatic slicers only), turn slice thickness dial clockwise past zero “0” until it stops, and remove the food chute before sharpening.
- **NEVER** sharpen slicer unless all guards are installed.
- **ALWAYS** make sure the food chute is removed and the auto engage lever is in the “Manual” position when sharpening automatic slicers.

### WHEN AND HOW OFTEN TO SHARPEN THE KNIFE

1. Indications of a dull knife are excess waste/or a “tail” on the unsliced portion remaining in the food chute.
2. The knife needs to be sharpened periodically to provide consistent slices and maximum food product yield. Sharpening the knife lightly every few days is more effective than heavy sharpening at less frequent intervals.

**Arby's® Knife Sharpener** is kept in a manager's location/possession until it is required. The sharpener must be properly installed on the slicer for prior to sharpening. After the slicer is sharpened, the sharpener is to be properly cleaned, sanitized, and allowed to air dry. It must then be returned to management.

Once the knife sharpener is removed, the knife and the entire slicer must be cleaned, sanitized and allowed to air dry before use. The sharpener inlay and all removable parts **MUST BE** reinstalled on the unit before returning the slicer to use.

### PREPARING TO SHARPEN

**⚠️ WARNING** To prevent illness or death caused by the spread of food-borne pathogens, it is important to properly clean and sanitize the entire slicer as any surface of the slicer can become contaminated. It is the responsibility of the slicer owner/operator to follow all guidelines, instructions and laws as established by your local and state health departments and the manufacturers of chemical sanitizers.



**Before sharpening, it is extremely important to completely clean and sanitize the slicer according to the cleaning instructions presented in this manual. *The slicer must be cleaned and sanitized again after sharpening.***

# Knife Sharpening, Sharpener Cleaning & Sanitizing

## INSTALL THE KNIFE SHARPENER

Arby's® policy requires that all associates **must** wear non-cutting safety gloves and single-use gloves during the cleaning operation

1. Turn slicer off by pressing the "STOP" button and **unplug the slicer**.
2. Make sure the auto engage lever is in the "Manual" position.
3. Remove the sharpener inlay by loosening the sharpener release knob located underneath the sharpener cover. Lift and remove the sharpener cover off of the slicer (Fig. 16-1).
4. Align and seat the sharpener into the knife sharpener seat. Secure the sharpener by tightening the knife sharpener thumb screw (Fig. 16-2).
5. Turn the slice thickness dial clockwise past zero "0" until it stops so the slicer table covers the knife edge.
6. Remove the food chute from the slicer.
7. Clean and dry both sides of the knife edge before sharpening, following the instructions for knife cleaning on pages 12 through 14.



Figure 16-1



Figure 16-2

 **NOTE:** The knife cover must be on during sharpening. The slicer will not start if the knife cover is removed.

 **ALWAYS BE ALERT.**

 **ALWAYS** clean and sanitize the slicer and all parts before and after sharpening

 **ALWAYS** keep hands and arms away from exposed knife.

 **NEVER** sharpen a knife with wet or damp stones.

## SHARPENING THE KNIFE

The knife should be sharpened every two to three days for 5-10 seconds.

1. Make sure the knife sharpener is secured in place with the sharpener knob to the top of the slicer (Fig 16-1).
2. Plug in the slicer and turn the knife motor on by pressing the START button.
3. With one hand, apply pressure inward and hold the sharpener lever in until it stops.
4. Maintain pressure on the lever for 5-10 seconds. Be sure to apply pressure to the lever for the full 5-10 seconds to maintain contact with the knife.

 **TURN OFF and UNPLUG the slicer.**

# Knife Sharpening, Sharpener Cleaning & Sanitizing

## CLEANING AND SANITIZING THE SLICER AND SHARPENER

Arby's® policy requires that all associates ***must*** wear non-cutting safety gloves and single-use gloves during the cleaning operation.

1. **Clean and sanitize the slicer as necessary using the cleaning procedures listed on pages 12 through 14.**

Place all removable parts, including the knife sharpener, in a dishmachine or three compartment sink with warm water and mild detergent solution; soak, clean, and thoroughly scrub all surfaces using a solution of mild detergent and warm water. (Removable parts include: food chute, end weight, slide rod, knife cover, sharpener inlay, knife sharpener, and slice deflector.)

Rinse removable parts with fresh, clean water. Following the instructions on your quaternary sanitizer label, soak the food chute, knife cover, sharpener inlay, knife sharpener, and slice deflector in a proper solution of quaternary sanitizer for a minimum of two minutes. Allow these parts to air dry.

Continue with the cleaning procedure outlined in this manual on pages 12 through 14 including reinstalling the sharpener inlay (Fig. 17-1).

2. After the slicer is sharpened, the sharpener is to be properly cleaned, sanitized, and allowed to air dry. It must then be returned to management until such time as it is needed again.
3. Reinstall the food chute.
4. Plug in the power cord.

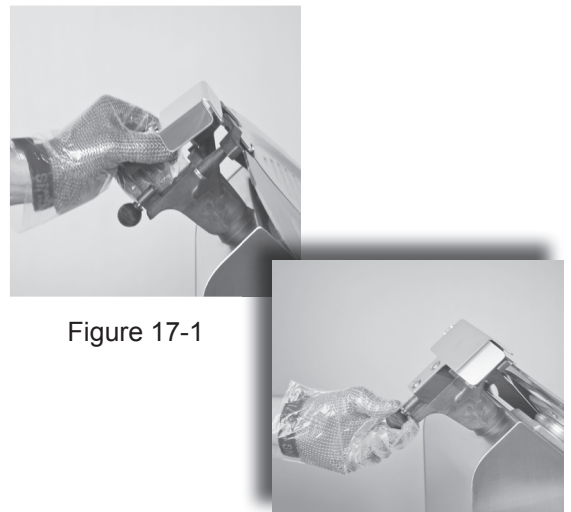

Figure 17-1

# Inspections, Simple Maintenance, and Repair

**WARNING**



## SHARP KNIFE BLADE TO AVOID SERIOUS PERSONAL INJURY:

- **BEFORE CLEANING, SHARPENING, SERVICING, OR REMOVING ANY PARTS:**
- Arby's® policy requires that all associates must wear non-cutting safety gloves and single-use gloves during the cleaning, sanitizing, sharpening, and servicing operation.
- Always turn slicer off, turn the slice thickness dial clockwise past zero "0" until it stops, remove the food chute, and unplug the power cord.
- **NEVER TOUCH KNIFE.** Keep hands and arms away from all moving parts.
- **DO NOT** tamper with, bypass, or remove any safety devices, guards, START/STOP buttons, or touch pad controls.
- **ALWAYS** turn slicer off, return auto engage lever to the "Manual" position, and turn the slice thickness dial clockwise past zero "0" until it stops after each use
- **USE ONLY PROPERLY INSTALLED GLOBE PARTS AND ACCESSORIES.**

### INSPECTING THE SLICER

**WARNING**

INSPECTING THE SLICER FOR DAMAGED OR BROKEN PARTS INCLUDING GASKETS & SEALS. A thorough visual inspection should be made of the entire slicer and its parts. Globe urges the owner/operator to inspect all components often and for an authorized service agent to inspect the entire slicer at least every 6 months, including all parts that are detachable for

cleaning and sanitizing. This inspection should include looking for damaged parts, broken seals or gaskets, and areas that may be more difficult to clean and sanitize.

IF A SEAL OR GASKET IS FOUND TO NOT PROPERLY SEAL, IS DAMAGED, OR IS MISSING, THE SLICER MUST BE REMOVED FROM SERVICE UNTIL IT IS REPAIRED BY AN AUTHORIZED SERVICER.

### SLICER INSPECTION AREAS

Slicer Seals and Gaskets Identified

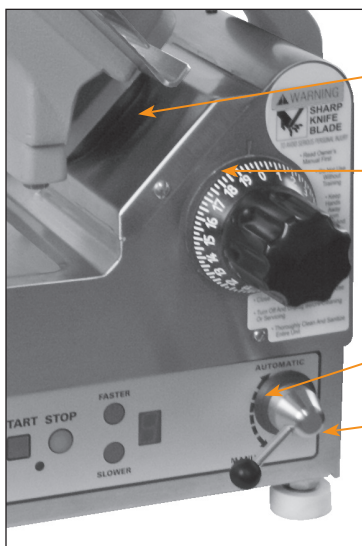

I  
N  
S  
P  
E  
C  
T

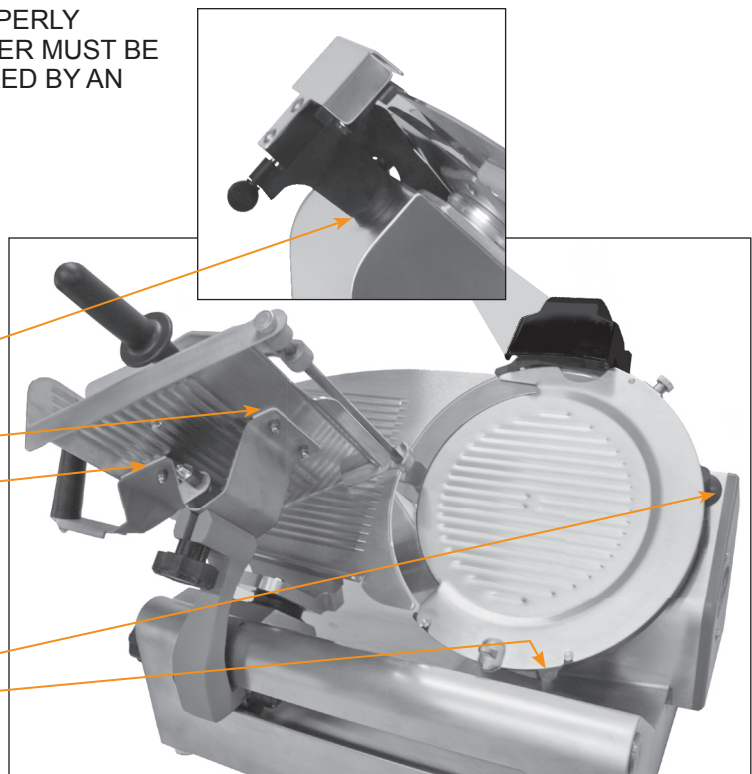

Shown with sharpener

# Inspections, Simple Maintenance, and Repair

## LUBRICATION

Various slicer parts need to be lubricated periodically using Globe oil. Globe oil is a light, tasteless and odorless mineral oil that will not contaminate or impart odors or taste to sliced food product.



**DO NOT USE VEGETABLE OIL TO LUBRICATE SLICER. VEGETABLE OIL WILL DAMAGE THE SLICER AND VOID THE WARRANTY.**

### Food Chute Slide Rods

It is necessary to lubricate the food chute slide rods with Globe oil every week (or when excessive drag is felt).

1. Close the slicer table. Make sure the auto engage lever is in the “Manual” position (automatics only).
2. Remove the food chute to improve access to the oil hole.
3. Pull the chute arm completely towards you and hold it in position so the oil hole is located behind the chute arm.
4. Remove cap from oil container. Add several drops of Globe oil into the oil hole (Fig. 19-1).
5. Wipe off excess oil.
6. Reinstall the food chute.



Figure 19-1

### End Weight Slide Rod

The end weight slide rod should be lubricated after cleaning (or when excessive drag is felt) with a few drops of Globe oil.

1. Add a few drops of Globe oil to the slide rod (Fig. 19-2).
2. Slide the end weight up and down several times to distribute the oil.

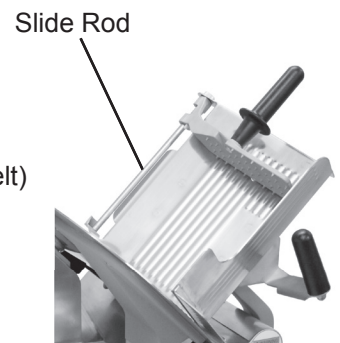

Figure 19-2

### Other Lubrication

It is recommended that all threaded screws be lubricated after each cleaning to maximize the life of your slicer.

# Optimal Slicing Performance

## TO OBTAIN THE MAXIMUM PERFORMANCE AND YIELD FROM YOUR GLOBE SLICER:

1. Read this entire manual before touching the slicer and strictly follow all instructions and precautions.  
**THERE IS NO SUBSTITUTE FOR SAFETY!**
2. Lubricate the slicer per the instructions on page 19.
3. Maintain a sharp knife and replace as necessary. Refer to the knife sharpening procedures on pages 15 through 17. Globe recommends replacing the knife at approximately 12 <sup>11</sup>/<sub>16</sub>" diameter. Never attempt to replace the knife yourself. Contact an authorized Globe service company to replace the knife.
4. Clean the knife prior to sharpening the slicer knife per the instructions on pages 11 through 14.
5. As the knife is sharpened and the diameter is reduced, it will be necessary to have:
  - a. The table adjusted inward toward the knife in order to maintain a consistent 1/16" clearance between the table and knife.
  - b. The sharpener lever must be fully engaged to allow the stones to come into full contact with the knife.

**We recommend an authorized Globe service company  
perform all adjustments and preventive maintenance.  
See front cover for service contact information.**

**By adequately maintaining your slicer, it will provide years of dependable  
service. The only way to damage a Globe slicer is by neglect.**

# Service and Troubleshooting Guide

<u>Issue</u>	<u>CAUSE</u>	<u>SOLUTION</u>
Slicer will not start	Slicer not plugged in	Plug in slicer
	Breaker at power panel / box tripped	Reset breaker at power panel / box
	Knife cover off	Install knife cover
	Knife cover removed or not properly installed	Install knife cover
Chute speed light flashing model 4913N		
	2 Knife cover removed or not properly installed	Install knife cover
	3 Chute motor overload. Check for obstructions and lubrication	Clear obstruction(s), lubricate rails, unplug slicer for 2 minutes, plug slicer in and restart
4 Food chute not in home position	Pull food chute completely towards you and restart the slicer	
Ragged cuts-poor yield	Dull knife	Sharpen knife-make sure knife and stones are clean
	Chipped knife	Sharpen or have new knife installed
	Knife-slicer table gap too wide 1/8"	Call for service to adjust slicer table
	Knife too small, 12" or less	Have new knife installed
Metal rubbing knife	Knife cover	Make sure knife cover is securely installed
	Food chute	Tighten or adjust food chute
	End weight	Have defective end weight replaced
	Slicer table	Call for service to adjust slicer table
Table will not operate	Knife cover off	Install knife cover
Hard to push food chute	No lubrication	Lubricate slide rods thoroughly with Globe oil - <b>Do not use vegetable oil!</b>
Blade will not sharpen satisfactorily	Stones dirty, wet, or clogged with grease	Clean stones with soapy water and brush. Allow stones to dry completely.
	Knife edge dirty	Clean top and bottom of knife edge
	Worn stones	Have stones replaced

If problems persist and the assigned solution does not remedy the issue, please call our Service Department at 866-260-0522.



# Spare Parts Sheet: Arby's Slicer 4913N

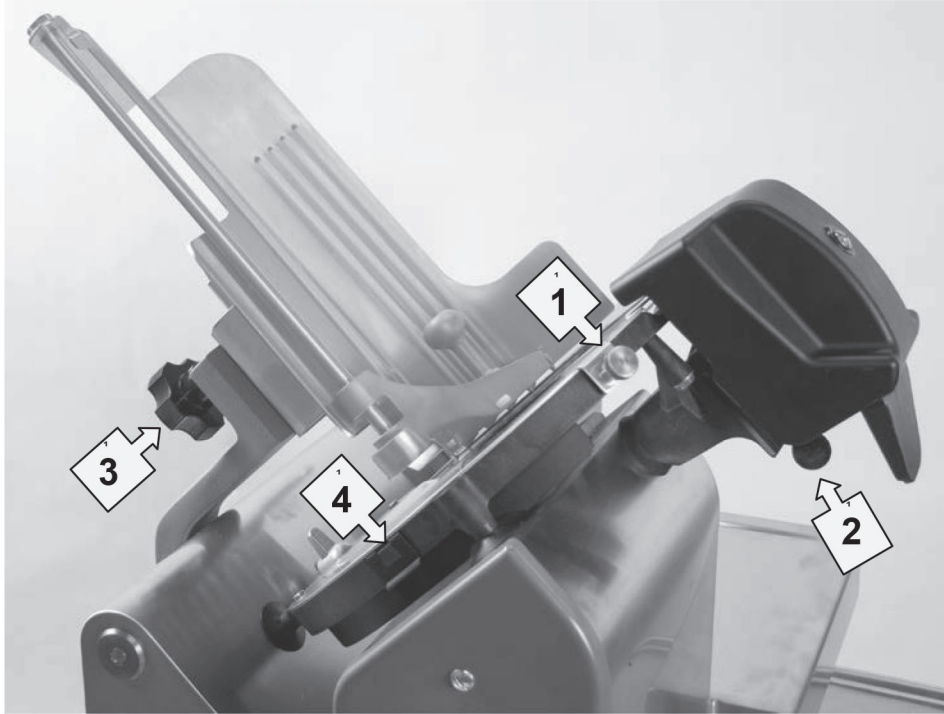

Part locations on Slicer



**Figure 1**  
Knife Cover Thumbscrew  
P/N 460045

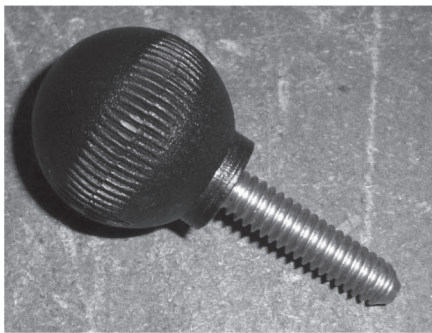

**Figure 2**  
Sharpener Release Knob  
P/N 520330

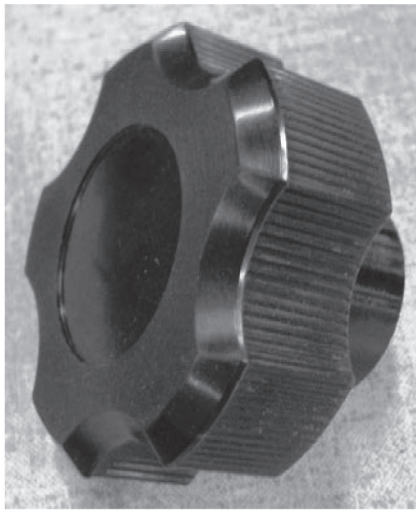

**Figure 3**  
Carriage Release Knob  
P/N 520312

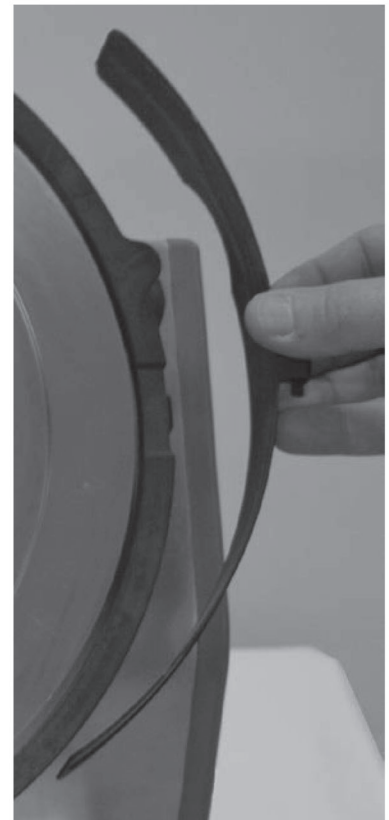

**Figure 4**  
Slice Deflector  
(Product Retainer)  
P/N 520219

# Limited Warranty

Globe Food Equipment Company (“GFE”) warrants to the original purchaser of new equipment that said equipment, when installed in accordance with our instructions within North America and subjected to normal use, is free from defects in material or workmanship for a period of 1 year on parts (excludes wear/expendable parts). The labor warranty is 1 year on labor from original installation, or 18 months from actual shipment date, whichever date occurs first. The labor warranty includes travel within a 50 mile radius of the authorized service center during normal business hours (M-F, 8am-5pm). The motor pinion gear and knife drive gear have a 15 year limited warranty.

NOTE: There is also an extended service program available for purchase at time of sale only, which is 3 years on parts (excludes wear/expendable parts). The labor warranty is 3 years on labor from original installation, or 42 months from actual shipment date, whichever date occurs first. The labor warranty includes travel within a 50 mile radius of the authorized service center during normal business hours (M-F, 8am-5pm). 2 preventative maintenance calls per year is also included in this service program.

THIS WARRANTY IS IN LIEU OF ALL OTHER WARRANTIES, WHETHER EXPRESS OR IMPLIED. GFE EXPRESSLY DISCLAIMS ANY IMPLIED WARRANTY OF MERCHANTABILITY OR EXPRESS OR IMPLIED WARRANTY OF FITNESS FOR A PARTICULAR PURPOSE.

GFE’S OBLIGATION AND LIABILITY UNDER THIS WARRANTY IS EXPRESSLY LIMITED TO REPAIRING AND REPLACING EQUIPMENT WHICH PROVES TO BE DEFECTIVE IN MATERIAL OR WORKMANSHIP WITHIN THE APPLICABLE WARRANTY PERIOD. All repairs pursuant to this Warranty will be performed by an Authorized Designated GFE Service Location during normal working hours. IN NO EVENT SHALL GFE BE LIABLE FOR INCIDENTAL OR CONSEQUENTIAL DAMAGES TO BUYER OR ANY THIRD PARTY, INCLUDING, WITHOUT LIMITATION, LOSS OF PROPERTY, PERSONAL INJURY, LOSS OF BUSINESS OR PROFITS OR OTHER ECONOMIC LOSSES, OR STATUTORY OR EXEMPLARY DAMAGES, WHETHER IN NEGLIGENCE, WARRANTY, STRICT LIABILITY, OR OTHERWISE. CUSTOMER WILL PAY \$75.00 FOR ANY LABOR ONLY CALLS PLACED TO SERVICE AGENT.

This Warranty is given only to the first purchaser from a retail dealer. No warranty is given to subsequent transferees.

This Warranty does not cover product failures caused by: failure to maintain, neglect, abuse, damage due to excess water, fire, normal wear, improper set up and use. Periodic maintenance including lubrication and sharpening are not covered.

This Warranty is not in force until such time as a properly completed Installation/Warranty Registration has been received by GFE within 30 days from the date of installation. <http://www.globeslicers.com/site/warranty.asp>

THE FOREGOING WARRANTY PROVISIONS ARE A COMPLETE AND EXCLUSIVE STATEMENT BETWEEN THE BUYER AND SELLER. GFE NEITHER ASSUMES NOR AUTHORIZES ANY PERSONS TO ASSUME FOR IT ANY OTHER OBLIGATION OR LIABILITY IN CONNECTION WITH SAID EQUIPMENT.

Example of items not covered under warranty, but not limited to just these items:

1. Acts of God, fire, water damage, burglary, accident, theft.
2. Freight damage.
3. Improper installation or alteration of equipment.
4. Use of generic or after market parts.
5. Repairs made by anyone other than a GFE designated servicer.
6. Lubrication.
7. Expendable wear parts.
8. Cleaning of equipment.
9. Misuse or abuse.

WARRANTY REGISTRATION  
SCAN THE QR CODE WITH YOUR MOBILE DEVICE OR GO TO  
[WWW.GLOBESLICERS.COM](http://WWW.GLOBESLICERS.COM) TO FILL OUT AND SUBMIT YOUR  
WARRANTY REGISTRATION.

<http://www.globeslicers.com/site/warranty.asp>

