



# Instruction Manual

## Designer Holding Cabinet

Model Series: 5510, 5511, and 5512



**GOLD MEDAL<sup>®</sup> PRODUCTS CO.**

10700 Medallion Drive, Cincinnati, Ohio 45241-4807 USA



# Table of Contents

**SAFETY PRECAUTIONS ..... 3**

**INSTALLATION INSTRUCTIONS ..... 5**

    Inspection of Shipment ..... 5

    Manual ..... 5

    Model Description ..... 5

    Items Included with this Unit ..... 5

    Setup ..... 5

    Electrical Requirements ..... 7

    Before You Plug In Machine ..... 7

**OPERATING INSTRUCTIONS ..... 8**

    Controls and Their Functions ..... 8

    Operating Instructions ..... 8

    Adjusting the Set Temperature ..... 9

**Care and Cleaning ..... 10**

**Troubleshooting ..... 11**

**—THE FOLLOWING SECTIONS ARE FOR QUALIFIED SERVICE PERSONNEL ONLY— ..... 12**

**MAINTENANCE INSTRUCTIONS ..... 12**

**ORDERING SPARE PARTS ..... 13**

    Replacing Broken Glass ..... 14

    Cabinet - Parts Breakdown ..... 15



    Dome Interior – Parts Breakdown ..... 17



**Wiring Diagram ..... 19**



**WARRANTY ..... 20**







# SAFETY PRECAUTIONS

	 <b>DANGER</b>
	<p>Machine must be properly grounded to prevent electrical shock to personnel. Failure to do so could result in serious injury, or death. Make sure all machine switches are in the OFF position before plugging the equipment into the receptacle. Keep cord and plug off the ground and away from moisture. Always unplug the equipment before cleaning or servicing. DO NOT immerse any part of this equipment in water. DO NOT use a water jet or excessive water when cleaning.</p> <p style="text-align: right; font-size: small;">008_012221</p>

	 <b>DANGER</b>
	<p>Improper installation, adjustment, alteration, service, or maintenance can cause property damage, injury, or death. Any alterations to this equipment will void the warranty and may cause a dangerous condition. This appliance is not intended to be operated by means of an external timer or separate remote-control system. NEVER make alterations to this equipment. Read the Installation, Operating, and Maintenance Instructions thoroughly before installing, servicing, or operating this equipment.</p> <p style="text-align: right; font-size: small;">014_020416</p>

	 <b>WARNING</b>
	<p>To avoid burns, DO NOT touch heated surfaces. DO NOT place or leave objects in contact with heated surfaces.</p> <p style="text-align: right; font-size: small;">009_092414</p>

	 <b>WARNING</b>
	<p>ALWAYS wear safety glasses when servicing this equipment.</p> <p style="text-align: right; font-size: small;">010_010914</p>

	 <b>WARNING</b>
	<p>No user serviceable parts inside. Refer servicing to qualified service personnel.</p> <p style="text-align: right; font-size: small;">011_051514</p>

	 <b>WARNING</b>
	<p>Read and understand operator's manual and all other safety instructions before using this equipment. To order copies of the operator's manual go to <a href="http://gmpopcorn.com">gmpopcorn.com</a> or write to Gold Medal Products Co., 10700 Medallion Drive, Cincinnati, OH 45241 USA 1-(800)-543-0862</p> <p style="text-align: right; font-size: small;">022_060215</p>



	<b>WARNING</b>
	<p>DO NOT allow direct contact of this equipment by the public when used in food service locations. Only personnel trained and experienced in the equipment operation may operate this equipment. Carefully read all instructions before operation.</p> <p style="text-align: right; font-size: small;">012_010914</p>

	<b>WARNING</b>
	<p>This machine is NOT to be operated by minors.</p> <p style="text-align: right; font-size: small;">007_010914</p>

	<b>CAUTION</b>
	<p>If the supply cord is damaged, it must be replaced by Gold Medal Products Co., its service agent or similarly qualified persons in order to avoid a hazard.</p> <p style="text-align: right; font-size: small;">039_080614</p>

**Note:** Improvements are always being made to Gold Medal’s equipment. This information may not be the latest available for your purposes. It is critical that you call Gold Medal’s Technical Service Department at 1-800-543-0862 for any questions about your machine operations, replacement parts, or any service questions. (Gold Medal Products Co. does not assume any liability for injury due to careless handling and/or reckless operation of this equipment.) General images may be used in manual for reference only.



# INSTALLATION INSTRUCTIONS

## Inspection of Shipment

After unpacking, check thoroughly for any damage which may have occurred in transit. Claims should be filed immediately with the transportation company. The warranty does not cover damage that occurs in transit, or damage caused by abuse, or consequential damage due to the operation of this machine, since it is beyond our control (reference warranty in back of manual).

## Manual

Read and understand the operator's manual and all other safety instructions before using this equipment. To order copies of the operator's manual go to [gmpopcorn.com](http://gmpopcorn.com) or write to Gold Medal Products Co., 10700 Medallion Drive, Cincinnati, OH 45241 USA 1-(800)-543-0862.

## Model Description

Designer Holding Cabinet is a countertop unit with an LED lighted cabinet and sign, and a digital heat control.

Unit is suitable for holding potentially hazardous foods (volatile food products) when the digital heat control is set to 160°F (72°C)—holds precooked products at serving temperature; not designed for cooking or reheating, see Operating Instructions.

**5510-00-100:** Small Cabinet, two removable shelves

**5511-00-100:** Tall Cabinet, five removable shelves

**5512-00-100:** Wide Cabinet, two removable shelves

## Items Included with this Unit

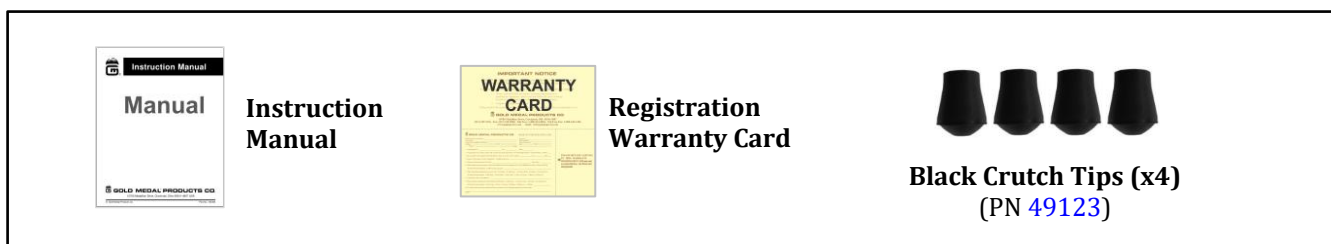

## Setup

This unit has been tested at the factory.

1. Remove all packaging and tape prior to operation.
2. Place the unit on a sturdy, level base.
3. Unit has 4 glide feet preinstalled at the factory (see image below). Install a Black Crutch Tip on each foot. Firmly push crutch tip over glide until it covers glide entirely.



4. Doorknobs are shipped facing the inside of machine. Re-adjust knobs to face the outside of machine.
5. Make sure air ducts are in place before installing racks, see Air Duct Installation instructions below.
6. Install racks—make sure the rack sits on the shelf support for each corner post.
7. After setup, unit should be cleaned prior to use (see Care and Cleaning section).

**Shelf supports located on each corner post.**

**Readjust knobs to face outward.**

**Glide (pre-installed at the factory)**

**Black Crutch Tip**

**Rubber Feet Installation**

**Air Duct Installation:**

- a. Insert top of air duct under the ceiling tab.  
Side flanges of the air duct must face the glass.
- b. Slide bottom end towards glass.  
Make sure the air duct clears the shelf brackets on the corner posts.



**General images shown for reference only (model sizes vary).**



## Electrical Requirements

The following power supply must be provided (reference unit Data Plate for Wattage requirement):

**120 V~, 60 Hz**

	 <b>DANGER</b>
	<p>Machine must be properly grounded to prevent electrical shock to personnel. Failure to do so could result in serious injury, or death.                  Make sure all machine switches are in the OFF position before plugging the equipment into the receptacle. Keep cord and plug off the ground and away from moisture. Always unplug the equipment before cleaning or servicing.                  DO NOT immerse any part of this equipment in water.                  DO NOT use a water jet or excessive water when cleaning.</p> <p style="text-align: right; font-size: small;">008_012221</p>

A certified electrician must furnish sufficient power for proper machine operation and install any supplied receptacle (reference unit Data Plate for model specific Volts AC, Hertz, and Wattage requirements). We recommend this equipment be on a dedicated and protected circuit. Failure to wire properly will void the warranty and may result in damage to the machine. It is Gold Medal Products Co.'s recommendation that this machine be plugged directly into a wall outlet. The use of extension cords is not recommended due to safety concerns, and may cause sacrificed and/or reduced performance. Make sure cord is located to prevent a trip hazard or unit upset.

## Before You Plug In Machine

1. Make sure all machine switches are OFF before plugging equipment into receptacle.
2. Make sure wall outlet can accept the grounded plugs (where applicable) on the power supply cord.
3. The wall outlet must have the proper polarity. If in doubt, have a competent electrician inspect the outlet and correct if necessary.
4. **DO NOT** use a grounded to un-grounded receptacle adapter (where applicable).
5. Install unit in a level position.

	 <b>CAUTION</b>
	<p>If the supply cord is damaged, it must be replaced by Gold Medal Products Co., its service agent or similarly qualified persons in order to avoid a hazard.</p> <p style="text-align: right; font-size: small;">039_080614</p>



# OPERATING INSTRUCTIONS

## Controls and Their Functions

### LIGHTS SWITCH

Two position, lighted rocker switch - provides power to the interior cabinet lighting and to the sign. The green light ON indicates there is power to the lights.

### HEAT SWITCH

Two position, lighted rocker switch - provides power to the blower and Digital Heat Control. DO NOT operate unit if blower is not working (see Troubleshooting section).

### DIGITAL HEAT CONTROL (Digital Display)

Controls the cabinet temperature (cycles the heat element OFF/ON during operation, as needed)—the heat switch must be on for the control to turn on.

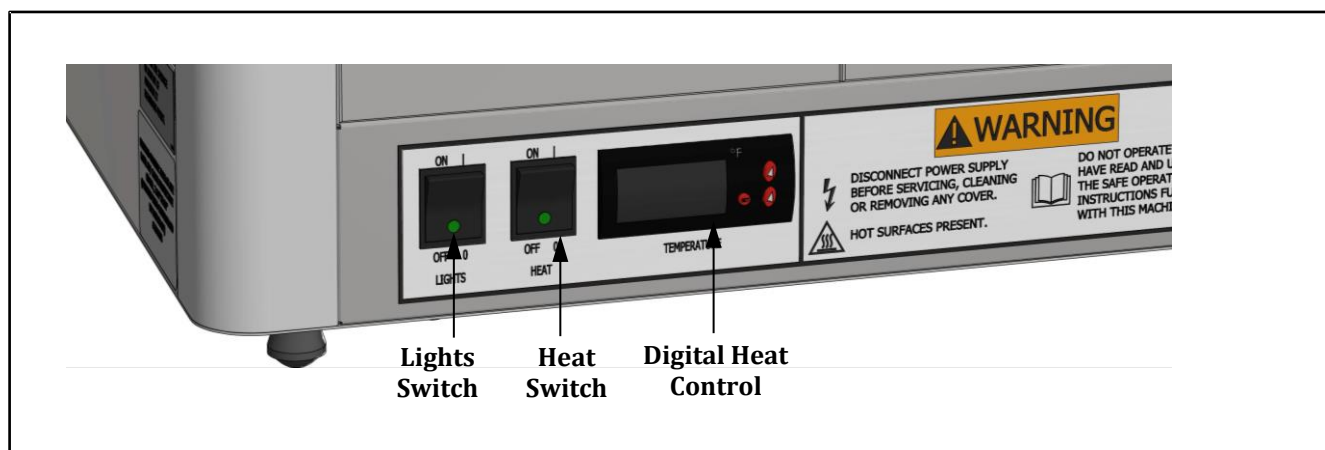

## Operating Instructions

1. Turn Lights and Heat Switch ON.
2. Set unit temperature for one of the uses below (see Adjusting the Set Temperature).

**To hold potentially hazardous foods (volatile foods)**—the control MUST be set to 160°F (72°C).

**Note:** Do not use for cheese cups when set above 140°F (60°C).

**To hold Portion Pak Cheese Containers/prepackaged non-volatile foods**—set the control to 140°F (60°C).

DO NOT use for open volatile food products when set below 160°F (72°C).

**Important:** The control displays the air temperature in the cabinet. **The actual product temperature may be lower or higher than the displayed temperature depending on how long it has been heated.**

For specific product safe food holding temperature, reference your local code and/or instructions from the food product manufacturer.



3. Allow unit to preheat to the set temperature while empty.
4. Load product as indicated below—do not over fill the unit or block the air ducts; allow air to circulate freely.

**For volatile foods**—load preheated product directly into the preheated cabinet—unit must be preheated to 160°F (72°C) before adding product. Unit holds precooked products at serving temperature; not designed for cooking or reheating.

**Portion Pac Cheese Cups/unopened prepackaged non-volatile foods only**—load product into the preheated cabinet—unit must be set to 140°F (60°C); allow product to preheat approximately one hour.

5. Keep cabinet doors closed when not loading or serving product.

## Adjusting the Set Temperature

To check or adjust the Digital Heat Control, follow the instructions below. The temperature range of the control can be set between 140°F–160°F (60°C–72°C), see steps below.

1. Press SET button—“SP” displays.
2. Press SET again—current set temperature displays.
3. Press UP/DOWN arrows to adjust temperature, then press SET to save.
4. To EXIT, press SET and DOWN arrow **at the same time** (returns to operating mode).

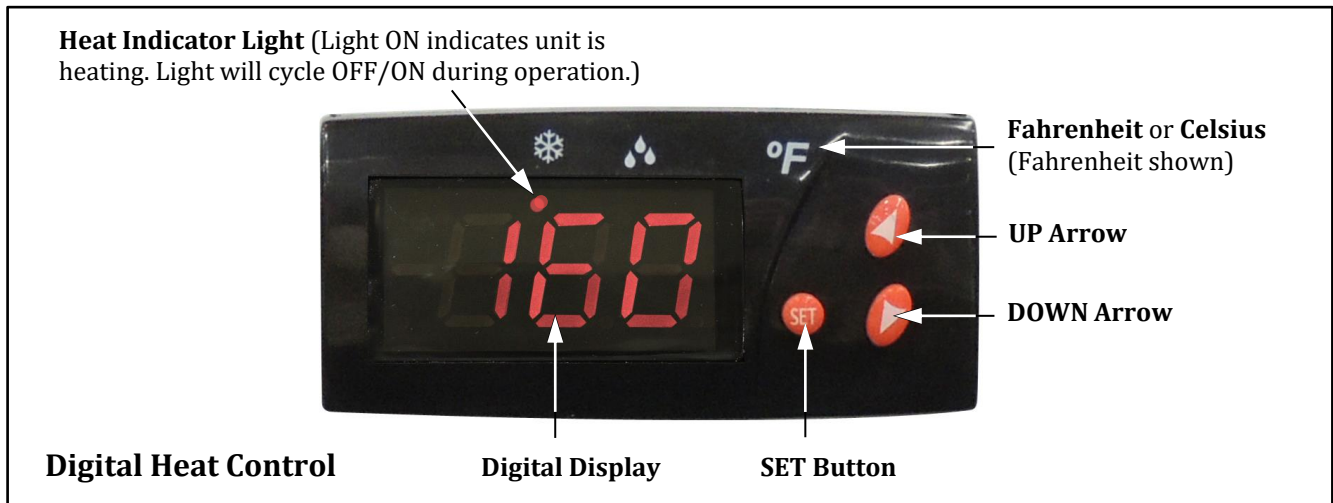



## Care and Cleaning

	<b>⚠ DANGER</b>
	Machine must be properly grounded to prevent electrical shock to personnel. <b>DO NOT immerse in water.</b> DO NOT clean appliance with a water jet or steam cleaner. Always unplug the equipment before cleaning or servicing. 025_051321

	<b>⚠ WARNING</b>
	To avoid burns, DO NOT touch heated surfaces. DO NOT place or leave objects in contact with heated surfaces. 009_092414

Good sanitation practice demands that all food preparation equipment be cleaned regularly (only use non-toxic, food grade cleaners).

For surfaces needing further cleaning or degreasing, Watchdog Stainless Cleaner (Item No. 2088) or Watchdog Concession Equipment Degreaser (Item No. 2580) is available for use accordingly. For any cleaning products used, follow the manufacturer's instructions on the product. **DO NOT use oven cleaners or abrasive materials** as they will damage parts of machine.

Follow the directions below to clean the unit each day after use.

1. Turn machine OFF, unplug unit and allow it to cool completely.
2. Take racks/pans to the sink to clean with soap and water, then rinse and dry.
3. Wipe interior and exterior surfaces clean using a SLIGHTLY damp cloth (cloth may be SLIGHTLY dampened with soap and water, then wipe again to remove any remaining cleaner).
4. Clean glass panels with glass cleaner. Gold Medal Watchdog Glass Cleaner (Item No. 2588) is recommended.  
Ammonia cleaners will damage plastic doors/panels. Only use a non-ammonia cleaner, such as Gold Medal Watchdog Glass Cleaner (Item No. 2588).
5. Make sure the air vents are in place; then reinstall the racks.





## Troubleshooting



<b>Issue</b>	<b>Possible Cause</b>	<b>Solution</b>
<b>Unit Does Not Heat</b>	A. No power to unit	A. Check that the unit is plugged into the wall outlet. See Electrical Requirements section for electrical specifications. Make sure the Heat Switch is ON for the digital control to operate. If heat switch and control are on, but unit still does not heat, the element may be the issue, have Qualified Service Person inspect/repair the unit.
<b>Fan Not Operating</b>	A. Blower Defective	A. If the blower does not come on when the heat switch is turned activated, do not use the unit, have Qualified Service Person inspect/repair the unit.
<b>Product Heats Slow</b>	A. Too Much Product	A. Do not overfill the unit or block the air ducts. Allow air to circulate freely.





—THE FOLLOWING SECTIONS ARE FOR QUALIFIED SERVICE PERSONNEL ONLY—

# MAINTENANCE INSTRUCTIONS

	 <b>DANGER</b>
	<p>Machine must be properly grounded to prevent electrical shock to personnel. Failure to do so could result in serious injury, or death. Make sure all machine switches are in the OFF position before plugging the equipment into the receptacle. Keep cord and plug off the ground and away from moisture. Always unplug the equipment before cleaning or servicing. DO NOT immerse any part of this equipment in water. DO NOT use a water jet or excessive water when cleaning.</p> <p style="text-align: right; font-size: small;">008_012221</p>

	 <b>DANGER</b>
	<p>Improper installation, adjustment, alteration, service, or maintenance can cause property damage, injury, or death. Any alterations to this equipment will void the warranty and may cause a dangerous condition. This appliance is not intended to be operated by means of an external timer or separate remote-control system. NEVER make alterations to this equipment. Read the Installation, Operating, and Maintenance Instructions thoroughly before installing, servicing, or operating this equipment.</p> <p style="text-align: right; font-size: small;">014_020416</p>

	 <b>WARNING</b>
	<p>No user serviceable parts inside. Refer servicing to qualified service personnel.</p> <p style="text-align: right; font-size: small;">011_051514</p>

	 <b>CAUTION</b>
	<p>THE FOLLOWING SECTIONS OF THIS MANUAL ARE INTENDED ONLY FOR QUALIFIED SERVICE PERSONNEL WHO ARE FAMILIAR WITH ELECTRICAL EQUIPMENT. THESE ARE NOT INTENDED FOR THE OPERATOR.</p> <p style="text-align: right; font-size: small;">027_010914</p>



---

---

## ORDERING SPARE PARTS

1. Identify the needed part by checking it against the photos, illustrations, and/or parts list. (General images may be used in manual for reference only.)
2. Use only approved replacement parts when servicing this unit.
3. When ordering, please include part number, part name, and quantity needed.
4. Please include your model number, serial number, and date of manufacture (located on the machine nameplate/data plate) with your order.
5. Address all parts orders to Parts Department, Gold Medal Products Co., 10700 Medallion Drive, Cincinnati, Ohio 45241-4807

or place orders by phone or online:

Phone: (800) 543-0862  
(513) 769-7676

Fax: (800) 542-1496  
(513) 769-8500

E-mail: [info@gmpopcorn.com](mailto:info@gmpopcorn.com)  
Web Page: [gmpopcorn.com](http://gmpopcorn.com)



## Replacing Broken Glass

Broken glass panels can be easily replaced. Gold Medal Products Co. does not ship glass. It can be obtained from a local glass shop, always purchase tempered glass.

### GLASS DIMENSIONS (Height x Width x Thickness)

Model Series	Side Glass	Front Glass
5510	13.375" x 15.297" x .125"	13.375" x 15.297" x .125"
5511	27.375" x 15.297" x .125"	27.375" x 15.297" x .125"
5512	13.375" x 15.297" x .125"	13.375" x 29.797" x .125"

1. Turn machine OFF, unplug unit and allow it to cool before attempting to replace glass.
2. Carefully remove all loose pieces of broken glass.
3. Pull out Magnetic Clip located above glass panel in cabinet interior (see Figure A below).
4. Slide glass panel up under top ridge, then swing bottom of panel out and lower it away from unit (see Figures A and B below).
5. Carefully remove the rest of the broken glass.
6. Remove all rigid glass channels from around glass to be replaced, set channels aside for reuse.
7. Apply decals (if desired) to new glass panel.
8. Slide rigid glass channels over exposed edges of new glass panel.
9. Carefully slide new glass panel up under top ridge, then lower it into the bottom channel.
10. Reinstall magnetic clip above the new panel in cabinet interior.

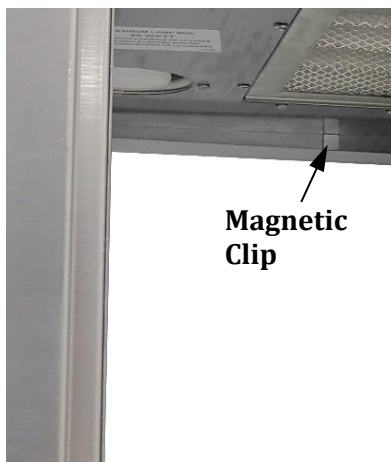

**Figure A** - Remove magnetic clip located above glass panel.



**Figure B** - Slide glass panel up under top ridge.

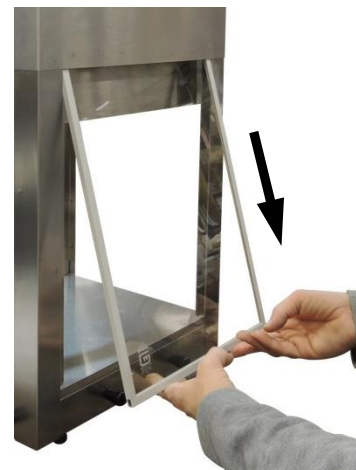
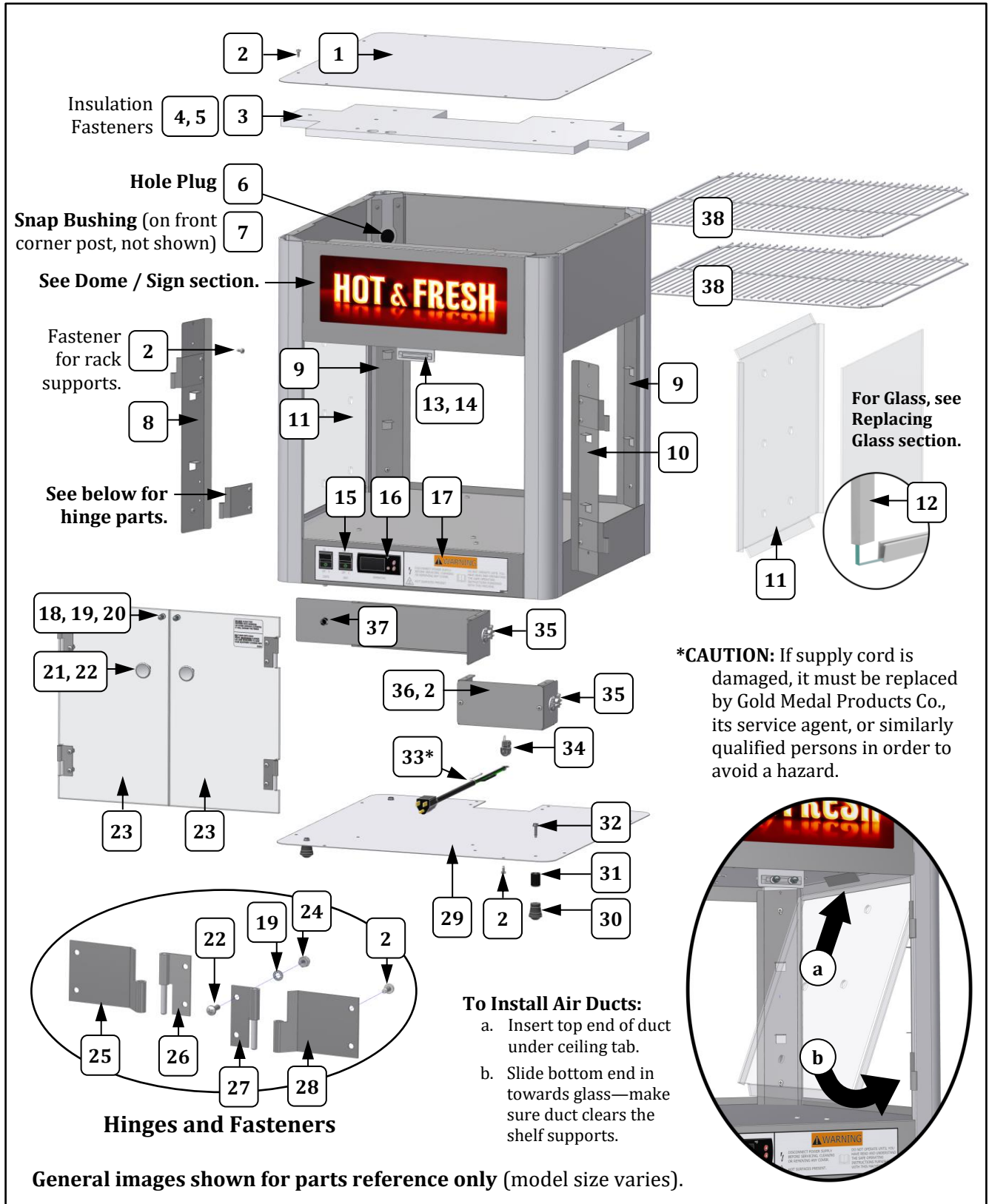

**Figure C** - Swing bottom of glass panel out, then lower it away from unit.

General images shown for glass installation reference only.



# Cabinet - Parts Breakdown



General images shown for parts reference only (model size varies).



## Cabinet - Parts List

Item	Part Description	Part Number		
		5510-00-100	5511-00-100	5512-00-100
1	DOME COVER	116450	116450	116618
2	SCREW #8-32X3/8 PAN HD PH	74141	74141	74141
3	INSULATION WRAP	116533	116533	116534
4	SCREW #8-32X1/2 PAN HD PH	74147	74147	74147
5	#10X1X.047THK SS WASHER	115109	115109	115109
6	HOLE PLUG, .875 DIA (for rear corner posts)	61187	61187	61187
7	BUSHING, SNAP .875 IN (not shown, for front corner posts)	45396	45396	45396
8	LH DOOR HANGER	116495	116453	116495
9	REAR GLASS RETAINER	116494	116452	116494
10	RH DOOR HANGER	116496	116456	116496
11	AIR DUCT	116499	116489	116499
12	GLASS CHANNEL (for side edges of glass panels)	42865	100654	42865
	GLASS CHANNEL (for top and bottom of SIDE glass panels)	115303	115303	115303
	GLASS CHANNEL (for top and bottom of BACK glass panel)	115303	115303	47698
13	MAGNETIC CATCH BRACKET	116459	116459	116459
14	MAGNETIC CATCH	47561	47561	47561
15	SWITCH, LIGHTED ROCKER GR	42798	42798	42798
16	PROGRAMMED CONTROL	101120-006	101120-006	101120-006
17	LABEL	111586	111586	111586
18	TEE BOLT #8-32X3/8 ZP	75267	75267	75267
19	WASHER #8 INTERNAL TOOTH	74150	74150	74150
20	ACORN NUT #8-32	47702	47702	47702
21	KNOB, DOOR,8-32 INT THREAD	41013	41013	41013
22	8-32 X 1/2 PHIL PN M/S SS	42226	42226	42226
23	DOOR	116497	116455	116620
24	8-32 ACORN NUT SS	12385	12385	12385
25	RH FEMALE STL HINGE	116463	116463	116463
26	MALE HINGE SHORT LEFT	41349	41349	41349
27	MALE HINGE SHORT RIGHT	41350	41350	41350
28	LH FEMALE STL HINGE	116462	116462	116462
29	BASE COVER	116451	116451	116619
30	CRUTCH TIP BLACK 70 DURO	49123	49123	49123
31	GLIDE	47328	47328	47328
32	SCREW, 10-24 X 3/4 HXHD	41314	41314	41314
33	POWER SUPPLY CORD 15 AMP	22038	22038	22038
34	STRAIN RELIEF SR-11-2 RA	87194	87194	87194
35	STRAIN RELIEF T&B 3302 (metal)	89045	89045	89045
36	IEC COVER	111705	111705	111705
37	HOLE PLUG, .500 DIA.	116282	116282	116282
38	DESIGNER SHELF	116492	116492	116623



# Dome Interior – Parts Breakdown

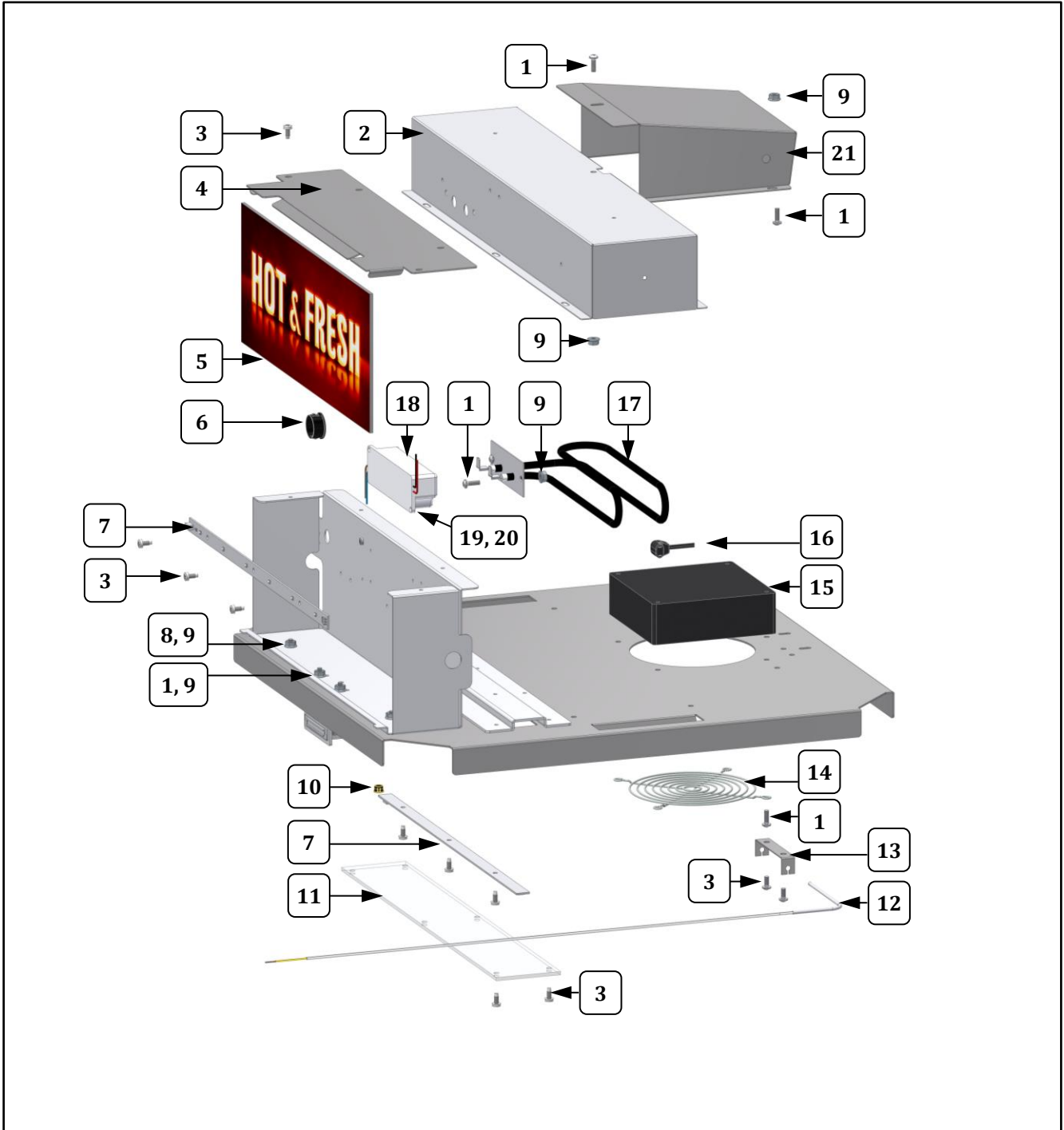



## Dome Interior – Parts List

Item	Part Description	Part Number		
		5510-00-100	5511-00-100	5512-00-100
1	8-32 X 1/2 PHIL PN M/S SS	42226	42226	42226
2	BLOWER BOX	116488	116488	116617
3	SCREW #8-32X3/8 PAN HD PH	74141	74141	74141
4	SIGN RETAINER	116446	116446	116615
5	HOT & FRESH SIGN	116457	116457	116616
6	BUSHING, SNAP .875 IN	45396	45396	45396
7	LED STRIP COOL WHITE	55379	55379	55379
8	8-32 X 3/8 PAN HD PH M/S	12389	12389	12389
9	8-32 SERRATED FLANGE NUT	61151	61151	61151
10	BUSHING, SNAP .312 IN	75328	75328	75328
11	LED COVER	63772	63772	116613
12	THERMISTOR PTC SS SHEATH	101131	101131	101131
13	BULB KEEPER	42658	42658	42658
14	5IN FAN GRATE	74783	74783	74783
15	AXIAL FAN	40721	40721	40721
16	EXHST BLOWER PLUG & CORD	47199	47199	47199
17	HEAT ELEMENT 750W 120V	39615	39615	39615
18	POWER SUPPLY 24VDC 20W	55394	55394	
	POWER SUPPLY 24VDC 60W			55586
19	SCREW 6-32X3/8 PH PAN HD	101210	101210	101210
20	6-32 HEX NUT ZINC PLATED	38005	38005	38005
21	BLOWER WRAPPER	74738	74738	74738



# Wiring Diagram

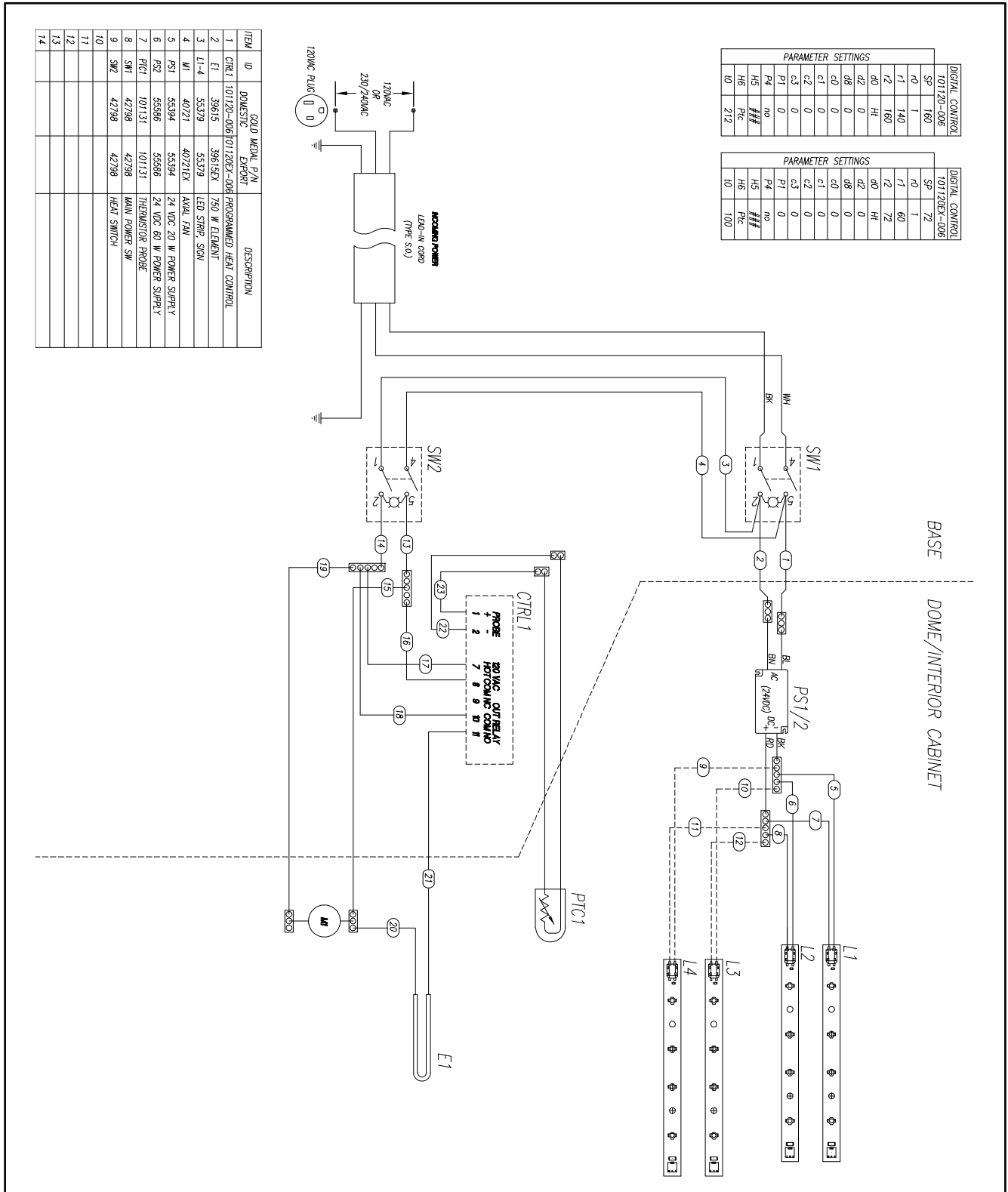



## WARRANTY

Gold Medal Products Co. warrants to the original purchaser each item of its manufacture to be free of defects in workmanship and material under normal use and service. Gold Medal Products Co.'s obligation under this warranty is limited solely to repairing or replacing parts, f.o.b. Cincinnati, Ohio, which in its judgment are defective in workmanship or material and which are returned, freight prepaid, to its Cincinnati, Ohio factory or other designated point. Except for "Perishable Parts" on specific machines, the above warranty applies for a period of two (2) years from the date of original sale to the original purchaser of equipment when recommended operating instructions and maintenance procedures have been followed. These are packed with the machine. Parts warranty is two (2) years, labor is six (6) months.

THIS WARRANTY IS IN LIEU OF ALL OTHER WARRANTIES EXPRESSED OR IMPLIED, AND OF ALL OTHER OBLIGATIONS OR LIABILITIES ON OUR PART, INCLUDING THE IMPLIED WARRANTY OF MERCHANTABILITY. THERE ARE NO WARRANTIES WHICH EXTEND BEYOND THE DESCRIPTION ON THE FACE HEREOF. In no event shall Gold Medal Products Co. be liable for special, incidental or consequential damages. No claim under this warranty will be honored if the equipment covered has been misused, neglected, damaged in transit, or has been tampered with or changed in any way. No claim under this warranty shall be honored in the event that components in the unit at the time of the claim were not supplied or approved by Gold Medal Products Co. This warranty is effective only when electrical items have been properly attached to city utility lines only at proper voltages. This warranty is not transferable without the written consent of Gold Medal Products Co.

The term "Original Purchaser" as used in this warranty shall be deemed to mean that person, firm, association, or corporation who was billed by the GOLD MEDAL PRODUCTS CO., or their authorized distributor for the equipment.

THIS WARRANTY HAS NO EFFECT AND IS VOID UNLESS THE ORIGINAL PURCHASER FIRST CALLS GOLD MEDAL PRODUCTS CO. AT 1-800-543-0862 TO DISCUSS WITH OUR SERVICE REPRESENTATIVE THE EQUIPMENT PROBLEM, AND, IF NECESSARY, FOR INSTRUCTIONS CONCERNING THE REPAIR OR REPLACEMENT OF PARTS.

*NOTE: This equipment is manufactured and sold for commercial use only.*



**GOLD MEDAL<sup>®</sup> PRODUCTS CO.**

10700 Medallion Drive, Cincinnati, Ohio 45241-4807 USA

[gmpopcorn.com](http://gmpopcorn.com)

Phone: (800) 543-0862      Fax: (800) 542-1496  
(513) 769-7676              (513) 769-8500