

Please review all the information in this manual before installation and operation. Long term, trouble-free service will follow if good housekeeping and maintenance procedures are followed. Thank you for selecting Glastender, Inc. products.

- **Electrical:** 115 Volt AC, 1 Phase, 60 Hz, less than 5 Full Load Amps. A 9-foot grounded cord is included.

UNCRATING AND START-UP INSTRUCTIONS

1. Unwrap power cord.
2. Position the Lighted Liquor Display.
3. Units up to 54" are shipped as a single unit and need no further assembly, skip to step 4. For units 60" and longer (LLDS shown):

- Remove six screws from each top, remove tops. (Fig. 1)
- Put the left LLD power cord through the side hole. (Fig. 2)
- Align the two ends of the Lighted Liquor Displays. (Fig. 3)
- Put the power cord into the right LLD. (Fig. 3)
- Secure the tops of the units together with four provided screws. (Fig. 4)
- Carefully lay both units on back side. Secure the bottoms of the units with four provided screws. (Fig. 5) NOTE: LLD3 model requires 10 screws (provided).
- Plug the power cord into the right LLD. (Fig. 5)
- Carefully upright connected units.
- Reinstall tops with six screws each.

4. Remove clear protective film from plexiglass tops and discard.
5. Plug into 115 volt AC outlet.
6. Through the power cord side hole, turn the switch ON.
7. Your Glastender Lighted Liquor Display is now ready for use.

CHANGING A LIGHT BULB

1. Disconnect the electrical power.
2. Unscrew and remove the top.
3. Twist the bulb, and remove.
4. Align the new bulb pins, set in and twist into position.
5. Put the top back in place and secure with screws.



LLD3

6 screws for top installation

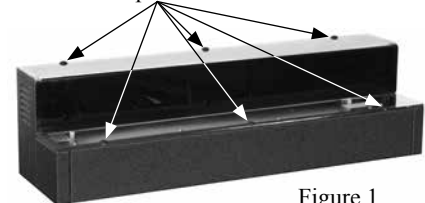
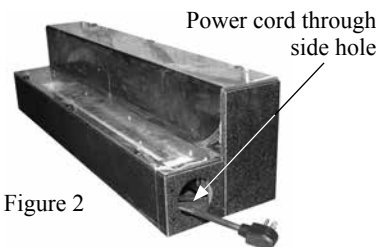
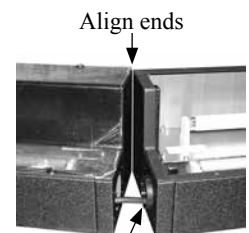

Figure 1



Power cord through side hole

Figure 2



Align ends

Power cord into right unit

Figure 3

Top - secure units together with 4 screws

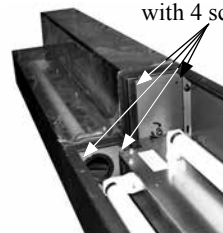

Figure 4

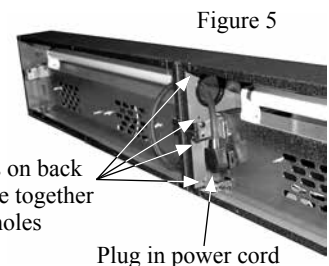

Figure 5

Lay both units on back side and secure together with 4 screw holes

Plug in power cord

IMPORTANT!!

No labor warranty. One year parts warranty only. If any issues occur contact the factory immediately for assistance at 800.748.0423, 8AM to 5PM EST, Monday through Friday.

SAVE THESE INSTRUCTIONS

Read all instructions before using this device.

When using a lighted liquor display, basic precautions should always be followed, including the following:



DANGER - To reduce the risk of electric shock:

1. Always unplug this device from the electrical outlet before cleaning or servicing.



WARNING - To reduce the risk of burns, fire, electric shock or injury to persons:

1. Unplug from outlet before changing bulb assemblies, or otherwise servicing.
2. Use this device only for its intended use as described in these instructions.
3. Never operate this device if it has a damaged cord or plug, if it is not working properly, if it has been dropped or damaged, or if it has been saturated with liquid. Contact the factory for return authorization and repair options.
4. Never operate this device with the air openings blocked. Keep the air openings free of lint, dust, and the like.
5. To disconnect, turn unit off then remove the plug from outlet.
6. Keep cord away from heated surfaces.
7. Do not use outdoors.



WARNING - Risk of electrical shock – connect this furnishing to a properly grounded outlet only. See Grounding Instructions.

GROUNDING INSTRUCTIONS

This product must be grounded. If it should malfunction or breakdown, grounding provides a path of least resistance for electric current to reduce the risk of electric shock. This product is equipped with a cord having an equipment-grounding conductor and a grounding plug. The plug must be plugged into an appropriate outlet that is properly installed and grounded in accordance with all local codes and ordinances.



DANGER - Improper connection of the equipment-grounding conductor can result in a risk of electric shock. Check with a qualified electrician or serviceman if you are in doubt as to whether the product is properly grounded. Do not modify the plug provided with the product - if it will not fit the outlet, have a proper outlet installed by a qualified electrician.

This product is for use on a nominal 120-volt circuit and has a 3-prong grounding plug. Make sure that the product is connected to an outlet having the same 3-prong configuration as the plug. No adapter should be used with this product.

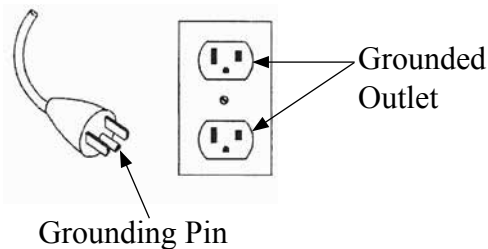

WIRING DIAGRAM FOR 24" LLD, LLDS, AND LLD3

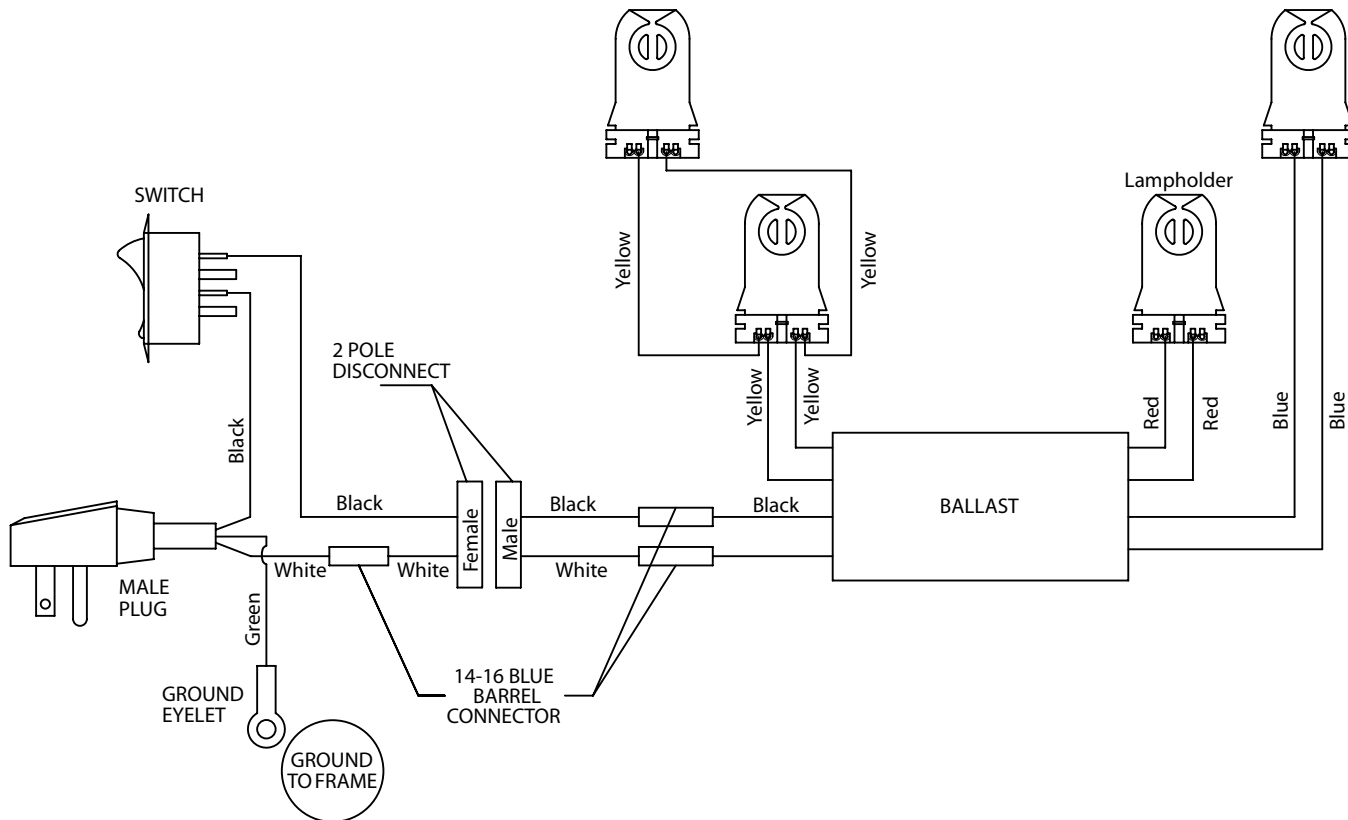

WIRING DIAGRAM FOR 30"-54" LLD, LLDS, AND LLD3

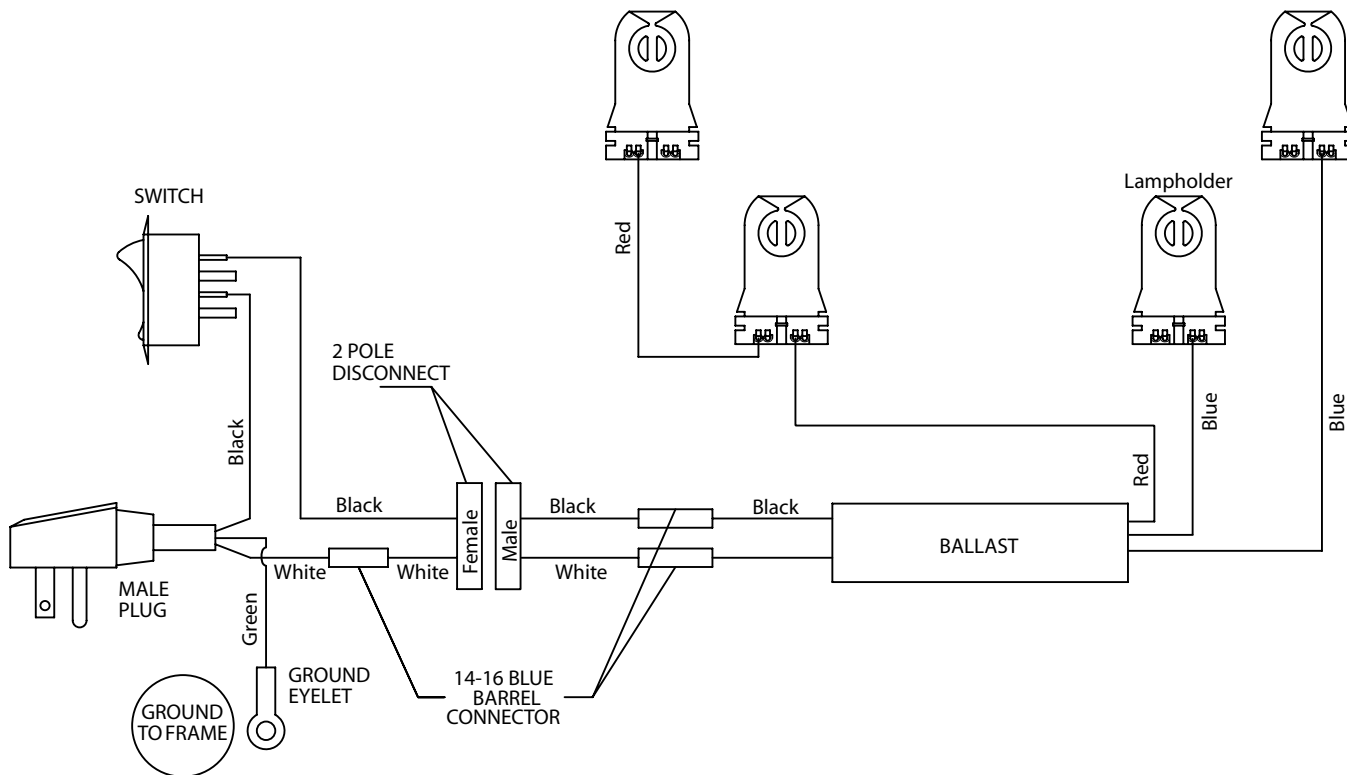

WIRING DIAGRAM FOR 60"-108" LLD, LLDS, AND LLD3

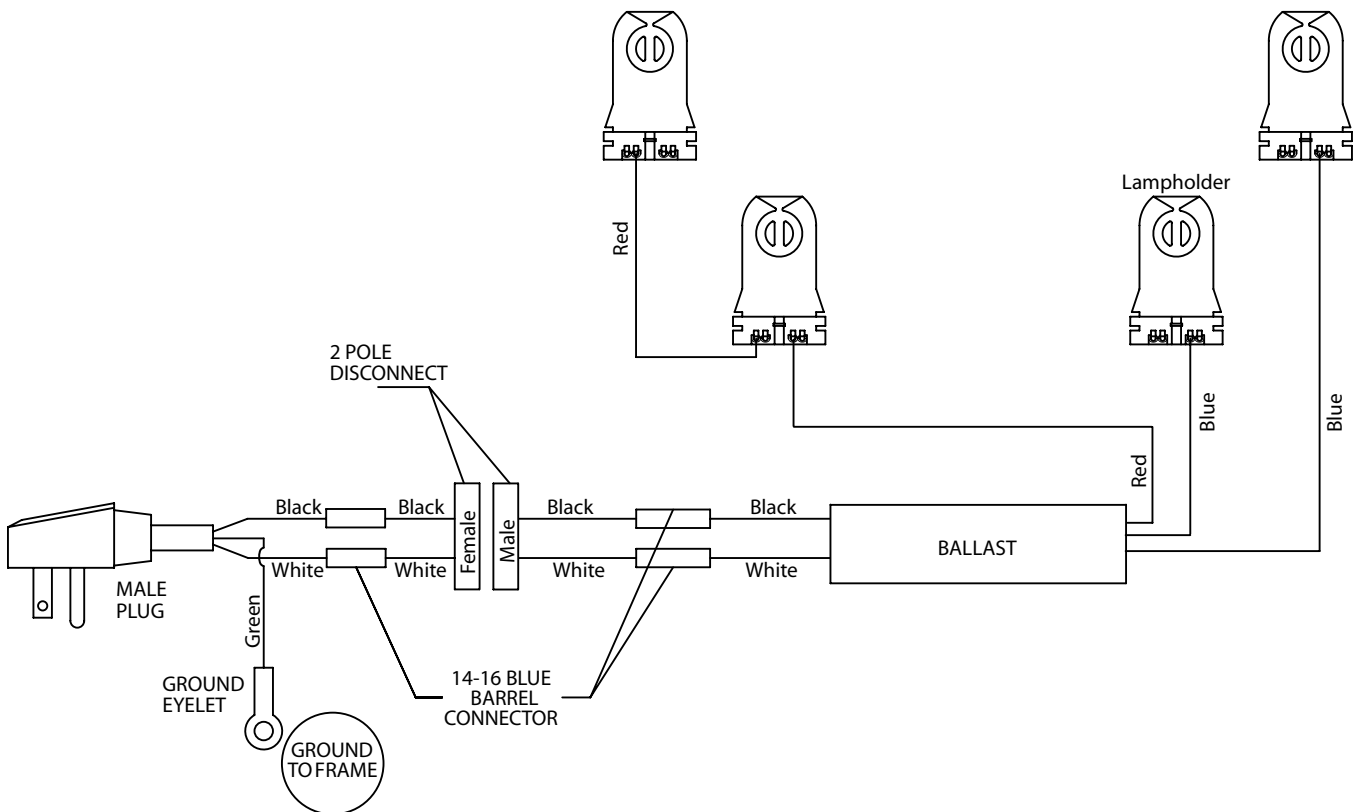
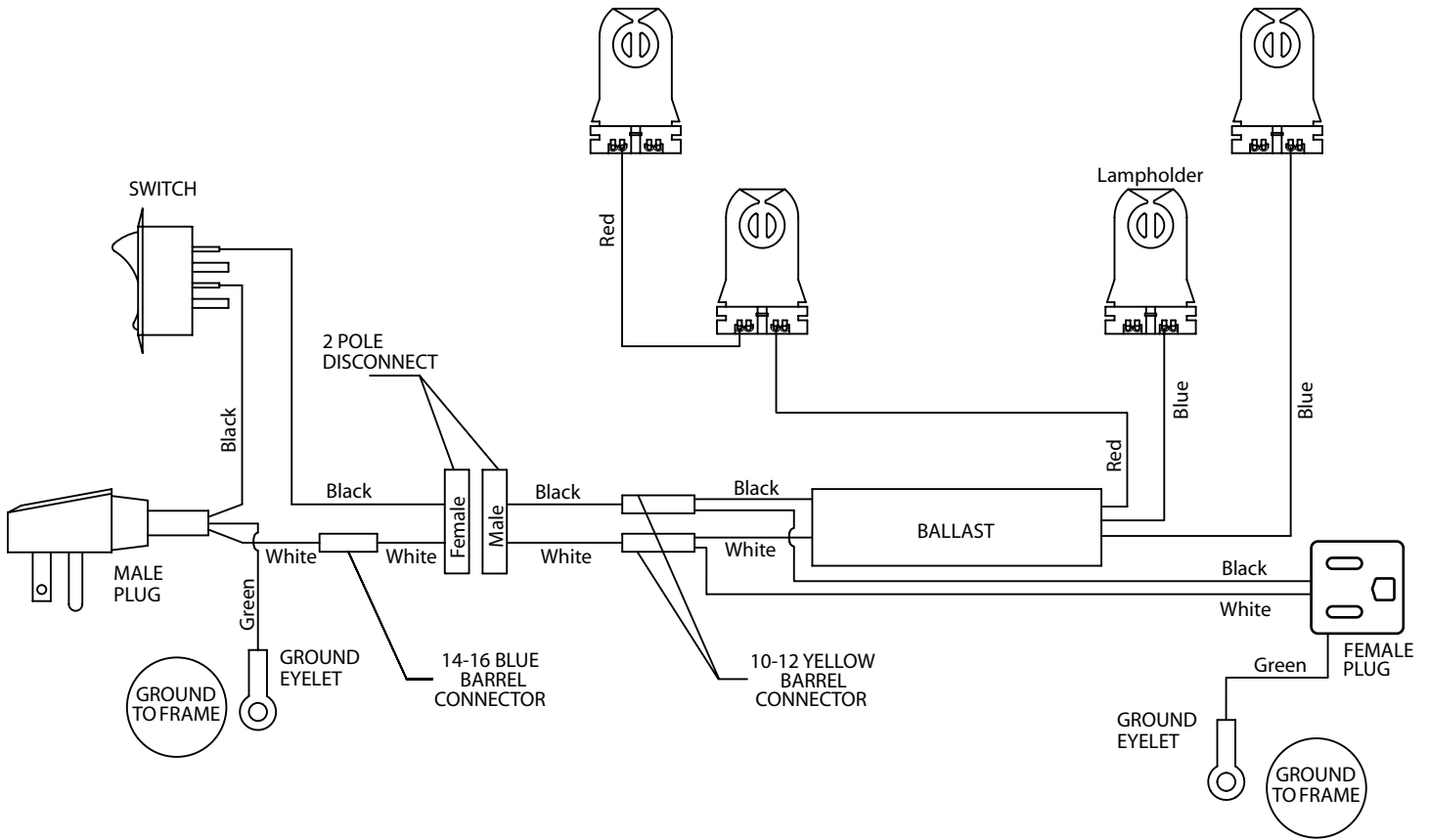

REPLACEMENT PARTS



Part No.	Description	Price
1. 06001422	Ballast, 2 lamp, (LLD24)	140.00
12000323	Ballast, 2 lamp, 32W T8 for use with 24", 36" & 48" bulbs	76.00
2. 12000530	Lamp holder, Fluorescent light, set of 2	9.50
3. 12000324	Bulb, Fluorescent 18" T8 (LLD24)	14.00
12000325	Bulb, Fluorescent 24", 17W T8 (LLD30, LLD36)	14.00
12000326	Bulb, Fluorescent 36", 25W T8 (LLD42, LLD48)	14.00
12000322	Bulb, Fluorescent 48", 32W T8 (LLD54)	10.00
4. 06009527	Power cord, 132" long	35.00
5. 12000314	Panel, front, LLD24 1/8" x 2-7/8" x 21-5/8", clear plexiglass	8.00
12000315	Panel, front, LLD30 1/8" x 2-7/8" x 27-5/8", clear plexiglass	10.00
12000316	Panel, front, LLD36 1/8" x 2-7/8" x 33-5/8", clear plexiglass	12.00
12000317	Panel, front, LLD42 1/8" x 2-7/8" x 39-5/8", clear plexiglass	14.00
12000318	Panel, front, LLD48 1/8" x 2-7/8" x 45-5/8", clear plexiglass	16.00
12000319	Panel, front, LLD54 1/8" x 2-7/8" x 51-5/8", clear plexiglass	18.00
6. 12000414	Top, 24", 2 tier, clear PVC	95.00
12000415	Top, 30", 2 tier, clear PVC	95.00
12000416	Top, 36", 2 tier, clear PVC	120.00
12000417	Top, 42", 2 tier, clear PVC	130.00
12000418	Top, 48", 2 tier, clear PVC	140.00
12000419	Top, 54", 2 tier, clear PVC	170.00
12000420	Top, 24", 3 tier, clear PVC	150.00
12000421	Top, 30", 3 tier, clear PVC	175.00
12000422	Top, 36", 3 tier, clear PVC	190.00
12000423	Top, 42", 3 tier, clear PVC	220.00
12000424	Top, 48", 3 tier, clear PVC	250.00
12000425	Top, 54", 3 tier, clear PVC	270.00

