

# Operation Manual & Parts List

---

# Glastender®

A Family Company Manufacturing In The USA Since 1969

GT-24, GT-30

**GLASSWASHERS** (Manufactured after June 1, 1990 with digital temperature gauges)

---



GT-24-CW



GT-30-CCW

---

Glastender, Inc. · 5400 North Michigan Road · Saginaw, MI · 48604-9780  
800.748.0423 · 989.752.4275 · Fax 989.752.4444 · [www.glastender.com](http://www.glastender.com)



# WARRANTY STATEMENT

## APPLICABLE TO ALL PRODUCTS SOLD WITHIN THE UNITED STATES AND CANADA

Glastender, Inc. warrants all products to be free of defects in material and workmanship. One-year labor and parts warranty applies to all glasswashers, self-contained refrigeration models, and BDS model bottle disintegration units. In established areas, a start up is included with GT-24 and GT-30 model glasswashers. Warranty is effective for one year from the date of installation or up to 18 months from date of factory shipment, whichever occurs sooner. Glastender, Inc. will replace any part or assembly found defective under normal use and service.

For warranty labor claims beyond 15 months from the date of factory shipment, proof of date of installation or occupancy must be provided. Authorization for labor must be obtained from Glastender within the warranty period and prior to the service being performed.

Labor warranty applies to the United States and Canada only.

Remote refrigeration models and beer line chillers include a one-year parts warranty only. There is no labor warranty on these products.

Field replacement parts not covered under the original warranty include a 90-day part warranty from the date of installation.

**FOUR YEAR ADDITIONAL COMPRESSOR WARRANTY:** Glastender will warrant to the original user the compressor for all self-contained refrigeration models for an additional four years following the regular one-year warranty period. This plan applies to the compressor only.

A completed warranty claim form **MUST** accompany all returned defective parts or assemblies. Upon request, a defective part or assembly must be returned to Glastender, Inc., Saginaw, Michigan, with all transportation and delivery charges prepaid. Warranty repairs or replacements will be shipped FOB factory in Saginaw, Michigan. Reimbursement for applicable freight charges covers ground service only.

Glastender provides in-warranty repairs during a service company's regular working days and hours. There is no provision for payment of a premium rate during "overtime" hours. When warranty service is requested during other than normal working hours, the end user will be charged the premium portion of the overtime rate.

The warranty covers substantiated travel expenses for up to 2 hours / 100 miles round trip up to a maximum of \$150. Any additional costs due to installations that require extra work, time, or travel to gain access for service are the sole responsibility of the equipment purchaser. Any exceptions to these travel and access limitations must be pre-approved by a factory representative.

The warranty does not cover door gaskets, chemical tubing, pump squeeze tubing, and/or any equipment subjected to accidents, freight damage, alterations from the original design, improper power and/or plumbing hookups, improper chemical use, general misuse, or lack of routine required maintenance as determined by Glastender, Inc. Installation, normal control adjustments, general maintenance, correcting an installation error, or service calls that reveal the unit is functioning normally will not be reimbursed under warranty.

Condenser coils on self-contained refrigeration products must be cleaned regularly. Failure to provide adequate air flow to a refrigeration unit will void the warranty.

Glastender shall not be liable for loss of use, revenue, or profit, or for any other indirect, incidental, special, or consequential damage including, but not limited to, product spoilage or loss.

This warranty is conditioned upon Glastender receiving notice of any defect subject to this warranty within sixty (60) days of its discovery by the end user or dealer. All products are warranted only for the initial place of installation. Removal of a product automatically terminates this warranty.

### SECOND YEAR EXTENDED PARTS & LABOR WARRANTY:

Glastender's one-year parts and labor warranty on self-contained refrigeration units, excluding beer line chillers, can be extended to two years with the purchase of a two year parts and labor warranty. Specify part number EWR2 (\$150 net price) when ordering.

EXPORT WARRANTY - One year parts only.

### EXCLUSION OF WARRANTIES

EXCEPT AS PROVIDED ABOVE, GLASTENDER MAKES NO WARRANTIES, EXPRESS OR IMPLIED, INCLUDING, BUT NOT LIMITED TO, ANY IMPLIED WARRANTY OF MERCHANTABILITY, FITNESS FOR A PARTICULAR PURPOSE OR NON-INFRINGEMENT.

**LIMITATION OF REMEDIES AND DAMAGES** If Buyer makes a valid and timely claim as outlined above, Glastender's liability and Buyer's remedies under this agreement will be limited solely to labor charges authorized and/or replacement or credit, at Glastender's option, with respect to Products returned at Buyer's expense within thirty (30) days after warranty repair. GLASTENDER'S LIABILITY WILL IN NO EVENT BE GREATER IN AMOUNT THAN THE PURCHASE PRICE OF THE RETURNED PRODUCTS. GLASTENDER WILL NOT BE LIABLE UNDER ANY CIRCUMSTANCE FOR CONSEQUENTIAL OR INCIDENTAL DAMAGES, INCLUDING, BUT NOT LIMITED TO, LABOR COSTS EXCEPT AS COVERED UNDER OUR WARRANTY, LOST PROFITS OR THE LOSS OF PERISHABLE PRODUCTS RESULTING FROM THE USE OF OR INABILITY TO USE OUR PRODUCTS OR FROM OUR PRODUCTS' INCORPORATION INTO OR BECOMING A COMPONENT OF ANY OTHER PRODUCT. NEITHER PARTY WILL HAVE ANY NEGLIGENCE OR OTHER TORT LIABILITY TO THE OTHER, OR TO ANY THIRD PARTY, ARISING FROM ANY BREACH OF THIS AGREEMENT.

### GOVERNING LAW - JURISDICTION

The terms and conditions of an order are to be governed and construed according to the laws of the State of Michigan, without regard to conflict of laws principles. Buyer hereby consents to the jurisdiction and venue of the courts located in Saginaw County, Michigan.

No representative, distributor, dealer, or any other person is authorized to modify this warranty. This warranty replaces all other written or verbal warranties.

NOTE: Glastender, Inc.'s policy of constant quality improvement means that prices, specifications, and policies are subject to change without notice. Questions regarding this warranty should be directed to Glastender's Warranty Administrator.

04-19-17

## **IMPORTANT!!**

### Attention Service Companies

Please review the important warranty information on this page. If you believe a service call should be covered by the factory, please call the factory for authorization between 8AM and 5PM EST, Monday through Friday.

# INDEX

Exterior Components.....	3-4	Drive Assembly Components .....	11-12
Glass Stops, Curtains, Rinse Tank Guides and Conveyors .....	5-6	Recirculating Pump Components .....	13-16
Spray Boxes, Gaskets, Inlet Screens and Level Controls.....	7-8	Chemical Tubing, Level Sensor Tubing and Related Parts .....	17-18
Electrical Components.....	9-10	Peristaltic Pump Components.....	19-22
		Plumbing Components.....	23-24

## TERMS AND CONDITIONS

### PRICES:

All prices are LIST. Applicable taxes will be added.

### QUOTATIONS:

Unless otherwise stated, quotations are effective for 30 days only.

### ACCEPTANCE:

All orders are subject to acceptance by Glastender, Inc.'s headquarters in Saginaw, Michigan. Possession of the Product Directory and Price List is not an offer to sell.

### SHIPMENTS:

F.O.B. factory in Saginaw, Michigan. Freight terms are Third Party or Collect if shipped directly to you. Prepay and Add to Invoice freight terms are available upon request. The approximate shipping weights of all products are listed with the prices. Partial shipments will be made unless otherwise specified by the customer. Surface freight classifications are:

- GT-24/GT-30/GW24 Glasswashers - Class 175
- GT-18 Glasswashers - Class 250
- All Underbar Equipment - Class 175
- Bar Die Orders – Class 250
- Portable Bars - Class 175
- Remote refrigerators (i.e., no compressor) or dry storage back bar equipment - Class 175
- Self-contained refrigeration equipment - Class 150
- Ice Display Units (IDU and GDU) - Class 85
- Lighted Liquor Displays - Class 85
- Beer line chillers and beer towers (beverage dispensing equipment) - Class 92.5
- Bottle Disintegration System - Class 150
- Ice Cream Freezers - Class 77.5

All small items are evaluated to see the most cost effective means for shipment. Many small items ship via UPS or FedEx; however, when dimensional weight is excessive, LTL carriers are the most cost effective choice. Spare parts orders received before 1:00 PM EST can usually be shipped the same day.

The order department is happy to assist with routing or shipping questions.

### PAYMENT TERMS:

Cash should be included with all orders unless credit terms have been arranged. To establish credit, banking and trade references are required. A convenient credit application is available upon request. Payment via credit card is not our normal means of receiving payment. Visa and

MasterCard will be accepted, but must be charged at the time of shipment. In addition, a payment via credit card for orders totaling more than \$500 will incur a 3% convenience fee on the total transaction amount.

### DELIVERY:

The majority of equipment is manufactured to order and typically ships within three to six weeks after complete order information is received by the factory. In-stock equipment typically ships within two to three days of the factory receiving complete order information.

### RETURNS:

Items specified as "Manufactured to Order" are NOT returnable.

A Return Authorization number must be issued by the factory in advance for any items that are returnable. The number MUST be noted on the outside of the returned package. Returns must be received within 90 days of the issue date. Shipping charges must be prepaid. A minimum 20% restocking charge will be applied to all authorized returns if received in new, unused condition in the original packaging.

The above conditions apply to spare part returns, except spare part returns must be received within 30 days of original shipment for electronic or electrical parts or within 90 days for all other parts.

### LOSS OR DAMAGE:

For customer routed shipments, Glastender, Inc. is not responsible for any loss, damage, or delay of merchandise during shipment. Such transit claims must be filed with the carrier. Merchandise must be examined on arrival. If shortages occur, Glastender, Inc. must be notified in writing within five (5) days of delivery to honor any shortage claim. Glastender will assume responsibility for freight claims on Prepay and Add shipments but the customer must inspect freight and note any damage upon receipt. Failure to do so may result in losses at the customer's expense.

### CUSTOM ORDERS:

Custom orders must be paid in advance and are not subject to cancellation.

### LAMINATES:

Some products include common, readily available plastic laminates of the customer's selection. There may be an additional charge if uncommon varieties are ordered.

12/14/17

# EXTERIOR COMPONENTS

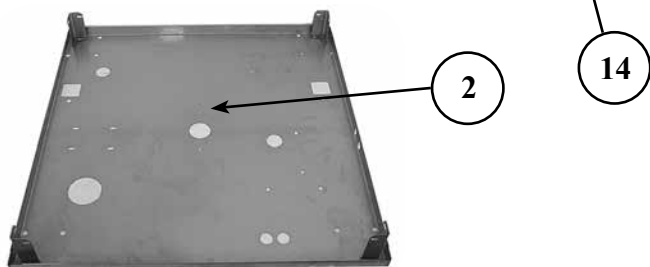
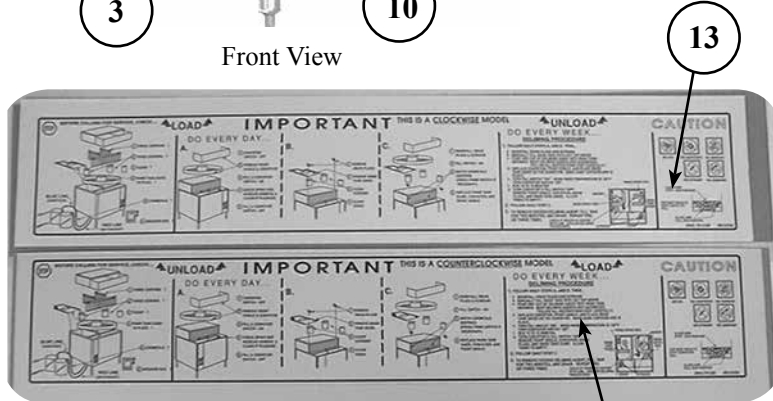
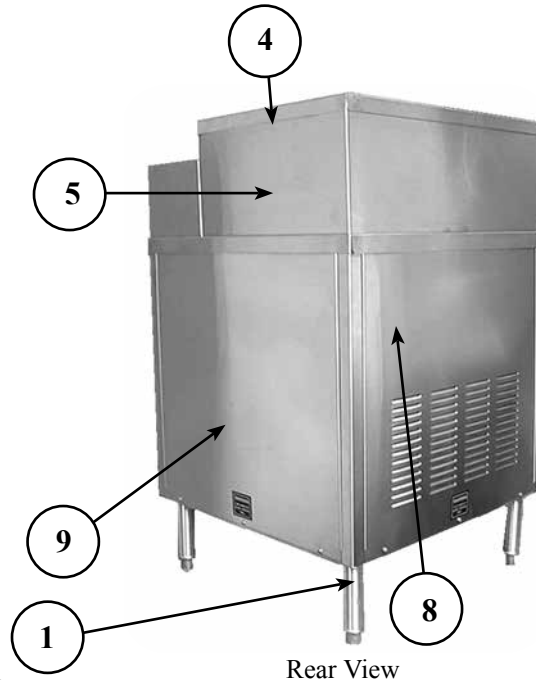
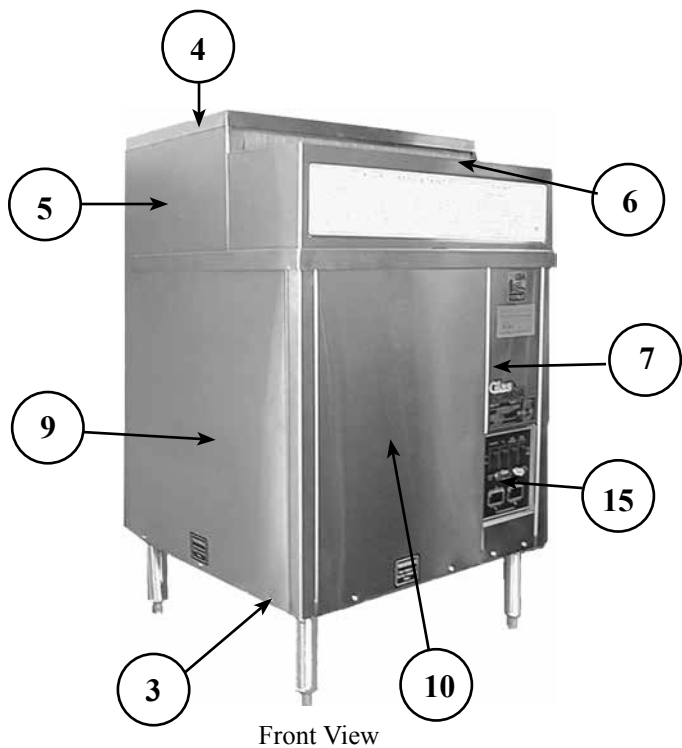

Counterclockwise Model Shown

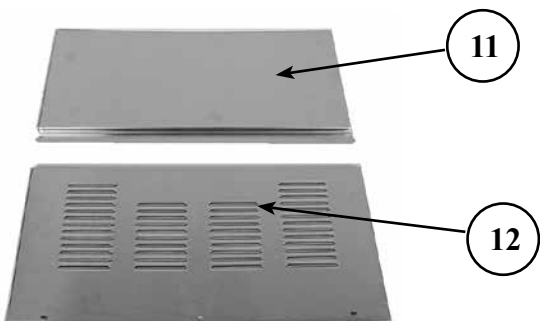

Counterclockwise Model Shown

# EXTERIOR COMPONENTS

<u>PART NO.</u>	<u>DESCRIPTION</u>	<u>PRICE</u>
1. 04000111	Leg, stainless steel, 7" (4 required)	\$39.00
00000041	Bolt, leg, 1/4"-20 x 5/8" (4 required per leg)	.50
2. 01000701	Floor, GT-24, clockwise	278.00
01000702	Floor, GT-24, counterclockwise	278.00
01000703	Floor, GT-30, clockwise	328.00
01000704	Floor, GT-30, counterclockwise	328.00
3. 00000031	Screw, exterior, 10-24 x 1/2", PPH, SMS, 410 SS	1.00
4. 01000715	Skin top, GT-24	76.00
01000718	Skin top, GT-30	102.00
5. 01000716	Top, GT-24, clockwise	749.00
01000717	Top, GT-24, counterclockwise	749.00
01000719	Top, GT-30, clockwise	942.00
01000720	Top, GT-30, counterclockwise	942.00
6. 01000713	Front shield, GT-24 (decal not included)	140.00
01000714	Front shield, GT-30 (decal not included)	167.00
7. 01000628	Panel, switch, GT-24 and GT-30 (decal not included)	89.00
8. 01000629	Panel, back, GT-24	89.00
01000634	Panel, back, GT-30	106.00
9. 01000630	Panel, side, GT-24 (2 required)	83.00
01000635	Panel, side, GT-30 (2 required)	101.00
10. 01000631	Panel, front, GT-24 (15-1/2")	76.00
01000636	Panel, front, GT-30 (21-1/2")	104.00
11. 01000632	Panel, split front, TOP, GT-24	48.00
01000637	Panel, split front, TOP, GT-30	60.00
12. 01000633	Panel, split front, BOTTOM, GT-24	48.00
01000638	Panel, split front, BOTTOM, GT-30	60.00
13. 01000487	Decal, cleaning instructions, clockwise	26.00
14. 01000488	Decal, cleaning instructions, counterclockwise	25.00
15. 01000494	Decal, switch panel	12.00
16. 01000678	Tank complete, GT-24, clockwise (includes all welded components)	2,260.00
01000679	Tank complete, GT-24, counterclockwise (includes all welded components)	2,260.00
01000680	Tank complete, GT-30, clockwise (includes all welded components)	2,625.00
01000681	Tank complete, GT-30, clockwise (includes all welded components)	2,625.00

# GLASS STOPS, CURTAINS, RINSE TANK GUIDES, AND CONVEYORS

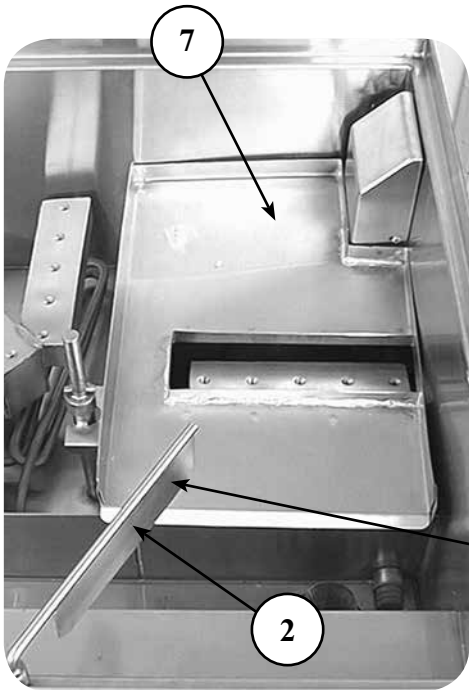

Clockwise Model Shown

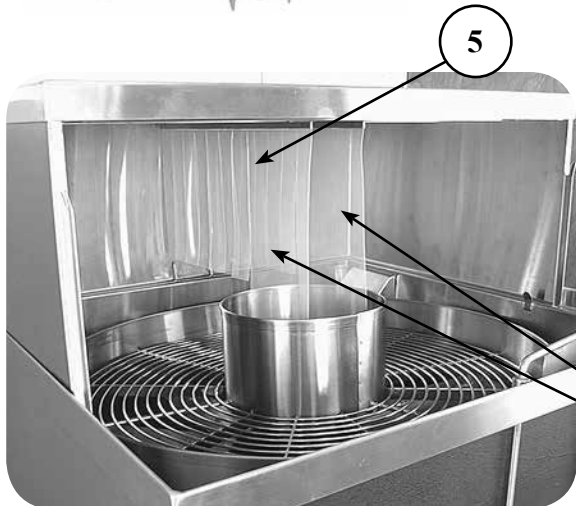
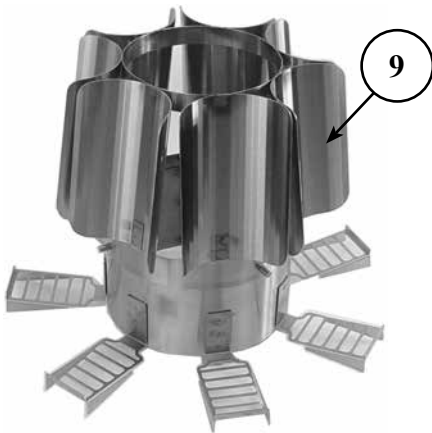
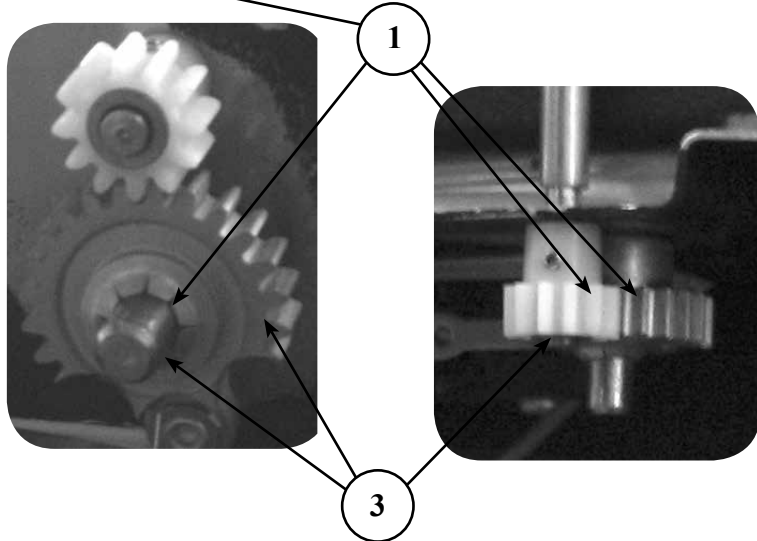

# GLASS STOPS, CURTAINS, RINSE TANK GUIDES, AND CONVEYORS

<u>PART NO.</u>	<u>DESCRIPTION</u>	<u>PRICE</u>
1. 01000727	Glass stop arm assembly, GT-24 (consists of: 01000728, 01000729, 01000730, and 01000731)	\$78.00
01000733	Glass stop arm assembly, GT-30 (consists of: 01000732, 01000729, 01000730, and 01000731)	80.00
2. 01000728	Glass stop arm with flag, GT-24	50.00
01000732	Glass stop arm with flag, GT-30	52.00
3. 01001592	Kit, gears, glass stop arm actuator (consists of 01000730, 01000729, 01000731)	30.00
4. 01000653	Curtain, front, GT-24	40.00
01000654	Curtain, front, GT-30	50.00
5. 01000655	Curtain, wash or rinse, GT-24, 13-1/2" (2 required)	25.00
01000656	Curtain, wash or rinse, GT-30, 17" (2 required)	31.00
6. 01000684	Curtain set, GT-24 (consists of: two 01000653 and two 01000655)	130.00
01000685	Curtain set, GT-30 (consists of: two 01000654 and two 01000656)	160.00
7. 01000659	Rinse tank guide, GT-24, clockwise	64.00
01000660	Rinse tank guide, GT-24, counterclockwise	64.00
01000661	Rinse tank guide, GT-30, clockwise	74.00
01000662	Rinse tank guide, GT-30, counterclockwise	74.00
8. 01000563	Conveyor, GT-24	460.00
01000565	Conveyor, GT-30	574.00
9. 01000534	Stemware rack for GT-24	295.00
01000535	Stemware rack for GT-30	385.00

# SPRAY BOXES, GASKETS, INLET SCREENS, AND LEVEL CONTROLS

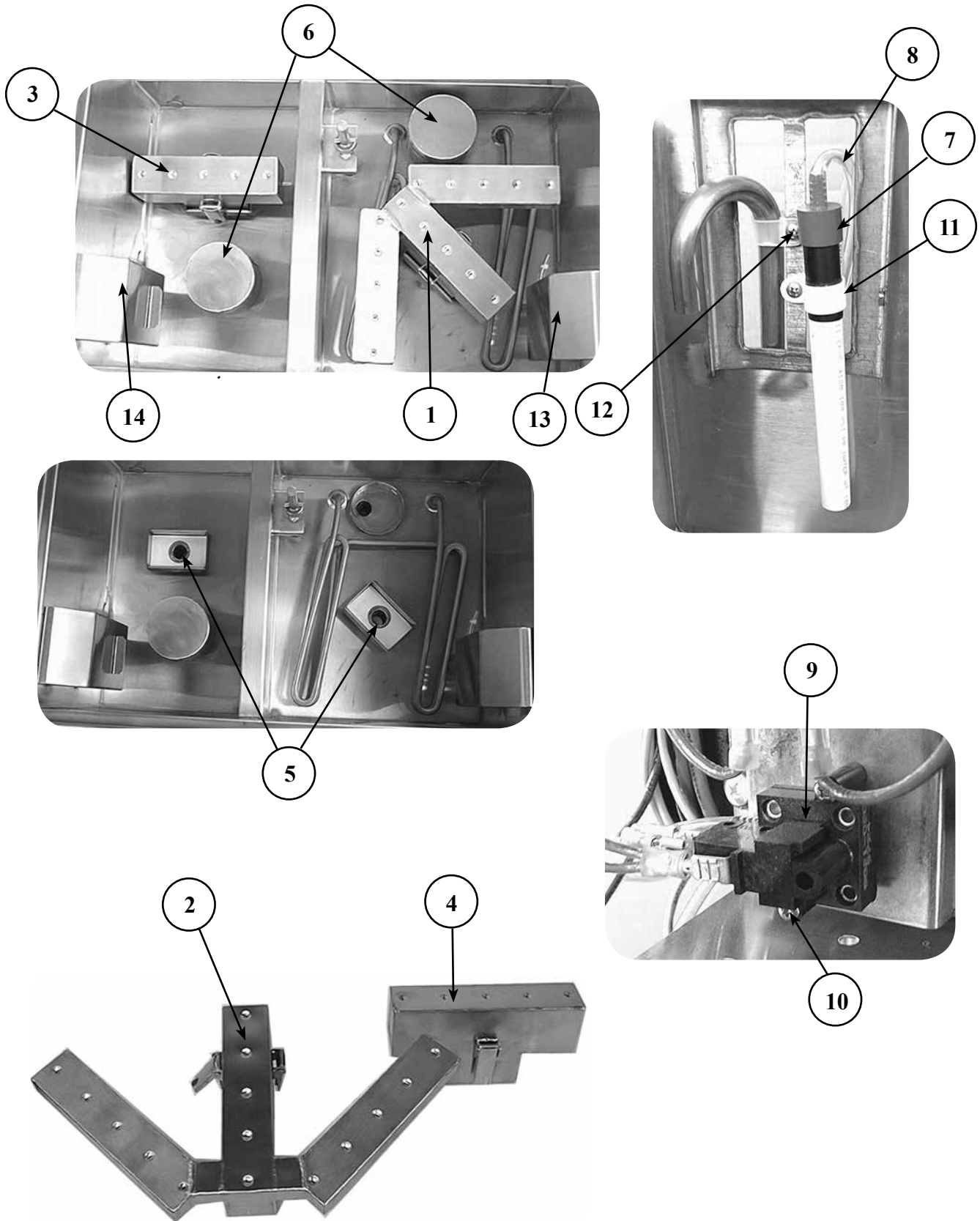

# SPRAY BOXES, GASKETS, INLET SCREENS, AND LEVEL CONTROLS

<u>PART NO.</u>	<u>DESCRIPTION</u>	<u>PRICE</u>
1. 01000663	Spray box, wash, GT-24	\$454.00
2. 01000664	Spray box, wash, GT-30	479.00
3. 01000665	Spray box, rinse, clockwise, GT-24	227.00
01000668	Spray box, rinse, counterclockwise, GT-24	227.00
4. 01000666	Spray box, rinse, GT-30	240.00
5. 01000470	Gasket, wash or rinse spray box (GT-24 and GT-30)	5.00
01000471	Gasket set, spray box (consists of: (2) 01000470)	10.00
6. 01000675	Screen, pump inlet (GT-24 and GT-30)	70.00
7. 01000520	Pickup tube, liquid level	16.00
8. 01000521	Tubing, liquid level, GT-24 (36" long)	6.00
01000522	Tubing, liquid level, GT-30 (42" long)	8.00
9. 01000550	Switch, liquid level and low level air	35.00
10. 00000022	Screw, air switch mounting, #6 x 1/2"	.50
11. 00000001	Clamp, cable, white nylon, 5/8" ID	.50
12. 00000025	Screw, water inlet straps, pickup tube straps, and water inlet cover, 8-32 x 5/8"	.50
13. 01000644*	Cover, pickup tube and water inlet, wash	48.00
14. 01000645*	Cover, pickup tube and water inlet, rinse	48.00

\* NOTE: For these parts, you must specify if the unit is clockwise or counterclockwise when ordering.

# ELECTRICAL COMPONENTS

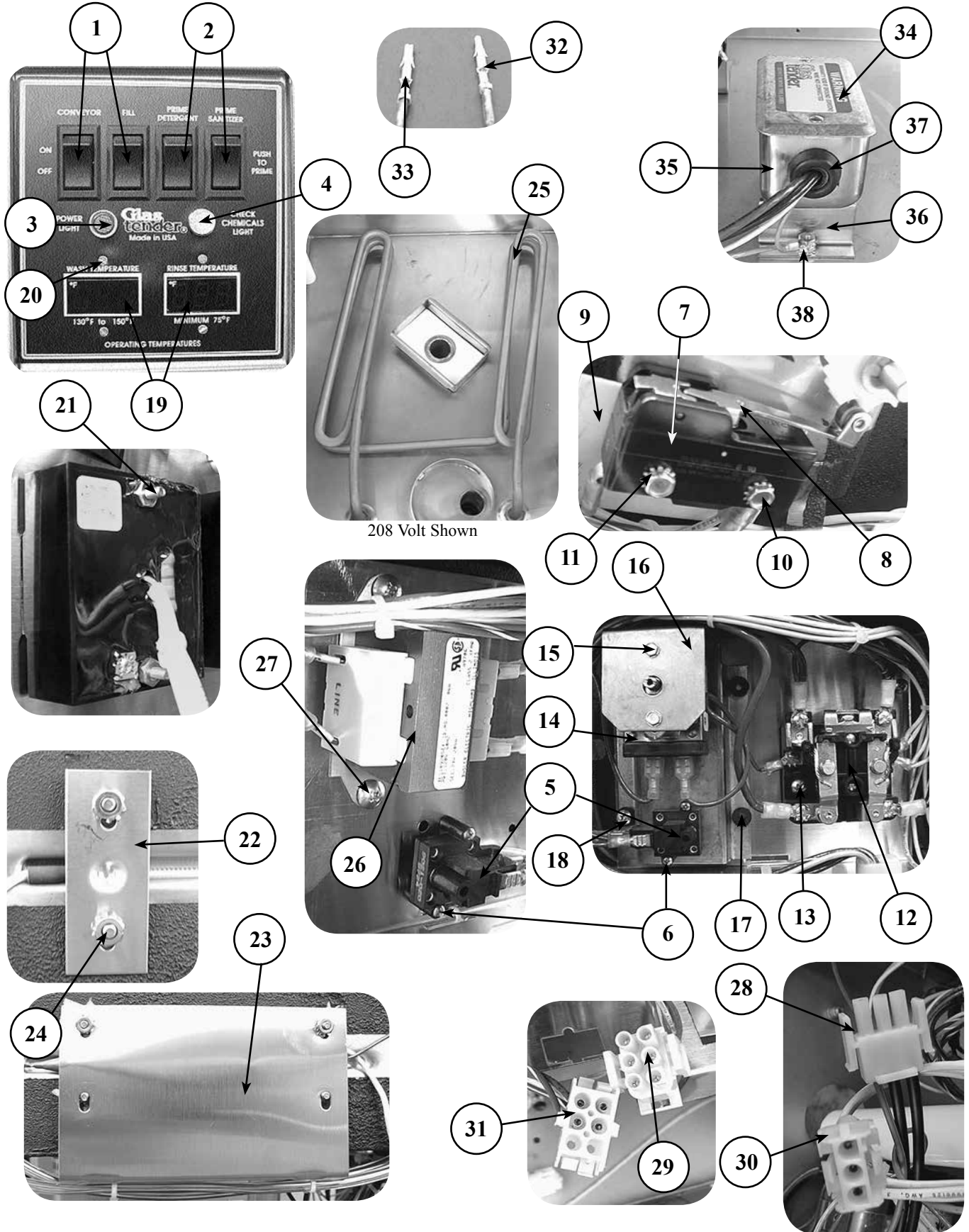

208 Volt Shown

# ELECTRICAL COMPONENTS

<u>PART NO.</u>	<u>DESCRIPTION</u>	<u>PRICE</u>
01000608	Wire harness, GT-24 and GT-30	\$165.00
1. 01000549	Switch, conveyor and fill (2 required)	18.00
2. 07000257	Switch, prime, momentary (2 required)	20.00
3. 01000591	Light, power, green, 240VAC	11.00
4. 01000593	Light, check chemicals, flasher, 125VAC	20.00
5. 01000550	Switch, liquid level and low level air	35.00
6. 01000866	Screw, air switch mounting, 4-40 x 3/4" phillips (2 required)	1.00
7. 01000551	Switch, glass stop with roller	56.00
8. 01000859	Spring, 18-1/2 ounce	10.00
9. 07000259	Switch insulator	1.50
10. 00000032	Screw, switch retaining, 6-32 x 1", HH, MS, zinc (2 required)	.50
11. 01000641	Washer, switch retaining screw, star, #6 (2 required)	.50
12. 01000554	Relay, 120V	80.00
13. 00000050	Screw, relay mounting, 10-32 x 1-1/4" PPH, MS, SS (2 required)	.50
14. 01000545	Thermostat	110.00
15. 00000022	Screw, thermostat mounting, #6 x 1/2" (2 required)	.50
16. 01000484	Bracket, thermostat mounting	5.00
17. 01000740	Grommet, thermostat mounting bracket, relay mounting	1.00
18. 00000044	Screw, thermostat mounting bracket, 10 x 5/8", PPH, zinc (2 required)	.50
19. 01000606	Gauge, digital temperature with probe	145.00
20. 00000023	Screw, temperature gauge mounting, flat head, 4-40 x 1"	.50
21. 01000618	Nut, temperature gauge mounting, 4-40	.50
22. 01000741	Retaining plate, rinse tank sensor bulb	2.00
23. 01000738	Cover, thermometer	4.00
24. 00000026	Nut, sensor and thermostat bulb, retaining plate, electrical box mounting, 8-32	.50
01000641	Washer, sensor and thermostat bulb, retaining plate, star, #6	.50
25. 01001586	Heater kit, perimeter style, 240 volt (replaces 01000583)	265.00
01001587	Heater kit, perimeter style, 208 volt (replaces 01000584)	265.00
26. 01000555	Transformer, low level sensor and temperature gauges (primary - 120VAC, secondary - 24VAC)	53.00
27. 00000039	Screw, transformer mounting, 10-32 x 3/8" phillips, TH, MS, SS	.50
28. 01000669	Plug, three wire	1.00
29. 06001537	Plug, six wire	1.50
30. 01000547	Receptacle, three wire	1.00
31. 06001634	Receptacle, six wire	1.50
32. 01000670	Plug, solderless terminal	.50
33. 01000548	Receptacle, solderless terminal	.50
34. 06001584	Cover, electrical box	1.50
35. 00000168	Electrical box	4.00
36. 01000474	Bracket, electrical box	17.00
37. 06001552	Grommet, electrical box	3.50
38. 00000076	Bolt, electrical box, 8-32 x 1/2", hex head (2 required)	.50
01000642	Lockwasher, large, star, #10	.50

# DRIVE ASSEMBLY COMPONENTS

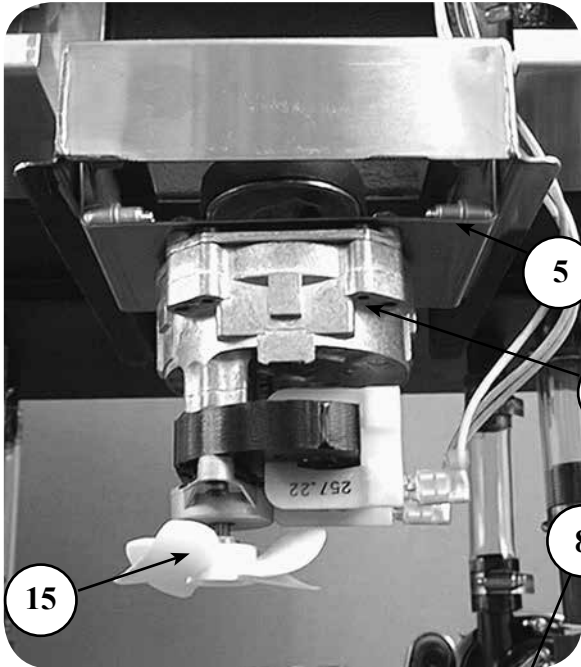

CCW View

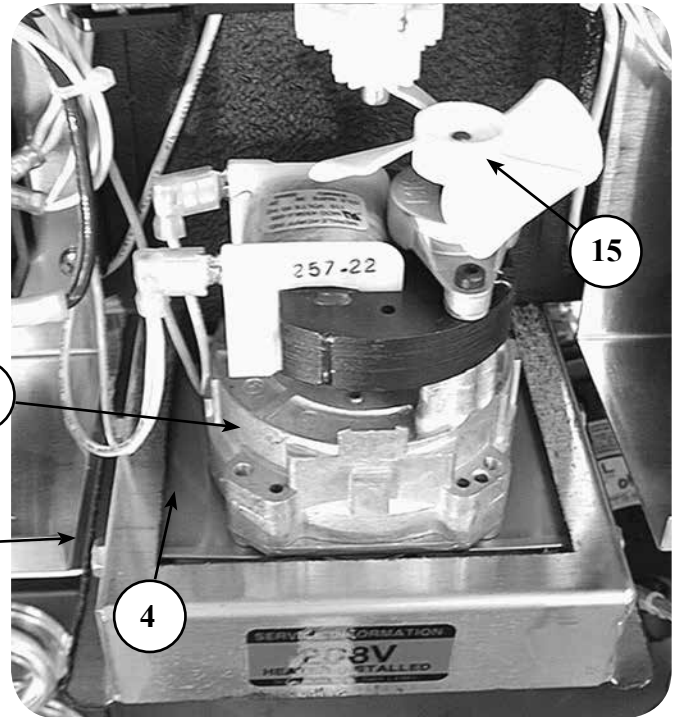

CW View

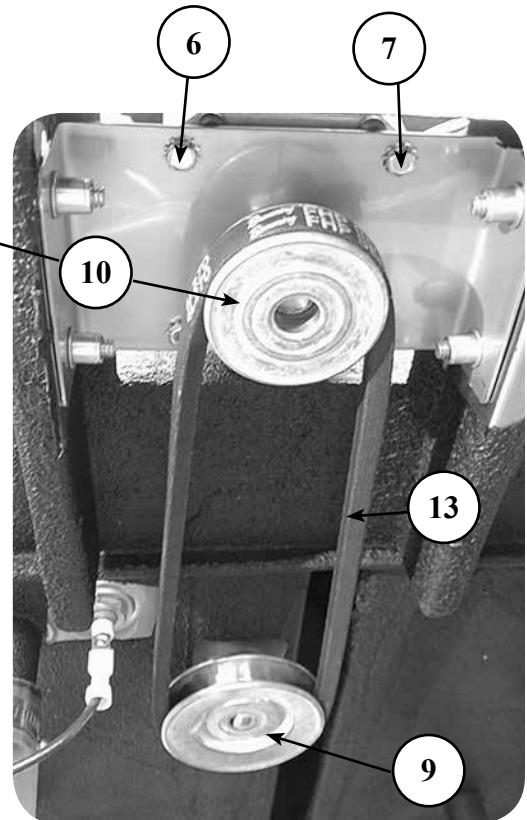
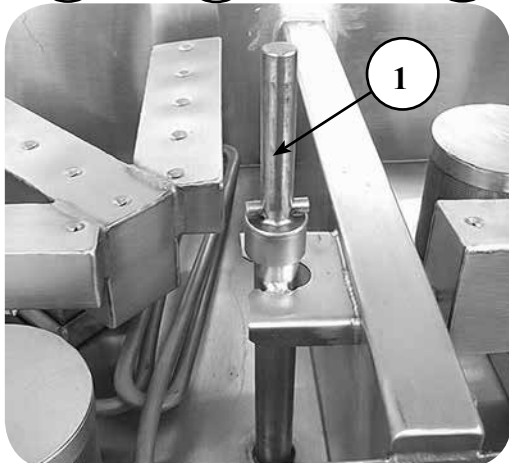
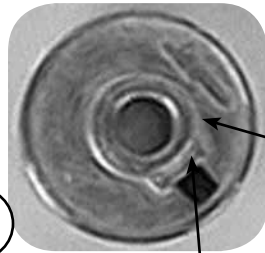
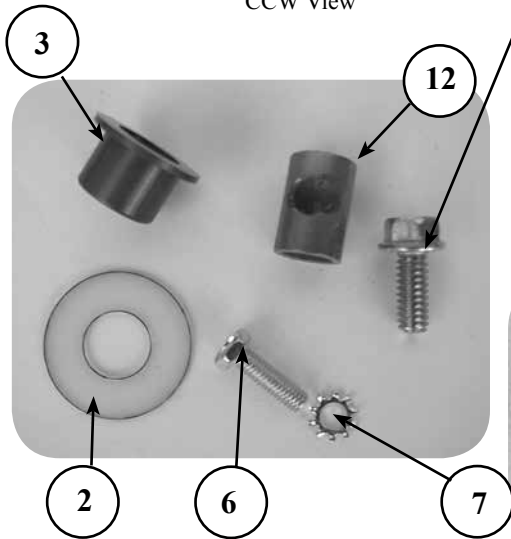

# DRIVE ASSEMBLY COMPONENTS

<u>PART NO.</u>	<u>DESCRIPTION</u>	<u>PRICE</u>
1. 01000801	Drive shaft	\$111.00
2. 01000847	Washer, drive shaft, nylon (3 required)	.50
3. 01000671	Flange bearing (2 required)	3.00
4. 01000475	Mount, motor, clockwise rotation	26.00
5. 01000476	Mount, motor, counterclockwise rotation	26.00
6. 01000855	Screw, drive motor mounting, 10-32 x 5/8" (4 required)	.50
7. 01000642	Lockwasher, #10, drive motor mounting screw (4 required)	.50
8. 00000041	Bolt, motor mounting to tank, hex, washer head, 1/4"-20 x 5/8" (4 required)	.50
9. 01000467	Pulley, 3", with set screw and machined center, drive shaft	20.00
10. 01000466	Pulley, 2", with set screw and sleeve, drive motor	14.00
11. 00000024	Screw, set, drive shaft or drive motor pulley, 5/16"-18 x 1/2"	.50
12. 01000735	Sleeve, drive motor pulley, 3/8" to 1/2"	6.00
13. 01000587	Belt, 27", GT-24	20.00
01000588	Belt, 33", GT-30	20.00
14. 01000594	Motor, drive, 1/2 RPM (Merkle-Korff)	225.00
15. 01000531	Fan blade, drive motor	3.00
01001590	Fan blade, drive motor, black, REX	3.00

# RECIRCULATING PUMP COMPONENTS

MANUFACTURED PRIOR TO NOVEMBER 2004

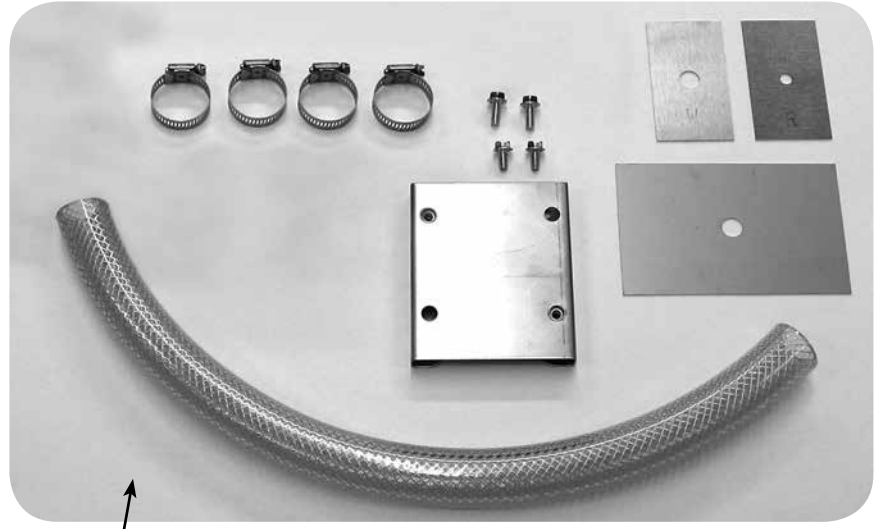
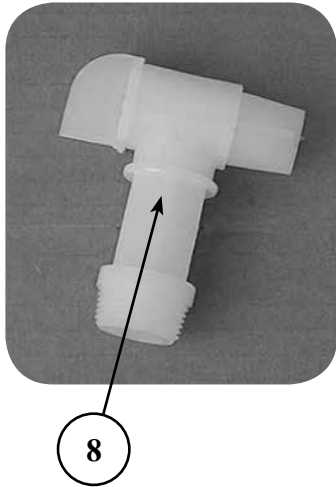
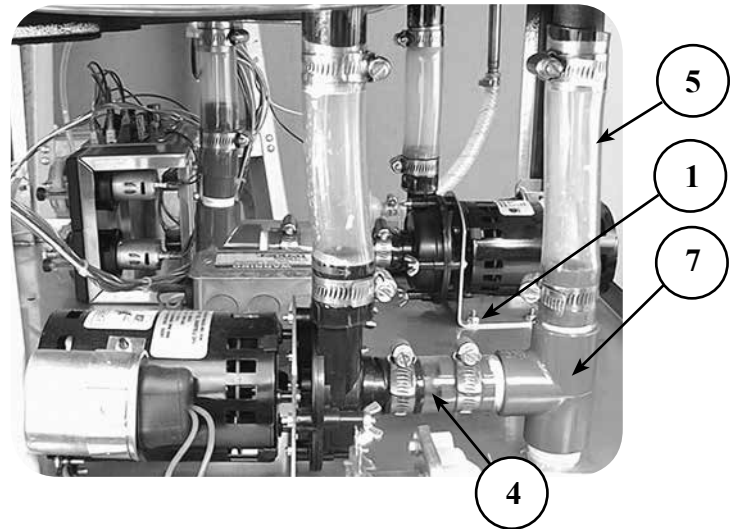
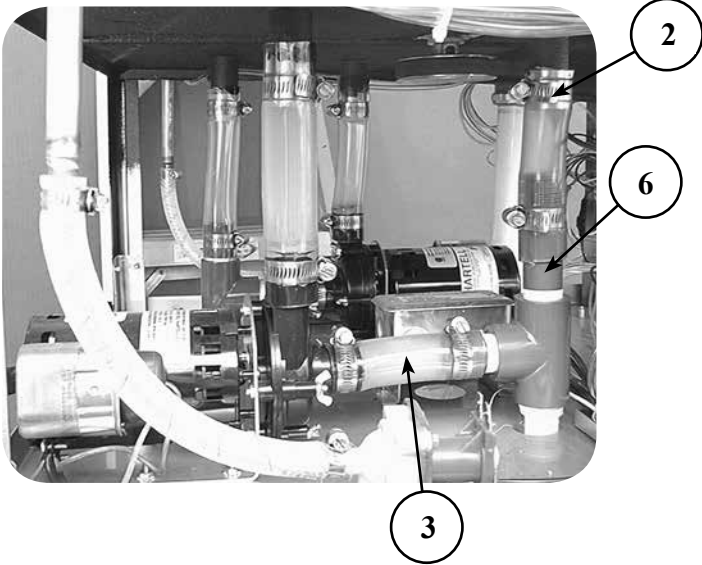

9 Recirculating Pump Kit  
Curtain not pictured

# RECIRCULATING PUMP COMPONENTS

MANUFACTURED PRIOR TO NOVEMBER 2004

<u>PART NO.</u>	<u>DESCRIPTION</u>	<u>PRICE</u>
1. 00000076	Bolt, water recirculating pump mounting, 8-32 x 1/2", hex head (4 required per pump)	.50
01000642	Lockwasher, water recirculating pump mounting, large, star, #10	.50
00000026	Nut, water recirculating pump mounting, 8-32	.50
2. 00000000	Clamp, water recirculating pump hose (6 required per pump)	1.00
3. 01000612	Hose, bottom, long, wash pump, GT-24	5.00
01000614	Hose, bottom, long, wash pump, GT-30	5.00
4. 01000613	Hose, bottom, short, rinse pump, GT-24	4.00
01000615	Hose, bottom, short, rinse pump, GT-30	4.00
5. 01000616	Hose, top (2 required per pump)	5.00
06001468	Hose, 1" ID x 1-1/4" OD x 1/8" (per foot)	5.00
6. 01000598	Pipe, PVC, 3/4" x 4"	4.00
7. 01000599	Tee, PVC, 3/4"	10.00
01000604	Pipe, PVC, 3/4" x 6" (GT-30 wash pump only)	4.00
8. 01000562	Valve, drain (2 required)	13.00
9. 01000826*	Mounting kit, MP water pump (pump not included)	92.00
10. 01000415	Pump, water recirculating, wash pump	660.00

\* These kits are needed to only when replacing Hartell Pumps, installed in Glasswashers prior to November 2004.

# RECIRCULATING PUMP COMPONENTS

MANUFACTURED NOVEMBER 2004 AND LATER

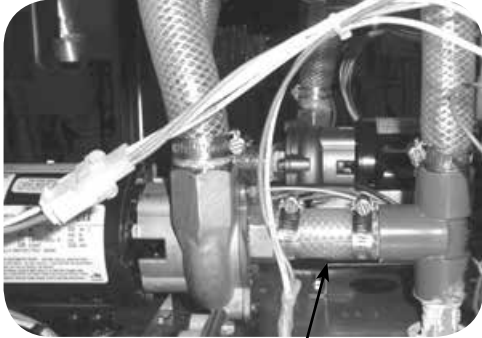

3

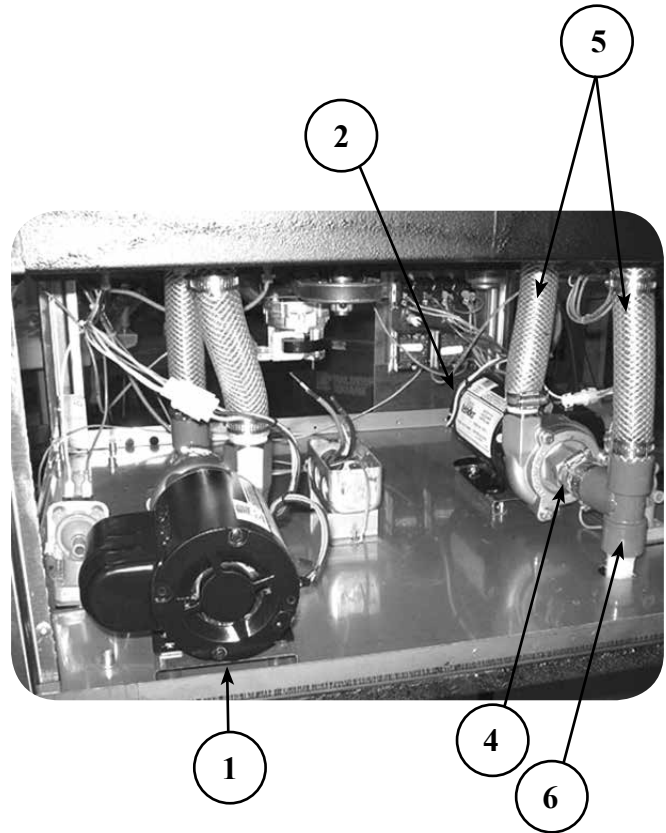

1

2

5

4

6

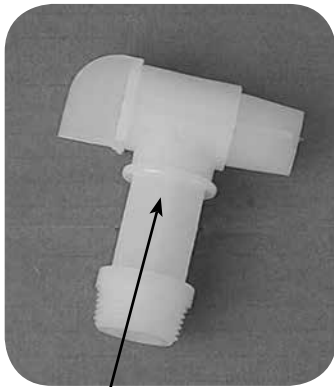

7

# RECIRCULATING PUMP COMPONENTS

MANUFACTURED NOVEMBER 2004 AND LATER

<u>PART NO.</u>	<u>DESCRIPTION</u>	<u>PRICE</u>
1. 01000415	Pump, water recirculating, all stainless construction with impellers, 115, (this pump is the larger of the two pumps)	660.00
2. 01001270	Pump, water recirculating, GT-24 and GT-30 rinse, 115V, 1/10 hp - for use in all GT-24 SN 24008346 and after and GT-30 SN 30005302 and after (built after May 1, 2008) (this pump is the smaller of the two pumps)	575.00
3. 01000612	Hose, bottom, long, wash pump, GT-24	5.00
01000614	Hose, bottom, long, wash pump, GT-30	5.00
4. 01000613	Hose, bottom, short, rinse pump, GT-24	4.00
01000615	Hose, bottom, short, rinse pump, GT-30	4.00
5. 01000616	Hose, top (2 required per pump)	5.00
6. 01000599	Tee, PVC, 3/4"	10.00
7. 01000562	Valve, drain (2 required)	13.00
01000851	Shaft seal, for wash pump 01000415	50.00
01000854	O-Ring, for wash pump 01000415	5.00
01000852	Impeller, for wash pump 01000415	42.00
01000853	Acorn nut, for wash pump 01000415	3.00

# CHEMICAL TUBING, LEVEL SENSOR TUBING, AND RELATED PARTS

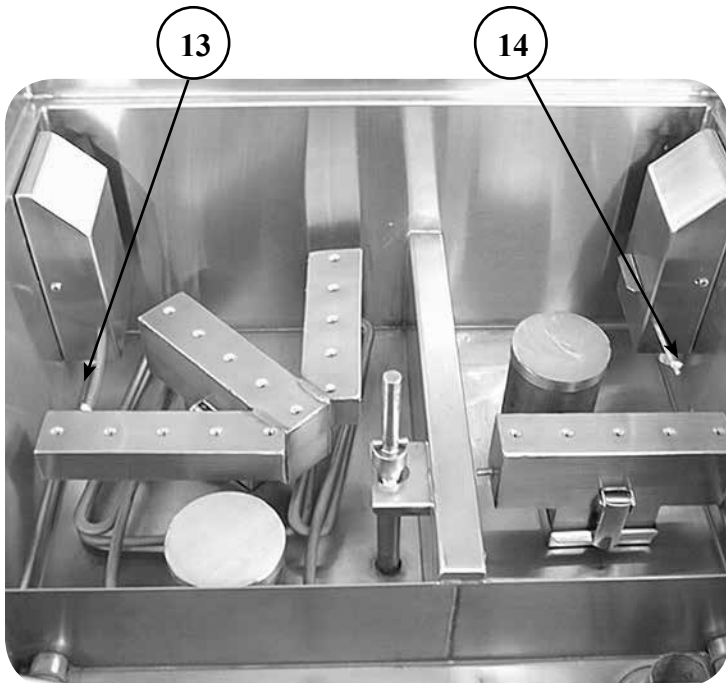
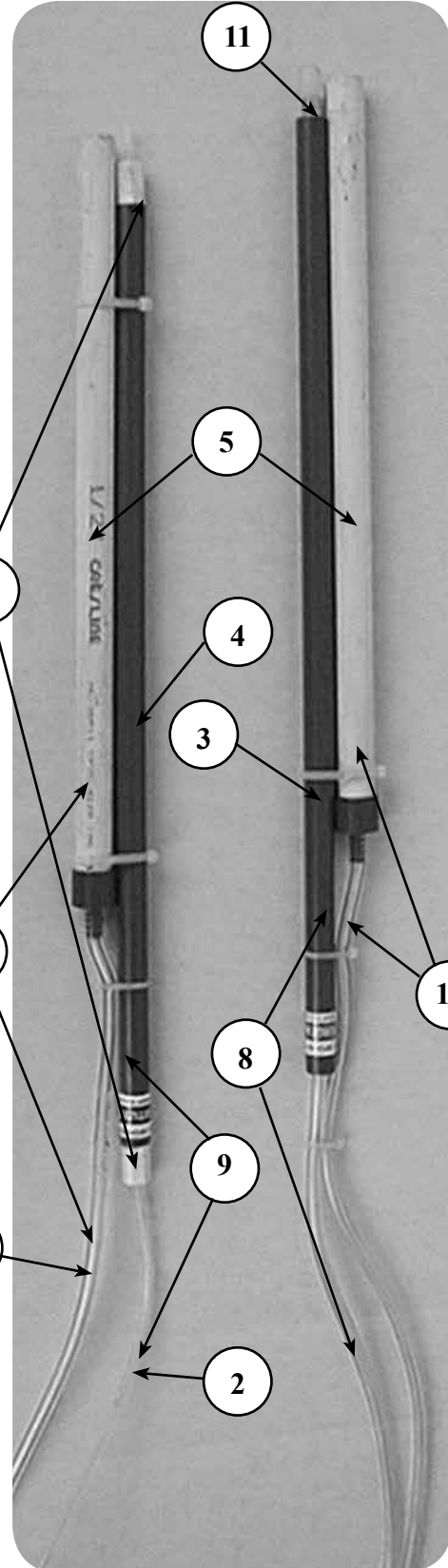

Clockwise Model Shown

# CHEMICAL TUBING, LEVEL SENSOR TUBING, AND RELATED PARTS

<u>PART NO.</u>	<u>DESCRIPTION</u>	<u>PRICE</u>
1. 01000517	Tubing, clear, 1/8" ID x 1/4" OD (per foot)	\$3.00
2. 01000527	Tubing, clear, 1/16" ID x 1/8" OD (per foot)	1.00
3. 01000526	Tubing support, detergent	6.00
4. 01000858	Tubing support, sanitizer	6.00
5. 01000518	Pickup tube, low level sensor, PVC	25.00
6. 01000485	Decal, detergent	1.00
7. 01000486	Decal, sanitizer	1.00
8. 01000696	Tubing, assembly, lower, detergent (consists of: 01000517 [6' length], 01000601, and 01000526)	20.00
9. 01000694	Tubing, assembly, lower, sanitizer (consists of: 01000527 [6' length], 01000858, and (2) 01000603)	20.00
10. 01000687	Tubing, assembly, liquid low level sensor (consists of: 01000517 [6' length], and 01000518)	37.00
11. 01000601	Fitting, chemical pickup, detergent, 1/8"	2.00
12. 01000603	Connector with nut, sanitizer feedline, 1/8" (2 required)	2.50
13. 01000697	Tubing, assembly, upper, detergent, 1/8" ID (6' length) (pump to tank)	12.00
14. 01000695	Tubing, assembly, upper, sanitizer, 1/16" ID (6' length) (pump to tank)	6.00

# ELECTRONIC PERISTALTIC PUMP COMPONENTS

MANUFACTURED PRIOR TO JANUARY 2003

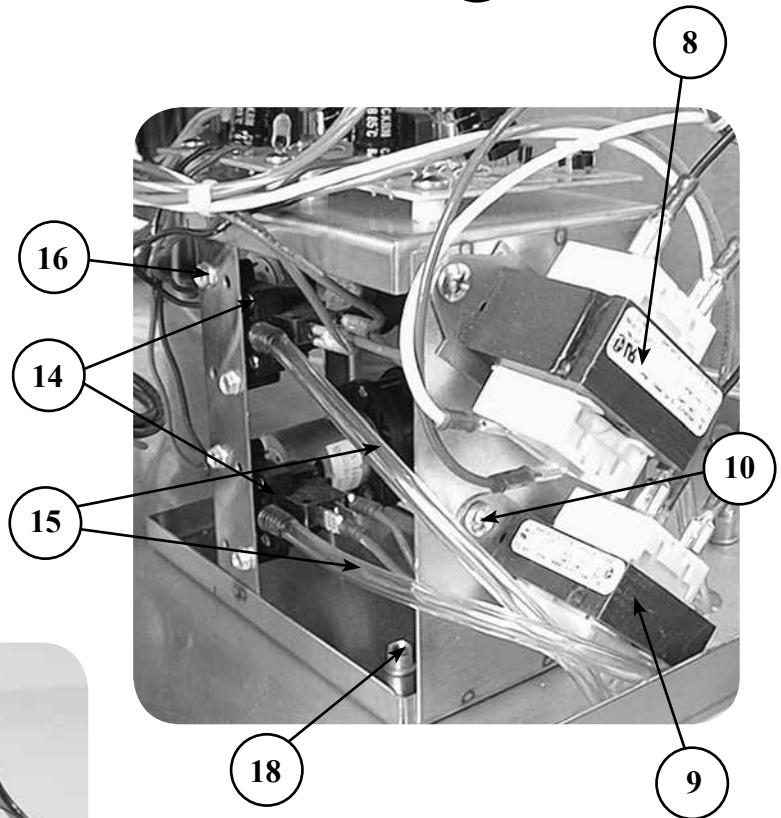
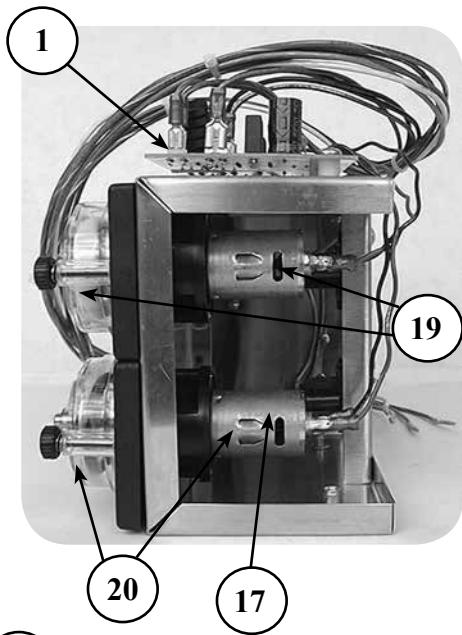
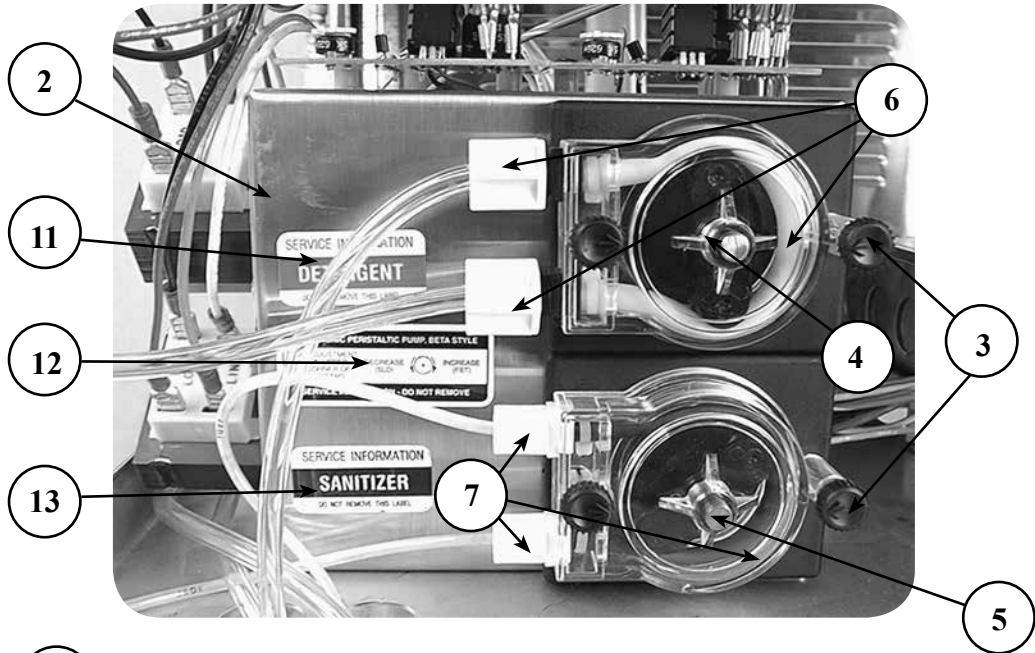

# ELECTRONIC PERISTALTIC PUMP COMPONENTS

MANUFACTURED PRIOR TO JANUARY 2003

<u>PART NO.</u>	<u>DESCRIPTION</u>	<u>PRICE</u>
01000829	Pump complete, dual, beta, with tubing assemblies	\$1,130.00
01000579	Pump complete, dual, beta, LESS tubing assemblies	700.00
1. NA	Circuit Board (no longer available, see parts numbers 01000543 & 01000544)	NA
2. 01000482	Bracket, dual pump, stainless steel	58.00
3. 01000578	Pin, snap clip (2 required per pump) DISCONTINUED	7.00
01001241	Pump cartridge kit, peristaltic pump (no tubing)	85.00
4. 01000571	Pump cartridge kit, detergent, pump tube with fittings, 1/8" ID, 1/4" OD	125.00
5. 01000577	Pump cartridge kit, sanitizer, pump tube with fittings, 1/16" ID, 1/8" OD	120.00
6. 01000692	Pump tube, detergent, with fittings, 1/8" ID	35.00
7. 01000693	Pump tube, sanitizer, with fittings, 1/16" ID	25.00
8. 01000555	Transformer, detergent, 24 volt (primary - 120VAC, secondary - 24VDC)	53.00
9. 01000558	Transformer, sanitizer, 12 volt	45.00
10. 00000030	Screw, transformer mounting, #10 x 1/2", PPH, SMS, drill kwik (2 required)	1.00
11. 01000485	Decal, detergent	1.00
12. 01000491	Decal, adjustment	1.00
13. 01000486	Decal, sanitizer	1.00
14. 01000550	Switch, liquid level and low level air (2 required)	35.00
15. 01000517	Tubing, liquid level control and low level sensor, 1/8" ID x 1/4" OD (per foot)	3.00
16. 00000022	Screw, air switch mounting, #6 x 1/2", HH, SMS	.50
17. 01000596	Motor drive, peristaltic pump	105.00
18. 00000039	Screw, pump bracket mounting, 10-32 x 3/8", PH, TH, MS, SS (2 required)	.50
01000642	Lockwasher, star, pump bracket mounting screw, #10	.50
19. 01000572	Pump cartridge and motor assembly, detergent (consists of: 01000571 and 01000596)	222.00
20. 01000575	Pump cartridge and motor assembly, sanitizer (consists of: 01000577 and 01000596)	217.00
21. 01000541	Relay timer only, sanitizer, 12VDC	125.00
01000543	Relay timer assembly, sanitizer, 12VDC	190.00
22. 01000542	Relay timer only, detergent, 24VDC	125.00
01000544	Relay timer assembly, detergent, 24 VDC	220.00

# ELECTRONIC PERISTALTIC PUMP COMPONENTS

MANUFACTURED JANUARY 2003 AND LATER

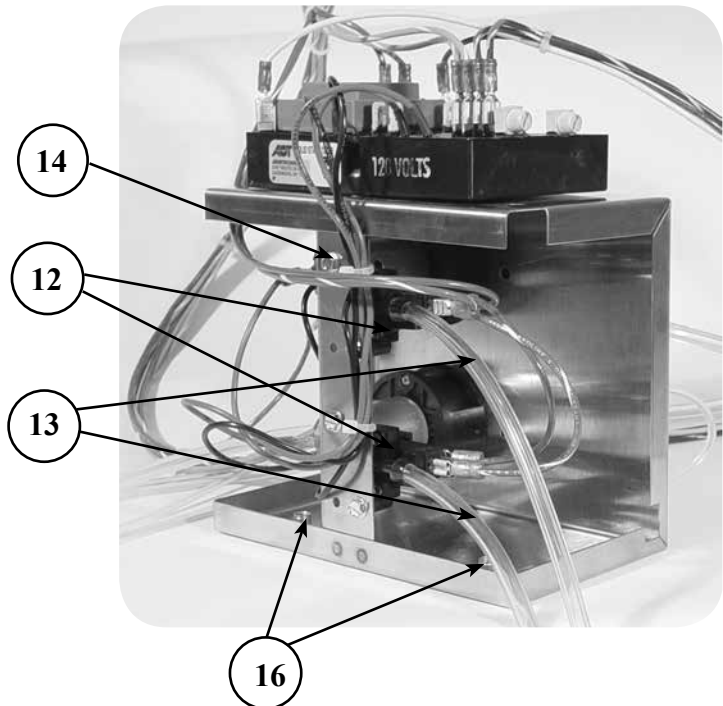
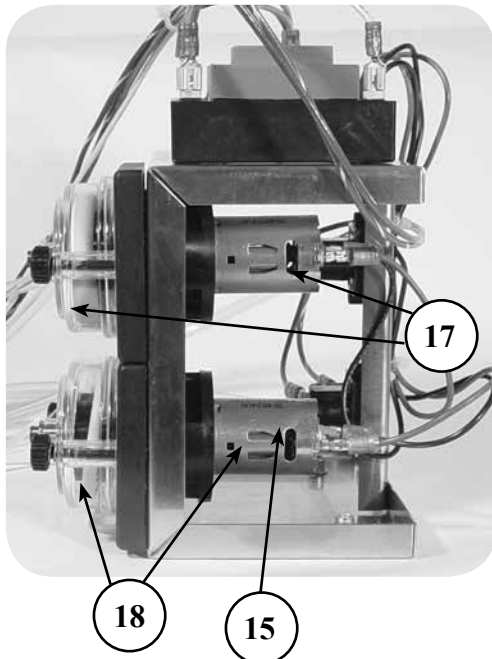
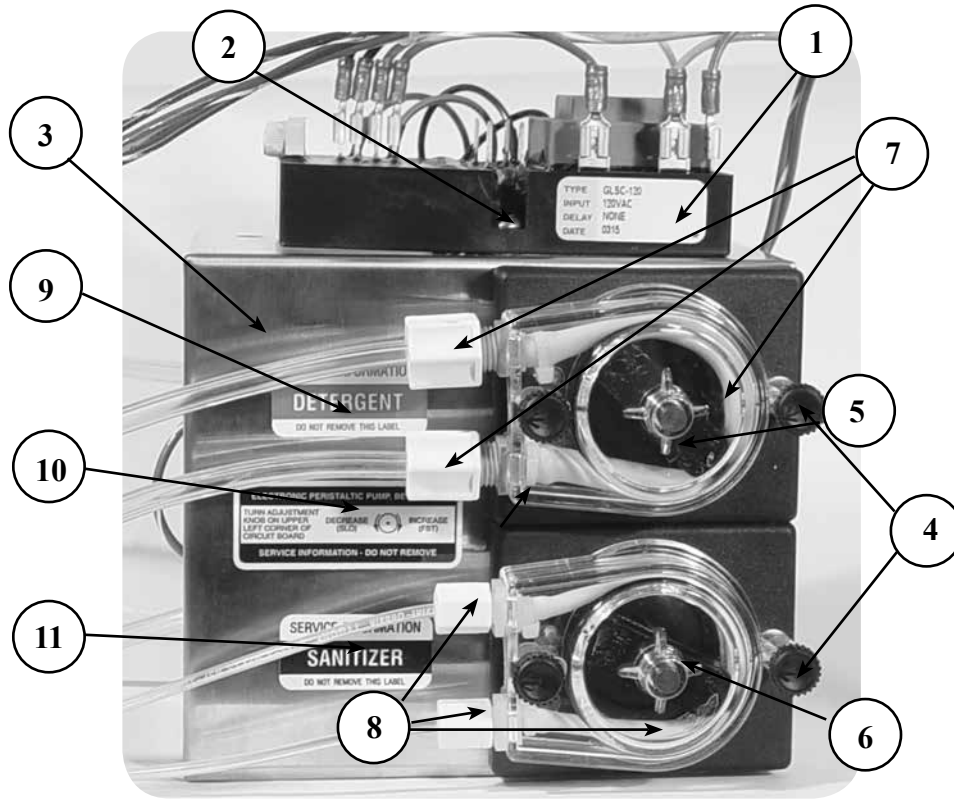

# ELECTRONIC PERISTALTIC PUMP COMPONENTS

MANUFACTURED JANUARY 2003 AND LATER

<u>PART NO.</u>	<u>DESCRIPTION</u>	<u>PRICE</u>
01000569	Peristaltic pump dual complete with tubing assemblies	\$780.00
01000856	Peristaltic pump dual complete LESS tubing assemblies	700.00
1. 01000540	Chemical Pump Control Module	190.00
2. 01000857	Screw, chemical pump control module mounting	.50
3. 01000482	Bracket, dual pump, stainless steel	58.00
4. 01000578	Pin, snap clip (2 required per pump) DISCONTINUED	7.00
01001241	Pump cartridge kit, peristaltic pump (no tubing)	85.00
5. 01000571	Pump cartridge kit, detergent, pump tube with fittings, 1/8" ID, 1/4" OD	125.00
6. 01000577	Pump cartridge kit, sanitizer, pump tube with fittings, 1/16" ID, 1/8" OD	120.00
7. 01000692	Pump tube, detergent, with fittings, 1/8" ID	35.00
8. 01000693	Pump tube, sanitizer, with fittings 1/16" ID	25.00
9. 01000485	Decal, detergent	1.00
10. 01000491	Decal, adjustment	1.00
11. 01000486	Decal, sanitizer	1.00
12. 01000550	Switch, liquid level and low level air (2 required)	35.00
13. 01000517	Tubing, liquid level control and low level sensor, 1/8" ID x 1/4" OD (per foot)	3.00
14. 00000022	Screw, air switch mounting, #6 x 1/2", HH, SMS	.50
15. 01000596	Motor, drive, peristaltic pump	105.00
16. 00000039	Screw, pump bracket mounting, 10-32 x 3/8", PH, TH, MS, SS (2 required)	.50
01000642	Lockwasher, star, pump bracket mounting screw, #10	.50
17. 01000572	Pump cartridge and motor assembly, detergent (consists of: 01000571 and 01000596)	222.00
18. 01000575	Pump cartridge and motor assembly, sanitizer (consists of: 01000577 and 01000596)	217.00

# PLUMBING COMPONENTS

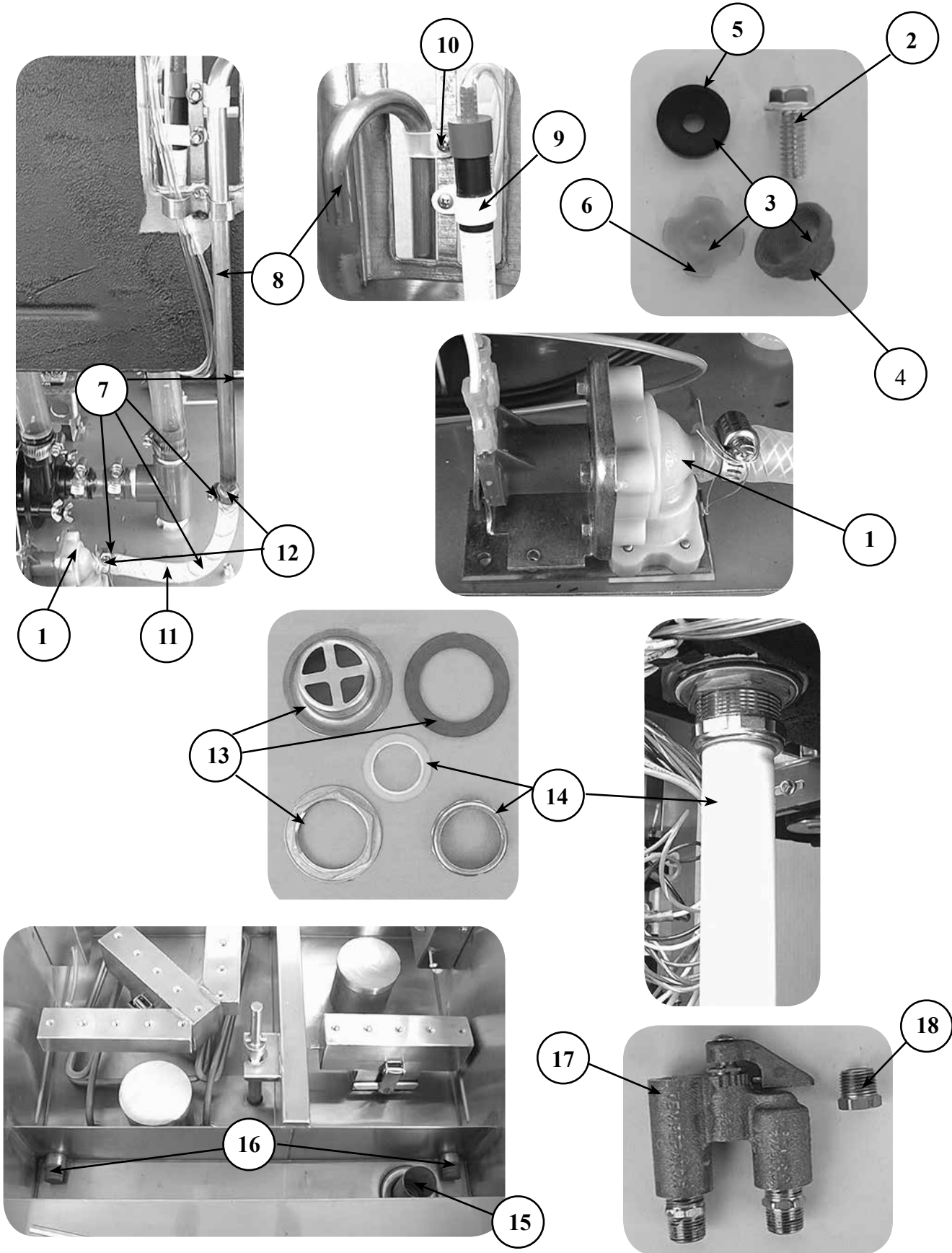

# PLUMBING COMPONENTS

<u>PART NO.</u>	<u>DESCRIPTION</u>	<u>PRICE</u>
1. 01000561	Valve, water inlet	\$55.00
2. 00000041	Bolt, water inlet valve mounting, 1/4"-20 x 5/8", HWH	.50
3. 01000672	Water inlet valve screen kit	9.00
4. 01000848	Screen, water inlet valve (K-017716)	2.00
5. 01000812	Washer, water inlet valve flow (K-27632)	8.00
6. 01000813	Retainer, water inlet valve flow washer (K-26554)	2.00
7. 01000688	Water inlet assembly, GT-24 (consists of: 01000617, 01001338, and two 01000469)	33.00
01000689	Water inlet assembly, GT-30 (consists of: 01000617, 01001338, and two 01000469)	34.00
8. 01001338	Tube, water inlet, stainless steel	14.00
9. 00000005	Clamp, cable white nylon, 1/2" ID	.50
10. 00000025	Screw, cable clamp, 8-32 x 5/8", PPH	.50
11. 01000617	Hose, nylon braided, water inlet (per foot)	1.60
12. 01000469	Clamp, hose (2 required)	1.00
13. 01000766	Drain fitting with nut and gasket, stainless, 1-1/2"	15.00
14. 01000967	Drain tailpiece kit	7.00
15. 01000674	Screen, drain	21.00
16. 01000770	Plug, wash or rinse tank drain (2 required)	14.00

## ACCESSORIES

17. 01000828	Valve, mixing (Central Brass #555)	223.00
18. 01000600	Adapter, water inlet valve, 1/4" MPT to 3/8" FMPT	5.00