

Operation Manual & Parts List

Glastender®

A Family Company Manufacturing In The USA Since 1969

BLC-1/3-E, BLC-1/3, BLC-1/3-2, BLC-1/2, BLC-1/2-2, BLC-3/4, BLC-3/4-2

REMOTE DRAFT BEER LINE CHILLERS



BLC-1/3-E



BLC-1/3-2



BLC-3/4-2

Glastender, Inc. · 5400 North Michigan Road · Saginaw, MI · 48604-9780
800.748.0423 · 989.752.4275 · Fax 989.752.4444 · www.glastender.com



INDEX

Beer Line Chiller Specifications.....	2
Inspection Upon Arrival	3
Set-Up Remote Glycol Line Chiller.....	3
Electrical Hook-Up.....	3
Glycol Line Connection.....	3
Glycol Filling.....	4
Unit Start-Up.....	4
System Start-Up.....	4
Electronic Temperature Control Programming	5
Cold Control Adjustment.....	5
Digital Controller Operation.....	6
Wiring Diagrams.....	7-8
BLC-1/3-E	7
BLC-1/3, BLC-1/3-2	7
BLC-1/2, BLC-1/2-2	8
BLC-3/4, BLC-3/4-2	8
Typical Installation Detail.....	9
Remote Installation Directions	10
Remote Control Panel Installation Detail.....	11
Remote Control Panel Installation Photo	12
Remote Beer Line Chiller Accessories.....	12
Replacement Parts.....	13-17
BLC-1/3, BLC-1/3-2, BLC-1/2, BLC-1/2-2	13-14
BLC-3/4, BLC-3/4-2	15-16
Electrical Components.....	16
BLC-1/3-E	17
Terms and Conditions	18
Warranty.....	19
Trouble Shooting	20
Installation Notes	20

BLC SPECIFICATIONS

1/3 HP Beer Line Chiller Model: BLC-1/3-E



BLC-1/3-E

STANDARD FEATURES:

- Glycol connections with flared fittings for easy service access
- Durable black vinyl-clad exterior with 16 gauge galvanized steel base
- Stainless steel, CFC-free, foamed-in-place insulated glycol bath
- High efficiency heat exchanger minimizes glycol bath size to one gallon
- Front located glycol filling port

1/3, 1/2, and 3/4 HP Beer Line Chillers with Remote Installable Control Panel

Models: BLC-1/3, BLC-1/3-2, BLC-1/2, BLC-1/2-2, BLC-3/4, BLC-3/4-2



BLC-1/3-2

STANDARD FEATURES:

- Control panel is removable and includes wall bracket for remote installation
- Glycol connections with flared fittings for easy service access
- Durable black vinyl-clad exterior with 16 gauge galvanized steel base
- Stainless steel, CFC-free, foamed-in-place insulated glycol bath
- High efficiency heat exchanger minimizes glycol bath size to one gallon
- Front located glycol filling port
- Digital temperature control with LCD display
- Over-sized condenser coil for maximum efficiency
- Clear glycol bath cover for easy visual inspection
- Available with two recirculating pumps (designated by “-2” suffix in model number)

Dimensional and Specification Information

Model No.		BLC-1/3-E	BLC-1/3	BLC-1/3-2	BLC-1/2	BLC-1/2-2	BLC-3/4	BLC-3/4-2
Dimensions†	Length	27"	27"	27"	27"	27"	27"	27"
	Width	21-1/4"	25-5/8"	25-5/8"	25-5/8"	25-5/8"	25-5/8"	25-5/8"
	Height	14-3/4"	16"	16"	16"	16"	16"	16"
† Note: A minimum six inch clearance should be allowed around the entire unit for proper air flow. Additional clearance should be considered above and in front of the unit for service access.								
Electrical	Voltage	120V	120V	120V	120V	120V	230V	230V
	Frequency	60 Hz	60 Hz	60 Hz	60 Hz	60 Hz	60 Hz	60 Hz
	Phase	1ø	1ø	1ø	1ø	1ø	1ø	1ø
	FLA	13	13	18.6	13.5	19.5	10.1	12.9
	Dedicated Circuit	20A	20A	30A	20A	30A	20A	20A
Electrical Connection	Cord & Plug	Cord & Plug	Hard Wire	Cord & Plug	Hard Wire	Cord & Plug	Cord & Plug	
Refrigerant		R134a	R134a	R134a	R134a	R134a	R134A	R134A
Refrigerant Charge		14 oz.	26 oz.	26 oz.	30 oz.	30 oz.	35 oz.	35 oz.
Compressor		1/3 HP	1/3 HP	1/3 HP	1/2 HP	1/2 HP	3/4 HP	3/4 HP
Capacities*		2,175 BTU/hr	2,175 BTU/hr	2,175 BTU/hr	3,300 BTU/hr	3,300 BTU/hr	6,375 BTU/hr	6,375 BTU/hr
* Note: Rated capacities assume maximum operating ambient temperature of 80°F.								
Max Distance to Taps		125 ft.	125 ft.	125 ft.	250 ft.	250 ft.	400 ft.	400 ft.
Circulating Pumps		60 gph	60 gph	60 gph	60 gph	60 gph	60 gph	60 gph
Glycol Bath Capacity		.94 gal	.94 gal	.94 gal	.94 gal	.94 gal	.94 gal	.94 gal.
Shipping Weight LBS (kg)		128 (58.1)	150 (68.0)	163 (73.9)	153 (69.4)	166 (75.3)	175 (79.5)	193 (87.7)

INSPECTION AND SET-UP

1. INSPECTION UPON ARRIVAL:

Immediately upon arrival, a visual inspection of the carton should be made to determine if there is evidence of damage in shipment. Following uncrating, make an inspection for any signs of external damage.

2. SET-UP OF REMOTE GLYCOL LINE CHILLER:

Once the survey of the location has been completed to determine the positioning of the remote glycol line chiller and the connecting draft beer dispensing stations (refer to the specification sheet to be certain that the trunk line will be within the recommended distance), make the necessary provisions to locate the unit and provide for the electrical services.

The ideal set-up is to mount the glycol line chiller on a proper machine stand that is easily accessible for routine maintenance and service.

In less-than-ideal circumstances, it may be necessary to locate the unit on top of the walk-in cooler or on the floor.

NOTE: Do not locate the glycol chiller in the walk-in cooler, as the cold ambient temperature will reduce the cooling performance of the unit.

NOTE: A minimum of six inches of clearance should be allowed around the entire unit for proper performance. Additional clearance should be considered for above the unit and in front of the unit for serviceability.

NOTE: When installed above walk-in cooler, ensure air flow is sufficient to maintain 80°F or lower ambient temperature to maintain rated cooling capacity.

If the unit is located on the floor:

- Ensure the cabinet is sealed to the floor with NSF listed silicon RTV sealant applied around the entire bottom edge of the cabinet.
- An optional 4" leg set is available as an accessory.

3. ELECTRICAL HOOK-UP:

Models BLC-1/3, BLC-1/3-E, BLC-1/2, BLC-3/4, & BLC-3/4-2 are supplied with a 20 Amp grounded cord and plug that connects at the rear of the unit. Models BLC-1/3-2 & BLC-1/2-2 ship as hard wire units and are supplied with a 30 Amp grounded cord only (no plug) that connects at the rear of the unit. A corresponding 20 Amp or 30 Amp grounded receptacle or junction box, depending on the line chiller model used, must be installed within reach of the unit.

4. GLYCOL LINE CONNECTION:

Typically, glycol recirculating lines are used to transport the glycol in the line chiller to and from the walk-in cooler to be connected to the glycol lines in the beer line set.

Recirculating Return

Connect your glycol recirculating line from the beer line set to the Line Chiller 3/8" barb fitting.

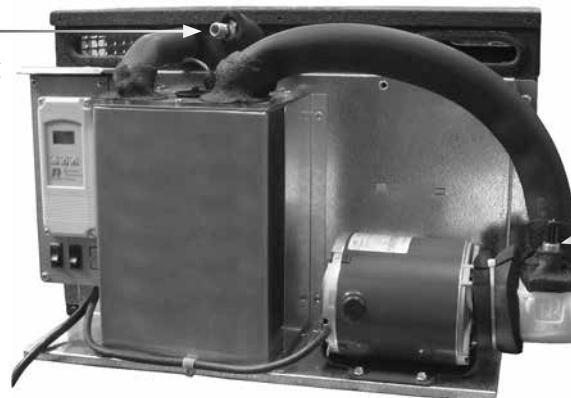

Recirculating Outlet

Connect your glycol recirculating line from the beer line set to the Line Chiller 3/8" barb fitting.

GLYCOL FILLING AND START-UP

5. GLYCOL FILLING:

The glycol bath capacity is 1 gallon (US). Glycol supplied by Glastender, Inc. may be diluted to a ratio of (1) part glycol to (2) parts water for freeze protection down to 0°F (-18°C) or a ratio of (1) part glycol and (3) parts water for freeze protection down to 10°F (-12°C). These mix ratios are recommended, since the refrigeration system is not capable of lowering the temperature of the glycol bath below 15°F (-9.4°C)

For glycol not supplied by Glastender, Inc. please consult the glycol manufacturer's recommended mixing ratio for the desired operating temperature.

NOTE: Do not place full strength glycol (undiluted) in the bath, as it will reduce the efficiency of the refrigeration system and may result in damage to the recirculation pump due to increased viscosity of cold glycol.

NOTE: Select and use only a propylene glycol product that meets FDA (Food and Drug Administration) regulations as a food grade product. Any substitution of food grade glycol with automotive anti-freeze or other products will expose people to hazardous chemicals.

Fill the bath with glycol mixture by removing the black plug in the top of the glycol back and placing a funnel in the fill hole. Pour in the glycol mixture until the level is 2-1/2" from the top.

6. UNIT START-UP:

- Connect unit to appropriate electrical circuit. For more information refer to Step 3, Electrical Hook Up.
- Model BLC-1/3-E has one power switch that operates the compressor unit and recirculating pump.
- Models BLC-1/3, BLC-1/3-2, BLC-1/2, BLC-1/2-2, BLC-3/4, and BLC-3/4-2 have a condensing unit power switch. There are separate power switches to operate the recirculating pumps. The condensing unit power switch will not operate the compressor unless a pump switch is in the on position.
- Check all glycol circuit line connections for leaks.
- As you are priming the BLC-1/3, BLC-1/2, or BLC-3/4 lines, continue to add the glycol mixture to keep the bath level 2-1/2" from the top.

7. SYSTEM START-UP:

It is a good practice to operate the glycol recirculation system for sixty (60) minutes before running beer through to the remote dispensing station(s). This enables the glycol circuit to be checked for leaks. Also, recirculating cold glycol through the lines enables the temperature inside the trunk line to stabilize before beer is introduced.

Once the refrigeration unit and the glycol recirculating pump have operated for sixty (60) minutes or more, the beer product can be connected and drawn through the trunk line.

- Check the system for leaks.
- Thoroughly insulate all line joints in the trunk line and dispensing station(s).

It is recommended that the glycol lines be insulated inside the walk-in cooler to prevent excessive ice build up. Insulate the glycol lines all the way up to the sealed chaseway as it exits the walk-in cooler.

TEMPERATURE CONTROL

8. ELECTRONIC TEMPERATURE CONTROL PROGRAMMING

BLC-1/3, BLC-1/3-2, BLC-1/2, BLC-1/2-2, BLC-3/4, BLC-3/4-2 (NOTE: THIS CONTROL USED ON UNITS PRIOR TO 11/21/2013 SN134147623X):

The unit is shipped from the factory set at 26°F, differential set at 5, in C1, cooling mode. If reprogramming or adjusting is necessary follow these steps:

- Step 1 Press the SET key to start programming.
Use the up or down arrow to toggle between and select F for degrees Fahrenheit or C for degrees Celsius.
- Step 2 Press the SET key again to access the setpoint.
To achieve the desired temperature, press the UP key to increase or the DOWN key to decrease the setpoint.
- Step 3 Press the SET key again to access the differential.
To achieve the desired differential, press the UP key to increase or the DOWN key to decrease the setting.
- Step 4 Press the SET key again to access the mode.
Use the up or down arrow to toggle between and select C1, cooling or H1, heating mode.
- Step 5 Press the SET key again to complete programming.

COLD CONTROL ADJUSTMENT, BLC-1/3-E

The unit is shipped from the factory set at 26°F, differential set at 5. To decrease the temperature turn the adjusting knob clockwise. To increase the temperature turn the adjusting knob counter clockwise.

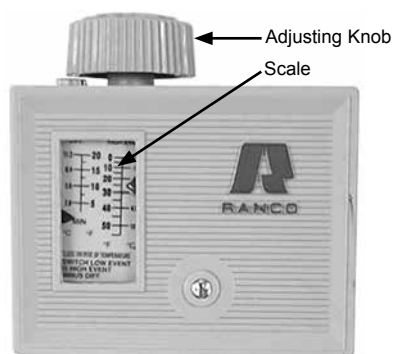

DIGITAL CONTROLLER OPERATION

The operating temperature range is preset at the factory according to the table below and can be adjusted up or down within the limits shown.

To see the set point - push and immediately release the SET button. The set point will be displayed.

To return to normal visualization - Push and immediately release the SET button or wait five seconds.

To change the set point - push and hold the SET button for more than two seconds. When the ° F display begins flashing, push the up arrow or down arrow buttons to adjust the set point to the desired value.

To save the new set point and return to the temperature display mode - push and release the SET button or wait ten seconds.

	Factory Settings		Range of Adjustment	
	Set Point	Operating Range†	Minimum Set Point	Maximum Set Point
Standard Cooler Setting				
BLC	28° F	28° F to 33° F	27° F	32° F

† Adjusting the factory set point will also adjust the operating range by the same amount

The thermostat controller does not have an “OFF” function. To turn chiller off, the unit must be unplugged or power to the electrical branch circuit has to be turned off via a circuit breaker or switch.

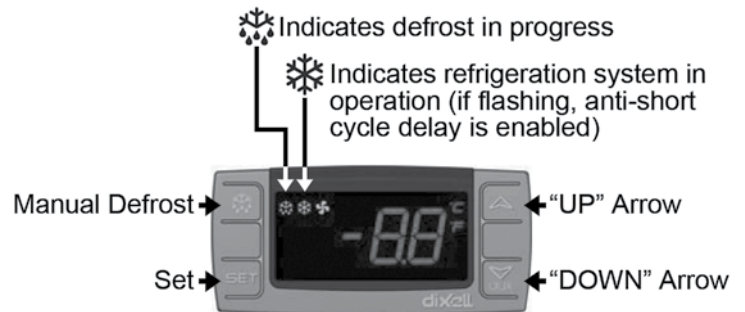

The thermostat control probe wire connector may become disconnected when the electrical compartment cover and/or grill are removed. This will result in thermostat P1 code. While the P1 code is flashing the compressor will cycle 5 minutes on and 5 minutes off and may cause icing of the evaporator coil. Service calls to reconnect the probe wiring are not covered by factory warranty.

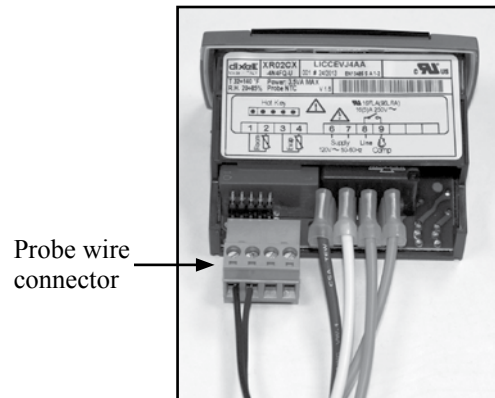

BLC-1/2, BLC-1/2-2 WIRING DIAGRAM

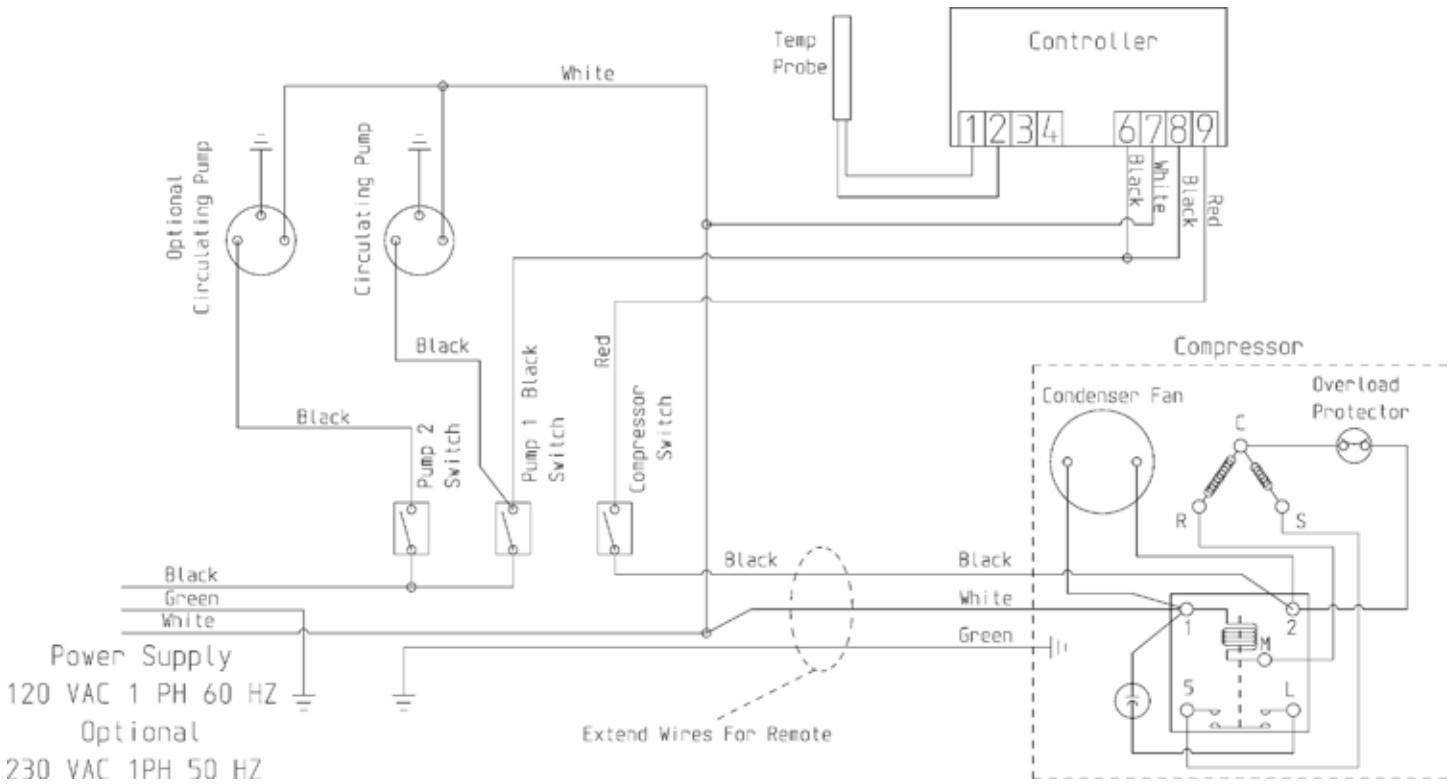

BLC-3/4, BLC-3/4-2 WIRING DIAGRAM

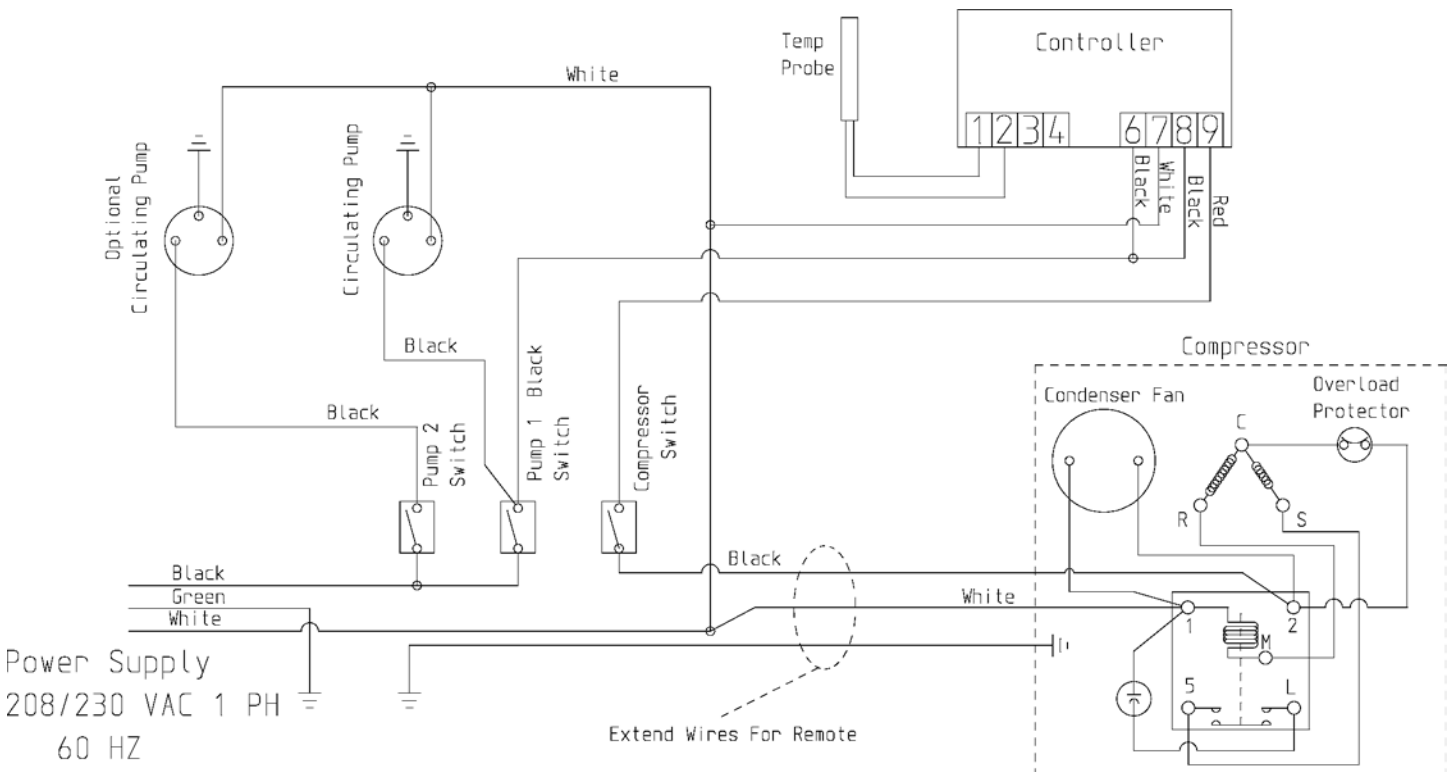

TYPICAL INSTALLATION DETAIL

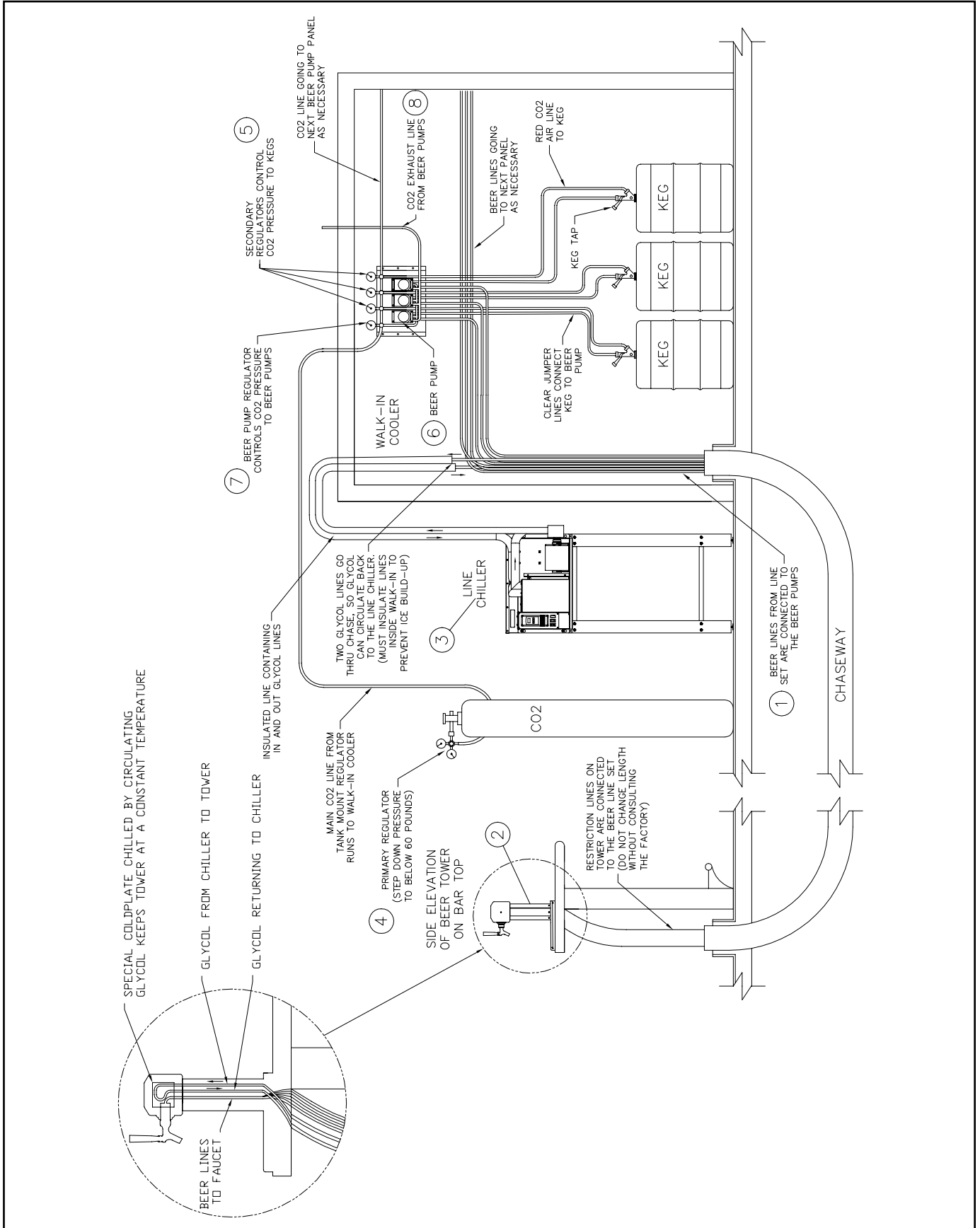

REMOTE CONTROL PANEL INSTALLATION DETAIL

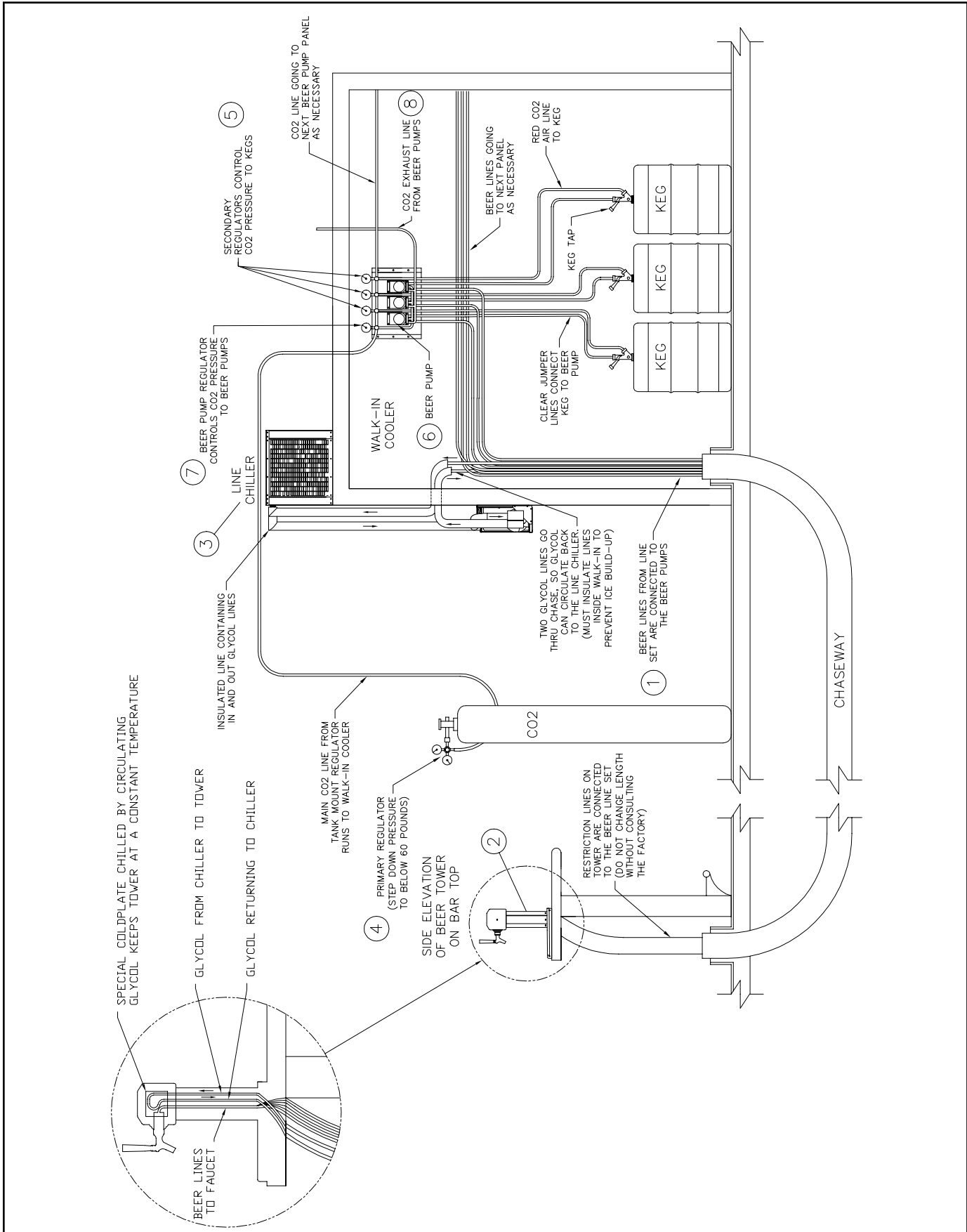

INSTRUCTIONS FOR CONTROL PANEL REMOTE INSTALLATION

The Glastender exclusive, patent pending beer line chiller design houses the heat exchanger inside the condensing unit compartment. For models BLC-1/3, BLC-1/3-2, BLC1/2, BLC-1/2-2, BLC-3/4, and BLC-3/4-2, this unique feature allows the control panel with glycol bath and recirculating pump(s) to be easily installed separately from the condensing unit in a more conveniently accessible location.

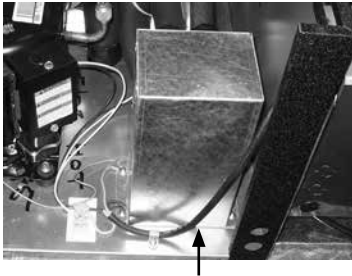

Remove cabinet top and vented side to get at the power cord. Disconnect 33" power cord.



Remove control cover to get at the power cord. Disconnect 33" power cord.

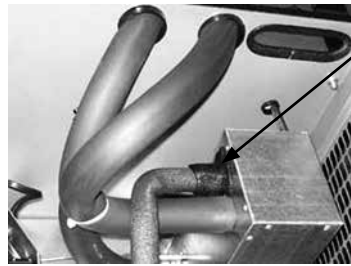

Disconnect glycol line from heat exchanger.



Disconnect glycol line from bath.

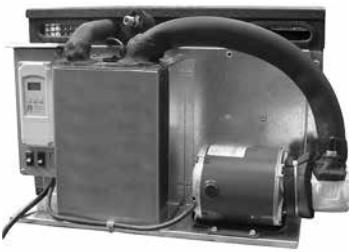

Remove control panel installed with four screws from cabinet. NOTE: Wall rack will be found behind control panel.

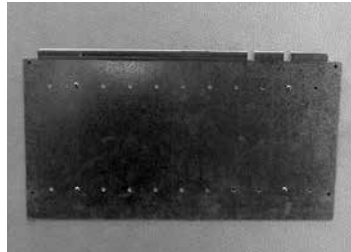

Mount wall rack for control panel at new site.



Clip control panel onto wall mounting plate. Secure against wall through four corner holes.



Install power line between condensing unit and control panel.



Install and insulate glycol line from heat exchanger to bath



Connect glycol recirculating line from pump outlet 3/8" barb fitting to the beer line set.

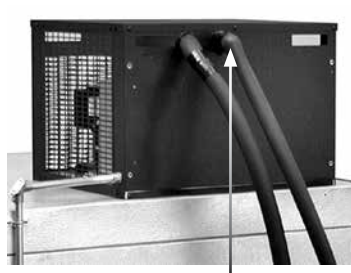

Connect glycol recirculating line from beer line set to the return 3/8" barb fitting.

REMOTE CONTROL PANEL INSTALLATION PHOTO

The Glastender exclusive, patent pending beer line chiller design houses the heat exchanger inside the condensing unit compartment. This unique feature allows the control panel with glycol bath and recirculating pump(s) to be easily installed separately from the condensing unit in a more conveniently accessible location. Simply remove the control panel from the condensing unit cabinet and mount it in the desired location. Only glycol and electrical lines need to be run between the control panel and the condensing unit cabinet.

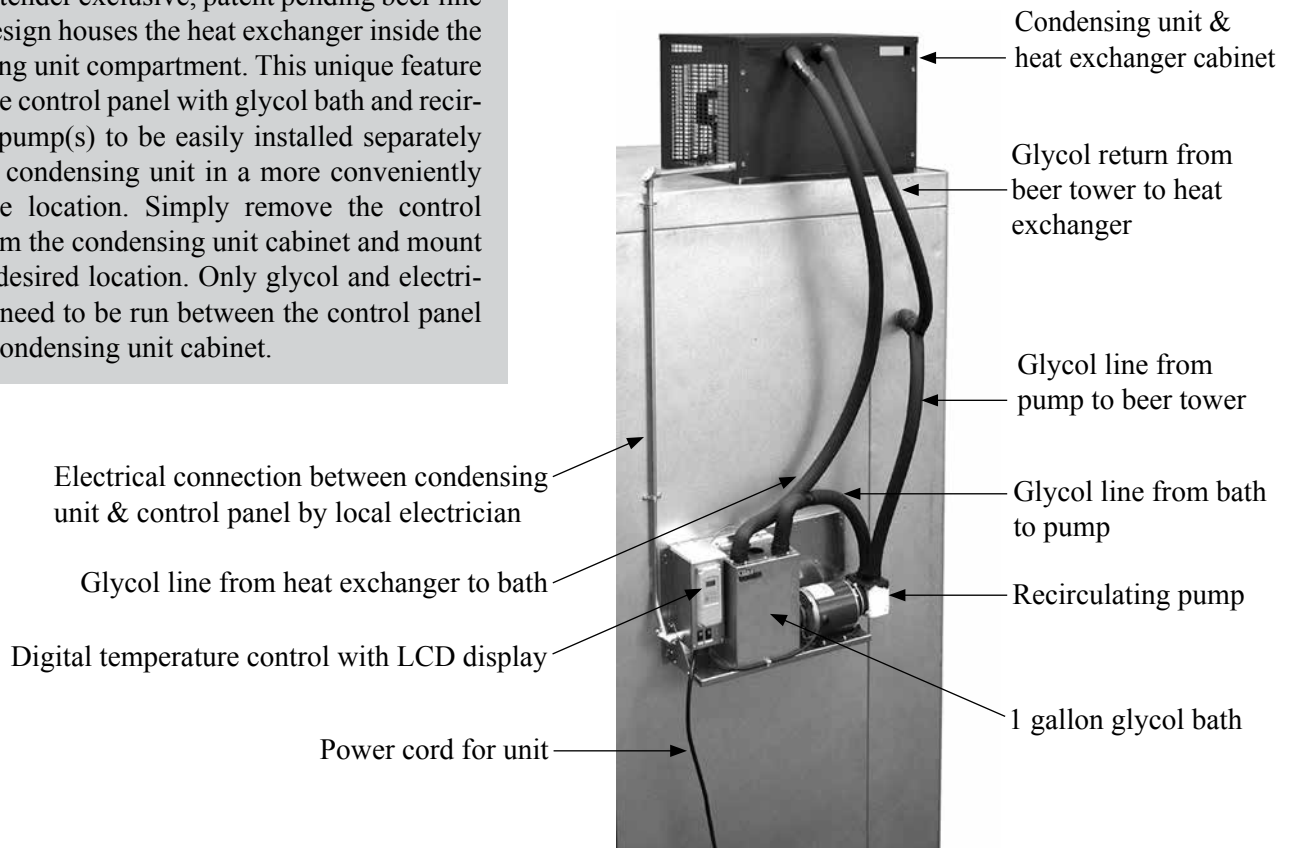

Photo shows BLC-1/3 in an installation setting with the control panel installed remotely from the condensing unit cabinet.

REMOTE BEER LINE CHILLER ACCESSORIES

All Glastender line chillers may be placed on 6" legs that are adjustable up to 7". The leg set includes 16 gauge galvanized steel that are mounted to the base plate of the unit.

A line chiller stand is 26-1/2" wide by 39" high by 24" deep and comes with adjustable feet for leveling. The bottom shelf is at the 8" high level. The top shelf has holes that correspond to the line chiller mounting holes, so the line chiller can be bolted to the shelf. One size stand is used for all line chiller models.



STANDS

A line chiller wall rack is a shelf that is mounted to a structural wall. The shelf has holes that correspond to the line chiller mounting holes, so the line chiller can be bolted to the shelf. One size rack is used for all line chiller models.



WALL RACKS

BLC-1/3, BLC-1/3-2, BLC-1/2, BLC-1/2-2 REPLACEMENT PARTS

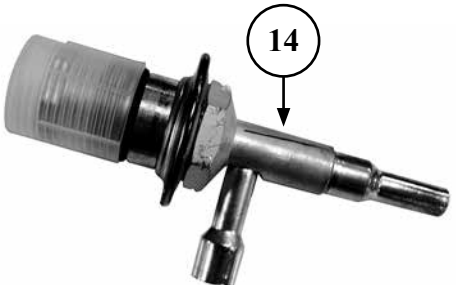
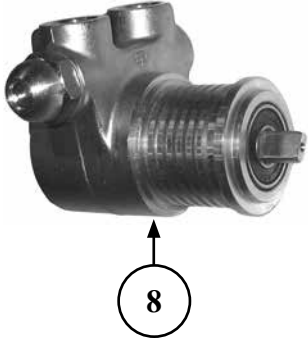
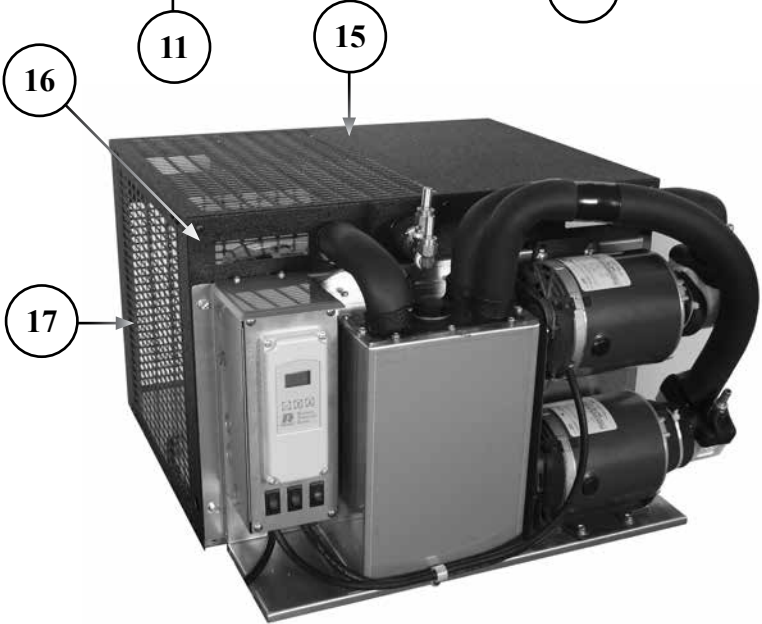
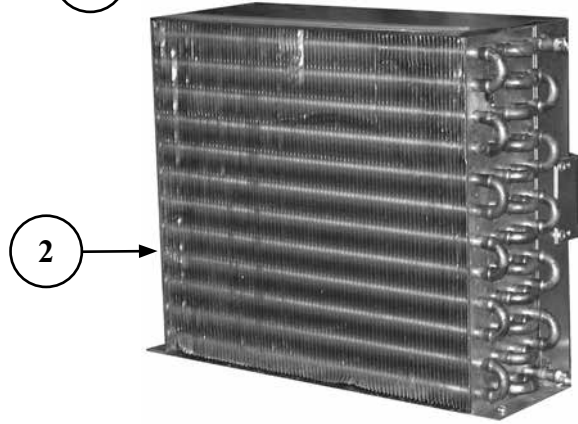
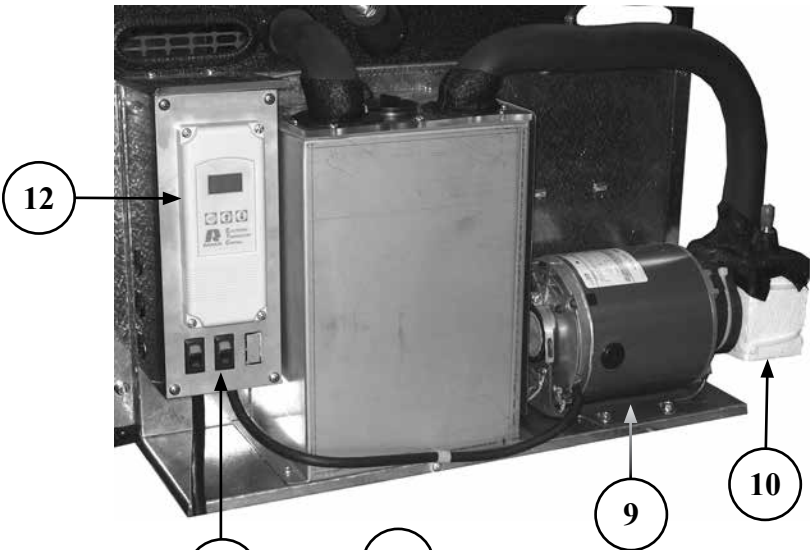
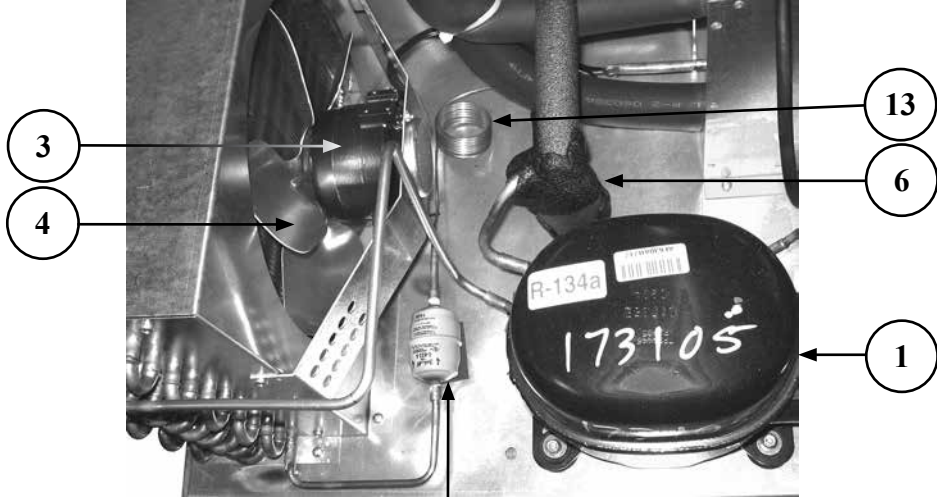
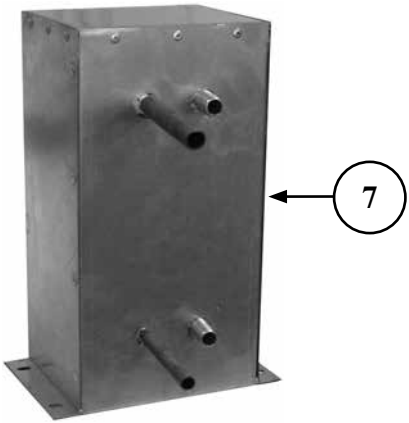

BLC-1/3, BLC-1/3-2, BLC-1/2, BLC-1/2-2 REPLACEMENT PARTS

<u>PART NO.</u>	<u>DESCRIPTION</u>	<u>PRICE</u>
1. 06001439	Compressor, 1/3 HP, R134a, 120V	\$435.00
09000481	Start capacitor for 1/3 HP R134a compressor (prior to 11/06/13 - SN 134147373)	10.00
06009616	Start capacitor for 1/3 HP R134a compressor (starting with and after 11/06/13 - SN 134147373)	35.00
09000479	Relay for 1/3 HP R134a compressor (prior to 11/06/13 - SN 134147373)	20.00
06009614	Relay for 1/3 HP R134a compressor (starting with and after 11/06/13 - SN 134147373)	31.00
09000480	Overload protector for 1/3 HP R134a compressor (prior to 11/06/13 - SN 134147373)	11.50
06009615	Overload protector for 1/3 HP R134a compressor (starting with and after 11/06/13 - SN 134147373)	20.00
09000334	Compressor, 1/2 HP, R134a, 120V	720.00
09000650	Start capacitor for 1/2 HP R134a compressor	19.00
09000652	Relay for 1/2 HP R134a compressor	30.50
09000651	Overload protector for 1/2 HP R134a compressor	22.00
2. 09000526	Condenser coil, 12.00" x 13.50"	270.00
3. 08000085	Motor, condenser fan	135.00
4. 09000528	Fan blade, 10" 30 degree S condenser	17.00
5. 06001385	Filter dryer, 1/4" x 1/4"	20.00
6. 07000953	Accumulator, suction line	30.00
7. 09000523	Evaporator, flat plate housing assembly	515.00
8. 09000331	Pump, glycol, 60 GPH, brass	225.00
9. 09000340	Pump motor, 1/3 HP, 120V	350.00
10. 06001595	Insulation, Fluid-O-Tech pump, 2 piece set	9.00
11. 06001412	Rocker switch	5.00
12. 09000616	Electronic temperature control (prior to 11/21/13 - SN 134147623)	190.00
09000728	Dixell control (starting with and after 11/21/13 - SN 134147623)	165.00
06003951	Probe, Dixell control	30.00
13. 09000527	Capillary tubing, precut .049 at 65", BLC-1/3, BLC-1/3-2	20.00
09000625	Capillary tubing, pre-cut .049 at 42", BLC-1/3, BLC-1/2-2	20.00
14. 08000724	Expansion valve (starting with and after 11/06/13 - SN 134147373)	100.00
15. 09000496	Top, compressor, black vinyl, flat plate chiller	35.00
16. 09000498	Front, compressor, moly, flat plate chiller	35.00
09000500	Back, compressor, black vinyl, flat plate chiller	35.00
17. 09000502	Side, compressor, black vinyl, flat plate chiller	27.00
09000522	Side, coil, black vinyl, flat plate chiller	15.00

BLC-3/4 & BLC-3/4-2 REPLACEMENT PARTS

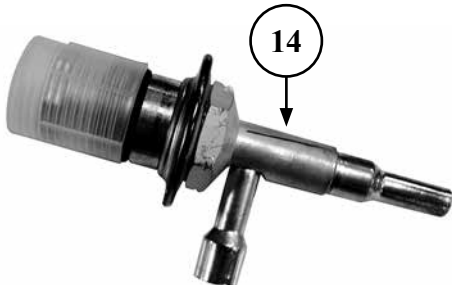
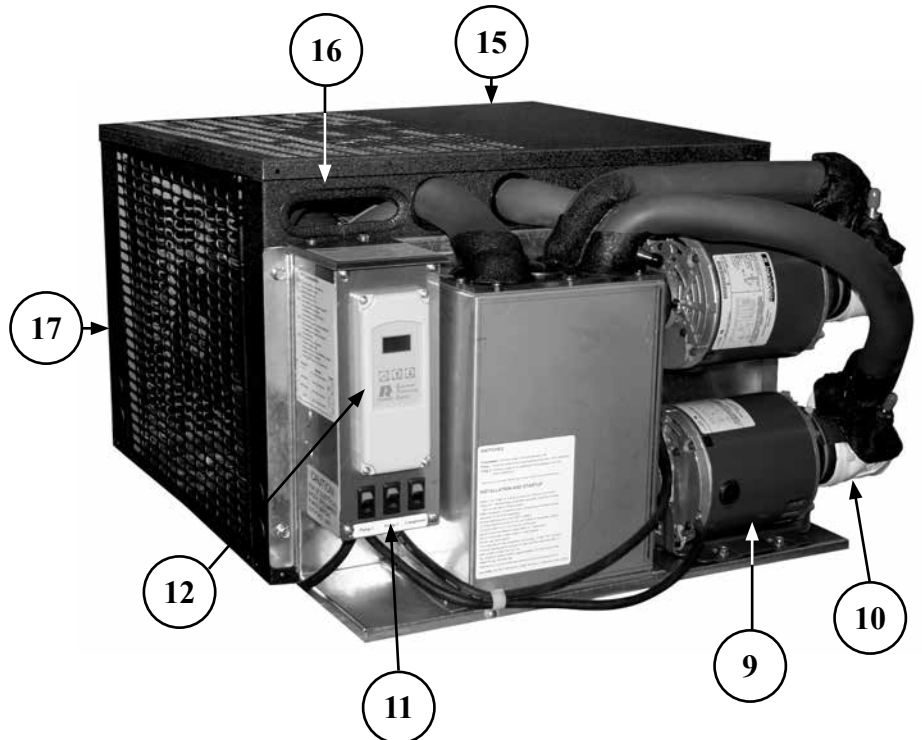
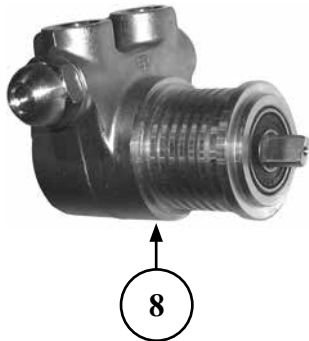
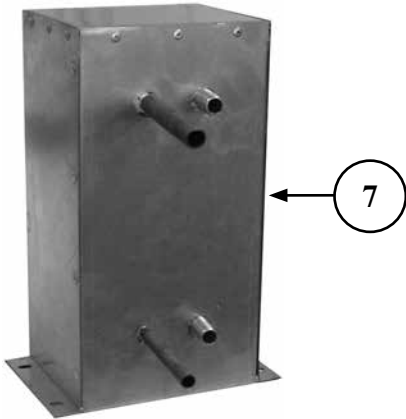
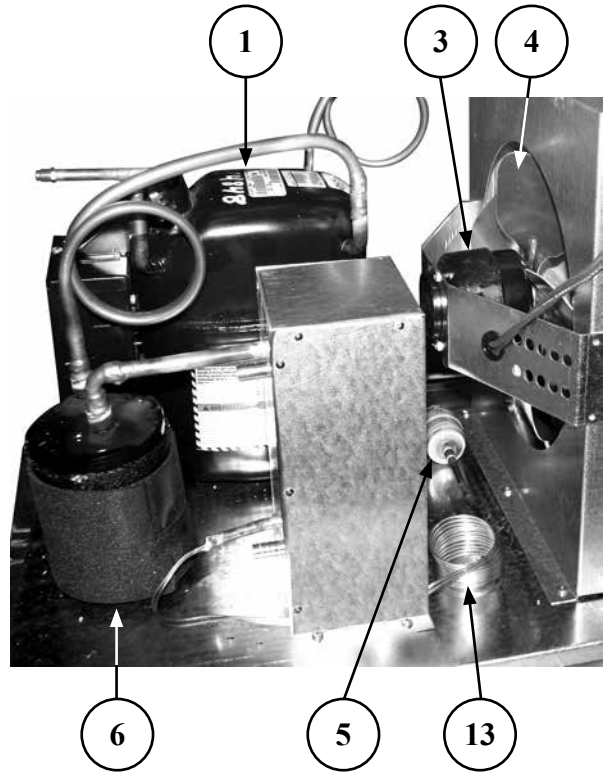
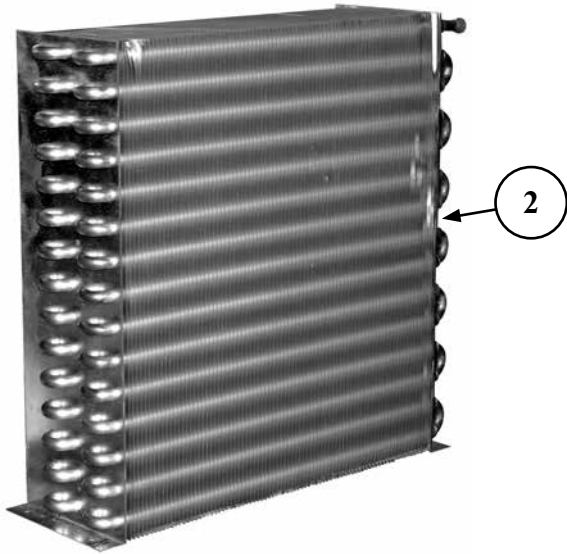

BLC-3/4 & BLC-3/4-2 REPLACEMENT PARTS

<u>PART NO.</u>	<u>DESCRIPTION</u>	<u>PRICE</u>
1. 09000335	Compressor, 3/4 HP, R-134a, 120V 60hz	\$930.00
09000668	Start capacitor for 3/4 HP 220V compressor	31.00
09000670	Relay for 3/4 HP 220V compressor	35.00
09000671	Overload protector for 3/4 HP 220V compressor	13.00
2. 09000640	Condenser coil, 15 x 13 x 4	370.00
3. 08000085	Motor, 16 watt Condenser Fan	135.00
4. 09000528	Fan Blade, 10"	17.00
5. 09000285	Filter Dryer, 1/4" x 1/4"	20.00
6. 09000286	Accumulator	126.00
7. 09000523	Evaporator, flat plate housing assembly	500.00
8. 09000331	Pump, glycol, 60 GPH, brass	225.00
9. 09000342	Pump motor 1/3hp, 220V	396.80
10. 06001595	Insulation, Fluid-O-Tech Pump, 2 piece set	9.00
11. 06001412	Rocker Switch	5.00
12. 09000616	Electronic Temperature Control (prior to 11/21/13 - SN 134147623)	190.00
09000674	Thermostat, LED display, range 28-34°F, BLC, 220V	200.00
06003951	Probe, Dixell Control	30.00
13. 09000649	Capillary tubing, set of 2, 60" x .049" ID	20.00
14. 09000724	Expansion valve (prior to 11/6/13 - SN 134147373)	100.00
15. 09000496	Top, compressor, black vinyl, flat plate chiller	35.00
16. 09000498	Front, compressor, moly, flat plate chiller	35.00
17. 09000502	Side, compressor, black vinyl, flat plate chiller	27.00
09000500	Back, compressor, black vinyl, flat plate chiller	35.00

ELECTRICAL COMPONENTS

<u>PART NO.</u>	<u>DESCRIPTION</u>	<u>PRICE</u>
06006121	Replacement powercord assembly, includes (06001572 06009527)	\$40.00

BLC-1/3-E REPLACEMENT PARTS

<u>PART NO.</u>	<u>DESCRIPTION</u>	<u>PRICE</u>
1. 06001439	Compressor, 1/3 HP, R-134a, 120V	\$435.00
09000481	Start capacitor for 1/3 HP R-134a compressor, prior to 11/06/13 SN134147373	10.00
06009616	Start capacitor for 1/3 HP R-134a compressor, after 11/06/13 SN134147373	20.00
09000479	Relay for 1/3 HP R-134a compressor, prior to 11/06/13 SN134147373	20.00
06009614	Relay for 1/3 HP R-134a compressor, after 11/06/13 SN134147373	31.00
09000480	Overload protector for 1/3 HP R-134a compressor, prior to 11/06/13 SN134147373	11.50
06009615	Overload protector for 1/3 HP R-134a compressor, after 11/06/13 SN134147373	20.00
2. 09000292	Condenser coil	170.00
3. 09000336	9W condenser fan motor	85.00
4. 09000300	Fan blade 40 series	15.00
5. 06001385	Filter dryer, 1/4" x 1/4"	20.00
6. 07000953	Accumulator, suction line	30.00
7. 09000523	Evaporator, flat plate housing assembly	515.00
8. 09000331	Pump, glycol, 60 GPH, brass	225.00
9. 09000340	Pump motor, 1/3HP, 120v	350.00
10. 06001595	Insulation, Fluid-O-Tech pump, 2 piece set	9.00
11. 06001412	Rocker switch	5.00
12. 09000303	Thermostat, adjustable	160.00
13. 09000527	Capillary tubing pre-cut .049 at 65"	20.00
14. 09000499	Top, compressor, moly, flat plate chiller, BLC-1/3-E	35.00
15. 09000531	Front, compressor, moly, flat plate chiller	35.00
09000503	Back, compressor, moly, flat plate chiller	35.00
16. 09000505	Side, compressor, black vinyl, flat plate chiller	20.00
09000510	Side, coil, black vinyl, flat plate chiller	12.00

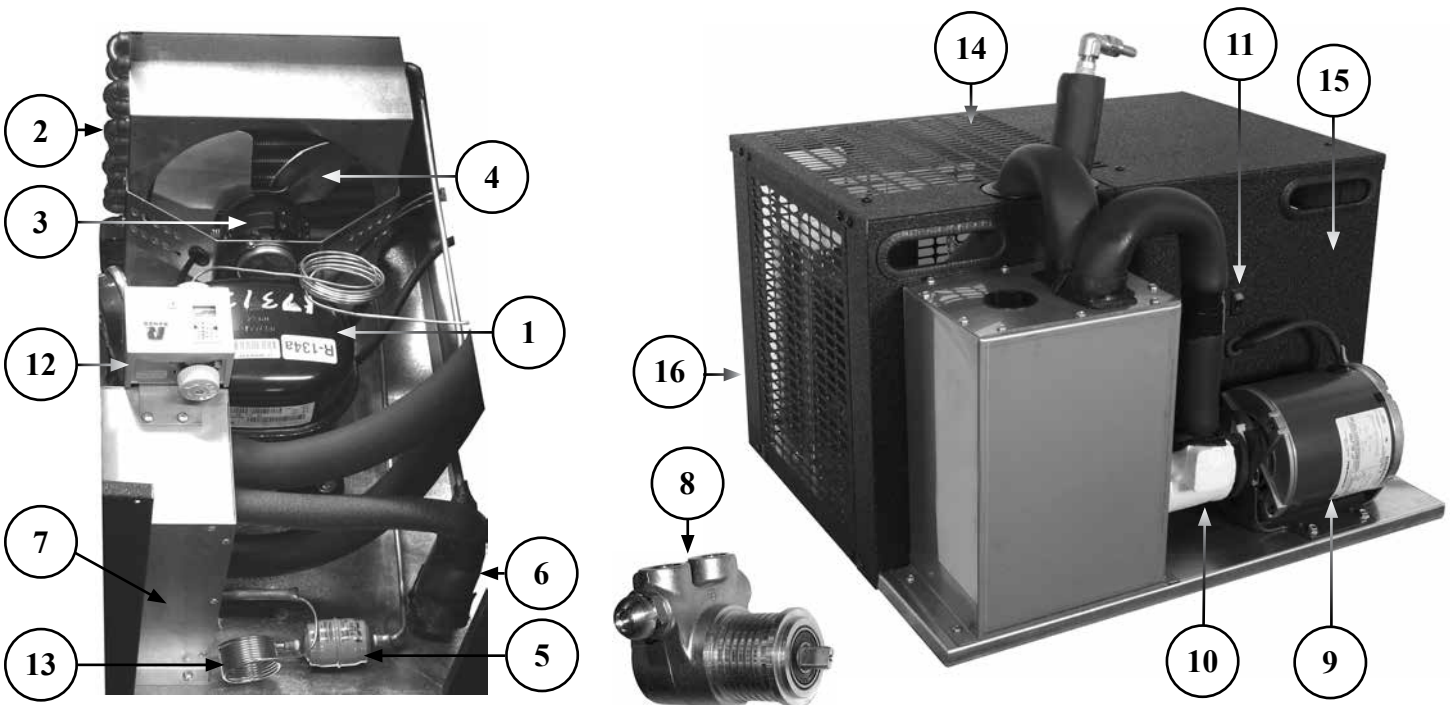

TERMS AND CONDITIONS

PRICES:

All prices are LIST. Applicable taxes will be added.

QUOTATIONS:

Unless otherwise stated, quotations are effective for 30 days only.

ACCEPTANCE:

All orders are subject to acceptance by Glastender, Inc.'s headquarters in Saginaw, Michigan. Possession of the Product Directory and Price List is not an offer to sell.

SHIPMENTS:

F.O.B. factory in Saginaw, Michigan. Freight terms are Third Party or Collect if shipped directly to you. Prepay and Add to Invoice freight terms are available upon request. The approximate shipping weights of all products are listed with the prices. Partial shipments will be made unless otherwise specified by the customer. Surface freight classifications are:

- GT-24/GT-30/GW24 Glasswashers - Class 175
- GT-18 Glasswashers - Class 250
- All Underbar Equipment - Class 175
- Bar Die Orders - Class 250
- Portable Bars - Class 175
- Remote refrigerators (i.e., no compressor) or dry storage back bar equipment - Class 175
- Self-contained refrigeration equipment - Class 150
- Ice Display Units (IDU and GDU) - Class 85
- Lighted Liquor Displays - Class 85
- Beer line chillers and beer towers (beverage dispensing equipment) - Class 92.5
- Bottle Disintegration System - Class 150
- Ice Cream Freezers - Class 77.5

All small items are evaluated to see the most cost effective means for shipment. Many small items ship via UPS or FedEx; however, when dimensional weight is excessive, LTL carriers are the most cost effective choice. Spare parts orders received before 1:00 PM EST can usually be shipped the same day.

The order department is happy to assist with routing or shipping questions.

PAYMENT TERMS:

Cash should be included with all orders unless credit terms have been arranged. To establish credit, banking and trade references are required. A convenient credit application is available upon request. Payment via credit card is not our normal means of receiving payment. Visa and MasterCard will be accepted, but must be charged at the time of shipment. In addition, a payment via credit card for orders totaling more than \$500 will incur a 3% convenience fee on the total transaction amount.

DELIVERY:

The majority of equipment is manufactured to order and typically ships within three to six weeks after complete order information is received by the factory. In-stock equipment typically ships within two to three days of the factory receiving complete order information.

RETURNS:

Items specified as "Manufactured to Order" are NOT returnable.

A Return Authorization number must be issued by the factory in advance for any items that are returnable. The number MUST be noted on the outside of the returned package. Returns must be received within 90 days of the issue date. Shipping charges must be prepaid. A minimum 20% restocking charge will be applied to all authorized returns if received in new, unused condition in the original packaging.

The above conditions apply to spare part returns, except spare part returns must be received within 30 days of original shipment for electronic or electrical parts or within 90 days for all other parts.

LOSS OR DAMAGE:

For customer routed shipments, Glastender, Inc. is not responsible for any loss, damage, or delay of merchandise during shipment. Such transit claims must be filed with the carrier. Merchandise must be examined on arrival. If shortages occur, Glastender, Inc. must be notified in writing within five (5) days of delivery to honor any shortage claim. Glastender will assume responsibility for freight claims on Prepay and Add shipments but the customer must inspect freight and note any damage upon receipt. Failure to do so may result in losses at the customer's expense.

CUSTOM ORDERS:

Custom orders must be paid in advance and are not subject to cancellation.

LAMINATES:

Some products include common, readily available plastic laminates of the customer's selection. There may be an additional charge if uncommon varieties are ordered.

12/14/17

WARRANTY STATEMENT

APPLICABLE TO ALL PRODUCTS SOLD WITHIN THE UNITED STATES AND CANADA

Glastender, Inc. warrants all products to be free of defects in material and workmanship. One-year labor and parts warranty applies to all glasswashers, self-contained refrigeration models, and BDS model bottle disintegration units. In established areas, a start up is included with GT-24 and GT-30 model glasswashers. Warranty is effective for one year from the date of installation or up to 18 months from date of factory shipment, whichever occurs sooner. Glastender, Inc. will replace any part or assembly found defective under normal use and service.

For warranty labor claims beyond 15 months from the date of factory shipment, proof of date of installation or occupancy must be provided. Authorization for labor must be obtained from Glastender within the warranty period and prior to the service being performed.

Labor warranty applies to the United States and Canada only.

Remote refrigeration models and beer line chillers include a one-year parts warranty only. There is no labor warranty on these products.

Field replacement parts not covered under the original warranty include a 90-day part warranty from the date of installation.

FOUR YEAR ADDITIONAL COMPRESSOR WARRANTY: Glastender will warrant to the original user the compressor for all self-contained refrigeration models for an additional four years following the regular one-year warranty period. This plan applies to the compressor only.

A completed warranty claim form **MUST** accompany all returned defective parts or assemblies. Upon request, a defective part or assembly must be returned to Glastender, Inc., Saginaw, Michigan, with all transportation and delivery charges prepaid. Warranty repairs or replacements will be shipped FOB factory in Saginaw, Michigan. Reimbursement for applicable freight charges covers ground service only.

Glastender provides in-warranty repairs during a service company's regular working days and hours. There is no provision for payment of a premium rate during "overtime" hours. When warranty service is requested during other than normal working hours, the end user will be charged the premium portion of the overtime rate.

The warranty covers substantiated travel expenses for up to 2 hours / 100 miles round trip up to a maximum of \$150. Any additional costs due to installations that require extra work, time, or travel to gain access for service are the sole responsibility of the equipment purchaser. Any exceptions to these travel and access limitations must be pre-approved by a factory representative.

The warranty does not cover door gaskets, chemical tubing, pump squeeze tubing, and/or any equipment subjected to accidents, freight damage, alterations from the original design, improper power and/or plumbing hookups, improper chemical use, general misuse, or lack of routine required maintenance as determined by Glastender, Inc. Installation, normal control adjustments, general maintenance, correcting an installation error, or service calls that reveal the unit is functioning normally will not be reimbursed under warranty.

Condenser coils on self-contained refrigeration products must be cleaned regularly. Failure to provide adequate air flow to a refrigeration unit will void the warranty.

Glastender shall not be liable for loss of use, revenue, or profit, or for any other indirect, incidental, special, or consequential damage including, but not limited to, product spoilage or loss.

This warranty is conditioned upon Glastender receiving notice of any defect subject to this warranty within sixty (60) days of its discovery by the end user or dealer. All products are warranted only for the initial place of installation. Removal of a product automatically terminates this warranty.

SECOND YEAR EXTENDED PARTS & LABOR WARRANTY:

Glastender's one-year parts and labor warranty on self-contained refrigeration units, excluding beer line chillers, can be extended to two years with the purchase of a two year parts and labor warranty. Specify part number EWR2 (\$150 net price) when ordering.

EXPORT WARRANTY - One year parts only.

EXCLUSION OF WARRANTIES

EXCEPT AS PROVIDED ABOVE, GLASTENDER MAKES NO WARRANTIES, EXPRESS OR IMPLIED, INCLUDING, BUT NOT LIMITED TO, ANY IMPLIED WARRANTY OF MERCHANTABILITY, FITNESS FOR A PARTICULAR PURPOSE OR NON-INFRINGEMENT.

LIMITATION OF REMEDIES AND DAMAGES

If Buyer makes a valid and timely claim as outlined above, Glastender's liability and Buyer's remedies under this agreement will be limited solely to labor charges authorized and/or replacement or credit, at Glastender's option, with respect to Products returned at Buyer's expense within thirty (30) days after warranty repair. GLASTENDER'S LIABILITY WILL IN NO EVENT BE GREATER IN AMOUNT THAN THE PURCHASE PRICE OF THE RETURNED PRODUCTS. GLASTENDER WILL NOT BE LIABLE UNDER ANY CIRCUMSTANCE FOR CONSEQUENTIAL OR INCIDENTAL DAMAGES, INCLUDING, BUT NOT LIMITED TO, LABOR COSTS EXCEPT AS COVERED UNDER OUR WARRANTY, LOST PROFITS OR THE LOSS OF PERISHABLE PRODUCTS RESULTING FROM THE USE OF OR INABILITY TO USE OUR PRODUCTS OR FROM OUR PRODUCTS' INCORPORATION INTO OR BECOMING A COMPONENT OF ANY OTHER PRODUCT. NEITHER PARTY WILL HAVE ANY NEGLIGENCE OR OTHER TORT LIABILITY TO THE OTHER, OR TO ANY THIRD PARTY, ARISING FROM ANY BREACH OF THIS AGREEMENT.

GOVERNING LAW - JURISDICTION

The terms and conditions of an order are to be governed and construed according to the laws of the State of Michigan, without regard to conflict of laws principles. Buyer hereby consents to the jurisdiction and venue of the courts located in Saginaw County, Michigan.

No representative, distributor, dealer, or any other person is authorized to modify this warranty. This warranty replaces all other written or verbal warranties.

NOTE: Glastender, Inc.'s policy of constant quality improvement means that prices, specifications, and policies are subject to change without notice. Questions regarding this warranty should be directed to Glastender's Warranty Administrator.

04-19-17

IMPORTANT!!

Attention Service Companies

Please review the important warranty information on this page. If you believe a service call should be covered by the factory, please call the factory for authorization between 8AM and 5PM EST, Monday through Friday.

