



## INSTALLATION AND OPERATING INSTRUCTIONS

# Gas Hot Plate

MODELS:

GHP-2H, GHP-4H, GHP-6H, GHPW-2H,  
GHPS-2H, GHPS-4H, GHPS-6H

### PRODUCT MANUAL

Safety Instructions, Installation Instructions, Operation Instructions  
Maintenance Instructions, Replacement Parts List, Warranty/Service Information

#### IMPORTANT FOR FUTURE REFERENCE

Please complete this information and retain this manual for the life of the equipment. For  
Warranty Service and/or Parts, this information is required.

\_\_\_\_\_

Model Number

\_\_\_\_\_

Serial Number

\_\_\_\_\_

Date Purchased



**FOR YOUR SAFETY:** Do not store or use gasoline or other flammable vapors or liquids  
in the vicinity of this or any other appliance.



**WARNING:** Improper installation, adjustment, alteration, service or maintenance can  
cause property damage, injury or death. Read the installation, operating and  
maintenance instructions thoroughly before installing, or servicing this equipment.



**WARNING:** Instructions must be posted in a prominent location. All safety precautions  
must be taken in the event the user smells gas. Safety information can be obtained from  
your local gas supplier.



ANSI/NSF4

P/N 8838900 8-06

**APW WYOTT Foodservice Equipment Company**

P.O. Box 1829  
Cheyenne, WY 82003

+1 (307) 634-5801 Phone  
+1 (307) 637-8071 Fax

+1 (800) 752-0863 Toll Free  
www.apwwyott.com

Installation and start-up should be performed by a qualified installer who thoroughly read, understands and follows these instructions.



If you have questions concerning the installation, operation, maintenance or service of this product, write Technical Service Department APW Wyott Foodservice Equipment Company, P.O. Box 1829, Cheyenne, WY 82003.



## 1. SAFETY PRECAUTIONS



Before installing and operating this equipment be sure everyone involved in its operation is fully trained and is aware of all precautions. Accidents and problems can result by a failure to follow fundamental rules and precautions.



Shut off gas flow through the appliance before cleaning or servicing unit.

The following words and symbols, found in this manual, alert you to hazards to the operator, service personnel or the equipment. The words are defined as follows.

 **DANGER:** This symbol warns of imminent hazard which will result in serious injury or death. 



 **WARNING:** This symbol refers to a potential hazard or unsafe practice, which could result in serious injury or death. 



 **CAUTION:** This symbol refers to a potential hazard or unsafe practice, which may result in minor or moderate injury or product or property damage. 



 **NOTICE:** This symbol refers to information that needs special attention or must be fully understood even though not dangerous. 

## GENERAL INFORMATION

### THIS MANUAL SHOULD BE RETAINED FOR FUTURE REFERENCE

 **CAUTION:** These models are designed, built, and sold for commercial use. If these models are positioned so the general public can use the equipment, make sure that cautions, warnings, and operating instructions are clearly posted near each unit so that anyone using the equipment will use it correctly and not injure themselves or harm the equipment. 

 **WARNING:** A factory authorized agent should handle all maintenance and repair. Before doing any maintenance or repair, contact APW Wyott. 

 **WARNING:** Improper installation, adjustment, alteration, service or maintenance can cause property damage, injury or death. Read installation, operating and maintenance instructions thoroughly before installing or servicing this equipment. 



**WARNING:** For your safety do not store or use gasoline or other flammable vapors or liquids in the vicinity of this or any other appliance. Keep the area free and clear of combustibles. (See ANZI Z83.14B, 1991)



**NOTICE:** Local codes regarding installation vary greatly from one area to another. The National Fire Protection Association, Inc., states in its NFPA96 latest edition that local codes are “Authority Having Jurisdiction” when it comes to requirement for installation of equipment. Therefore, installation should comply with all local codes.



**NOTICE:** This product is intended for commercial use only. Not for household use.



**NOTICE:** Instructions to be followed if anyone smells gas should be posted in a prominent place. These may be obtained from the gas supplier.



### GAS PRESSURE

The appliance and it’s individual shutoff valve (to be supplied by user) must be disconnected from the gas supply piping system during any pressure testing of that system at test pressures in excess of ½ psi (3.45 kPa).

The appliance must be isolated from the gas supply piping system by closing it’s individual manual shut-off valve during any pressure testing of the gas supply piping system at test pressures equal to or less than ½ psi (3.45 kPa).

Congratulations on your purchase of APW Wyott commercial cooking or refrigeration equipment. APW Wyott takes pride in the design and quality of our products. When used as intended and with proper care and maintenance, you will experience years of reliable operation from this equipment. To ensure best results, it is important that you read and follow the instructions in this manual carefully.

The countertop hot plate, models GHP-2H, -4H, -6H and GHPS-2H, -4H, -6H provides countertop heating and cooking capabilities. These units incorporate 2, 4 or 6 burners at 30,000 BTU/Hr each for fast, even cooking and heating.

### TABLE OF CONTENTS:

SECTION	ITEM	PAGE
1	Safety Precautions	2
2	General Installation Instructions	4
3	Specifications	4
4	Lighting Instructions	5
5	Maintenance	5
6	Conversion	6
7	Replacement Parts List & Exploded View	7
8	Warranty	11

#### LOCATION OF DATA PLATE

The data plate for the gas hot plate is located on the right side panel.

#### IMMEDIATELY INSPECT FOR SHIPPING DAMAGE

All containers should be examined for damage before and during unloading. The freight carrier has assumed responsibility for its safe transit and delivery. If equipment is received damaged, either apparent or concealed, a claim must be made with the delivering carrier.

A) Apparent damage or loss must be noted on the freight bill at the time of delivery. It must then be signed by the carrier representative (Driver). If this is not done, the carrier may refuse the claim. The carrier can supply

the necessary forms.

B) Concealed damage or loss if not apparent until after equipment is uncrated, a request for inspection must be made to the carrier within 15 days. The carrier should arrange an inspection. Be certain to hold all contents and packaging material.

Installation and start-up should be performed by a qualified installer who thoroughly read, understands and follows these instruction.

If you have questions concerning the installation, operation, maintenance or service of this product, write Technical Service Department APW Wyott Foodservice Equipment Company, P.O. Box 1829, Cheyenne, WY 82003.

## 2. GENERAL INSTALLATION INSTRUCTIONS:

Ensure gas supply and gas type, as shown on unit data plate agree. (Data plate is located on the right side panel of unit).

Unit installation must conform with the National Fuel Gas Code, ANSI Z223.1/NFPA 54, the National Gas Installation Code, CSA B149.1, or the Propane Installation Code, CSA B149.2 as applicable and in accordance with local codes.



Screw legs into the permanently fastened nuts on the four corners of the unit and tighten by hand. Level the unit by turning the adjustment screw at the bottom of each leg. Do not slide unit with legs mounted, lift if necessary to move unit.

Pipe gas supply to unit.

Pipe threading compound must be resistant to the action of liquefied petroleum gases.

These units are suitable for installation on non-combustible surfaces.

Unit must have adequate clearances for servicing. (Sides = 0", Rear = 6", Floor = 4").

	<b>Warning:</b> DO NOT use an open flame to check for leaks. Check all gas piping for leaks with a soap and water solution before operating unit.	
---	---	---

## 3. SPECIFICATIONS

These units are suitable for installation on NON-COMBUSTABLE surfaces only.

NON-COMBUSTABLE CLEARANCES		
Sides	Rear	Floor
0"	6"	4"

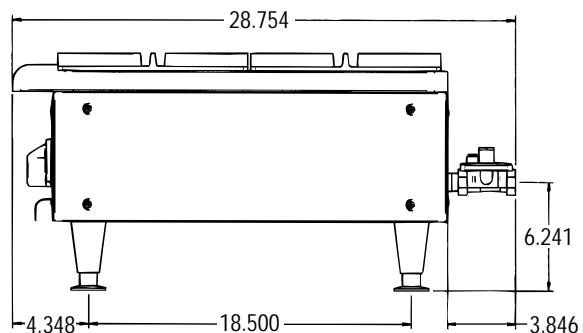
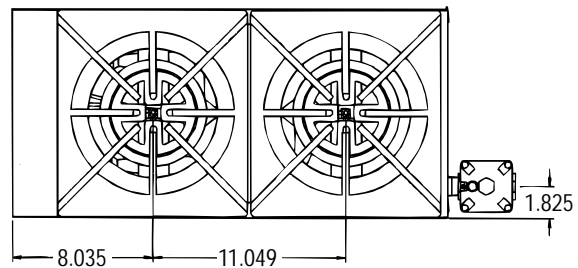
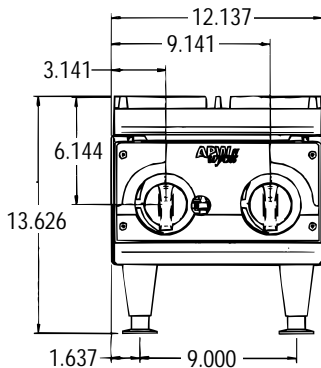

## 4. LIGHTING INSTRUCTIONS

Lighting instructions are located on the rear panel. Access to the pilot valves are gained through openings in the front panel. Access to the pilot burner is gained by removing the top grate.

### Lighting Pilot Burner:

1. Turn all burners to the "OFF" position.
2. Turn on the main gas supply to the unit.
3. Light the pilot and adjust the pilot regulating valve to give a stable pilot flame.
4. If the pilot is out, turn all control knobs to the "OFF" position. Wait 5 minutes before attempting to light the pilot.
5. To adjust the pilot flame, turn adjusting screw on the pilot valve to increase or decrease the size of the pilot flame. Adjust until the pilot flame is approximately  $\frac{1}{2}$ " (12mm) to  $\frac{3}{4}$ " (19mm) tall.

### Burner Ignition

Since the burner is lit from a constantly burning pilot, turn the control knob to "HI" to put the unit into operation; then adjust to any desired position between "LO" and "HI".

### Main Burner Air Supply:

For efficient burner operation, a proper balance of gas volume and primary air supply must be maintained which will result in complete combustion. Insufficient air supply results in a yellow streaming flame. Primary air supply is controlled by an air shutter on the burner.

Loosen the screws on the front of the venturi, and adjust the air shutter to eliminate the yellow on the burner flame. Lock the air shutter in place by tightening the screws.

All burners are lit from constantly burning pilots, turning the control valve as desired is all that is required to put the unit in service.



Do not permit fans to blow directly on the unit. Wherever possible, avoid open windows next to the unit's sides or back. Avoid wall type fans which create air cross-currents within the room.

It is also necessary that sufficient air should be allowed to enter the room to compensate for the amount of air removed by any ventilating system. Otherwise, a subnormal atmosphere will occur, adversely affecting operation and causing undesirable working conditions.

A properly designed and installed hood will act as the heart of the ventilating system for the room or area in which the unit is installed, and will leave the unit independent of changing draft conditions.

All valves must be checked and lubricated periodically. Consult the authorized service representative in your area.

## 5. MAINTENANCE

 **CAUTION:** Use only non-abrasive cleaners. Abrasive cleaners could scratch the finish of your unit, marring its appearance and making it susceptible to dirt accumulation. Do Not use steel wool, other abrasive cleaners or cleaners/sanitizers containing chlorine, iodine, ammonia or bromine chemicals as these will deteriorate the stainless steel and glass material and shorten the life of the unit. 

### Daily:

1. Thoroughly clean back, sides, top and front of unit.
2. Clean grates daily.

## Weekly:

1. Clean unit thoroughly. Clean stainless steel or chromed surfaces with a damp cloth and polish with a soft, dry cloth. A detergent may be used for cleaning. To remove discolorations, use a non-abrasive cleaner.
2. To clean the drip pan: Remove the drip pan by grabbing the handle and pulling it out of the opening in the front panel. To replace the pan, reverse this procedure.
3. Burner air shutter openings must be kept clean.
4. Main burner ports must be kept clean. To clean burners, boil them in a strong solution of lye water for 15 to 20 minutes. Then either brush with a wire brush or clean gas ports with a sharp-pointed metal instrument to insure open ports.



**CAUTION:** Clean the regulator at least once a month. Make sure the vent opening is open and not blocked in any way. Failure to do so will cause variations in pressure. Your unit will not function as well and it could shorten the life of the product.



## 6. CONVERSION

For conversion from natural gas to propane (L.P.).

This conversion should be done before connecting the unit to the gas supply.

Units are shipped from the factory equipped for use on natural gas. Orifices necessary for LP (propane) are provided in a bag tied to the valve on the front panel.

1. Remove the knobs and front panel.
2. Remove the main burners.
3. Remove the orifice fittings from the valves.
4. Replace the orifice fittings with the size recommended for propane (L.P.).
5. Replace the main burners.
6. Before installing the regulator, remove the cap. With the brass portion of the cap up, you can read (NAT) on the plastic insert. Snap the insert out of the cap, flip it over and snap back in place. You can now read (L.P.). Or change the regulator to a L.P. Regulator.
7. Replace the front panel and knobs.
8. Continue with the installation.

**Note:** Manifold pressure should be checked after the unit is connected to the gas supply. It should be 10 inches (25.4 cm) water column for (L.P.). If not, you can adjust the regulator by turning the white, plastic insert in the regulator stem: Clockwise increases pressure and counter-clockwise decreases pressure.

Manifold pressure should be 6 inches (15.2cm) water column for Natural gas. Leak test all joints.

If you should have any questions or problems, contact your nearest APW Wyott Service Representative.

# 7. REPLACEMENT PARTS LIST & EXPLODED VIEW

GHP-2H (CE)

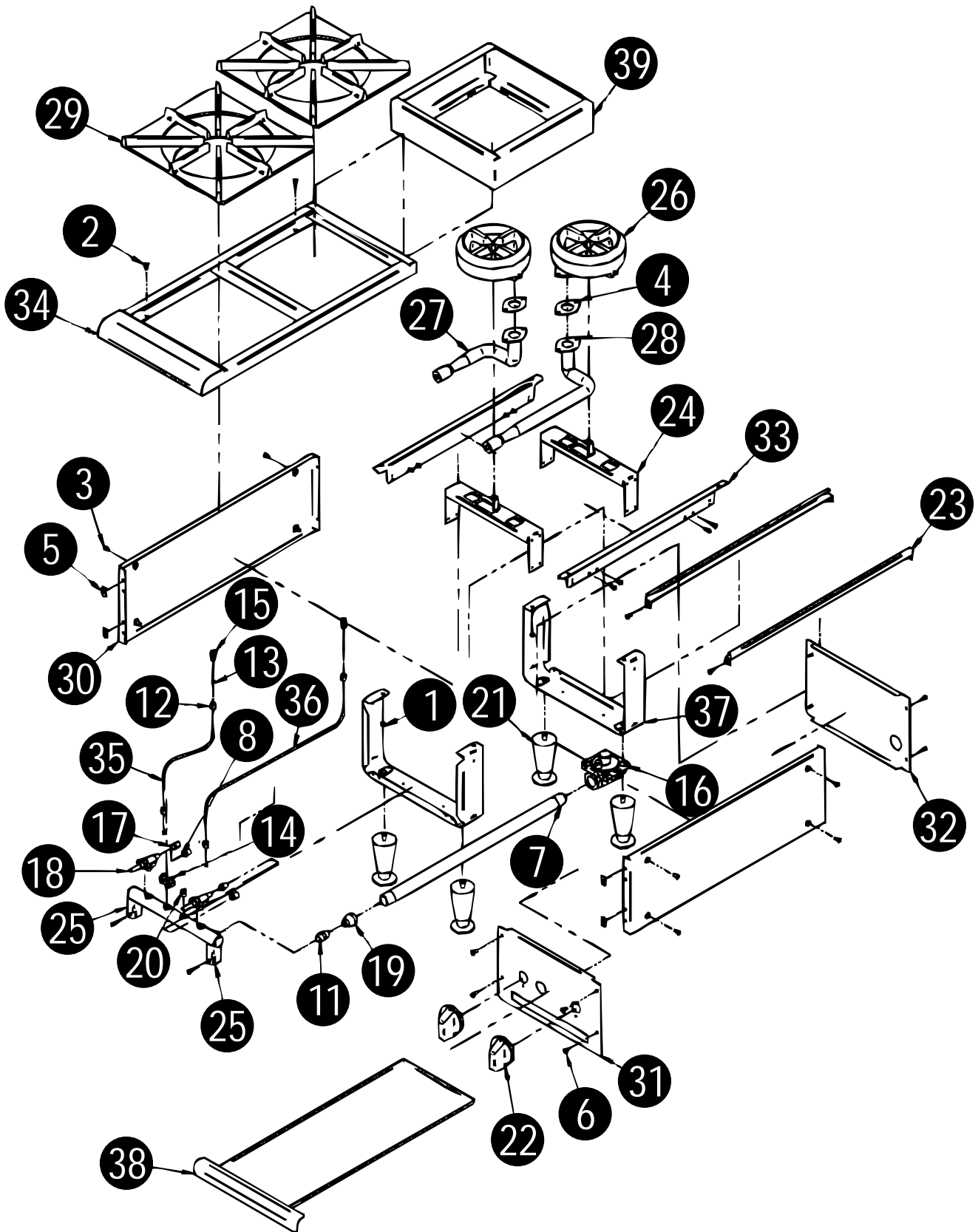

Item	P/N	Description	Quan	Item	P/N	Description	Quan
1	8417100	Nut, Hex, KEPS 10-32	Varies	26	2065900	Burner, Cast, GHP/GHPS	Varies
2	8175900	Screw, 10-32 X 1/2 Tr Hd, SS	4	27	2065913	Venturi, Front, 5.85" Lg	Varies
3	8170700	Screw, 10-32x1/2, Type AB	Varies	28	2065914	Venturi, Rear, 12.578" Lg.	Varies
4	2065916	Gasket, Burner	Varies	29	2201610	Grate, Individual, GHP-2H	Varies
5	8196601	Nut, U-type	4	30	21813313	Side Panel, LH & RH	2
6	81973-00	T/S #10 X 1/2 TPB Tr Hd	4		21815584	Side Panel, LH & RH GHPW	2
7	2092621	Pipe, 3/4" Sch. 40, 20-5/8	Varies	31	218203-19	Front Panel, GHP/GHPS-2H	1
8	2066852	Hood, Orifice, #52	Varies		218204-11	Front Panel, GHP/GHPS-4H	1
9*	8824302	Decal, Front Panel GHP 2 Burner	1		218205-19	Front Panel, GHP/GHPS-6H	1
	8824304	Decal, Front Panel GHP 4 Burner	1	32	218155-27	Back Panel GHP/GHPS-2H	1
	8824306	Decal, Front Panel GHP 6 Burner	1		218131-15	Back Panel GHP/GHPS-4H	1
	8824310	Decal, Dial Plate GHPW	Varies		218132-15	Back Panel GHP/GHPS-6H	1
10*	8838900	Manual, GHP-H Champion li	1	33	21815528	Support, Burner Side	2
11	2034000	Nipple, 3/8 NPT	1		21815585	Support, Burner Side GHPW	2
12	2065634	Nut, Compression 3/8-24 Brass	Varies	34	21815538	Weldment, Top, GHP/GHPS-2H	1
13	2065635	Sleeve, Compression For 3/16ø	Varies		21815539	Weldment, Top, GHP/GHPS-4H	1
14	2065641	Valve, Pilot 1/8" NPT Dual 3/16"	1		21815540	Weldment, Top, GHP/GHPS-6H	1
15	2066154	Pilot, Top	Varies		21815581	Weldment, Top, GHPW-2H	1
16	2067300	Regulator, Convertable 3/4 1/2 PSIG	1		21815815	Weldment, Top, GHPW-3H	1
17	2066842	Hood, Orifice, #42	Varies	35	21815564	Tube, Front Pilot GHP-H	Varies
18	2068200	Valve, Gas, On-Off	Varies	36	21815565	Tube, Rear Pilot GHP-H	Varies
19	2092512	Coupling, 3/4x3/8, F-F, NPT	1		21815566	Tube, Rear Pilot Step GHP-H	Varies
20	2092517	Plug, 1/8 NPTM	1	37	218203-23	Support, Leg GHP-2H	2
21	8632000	Leg, 4" Adj., 2000 Lb Cap.	4		218204-23	Support, Leg GHP-4H	2
22	8705800	Knob, Med. Duty Unit	Varies		218205-23	Support, Leg GHP-6H	2
23	21815522	Support, Drip Pan, GHP/GHPS	Varies	38	218203-20	Weldm't, Drip Pan	Varies
24	21815529	Support, Burner/pilot GHP/GHPS-2H	2	39	21815593	Step, 12" Weldm't GHPS	1
	21815530	Support, Burner/pilot GHP/GHPS-4H	2		21815594	Step, 24" Weldm't GHPS	1
	21815531	Support, Burner/pilot GHP/GHPS-6H	2		21815595	Step, 36" Weldm't GHPS	1
25	21815533	Manifold, 3/4" Pipe GHP/GHPS-2H	1				
	21815534	Manifold, 3/4" Pipe GHP/GHPS-4H	1				
	21815535	Manifold, 3/4" Pipe GHP/GHPS-6H	1				
	21815813	Manifold, 3/4" Pipe GHP/GHPS-3H	1			*NOT SHOWN	





## 8. APW WYOTT EQUIPMENT LIMITED WARRANTY

APW Wyott Foodservice Equipment Company warrants its equipment against defects in materials and workmanship, subject to the following conditions:

This warranty applies to the original owner only and is not assignable.

Should any product fail to function in its intended manner under normal use within the limits defined in this warranty, at the option of APW Wyott such product will be repaired or replaced by APW Wyott or its Authorized Service Agency. APW Wyott will only be responsible for charges incurred or service performed by its Authorized Service Agencies. The use of other than APW Wyott Authorized Service Agencies will void this warranty and APW Wyott will not be responsible for such work or any charges associated with same. The closest APW Wyott Authorized Service Agent must be used.

This warranty covers products shipped into the 48 contiguous United States, Hawaii, metropolitan areas of Alaska and Canada. There will be no labor coverage for equipment located on any island not connected by roadway to the mainland.

Warranty coverage on products used outside the 48 contiguous United States, Hawaii, and metropolitan areas of Alaska and Canada may vary. Contact the international APW Wyott distributor, dealer, or service agency for details.

### Time Period

One year for parts and one year for labor, effective from the date of purchase by the original owner. The Authorized Service Agency may, at their option, require proof of purchase. Parts replaced under this warranty are warranted for the un-expired portion of the original product warranty only.

### Exceptions

**\*Gas/Electric Cookline:** Models GCB, GCRB, GF, GGM, GGT, CHP-H, EF, EG, EHP. Three (3) Year Warranty on all component parts, except switches and thermostats. (2 additional years on parts only. No labor on second or third year.)

**\*Broiler Briquettes, Rock Grates, Cooking Grates, Burner Shields, Fireboxes:** 90 Day Material Only. No Labor.

**\*Heat Strips:** Models FD, FDL, FDD, FDDL. Two (2) Year Warranty on element only. No labor second year.

**\*Glass Windows, Doors, Seals, Rubber Seals, Light Bulbs:** 90 Day Material Only. No Labor.

In all cases, parts covered by extended warranty will be shipped FOB the factory after the first year.

### Portable Carry In Products

Equipment weighing over 70 pounds or permanently installed will be serviced on-site as per the terms of this warranty. Equipment weighing 70 pounds or under, and which is not permanently installed, i.e. with cord and plug, is considered portable and is subject to the following warranty handling limitations. If portable equipment fails to operate in its intended manner on the first day of connection, or use, at APW Wyott's option or its Authorized Service Agency, it will be serviced on site or replaced.

From day two through the conclusion of this warranty period, portable units must be taken to or sent prepaid to the APW Wyott Authorized Service Agency for in-warranty repairs. No mileage or travel charges are allowed on portable units after the first day of use. If the customer wants on-site service, they may receive same by paying the travel and mileage charges. Exceptions to this rule: (1) countertop warmers and cookers, which are covered under the Enhanced Warranty Program, and (2) toasters or rollergrills which have in store service.

### Exclusions

The following conditions are not covered by warranty:

\*Equipment failure relating to improper installation, improper utility connection or supply and problems due to ventilation.

\*Equipment that has not been properly maintained, calibration of controls, adjustments, damage from improper cleaning and water damage to controls.

\*Equipment that has not been used in an appropriate manner, or has been subject to misuse or misapplication, neglect, abuse, accident, alteration, negligence, damage during transit, delivery or installation, fire, flood, riot or act of god.

\*Equipment that has the model number or serial number removed or altered.

If the equipment has been changed, altered, modified or repaired by other than an Authorized Service Agency during or after the warranty period, then the manufacturer shall not be liable for any damages to any person or to any property, which may result from the use of the equipment thereafter.

This warranty does not cover services performed at overtime or premium labor rates. Should service be required at times which normally involve overtime or premium labor rates, the owner shall be charged for the difference between normal service rates and such premium rates. APW Wyott does not assume any liability for extended delays in replacing or repairing any items beyond its control.

In all cases, the use of other than APW Wyott Authorized OEM Replacement Parts will void this warranty.

This equipment is intended for commercial use only. Warranty is void if equipment is installed in other than commercial application.

### Water Quality Requirements

Water supply intended for a unit that has in excess of 3.0 grains of hardness per gallon (GPG) must be treated or softened before being used. Water containing over 3.0 GPG will decrease the efficiency and reduce the operation life of the unit.

**Note: Product failure caused by liming or sediment buildup is not covered under warranty.**

**“THE FOREGOING WARRANTY IS IN LIEU OF ANY AND ALL OTHER WARRANTIES EXPRESSED OR IMPLIED INCLUDING ANY IMPLIED WARRANTY OF MERCHANTABILITY OR FITNESS FOR PARTICULAR PURPOSES AND CONSTITUTES THE ENTIRE LIABILITY OF APW WYOTT. IN NO EVENT DOES THE LIMITED WARRANTY EXTEND BEYOND THE TERMS STATED HEREIN.”**

9/05



---

**APW WYOTT Foodservice Equipment Company**

P.O. Box 1829  
Cheyenne, WY 82003

+1 (307) 634-5801 Phone  
+1 (307) 637-8071 Fax

+1 (800) 752-0863 Toll Free  
[www.apwwyott.com](http://www.apwwyott.com)