



**THE
GAYLORD
TECHNICAL MANUAL**

FOR THE CUV-1000 CONTROL CABINET

GAYLORD INDUSTRIES

10900 S.W. AVERY STREET • TUALATIN, OREGON 97062 U.S.A.
800-547-9696 • 503-691-2010 • FAX: 503-692-6048 • email: info@gaylordusa.com



GAYLORD INDUSTRIES

World Headquarters: 10900 SW Avery Street • Tualatin, Oregon 97062 U.S.A.

To Our Customers. . .

Congratulations on your recent purchase of a Gaylord kitchen exhaust hood system. We are proud to be able to provide you with a quality product that incorporates the latest engineering concepts and is a result of over 60 years of experience in the foodservice kitchen exhaust industry.

If you have other Gaylord equipment such as a Gaylord Ventilator, Utility Distribution System, Quencher Fire Protection System, or Roof Top Air Handling Equipment, etc., please refer to the corresponding supplementary equipment manuals.

If you have further questions, please call us toll free at 1-800-547-9696 or email: info@gaylordusa.com. We are more than happy to help.

Sincerely,
Gaylord Industries

STREET ADDRESS: 10900 S.W. Avery Street, Tualatin, Oregon 97062 U.S.A.

PHONE: 503-691-2010 • 800-547-9696 • **FAX:** 503-692-6048 • **email:** info@gaylordusa.com • www.gaylordusa.com

COMMERCIAL KITCHEN EXHAUST SYSTEMS • FIRE PROTECTION • UTILITY DISTRIBUTION • ROOF TOP UNITS • POLLUTION CONTROL

TABLE OF CONTENTS

GENERAL DESCRIPTION _____	5
STARTING THE EXHAUST / SUPPLY FANS AND UV LAMPS _____	6
STOPPING THE EXHAUST / SUPPLY FANS AND UV LAMPS _____	7
AUTOSTART _____	8
REMOTE START _____	10
EXTERNAL FIRE - FIRE PROTECTION SYSTEM ACTIVATED _____	11
INTERNAL FIRE - THERMOSTAT ACTIVATED _____	12
UV SAFETY _____	13
UV SAFETY INTERLOCKS _____	14
UL LAMP FAILURE _____	15
FANS ON - UV SYSTEM OFF _____	16
UL LAMP LIFE _____	17
REMOTE MONITORING - OPTIONAL _____	18
CONTROL FUNCTION MATRIX _____	19
PLC STATUS LIGHTS _____	20
CUV-1000 PARTS LIST _____	21
WIRING DIAGRAM - INTERNAL _____	24
CUV-1000 TERMINAL VOLTAGES _____	25
WIRING DIAGRAM - EXTERNAL _____	26
WIRING DIAGRAM "UV" VENTILATORS WITH "ND", "FDD", OR "GBD" _____	27
WIRING DIAGRAM "UV" VENTILATORS WITH "ND", "FDD", OR "GBD" WITH AUTOSTART _____	28
WIRING DIAGRAM "UV" VENTILATORS WITH "GFBD" _____	29
WIRING DIAGRAM "UV" VENTILATORS WITH "GFBD" WITH AUTOSTART _____	30

ALL RIGHTS RESERVED. NO PART OF THIS BOOK MAY BE REPRODUCED, STORED IN A RETRIEVAL SYSTEM, OR TRANSMITTED IN ANY FORM BY AN ELECTRIC, MECHANICAL, PHOTOCOPYING, RECORDING MEANS OR OTHERWISE WITHOUT PRIOR WRITTEN PERMISSION OF GAYLORD INDUSTRIES COPYRIGHT 2009.

© Copyright 2009, Gaylord Industries

The manufacturer reserves the right to modify the materials and specifications resulting from a continuing program of product improvement or the availability of new materials.

ADDITIONAL COPIES \$15.00



This page intentionally left blank.

GENERAL DESCRIPTION

The **CUV-1000** Control Cabinet is designed to control one or more Gaylord “UV” ventilators. It will control the Exhaust and Supply Fan(s), Ultraviolet Lamps (UV), interface with the FP system and/or Building Management System (BMS). It may also be connected to an Autostart device, Gaylord model “TST”, in the ventilator to comply with IMC 507.2.1.1. For further information specific to a ventilator it will be necessary to refer to the appropriate Gaylord “UV” ventilator Technical Manual.

Model Number Description:

The Model Number describes options that may be included in the Control Cabinet.

CUV-1000

- Standard Control Cabinet

Options:

- “**LS**” - Includes a Light Switch built-in to cabinet
- “**TR**” - Includes a Trim Ring around cabinet
- “**RM**” - Includes a Remote Monitoring Option
- “**220V**” - Control is designed to be connected to 220VAC power source

Examples:

- **CUV-1000**
- **CUV-1000-LS-TR**
- **CUV-1000-220V**
- **CUV-1000-LS-TR-RM-220V**



STARTING THE EXHAUST / SUPPLY FANS AND UV LAMPS

Starting CUV-1000

THE CUV-1000 CAN BE STARTED THROUGH ONE OF THREE OPTIONS:

1. Manually - Press the “F1” (FAN ON) button
2. Autostart - Autostart thermostats in the ventilator activate the CUV-1000
3. Remotely - Remotely start the CUV-1000 from a switch or BMS

*See the following pages for more details on each of these options

Starting the Exhaust/Supply Fan(s) and UV Lamps

To start the Fan(s) press the “F1” (FAN ON) button.

Pressing the “F1” (FAN ON) button will result in:

1. Exhaust Fan On
2. Supply Fan On
3. UV Lamps On
4. Electric Dampers Open (if applicable)

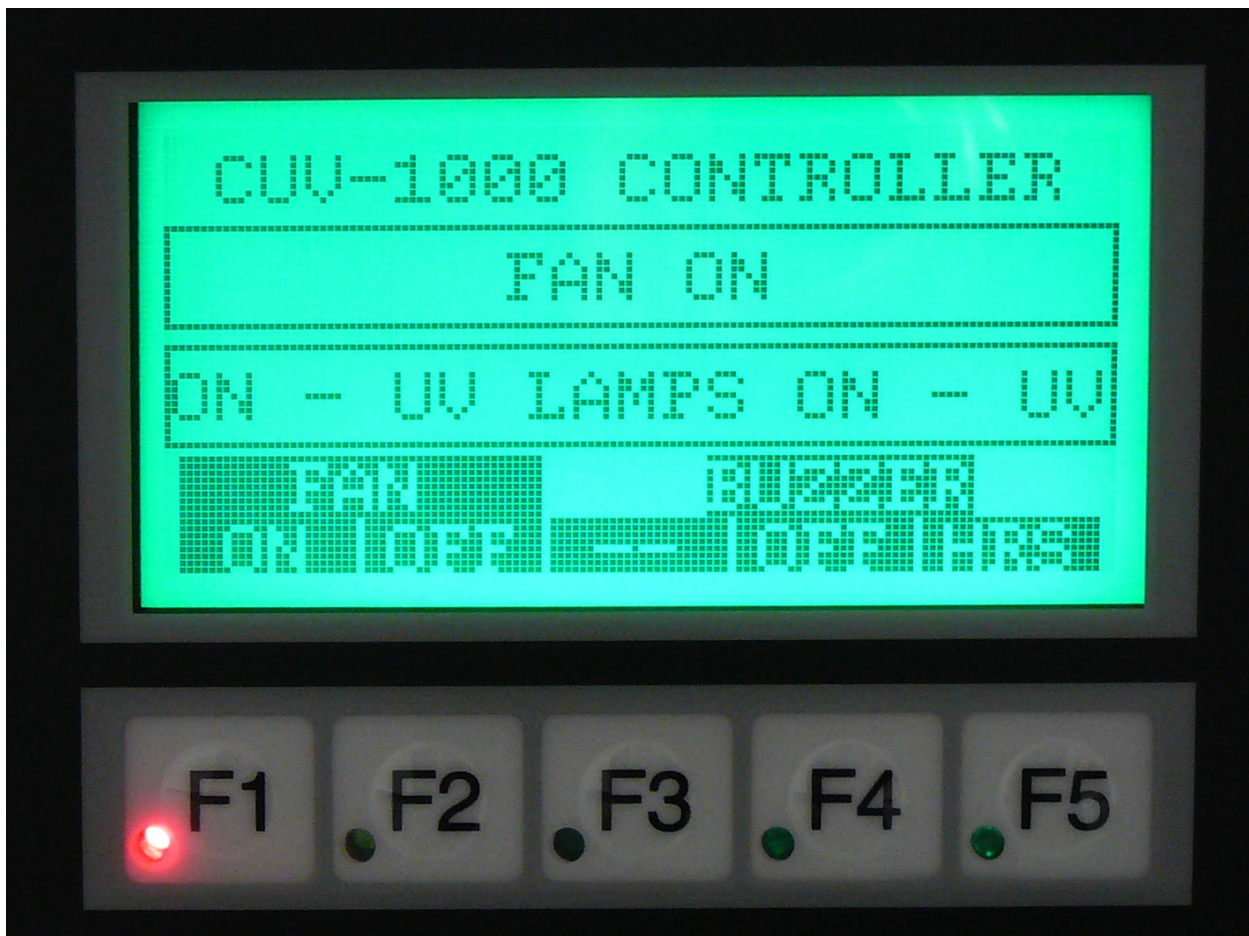

STOPPING THE EXHAUST / SUPPLY FANS AND UV LAMPS

Stopping the Exhaust/Supply Fan(s) and UV Lamps

To stop the Fan(s) press the “F2” (FAN OFF) button.

Pressing the “F2” (FAN OFF) button will result in:

1. Exhaust Fan Off
2. Supply Fan Off
3. UV Lamps Off
4. Electric Dampers Closed (if applicable)

Note:

If the ventilator(s) connected to the **CUV-1000** are equipped with Autostart thermostats (TST's), refer to the Autostart information on the following pages, and the temperature in the ventilator canopy is above the 90°F, the Exhaust and Supply Fan(s) and UV Lamps will “Autostart” and continue to run until the temperature in the ventilator canopy cools below 90°F. After the temperature cools below 90°F, the Exhaust and Supply Fan(s) and UV Lamps will run for 60 minutes, then shut off. Pressing the “F2” (FAN OFF) button will stop the Fans and UV, but if the temperature is still above 90°F, the Fans and UV will “Autostart” again.

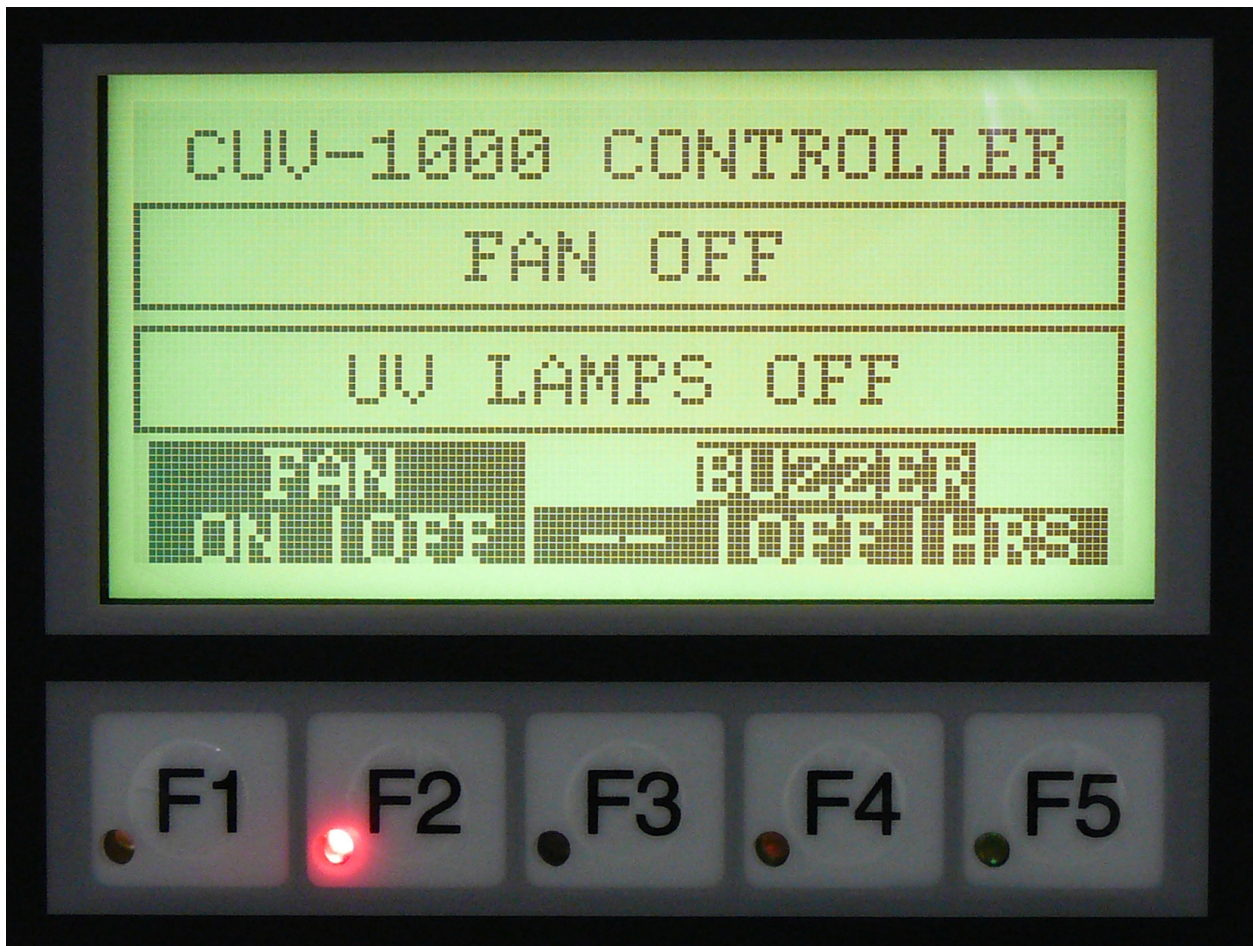

AUTOSTART

Code Requirements:

Some municipalities require the exhaust fan to start automatically whenever cooking operations occur, to comply with IMC 507.2.1.1. This code requires the exhaust fan to be interlocked with the cooking equipment such that it will start whenever cooking operations occur. This can be accomplished with Temperature Sensing Thermostat(s) in the ventilator, Gaylord model "TST".

Description:

The **CUV-1000** is designed to start the Exhaust and Supply Fan(s) automatically when cooking starts, IF the ventilator it is connected to is equipped with Autostart thermostats, Gaylord model "TST". The Autostart thermostats (TST's) are preset at the factory to 90°F. They may be adjusted in the field, if necessary.

Operation:

Whenever the temperature in the ventilator canopy is above 90°F, and the **CUV-1000** is OFF, the Exhaust and Supply Fan(s), and UV Lamps will start automatically in "Autostart" mode, and display the text shown below.

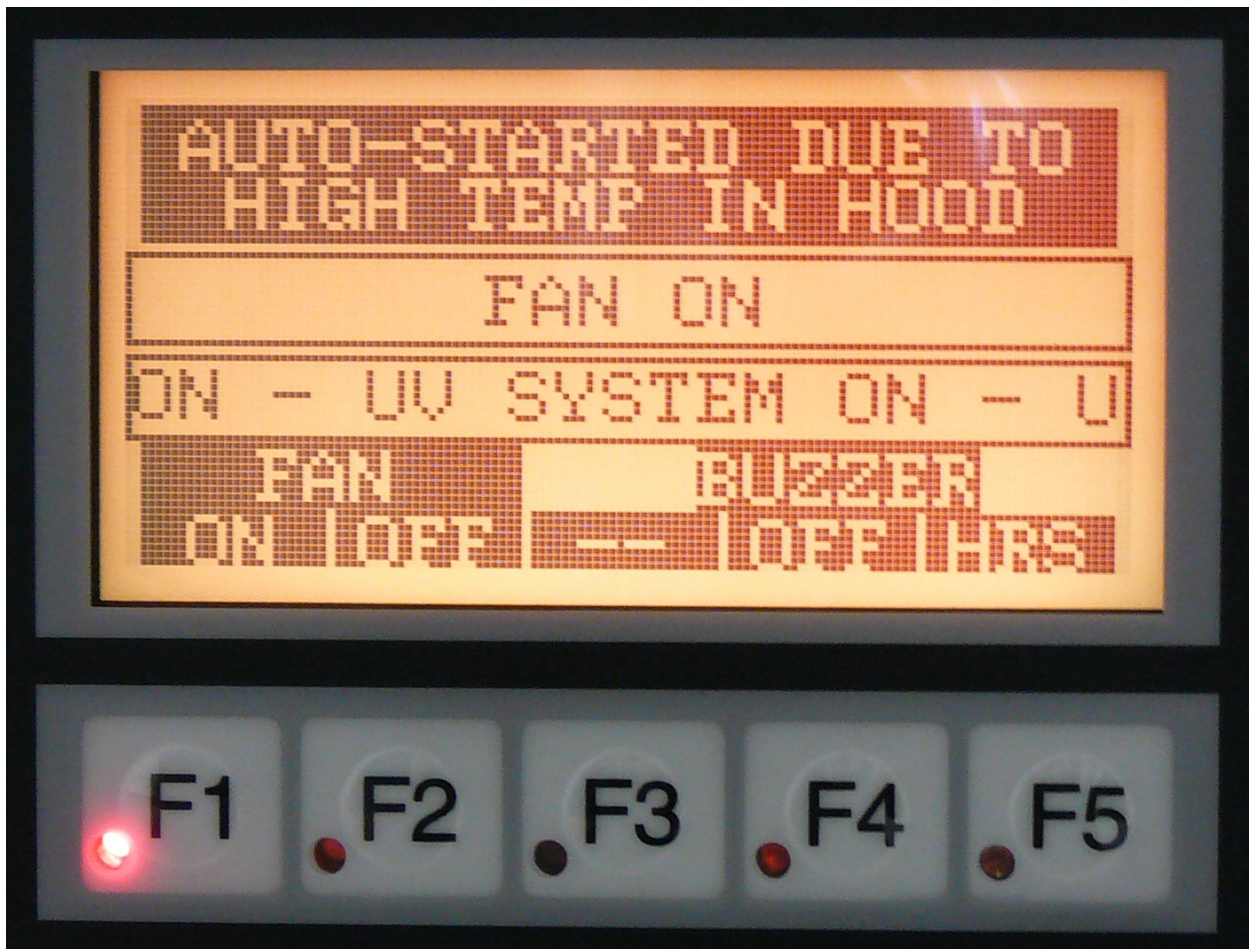

AUTOSTART

Automatic Shutdown:

After the temperature in the ventilator canopy drops below 90°F, the **CUV-1000** will start to countdown from 60 minutes. After 60 minutes the Exhaust and Supply Fan(s), and UV Lamps will shut off automatically. Once the countdown has started the Fans and UV can be shut down by pressing the “**F2**” (**FAN OFF**) button. This will cancel the countdown.

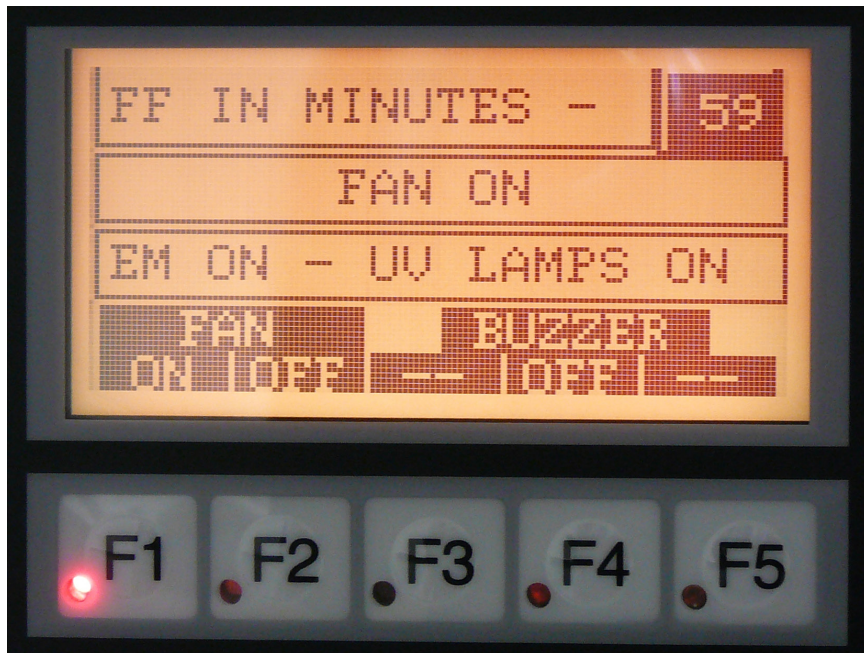

Note:

The Fans and UV should typically be started manually. By pressing the “**F1**” (**FAN ON**) button. The Autostart is provided as a back-up when the user forgets to start the Fans (when cooking). While in “Autostart” mode, pressing the “**F1**” (**FAN ON**) button will put the **CUV-1000** back into a normal “Fan On” mode.

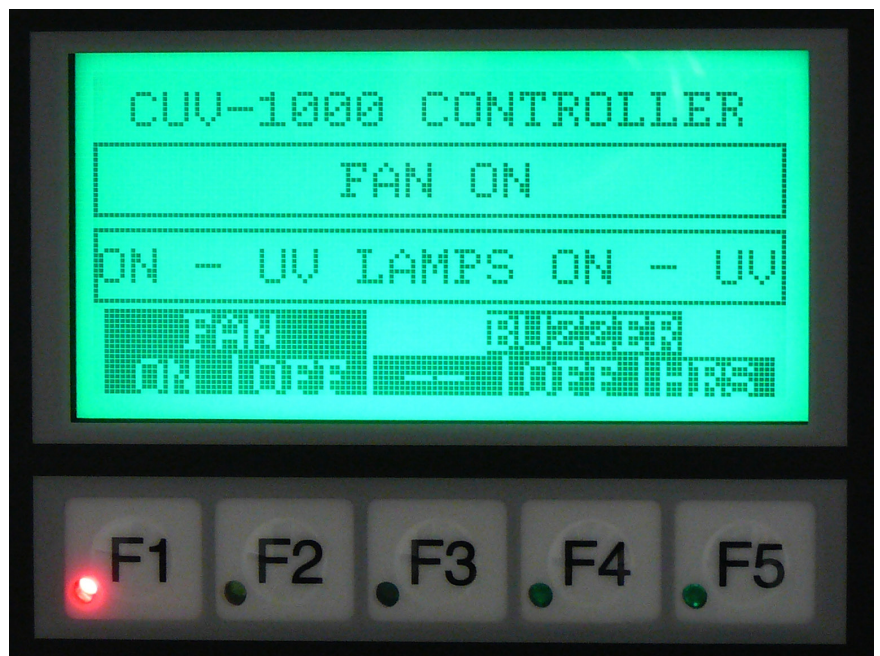

REMOTE START

Description:

The **CUV-1000** can be started remotely, from a Fan On/Off Switch located elsewhere, or from a Building Management System (BMS). This is accomplished by connecting terminals “RF1” and “RF2” to a set of normally open contacts. Please note that terminal “RF1” has 120VAC on it. Refer to the **CUV-1000** Internal Wiring diagram for more details.

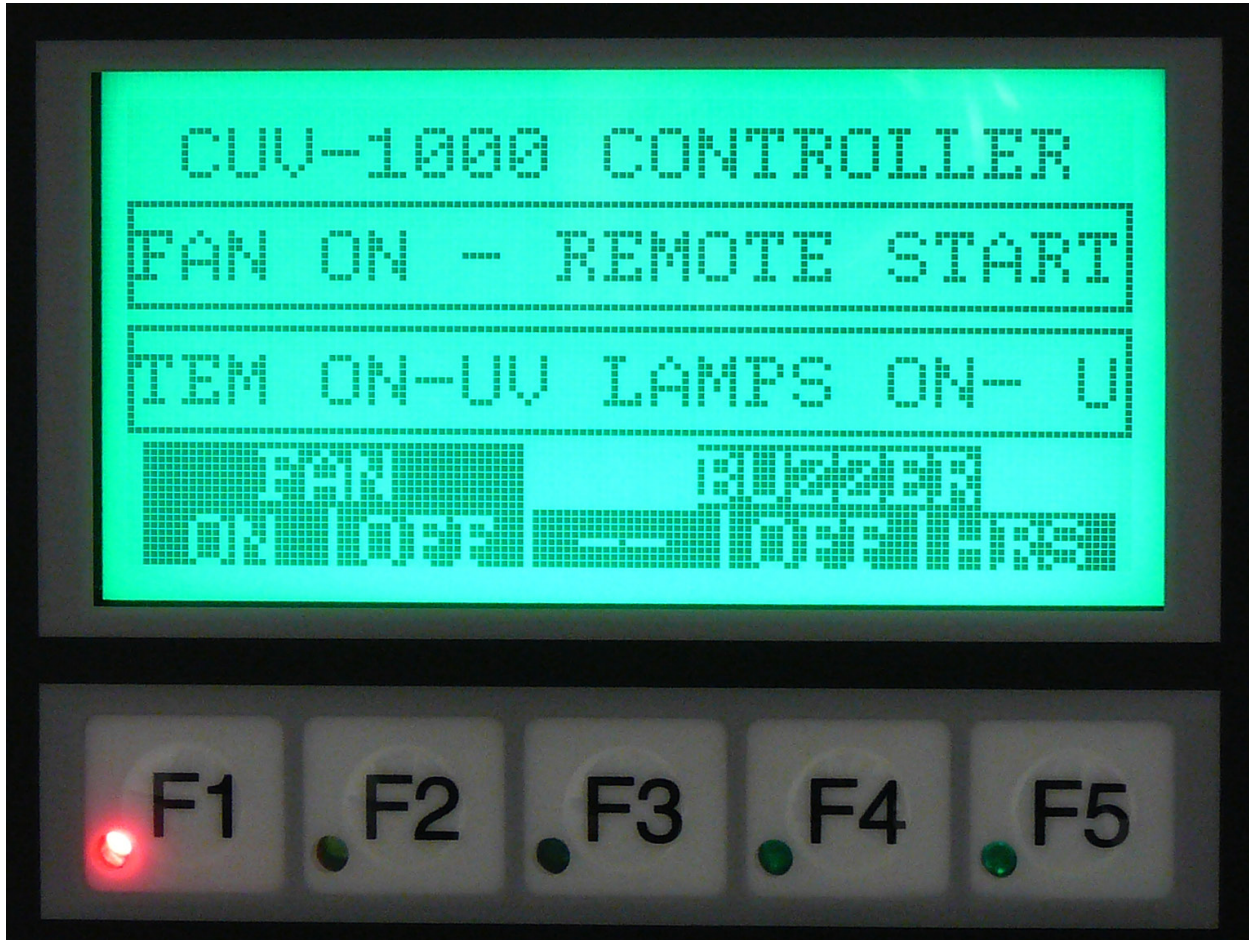

Operation:

When the **CUV-1000** is Remotely Started, the Exhaust and Supply Fan(s), and UV Lamps will start.

Note:

The Fans and UV cannot be shut off at the **CUV-1000**, if it is running in “Remote Start” mode. They must be shut off “Remotely”.

EXTERNAL FIRE - FIRE PROTECTION SYSTEM ACTIVATED

Description:

The **CUV-1000** should be wired to the Fire Protection System for the Ventilator(s) it is controlling. A set of normally open contacts in the Fire Protection System needs to be wired to terminals “4” and “FS” in the **CUV-1000**, refer to the **CUV-1000** Internal Wiring Diagram for more details. Please note that terminal “4” has 120VAC on it. If the Surface Fire Protection System for the Ventilator(s) is activated the **CUV-1000** will be placed in an “External Fire” mode.



Operation:

In an “External Fire” mode, the CUV-1000 will:

1. Start Exhaust Fan
2. Shut off Supply Fan
3. Shut off UV Lamps
4. Open Electric Dampers (if applicable)
5. Close Alarm Contacts “A1” & “A2” - refer to CUV-1000 Terminals for more details
6. Open Alarm Contacts “Q1” & “Q2” - refer to CUV-1000 Terminals for more details

Note:

The Fans and UV cannot be restarted until the microswitch in the Fire Protection System for the Ventilator(s) has been reset. After the microswitch has been reset, the Fans and UV can be restarted by pressing the “F1” (**FAN ON**) button.

INTERNAL FIRE - THERMOSTAT ACTIVATED

Description:

If the ventilator(s) connected to the **CUV-1000** are equipped with thermostat(s) at the duct/plenum to detect fire, and a fire is detected at the Exhaust Duct collar, the **CUV-1000** will go into an "Internal Fire" mode. Refer to the appropriate Gaylord "UV" ventilator Technical Manual for thermostat location and temperature setting.



Operation:

In an "Internal Fire" mode, the CUV-1000 will:

1. Shut off Exhaust Fan
2. Shut off Supply Fan
3. Shut off UV Lamps
4. Close Electric Dampers (if applicable)
5. Close Alarm Contacts "A1" & "A2" - refer to CUV-1000 Terminals for more details
6. Open Alarm Contacts "Q1" & "Q2" - refer to CUV-1000 Terminals for more details

Note:

After the temperature at the thermostat(s) cools below its' activation temperature, the Fans and UV can be restarted by pressing the "**F1**" (**FAN ON**) button.

Warning:

DO NOT defeat the purpose of the UV Safety Interlocks during Cleaning or Maintenance!

As with many types of technology if it is not used properly and/or proper precautions are not taken there is the potential for injury or harm. This is especially true with UVC light due to the fact that it does not physically hurt at the time of exposure. While UVC is very effective at breaking down grease molecules, direct exposure to large amounts is harmful to skin and eyes. The amount of UVC generated in these ventilators is greater than that what results from direct exposure to the sun. Under no circumstances is it acceptable to view the lighted lamps without proper eye protection or expose bare skin directly to the light. All interlocks and safety precautions called for in this manual must be followed to avoid the potential for harm to service personnel and/or operators. In addition, only trained and authorized personnel may perform some maintenance.

Personal Protective Equipment

Personal Protective equipment must be used at all times when working on any Gaylord “UV” ventilators, this includes:

1. Eye protection that prevents 100% of UVC being transmitted through the lens must be worn at all times when performing service work on any Gaylord “UV” ventilator that is energized and/or has the potential to be energized and expose personnel to UVC light.
2. Whenever service work is performed it is recommended that long sleeve shirts and long pants be worn to minimize the potential for inadvertent exposure of the skin to UVC.

UV SAFETY INTERLOCKS

Description:

The Gaylord “UV” ventilators are equipped with sensors to verify that all access doors are closed, all extractors are in place, and that the exhaust fan is running. The UV Lamps will NOT run unless ALL of the UV Safety Interlocks are in place and working properly. Refer to the appropriate Gaylord “UV” ventilator Technical Manuals for more details

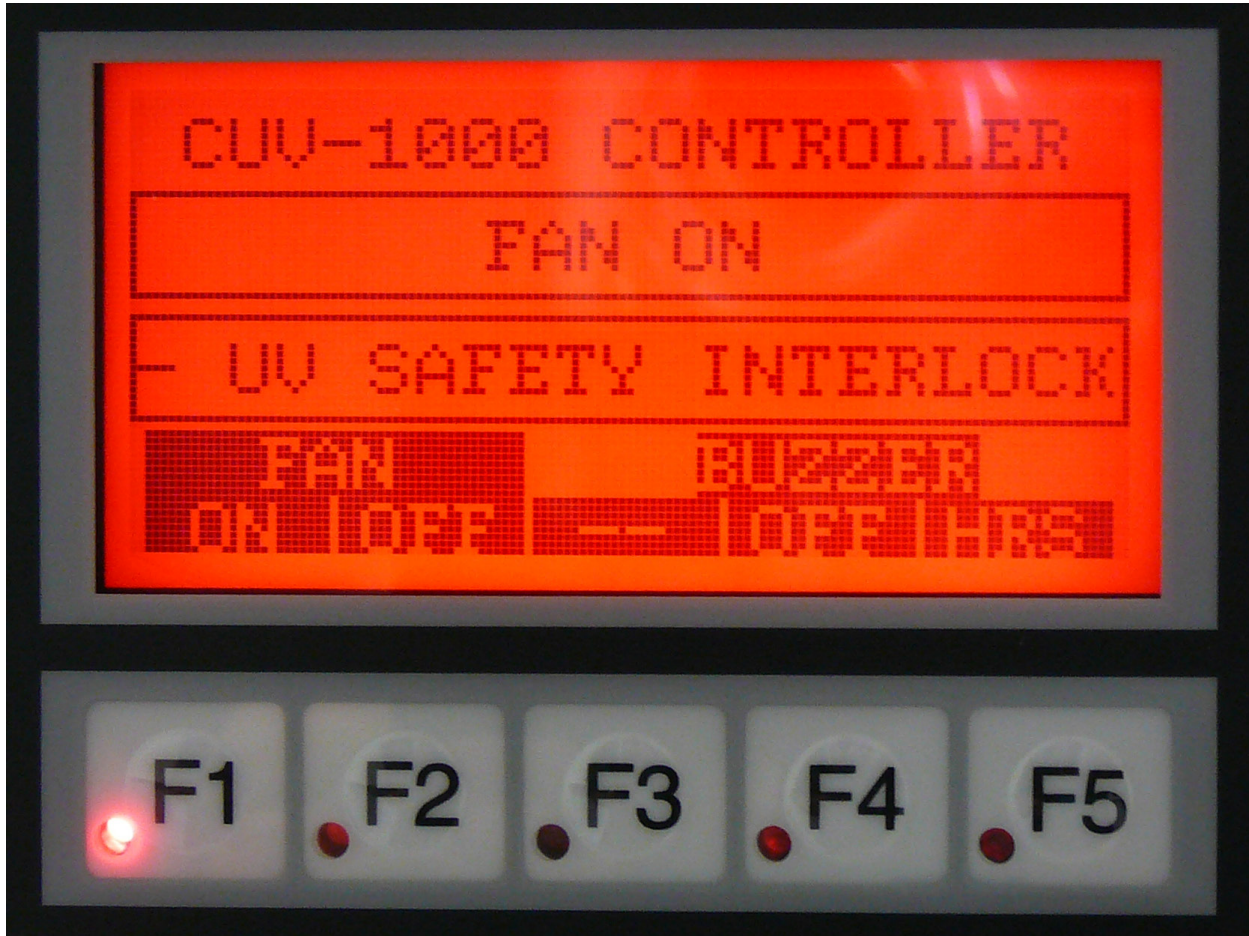

Operation:

When any of the UV Safety Interlocks are activated, the CUV-1000 will:

1. Run Exhaust Fan
2. Run Supply Fan
3. Shut OFF UV Lamps
4. Audible Alarm at CUV-1000 will sound

Silencing the Audible Alarm:

To silence the alarm correct the problem with the UV Safety Interlock, refer to the appropriate Gaylord “UV” ventilator Technical Manuals for more details, or press, the “F4” (**BUZZER OFF**) button. This will silence the alarm until the system is stopped and restarted. The “F4” (**BUZZER OFF**) button will need to be pressed each time the **CUV-1000** is restarted until the problem with the UV Safety Interlock is corrected.

UL LAMP FAILURE

Description:

When the UV Controller in a Gaylord “UV” ventilator senses that a UV Lamp is out or a ballast has failed, the “UV Lamp Failure” message will be displayed on the **CUV-1000**. This message indicates that one or more UV Lamps/Ballast are not working. Refer to appropriate Gaylord “UV” ventilator Technical Manual for troubleshooting details. If one UV Lamp is out, the Fans and remaining UV Lamps will continue to run. In most cooking applications, having one or two UV Lamps out will not hinder the performance of the UV. The number of UV Lamps are designed to handle the worst case cooking applications. Therefore, even if one or more UV Lamps are not working the UV will continue to clean the air and keep the Plenum, Exhaust Duct, and Exhaust Fan clean.

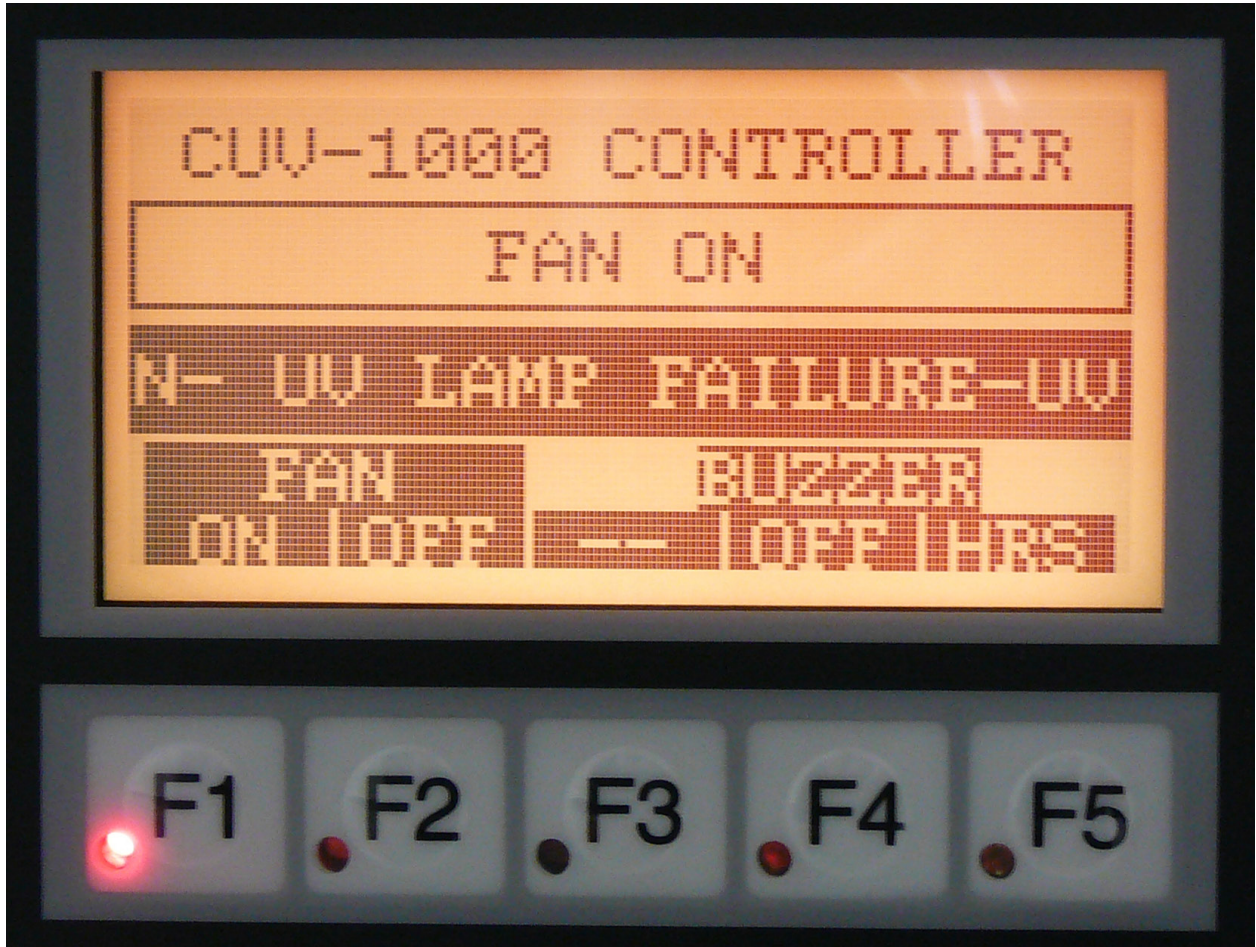

Note:

If there is a “UV Lamp Failure” less UV is being generated, but it does not prevent the operation of the ventilator or indicate an unsafe condition.

FANS ON - UV SYSTEM OFF

Description:

If the **CUV-1000** is turned On, and the screen says “**UV SYSTEM OFF**”, screen below is displayed, the following items should be looked at:

1. Verify that all of the circuit breakers for the UV Modules are turned On, check for power at the ventilator on L1 & L2, refer to the appropriate Gaylord “UV” ventilator Technical Manual for more details

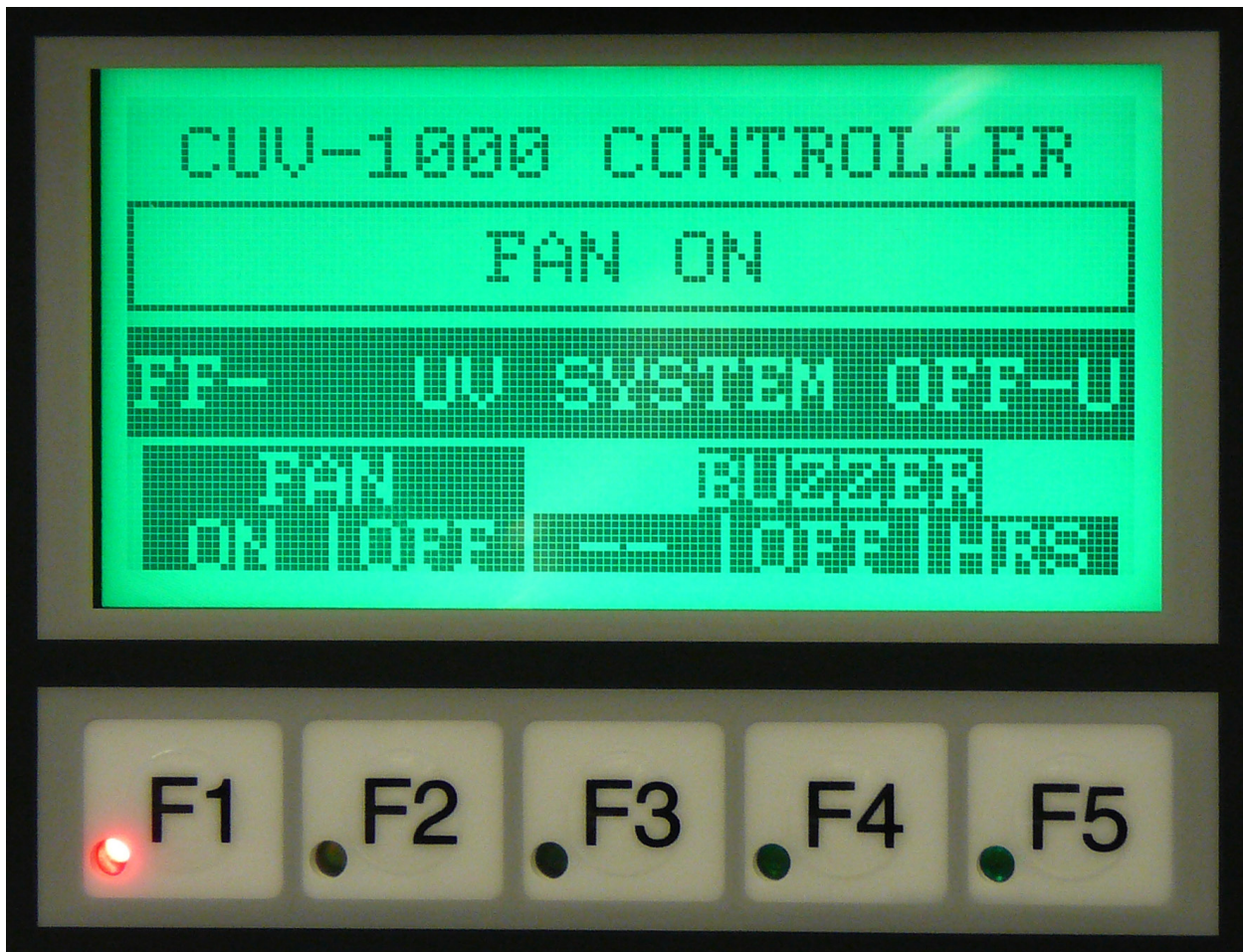

Description:

The UV Lamps need to be changed out after 8000 hours of use by a Gaylord Certified Service Agent (CSA). After 8000 hours, the UV Lamps will still work, but the performance of the UV Lamps, i.e. the amount of Ultraviolet light produced decreases dramatically. Refer to the appropriate Gaylord “UV” ventilator Technical Manual for instructions on replacing UV Lamps.

Checking the # of Hours on the UV Lamps:

To check the Number of Hours the UV Lamps have been in operation, press the “F5” (HRS) button. This will display the screen shown below and indicate the total number of hours the UV Lamps have been in use. To return to the main screen, press the “F5” (RTN) button.

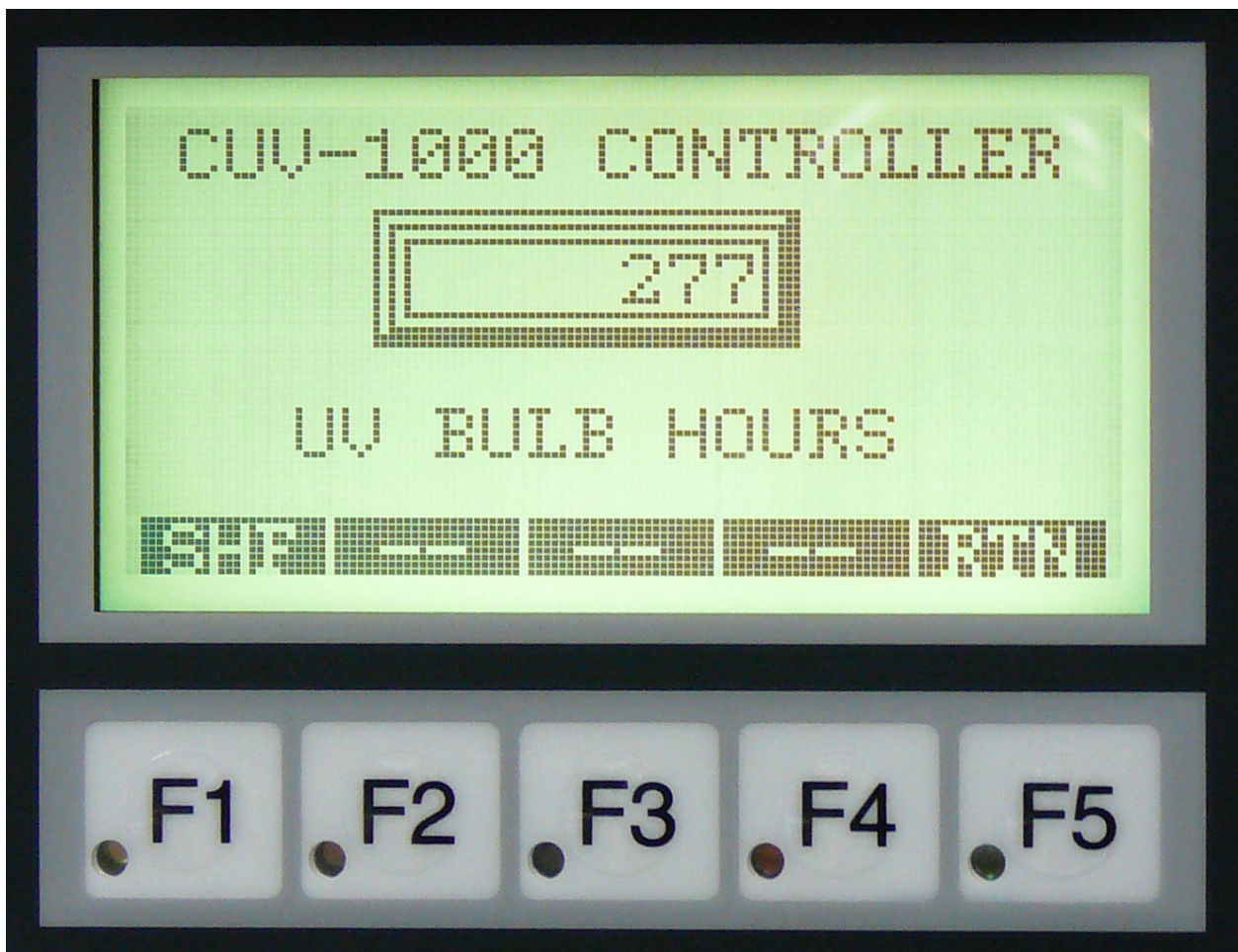

Resetting the UV Hour Meter:

After the UV Lamps have been replaced, the UV Hour Meter should be reset to Zero. To reset the UV Hour Meter, go to the “UV BULB HOURS screen”, shown above. Then press and hold the “F3” button for 5 seconds. This will reset the UV Hour Meter to Zero.

REMOTE MONITORING - OPTIONAL

Description:

The **CUV-1000** can have a Remote Monitoring “RM” installed as an option. The Remote Monitoring option is typically used to communicate with a Building Management System (BMS). The Remote Monitoring terminals will accept from 24V to 220V from a common power source.

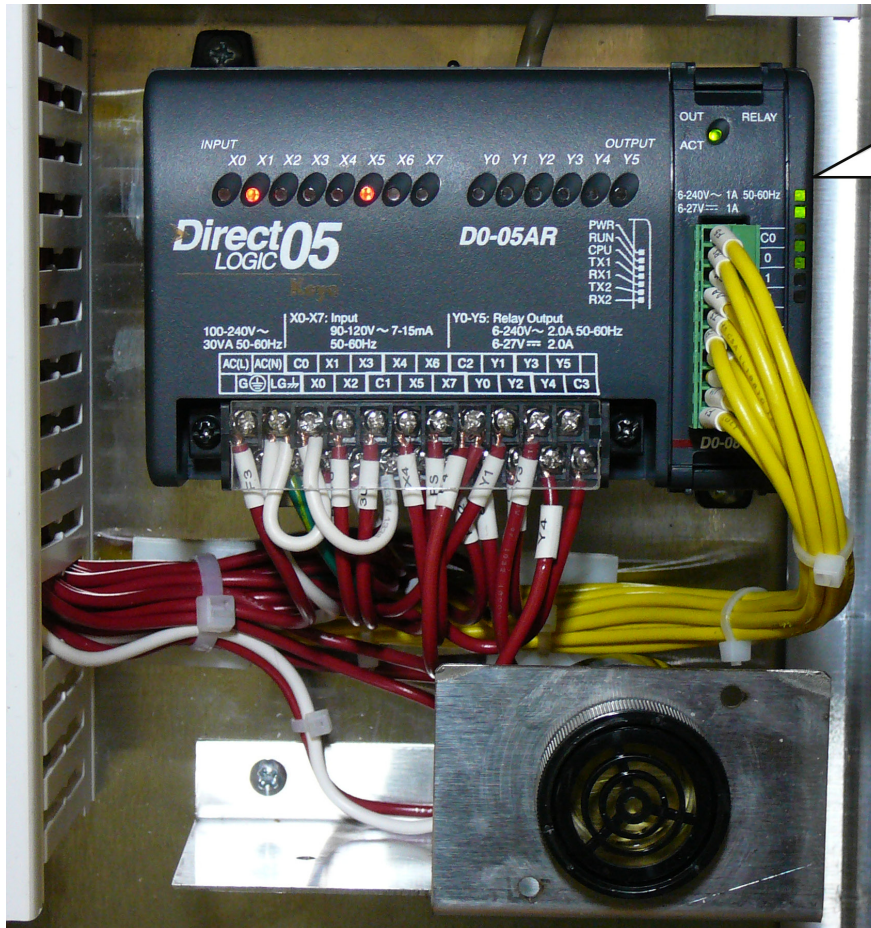

“RM” Option

Features:

A CUV-1000-RM includes Terminals and Normally Open Contacts that will close for the following:

- “RS” - Remote Start Active
- “FM” - External Fire Mode Active (Fire Protection System - Activated)
- “AA” - Autostart Active
- “TS” - Internal Fire Mode Active (Thermostat - Activated)
- “U3” - UV Safety Interlock Active
- “U2” - UV Lamp Failure
- “U1” - UV System On
- “F1” - Exhaust Fan On

*See CUV-1000 Internal Wiring and CUV-1000 Terminals for more details

CONTROL FUNCTION MATRIX

CUV-1000 Control Function Matrix				
Mode	Exhaust Fan	Supply Fan	UV Lights	Audible Alarm
Manual Fan On	ON	ON	ON	NO
Autostart Active	ON	ON	ON	NO
Remote Start Active	ON	ON	ON	NO
External Fire - FP System Activated	ON	OFF	OFF	NO
Internal Fire - Thermostat Activated	OFF	OFF	OFF	NO
“UV Safety Interlock” Activated	ON	ON	OFF	YES
“UV Lamp Failure” Activated	ON	ON	ON (some or none)	NO

Note:

When Autostart is Active (TST above 90°F) or the Remote Start is Active the Exhaust & Supply Fan(s) and UV Lamps will stay on until the Autostart is Not Active and the Remote Start is turned Off.

PLC STATUS LIGHTS

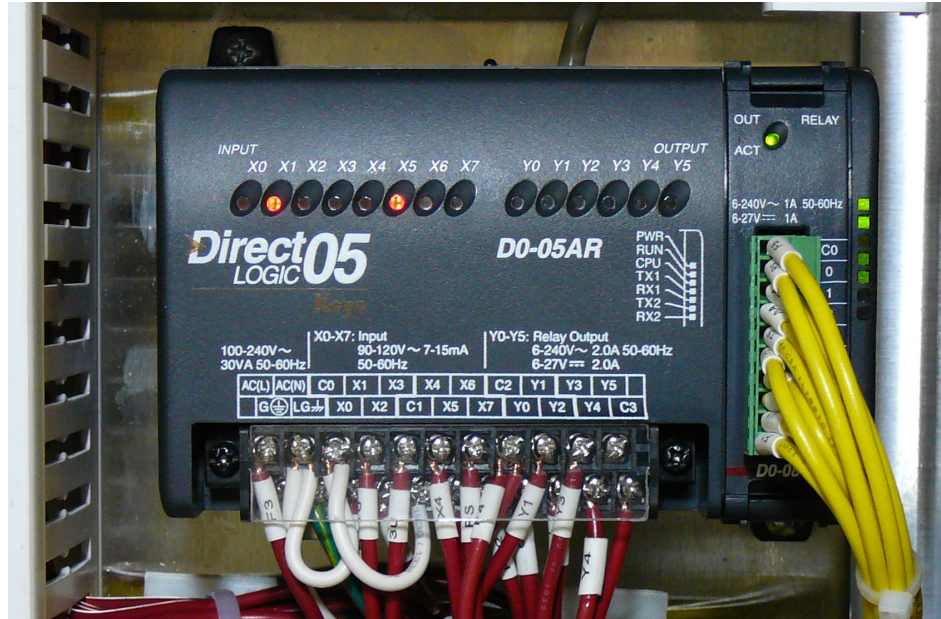

Inputs	Terminal	Description
X0	AS	ON when Autostart Thermostats (TST) are active
X1	1U	ON when “UV System On”
X2	2U	ON when “UV Lamp Failure”
X3	3U	ON when “UV Safety Interlock Active”
X4		Spare
X5	3	ON when N.C. Thermostats detect Fire (open)
X6	FS	ON when Remote Fire Switch is Activated (closed)
X7	RF1/RF2	ON when Remote “ON/OFF” Switch is closed

Outputs

Y0	8	ON when Exhaust Fan Motor Starter is On
Y1		ON when UV Safety Interlock Buzzer is On
Y2	1	ON when Supply Fan Motor Starter is On
Y3		ON when Internal or External Fire Mode are Active
Y4	6U	ON when UV Start Signal is On
Y5		Spare

Remote Monitoring - “RM”

Outputs

0	RS	ON when Remote Start Active
1	FM	ON when External Fire Mode Active
2	AA	ON when Autostart Active
3	TS	ON when Internal Fire Mode Active
4	U3	ON when UV Safety Interlock Active
5	U2	ON when UV Lamp Failure Active
6	U1	ON when UV System On
7	F1	ON when Exhaust Fan Motor Starter is On

CUV-1000 PARTS LIST

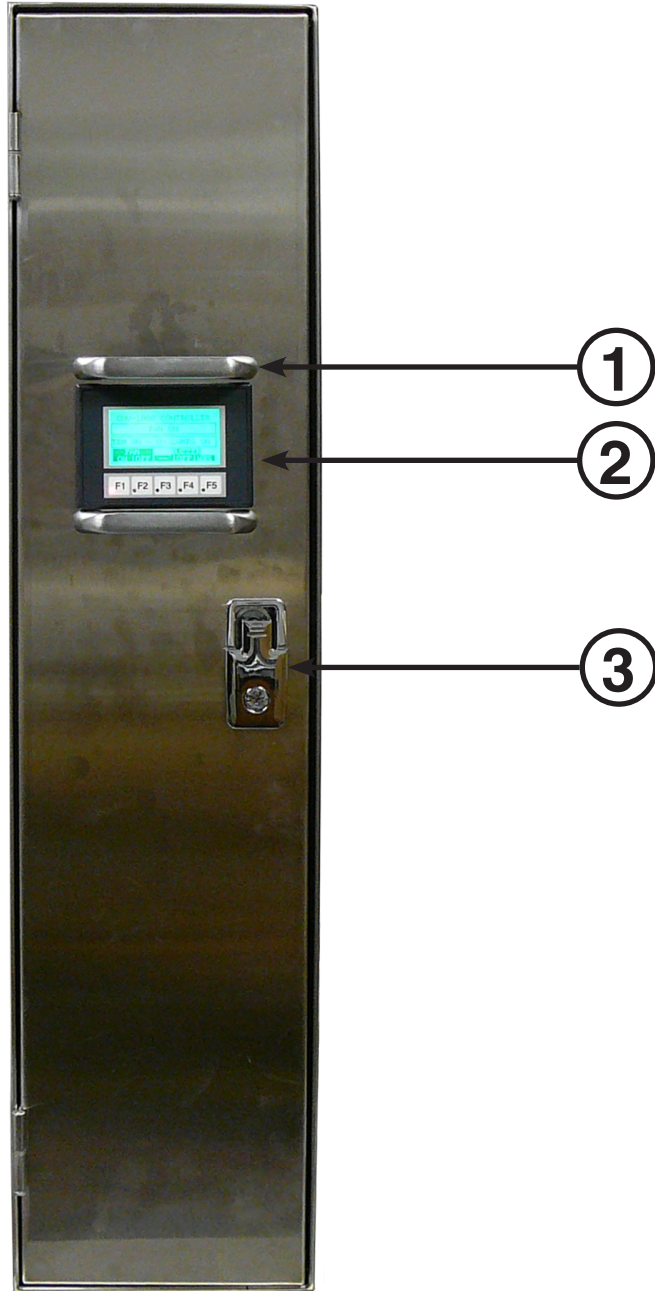

ITEM #	DESCRIPTION	GAYLORD PART #	MFR PART #
1	4" Pull Handle for GX Insert	10307	
2	CUV-1000 HMI - Operator Interface	20109	
3	Lift & Turn Compression Latch	11119	

CUV-1000 PARTS LIST

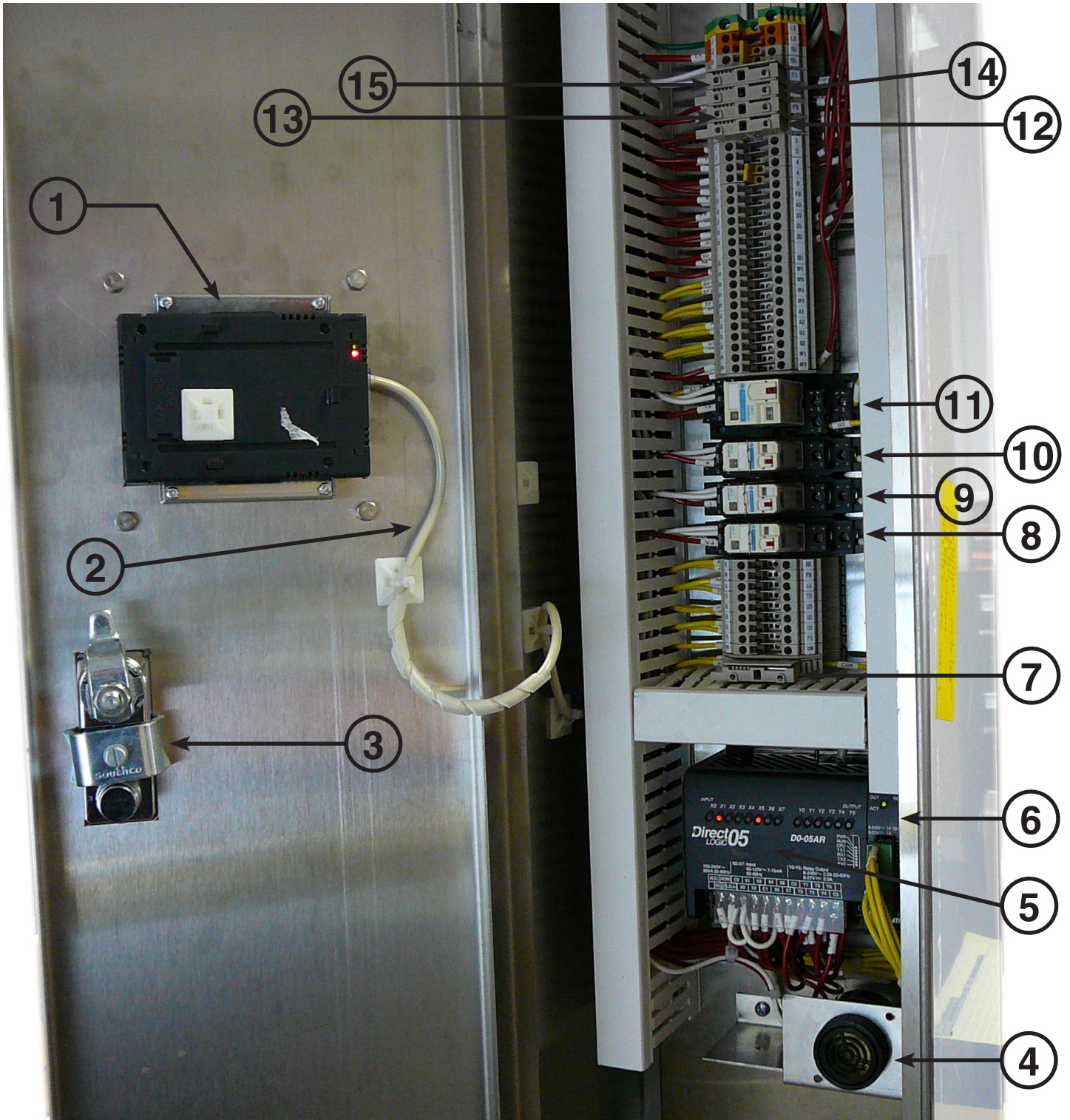

CUV-1000 PARTS LIST

ITEM #	DESCRIPTION	GAYLORD PART #	MFR PART #
1	CUV-1000 HMI - Operator Interface	20109	
2	HMI Cable	20107	
3	Lift & Turn Compression Latch	11119	
4	Sonalert Alarm	19319	
5	CUV-1000 PLC	20108	
6	CUV-1000 "RM" Module [Optional]	20113	
7	Fuse (F5) - 4 Amp Remote Outputs [Optional]	16822	BUSS GDB 4A
8	SPDT Control Relay [CR9] - UV Start Signal	30827	
	SPDT Socket	30836	
9	SPDT Control Relay [CR8] - Fire Modes	30827	
	SPDT Socket	30836	
10	SPDT Control Relay [CR7] -	30827	
	SPDT Socket	30836	
11	DPDT Control Relay [CR6] -	30828	
	DPDT Socket	30837	
12	Fuse (F4) - 4 Amp PLC Outputs	16822	BUSS GDB 4A
13	Fuse (F3) - 0.5 Amp PLC Power	18153	BUSS GMA500MA
14	Fuse (F2) - 6.3 Amp UV Power Output	17061	BUSS GDB 6.3A
15	Fuse (F1) - 6.3 Amp Main	17061	BUSS GDB 6.3A

WIRING DIAGRAM - INTERNAL

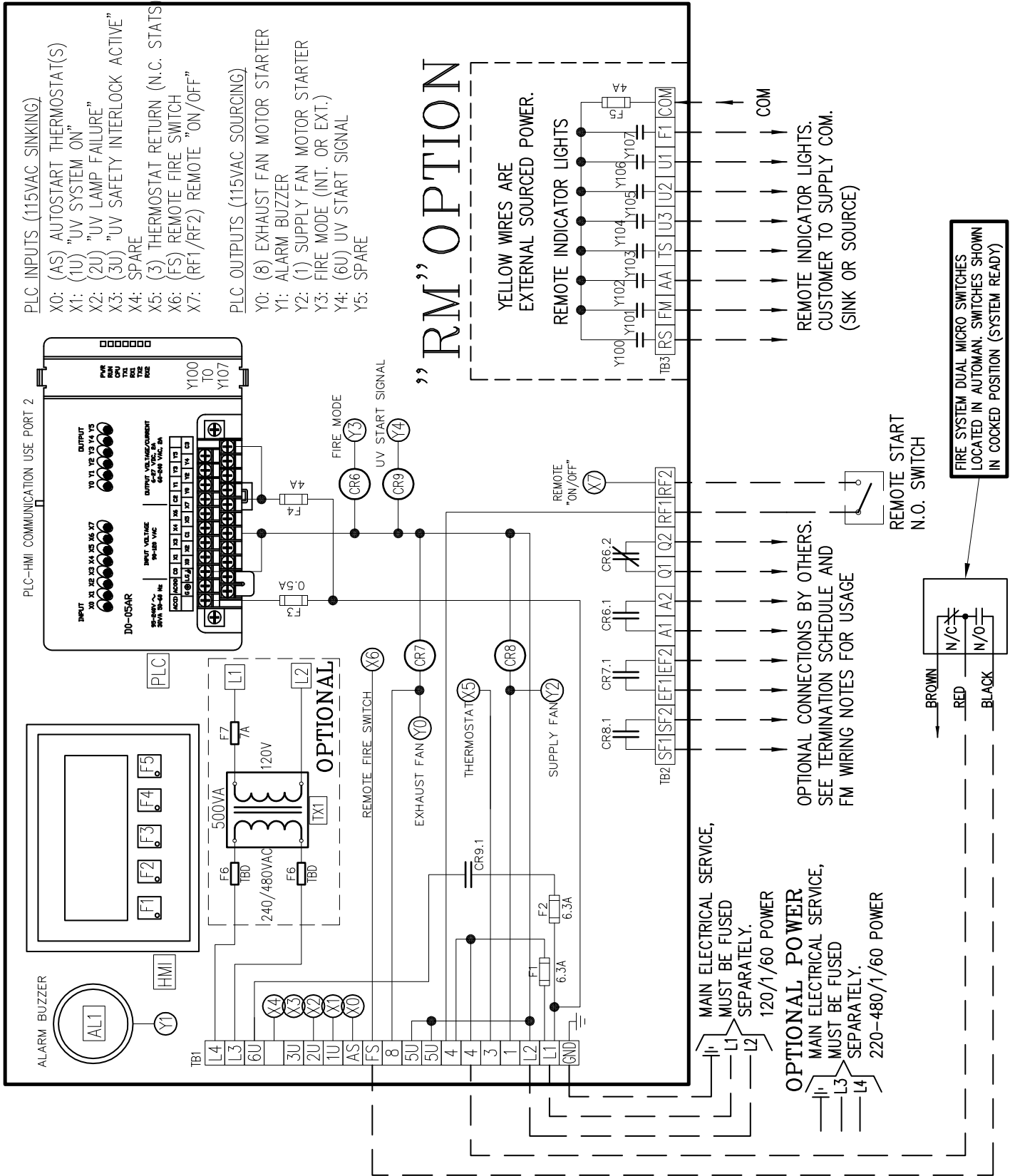

CUV-1000 TERMINAL VOLTAGES

Terminal	Description	Fan Off	Fan On	Int. Fire	Ext. Fire
L1	Main Power Connection : Hot	120 VAC	120 VAC	120 VAC	120 VAC
L2	Main Power Connection : Neutral	Common			
1	Output - Supply Fan Motor Starter	0 VAC	120 VAC	0 VAC	0 VAC
3	Input - Thermostat Return (N.C. Stats)	120 VAC	120 VAC	0 VAC	120 VAC
4	Fused Supply to Fire Switch, etc.	120 VAC	120 VAC	120 VAC	120 VAC
5U	120vac Neutral Leg	Common			
8	Output - Exhaust Fan Motor Starter	0 VAC	120 VAC	0 VAC	120 VAC
FS	Input - Remote Fire Switch (N.O. Sw.)	0 VAC	0 VAC	0 VAC	120 VAC
AS	Input - Autostart Thermostat(s)	120 VAC when Autostart thermostats above temperature setpoint			
1U	Input - "UV System On"	120 VAC when UV System is On and: 1. System Operating Normally <u>or</u> 2. UV Lamps Operating, but one or more of the UV Lamps or Ballasts has Failed in UV Module			
2U	Input - "UV Lamp Failure"	120 VAC when one or more of the UV Lamps or Ballasts has Failed in UV Module			
3U	Input - "UV Safety Interlock Active"	120 VAC when <u>any</u> UV Safety Interlock is Activated			
6U	Output - UV Control Power	0 VAC	120 VAC	0 VAC	0 VAC
SF1	N.O. Dry Contacts for Supply Fan Remote Control	Open	Closed	Open	Open
SF2					
EF1	N.O. Dry Contacts for Exhaust Fan Remote Control	Open	Closed	Open	Closed
EF2					
A1	N.O. Dry Contacts for Interface to Building Fire Alarm / Monitor System	Open	Open	Closed	Closed
A2					
Q1	N.C. Dry Contacts for Interface to Building Fire Alarm / Monitor System	Closed	Closed	Open	Open
Q2					
RF1	Remote On/Off Switch Terminals	120 VAC	120 VAC	120 VAC	120 VAC
RF2	Wired to N.O. Switch	120 VAC when Remote N.O. On/Off Switch is closed			

OPTIONAL "RM" TERMINALS

RS	Remote Start Active	BMS voltage when Remote N.O. On/Off Switch is closed ("ON")			
FM	External Fire Mode Active	0	0	0	BMS VOLTAGE
AA	Autstart Mode Active	BMS voltage when Autostart thermostats above temperature setpoint			
TS	Internal Fire Mode Active (Thermostat)	0	0	BMS VOLTAGE	0
U3	"UV Safety Interlock"	BMS voltage when <u>any</u> UV Safety Interlock is Activated			
U2	"UV Lamp Failure"	BMS voltage when one or more of the UV Lamps or Ballasts has Failed in UV Module			
U1	"UV System On"	BMS voltage when UV System is On and: 1. System Operating Normally <u>or</u> 2. UV Lamps Operating, but one or more of the UV Lamps or Ballasts has Failed in UV Module			
F1	Output - Exhaust Fan Motor Starter	0	BMS VOLTAGE	0	BMS VOLTAGE
COM	Output - Exhaust Fan Motor Starter	BMS Voltage (0-220VAC)			

WIRING DIAGRAM - EXTERNAL

CUV-1000

GAYLORD UV CONTROL

-- SUPPLY VOLTAGE --
120 VAC, 60 Hz.
13 AMPS MAXIMUM - CONNECTED LOAD

TRM	TERMINATION SCHEDULE	TYPE	RATING
L1	MAIN POWER CONNECTION : HOT	120VAC	
L2	MAIN POWER CONNECTION : NEUTRAL	0 V	
1	OUTPUT - SUPPLY FAN STARTER	120VAC	2 AMP
3	INPUT - THERMOSTAT RETURN (N.C. STATS)	120VAC	
4	FUSED SUPPLY TO FIRE SWITCH, ETC.	120VAC	
5U	120VAC NEUTRAL LEG	0 V	
8	OUTPUT - EXHAUST FAN STARTER	120VAC	2 AMP
FS	INPUT - REMOTE FIRE SWITCH (N.O. SW.)	120VAC	
AS	INPUT - AUTOSTART THERMOSTAT(S)	120VAC	
1U	INPUT - "UV SYSTEM ON"	120VAC	
2U	INPUT - "UV LAMP FAILURE"	120VAC	
3U	INPUT - "UV SAFETY INTERLOCK ACTIVE"	120VAC	
6U	OUTPUT - UV CONTROL POWER	120VAC	
SF1	N.O. DRY CONTACTS FOR SUPPLY FAN	N/A	7.5 AMP
SF2	REMOTE CONTROL	N/A	7.5 AMP
EF1	N.O. DRY CONTACTS FOR EXHAUST FAN	N/A	7.5 AMP
EF2	REMOTE CONTROL	N/A	7.5 AMP
A1	N.O. DRY CONTACTS FOR INTERFACE TO	N/A	7.5 AMP
A2	BUILDING FIRE ALARM / MONITOR SYSTEM	N/A	7.5 AMP
Q1	N.C. DRY CONTACTS FOR INTERFACE TO	N/A	7.5 AMP
Q2	BUILDING FIRE ALARM / MONITOR SYSTEM	N/A <td 7.5 AMP	
RF1	REMOTE ON/OFF SWITCH TERMINALS	120VAC	7.5 AMP
RF2	WIRED TO N.O. SWITCH	N/A	7.5 AMP

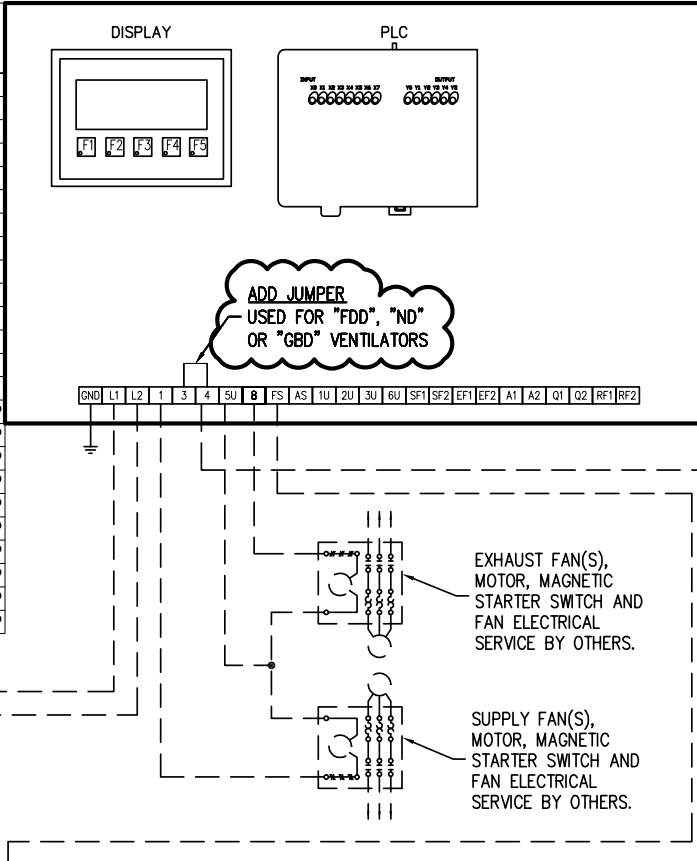

MAIN ELECTRICAL SERVICE FOR CUV-1000, MUST BE FUSED SEPARATELY.

WIRING NOTES

- E-1) ALL EXTERNAL CONTROL WIRING SHALL BE 12 GAUGE MINIMUM OR AS PER APPLICABLE CODES.
- E-2) THE HOLDING COILS WITHIN THE MAGNETIC STARTERS MUST MATCH THE SUPPLY VOLTAGE. MAGNETIC STARTERS ARE SUPPLIED BY OTHERS.
- E-3) VENTILATOR FAN CIRCUIT: THIS IS A SERIES CIRCUIT. CONNECT HOT FROM FAN SWITCH TO FIRST HOOD "IN". CONTINUE CONNECTING EACH HOOD "OUT" TO THE NEXT HOOD "IN", UNTIL LAST HOOD IS REACHED. CONNECT LAST HOOD "OUT" TO FAN MAGNETIC STARTER(S)

GAYLORD AUTOSTART THERMOSTAT "TST" NOTES

- A) INSTALLED IN HOOD
- B) PRESET TO 90°F AT FACTORY
- C) IN SOME CLIMATES AND/OR CONDITIONS, IT MAY BE NECESSARY TO ADJUST THE "TST" TEMPERATURE SETTING IN THE FIELD BY OTHERS

--- FIELD WIRING BY OTHERS
— WIRING BY GAYLORD

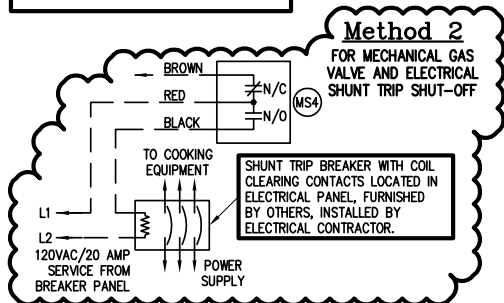

TYPICAL FIRE SYSTEM WIRING DIAGRAM (ANSUL SHOWN)

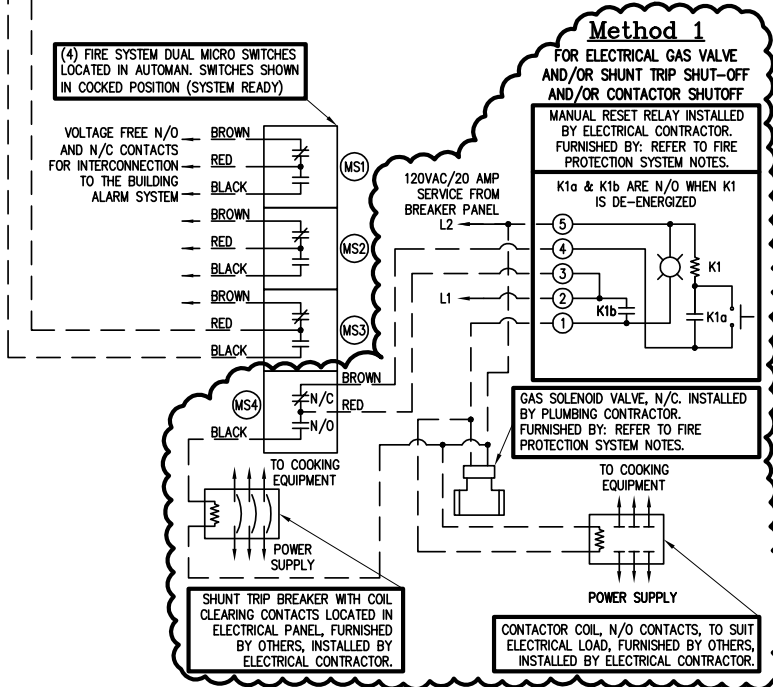

WIRING DIAGRAM FOR GAYLORD "UV" VENTILATORS WITH "ND", "FDD", OR "GBD"

1st Hood
1st Section

Add'l
Section(s)

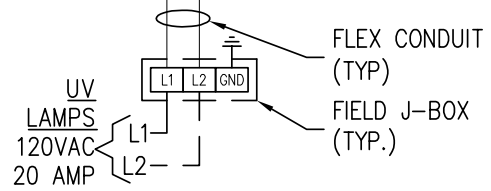
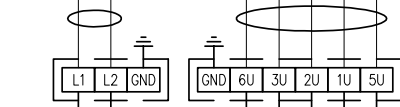
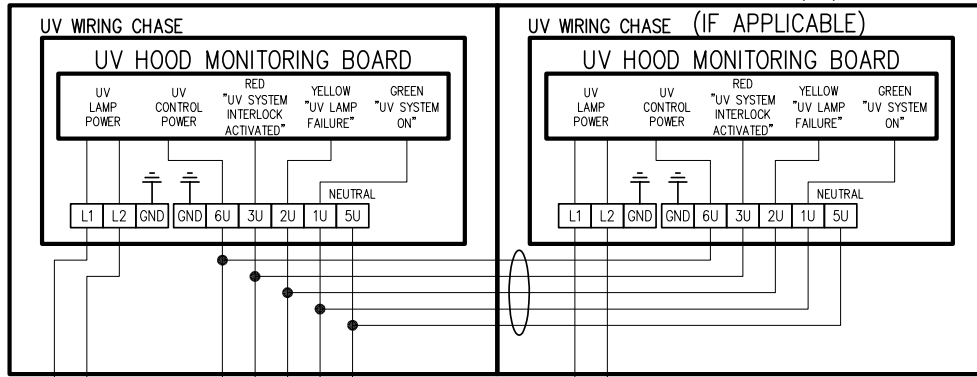

UV LAMP CIRCUIT:
120VAC, 60HZ, 20 AMP
EACH SECTION
REQUIRES A
SEPARATE 20 AMP
CIRCUIT

REFER TO
CUV-1000
WIRING
DIAGRAM
FOR DETAILS

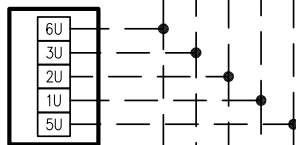

Add'l
Hood(s)

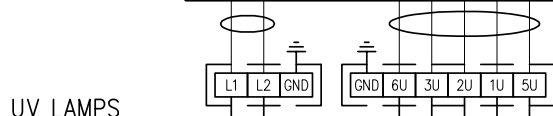
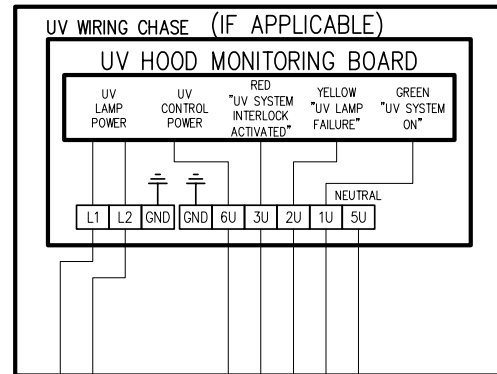

WIRING DIAGRAM FOR GAYLORD "UV" VENTILATORS WITH "ND", "FDD", OR "GBD" WITH AUTOSTART

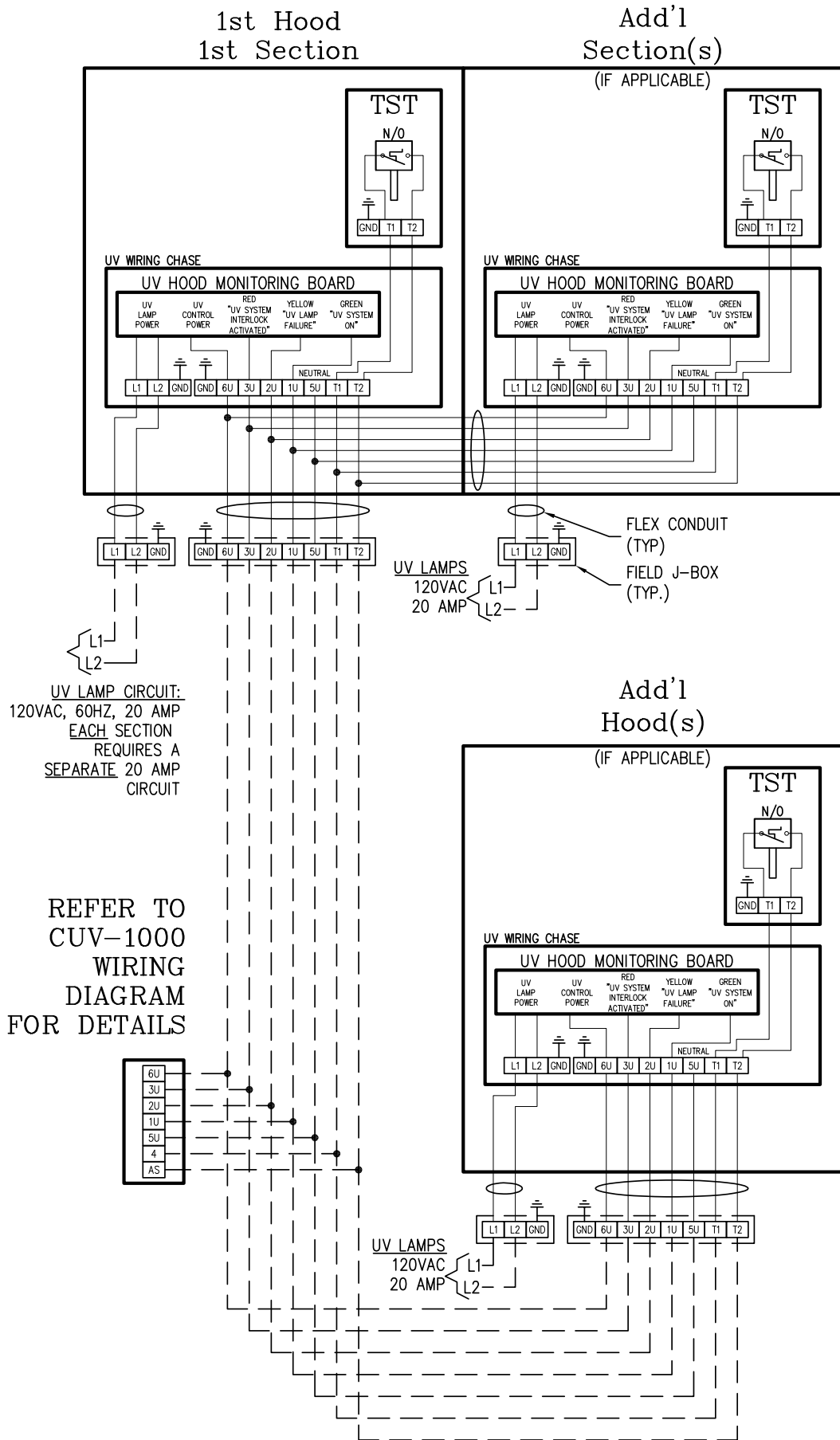

WIRING DIAGRAM FOR GAYLORD "UV" VENTILATORS WITH "GFBD"

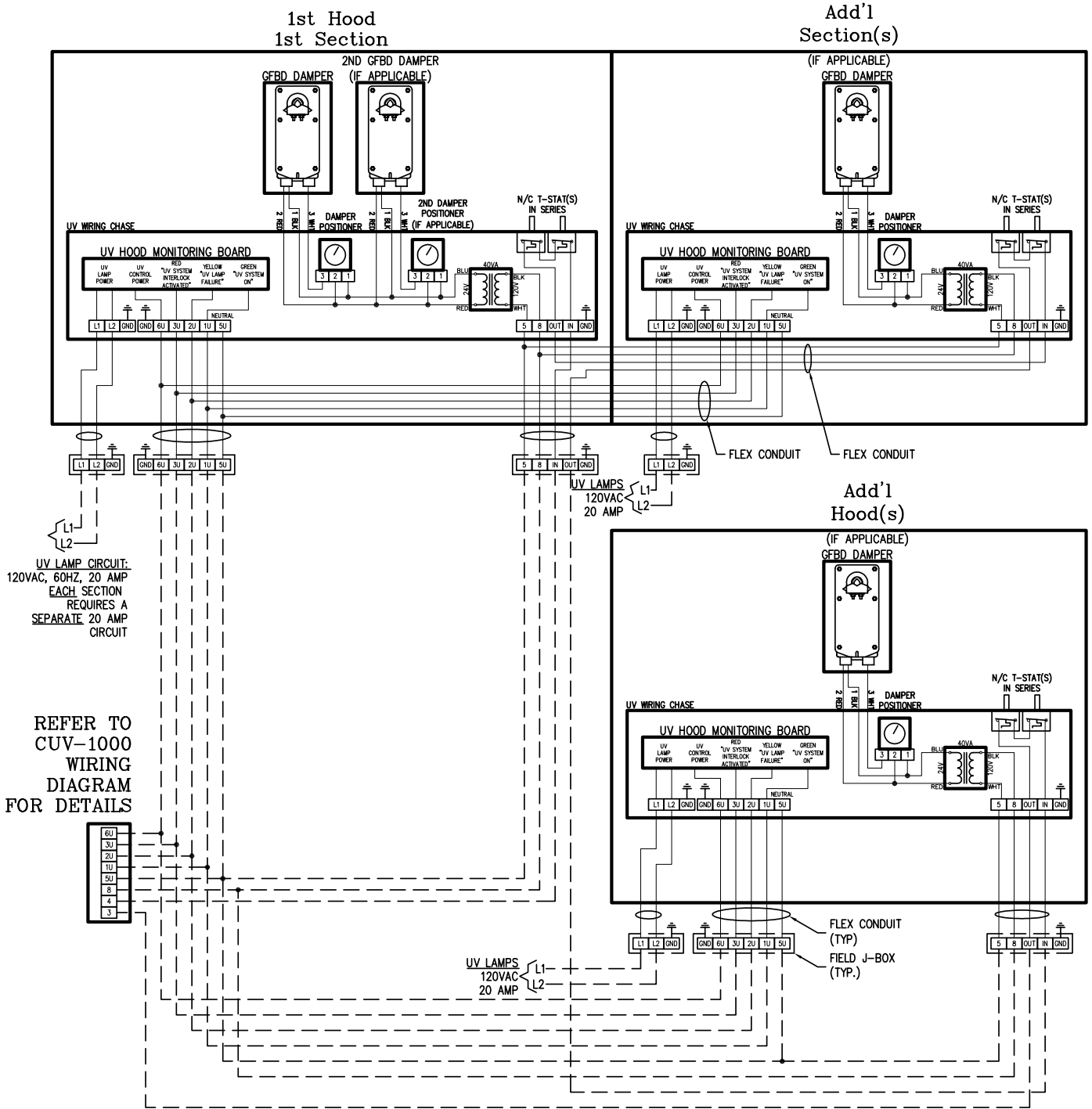

**THE GAYLORD CUV-1000 CONTROL CABINET
LIMITED WARRANTY**

December 2009

The Gaylord CUV-1000 Control Cabinet and component parts furnished with The Gaylord CUV-1000 Control Cabinet by the Licensed Gaylord Manufacturer are warranted by the Licensed Gaylord Manufacturer producing the ventilator to be free from defects of material and workmanship under normal use when installed, operated and serviced in accordance with factory recommendations.

The Licensed Gaylord Manufacturer's obligation under this warranty and any warranties implied by law shall be limited to repairing or replacing at its option any part of said equipment when the Licensed Gaylord Manufacturer's examination shall disclose to its satisfaction to be thus defective, for a period of one (1) year from the date of beneficial use, or eighteen months from date of shipment, whichever occurs first, provided proper and acceptable evidence of such is recorded at the factory. THE LICENSED GAYLORD MANUFACTURER SHALL NOT BE RESPONSIBLE FOR INCIDENTAL OR CONSEQUENTIAL DAMAGES RESULTING FROM A BREACH OF THIS WARRANTY.

In the United States the labor required to make repairs and replacements under this warranty shall be furnished by Gaylord Industries or the Licensed Gaylord Manufacturer or its authorized representative. Such labor shall only be provided Mondays through Fridays between the hours of 8 a.m. and 4 p.m. Requests for repairs or replacement parts should be made to GAYLORD INDUSTRIES, 10900 SW Avery Street, Tualatin, Oregon 97062 • 503-691-2010 • www.gaylordusa.com

Outside the United States, all replacement parts furnished under this warranty shall be F.O.B. Gaylord Industries, Tualatin, Oregon U.S.A. The owner shall pay the necessary freight delivery charges, and the necessary labor for removal and installation of parts, and any tariffs, duties or taxes.

This warranty does not cover fuses, routine maintenance, malfunctions or improper operation caused by fluctuating electrical power or power surges, or improper exhaust fan operation.

This is the sole warranty with respect to the aforesaid items. NEITHER THE GAYLORD LICENSEE NOR ANY OTHER PARTY MAKES ANY OTHER WARRANTY OF ANY KIND WHATSOEVER, EXPRESSED OR IMPLIED, AND ALL IMPLIED WARRANTIES OF MERCHANTABILITY AND FITNESS FOR A PARTICULAR PURPOSE WHICH EXCEED THE AFORESAID OBLIGATIONS ARE HEREBY DISCLAIMED AND EXCLUDED FROM THIS AGREEMENT.

SERVICE AND WARRANTY POLICIES

1. NO WARRANTY WORK SHALL BE PERFORMED ON THE PRODUCT WITHOUT A PO FROM GAYLORD INDUSTRIES, IF FINANCIAL REIMBURSEMENT TO BE REQUESTED.
2. NO WARRANTY SHALL BE PROVIDED ON EQUIPMENT THAT HAS BEEN STARTED UP AND IN OPERATION FOR MORE THAN 90 DAYS UNLESS, A PRODUCT MAINTENANCE SCHEDULE HAS BEEN CREATED AND PERFORMED PER THE REQUIREMENTS OF APPLICABLE TECHNICAL MANUALS.
3. ANY, AND ALL, WEARABLE PARTS ARE NOT TO BE CONSIDERED WARRANTY ITEMS, REGARDLESS OF INSTALLATION DATE, UNLESS PREVIOUSLY AUTHORIZED BY THE FACTORY.



**WORLDWIDE SALES, MANUFACTURING AND SERVICE
FOR THE NAME AND LOCATION OF THE NEAREST
CERTIFIED SERVICE AGENCY, VISIT OUR WEB SITE:**

WWW.GAYLORDUSA.COM

OR CONTACT US AT:

GAYLORD INDUSTRIES

10900 S.W. AVERY STREET
TUALATIN, OREGON 97062 U.S.A

Phone: 503-691-2010

1-800-547-9696

Fax: 503-692-6048

email: info@gaylordusa.com

LOCAL SERVICE AGENCY