

SERVICE MANUAL

TDR P^{eco}- ROTISSERIE OVEN MODELS TDW - WARMER MODELS

MODELS

TDR 5 P^{eco}
TDR 7 P^{eco}
TDW 5 P
TDW 7 P



Model TDR 5 P^{eco}



Model TDR 7 P^{eco}

- NOTICE -

This manual is prepared for the use of trained Service Technicians and should not be used by those not properly qualified. If you have attended training for this product, you may be qualified to perform all the procedures in this manual.

This manual is not intended to be all encompassing. If you have not attended training for this product, you should read, in its entirety, the repair procedure you wish to perform to determine if you have the necessary tools, instruments and skills required to perform the procedure. Procedures for which you do not have the necessary tools, instruments and skills should be performed by a trained technician.

Reproduction or other use of this Manual, without the express written consent of Fri-Jado, is prohibited.



USA

EMPTY PAGE

Versions		
Version	Issue date dd/mm/yy	Remarks
07/2012	01/07/2012	First release.
02/2013	01/02/2013	TDW 5 and 7 added. Small adjustments.
05/2013	01/05/2013	TDR 5 and TDW 5 deeper version added as standard. Small adjustments.
01/2014	01/01/2014	Small textual changes. Explode views and trouble shooting modified. Error 55 explanation added.
10/2014	01/10/2014	New bracket sensors, new errors, Name TDR 8 changed to TDR 7, various updates.

INDEX

Index	4
General technical data	6
Technical data	6
Programming instructions for the TDR 5 - 7 P and TDW 5 - 7	7
The automatic cook correction	25
Removal and replacement of parts for the TDR 5 and TDR 7	26
Right or left side panel.....	26
Top cover	26
Operating panel (general)	26
Electric panel.....	27
Replacing a lamp	27
Operating panel, glass + backplate + keypad.....	27
Power and I/O board	28
CPU board	28
Replacing of broken buzzer.....	29
Keypad.....	29
Contactor.....	30
Relay for thermistor function blower (from ser.nr. 100069000)	30
Door switch	30
High limit thermostat.....	31
PT 1000 sensor.....	31
Infra-red halogen lamp holder	32
Infra-red halogen lamp holder bottom rotisserie (stacked TDR 7).....	33
Blower motor	34
Blower motor bottom rotisserie (stacked TDR)	35
Drive motor	36
Heating element.....	37
Door adjustment (left side)	37
Door inside.....	38
Door outside	38
Removal and replacement of parts for the TDW 5 and TDW 7	39
Blower motor	39
Thermometer	39
Thermostat.....	40
Main switch	40
Heating element.....	41
Halotherm lamp.....	41
Parameter listing TDR P	42
Introduction	42
Reaching the parameter menus.....	42
Manager menu - description of the submenus.....	44
Service menu - description of the submenus	45
Adapting parameters	47
Loading software.....	47
Read and store recipes in manager menu.....	48
Read and store recipes and parameters in service menu	49
Parameter List P	51

Electrical tests and service procedures.....	52
Heating element test.....	52
Contactor, drive motor and blower test.....	52
PT1000 sensor test	53
Error codes on display	53
Control location	54
General troubleshooting list.....	55
Troubleshooting for the TDR 5 and 7 P rotisseries	55
Troubleshooting for the TDW 5 and 7 P warmers	57
Error 55 explanation.....	58
Analytic troubleshooting list	59
Servicing and repairing the TDR 5 and 7 P rotisseries	59
Servicing and repairing the TDW 5 and 7 P warmers.....	63
Exploded views & partlists.....	66
TDR 5 P - sheet metal work	66
TDR 5 P - components.....	68
TDR 5 P - doors.....	70
TDR 7 P - sheet metal work	72
TDR 7 P - components.....	74
TDR 7 P - doors.....	76
TDW 5 P - sheet metal work.....	78
TDW 5 P - components	80
TDW 7 P - sheet metal work.....	82
TDW 7 P - components	84
Electrical diagrams	86
Circuit diagram TDR 5 and 7 P	86
Wiring diagram TDR 5 and 7 P.....	87
Circuit diagram TDR 5 and 7 P (till serial number 100069000)	88
Wiring diagram TDR 5 and 7 P (till serial number 100069000).....	89
Circuit diagram TDR 5 and 7 P (till serial number 100059841)	90
Wiring diagram TDR 5 and 7 P (till serial number 100059841)	91
Circuit diagram TDR 5 and 7 P (till serial number 100058736)	92
Wiring diagram TDR 5 and 7 P (till serial number 100058736).....	93
Circuit diagram TDW 5	94
Wiring diagram TDW 5.....	95
Circuit diagram TDW 7	96
Wiring diagram TDW 7.....	97





GENERAL TECHNICAL DATA

This manual covers the TDR P^{eco} series rotisserie ovens and the TDW series warmers. Ovens and warming cabinets come in two sizes. Ovens and cabinets will also be delivered in stacked versions.

- TDR 5 – Oven with 5 spits (15 to 20 chickens) or 5 baskets (15 chickens).
- TDR 7 – Oven with 8 spits (32 to 40 chickens) or 7 baskets (28 chickens).
- TDW 5 – Warming cabinet for 25 to 30 chickens.
- TDW 7 – Warming cabinet for 35 to 40 chickens.

All of the information, illustrations and specifications contained in this manual are based on the latest product information available at the time of printing.

TECHNICAL DATA

Type	TDR 5 P	TDW 5 P	TDR 7 P	TDW 7 P
Power (W)	6600	2800	10500	3500
Fuses needed with power connection 208 V, 3 ~ 60 Hz (3 phases without zero)	3x 20 A	–	3x 40 A	3x 20 A
Fuses needed with power connection 208 V, 1N ~50...60 Hz (1 phase with zero)	–	1x 15A	–	–
Standard plug from factory	NEMA 15-30P 	NEMA 6-15P 	NEMA 15-50P 	NEMA 15-20P 
Standard plug from factory single pole	–	–	–	–
Stacked cabinets: each cabinet comes with separate power cord!!				
Net weight (lbs)	287	220	408	331
Gross weight (lbs)	335	265	476	388
Height (inch)	35 3/4"	35 3/4"	41 3/4"	41 3/4"
Width (inch)	33"	33"	39 1/4"	39 1/4"
Depth (inch)	30 3/8"	30 3/8"	35"	35"

Tools

- Standard set of tools.
- Metric wrenches, sockets and hex socket key wrenches.
- Multi-meter and AC current clamp meter.
- Temperature tester.
- Insulation value tester (Megger).
- Field Service Grounding Kit.

PROGRAMMING INSTRUCTIONS FOR THE TDR 5 - 7 P AND TDW 5 - 7

OPERATING PANEL

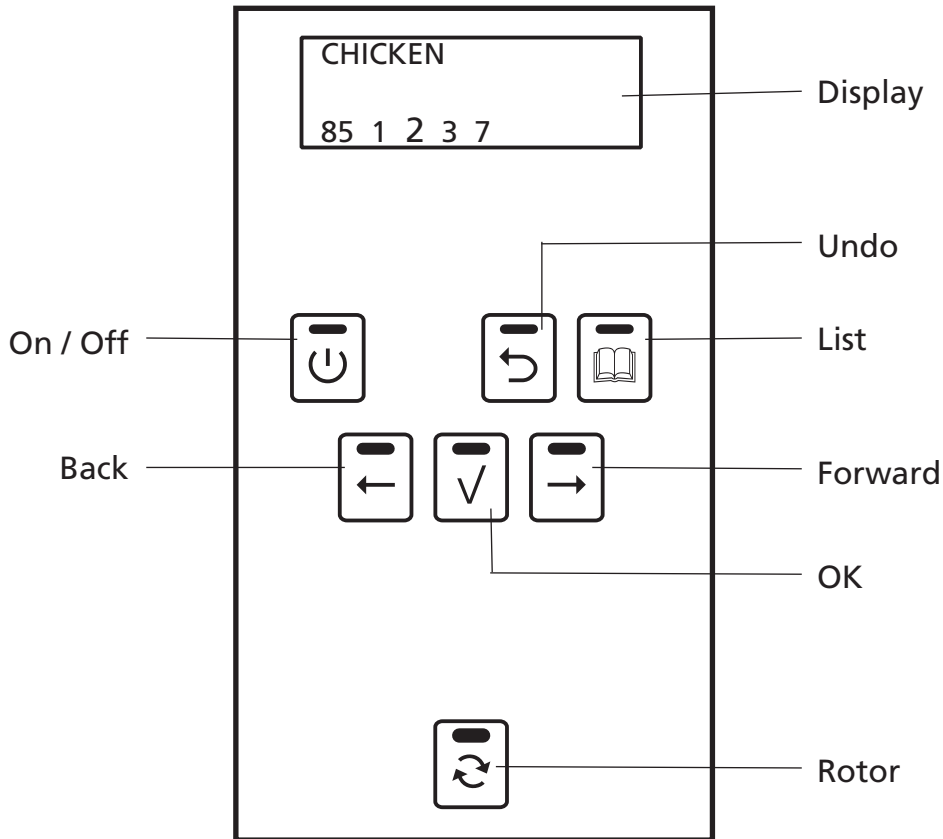

Key	Function
On / Off	Switching the unit On / Off
Undo	Go back to previous menu
List	Recipe / programming modus
Forward	One step ahead in setting
Rotor	Switching the rotor on
OK	Acknowledge a function or change
Back	One step back in setting

- 0 = Off
- 1 = 25°C / 77°F
- 2 = 40°C / 104°F
- 3 = 60°C / 140°F
- 4 = 80°C / 176°F
- 5 = 95°C / 203°F

OPERATING PANEL WARMER

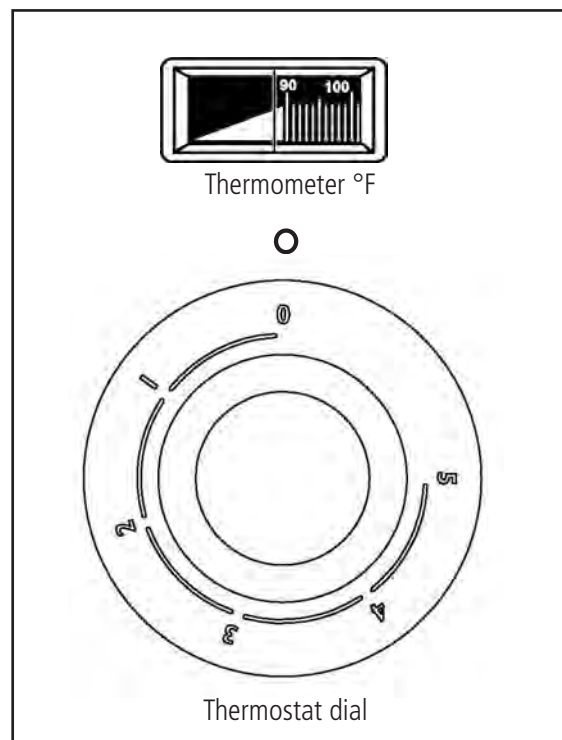

OPERATION

5. OPERATION



Buttons are lit when functional.

5.1. Operation of the rotisserie



1. Press Start.



2. Display shows Fri-Jado logo.

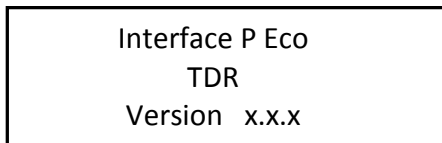

3. Display shows software version.

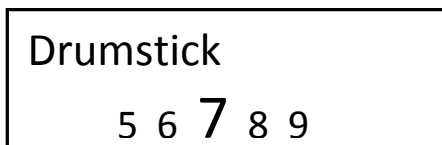

4. Display shows latest cooking program.

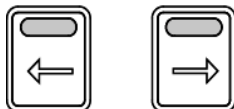

5. Use the arrow buttons for program selection.

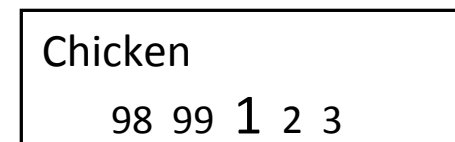

6. Display shows selected program.



7. Confirm the selected program.



8. Display shows pre-heat (only when pre-heat is defined).

LOAD
or START



Did you empty
The fat tray?



180°C 0:59



1 Chicken
230°C P123 0:60

1 Chicken
230°C P123 0:55



UNLOAD

9. Pre-heat ready
(unit returns a sound signal).
Note: press OK or open the door to stop the signal.

Display shows the next step of the program.

Note: Screen 9 and 11 alternate each 5 seconds.

10. When loading: press the rotor button to turn the rotor.

11. After loading, close the door.
A reminder to empty the fat tray appears.

12. Press OK to confirm.

13. Display show programmed temperature and time (hour : min).

14. (Optional) Press OK button for the actual temperature and time (shows about 2 seconds).

15. During the last minute the time blinks.

16. Display show the remaining time, the interval is 5 seconds.

17. Open the door.

Measure Core Temp.

2 Chicken
:00 Add time?

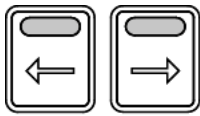

 UNLOAD



Chicken
98 99 1 2 3

18. A reminder to measure the core temperature appears.

Note: Screen 17 and 18 alternate every 5 seconds.

19. (Optional, visible for 5 min.) request for additional time (minutes) after opening the door.

Note: Add time is only available when activated in the service menu.

20. (Optional) press right arrow for one minute increase, press left arrow for one minute decrease. When activated program continues at step 13.

21. Program ready, open door.

22. Press the rotor button to rotate the rotor.

23. Close the door (if required clean the unit).

24. Display shows the last operated program.

OPERATION OPTIONS

5.2. Operation options

5.2.1. To end a running program.

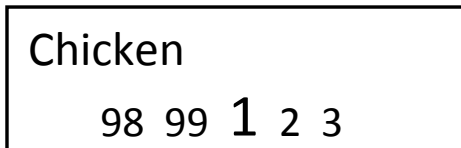
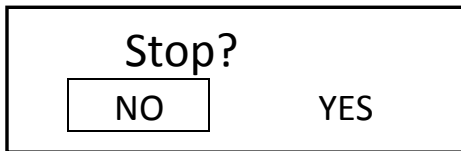

1. Press and hold start for 3 seconds.

2. Make a choice with the arrow buttons.

Note: Select NO to abort ending the program.

3. Confirm the selection.
(Within 5 seconds).

4. Display shows the last operated program.

5.2.2. Check the actual temperature

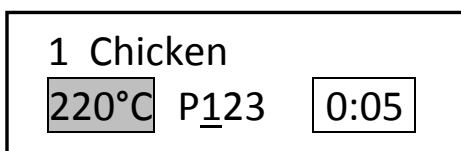
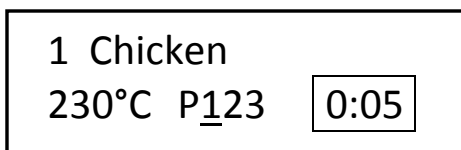

1. For example: Check the current temperature in program 1 Chicken, step 1.

2. Press the OK button.

3. The display shows during 3 seconds the actual temperature.

5.2.3. Check the remaining time in a program

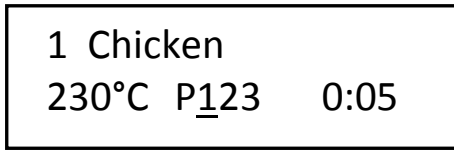

1. Use the arrow buttons to show the remaining time pro step.

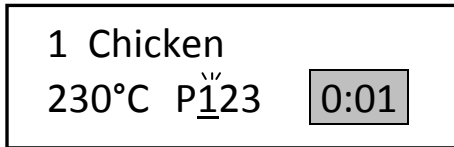

2. Time left at step 1 (first digit blinks).

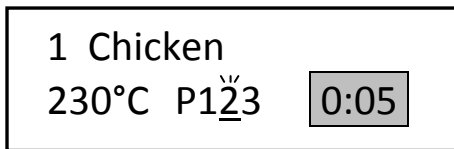

3. Time left at step 2 (second digit blinks).

5.2.4. Show all actual program information

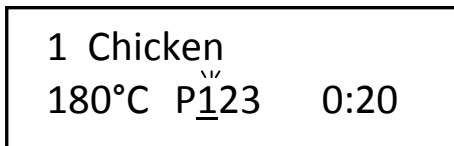

1. Display shows actual program. (step one is active).



2. Press List button.



3. Display shows the programmed temperature and time.

P	180		0:07	3	230	0:05	0:05
1	180	0:20	0:20	H	085	0:10	0:10
2	210	0:10	0:10	C	+ 00:00:00		

4. Press List button again for additional information.

5. Display shows the programmed steps and remaining times in one overview. (Step – temperature – program time – actual time)

P: Preheat
 1-3: Program step
 H: Holding
 C: Cook correction



1 Chicken		
180°C	P <u>1</u> 23	0:20

6. Press the OK button to update the screen
(automatically refreshed every 15 seconds).

7. Press List button to go back.

8. Display returns to the original operating display.

5.2.5. Eco function

1 Chicken	ECO	
180°C	P <u>1</u> 23	0:20

Optional: only available when activated in the service menu.

In the ECO mode the accumulated heat in the cavity will be used to cook the product.

Depending on the settings, the product and program an energy saving of 5% can be achieved.

5.2.6. Cook correction

180°C	0:20
--------------	------

Optional: only available when activated in the service menu.

Cook correction: Depending on the load of products the cooking time will be automatically adjusted.

The first cook is the reference cook and will be used to fix the correct parameters.

The activation of the cook correction is NOT visible in this display.

5.2.7. Display information

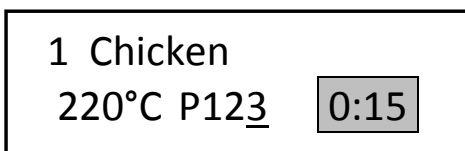
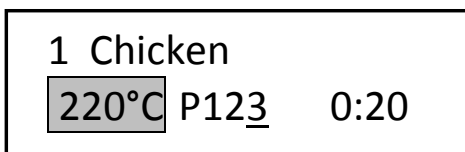
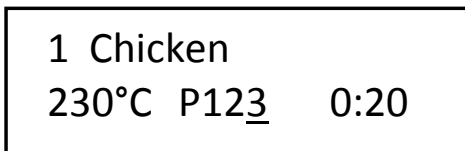
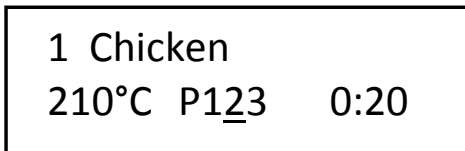
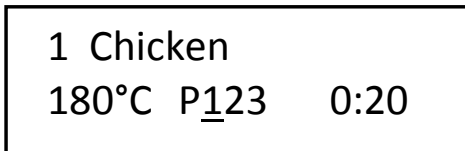
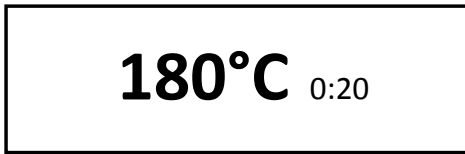

1. Display shows the programmed temperature and time.
2. Press the list button.
3. Display shows after 3 seconds cooking step + temperature + time.
Note: the current cooking step is underlined.
4. Use arrow button for next screen.
5. Cooking step 1 is finished, sound signal is returned.
Display shows next cooking step + temperature + time.
6. Cooking step 2 is finished, sound signal is returned.
Display shows next cooking step + temperature + time.
7. Display shows the actual temperature
Note: the actual temperature blinks.
8. Display shows the remaining time.
Note: the remaining time blinks, after 5 seconds the original display is shown again.

PROGRAMMING

6. MANAGER MENU

6.1. Manager menu items

Programming New Edit Delete Copy	Parameters Pre-Heat Preheat temperature Holding Holding temperature Cook correction* Eco function* Language Big digits Sound preheat Sound step Sound done	Change pin Clock Transfer Version USB Reading recipes Store recipes
---	--	--

* Only visible when selected in the service menu.

6.2. Programming the rotisserie

Possible programming steps:

- Preheat
- Step 1
- Step 2
- Step 3
- Holding



1. Start the unit.



2. Logo appears.

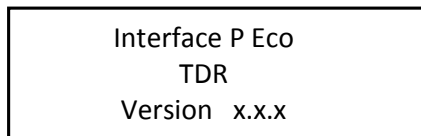

3. Unit information appears.

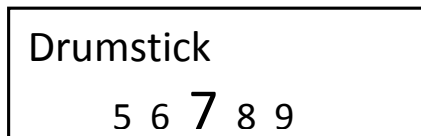

4. Last used program appears.



5. Press the list button.

Pin 0 - - -
Give User PIN code



Pin 1 - - -
Give User PIN code



Pin *0 - -
Give User PIN code

MANAGER MENU
USB Programming Para.



RECIPES
NEW EDIT



6. Enter the User PIN code.
Note: the original PIN code is 1111. The operator can change the User PIN code.

7. Use the arrow button to enter the PIN code.

8. Press the arrow right button to change the first digit.

9. Press the OK button to confirm.

10. The next digit is activated. Change as required using the arrow button. Confirm with the OK button. Repeat for the other digits.

11. Manager menu is activated. Use the arrow buttons to toggle between the sub menu's.

12. Select "Programming" and Press the OK button to confirm.

13. Use the arrow buttons to select a new or existing recipe.

14. Press the OK button to confirm.

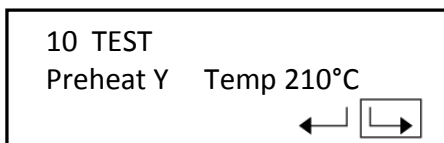
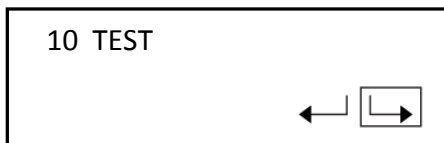
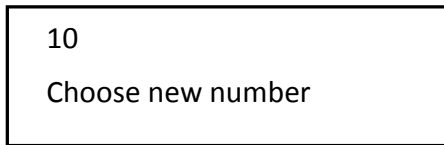

15. The first available number is shown.

Note: use the arrow right button to select the next available number.

16. Press the OK button to confirm.

17. Enter the recipe name.

Use the arrow button to change the character.

Note: ABC can be changed with the use of the list button into lower / higher case or special characters.

18. Press the OK button to confirm.

19. The new recipe name is shown

Note:
To change the name of the recipe use the back arrow button and press the OK button.

20. Press the OK button to confirm.

21. Set the preheat function and temperature (default set on 210 °C / 425°F). Press the left arrow button and the OK button to change the pre-heat setting.

Note: Pre-heat is only available when activated in the parameter list.

Preheat functions:
Y: Yes
N: No
C: Continuously



10 Step 1
Temp 1 - - °C

22. Press the OK button to confirm.

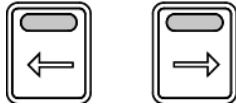

23. Set the "step 1" temperature.
Starting with the first digit.



24. Use the arrow buttons to
increase/decrease the value of the
selected digit.

10 Step 1
Temp 21 - °C

25. Press the OK button to confirm.



26. Set the second digit.

10 Step 1
Temp 215 °C

27. Press the OK button to confirm.



28. Set the third digit.

10 Step 1
Temp 215 °C Time 1 - -

29. Press the OK button to confirm.

30. Set the "step 1" time.
Starting with the first digit.

Note:
Enter the time in minutes.



31. Use the arrow buttons to
increase/decrease the value of the
selected digit.



10 Step 1
Temp 215 °C Time 21 -

32. Press the OK button to confirm.



10 Step 1
Temp 215 °C Time 210

33. Set the second digit.

34. Press the OK button to confirm.



10 Step 1
Temp 215 °C Time 210
← → ✓

35. Set the last digit.

36. Press the OK button to confirm.

37. The Step is now completed.

Select the right arrow and press the OK button to go to the next step.
Select the left arrow button and press the OK button to go back to the last setting.
Select the ✓ and press the OK button to finish programming.

10 Step 2
Temp 215 °C

38. Program the next step (when required). See step 1 for the procedure.

10 Holding
Temp 85 °C Time 999
← → ✓

39. After step 3 or when entering no time at step 2 (or 3) the holding step will appear. Set the temperature and time as required.

Note:

Set the time to 999 for continuous operating.

Only available when activated (refer to section 6.3).

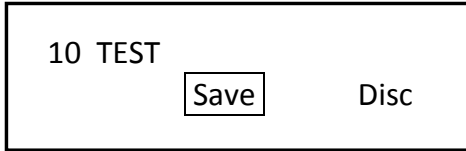

40. When ready programming press the OK button to confirm.

41. Save the finished programs.

Note: if the program is not saved all changes are lost!



42. Press the OK button to confirm.

43. The screen returns to the RECIPES menu.

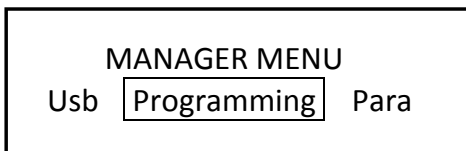

44. Press back to enter the manager menu.

45. Manager menu appears.

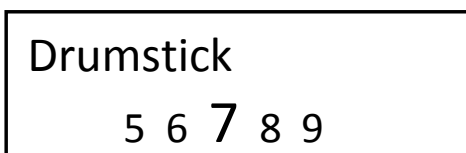

46. Press back to enter the user menu.

47. The last program used is shown.

MANAGER MENU: PARAMETERS

6.3. Programming parameters



Pin * * * *
Give User PIN code



MANAGER MENU
Edit. Parameters Pin.



Language: Dutch
Cha. NEXT PAR. Prev.

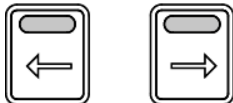

Language: Dutch
Change Next



1. Press the list button.
2. Enter your user PIN code.
3. Press the OK button to confirm.
4. Press the arrow buttons to select Parameters.
5. Press the OK button to confirm.
6. Press the arrow buttons to select Change or Previous.

Press the OK button to select the next parameter.
7. To change the language, select Change.
8. Press the OK button to change.

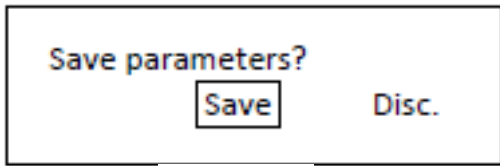
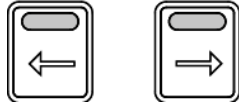
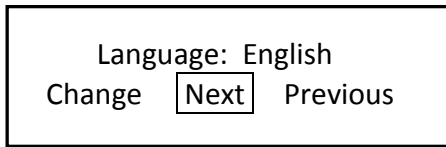

9. Use the arrow buttons to select Change, Next or Previous.

Press back to enter the manager menu.

10. Use the arrow buttons to select Save and press the OK button to confirm. This is valid for software version V1.04-09 or higher.

Note: when you select the Undo key the changes will not be saved and you go back to step 4.

10a. Untill software version V1.03.10 you had to press the undo key to go to save.



11. Use the arrow buttons to select the other settings:

Big Digits	YES/NO:	Default set at YES
Sound preheat	Sound T1-T3 Volume 1-4	Default set at T1 Default set at 2
Sound Step	Sound T1-T3 Volume 1-4	Default set at T2 Default set at 1
Sound Done	Sound T1-T3 Volume 1-4	Default set at T3 Default set at 3
Preheat	YES/NO:	Default set at NO
Preheat Temperature	50-250 °C (122-482 °F)	Default set at 210°C (410°F)
Holding	YES/NO:	Default set at YES
Holding Temperature	50-250 °C (122-482 °F)	Default set at 85°C (185°F)
Cook correction	YES/NO:	Default set at YES
Eco function	YES/NO:	Default set at YES



Press back to enter the manager menu.



Press (again) back to enter the user menu.

MANAGER MENU: CHANGE PINCODE

6.4. Change pin code

MANAGER MENU
Para Clock

1. Manager menu.
2. Select Change Pin.
3. Press the OK button.

Pin 0 0 0 0
Enter new code

4. Enter the new pin code.
5. Press the OK button.

6.5. Clock

MANAGER MENU
Pin Copy

1. Manager menu.
2. Select Clock.
3. Press the OK button.

2012 / 10 / 1 8:01 AM
 12..

4. Set the correct date and time.
5. Press the OK button.

6.6. Transfer

MANAGER MENU
Clock Vers.

1. Manager menu.
2. Select Transfer.
3. Press the OK button.

Insert stick and press
enter

4. Insert stick and press OK.

6.7. Version

Interface P Eco
TDR
Version x.x.x

1. Display shows software version.

OPTIONS MANAGER MENU: USB

6.8. USB

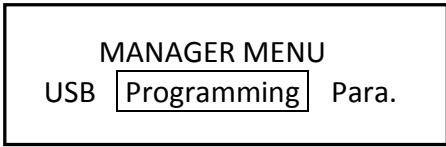

1. Manager menu.

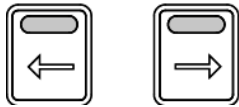

2. Use the arrow buttons to select the USB function.

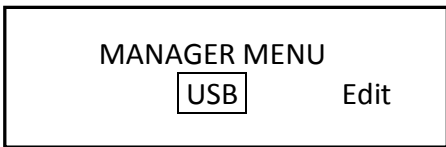

3. Screen shows the USB function. Place the USB stick into the USB-slot.



4. Press the OK button to confirm.

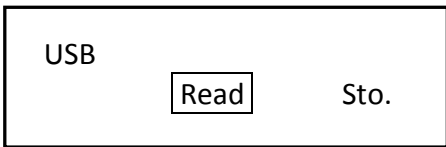

5. Use the arrow buttons to select Read to exchange an existing program or STORE to save a program.

Option STORE:

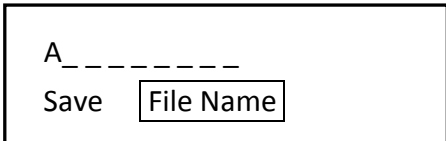

6. Enter the file name by using the arrow buttons and OK button.

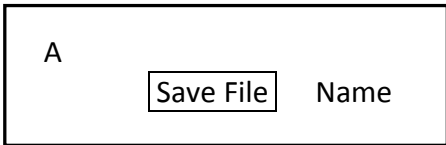

7. Select Save.



8. Press the OK button to confirm.

Note: When reading new programs all existing programs will be deleted.

THE AUTOMATIC COOK CORRECTION

The automatic cook correction facility will automatically add or deduct time to the programmed cooking time in order to have constant cooking quality.

After programming a new program, the first cooking process will be the "learning" process. It is recommended to do the first cook with a half load.

The program calculates the surface from the diagram below the curved line. (temperature * time). The result is the so called heat number. This heat number is stored into the cooking program.

All further cooking programs will try to get the same heat number.

The second diagram shows an example with full load. It takes more time for the unit to reach the programmed cooking temperature. See dashed line. The surface above the dashed line represents the missing part of the heat number. The cook correction will put this missing part behind the normal cooking time. Therefore extra time is added in order to reach the desired heat number. It is also possible that time is deducted in case a smaller load has been put into the oven.

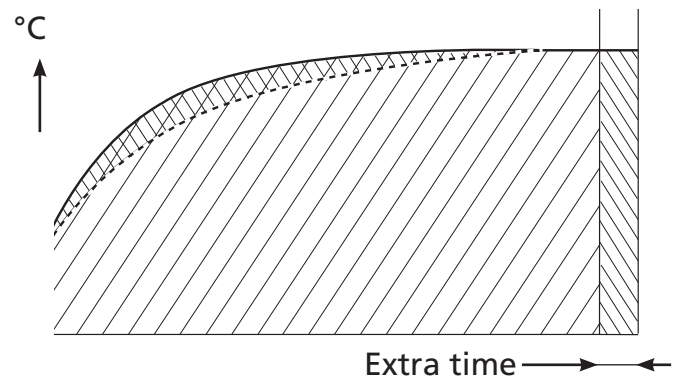
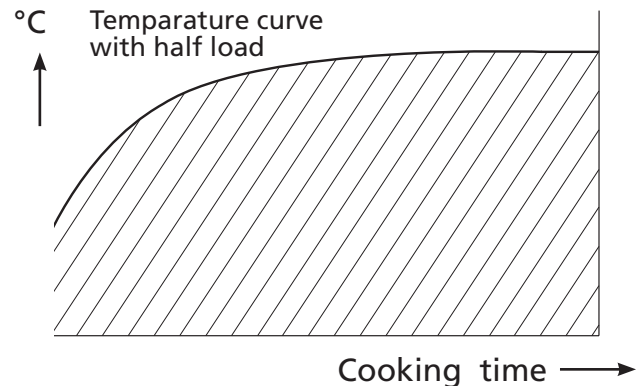

Time will be added in case of:

- A bigger load.
- A colder load. (straight from the freezer)
- A lower mains voltage.
- Somebody opened the door.

Time will be deducted in case of:

- A smaller load.
- A warmer load. (defrosted)
- A higher mains voltage.

Note 1:

In case the time or temperature will be changed in the cooking program, the heat number will be adapted with this amount.

Note 2: Only if you delete a program or change the name the "learning" process starts again from the beginning.

The heat number is stored in the cooking program. In case such a program is copied and stored in another rotisserie, the heat number goes with it. It is possible that in case the program has changed a lot, the cook correction is not able to perform well anymore. In that case the program has to be deleted and reprogrammed with the good parameters. It is possible to disable this cook correction feature in the service parameters. See "parameter listings" -> "cook correction".

REMOVAL AND REPLACEMENT OF PARTS FOR THE TDR 5 AND TDR 7

WARNING: Disconnect the electrical power to the machine at the main circuit box. Place a tag on the circuit box indicating the circuit is being serviced.

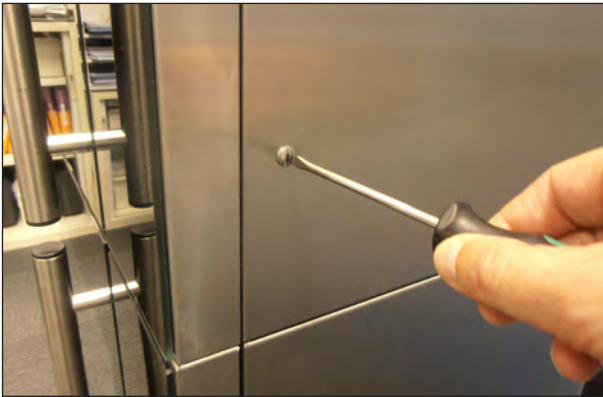
RIGHT OR LEFT SIDE PANEL

1. Remove the crosshead screws that secure the panel to the frame.
2. Remove the panel.
3. Reverse the procedure to install.

TOP COVER

1. Remove the right side panel according prior procedure.
2. Remove the screws securing both large and small top covers.
3. Remove the top cover. (Lift at right side and remove to the left).
4. Reverse the procedure to install.

OPERATING PANEL (GENERAL)



1. Remove the right side panel according prior procedures
2. Remove the bolt, nut and ring on the top side on the backside of the operating panel.
3. Pull the panel away from the top side.
4. Remove the flatcables and ground cable from the CPU board on the backside.
5. Remove the panel.
6. Reverse the procedure to install.

ELECTRIC PANEL

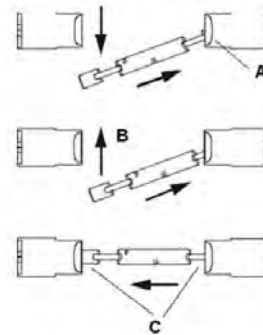

1. Remove the right side panel according prior procedure.
2. Disconnect all external wiring of the panel.
3. Remove on the inside bottom of the electric panel the bolt and nuts.
4. Slide the electric panel upwards to remove this.
5. Reverse the procedure to install.

REPLACING A LAMP



OPERATING PANEL, GLASS + BACKPLATE + KEYPAD



1. Remove the right hand panel according prior procedure.
2. Remove the operating panel according prior procedure.
3. Remove the 4 nuts and rings on the CPU board and remove the board.
4. Replace the USB connection from old to new operation panel.
5. Reverse the procedure to install.

Note 1: For connection flatcable of the keypads see CPU board on page 28.

Note 2: For older units with earth wire in right hand bottom corner. Take care that the ring terminal doesn't make contact with with the solder point (see arrow). Otherwise the illumination of the display and keys can be out.

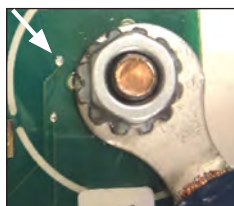
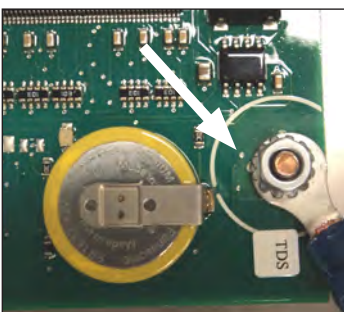

POWER AND I/O BOARD



1. Remove the right side panel according prior procedure.
2. Disconnect the wiring and flatcable on the board.
3. Remove the board from the clips by pressing the clips together.
4. Reverse the procedure to install.

CPU BOARD



Before changing the CPU board and display be sure to download (with a USB stick) or write down the cooking programs and the parameters.

1. Remove the right side panel according prior procedure.
2. Remove the operating panel according prior procedure.
3. Remove the 4 nuts and rings on the CPU board and remove the board.
4. Reverse the procedure to install.
5. Read the cooking programs and parameters from the USB stick to the CPU board.

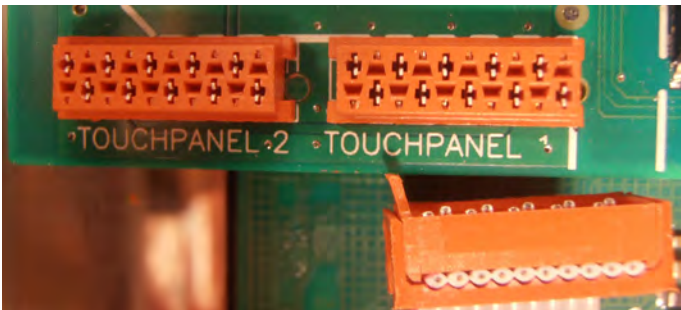

Note 1: Flatcable keypad must be connected to connector "Touchpanel 1" on CPU board.

Note 2: "Touchpanel 2" is flatcable connection for the rotor switch keypad on customer side.

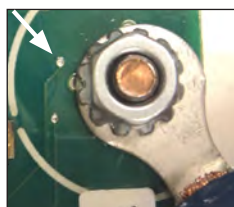
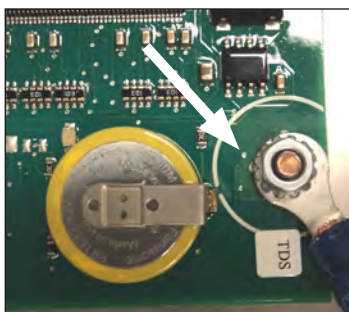

Note 3: For older units with earth wire in right hand bottom corner. Take care that the ring terminal doesn't make contact with with the solder point (see arrow) .Otherwise the illumination of the display and keys can be out.

REPLACING OF BROKEN BUZZER

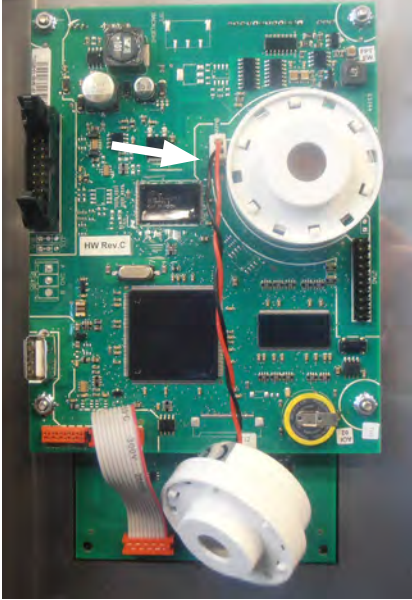

1. Remove the right side panel according prior procedure.
2. Remove the operating panel according prior procedure.
3. Stick connector of new buzzer in plug next to the existing broken buzzer (see white arrow).
4. Reverse the procedure to install.

Note: *buzzer can dangle loosely without any problem.*

KEYPAD

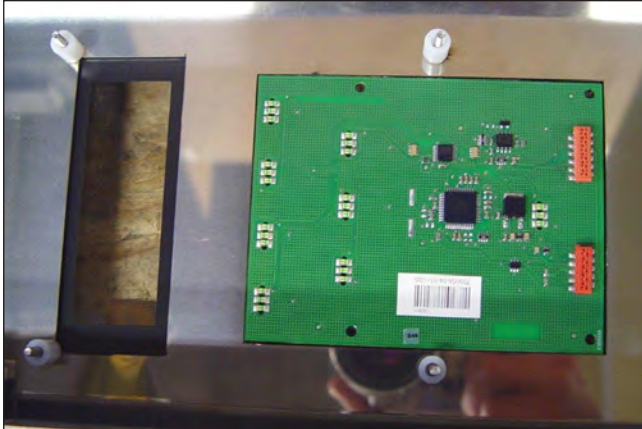

1. Remove the right side panel, the operating panel and the CPU board according prior procedures.
2. Remove the keypad and degrease the surface of the glass.
3. Glue the new keypad on its place with the red colored connectors on the bottom side.
4. Reverse the procedure to install.

Note 1: *For connection flatcable of the keypads see CPU board on page 28.*

Note 2: *When the keypad is on the panel on customer side you need a long extended flatcable for connection to the CPU board.*

CONTACTOR

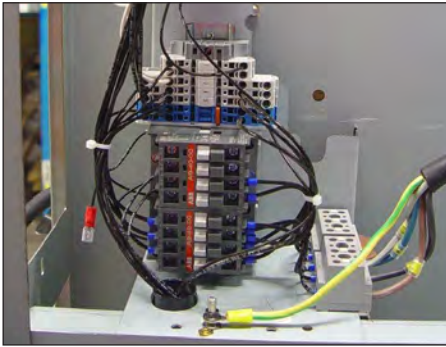

1. Remove the right side panel according prior procedure.
2. Disconnect the lead wires to the contactor.
3. Push the locking tab down with a screw driver and lift out to remove it from the mounting bracket.
4. Reverse the procedure to install.

RELAY FOR THERMISTOR FUNCTION BLOWER (FROM SER.NR. 100069000)



1. Remove the right side panel according prior procedure.
2. Loosen the clamp handle.
3. Gently remove the relay.
4. Reverse the procedure to install.

Note: When placing a relay be sure the connecting pins are in place.



DOOR SWITCH



1. Remove the operation panel and the right side panel according prior procedures.
2. Remove the 2 screws that secure the switch and remove the switch.
3. Disconnect the wiring of the switch.
4. Reverse the procedure to install.

Note: The contact pin of the switch must run free through the chassis.

HIGH LIMIT THERMOSTAT



TDR 5



TDR 8

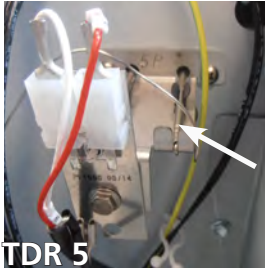

TDR 5

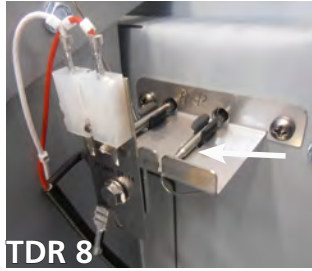

TDR 8



TDR 5 old version

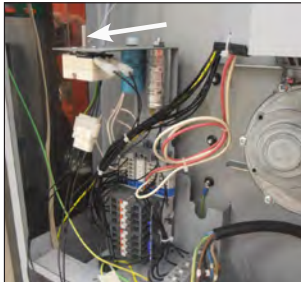

TDR 8 old version

TDR 8 until serial nr.
100060436

1. Remove the right side panel according prior procedure.
2. Remove the fan plate on the ceiling on the inside of the oven (this is only to check if the probe is on the right place).
3. Remove the thermostat probe from the clip and remove the probe.
4. Remove the screws on the electric panel that secure the thermostat.
5. Remove the thermostat and disconnect the wiring.
6. Reverse the procedure to install.

Note 1: The probe sticks out of the side wall till the end of the bracket.

Note 2: Set the new high limit thermostat to its maximum position (see arrow).

Note 3: The versions until serial nr. 100067092 have different brackets. The latest bracket is the preferred one.

PT 1000 SENSOR

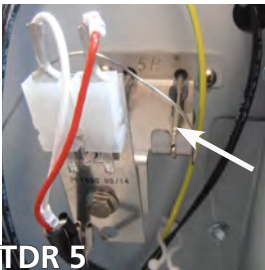

TDR 5

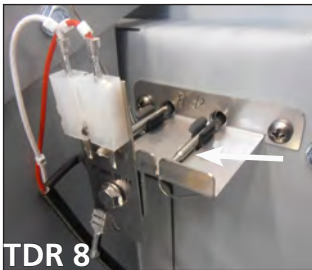

TDR 8



TDR 5 old version



TDR 8 old version

1. Remove the right side panel and the fan plate on the inside of the oven according prior procedures.
2. Disconnect the wiring of the sensor.
3. Reverse the procedure to install.

Note 1: The probe sticks out of the side wall till the end of the bracket.

Note 2: The versions until serial nr. 100067092 have different brackets. The latest bracket is the preferred one.



TDR 8 old version

INFRA-RED HALOGEN LAMP HOLDER



Caution: Do not touch the glass with your hands. The moisture from your hands could affect the live span of the lamp. This moisture can be removed with alcohol while the lamp is cold.

Note: Use a clean rag or paper towel to replace the lamp.

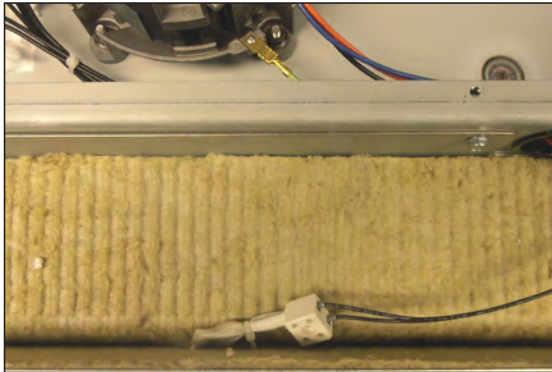

1. Remove the bolts that secure the protection guard of the Halogen lamp and remove the guard.
2. Push the lamp to either side and pull it down to remove the lamp.
3. Remove the top cover according prior procedure.
4. Disconnect the wiring on the terminal block.
5. Remove the insulation above the light fixture.
6. Remove the screws that secure the lamp holder and remove the holder from the inside.
7. Reverse the procedure to install.



Note 1: Be sure that the "drop" on the lamp is pointing downwards.

Note 2: Check the lamp reflecting shield and replace this if corroded.



INFRA-RED HALOGEN LAMP HOLDER BOTTOM ROTISSERIE (STACKED TDR 7)

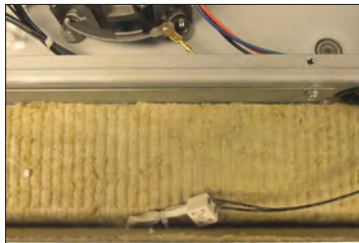
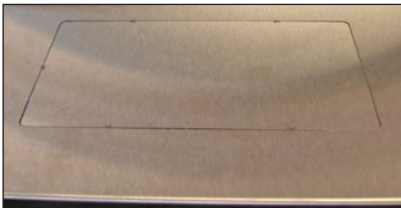
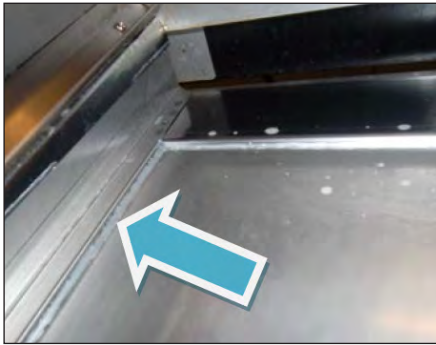

Warning: When changing the lamp holder for the TDR 5, the top rotisserie has to be removed.

Caution: Do not touch the glass with your hands. The moisture from your hands could affect the live span of the lamp. This moisture can be removed with alcohol while the lamp is cold.

Note: Use a clean rag or paper towel to replace the lamp.

1. Remove the bolts that secure the protection guard of the Halogen lamp and remove the guard.
2. Push the lamp to either side and pull it down to remove the lamp.
3. Remove the fat drawer and the drip trays from the upper oven.
4. Remove the bolts that secure the intermediate plate and remove this plate.
5. Cut the sealant around the bottom plate and remove this plate (see arrow).
6. Knock out the access plate to the light fixture and remove this plate.
7. Disconnect the wiring on the terminal block.
8. Remove the insulation above the light fixture.
9. Remove the screws that secure the lamp holder and remove the holder from the inside.
10. Reverse the procedure to install.

Note 1: Be sure that the "drop" on the lamp is pointing downwards.

Note 2: Clean all surfaces that have to be sealed. Seal the bottom plate with a grease resistant sealant.

Note 3: Check the lamp reflecting shield and replace this if corroded.

BLOWER MOTOR

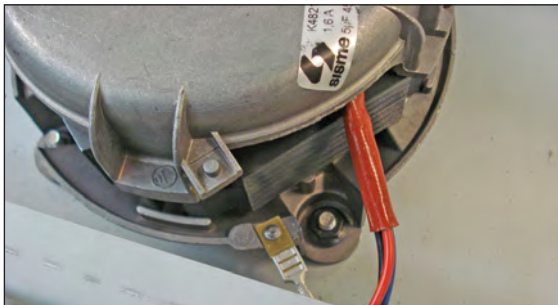
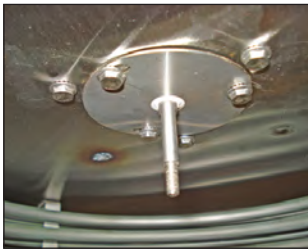
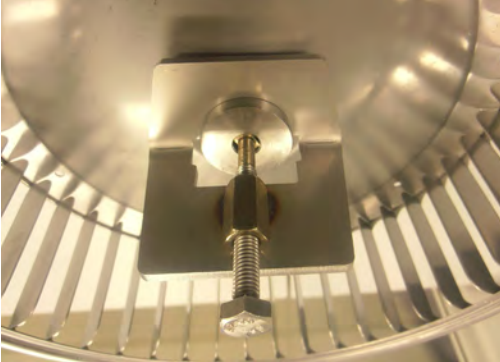

1. Remove the right side panel and the top cover according to prior procedures.
2. Remove the rotor discs and the fan plate on the ceiling inside the oven.
3. Remove the nut and washer on the fan blade and remove the fan blade with the help of the puller.
4. Remove the 3 screws that secure the shaft seal plate. Now replace the shaft seal and shaft seal plate.
5. Disconnect the connector of the motor wiring and also the grounding wire.
6. Remove the nuts that secure the motor and remove the motor.
7. Remove the wiring of the capacitor and change the capacitor.
8. Reverse the procedure to install.

Note 1: The puller is delivered with each new blower.

Note 2: The blower is equipped with a capacitor of 6 μ F. Check the direction of rotation of the motor (clockwise, see arrow).

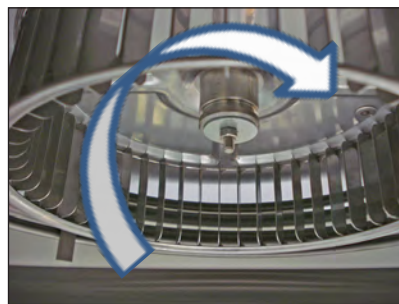

BLOWER MOTOR BOTTOM ROTISSERIE (STACKED TDR)

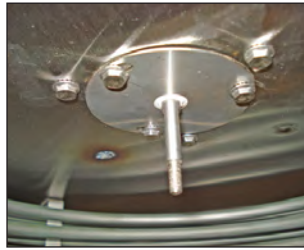
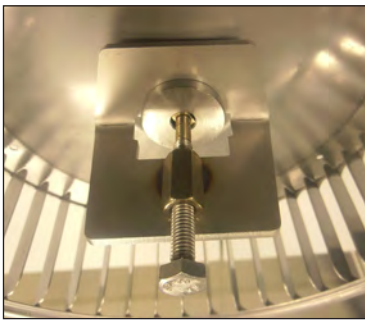

1. Remove the right side panel according prior procedures.
2. Remove the rotor discs and the fan plate on the ceiling inside the oven in the bottom oven.
3. Remove the nut and washer on the fan blade and remove the fan blade with the help of the puller.
4. Remove the 3 screws that secure the shaft seal plate. Now replace the shaft seal and shaft seal plate.
5. Remove the fat drawer and the drip trays from the upper oven.
6. Remove the bolts that secure the intermediate plate and remove this plate.
7. Cut the sealant around the bottom plate and remove this plate (see arrow).
8. Disconnect the connector of the motor wiring and also the grounding wire.
9. Remove the nuts that secure the motor and remove the motor.
10. Remove the wiring of the capacitor and change the capacitor.
11. Reverse the procedure to install.

Note 1: The puller is delivered with each new blower.

Note 2: The blower is equipped with a capacitor of 6 uF. Check the direction of rotation of the motor (clockwise, see arrow).

Note 3: Clean all surfaces that have to be sealed. Seal off the bottom plate with a grease resistant sealant.

DRIVE MOTOR

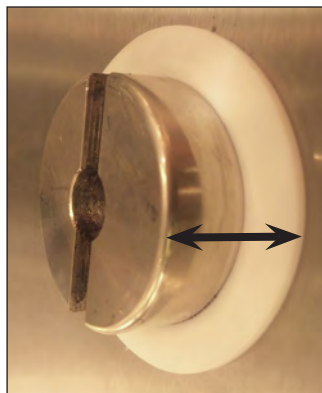
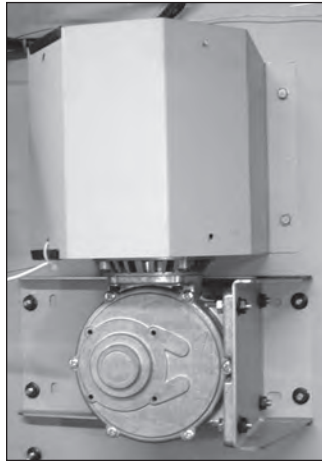
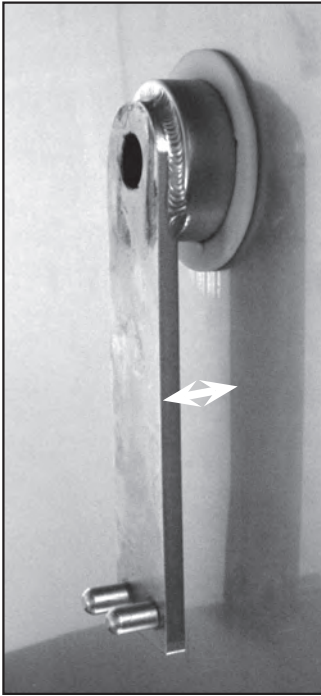

1. Remove the right side panel and rotor discs according prior procedure.
2. Disconnect the wiring of the motor. Check where the wire, marked A is connected.
3. Remove the screws that secure the fan cover and remove the cover.
4. Note down how far the drive arm or drive block sticks out from the inner wall (see white or black arrow).
5. (TDR 5 only) Remove the nuts that secure the motor and remove the motor.
6. (TDR 7 only) Set the drive arm in a position vertical downwards. This can be done manually or by turning the fan blade by hand.
7. Mark the position of the motor support with a marker.
8. Remove the bolts that secure the motor and the nuts that secure the motor support and remove the motor.
9. Check the white Teflon ring. Replace this if necessary.
10. Check the position of the red gasket between motor support and the side wall. Replace this if necessary.
11. Install the fan blade on the new motor.
12. Reverse the procedure to install.

Note: Always make a test run of 15 minutes on maximum temperature to insure the motor is well mounted and adjusted and turns parallel to the side wall.

HEATING ELEMENT

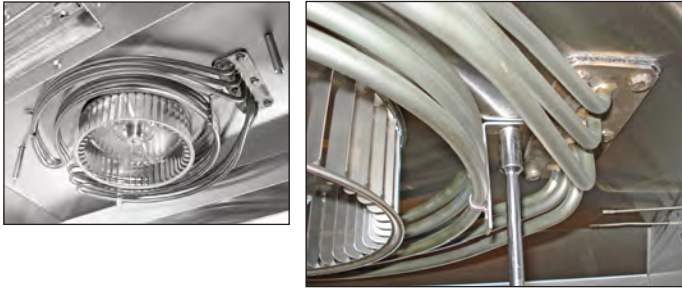

1. Remove the right side panel, the top cover and the fan plate according prior procedures.
2. Remove the nut(s) on the inside top that fastens the element to the top side.
3. Disconnect the wiring from the element.
4. Cut the insulation on the top side around the fastening plate of the elements and remove the insulation.
5. Remove the nuts that secure the element and remove the element and the gasket. Gasket has to be replaced.
6. Reverse the procedure to install.

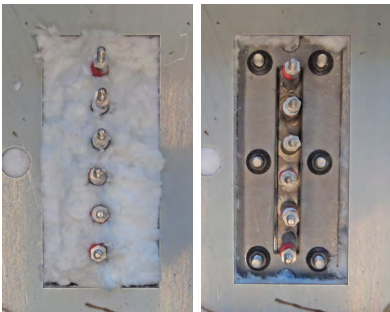

DOOR ADJUSTMENT (LEFT SIDE)

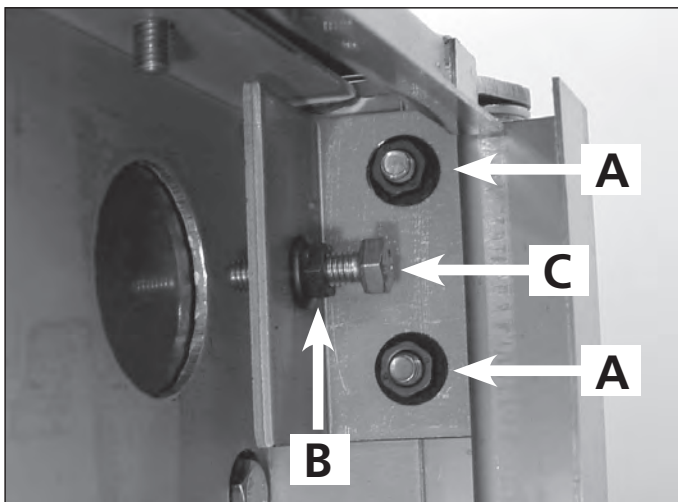

1. Remove the left side panel according prior procedure.
2. Loosen the nuts A of the upper hinge. The door must be closed.
3. Loosen the locknut B and adjust the bolt C in or out to adjust the door.
4. Tighten the nuts of the hinge and mount the left-hand panel.

DOOR INSIDE



1. Separate the inside door from the outside door.
2. Lift the inside door upward out of the hinges.
3. Place the new door in the hinges.
4. Close the inside door on the outside door.

Note: Tightening of nuts max. 8 Nm. or 5.9 lbf.ft

DOOR OUTSIDE



1. Lift the inner door out of the hinges and lay this aside.
2. Remove the left side panel according prior procedure.
3. Remove the 2 nuts behind the upper hinge and loosen the locknut according prior procedure. The door must be closed.
4. Hold the door on both sides and move this towards yourself, before lifting it out of the hinge on the bottom side. See to it that the washers stay on the hinge.
Also remove the top hinge.
5. Place the top hinge on the new door.
6. Place the new door on the hinge on the bottom side and push the 2 studs on the top hinge through the openings on the top side and screw the nuts on it .
7. Adjust the door according prior procedure.

Note: Tightening of nuts max. 8 Nm. or 5.9 lbf.ft

REMOVAL AND REPLACEMENT OF PARTS FOR THE TDW 5 AND TDW 7

WARNING: Disconnect the electrical power to the machine at the main circuit box. Place a tag on the circuit box indicating the circuit is being serviced.

BLOWER MOTOR



1. Remove the right side panel according prior procedure.
2. Remove the racks and bottom plate.
3. Remove the cap nuts that secure the fan plate and remove fan plate.
4. Remove the wing nut on the fan blade and remove fan blade. Left handed threads.
5. Disconnect wiring of the motor.
6. Remove the screws that secure the motor and remove the motor.
7. Reverse the procedure to install.

Note: The blowers are equipped with a capacitor of 1.5uF. Check the direction of rotation of the motor (clockwise, see arrow) and change the wiring if necessary.

THERMOMETER

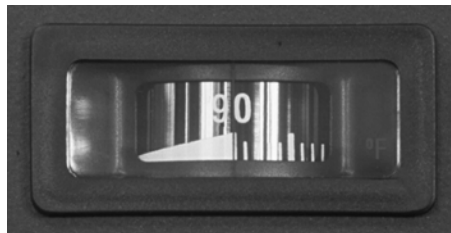
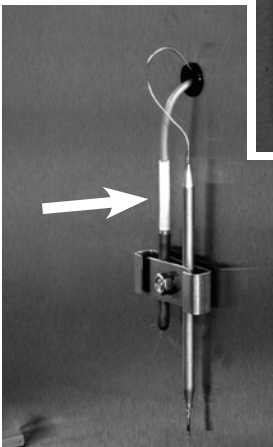

1. Remove the right side panel, the fan plate and the operating panel according prior procedures.
2. Remove the thermometer probe from the clamp inside the cavity (see arrow) and guide it outside through the opening.
3. Remove the 2 nuts that secure the clamp plate, on the backside, over the thermometer.
4. Remove the thermometer out of the clamp plate.
5. Reverse the procedure to install.

THERMOSTAT

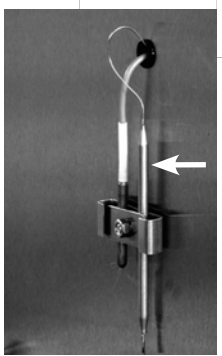
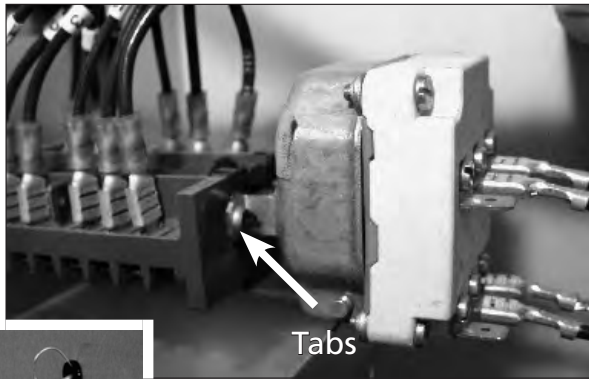

1. Remove the right side panel and the fan plate according prior procedures.
2. Remove the thermostat probe from the clamp inside the cavity (see arrow) and guide it outside through the opening.
3. Disconnect the wiring from the thermostat.
4. Remove the thermostat from the main switch by squeezing the tabs (see arrow) and pull the thermostat away.
5. Reverse the procedure to install.

MAIN SWITCH



1. Remove the right side panel according prior procedure.
2. Remove the knob according prior procedure.
3. Remove the screws, on the frontside of the operating panel, that secure the main switch and remove the switch.
4. Disconnect the wiring from the switch.
5. Remove the thermostat from the main switch according prior procedure.
6. Reverse the procedure to install.

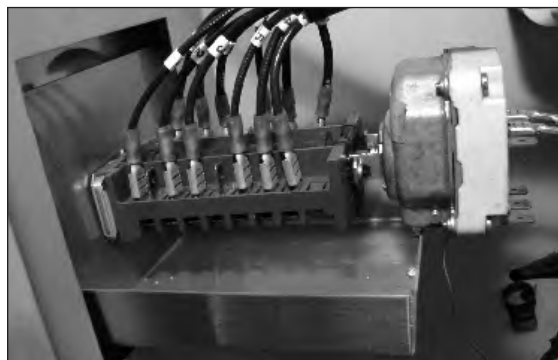

HEATING ELEMENT



1. Remove the right side panel, racks, bottom plate and the fan plate according prior procedures.
2. Disconnect the wiring from the element.
3. Remove the nuts and rings that secure the element and remove the element.
4. Reverse the procedure to install.

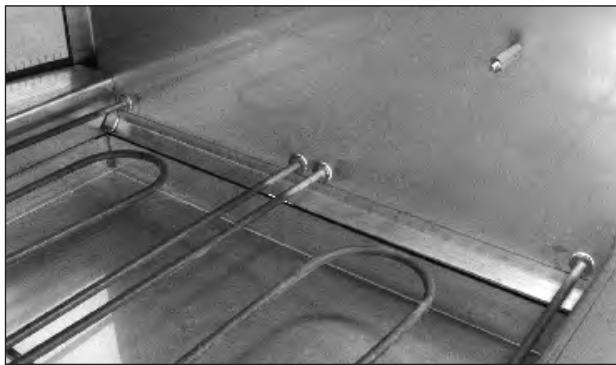

HALOTHERM LAMP



1. Remove the bolts of the protection guard.
2. Push the lamp to either side and pull it down to remove the lamp.
3. Insert one end of the new lamp in the socket and push it in. Align the other end of the lamp with the socket and allow the spring tension to push the lamp in place.
4. Replace the protection guard.

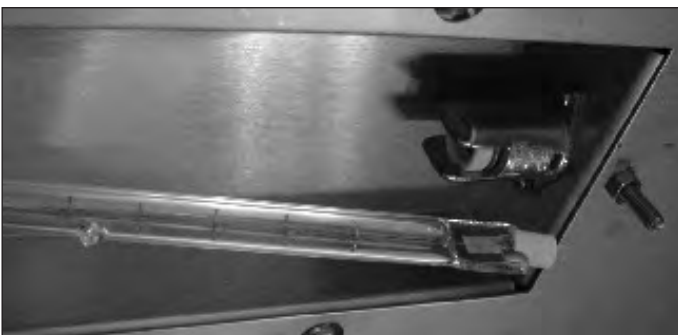

Note: Be sure that the “drop” on the lamp is pointing downwards.

PARAMETER LISTING TDR P

INTRODUCTION

This chapter contains an explanation and listing of the parameters for the P-control system of the TDR. The first section contains explanations for every parameter. The sections after that contain instructions and a parameter table for the TDR P.

The P-control system has 2 separate parameter sections, one titled "Manager" and one titled "Service". The manager parameters are protected with a standard password "1111". The manager can also protect this with his own 4-digits password.

The service section is only accessible for qualified service technicians.

The start up screen lists general information such as software version number, model name and Fri-Jado company logo.

Please make sure you read the paragraph titled "adapting parameters" before changing parameters. It contains some important information concerning the programming of the parameters.

REACHING THE PARAMETER MENUS

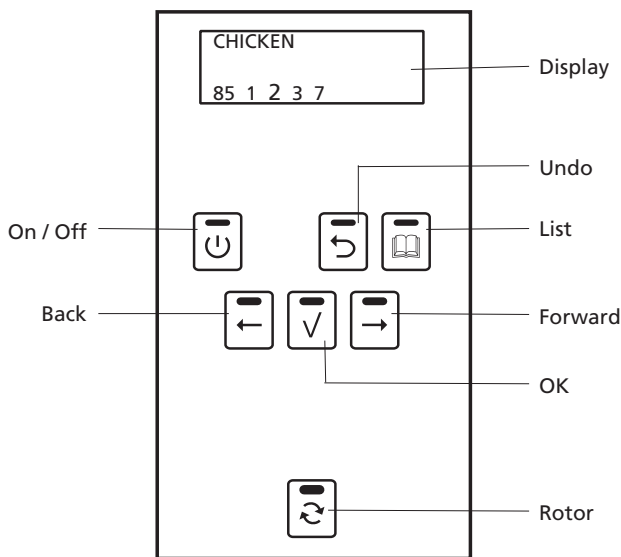

To reach the Manager parameter menu, press the "list" key and enter with the standard password "1111" (if not protected by a specific Manager password).

To reach the Service menu press and hold the "UNDO" key for 5 seconds and enter with the password "4878".

To leave a section use the UNDO key.

Note 1: The service section is by default protected with a default password "4878".

Note 2: The manager section can be protected by a separate password, this password can be set inside the manager menu. It is possible to read this password through the service menu in the User PIN parameter.

OPTIONS MANAGER MENU

To enter the manager menu press and hold the List key. The manager section can be protected by a separate password. The standard number is "1111", This password can be changed inside the manager menu.

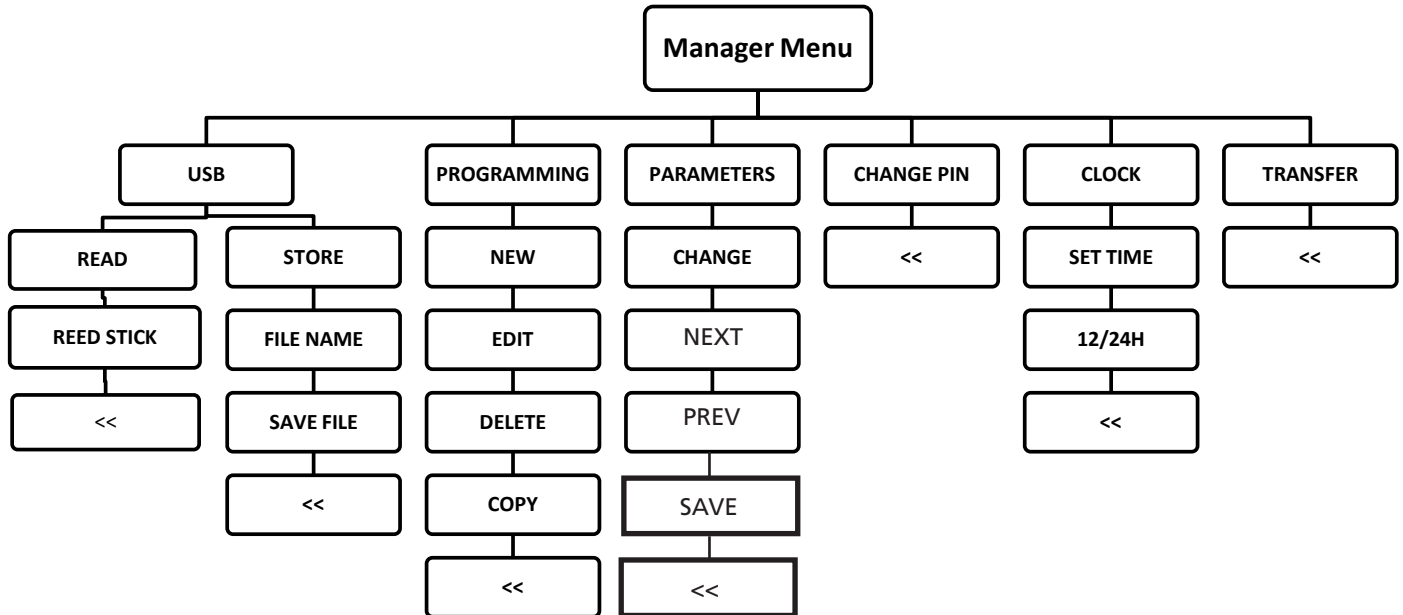

OPTIONS SERVICE MENU

To enter the service menu press and hold the UNDO key for 5 seconds. The service section is by default protected with a default password of "4878".

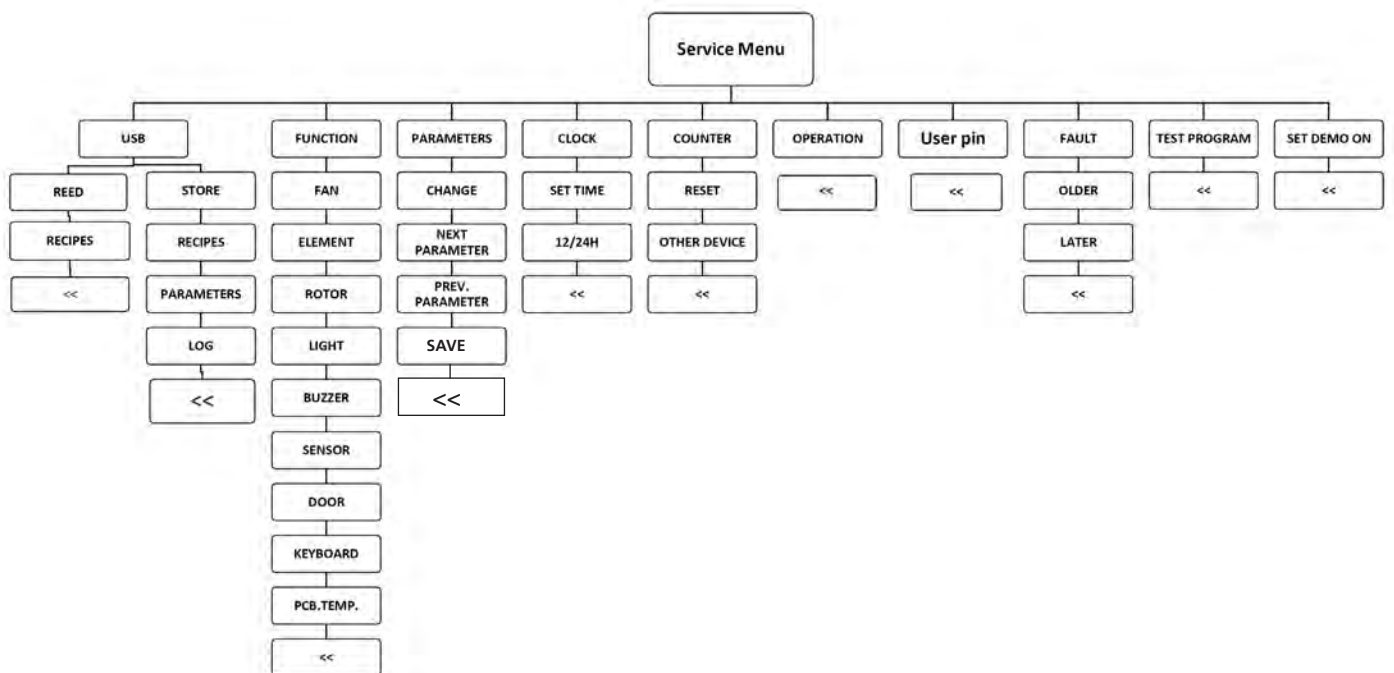

MANAGER MENU - DESCRIPTION OF THE SUBMENUS

Menu section: Manager menu	
Parameter	Description
USB	In this menu you can read recipes from the USB stick to the CPU board, or store programs from the CPU to the USB stick.
Programming	In this menu you can process the cooking programs. You can make a new program or edit, delete or copy an existing program.
Parameters	In this menu you can view or change all manager parameters. Note: when changing a parameter in this manager menu, this will automatically be changed also in the service menu. For an overview of the parameters see parameter list manager menu.
Change pin	In this menu you can change the manager pincode.
Clock	In this menu you can set the time and the time format (12/24h clock).
Transfer	In this menu you can store log data on the USB stick. These are 2 separate files. One with a error overview and the second with all parameter settings.

Parameter list Manager menu	
Parameter	Description
Language	This parameter allows the setting of the language of the different texts used by the unit. Note that some texts may not yet have an updated translation.
Big digits	This parameter allows to choose for big digits on the display during preheat, cooking and hold cycle.
Preheat allowed	This parameter allows the enabeling of preheating before a recipe. If "yes" is selected, every program can have a preheat step included, you have a choice in this. If "no" is selected preheating is not possible, even if there is a program with a preheat step.
Holding allowed	This parameter allows the enabeling of a warm hold step at the end of the grilling step(s). If "yes" is selected every program can have a holding step included, you have a choice in this. If "no" is selected holding is not possible, even if there is a program with a holding step.
Preheat temperature	This parameter allows the programming of a general preheat temperature. Note: this preheat temperature is suggested and can be overwritten in the programs.
Holding temperature	This parameter allows the programming of a general holding temperature. Note: this holding temperature is suggested and can be overwritten in the programs.
Sound preheat T1	This parameter allows to set an alarm sound at the end of the preheat step. You can choose 3 different sounds (T1-T2-T3) and the level of the sound (up to 4 white blocks) or no sound (no white block).
Sound step T2	This parameter allows to set an alarm sound at the end of the first grilling step. You can choose 3 different sounds (T1-T2-T3) and the level of the sound (up to 4 white blocks) or no sound (no white block).
Sound done T3	This parameter allows to set an alarm sound at the end of the grilling step(s). You can choose 3 different sounds (T1-T2-T3) and the level of the sound (up to 4 white blocks) or no sound (no white block).

SERVICE MENU - DESCRIPTION OF THE SUBMENUS

Menu section: Service menu	
Parameter	Description
USB	In this menu you can read recipes from the USB stick to the CPU board. And you can store recipes, parameters and LOG data to the USB stick.
Function	This menu allows access to the I/O test screen, Through this, several inputs and outputs of the machine can be monitored and toggled. You can also test the keypad.
Parameters	In this menu you can view or change all service parameters. Note: when changing a parameter in this service menu, this will automatically be changed also in the manager menu. For an overview of the parameters see parameter list service menu.
Clock	In this menu you can set the time and the time format (12/24h clock).
Counter	In this menu you can view the total working hours of the fan, gearbox and heaters. After replacing one of these parts you have to set the counter on zero again.
Operation	In this menu you can view the total hours of operation. This value is not resettable.
User pin	In this menu you can view the current set pincode. This code can only be viewed and not changed.
Fault	In this menu you can view all occurred errors and, if applied, in what cooking program.
Test program	In this menu you can start a test program. This fixed program has one cooking step of 250°C/482°F for 20 minutes and a holding program of 85°C/185°F and 10 minutes.
Set demo on	In this menu you can set the machine into a demonstration mode. In demonstration mode the machine will not turn the heating elements on and will simulate the machine heating up only through software.

Parameter list Service menu	
Parameter	Description
Language	This parameter allows the setting of the language of the different texts used by the unit. Note that some texts may not yet have an updated translation.
Big digits	This parameter allows to choose for big digits on the display during preheat, cooking and hold cycle.
Preheat allowed	This parameter allows the enabling of preheating before a recipe. If "yes" is selected, every program can have a preheat step included, you have a choice in this. If "no" is selected preheating is not possible, even if there is a program with a preheat step.
Holding allowed	This parameter allows the enabling of a warm hold step at the end of the grilling step(s). If "yes" is selected every program can have a holding step included, you have a choice in this. If "no" is selected holding is not possible, even if there is a program with a holding step.
Preheat temperature	This parameter allows the programming of a general preheat temperature. Note: this preheat temperature is suggested and can be overwritten in the programs.
Holding temperature	This parameter allows the programming of a general holding temperature. Note: this holding temperature is suggested and can be overwritten in the programs.
Sound preheat T1	This parameter allows to set an alarm sound at the end of the preheat step. You can choose 3 different sounds (T1-T2-T3) and the level of the sound (up to 4 white blocks) or no sound (no white block).
Sound step T2	This parameter allows to set an alarm sound at the end of the first grilling step. You can choose 3 different sounds (T1-T2-T3) and the level of the sound (up to 4 white blocks) or no sound (no white block).
Sound done T3	This parameter allows to set an alarm sound at the end of the grilling step(s). You can choose 3 different sounds (T1-T2-T3) and the level of the sound (up to 4 white blocks) or no sound (no white block).
Temp. unit	This parameter allows the switching between showing degrees either in Celcius (°C) or Fahrenheit (°F). Changing the parameter affects all values directly and no restart of the machine is required.

Parameter list Service menu	
Parameter	Description
Ecocook allowed	This parameter allows the ecocook to be activated or not. Ecocook on yes means that the accumulated heat in the cavity will be used to cook the product and to save energy. Heating elements will not be activated during the last period of the last grilling step.
Ecocook var.	This parameter allows to set the variable of the ecocook. Var. adjustable from 1 to 9. This is the percentage of the total cooking time.
Boost allowed	This parameter allows to add extra cooking time at the end of the grilling cycle. If set on "yes" you can add extra time in minutes.
User PIN in use	This parameter allows free access to the Manager menu if set on "no". Or protected access by means of a pin code if set on "yes". If set on "no" there is no pin code protection for the Manager menu and you have free access to this menu. If set on "yes" the standard Manager pin code is "1111", but can also be changed to another pin code. Note: Always set the pincode back on "yes" after work has ended.
Lights out	This parameter allows the lights to be shut off during opening of the door during stand by position. If set on "no" the lights will go on for 20 seconds.
key beep	This parameter allows to set a beep sound when a key is touched. If set on "off" the beep sound will be off.
Temp. offset	This parameter allows to set an offset in the temp. regulation. For example: if temp. is set on 200°C/390°F and offset on -20°C/-36°F the software regulates the temp. on 220°C/428°F, so a real higher operating temp. The actual temperature is indicating 36°F lower than it really is. The set temperature of 390°F will be indicated on the display. Offset can be adjusted on ± 49,9°C/99.9°F.
Cook correction allowed	This parameter allows a cooking time that automatically will be adjusted depending on the load of products. The first cook is the reference cook and will be used to fix the correct parameters. The activation of the cook correction is not visible in the display.
Key sens	This parameter allows the adjustment of the sensitivity of the keys. Sensitivity is highest on value 1 and lowest on 9.
Temp. grad.	This parameter allows the setting of the minimal temperature rise, in °C / 2minutes, of the PT sensor during the preheat, cooking or hold step. This parameter is used for the error 55 test. In this test the measuring only starts 5 minutes after beginning of a heating step. Duration of the test is 5 periods of 2 minutes. Measuring stops at 150°C/302°F or when temp. in the cabinet is < 30°C than the set temperature. When the temperature rise is lower than 0.5°C per 2 minutes during 5 consecutive periods, an "error 55" will be indicated and the machine switches off.
Second display	This parameter allows the setting of the display on customer side. 0 = Second display has only the rotor function in stand by position. 1 = Second display has only limited functions like viewing during cooking proces. 2 = As 1 + possibility of selection of programs and starting. 3 = Not in use.
Thermistor	This parameter allows the activation of an error on the clixon inside the blower motor. If set on "yes" the clixon is connected, by relay K3, to the input of the CPU board and stops the blower and rotisserie when overheating and indicates an error 66. If set on "no" the clixon is not activated.

Notes:

- After parameter changes have been made in both Manager or Service menu, you have to go to save and press OK key to confirm.
- When parameters, that are both in Manager and Service menu, are changed in one menu they will be also adjusted in the other menu.
- When preheat allowed or holding allowed is set on zero, no preheat or holding will take place even if this is programmed in a recipe.
- When preheat is set in the Manager or Service menu and the recipe itself has no preheat programmed, there will be no preheat in the cooking cycle.
- It is not possible to program only a preheat or hold step, without a cooking step.
- The countdown of the last minute in the cooking cycle is displayed in seconds.

ADAPTING PARAMETERS

The P-control system utilises a large set of parameters, of these parameters a select group is open to customization. This meaning these parameters can be adjusted to offer functionality more fitting to the intended purpose of the unit.

The manager parameters are open to modification. It is however important to know beforehand what a parameter does before changing it, a detailed description of all parameters can be found earlier in this chapter.

Generally speaking all Service parameters are considered important and should not deviate from the value as listed in the parameter lists found in this document.

When changing the critical service parameters beyond the value listed in this document Fri-Jado cannot guarantee that the unit will function as to be expected.

LOADING SOFTWARE

Software can only be loaded to the CPU board by means of a memory stick. The download is always done out of a folder called "42-P+CPU" (see also explanation updating system. This folder has to be placed direct on the memory stick and cannot be placed in another folder, otherwise it will not work. That means only one folder "42-P+CPU" can be placed direct on the memory stick

To load new software from a memory stick to the CPU board is as follows:

1. Disconnect the power.
2. Place memory stick in the side wall.
3. Put the plug in the socket or switch on the mains supply. Now the new software will be loaded inside the CPU board.
4. You will be asked to remove the stick and when done the unit switches on. (the existing parameters will remain).

Updating system software (firmware). Only in case the unit has older software!!

This software, supplied by Fri-Jado comes in a "zip" file with the version number of the software, for example "V1_4_09.zip". The file needs to be copied on a USB stick. (disk "USB drive (F:)" in the example).

After unpacking it, the folder named "42-P+CPU" needs to be moved or copied to the root of the USB stick as shown below.

After unpacking.

Move the "42-P+CPU" folder to the root.



READ AND STORE RECIPES IN MANAGER MENU

Recipes can be read and stored from both the Manager menu and the Service menu.

Recipes can only be read to, or stored from the CPU board by means of a memory stick. The transfer is always done out of a folder called "Programs". This folder has to be placed direct on the memory stick and cannot be placed in another folder, otherwise it will not work. If the folder called "Programs" doesn't exist on the memory stick, this folder will be created automatically while storing. The folder can contain several files with programs. The name of a file may exist of maximum 8 characters, otherwise it will not be read or stored.

When reading a new program to the CPU board the old program will be deleted. So it's advisable to store the old program first on your memory stick. **How to read and store recipes see also USB on page 24.**

To read a program from a memory stick to the CPU board is done as follows:

1. Place the memory stick and go to the manager menu choose "USB" and confirm with OK.
2. Go to "read" and confirm with "OK".
3. Go to "read stick" and confirm with "OK".
4. Choose file name, with "other file", and confirm with "OK".
5. Now go to "read file" and confirm with "OK".

Now the new program will be loaded inside the CPU board.

To store programs from the CPU board to the memory stick is done as follows:

1. Place the memory stick and go to the manager menu choose "USB" and confirm with "OK".
2. Go to "store" and confirm with "OK".
3. Now choose a file name and confirm with "OK".
4. Go to "save" and confirm with "OK".

Now the program will be written on the memory stick.

Notes:

- When the message "files not found" is indicated on the display try to reset the machine by pulling the plug out for 5 seconds.
- The name of a file may not exist of more than 8 characters and can't have a space between the characters. Check this in the program list on the memory stick.
- It is not allowed to have a open line in the recipe list. Remove the open line and try again.
- If the reset doesn't work try to load the software again.
- All recipe names must have the extension .csv.

READ AND STORE RECIPES AND PARAMETERS IN SERVICE MENU

Recipes can be read and stored from both the Manager menu and the Service menu.

Recipes can only be read to, or stored from the CPU board by means of a memory stick. The transfer is always done out of a folder called "Programs". This folder has to be placed direct on the memory stick and cannot be placed in another folder, otherwise it will not work. If the folder called "Programs" doesn't exist on the memory stick, this folder will be created automatically while storing. The folder can contain several files with programs. The name of a program file may exist of maximum 8 characters and can't have a space between the characters, otherwise it will not be read or stored.

When reading a new program to the CPU board the old program will be deleted. So it's advisable to store the old program first on your memory stick.

To read a recipe program from a memory stick to the CPU board is done as follows:

1. Place the memory stick and go to the Service menu (pincode 4878), choose "USB" and confirm with OK.
2. Go to "read" and confirm with "OK".
3. Choose "recipes" and confirm with "OK".
4. Go to "read stick" and confirm with "OK".
5. Choose file name, with "other file", and confirm with "OK".
6. Now go to "read file" and confirm with "OK".

Now the new program will be loaded inside the CPU board.

To store recipe programs from the CPU board to the memory stick is done as follows:

1. Place the memory stick and go to the Service menu (pincode 4878) choose "USB" and confirm with "OK".
2. Go to "store" and confirm with "OK".
3. Choose "recipes" and confirm with "OK".
4. Fill in a file name, with "other file" and confirm with "OK".
5. Go to "save" and confirm with "OK".

Now the program will be written on the memory stick.

Notes:

- When the message "files not found" is indicated on the display try to reset the machine by pulling the plug out for 5 seconds.
- The name of a file may not exist of more than 8 characters and can't have a space between the characters. Check this in the program file on the memory stick.
- It is not allowed to have a open line in the recipe list. Remove the open line and try again.
- If the reset doesn't work try to load the software again.
- All recipe names must have the extension .csv.

Parameters can only be read to, or stored from the CPU board by means of a memory stick. The transfer is always done out of a folder called "PARAMS". This folder has to be placed direct on the memory stick and cannot be placed in another folder, otherwise it will not work. If the folder called "PARAMS" doesn't exist on the memory stick, this folder will be created automatically while storing. The folder can contain several parameter files. The name of a file may exist of maximum 8 characters and can't have a space between the characters, otherwise it will not be read or stored.

When reading a new parameter file to the CPU board the old parameters will be deleted. So it's advisable to store the old program first on your memory stick.

To read a parameter list from a memory stick to the CPU board is done as follows:

1. Place the memory stick and go to the service menu (pincode 4878), choose "USB" and confirm with OK.
2. Go to "read" and confirm with "OK".
3. Choose "parameters" and confirm with "OK".
4. Go to "read stick" and confirm with "OK".
5. Choose file name, with "other file", and confirm with "OK".
6. Now go to "read file" and confirm with "OK".

Now the new parameters will be loaded inside the CPU board.

To store parameters from the CPU board to the memory stick is done as follows:

1. Place the memory stick and go to the Service menu (pincode 4878) choose "USB" and confirm with "OK".
2. Go to "store" and confirm with "OK".
3. Choose "parameters" and confirm with "OK".
4. Now choose a file name and confirm with "OK".
5. Go to "save" and confirm with "OK".

Now the parameters will be stored on the memory stick.

Notes:

- When the message "files not found" is indicated on the display try to reset the machine by pulling the plug out for 5 seconds.
- The name of a parameter file may not exist of more than 8 characters and can't have a space between the characters.
- Check if there is a folder on the memory stick with the name "PARAMS".
- If it still doesn't work try to load the software again.
- All parameter name files must have the extension .csv.

PARAMETER LIST P

Parameters P eco software version 1.04.09 USA				
Level 1	Level 2	Level 3	Default	Possibilities
Information			1.04.09	software version
Manager			1111	
	Preheat allowed		yes	yes - no
	Preheat temp		425	50 - 250 °C / 122 - 482 °F
	Holding allowed		no	yes - no
	Holding temp		160	50 - 250 °C / 122 - 482 °F
	Cook Correction ¹		yes	yes - no
	Eco function ²		no	yes - no
	Language		English	English - Nederlands - Deutsch - Francais - Espanol - Russian
	Big Digits		yes	yes - no
	Sound preheat		T1, ■■■■	T1 - T2 - T3
	Sound step		T3, ■□□□	T1 - T2 - T3
	Sound done		T1, ■■■■	T1 - T2 - T3
Service			4878	
	Preheat allowed		yes	yes - no
	Preheat temp		425	50 - 250 °C / 122 - 482 °F
	Holding allowed		no	yes - no
	Holding temp		160	50 - 250 °C / 122 - 482 °F
	Cook corr. Option		yes	yes - no
	Cook corr. factor		3	1 - 6
	Ecocook option		no	yes - no
	Ecocook var		6	1 - 9
	Language		English	English - Nederlands - Deutsch - Francais - Espanol - Russian
	Big Digits		yes	yes - no
	Sound preheat		T1, ■■■■	T1 - T2 - T3
	Sound step		T3, ■□□□	T1 - T2 - T3
	Sound done		T1, ■■■■	T1 - T2 - T3
	Temp unit		°F	°C - °F
	Boost allowed		yes	yes - no
	User pin in use		no	yes - no
	Lights out		yes	yes - no
	Key beep		yes	yes - no
	Temp offset		0	-50 - +50 °C or -100-+100 °F
	Key sense		7	1 - 11
	Temp grad ³		3	0 - 19
	Second Display		0	0-1-2-3
	Thermistor ⁴		no	yes - no

¹ Only visible when "Cook Corr. option" in Service Menu is set on "yes"

² Only visible when "Ecocook option" in Service Menu is set on "yes"

³ If set to "0" then the error 55 function is not active.

⁴ Has to be set on "no" until serial number 100069000.

ELECTRICAL TESTS AND SERVICE PROCEDURES

WARNING: Disconnect the electrical power to the machine at the main circuit box. Place a tag on the circuit box indicating the circuit is being serviced.

HEATING ELEMENT TEST

Note: When testing the resistance of the element remove the wiring.

Type	Wattage/Voltage	Resistance Ω -0% + 10%	Current A
TDR 5	3x 1800 / 230 3x 1800 / 208	3x 29.3 3x 24.0	3x 7.8 3x 8.6
TDR 8	2x 3000 / 230 1x 3300 / 230 2x 3000 / 208 1x 3300 / 208	2x 17.6 16.0 2x 14.4 13.1	2x 13.0 14.3 2x 14.4 15.8
TDW 5	2500 / 230	21.0	9.8
TDW 8	1500 / 230	35.0	5.9

CONTACTOR, DRIVE MOTOR AND BLOWER TEST

Note: When testing the resistance remove the wiring.

Type	Description	Voltage	Resistance Ω
TDR 5 + 8	Contacteur	208	Resistance of coil (A1 - A2) ~ 525
TDR 5 + 8	Drive motor	208	Between white A and white wire ~ 235 Between white A and brown wire ~ 117 Between white and brown wire ~ 117
TDR 5 + 8	Blower rotisserie	208	Between black and red wire ~ 65 Between black and blue wire ~ 35 Between red and blue wire ~ 30
TDW 5 + 8	Blower warmer	208	Between blue and brown wire ~ 310 Between blue and black wire ~ 320 Between brown and black wire ~ 630

PT1000 SENSOR TEST

Temperature		Resistance Ω
$^{\circ}\text{F}$	$^{\circ}\text{C}$	± 5 Ohms
32	0	1000
60	16	1062
70	21	1082
80	27	1106
90	32	1124
100	38	1148
125	52	1202
150	65	1252
200	94	1362
250	121	1464
350	177	1674
450	233	1880

Note: When testing the resistance of the sensor remove the wiring. Refer to the removal and replacement part of the manual on how to do this.

1. Remove the wiring from the sensor.
2. Connect a temperature sensor to the probe for comparison.
3. Test the probe with an Ohmmeter.

ERROR CODES ON DISPLAY

Error 11: Full contact between wires of PT sensor. Temp. indication on display doesn't go up.

Error 33: No connection between wires of PT sensor. Temp. indication on display 317 $^{\circ}\text{C}$ / 602 $^{\circ}\text{F}$.

Error 55: Heating defect. Temperature rise in $^{\circ}\text{C}/\text{minute}$ of the PT sensor during cooking of the products is under the minimum value as indicated in parameter "Temp. grad." See also the parameterlist on page 51 and explanation on page 46.

Error 66: Thermal protection of blower activated. This error message is active from software version V1.04-09.

Note: The parameter for this thermistor has to be set on "yes" only from serial number 100069000. For older models this parameter has to be set on "no", otherwise this results in a continuous error 66.

Error 77: If the expected heat number is more than 20% lower than the stored heat number in the cooking program. This error does not result in a complete shut down of the rotisserie, but is stored in the fault messages in the service menu.

Error 88: If the expected heat number is more than 20% higher than the stored heat number in the cooking program. This error does not result in a complete shut down of the rotisserie, but is stored in the fault messages in the service menu.

App. Error: - Parameter file cannot be opened when switching the TDR on.

- Failure during loading of parameters or programs.
- Communication failure keypad and CPU.

For explanation and solving of the errors see general troubleshooting list on page 55.

CONTROL LOCATION

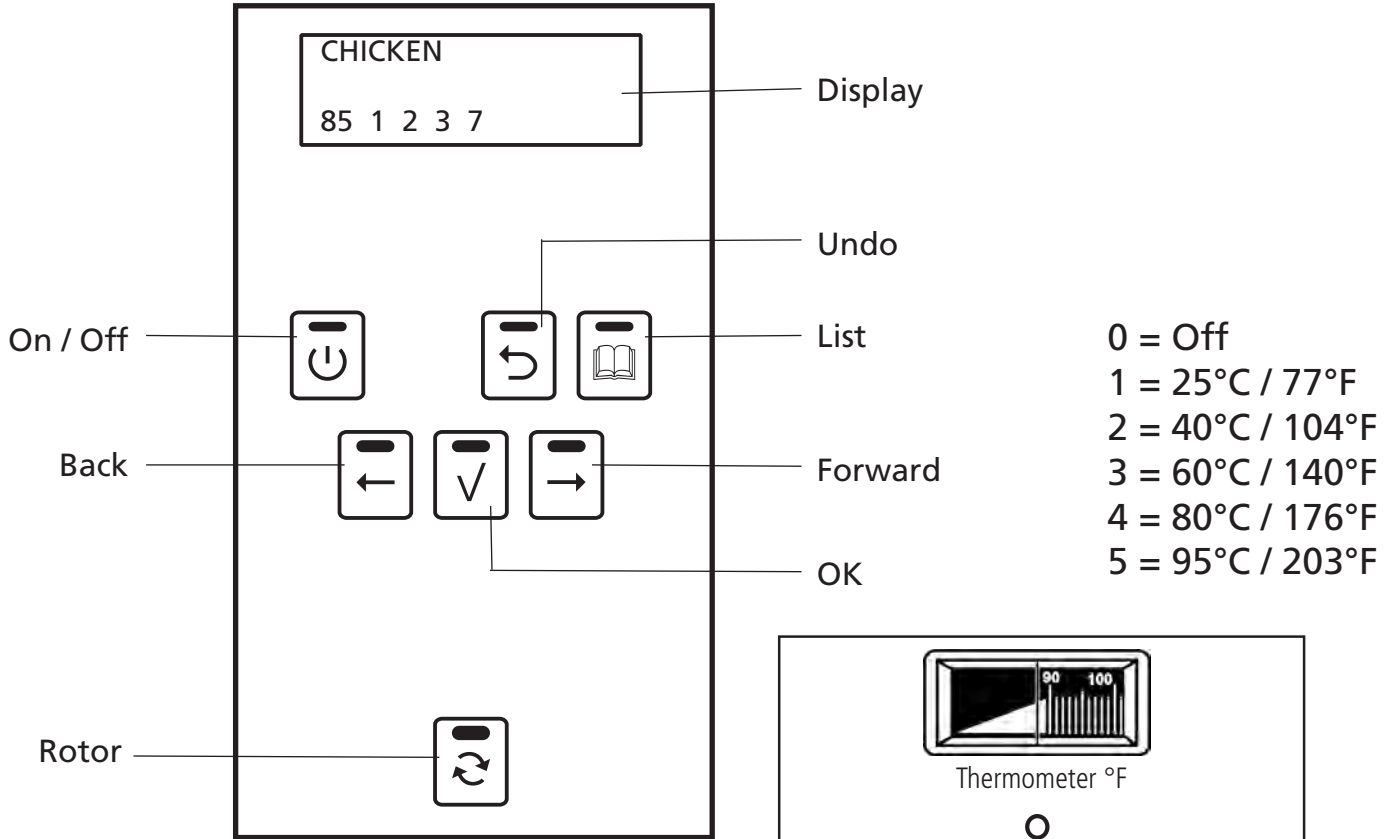

Key	Function
On / Off	Switching the unit On / Off
Undo	Go back to previous menu
List	Recipe / programming modus
Forward	One step ahead in setting
Rotor	Switching the rotor on
OK	Acknowledge a function or change
Back	One step back in setting

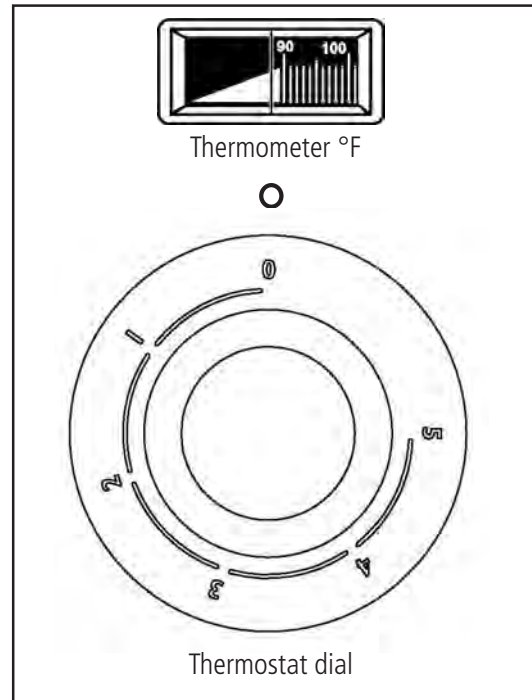

GENERAL TROUBLESHOOTING LIST

TROUBLESHOOTING FOR THE TDR 5 AND 7 P ROTISSERIES

Symptom	Possible causes
No power to oven controls.	<ol style="list-style-type: none"> 1. Main breaker open. 2. Fuse burned (F1 or F2). 3. Fuse power and I/O board burned (F4). 4. Electronic control inoperative. 5. Wiring or flatcable loose/broken.
Main fuse or breaker blows.	<ol style="list-style-type: none"> 1. Wiring incorrectly. 2. Heating element, drive motor, blower or contactor shorted. 3. Wiring shorted.
Drive motor does not run during cooking cycle.	<ol style="list-style-type: none"> 1. Main fuse inoperative. 2. Capacitor malfunction. 3. Motor malfunction. 4. Door switch malfunction. 5. Power and I/O board malfunction. Also check relay X12. 6. Wiring loose.
Drive motor stops and runs again after a certain period.	<ol style="list-style-type: none"> 1. Thermal protection activated (105°C / 220°F). This shuts off after the temperature is below 105°C / 220°F.
Blower motor does not run.	<ol style="list-style-type: none"> 1. Capacitor malfunction. 2. Motor inoperative. 3. Power and I/O board malfunction. Also check relay X6. 4. Wiring loose.
Blower motor stops and runs again after a certain period.	<ol style="list-style-type: none"> 1. Thermal protection activated (140°C / 285°F). This shuts off after the temperature is below 140°C / 285°F.
Oven temperature differs from temperature setting.	<ol style="list-style-type: none"> 1. Incorrect line voltage. 2. (safety) thermostat malfunction. 3. Blower motor inoperative (turning direction?). 4. Electronic control inoperative. 5. PT 1000 sensor malfunction. 6. PT sensor not in right place (see also page 32) 7. Dirty fanguard or fanblade.
All heating elements out, both halogen lamps and blower operate while oven cavity is below set temperature.	<ol style="list-style-type: none"> 1. (safety) thermostat malfunction. 2. Contactor inoperative. 3. Power and I/O board malfunction. 4. Wiring loose.
Oven temperature does not reach desired temperature.	<ol style="list-style-type: none"> 1. (safety) thermostat malfunction. 2. Contactor inoperative. 3. PT 1000 sensor malfunction. 4. PT 1000 sensor not in right place (see also page 32) 5. Electronic control inoperative. 6. Heater(s) inoperative. 7. Incorrect line voltage.
All beep functions do not function anymore.	<ol style="list-style-type: none"> 1. Obsolete software (older than V1.03.06). Load latest software. If no software is available unplug the unit for 5 seconds and plug in again. Now the beep signal will work again for 49 days. 2. All sounds in parameter list are disabled (switched off).
Blue LED light On/Off key is fading in and out. Keypad does not function.	<ol style="list-style-type: none"> 1. Flatcable from keypad is connected incorrectly. Must be connected to "Touchpanel 1" connector of CPU board (see CPU board page 28).

Symptom	Possible causes
No display and/or keypad does not function.	<ol style="list-style-type: none"> 1. Main breaker open. 2. Remove plug out of socket and connect plug again (reset of key sensitivity). 3. Loose flat cable from CPU/display to power and I/O board. 4. Fuse (125 mA) on power and I/O board burned. 5. Power and I/O board malfunction. 6. Loose flatcable from CPU/display to keypad. 7. CPU board malfunction. 8. Door switch malfunction. 9. Keypad malfunction. Check also the adhesive of the keypad. 10. Earth wire on CPU board makes contact with the solder point on the board (see CPU board page 28).
Programs are not saved. Only program 0 is available.	<ol style="list-style-type: none"> 1. Bug in program mode. Only way to bypass is to load minimum 1 program with a memory stick. 2. Need to load the latest software.
Infrared Halogen lamp(s) do not work.	<ol style="list-style-type: none"> 1. Contactor inoperative. 2. Lamp(s) broken. 3. Lamp holder broken. 4. Wiring loose.
Infrared Halogen lamps do not shut off.	<ol style="list-style-type: none"> 1. Contactor inoperative. 2. Power and I/O board malfunction. Also check relay X11.
Error 11. See also extra explanation on page 53.	<ol style="list-style-type: none"> 1. PT sensor malfunction. 2. Wiring PT sensor shortened.
Error 33. See also extra explanation on page 53.	<ol style="list-style-type: none"> 1. PT sensor malfunction. 2. Wiring PT sensor loose.
Error 55. See also extra explanation on page 53 and 57.	<ol style="list-style-type: none"> 1. Contactor malfunction. 2. P.T. sensor malfunction. 3. Heating elements malfunction. See also page 53 and 58. 4. Safety thermostat malfunction. 5. or software older than V.1.03.07: Setting of temperature in cooking program is too high. Set temperature on "normal value". Load latest software. 6. Parameter setting of "temp.grad" is not on value 3. (see page 51)
Error 66. See also extra explanation on page 53.	<ol style="list-style-type: none"> 1. Relay K3 not in place. 2. Relay K3 malfunction. 3. Model is older than serial nr.100067527 (has no relay K3). 4. Parameter "thermistor" is set on "yes" in a model older than serial nr. 100067527.
Error 77. See also extra explanation on page 53.	<ol style="list-style-type: none"> 1. Check heat number in cooking program. 2. Cooking program malfunction. Erase program, create new program, run a reference batch and run a second batch for verification.
Error 88. See also extra explanation on page 53.	<ol style="list-style-type: none"> 1. Check heat number in cooking program. 2. Heating element malfunction. 3. Cooking program malfunction. Erase program, create new program, run a reference batch and run a second batch for verification.
Application error. See also extra explanation on page 53. A: No standard screen when switching on. B: APP. error on screen.	<ol style="list-style-type: none"> A1. Make a complete reset by pulling out the plug for 1 sec. A2. CPU board malfunction. B1. Memory stick failure. B2. For communication failure load latest software version (solved in V1.03.08 or higher).

TROUBLESHOOTING FOR THE TDW 5 AND 7 P WARMERS

Symptom	Possible causes
No power to warmer controls.	<ol style="list-style-type: none"> 1. Main breaker open. 2. Switch malfunction. 3. Wiring loose.
Main fuse or breaker blows.	<ol style="list-style-type: none"> 1. Wiring incorrectly. 2. Heating element or blower shorted. 3. Wiring shorted.
Blower motor does not run.	<ol style="list-style-type: none"> 1. Capacitor malfunction. 2. Wiring loose. 3. Motor inoperative.
Lamps do not operate.	<ol style="list-style-type: none"> 1. Lamp malfunction. 2. Switch malfunction. 3. Wiring loose.
Oven temperature does not reach desired temperature.	<ol style="list-style-type: none"> 1. Incorrect line voltage. 2. Heater(s) inoperative. 3. Thermometer malfunction. 4. Thermostat malfunction. 5. Thermostat probe not in right place. 6. Blower motor inoperative (turning direction?) 7. Dirty fanguard or fanblade.
Products dry out too fast.	<ol style="list-style-type: none"> 1. No water in tray.
No indication on the display.	<ol style="list-style-type: none"> 1. Display malfunction.

ERROR 55 EXPLANATION

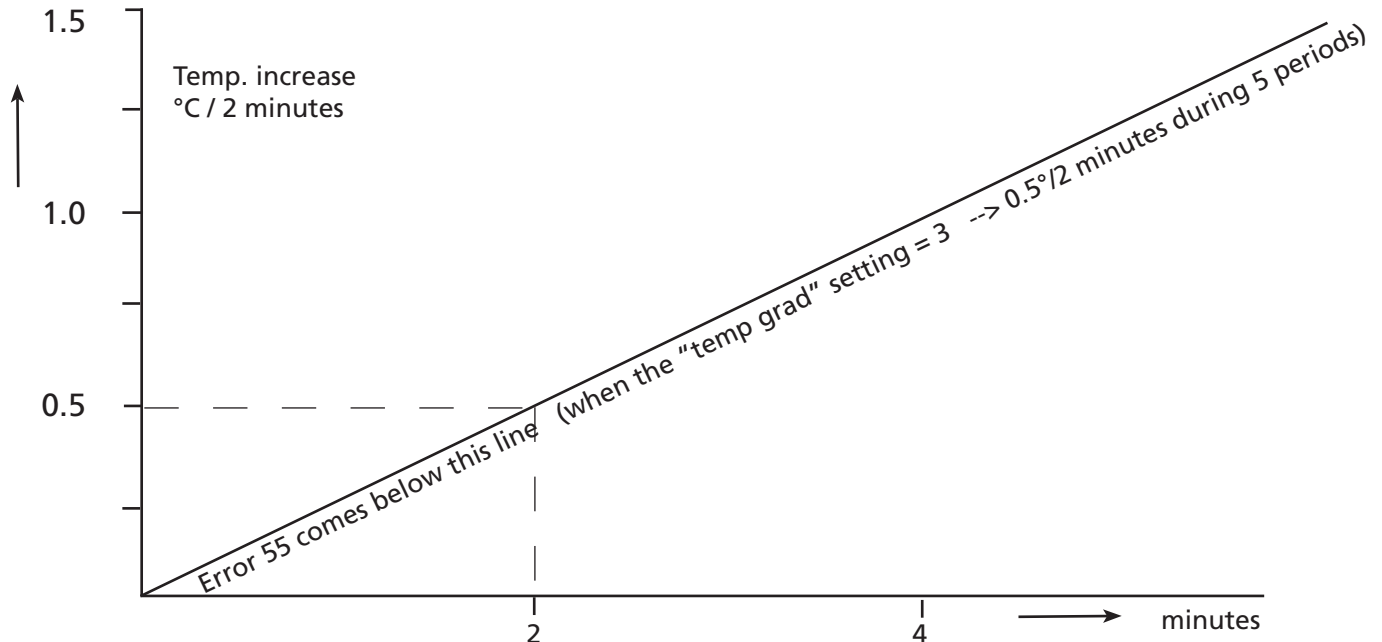

- Note:
1. Measuring starts 5 minutes after beginning of a heating step.
 2. Duration is 5 periods of 2 minutes.
 3. Measuring stops at 150°C/302°F or when temp. in cabinet is < 30°C than the set temperature.

Necessary line currents:

TDR8 with neutral 3x 16A. Without neutral 3x 27A.

TDR5 with neutral 3x 8,5A. Without neutral 3x 14A.

Possible cause	Caused by	Explanation	Solution
Energy supply problem	Broken contactor	One or more contacts broken, no current	Replace contactor
		Broken coil, contactor does not kick in	Replace contactor
	Missing phase	No current in one or two phases	Check mains connections and customer fuses
	Broken heating element	No current to one or more heating elements	Replace heating element
		Short circuit in heating element	Replace heating element
	Low supply Voltage	Low voltage results in low current	Check line voltage and currents.
	Hi-limit thermostat	Not adjusted to it's maximum	Fully turn clock-wise (cw)
		Broken thermostat.	Replace thermostat
Broken temperature sensor	Sensor gives a wrong value	Replace sensor	
Wrong setting of "temp grad" parameter	Default setting is 3, --> 0,5° per 2 minutes	Check setting	
Too much energy absorption	Products are stuffed with a very humid substance		Put "temp grad" setting on 2 or 1.

ANALYTIC TROUBLESHOOTING LIST

SERVICING AND REPAIRING THE TDR 5 AND 7 P ROTISSERIES

This is an analytic description for servicing and repairing all major parts of the rotisseries and warmers. It consists off 4 basic steps to recognize and solve the problems. These steps are:

1. Symptoms.
2. Possible causes.
3. Solving of the problem: checking/action.
4. Replacing of parts and testing.
 - a. Replacing is described in the service manual.
 - b. For testing see programming of rotisserie on page 7 in this manual.

Description of part	Symptoms	Possible causes	Solving: checking/action
Inside door	Broken glass	Slamming of door. Fastening bolts and nuts are loose. No PTFE ring between steel and glass.	Give instruction to operator. Tighten all fastenings. Mount new glass with PTFE rings between glass and steel.
Outside door	Broken glass Door adjustment	Slamming of door. Fastening bolts and nuts are loose. No PTFE ring between steel and glass. Door not well adjusted and closes against bottom side.	Give instruction to operator. Tighten all fastenings. Mount new glass with PTFE rings between glass and steel. Adjust door on hinge and tighten the hinge plate.
Heating element	Rotisserie doesn't reach adjusted temperature Duration of grilling time is too long	Wiring. Element malfunction. Wiring. Element malfunction.	Check the wiring. Check the power on the element. Check the current with AC current tester. See table on page 52. Check the wiring. Check the current with AC current tester. See table on page 52.
Thermostat	Contactors doesn't come in after starting of program Contactors switches off before reaching the adjusted temperature in program	Wiring. Thermostat malfunction. Thermostat malfunction. Thermostat probe not in right position.	Check the wiring. Check if the thermostat is making contact. Check if the thermostat is turned fully clockwise (contact closed). Check the position of the thermostat probe.

Description of part	Symptoms	Possible causes	Solving: checking/action
Safety thermostat	<p>Contactator does not come in after starting of program</p> <p>Contactator switches off before reaching the adjusted temperature in program</p>	<p>Wiring.</p> <p>Thermostat malfunction.</p> <p>Thermostat malfunction.</p> <p>Thermostat probe not in right position.</p>	<p>Check the wiring.</p> <p>Check if the thermostat is making contact.</p> <p>Check if the thermostat is turned fully clockwise (contact closed).</p> <p>Check the position of the thermostat probe.</p>
PT-sensor	<p>Temperature indication on display of 317°C / 603°F</p> <p>Temperature indication on display does not go up</p> <p>Rotisserie does not reach adjusted temperature</p> <p>Temperature indication on display runs up too fast</p>	<p>No connection between wires.</p> <p>Full contact between wires of sensor.</p> <p>Short circuit in sensor.</p> <p>Malfunction sensor.</p> <p>Sensor not in right position.</p> <p>Malfunction Sensor</p>	<p>Check the wiring.</p> <p>Check thin wire on sensor.</p> <p>Check the wiring.</p> <p>Measure resistance of sensor. This is zero.</p> <p>Measure resistance of sensor with a thermometer probe next to the sensor. See table in this manual.</p> <p>Check position of sensor</p> <p>Measure resistance of sensor. See table on page 53.</p>
Contactator	<p>Contactator doesn't come in</p> <p>Contactator comes in, but one or more functions don't come in</p>	<p>Wiring.</p> <p>Coil malfunction.</p> <p>Contact burned.</p>	<p>Check the wiring.</p> <p>Check resistance of the coil. This should be 525Ω. See table on page 52.</p> <p>Check the wiring.</p> <p>Check the power on all contacts.</p> <p>Check the contacts of the contactator.</p>
Capacitor	Drive motor or blower don't work	<p>Wiring.</p> <p>Capacitor malfunction.</p>	<p>Check the wiring.</p> <p>Check function after connecting a new capacitor.</p> <p>Checking of capacitor: Discharge capacitor with screwdriver. Set meter on MΩ and connect the pins of the meter on contacts, value runs up. Change the pins on contacts, value runs up again. This means the capacitor is OK.</p>

Description of part	Symptoms	Possible causes	Solving: checking/action
Keypad(s) on operation panel	No possibility to make a program	One or more keys don't function. No response on all keys.	Check functions of keypad(s), see "function" parameter in service menu. Check flat cable connection between CPU board and keypad. Check flat cable. Check if keypad is correctly glued to the glass. Remove plug from socket and connect again (reset of key sensitivity). Check flat cable connection between CPU board and keypad. Check flat cable. Check if keypad is correctly glued to the glass.
Display/CPU on operation panel and power I/O board	No illumination on display One or more functions don't work or stay activated. Display shows strange things.	Wiring. Fuse burned. Flat cable. Display/CPU malfunction. Power board malfunction. Relay malfunction. Parameters not on right settings. Wrong software or loss of data.	Check the wiring. Check the power on the CPU board by the 2 flashing red LED's just near the flatcable on the power and I/O board. Check the 125 mA fuse on the power I/O board. Check the fuse F1 and F3. Check grey flat cable connection. Check functions after connecting a new grey flat cable. Check functions after installing a new CPU board with display. Check functions after installing a new power I/O board. Check relay on function with problem. Check parameters. Check software version or upload latest software.

Description of part	Symptoms	Possible causes	Solving: checking/action
Drive motor	<p>Motor doesn't run</p> <p>Motor runs after starting it up by hand</p> <p>Motor stops during process and comes in again after a period of time</p> <p>Main fuse burned</p>	<p>Wiring.</p> <p>Coil malfunction. See also table on page 52.</p> <p>Reduction gearbox.</p> <p>Capacitor malfunction.</p> <p>Coil overheated, thermostat switches off (105°C – 221°F).</p> <p>Short circuit in coil to ground.</p>	<p>Check the wiring.</p> <p>Check the power to the motor.</p> <p>Check resistance of the coils. Between whiteA and white wire 234Ω.</p> <p>Between whiteA and brown wire 117Ω.</p> <p>Between white and brown wire 117Ω.</p> <p>Check if reduction gearbox is blocked.</p> <p>Check capacitor (see capacitor) or connect new capacitor.</p> <p>Check position of fan blade. Air is sucked up over the motor.</p> <p>Check cooling circuit of motor.</p> <p>Check if rotisserie is close to another heat source.</p> <p>Measure temperature motor during process.</p> <p>Check insulation value of coil with Megger on 500V. Minimum value is 0.5 MΩ.</p>
<p>Blower</p> <p>Note: Until serial number 100062182 this blower is executed with a 8 uF capacitor due to the minimum RPM. The blower in the rotisseries after 100062182 have adapted coils and 6 uF capacitor. The RPM now are minimum 2500.</p>	<p>Blower doesn't run</p> <p>Blower runs after starting it up by hand</p> <p>Blower stops during process and comes in again after a period of time</p> <p>Temperature indication on display runs up very fast (180°C - 355°F after 5 minutes)</p> <p>Main fuse burned</p>	<p>Wiring.</p> <p>Coil malfunction. See also table on page 52.</p> <p>Capacitor malfunction.</p> <p>Coil overheated, thermostat switches off (140°C – 284°F).</p> <p>Blower doesn't turn and heat stays in top of cavity.</p> <p>Short circuit in coil to earth.</p>	<p>Check the wiring.</p> <p>Check the power on the blower.</p> <p>Check resistance of the coils. Between black and red wire 65Ω.</p> <p>Between black and blue wire 35Ω.</p> <p>Between red and blue wire 30Ω.</p> <p>Check capacitor (see capacitor) or connect new capacitor.</p> <p>Check cooling circuit of blower.</p> <p>Check if rotisserie is close to another heat source.</p> <p>Measure temperature blower during process.</p> <p>Check the wiring.</p> <p>Check the power on the blower.</p> <p>Check insulation value of coil with a Megger on 500V. Minimum value is 0.5 MΩ.</p>

SERVICING AND REPAIRING THE TDW 5 AND 7 P WARMERS

Description of part	Symptoms	Possible causes	Solving: checking/action
Outside door	Broken glass.	Slamming of door. Fastening bolts and nuts are loose. No PTFE ring between steel and glass.	Give instruction to operator. Tighten all fastenings. Mount new glass with PTFE rings between glass and steel.
	Door adjustment.	Door not well adjusted and closes against bottom side.	Adjust door on hinge and tighten the hinge plate.
Heating element	Warmer doesn't reach adjusted temperature.	Wiring.	Check the wiring. Check the power on the element.
		Element malfunction.	Check the current with AC current tester. See table on page 52.
Thermostat	Warmer doesn't reach adjusted temperature.	Wiring. Thermostat malfunction.	Check the wiring. Check if the thermostat is making contact. Check the position of the thermostat probe.
	Warmer doesn't heat up.	Thermostat malfunction.	Check if the drive shaft behind the main switch is connected on the thermostat. Check if the thermostat is making contact.
Thermometer	Temperature indication differs from setting with knob.	Thermometer malfunction	Check the position of the thermometer probe. Check function after connecting a new thermometer.
Main switch	No power to all, or some oven controls.	Wiring.	Check the wiring.
		Malfunction of the cams on the switch.	Check the cams.
		Contacts burned.	Check the contacts on the switch.

Description of part	Symptoms	Possible causes	Solving: checking/action
Capacitor	Drive motor or blower doesn't work.	Wiring. Capacitor malfunction.	Check the wiring. Check function after connecting a new capacitor. Checking of capacitor: Discharge capacitor with screwdriver. Set meter on MΩ and connect the pins of the meter on contacts, value runs up. Change the pins on contacts, value runs up again. This means the capacitor is OK.
Blower	Blower doesn't run. Blower runs after starting it up by hand. Blower stops during process and comes in again after a period of time.	Wiring. Coil malfunction. Capacitor malfunction. Coil overheated, thermistor switches off (150°C – 302°F).	Check the wiring. Check the power on the blower. Check resistance of the coils. See also table on page 52. Between blue and brown wire= 310Ω Between blue and black wire= 320Ω Between brown and black wire= 630Ω Check capacitor (see capacitor), or connect new capacitor. Check cooling circuit of blower. Check if warmer is close to another heat source. Measure temperature blower during process.
	Fuse burned.	Short circuit in coil to earth.	Check insulation value of coil with a Megger on 500V. Minimum value is 0.5 MΩ.

EMPTY PAGE

EXPLODED VIEWS & PARTLISTS

TDR 5 P - SHEET METAL WORK

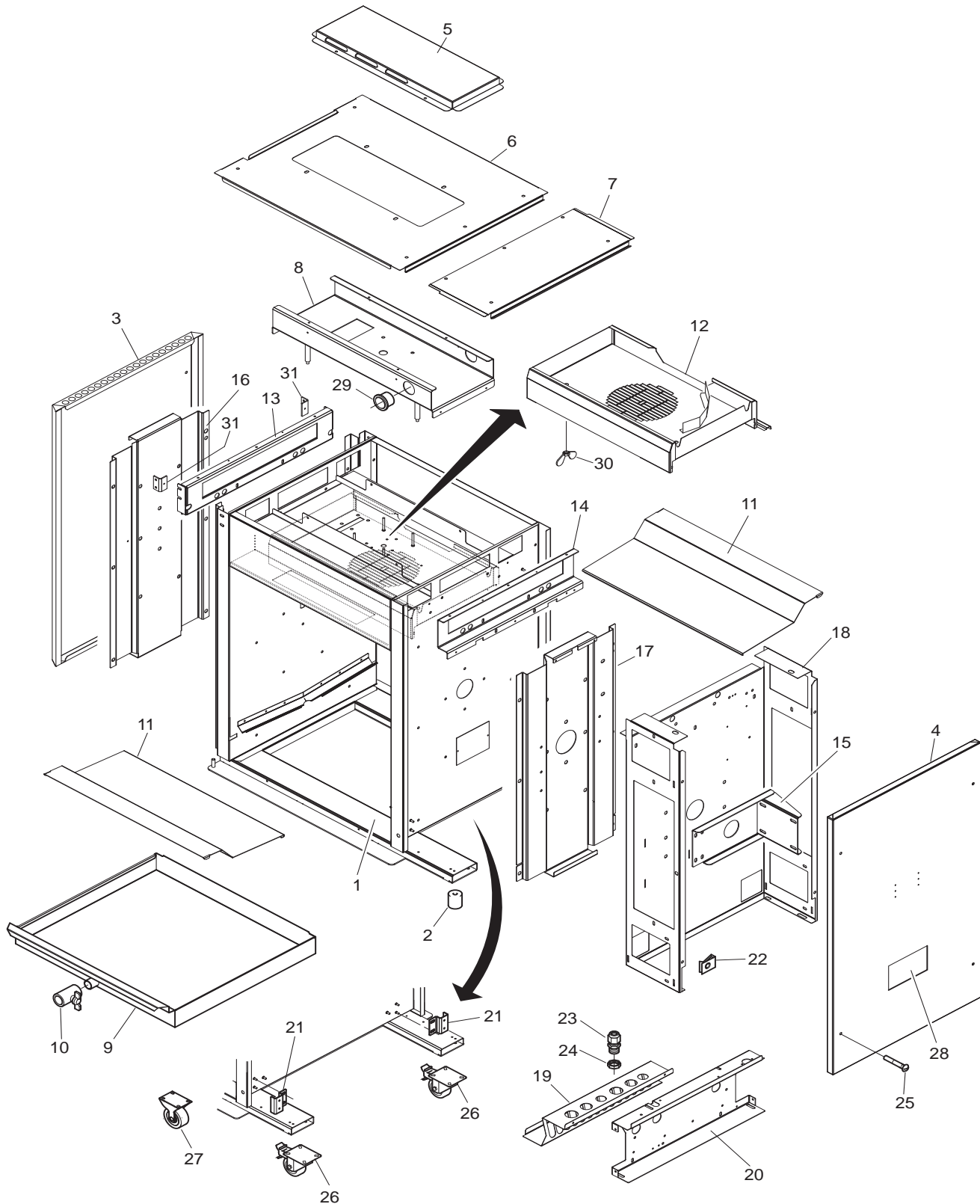

Item	Part number	Qty.	Description
1	1	Frame, ass.
2	9171125	4	Leg, rubber 50 mm
3	9294353	1	Side panel, left
3A	9294126	1	Side panel, left (till serial nr. 100061480)
4	9294352	1	Side panel, right
4A	9294125	1	Side panel, right (till serial nr. 100061480)
5	9294160	1	Top cover
6	9294350	1	Top plate
6A	9294127	1	Top plate (till serial nr. 100061480)
7	9294351	1	Cover, removeable
7A	9294128	1	Cover, removeable (till serial nr. 100061480)
8	9290450	1	Mounting plate, blower
9	9290476	1	Drawer
9A	9290456	1	Drawer (till serial nr. 100061480)
10	9171008	1	Drain-tap with handle
11	9294354	2	Bottom plate, stainless steel
11A	9294116	2	Bottom plate, stainless steel (till serial nr. 100061480)
12	9290458	1	Cover plate, blower.
13	9294356	1	Side plate, left
13A	9294110	1	Side plate, left (till serial nr. 100061480)
14	9294357	1	Side plate, right
14A	9294112	1	Side plate, right (till serial nr. 100061480)
15	9170444	1	Support, gear motor
16	9294109	1	Reinforcement, side plate, left
17	9294111	1	Reinforcement, side plate, right
18	9294360	1	Cover plate, machine components
18A	9294119	1	Cover plate, machine components (till serial nr. 100061480)
19	9294370	1	Spark catcher
19A	9294121	1	Spark catcher (till serial nr. 100061480)
20	9294361	1	Mounting plate
20A	9294120	1	Mounting plate (till serial nr. 100061480)
21	9294381	1	Bracket, door switch
21A	9294065	1	Bracket, door switch (till serial nr. 100061480)
22	9172053	8	Nut
23	9261022	1	Strain relief M25
24	9261023	1	Connector M25
25	4288322	8	Screw M5 x 10
26	9172066	2	Swivel castor with brake (only for stacked units)
27	9172065	2	Swivel castor without brake (only for stacked units)
28	9123492	1	Indication plate
29	9171015	2	Grommet, plastic
30	2800082	2	Wing nut M6
31	9174154	2	Adjusting bracket

TDR 5 P - COMPONENTS

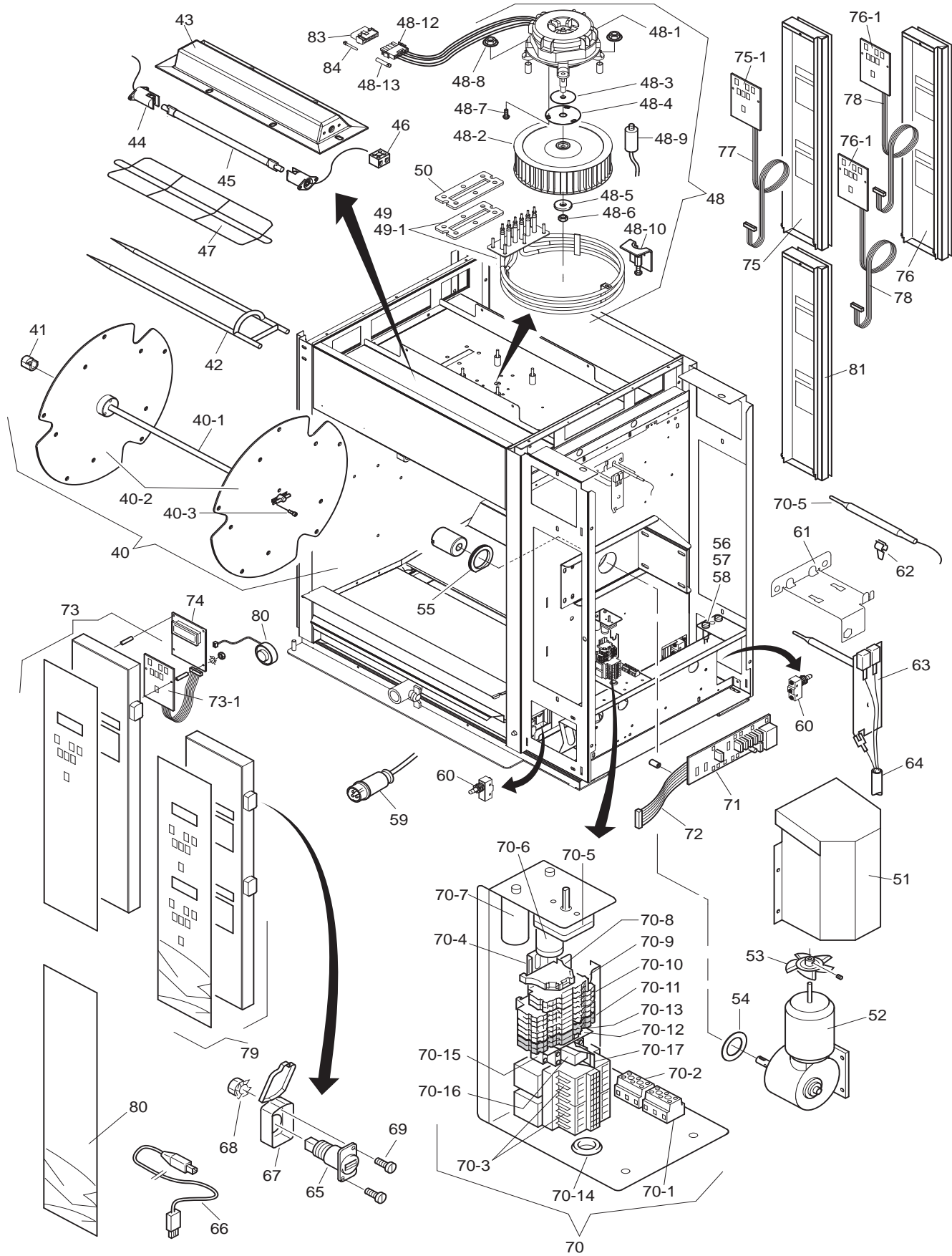

Item	Part number	Qty.	Description
40	9146951	1	Rotorset ass., stainless steel
40-1	9170571	1	Rotor shaft
40-2	9174369	2	Rotor disc 3 mm
40-3	0142975	6	Socket head screw M6 x 20 SS
41	9172062	1	Steel bearing 14 mm
42	9010549	5	Meatfork, stainless steel
43	9294463S	2	Light fixture + end plate L and R
44	9052826	4	Lamp holder
45	9291001	2	Infrared Halogen lamp 500W
46	2300121	2	Terminal block, ceramic
47	9292061	2	Protection guard, infrared lamp
48	9298550S	1	Blower, ass.
48-1	9293020	1	Blower motor
48-2	3701218	1	Turbine Ø 200 mm x 43
48-3	3702325	1	Sealing, blower shaft, PSS
48-4	9294007	1	Washer plate
48-5	0142103	1	Washer M5
48-6	0142315	1	Nut M5
48-7	4288232	3	Srew M5x12
48-8	4285092	4	Nut M6
48-9	9192034	1	Capacitor 6 uF
48-10	9290487	1	Pully, for removing turbine
48-11	9293021	1	Conversion cable 3 to 5-pole
48-12	3701272	1	Plug, 5-pole M-N-L, universal
48-13	0601458	5	Socket, female M-N-L
49	9292029S	1	Heating element 208 V, 5.4 KW, ass.
49-1	9194489	1	Gasket, heating element
50	9194501	1	Fastening plate
51	9294419	1	Protection support
52	9293001S	1	Gearmotor, complete with drive head
53	9172078	1	Fanblade Ø 150 mm, gearmotor
54	9110797	1	Sealring, drive head
55	9073131	1	Sealing ring, Teflon
56	...	1	Fuse holder plate
57	9044205	2	Fuse holder
58	9110250	2	Fuse SC10, 10A
59	9172404	1	Connecting cable with plug15-30P
60	3701233S	2	Door switch
61	9294075	1	Bracket temperature sensors
62	9110072	2	Clip
63	9172310	1	Temperature sensor PT 1000
64	9044140	1	Sensor cable
65	9291011	1	USB adapter
66	9291012	1	USB cable
67	9291010	1	Cover USB adapte
68	4285010	2	Nut M3
69	0141050	2	Screw M3x10
70	9290215	1	Electric panel, ass.
70-1	9044564	1	Connecting block, 1,2,3

Item	Part number	Qty.	Description
70-2	9044572	1	Connecting block, 4,5,6
70-3	3500069	1	Contactora
70-4	9077088	2	Rail
70-5	9040970	1	Safety thermostat
70-6	9192034	1	Capacitor 6 uF
70-6A	9291015	1	Capacitor 8 uF (till serial nr. 100062182)
70-6B	3701274	1	Capacitor 5 uF (till serial nr. 100060887)
70-7	9077101	1	Capacitor 2.5 uF
70-7A	9077102	1	Capacitor 3 uF (till serial nr. 100061450)
70-8	9191222	2	End clamp
70-9	9191232	2	Rail terminal, 2p grey
70-10	9191240	7	Rail terminal, 4p grey
70-12	9191223	1	Endcap, terminal
70-13	9191237	1	Connecting bridge, 3p
70-14	9070840	1	Grommet
70-15	9261032	1	Socket for relay
70-16	9261031	1	Relay
70-17	9261030	1	Clamp
71	9192202	1	Power & I/O board
72	9172314	1	Flat cable, 14 pins
73	9298520	1	Operation panel, ass. Glass + backplate + keypad with short flatcable
73-1	9292041	1	Keypad + short flatcable
74	9292040S	1	CPU board + LCD
75	9298522	1	Panel, customer side, ass. Glass + backplate + keypad with short flatcable
75-1	9292041	1	Keypad + flatcable
76	9298525	1	<i>Panel, customer side, ass. Glass + backplate + keypads with short flatcables. For stacked models only</i>
76-1	9292041	2	<i>Keypad + short flatcable For stacked models only</i>
77	9292044	1	Extended flatcable 1100 mm.
78	9292044	2	<i>Extended flatcable 1100 mm. For stacked models only</i>
79	9298523	1	<i>Operation panel, ass. Glass + backplate + keypads with short flatcables. For stacked models only</i>
80	9298526	1	<i>Panel, operation side, bottom side, ass. Glass + backplate. For stacked models only</i>
81	9298521	1	<i>Panel, customer side, bottom side, ass. Glass + backplate. For stacked models only</i>
82	9172362	1	<i>Buzzer 12V, separate connection for service</i>
83	9291014	1	Cap, 5-pole M-N-L
84	0601466	5	Pin, male M-N-L

TDR 5 P - DOORS

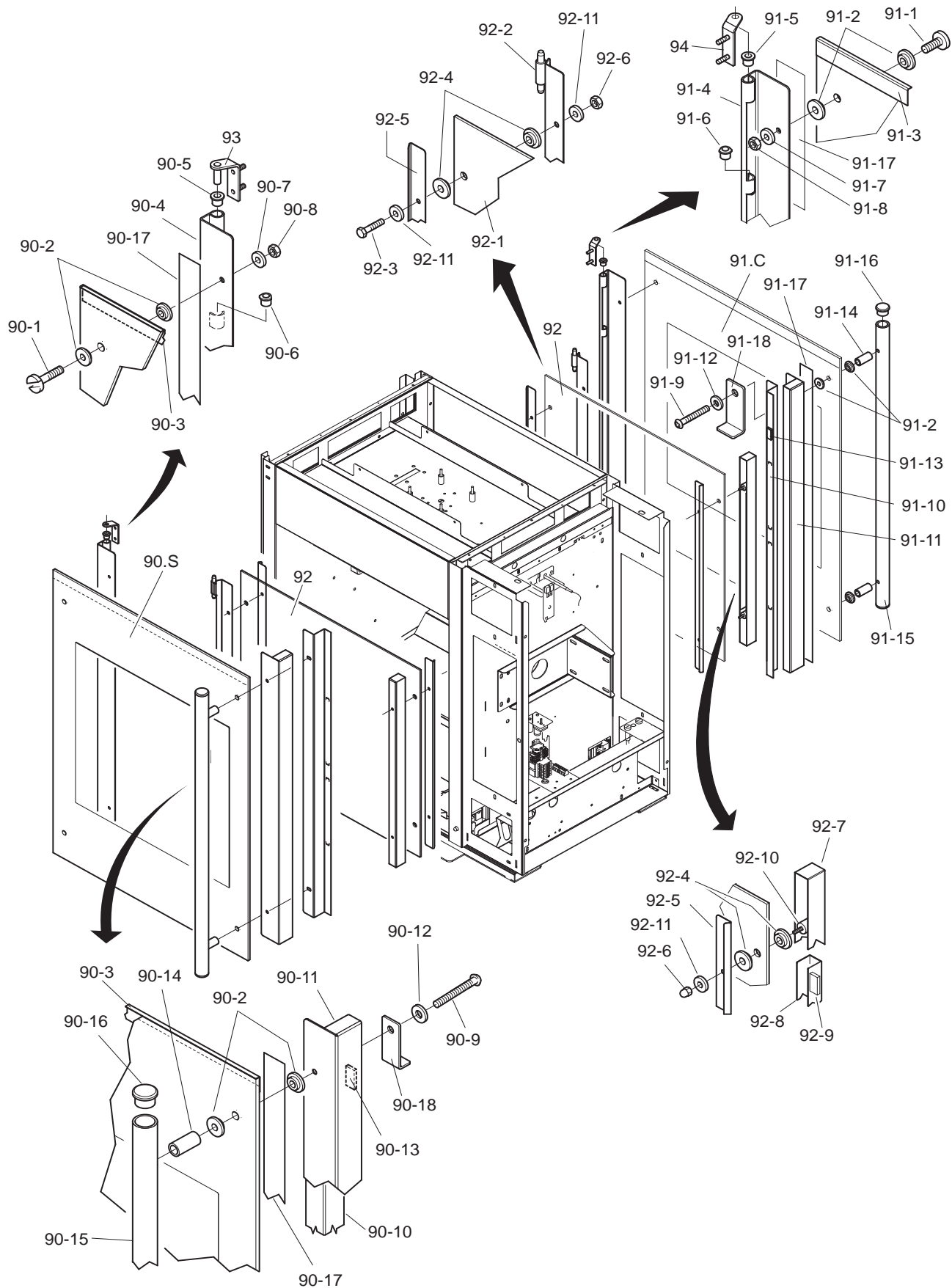

Item	Part number	Qty.	Description
90.5	92985005	1	Door service side, ass.
90-1	4280558	2	Screw M5 x 16 SS
90-2	3702342	8	Flange bush, PTFE 3 mm
90-3	9294149	1	Protection profile
90-4	9294135	1	Hinge profile
90-5	9172054	2	Brass bearing 8 mm
90-6	9172122	2	Brass bearing 8 mm, adjusted
90-7	4311110	2	Washer M5
90-8	0144359	2	Nut M5, self locking
90-9	4288059	2	Bolt M5 x 50 SS
90-9A	4288320	2	Screw, pan head, M5 x 50 SS (till ser.nr.100068523)
90-10	9294137	1	Fastening, door handle
90-11	9294136	1	Magnet holder profile
90-12	9174680	2	Washer
90-13	9070141	10	Magnet block
90-14	9293010	2	Spacing pin
90-15	9293009	1	Door handle
90-16	2103209	2	Plug, door handle
90-17	4302141	2	Tape 20 x 0.8
90-18	9294229	1	Blocking bracket
91.C	92985035	1	Door customer side, ass.
91-1	4280558	2	Screw M5 x 16 SS
91-2	3702342	8	Flange bush, PTFE 3 mm
91-3	9294149	1	Protection profile
91-4	9294135	1	Hinge profile
91-5	9172054	2	Brass bearing 8 mm
91-6	9172122	2	Brass bearing 8 mm, adjusted
91-7	4311110	2	Washer M5
91-8	0144359	2	Nut M5, self locking
91-9	4288059	2	Bolt M5 x 50 SS
91-9A	4288320	2	Screw, pan head, M5 x 50 SS (till ser.nr.100068523)
91-10	9294137	1	Fastening, door handle
91-11	9294136	1	Magnet holder profile
91-12	9174680	2	Washer
91-13	9070141	12	Magnet block
91-14	9293010	2	Spacing pin
91-15	9293009	1	Door handle
91-16	2103209	2	Plug, door handle
91-17	4302141	2	Tape 20 x 0.8
91-18	9294229	1	Blocking bracket

Item	Part number	Qty.	Description
92	92985025	2	Door inside, ass.
92-1	9292011	2	Glass, inside door
92-2	9290457	2	Hinge profile
92-3	9191050	4	Bolt M5 x 18 SS, hexagon head
92-4	3702341	16	Flange bush, PTFE 2 mm
92-5	9294139	4	Cover profile
92-6	0142315	8	Nut M5 SS
92-7	9294140	2	Holder, magnet
92-8	9294141	2	Profile
92-9	9070141	16	Magnet block
92-10	9172291	4	Spacing pin
92-11	9174680	12	Washer
93	9290409	1	Hinge, left
94	9290410	1	Hinge, right

TDR 7 P - SHEET METAL WORK

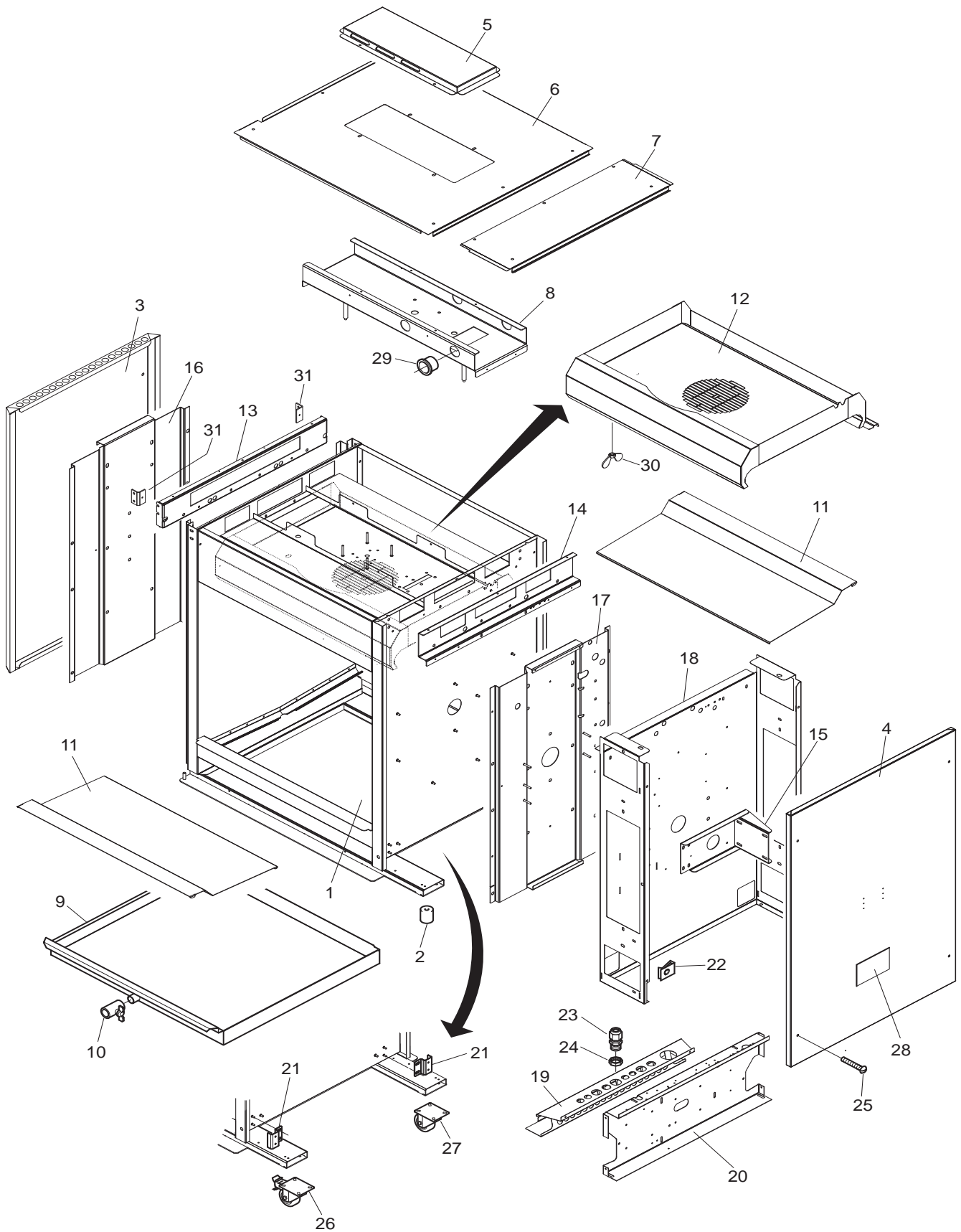

Item	Part number	Qty.	Description
1	1	Frame, ass.
2	9171125	4	Leg, rubber 50 mm
3	9294180	1	Side panel, left
4	9294018	1	Side panel, right
5	9294160	1	Top cover
6	9294032	1	Top plate
7	9294045	1	Cover, removeable
8	9290401	1	Mounting plate, blower
9	9290405	1	Drawer
10	9171008	1	Drain-tap with handle
11	9294014	2	Bottom plate, stainless steel
12	9290411	1	Cover plate, blower
13	9294011	1	Side plate, left
14	9294030	1	Side plate, right
15	9290444	1	Support, gear motor
16	9294028	1	Reinforcement, side plate, left
17	9294029	1	Reinforcement, side plate, right
18	9294026	1	Cover plate, machine components
19	9294019	1	Spark catcher
20	9294025	1	Mounting plate
21	9294065	2	Bracket, door switch
22	9172053	8	Nut
23	9261022	1	Strain relief M25
24	9261023	1	Connector M25
25	4288322	8	Screw M5 x 10
26	9172066	2	Castor with brake (only for stacked units)
27	9172065	2	Castor without brake (only for stacked units)
28	9123492	1	Indication plate
29	9171015	2	Grommet, plastic
30	2800082	2	Wingnut M6
31	9174151	2	Adjusting bracket

TDR 7 P - COMPONENTS

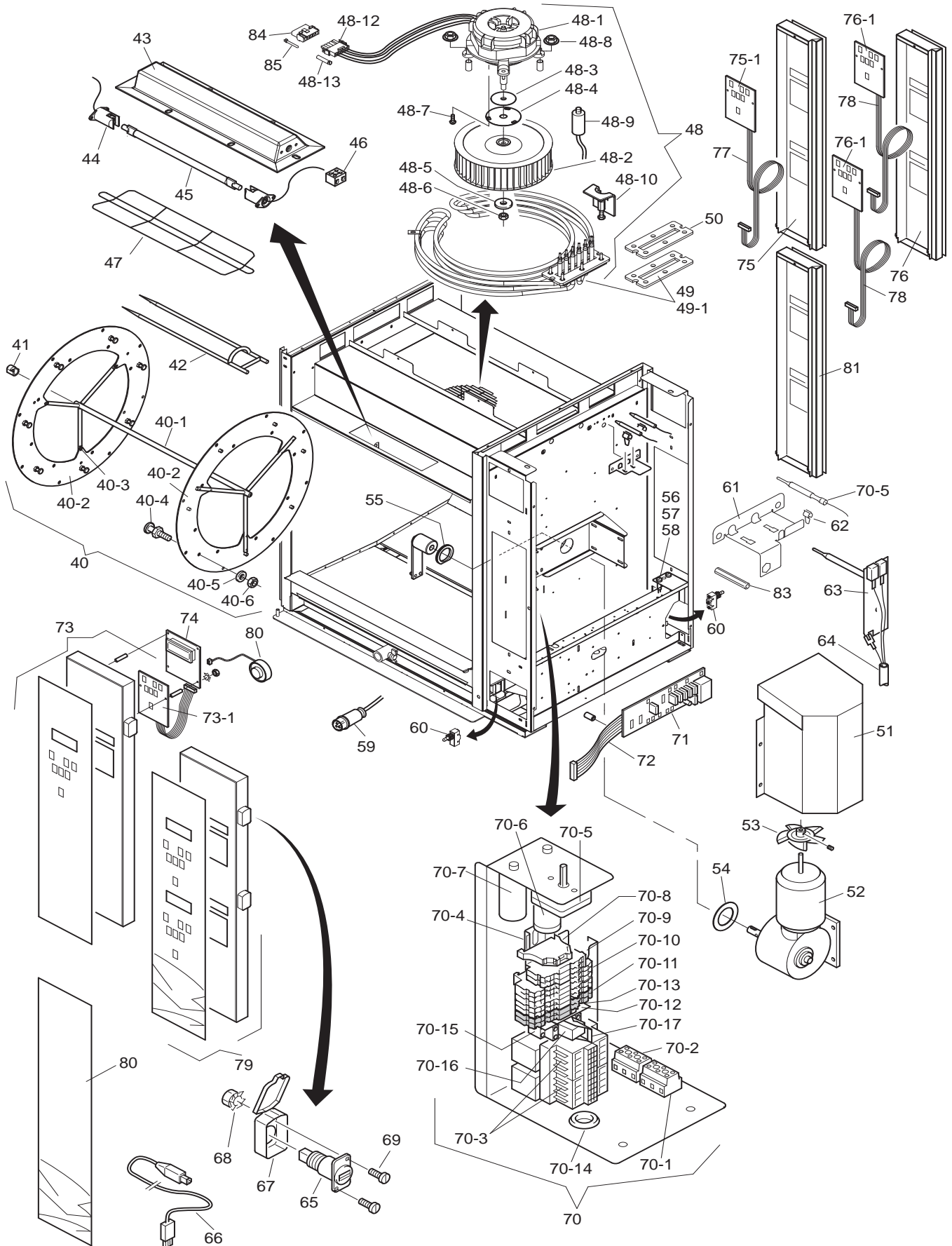

Item	Part number	Qty.	Description
40	9172274	1	Rotorset ass. 8 meat forks, stainless steel
40-1	9070272	1	Rotor shaft
40-2	9174623	2	Rotor disc 3 mm
40-3	4288231	12	Tensilock bolt M5 x 10
40-4	9172169	14	Support pin
40-5	0142056	14	Spring washer M8
40-6	0141547	14	Nut M8
41	9172063	1	Steel bearing 14 mm
42	9172153	8	Meatfork 8 mm SS
43	9294463S	2	Light fixture + end plate L and R
44	9052826	4	Lamp holder
45	9291001	2	Infrared Halogen lamp 500W
46	2300121	2	Terminal block, ceramic
47	9292061	2	Protection guard, infrared lamp
48	9298551S	1	Blower, ass.
48-1	9293020	1	Blower motor
48-2	3701273	1	Turbine Ø 200 mm x 61
48-3	3702325	1	Sealing, blower shaft, PSS
48-4	9294007	1	Washer plate
48-5	0142103	1	Washer M5
48-6	0142315	1	Nut M5
48-7	4288232	3	Srew M5x12
48-8	4285092	4	Nut M6
48-9	9192034	1	Capacitor 6 uF
48-10	9290487	1	Pully, for removing turbine
48-11	9293021	1	Conversion cable 3 to 5-pole
48-12	3701272	1	Plug, 5-pole M-N-L, universal
48-13	0601458	5	Socket, female M-N-L
49	9292028S	1	Heating element 208 V, 9.3 KW
49-1	9194489	1	Gasket, heating element
50	9194501	1	Fastening plate
51	9294421	1	Protection support
52	9293002S	1	Gearmotor, complete with drive head
53	9172078	1	Fanblade Ø 150 mm, gearmotor
54	9110797	1	Sealring, drive head
55	9073131	1	Sealing ring, Teflon
56	...	1	Fuse holder plate
57	9044205	2	Fuse holder
58	9110250	2	Fuse SC10, 10A
59	9172425	1	Connecting cable with plug 15-50P
60	3701233S	2	Door switch
61	9294069	1	Bracket temperature sensors
61A	9294063	1	Bracket temperature sensors. (Untill serial nr. 100060436)
62	9110072	2	Clip
63	9172310	1	Temperature sensor PT 1000
64	9044140	1	Sensor cable
65	9291011	1	USB adapter
66	9291012	1	USB cable
67	9291010	1	Cover USB adapte

Item	Part number	Qty.	Description
68	4285010	2	Nut M3
69	2105045	2	Screw M3x12
70	9290215	1	Electric panel, ass.
70-1	9044564	1	Connecting block, 1,2,3
70-2	9044572	1	Connecting block, 4,5,6
70-3	3500069	1	Contactora
70-4	9077088	2	Rail
70-5	9040970	1	Safety thermostat
70-6	9192034	1	Capacitor 6 uF
70-6A	9291015	1	Capacitor 8 uF (till serial nr. 100062182)
70-6B	3701274	1	Capacitor 5 uF (till serial nr. 100060887)
70-7	9077101	1	Capacitor 2.5 uF
70-7A	9077102	1	Capacitor 3 uF (till serial nr. 100061450)
70-8	9191222	2	End clamp
70-9	9191232	2	Rail terminal, 2p grey
70-10	9191240	7	Rail terminal, 4p grey
70-12	9191223	1	Endcap, terminal
70-13	9191237	1	Connecting bridge, 3p
70-14	9070840	1	Grommet
70-15	9261032	1	Socket for relay
70-16	9261031	1	Relay
70-17	9261030	1	Clamp
71	9192202	1	Power & I/O board
72	9172314	1	Flat cable L= 1100 mm, 14 pins
73	9298530	1	Operation panel, ass. Glass + backplate + keypad with short flatcable
73-1	9292041	1	Keypad + short flatcable
74	9292040S	1	CPU board + LCD
75	9298532	1	Panel, customer side, ass. Glass + backplate + short keypad with flatcable
75-1	9292041	1	Keypad + short flatcable
76	9298535	1	Panel, customer side, ass. Glass + backplate + keypads with short flatcables. For stacked models only
76-1	9292041	2	Keypad + short flatcable For stacked models only
77	9292044	1	Extended flatcable 1100 mm.
78	9292044	2	Extended flatcable 1100 mm. For stacked models only
79	9298533	1	Operation panel, ass. Glass + backplate + keypads with short flatcables. For stacked models only
80	9298536	1	Panel, operation side, bottom side, ass. Glass + backplate. For stacked models only
81	9298531	1	Panel, customer side, bottom side, ass. Glass + backplate. For stacked models only
82	9172362	1	Buzzer 12V, separate connection for service
83A	9172280	1	Distance bush (till ser.nr. 100060436)
84	9291014	1	Cap, 5-pole M-N-L
85	0601466	5	Pin, male M-N-L

TDR 7 P - DOORS

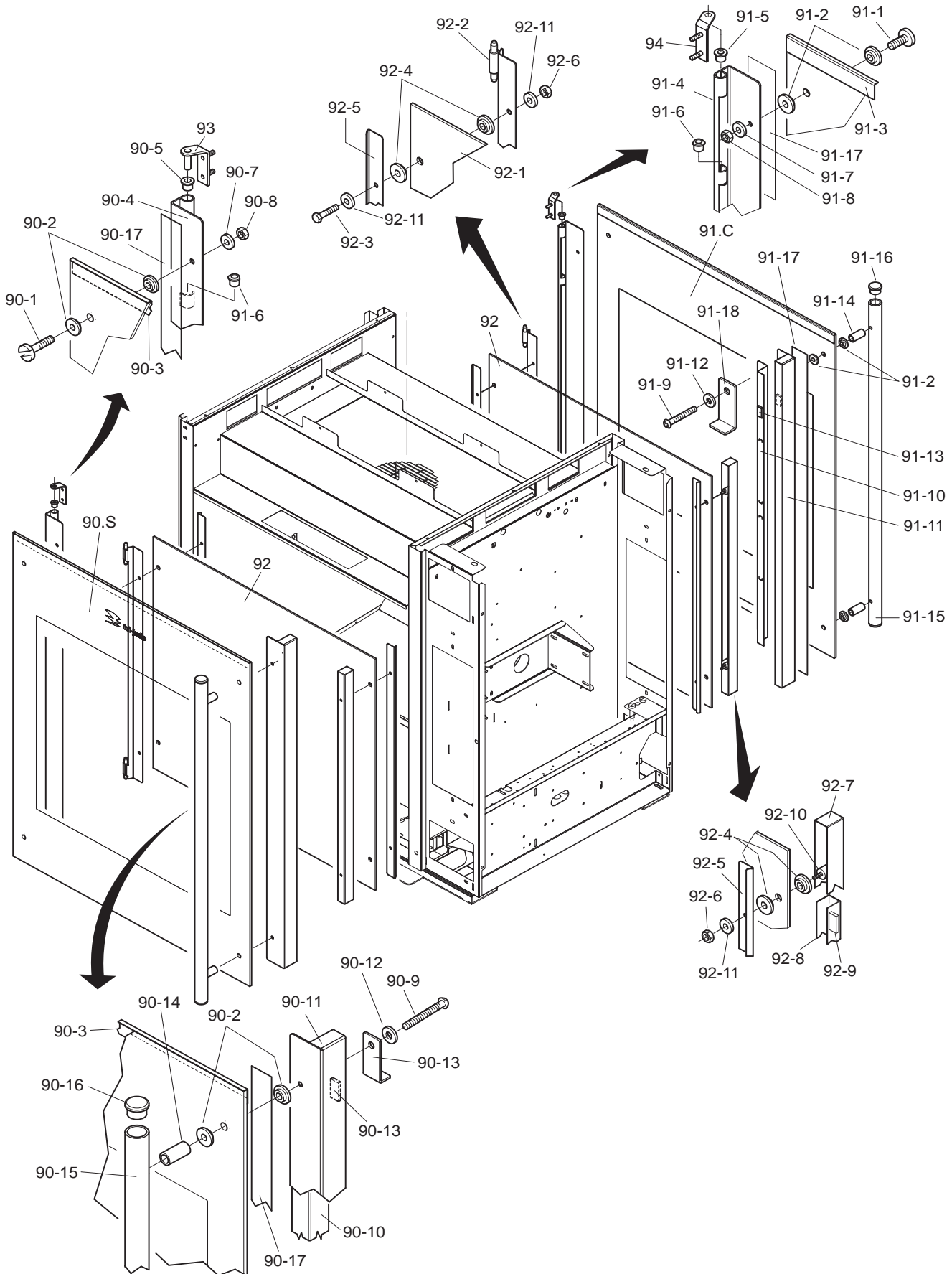

Item	Part number	Qty.	Description
90.S	9298510S	1	Door service side, ass.
90-1	4280558	2	Screw M5 x 16 SS
90-2	3702342	8	Flange bush, PTFE 3 mm
90-3	9294049	1	Protection profile
90-4	9294048	1	Hinge profile
90-5	9172054	2	Brass bearing 8 mm
90-6	9172122	2	Brass bearing 8 mm, adjusted
90-7	4311110	2	Washer M5
90-8	0144359	2	Nut M5, self locking
90-9	4288059	2	Bolt M5 x 50 SS
90-9A	4288320	2	Screw, pan head, M5 x 50 SS (till ser.nr.100068523)
90-10	9294035	1	Fastening, door handle
90-11	9294034	1	Magnet holder profile
90-12	9174680	2	Washer
90-13	9070141	12	Magnet block
90-14	9293010	2	Spacing pin
90-15	9293008	1	Door handle
90-16	2103209	2	Plug, door handle
90-17	4302141	2	Tape 20 x 0.8
90-18	9294229	1	Blocking bracket
91.C	9298513S	1	Door customer side, ass.
91-1	4280558	2	Screw M5 x 16 SS
91-2	3702342	8	Flange bush, PTFE 3 mm
91-3	9294049	1	Protection profile
91-4	9294048	1	Hinge profile
91-5	9172054	2	Brass bearing 8 mm
91-6	9172122	2	Brass bearing 8 mm, adjusted
91-7	4311110	2	Washer M5
91-8	0144359	2	Nut M5, self locking
91-9	4288059	2	Bolt M5 x 50 SS
91-9A	4288320	2	Screw, pan head M5 x 50 SS (till ser.nr. 100068523)
91-10	9294035	1	Fastening, door handle
91-11	9294034	1	Magnet holder profile
91-12	9174680	2	Washer
91-13	9070141	12	Magnet block
91-14	9293010	2	Spacing pin
91-15	9293008	1	Door handle
91-16	2103209	2	Plug, door handle
91-17	4302141	2	Tape 20 x 0.8
91-18	9294229	1	Blocking bracket

Item	Part number	Qty.	Description
92	9298512S	2	Door inside, ass.
92-1	9292013	2	Glass, inside door
92-2	9290406	2	Hinge profile
92-3	9191050	4	Bolt M5 x 18 SS
92-4	3702341	16	Flange bush, PTFE 2 mm
92-5	9294037	4	Cover profile
92-6	0142315	8	Nut M5 SS
92-7	9294038	2	Holder, magnet
92-8	9294039	2	Profile
92-9	9070141	20	Magnet block
92-10	9172291	4	Spacing pin
92-11	9174680	12	Washer
93	9290409	1	Hinge, left
94	9290410	1	Hinge, right

TDW 5 P - SHEET METAL WORK

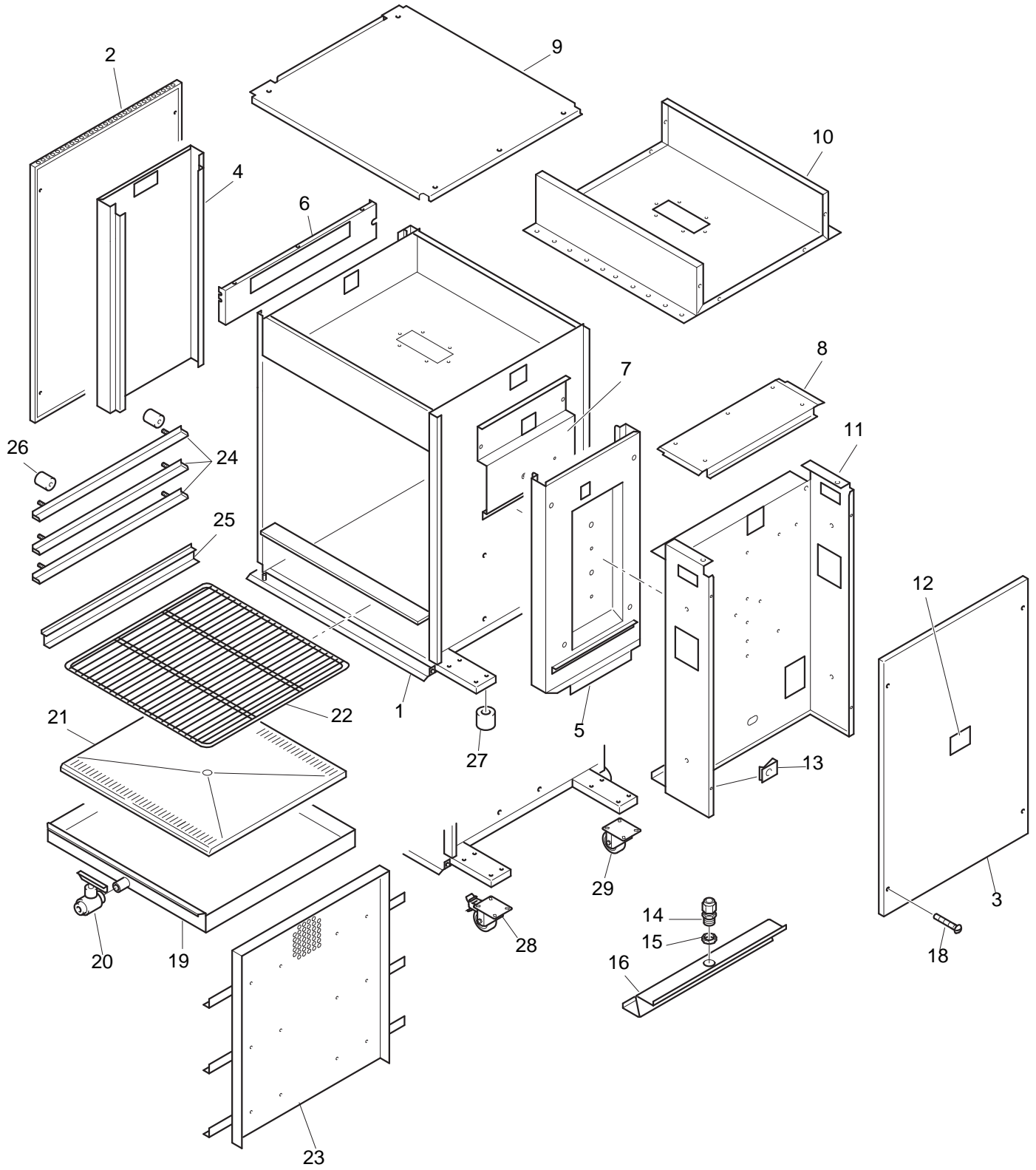

Item	Part number	Qty.	Description
1	1	Frame, ass.
2	9294353	1	Side panel, left
2A	9294126	1	Side panel, left (till serial nr. 100061480)
3	9294352	1	Side panel, right
3A	9294125	1	Side panel, right (till serial nr. 100061480)
4	9290492	1	Reinforcement plate, left
4A	9290510	1	Reinforcement plate, left (till serial nr. 100061480)
5	9290493	1	Reinforcement plate, right
5A	9290511	1	Reinforcement plate, right (till serial nr. 100061480)
6	9294359	1	Reinforcement, left top
6A	9294110	1	Reinforcement, left top (till serial nr. 100061480)
7	9294461	1	Reinforcement, right top
7A	9294280	1	Reinforcement, right top (till serial nr. 100061480)
8	9294351	1	Cover, removable
8A	9294128	1	Cover, removable (till serial nr. 100061480)
9	9294454	1	Top plate
9A	9294288	1	Top plate (till serial nr. 100061480)
10	9290494	1	Ceiling
10A	9290512	1	Ceiling (till serial nr. 100061480)
11	9294455	1	Cover plate, machine components
11A	9294287	1	Cover plate, machine components (till serial nr. 100061480)
12	9123492	1	Indication plate
13	9172053	8	Nut
14	9222076	1	Strain relief M20
15	9222077	1	Connector M20
16	9294459	1	Spark catcher
16A	9294291	1	Spark catcher (till serial nr. 100061480)
18	4288322	8	Screw M5 x 10
19	9290476	1	Drawer
19	9290456	1	Drawer (till serial nr. 100061480)
20	9171008	1	Drain-tap with handle
21	9294460	1	Bottom plate
21A	9294286	1	Bottom plate (till serial nr. 100061480)
22	9142192	1	Display rack
23	9290513	1	Ventilating plate
24	9294284	3	Runner
25	9294285	1	Runner for bottom plate
26	9171020	12	Spacing pin
27	9171125	4	Rubber leg 50 mm
28	9172066	2	Swivel castor with brake (only for stacked units)
29	9172065	2	swivel castor without brake (only for stacked units)

TDW 5 P - COMPONENTS

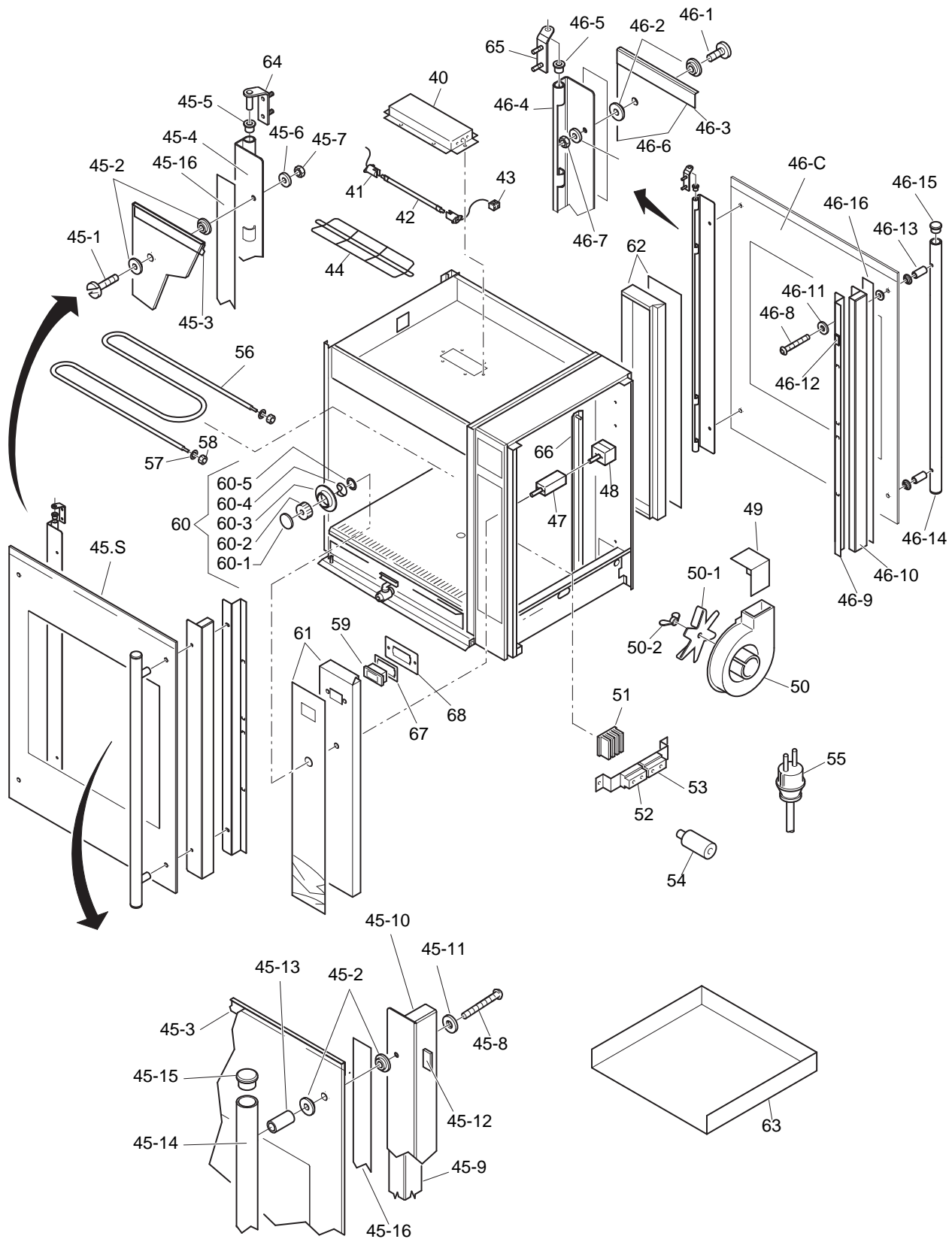

Item	Part number	Qty.	Description
40	9294271	1	Lamp shade
41	9052826	2	Lamp holder
42	9082774	1	Lamp. Halotherm 200 W
43	2300121	1	Terminal block, Ceramic
44	9292061	1	Protection guard, Halotherm lamp
45.S	92985005	1	Door service side, ass.
45-1	4280558	2	Screw M5 x 16 SS
45-2	3702342	8	Flange bush, PTFE 3 mm
45-3	9294149	1	Protection profile
45-4	9294135	1	Hinge profile
45-5	9172054	2	Brass bearing 8 mm
45-6	4311110	2	Washer M5
45-7	0144359	2	Nut M5, self locking
45-8	4288320	2	Screw M5 x 50 SS
45-9	9294137	1	Fastening, door handle
45-10	9294136	1	Magnet holder profile
45-11	9174680	2	Washer
45-12	9070141	12	Magnet block
45-13	9293010	2	Spacing pin
45-14	9293009	1	Door handle
45-15	2103209	2	Plug, door handle
45-16	4302141	2	Tape 20 x 0.8
46.C	92985035	1	Door customer side, ass.
46-1	4280558	2	Screw M5 x 16 SS
46-2	3702342	8	Flange bush, PTFE 3 mm
46-3	9294149	1	Protection profile
46-4	9294135	1	Hinge profile
46-5	9172054	2	Brass bearing 8 mm
46-6	4311110	2	Washer M5
46-7	0144359	2	Nut M5, self locking
46-8	4288320	2	Screw M5 x 50 SS
46-9	9294137	1	Fastening, door handle
46-10	9294136	1	Magnet holder profile
46-11	9174680	2	Washer
46-12	9070141	12	Magnet block
46-13	9293010	2	Spacing pin
46-14	9293009	1	Door handle
46-15	2103209	2	Plug, door handle
46-16	4302141	2	Tape 20 x 0.8

Item	Part number	Qty.	Description
47	9040714	1	Main switch, warmer
48	9082994	1	Thermostat 90 - 230°F
49	9174139	1	Spray mouth
50	9110048	1	Blower
50-1	9110153	1	Fan blade
50-2	9073150	1	Wing nut, left hand threaded
51	9040722	1	Connecting block
52	9044564	1	Connecting block, 1,2,3
53	9044572	1	Connecting block, 4,5,6
54	9110030	1	Capacitor 1,5 mF
55	9172400	1	Connecting cable with plug 6-15P
56	9160865	1	Heating element 230 V, 2,5 KW
57	0169197	2	Gasket, heating element
58	0169189	2	Nut, heating element
59	9082164	1	Thermometer, analogue °F
60	9298509	1	Main switch knob, assembly
60-1	9292002	1	Cover, black
60-2	9292001	1	Control knob, black
60-3	9292008	1	Back plate, 0-5
60-4	9172052	1	Locking ring
60-5	9110802	1	Seal ring
61	9298537	1	Operation panel, ass. Glass + backplate
62	9298521	1	Back panel, ass. glass and backplate
63	9294366	1	Protective pan under grease tray (for stacked units)
63A	9294118	1	Protective pan under grease tray (for stacked units) (till serial nr. 100061480)
64	9290409	1	Hinge, left
65	9290410	1	Hinge, right
66	9294157	1	Wiring duct
67	9294270	1	Filling plate
68	9294269	1	Mounting plate

TDW 7 P - SHEET METAL WORK

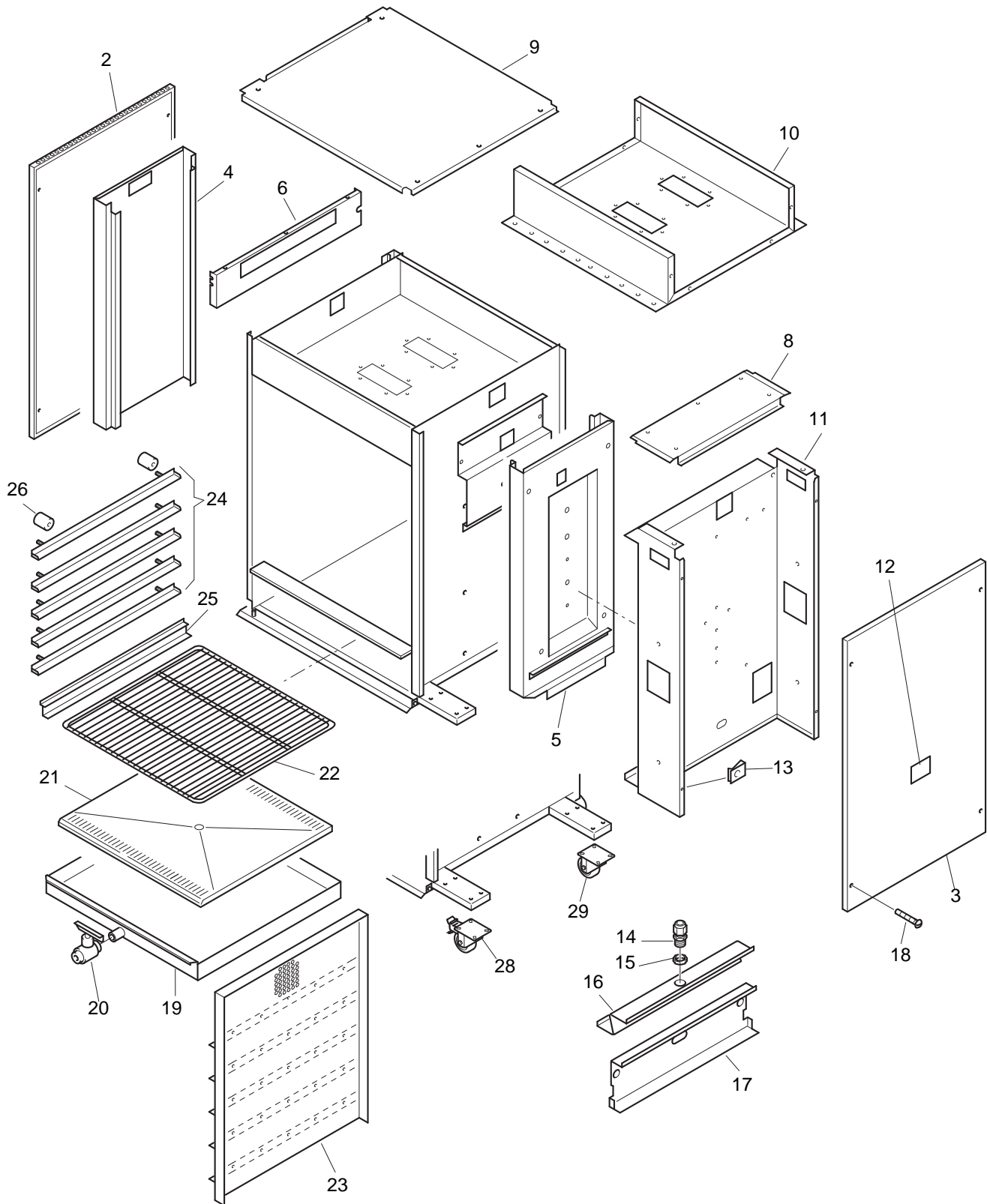

Item	Part number	Qty.	Description
1	1	Frame, ass.
2	9294180	1	Side panel, left
3	9294018	1	Side panel, right
4	9290500	1	Reinforcement plate, left
5	9290501	1	Reinforcement plate, right
6	9294110	1	Reinforcement, left top
7	9294258	1	Reinforcement, right top
8	9294045	1	Cover, removable
9	9294263	1	Top plate
10	9290502	1	Ceiling
11	9294262	1	Cover plate, machine components
12	9123492	1	Indication plate
13	9172053	8	Nut
14	9222076	1	Strain relief M20
15	9222077	1	Connector M20
16	9294019	1	Spark catcher
17	9294025	1	Mounting plate
18	4288322	8	Screw M5 x 10
19	9290405	1	Drawer
20	9171008	1	Drain-tap with handle
21	9294267	1	Bottom plate
22	9040748	1	Display rack
23	9290504	1	Ventilating plate
24	9294261	5	Runner
25	9294268	1	Runner for bottom plate
26	9171020	12	Spacing pin
27	9171125	4	Rubber leg 50 mm
28	9172066	2	Swivel castor with brake (only for stacked units)
29	9172065	2	Swivil castor without brake (only for stacked units)

TDW 7 P - COMPONENTS

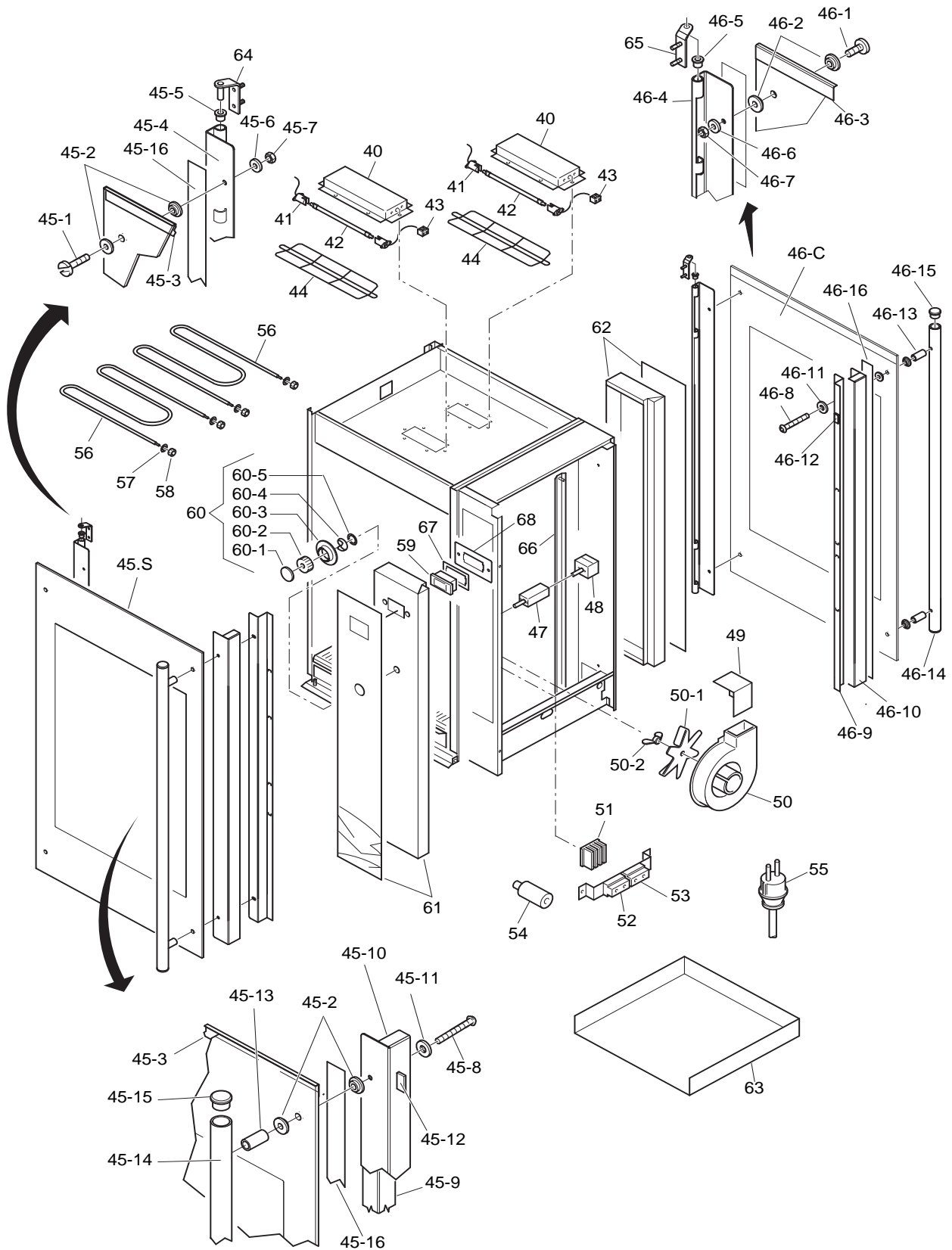

Item	Part number	Qty.	Description
40	9294271	2	Lamp shade
41	9052826	4	Lamp holder
42	9082774	2	Lamp. Halotherm 200 W
43	2300121	2	Terminal block, Ceramic
44	9292061	2	Protection guard, Halotherm lamp
45.5	9298510S	1	Door service side, ass.
45-1	4280558	2	Screw M5 x 16 SS
45-2	3702342	8	Flange bush, PTFE 3 mm
45-3	9294049	1	Protection profile
45-4	9294048	1	Hinge profile
45-5	9172054	2	Brass bearing 8 mm
45-6	4311110	2	Washer M5
45-7	0144359	2	Nut M5, self locking
45-8	4288320	2	Screw M5 x 50 SS
45-9	9294035	1	Fastening, door handle
45-10	9294034	1	Magnet holder profile
45-11	9174680	2	Washer
45-12	9070141	12	Magnet block
45-13	9293010	2	Spacing pin
45-14	9293008	1	Door handle
45-15	2103209	2	Plug, door handle
45-16	4302141	2	Tape 20 x 0.8
46.C	9298513S	1	Door customer side, ass.
46-1	4280558	2	Screw M5 x 16 SS
46-2	3702342	8	Flange bush, PTFE 3 mm
46-3	9294049	1	Protection profile
46-4	9294048	1	Hinge profile
46-5	9172054	2	Brass bearing 8 mm
46-6	4311110	2	Washer M5
46-7	0144359	2	Nut M5, self locking
46-8	4288320	2	Screw M5 x 50 SS
46-9	9294035	1	Fastening, door handle
46-10	9294034	1	Magnet holder profile
46-11	9174680	2	Washer
46-12	9070141	12	Magnet block
46-13	9293010	2	Spacing pin
46-14	9293008	1	Door handle
46-15	2103209	2	Plug, door handle
46-16	4302141	2	Tape 20 x 0.8

Item	Part number	Qty.	Description
47	9040714	1	Main switch, warmer
48	9082994	1	Thermostat 90 - 230°F
49	9174139	1	Spray mouth
50	9110048	1	Blower
50-1	9110153	1	Fan blade
50-2	9073150	1	Wing nut, left hand threaded
51	9040722	1	Connecting block
52	9044564	1	Connecting block, 1,2,3
53	9044572	1	Connecting block, 4,5,6
54	9110030	1	Capacitor 1,5 mF
55	9172403	1	Connecting cable with plug 15-20P
56	9005251	2	Heating element 230 V, 1,5 KW
57	0169197	2	Gasket, heating element
58	0169189	2	Nut, heating element
59	9082164	1	Thermometer, analogue °F
60	9298509	1	Main switch knob, assembly
60-1	9292002	1	Cover, black
60-2	9292001	1	Control knob, black
60-3	9292008	1	Back plate, 0-5
60-4	9172052	1	Locking ring
60-5	9110802	1	Seal ring
61	9298538	1	Operation panel. ass. glass + backplate
62	9298531	1	Back panel, ass. glass and back-plate
63	9294041	1	Protective pan under grease tray (for stacked units)
64	9290409	1	Hinge, left
65	9290410	1	Hinge, right
66	9294157	1	Wiring duct
67	9294270	1	Filling plate
68	9294269	1	Mounting plate

ELECTRICAL DIAGRAMS

CIRCUIT DIAGRAM TDR 5 AND 7 P

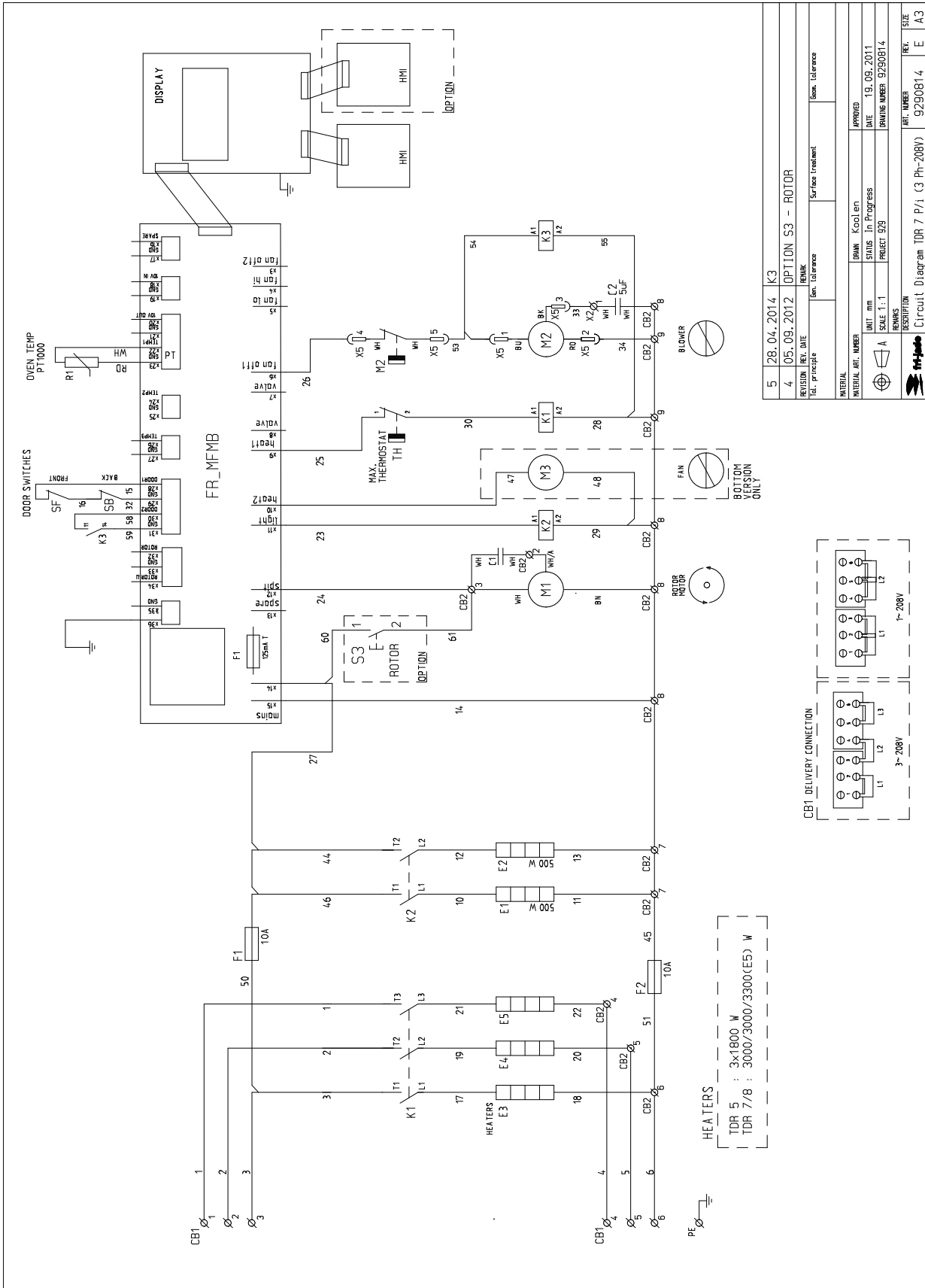

WIRING DIAGRAM TDR 5 AND 7 P

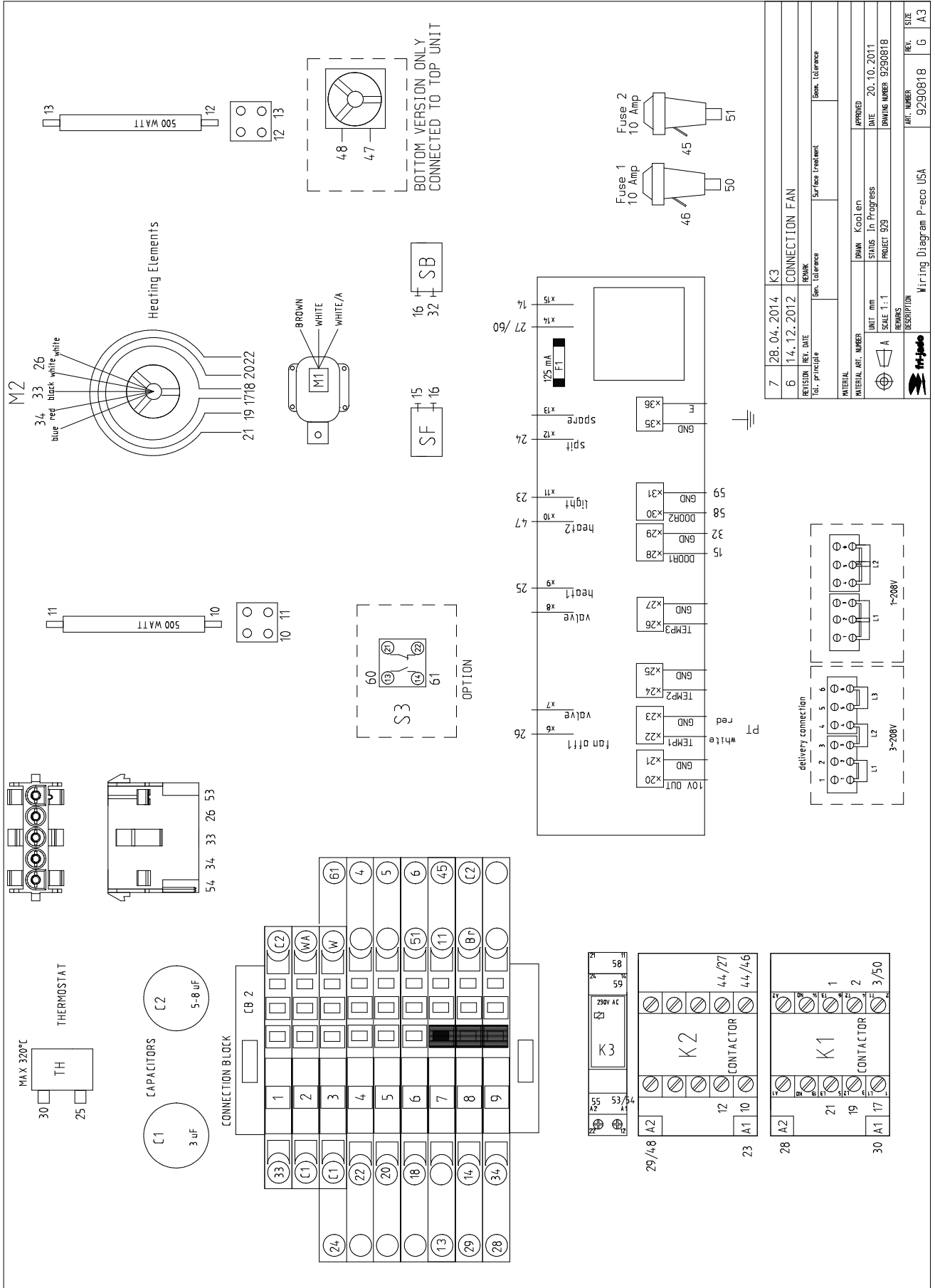

7	28.04.2014	K3	CONNECTION FAN
6	14.12.2012	REVISION	DATE
REVISION		REV. DATE	DATE
REV. PRINCIPLE		REV. TOLERANCE	REV. TOLERANCE
MATERIAL		REV. NUMBER	REV. NUMBER
MATERIAL ART. NUMBER		REV. NUMBER	REV. NUMBER
DRAWN		REV. NUMBER	REV. NUMBER
Kool en		REV. NUMBER	REV. NUMBER
STATUS		REV. NUMBER	REV. NUMBER
In Progress		REV. NUMBER	REV. NUMBER
PROJECT 929		REV. NUMBER	REV. NUMBER
SCALE 1:1		REV. NUMBER	REV. NUMBER
DRAWING NUMBER 9290818		REV. NUMBER	REV. NUMBER
REVISION		REV. NUMBER	REV. NUMBER
DESCRIPTION		REV. NUMBER	REV. NUMBER
Wiring Diagram P-eco USA		REV. NUMBER	REV. NUMBER
9290818		REV. NUMBER	REV. NUMBER
G		REV. NUMBER	REV. NUMBER
A3		REV. NUMBER	REV. NUMBER

CIRCUIT DIAGRAM TDR 5 AND 7 P (TILL SERIAL NUMBER 100069000)

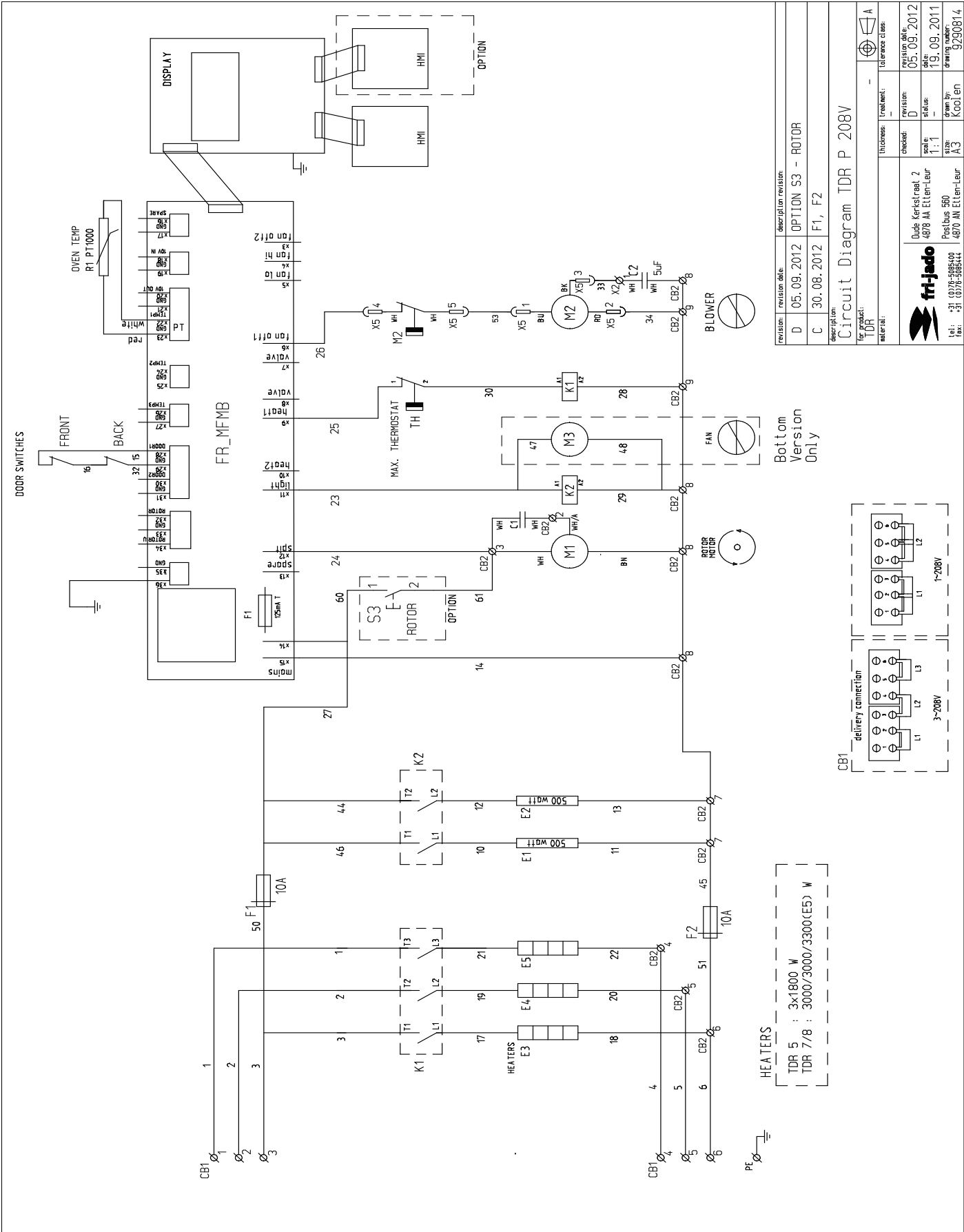

revision: D	05.09.2012	description revision: OPTION S3 - ROTOR
revision: C	30.08.2012	F1, F2
description: Circuit Diagram TDR P 208V		
for project: TDR	thickness: -	treatment: -
material: -	checked: D	revision date: 05.09.2012
	scale: 1:1	status: -
	size: A3	date: 19.09.2011
	drawn by: Koolen	drawing number: 9290814

Bottom Version Only

HEATERS
 TDR 5 : 3x1800 W
 TDR 7/8 : 3000/3000/3300(E5) W

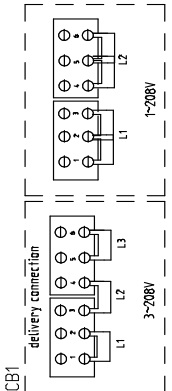

WIRING DIAGRAM TDR 5 AND 7 P (TILL SERIAL NUMBER 100069000)

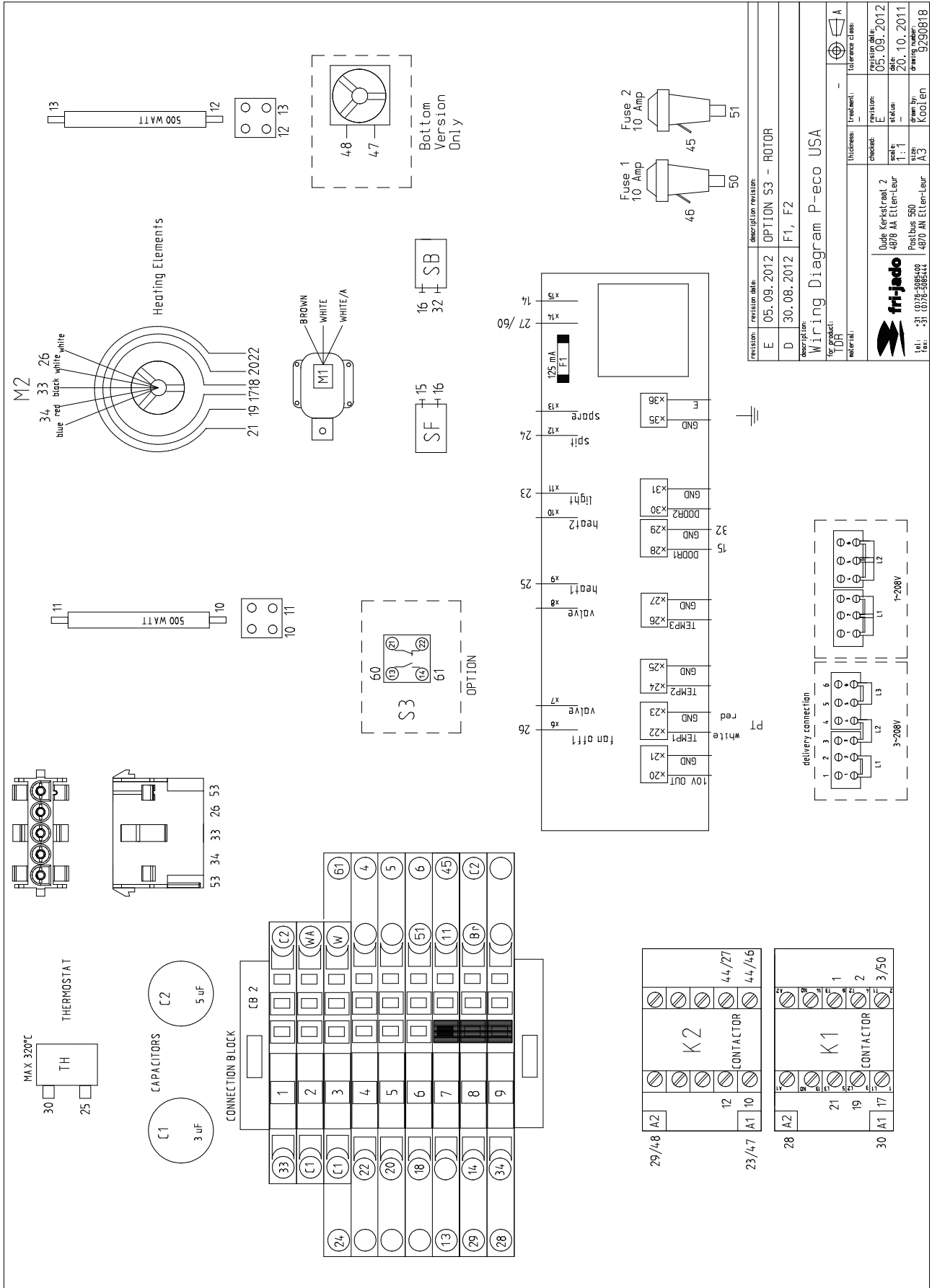

CIRCUIT DIAGRAM TDR 5 AND 7 P (TILL SERIAL NUMBER 100059841)

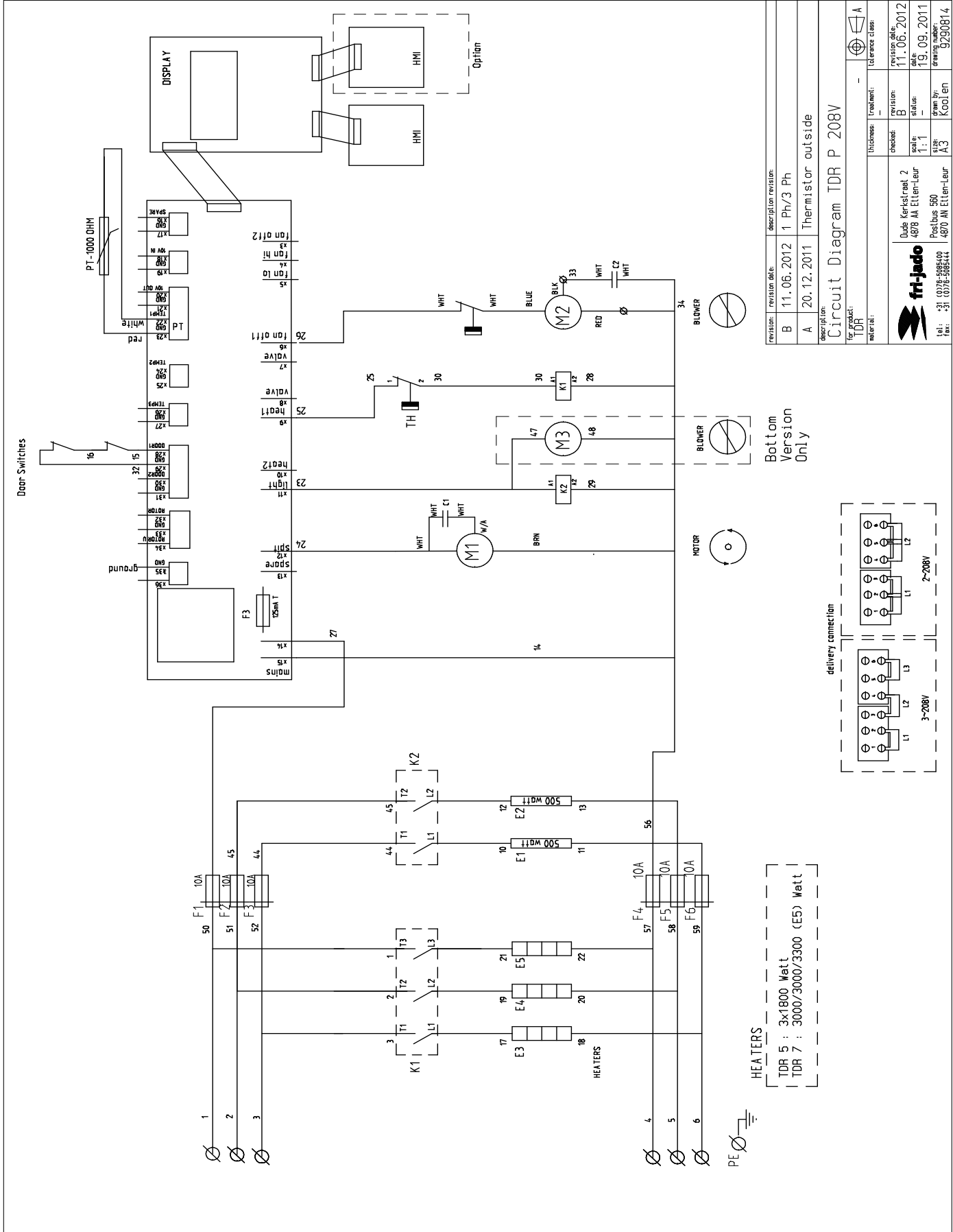

revision:	B	11.06.2012	1 Ph/3 Ph
description revision:	A	20.12.2011	Thermistor outside
description: Circuit Diagram TDR P 208V			
for product: TDR			
material:		thickness:	
		treatment:	
		checked:	Dude Kerst raek ?
		revision:	B
		revision date:	11.06.2012
		scale:	1:1
		status:	
		date:	19.09.2011
		drawn by:	Koolen
		size:	A3
		drawing number:	9290814

Bottom Version Only

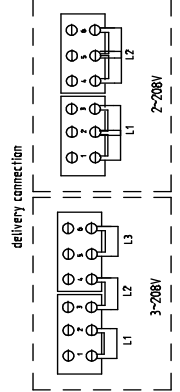

HEATERS
 TDR 5 : 3x1800 Watt
 TDR 7 : 3000/3000/3300 (E5) Watt

WIRING DIAGRAM TDR 5 AND 7 P (TILL SERIAL NUMBER 100059841)

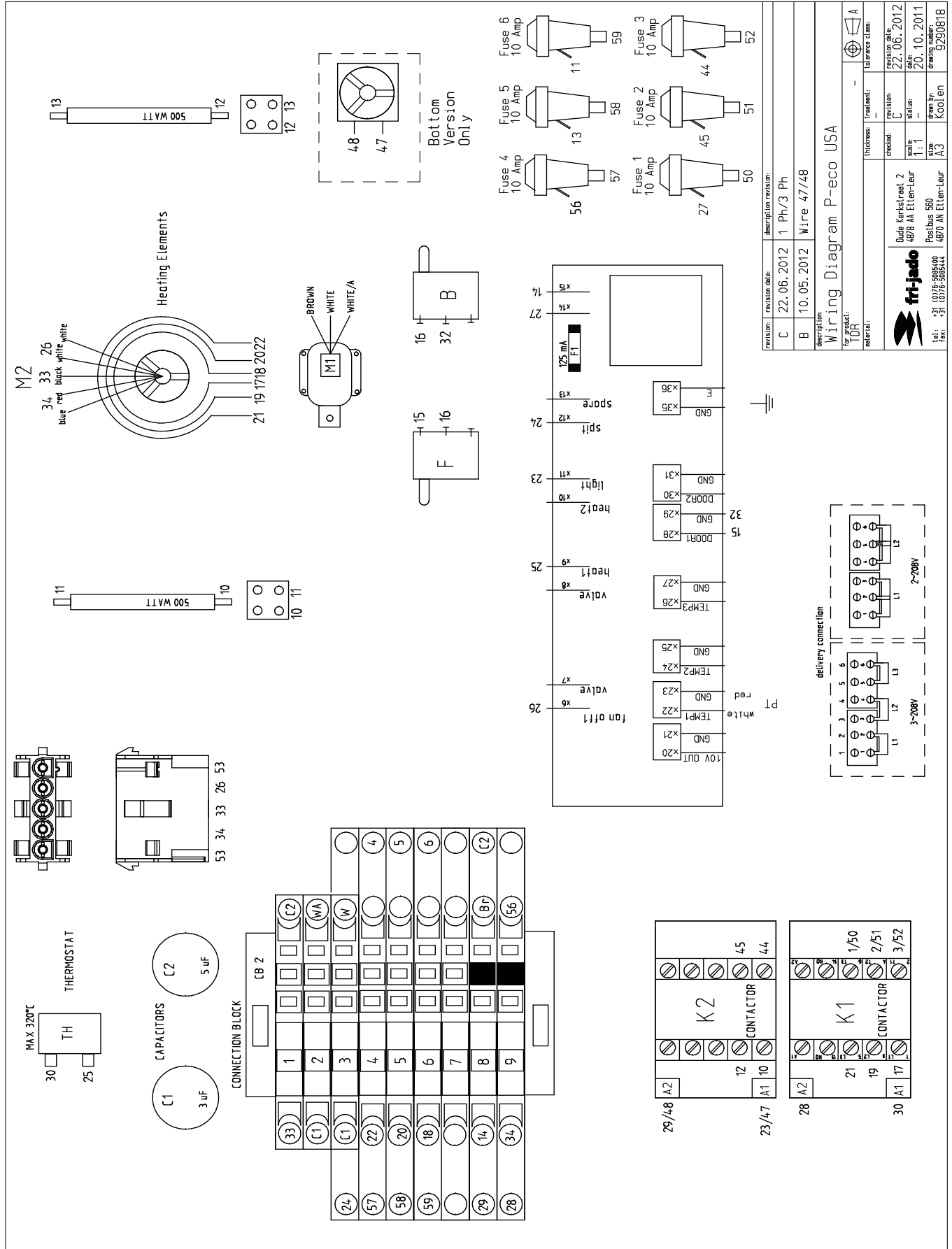

revision	revision date	description	revision
C	22.06.2012	1 Ph/3 Ph	
B	10.05.2012	Wire 47/48	

description: Wiring Diagram P-eco USA
for project: TDR
material:

business	treatment	checked	revision date	scale	status	date	drawn by	size	drawing number
			22.06.2012	1:1		20.10.2011	Koolen	A3	9290818

fri-jado
Dude Kerksstraat, 2
4878 AA Etten-Leur
Postbus 560
Tel: +31 (0)16-5985400
Fax: +31 (0)16-5985444

WIRING DIAGRAM TDR 5 AND 7 P (TILL SERIAL NUMBER 100058736)

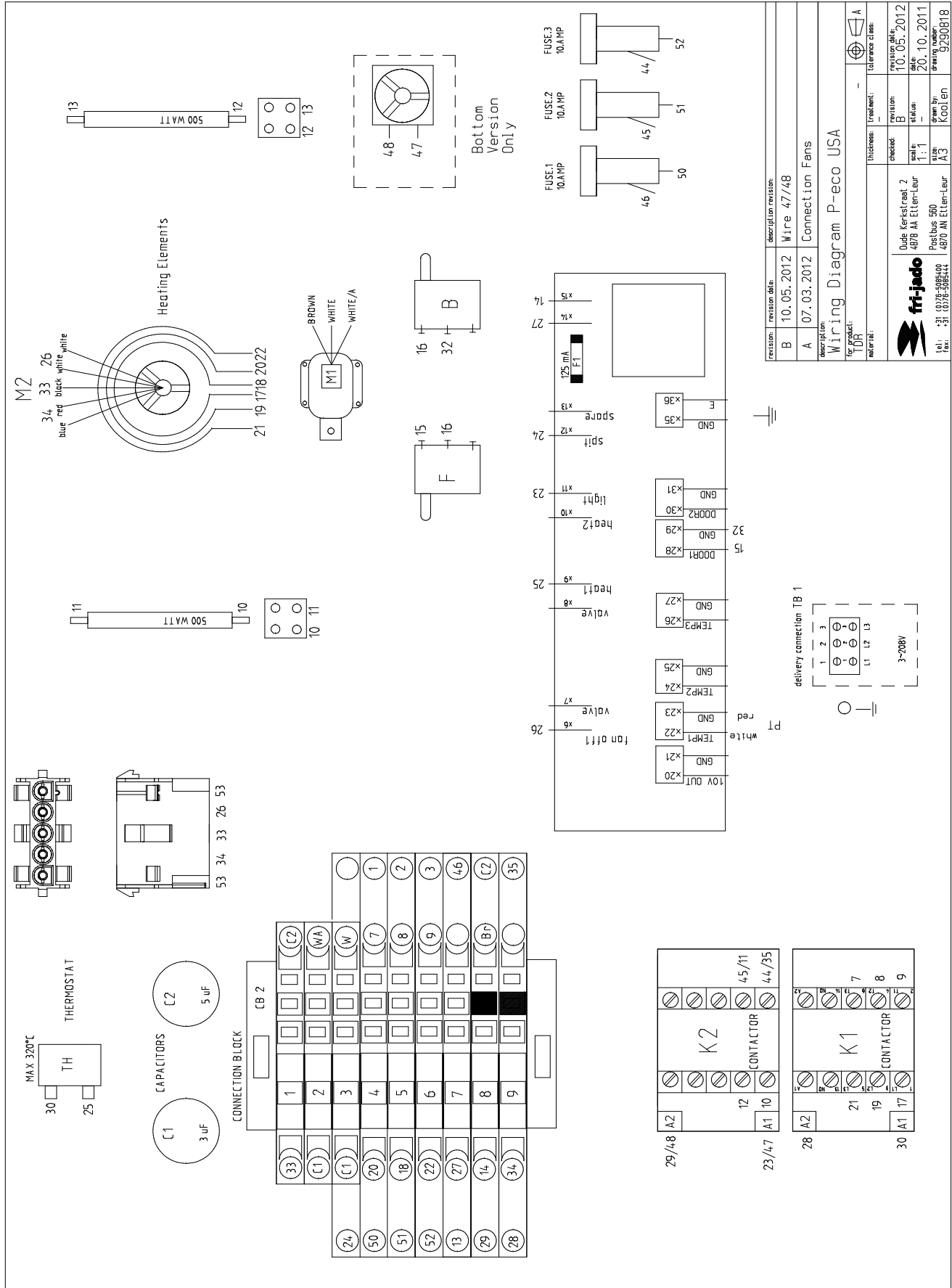

revision:	B	revision date:	10.05.2012	description:	Wire 47/48
revision:	A	revision date:	07.03.2012	description:	Connection Fans
description: Wiring Diagram P-eco USA					
for product: TDR					
material:					
thickness:	-	treatment:	-	tolerance class:	A
checked:	B	revision:	10.05.2012	drawing scale:	1:1
scale:	1:1	status:	20	date:	10.2011
size:	A3	drawn by:	Koelen	drawing number:	9290818

fri-jado
Dude Kerckstraat 2
4878 AH Ellen-Leur
Postbus 560
4870 AN Ellen-Leur
tel: +31 (0)76 588 00
fax: +31 (0)76 588 011

CIRCUIT DIAGRAM TDW 5

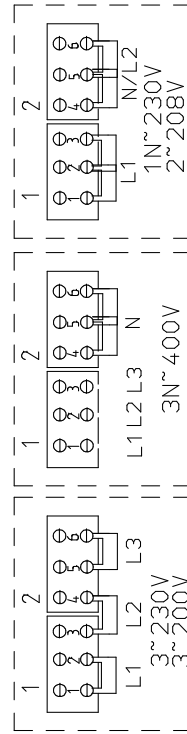
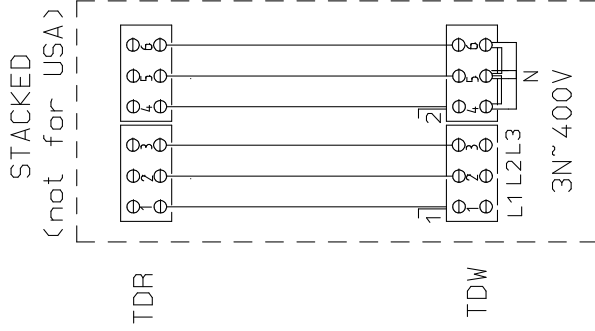
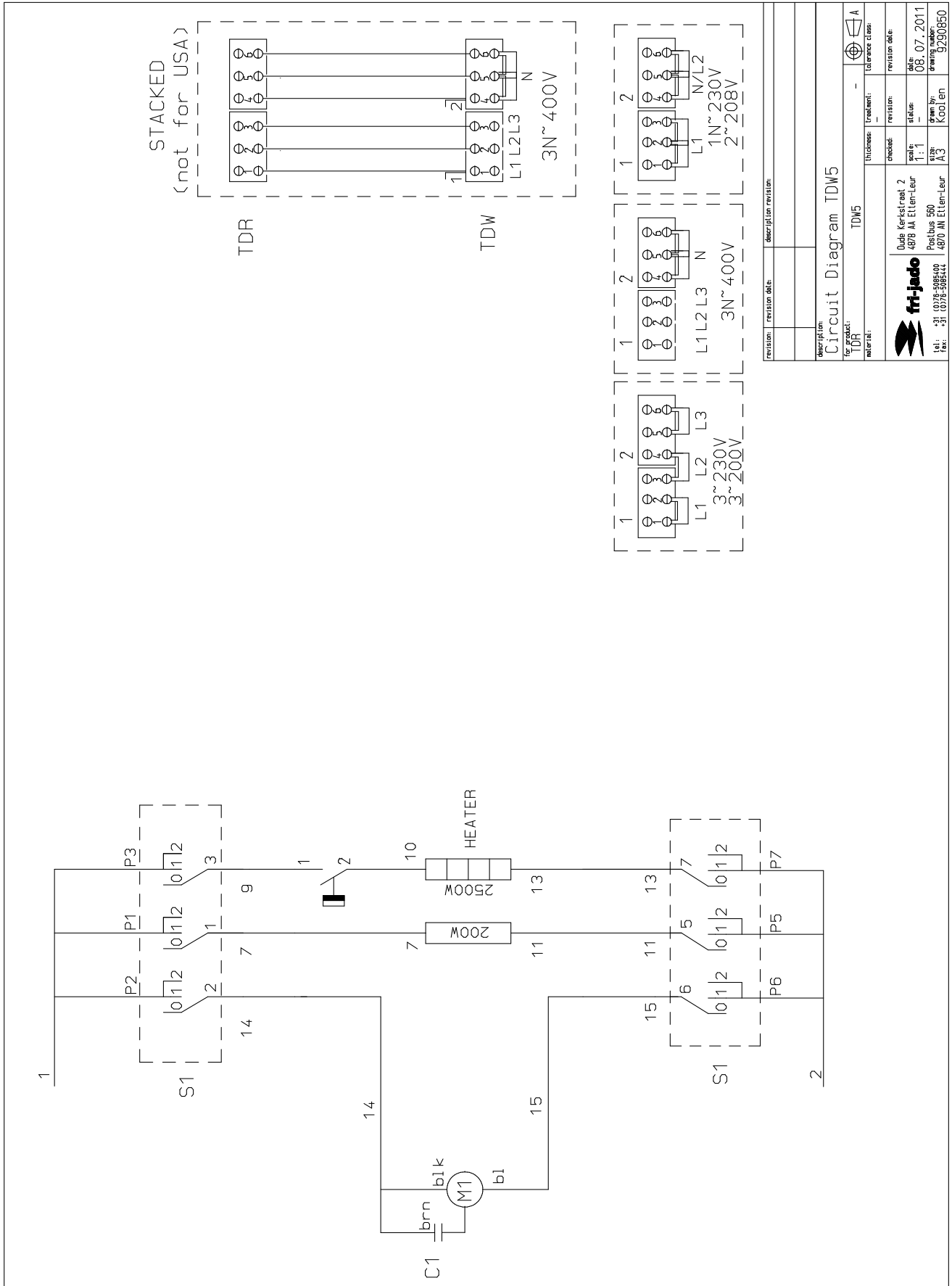

revision:	revision date:	description:	revision:
description: Circuit Diagram TDW5			
fig. product: TDR			
material:			
thickness:	material:	revision:	revision date:
checked:	checked:	scale:	date:
		1:1	08.07.2011
size:	drawn by:	size:	drawing number:
A3	Koelen	A3	9290850

fri-jado
 Oude Kerkstraat 2
 4878 AM Eilten-Leur
 Postbus 560
 Tel: +31 (0)76-5085400
 Fax: +31 (0)76-5085444

WIRING DIAGRAM TDW 5

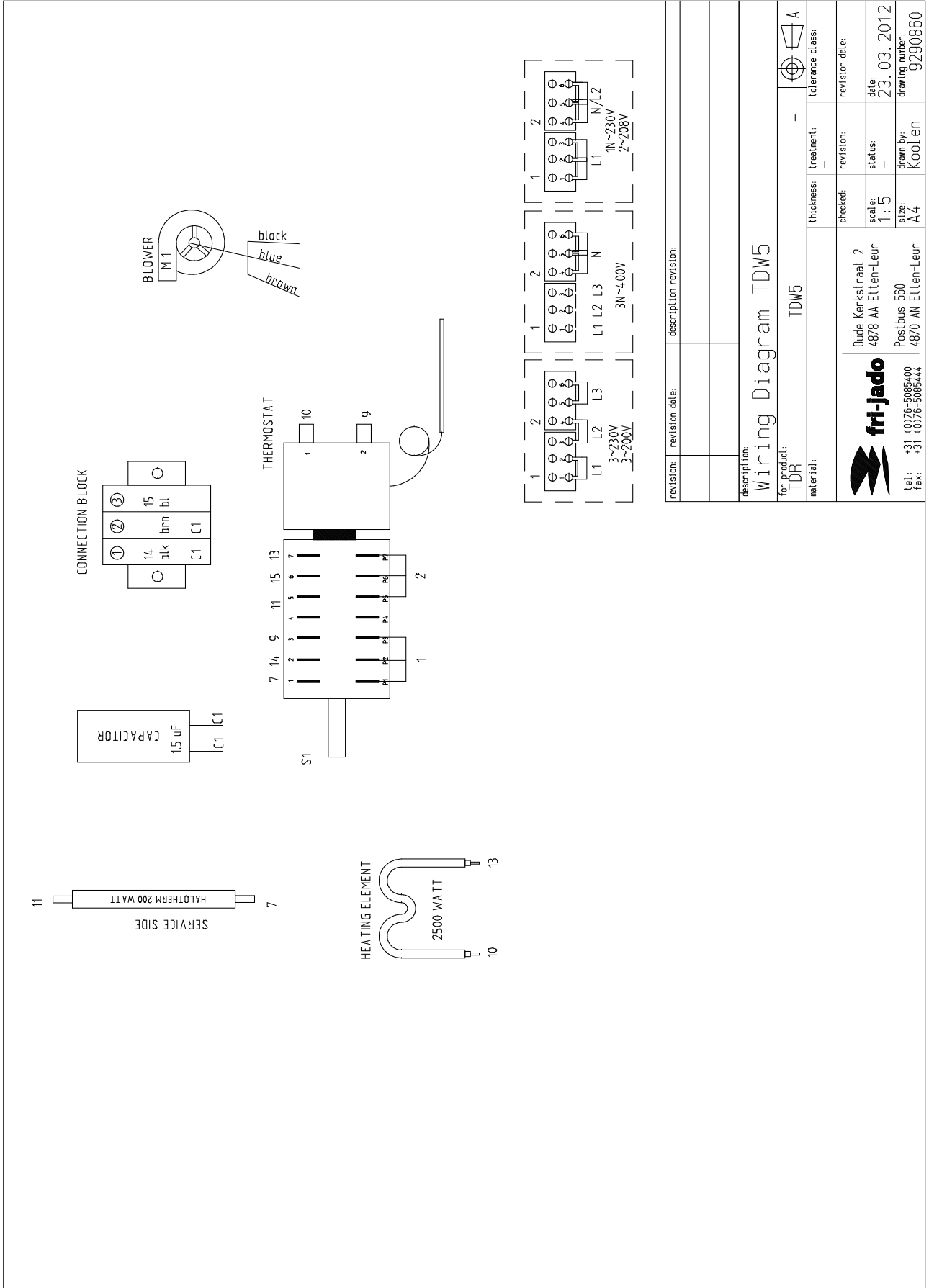

revision:	revision date:	description:	revision:	revision date:	tolerance class:
		Wiring Diagram TDW5			A
for product: TDR					
material:	TDW5	thickness:	-	treatment:	-
Dulle Kerckstraat 2 4878 AA Etten-Leur Postbus 560 4870 AN Etten-Leur Tel.: +31 (0)76-5085400 Fax: +31 (0)76-5085444					
checked:	revision:	status:	date:	drawn by:	drawing number:
			23.03.2012	Koolen	9290860
scale:	1:5				
size:	A4				

CIRCUIT DIAGRAM TDW 7

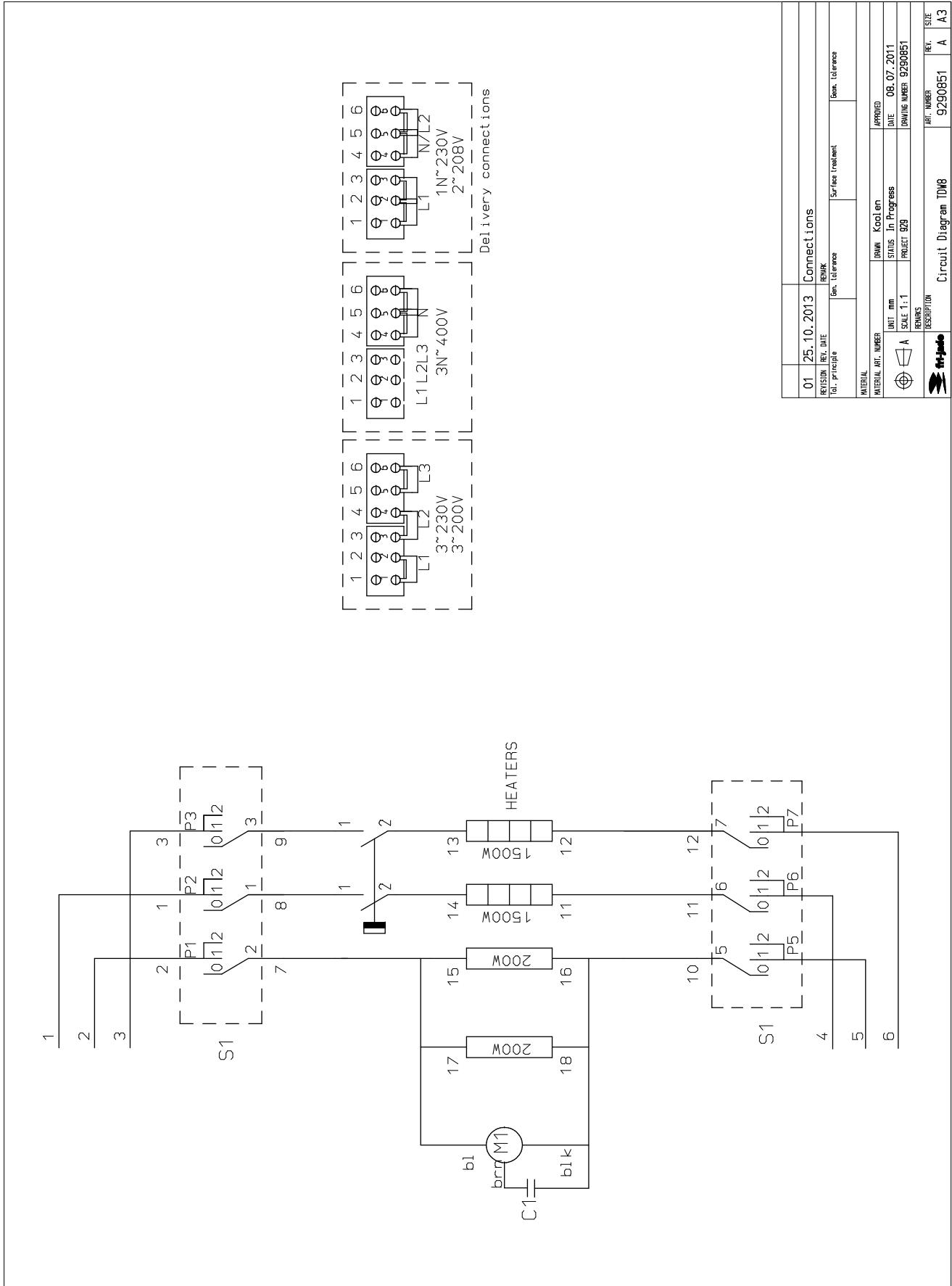

01	25.10.2013	Connections
REVISION	REV. DATE	DESCRIPTION
for principle		Gen. tolerance
		Surface treatment
		Gen. tolerance
MATERIAL		
MATERIAL ART. NUMBER	BRAND	Koellen
UNIT	mm	In Progress
SCALE	1:1	PROJECT 929
REVISIONS		
ART. NUMBER	REV.	SIZE
9290851	A	A3
Description: Circuit Diagram TDW8		

WIRING DIAGRAM TDW 7

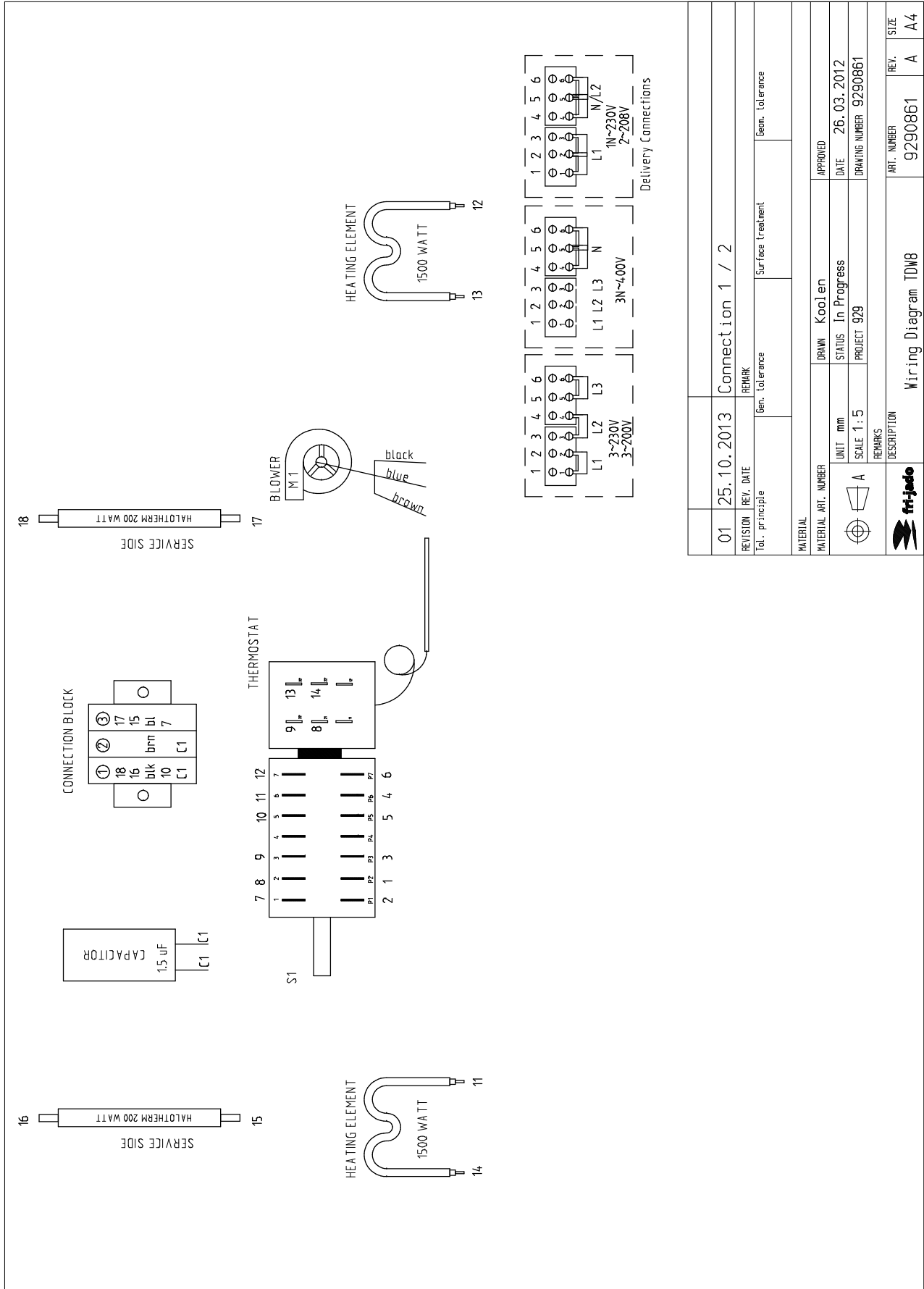

01	25.10.2013	Connection 1 / 2		
REVISION	REV. DATE	REMARK		
Tol. principle		Gen. tolerance	Surface treatment	Geom. tolerance
MATERIAL				
MATERIAL ART. NUMBER	DRAWN	Koolen	APPROVED	
UNIT mm	STATUS	In Progress	DATE	26.03.2012
SCALE 1:5	PROJECT	929	DRAWING NUMBER	9290861
REMARKS				
DESCRIPTION			ART. NUMBER	REV.
Wiring Diagram TDM8			9290861	A
			SIZE	A4

EMPTY PAGE

EMPTY PAGE

For technical support call:	877 374-5236
For parts call:	877 392-7851

