

SERVICE MANUAL

Hot Island 48 - 2 level



- NOTICE -

This manual is prepared for the use of trained Service Technicians and should not be used by those not properly qualified. If you have attended a training for this product, you may be qualified to perform all the procedures in this manual.

This manual is not intended to be all encompassing. If you have not attended a training for this product, you should read, in its entirety, the repair procedure you wish to perform to determine if you have the necessary tools, instruments and skills required to perform the procedure. Procedures for which you do not have the necessary tools, instruments and skills should be performed by a trained technician.

Reproduction or other use of this Manual, without the express written consent of Fri-Jado, is prohibited.

EMPTY PAGE

Versions		
Version	Issue date dd/mm/yy	Remarks
06/2018	01/07/2018	First release.

INDEX

Index	4
General Technical data	5
Performance	5
Technical data	6
Removal and replacement of parts	7
Top glass.....	7
Side door.....	7
Middel glass.....	8
Coverplate electrobox.....	8
Danfoss thermostat.....	9
Tumble switch / lamp holder.....	10
Upper pane	10
Electronic ballast.....	11
Child guard.....	12
Blower	12
Sensor of Danfoss thermostat.....	12
Electrical tests and service procedures	14
Heating element test.....	14
PTC 1K Sensor test	14
Contactor and blower test.....	14
Adjusting Danfoss ERC 211 thermostat.....	15
Adjusting Danfoss ERC 211 thermostat (continued)	16
Error codes ERC 211	16
Danfoss ERC 211 settings.....	17
Electric diagram.....	18
Troubleshooting	20
Exploded views and partlist	22

GENERAL TECHNICAL DATA

Tools

- Standard set of tools
- Metric wrenches, sockets and hex socket key wrenches
- Multi-meter and AC current clamp meter
- Temperature tester

PERFORMANCE

The cabinet conforms to both Fri-Jado and NSF 4 standards.

Energy efficiency is high, the energy consumption measured at 73,4 °F is 3,7 kWh/h during normal operation, this is equal to 1,8 kWh/h per 3,28 ft² of the display area. Peak power can reach 4,4 kW.

The table below gives an overview of the maximum surface temperature of the different components. Note that the temperature at the shelf can vary, it can be 10 degrees lower than the given values.

Component	Material	Max. Temperature (°F)
Top shelf	Stainless steel	181,4
Bottom shelf	Stainless steel	192,2
Side glass	Tempered glass	145,4
Child guard	Aluminium	143,6

This manual describes the Hot Island 48-2 UL + UF merchandiser.

All information, illustrations and specifications in this manual are based on the product information available at version date.

TECHNICAL DATA

Type	HI 48-2 +UF
Number	9259100
Power (W)	4500
Voltage	3~208 V
Frequency	60 Hz
Fuses needed with power connection 208 V 3 ~60 Hz (3 phases without zero)	3x20A
Standard plug from factory single pole	NEMA 15-30P
Lighting	4 x T5 21 W 830
Net Weight (lbs)	723
Ship Weight (lbs)	849
Depth	52 3/4"
Width	46 3/4"
Height	59 7/8"
Presentation area	23 ft ²
Sound pressure	<70 dB(A)
Power cord	78"
Accessories	
Cross-selling basket	9259801
Bumper, set of 4	9259800
Temperature indicator	9229801

REMOVAL AND REPLACEMENT OF PARTS

WARNING: Disconnect electric power, then place a tag on the circuit box indicating that the circuit is being serviced.

TOP GLASS



1. Remove 4 screws at the side of the glass
2. Lift the top glass
3. Reverse the procedure to install

SIDE DOOR

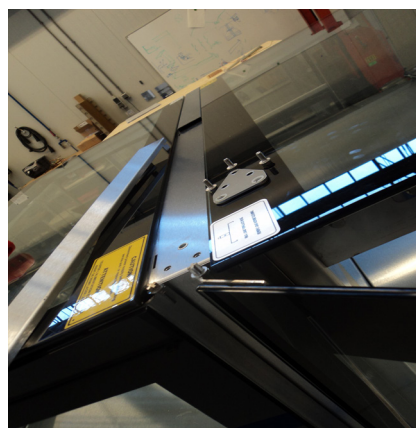
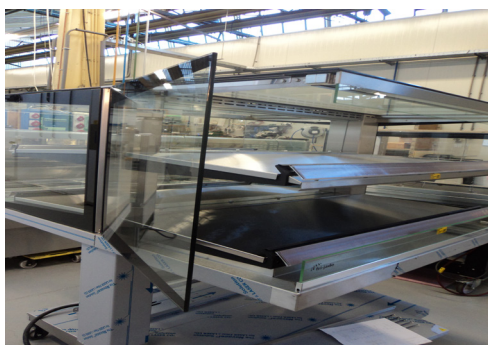

1. Slide and lift the metal strip aside.
2. Remove the screw at the fastening strap.
3. Remove the 3 screws at the upper side and lift the door.
4. Reverse the procedure to put the door back.

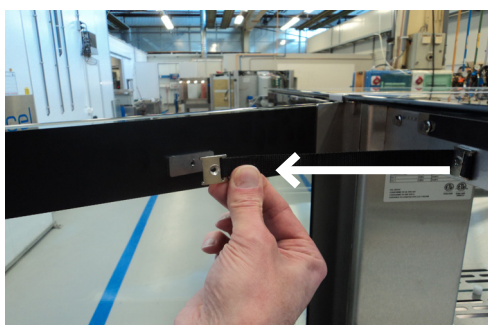

MIDDEL GLASS



1. Both separation panels can be removed by lifting the glass.
2. Move the bottom of the glass sideways to take it out

COVERPLATE ELECTROBOX



1. Unscrew the 4 hex screws.
2. Remove the cover plate.

DANFOSS THERMOSTAT

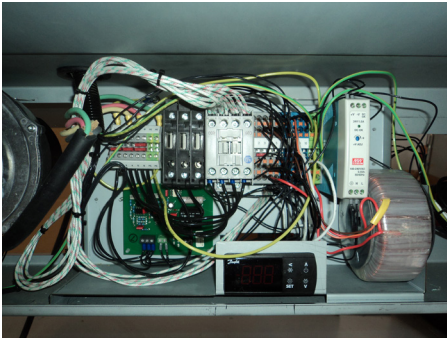

1. Follow the instructions as described above to remove the electro-box cover plates
2. Unscrew the Phillips screw at the back side to be able to move the box
3. Disconnect the wiring of the thermostat
4. Remove the Danfoss by pushing the clamps on both sides.



TUMBLE SWITCH / LAMP HOLDER

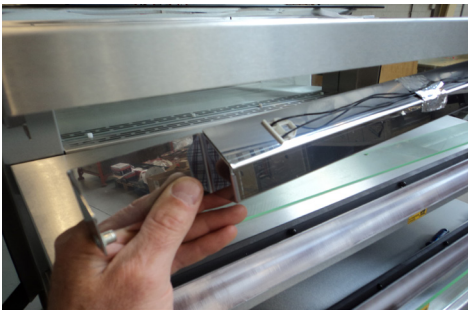
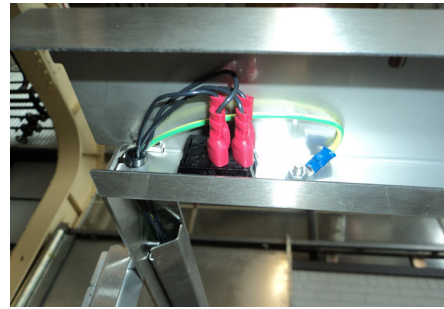
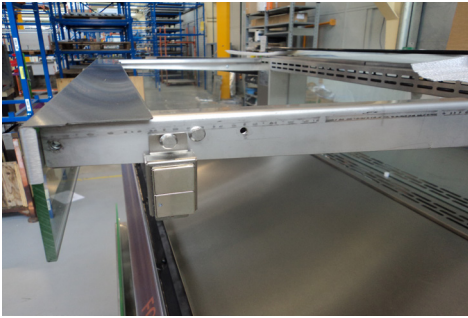

1. Remove the top glass.
2. Remove the 2 screws at the left and righthand site of the magnet.
3. Unscrew the nuts.
4. Slide the glass panel forwards and take it out.
5. Take out the glass clamp.
6. To disconnect the switch remove wiring and push the 2 clips.

UPPER PANE

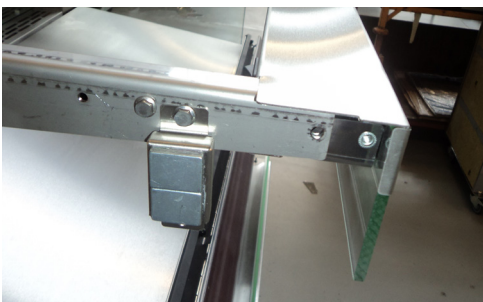

1. Follow the same procedure as described above to remove the top glass and lamp holder.
2. Slide the glass panel forwards and take it out.
3. Reverse the procedure to replace the upper pane.

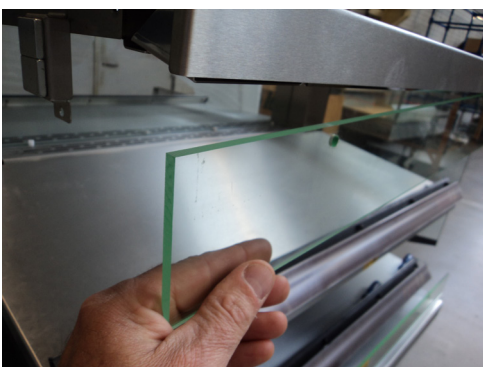

ELECTRONIC BALLAST



1. Remove the cover plates as described above.
2. The electrobox can be removed by unscrew the Phillips screw at the back side.
3. The two ballast are located at the back of the electrobox.

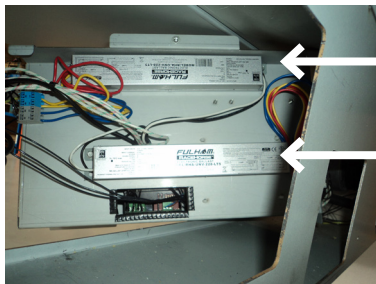

CHILD GUARD

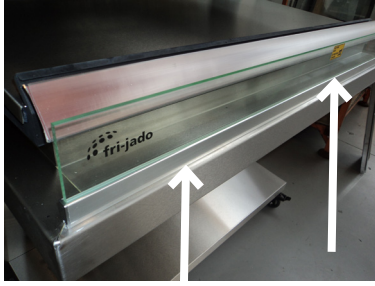

To be able to replace the child guard the glass needs to be lifted upwards.

BLOWER

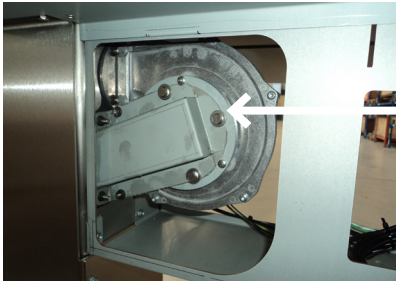

1. Remove the cover plates as described above.
2. Unscrew the fan box (213)
3. Unscrew the nuts to remove the blower.

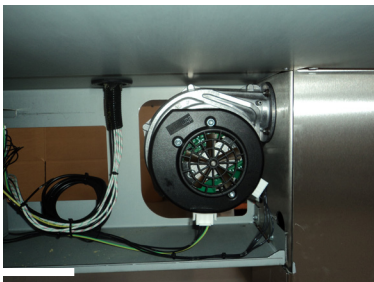

SENSOR OF DANFOSS THERMOSTAT

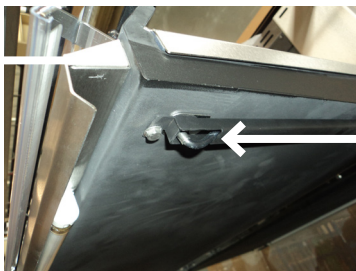

The sensor is located at the right side of the upper plate shelf.

1. In order to replace the sensor the upper shelf needs to be removed.
2. Disconnect the cable in the electrobox.
3. Pull the cable through the conduit.
4. Replace the cable and re-connect it to the danfoss thermostat.
5. Put the shelf and cover plates back

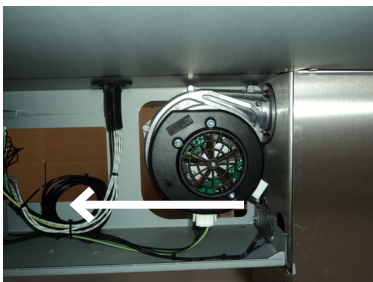

EMPTY PAGE

ELECTRICAL TESTS AND SERVICE PROCEDURES

WARNING: Disconnect electric power, then place a tag on the circuit box indicating the circuit is being serviced.

HEATING ELEMENT TEST

Note: When testing the resistance of the element remove the wiring from the connecting block.

Type	Power/Voltage	Resistance Ω -0% + 10%	Current A
HI 48	1060 / 28	40.8	5.0

PTC 1K SENSOR TEST

Temperature		Resistance
°F	°C	± 10 Ohms
60	16	930
70	21	970
80	27	1016
90	32	1056
100	38	1107
125	52	1227
150	65	1347
200	94	1636
250	121	1935

1. Remove the panel according prior procedure.
2. Remove the wiring from the sensor.
3. Connect a temperature sensor to the probe for comparison.
4. Test the probe with an Ohmmeter.

CONTACTOR AND BLOWER TEST

Note: When testing the resistance remove the wiring.

Type	Description	Voltage	Resistance
HI 48	Contactor	208 V	Resistance of coil (A1 - A2) ~ 525 Ω
HI 48	Blower See picture below	120 V	Between 1-2 ~3.5 M Ω

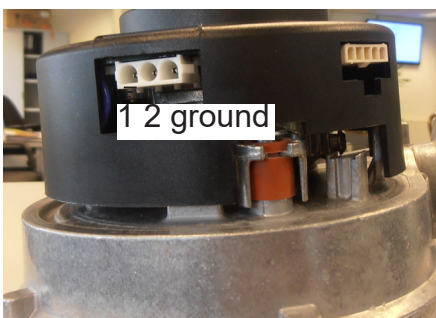







ADJUSTING DANFOSS ERC 211 THERMOSTAT

Adjusting Danfoss ERC211 thermostat



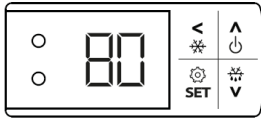











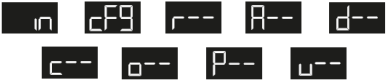

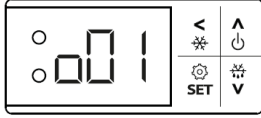
Changing temperature setpoint

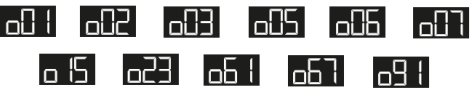
Example screens

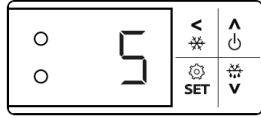
1. Press  to access setpoint mode	
2. Change value with  or 	
3. Press  to confirm	
When no key is pressed after last confirmation, the system goes back to normal operation after 10 seconds	

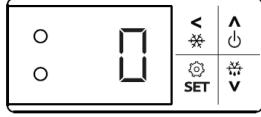
Programming menu

Example screens

1. Press  for 3 seconds to access the menu	
2. Scroll through parameter groups with  and 	
3. Select parameter group with 	
4. Scroll through parameter names with  and 	
5. Press  to read out the value	
6. Change value with  and 	
7. Press  to confirm	
8. Press  to select the next parameter and follow instruction 3 to 7	
Use  to go back in the parameter groups and once more to leave the programming menu	

ADJUSTING DANFOSS ERC 211 THERMOSTAT (CONTINUED)

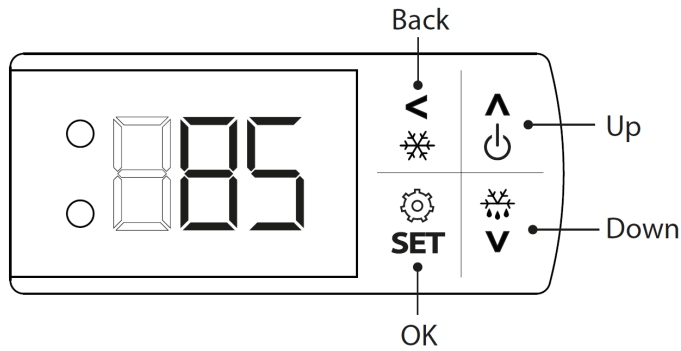

ERROR CODES ERC 211

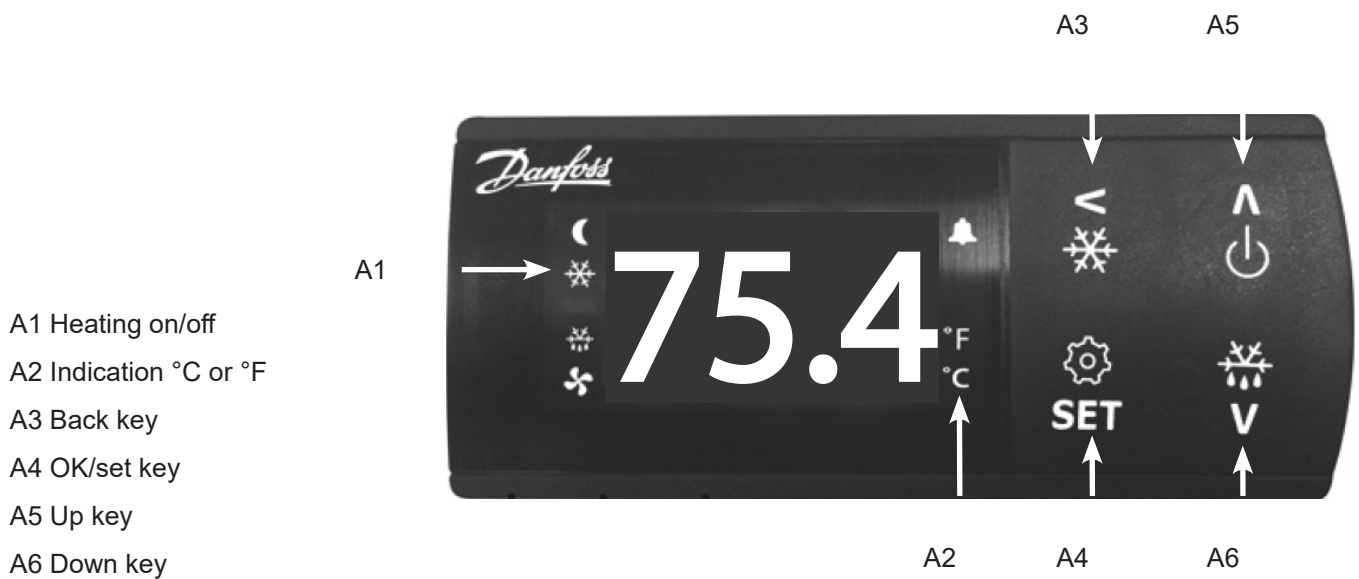

If the elements are switched on, the indicator lamp A1 will go on.

Error codes on display:

E29: PT sensor broken or wiring problem sensor.

A01: High temperature alarm.

A02: Low temperature alarm.

A99: High voltage alarm.

AA1: Low voltage alarm.

oFF: Main switch alarm. Check parameter r12.

Wrong temperature displayed: Wrong type of sensor selected. Check o06.

When reporting error codes the unit is switched in stand-by mode and cannot be used until the problem is resolved.

DANFOSS ERC 211 SETTINGS

Note! Change r05 first and then r03.

r00	Temperature set point	<u>194</u>	°F
r01	Differential	<u>1.8</u>	°F
r02	Min set point limitation	<u>32</u>	°F
r03	Max set point limitation	<u>210</u>	°F
r04	Display offset	0	°F
r05	Display unit (°C/°F)	<u>°F</u>	
r09	Calibration of Sair	<u>0</u>	°F
r12	Main switch	1	
r13	Night set back	0	
r40	Thermostat reference displacement	0	
r96	Pull-down duration	0	
r97	Pull-down limit temperature	0	
A03	Delay for temperature alarm (normal conditions)	30	min
A12	Delay for temperature alarm (pull down/start-up/defrost)	60	min
A13	High temperature alarm limit	<u>212</u>	°F
A14	Low temperature alarm limit	-22	°F
A27	DI1 delay	30	min
A37	Condenser high alarm limit	176	°F
A54	Condenser high block limit	185	°F
A72	Voltage protection enable	no	
A73	Minimum cut-in voltage	0	V
A74	Minimum cut-out voltage	0	V
A75	Maximum voltage	270	V
d01	Defrost method (no=no defrost, nAt=natural)	<u>no</u>	
d02	Defrost stop temperature	40	°F
d03	Defrost Interval	8	hr.
d04	Max. defrost time	30	min
d05	Defrost delay at power up	0	min
d06	Drip delay	0	min
d10	Defrost stop sensor (non=time, Air=Sair)	non	
d18	Compressor accumulated	0	hr.
d30	Defrost delay after pull-down	0	min
c01	Compressor minimum ON time	0	min

c02	Compressor minimum OFF-time	<u>0</u>	min
c04	Compressor OFF delay	0	sec
c70	Zero crossing selection	yES	
o01	Delay of outputs	<u>0</u>	sec
o02	DI1 configuration	oFF	
o03	Serial address	0	
o05	Password	no	
o06	Sensor type selection (n5=NTC5 K, n10=NTC10 K, Ptc=PTC, Pt1=Pt1000)	<u>Ptc</u>	
o07	Cooling/heating (rE=refrigeration / Ht=heat)	<u>Ht</u>	
o15	Display resolution (°C)	0.1	
o23	Relay counter	0	
o61	Predefined applications	AP0	
o67	Save settings as factory	no	
o91	Display at defrost	d	
P73	DI1 input polarity	no	
P76	Keyboard lock enable	no	
u01	Air temperature (Sair)	-	°F
u02	Read the present regulation refer- ence	-	
u10	DI1 input	-	
u13	Status of night operation	-	
u58	Compressor relay status	-	-
u80	Firmware version readout	-	

ELECTRIC DIAGRAM

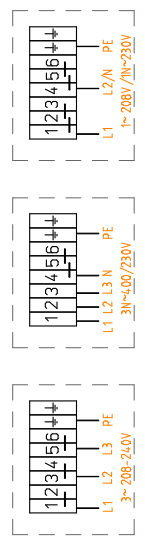
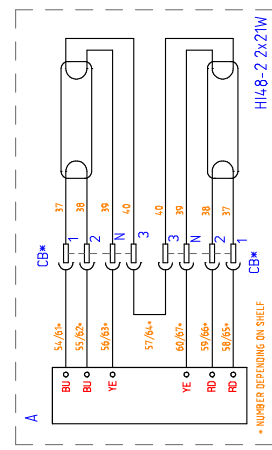
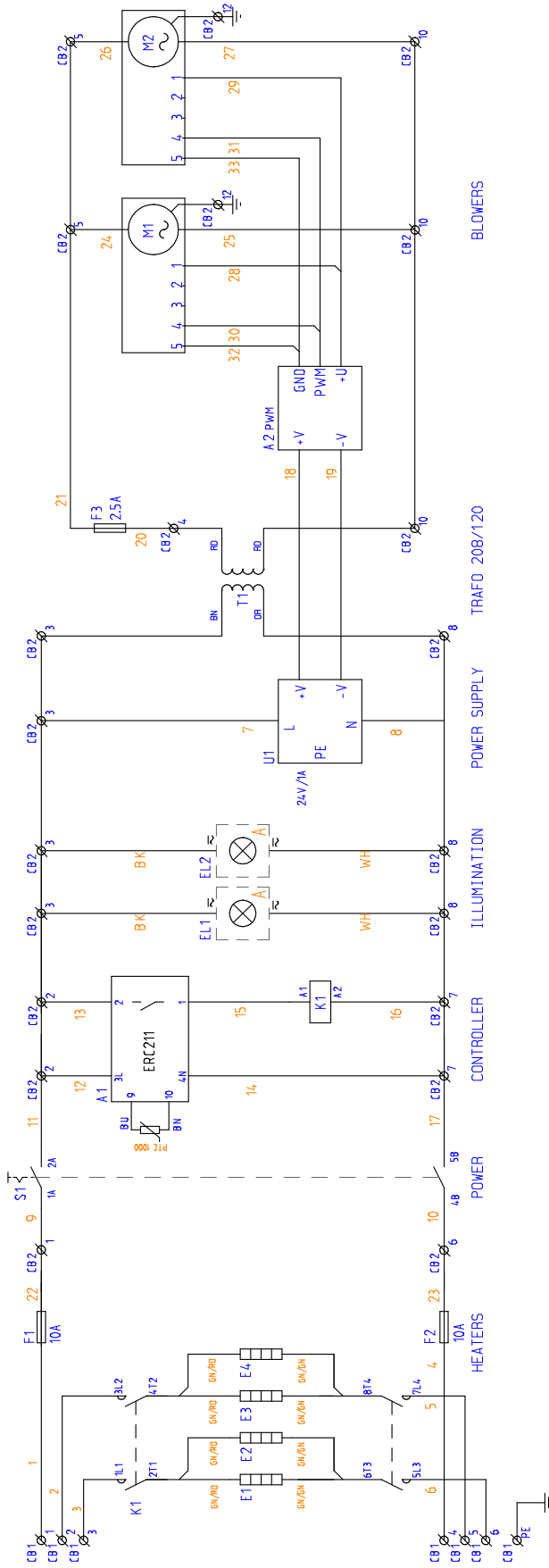

BN - BROWN
 BU - BLUE
 RD - RED
 OR - ORANGE
 GN - GREEN
 YE - YELLOW

HEATER	E1	E2	E3	E4
HI48-2	1060W	1060W	1060W	1060W

REVISION	REV. DATE	Name/ground	REMARK
01	12.03.2018		

APPROVED v.	DRWN	DATE
Dorst	v. Dorst	27.10.2017

STATUS	PROJECT
Released	9250801

UNIT	SCALE
mm	1:1

ART. NUMBER	DESCRIPTION	REV.	SIZE
9250801	Circuit diagram HI 208 V ERC	A	A3

TROUBLESHOOTING

This is an analytic description for servicing and repairing all major parts of the HI 48 It consists of 4 basic steps to recognize and solve the problems:

1. Symptoms.
2. Possible causes.
3. Solving of the problem: checking/action.
4. Replacing of parts and testing:

Description of part	Symptoms	Possible causes	Solving: checking / action
Contactora	Contactora does not come in.	Wiring. Coil malfunction. Contact burned.	Check the wiring. Check resistance of coil. This should be $\pm 525\Omega$. Check the contacts.
Heating element	The cabinet is not reaching the adjusted temperature	Wiring. Element malfunction.	Check the wiring. Check the power on the element. Check current with AC current tester.
Tumble switch	Light and heating does not switch on	Wiring. Contact burned.	Check the wiring. Check the voltage on "in"- and "output".
Electronic ballast	Light does not switch on	Wiring. Ballast malfunction.	Check the wiring. Replace ballast.
lamp(s)	Light does not switch on	Wiring. Lamp(s) broken.	Check the wiring. Replace lamp(s).
Electronic thermostat	Display does not light up The cabinet is not reaching the adjusted temperature or does not heat up at all	Wiring. Loose sensor. Thermostat malfunction. Thermostat settings.	Check the wiring. Check sensor. Replace thermostat. Check parameters.
PTC 1000 sensor	The cabinet is not reaching the adjusted temperature or does not heat up at all The cabinet becomes too hot	Broken sensor. Loose sensor. Broken sensor. Sensor shorted.	Replace sensor. Check wiring. Replace sensor. Check wiring.
Blower heating system	Blower doesn't run Main fuse burned	Wiring. Cooling. Short circuit in coil to earth.	Check wiring. Check voltage on blower. Check cooling of motor. Check if unit is close to another heat source. Check insulation value of coil with a Megger on max. 500V Minimum value is 0.5M Ω

Symptom	Possible causes
No power to cabinet controls.	<ol style="list-style-type: none"> 1. Main breaker open. 2. Wiring loose.
Main fuse or breaker blows.	<ol style="list-style-type: none"> 1. Wiring incorrectly. 2. Heating element shorted. 3. Blower shorted. 4. Wiring shorted.
Illumination does not work.	<ol style="list-style-type: none"> 1. Lamp malfunction. 2. Tumble switch malfunction. 3. Electronic ballast malfunction. 4. Wiring loose. 5. Wiring in faston broken.
No heating.	<ol style="list-style-type: none"> 1. Heating element malfunction. 2. Wiring loose. 3. Thermostat malfunction. 4. Sensor malfunction. 5. Sensor wiring loose.
Unit does not reach desired temperature.	<ol style="list-style-type: none"> 1. Heating element(s) malfunction. 2. Strong air current along the unit. 3. Air leak in PVC air flow system. 4. Sensor malfunction. 5. Blower malfunction.
No indication on electronic thermostat.	<ol style="list-style-type: none"> 1. Electronic thermostat malfunction. 2. Wiring loose.
Blower motor does not run.	<ol style="list-style-type: none"> 1. Wiring loose. 2. Motor inoperative.

EXPLODED VIEWS AND PARTLIST

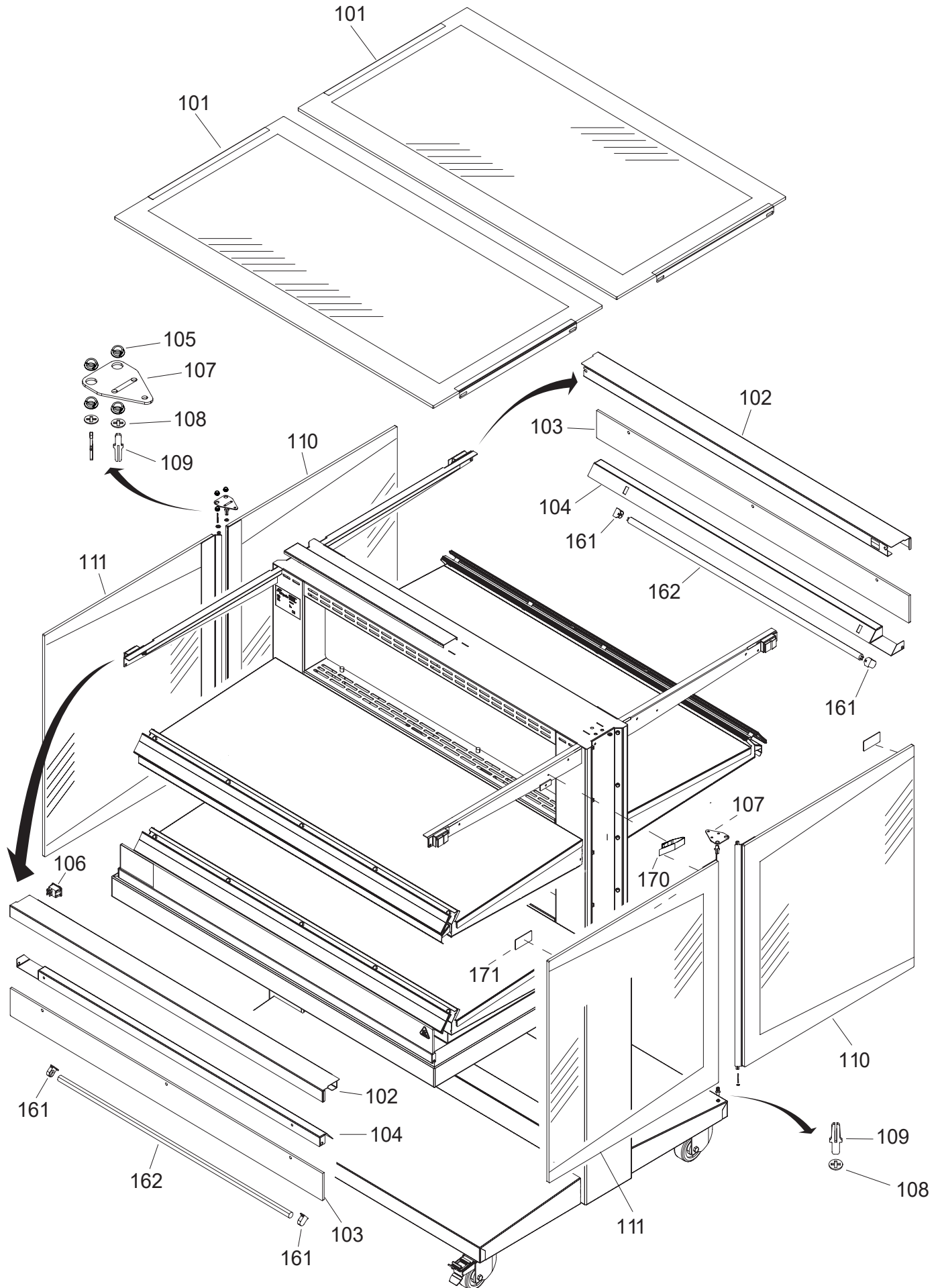

Pos	Part number	Description	Qty	Priority	Comment
101	9250119	Assembly Top glass	2,00	2	
102	9254038	Front Glass Clamp	2,00	2	
103	9252004	Front pane 120	2,00	2	
104	9254040	Inner TL / Front Glass Clamp 120	2,00	2	
106	9181008	Switch black 1-0 250 volt 22 x 30	1,00	2	
107	9254033	Side Door Hinge Top	2,00	2	
105	909274	Plate bearing	4,00	2	
108	9254010	Ring 0.8 mm	8,00	2	
109	9254011	Glass Holder Plugin	4,00	2	
110	9250117	Side door glass left	2,00	2	
111	9250104	Side door glass right	2,00	2	
161	9221025	Lamp base G5 piercing	4,00	2	
170	9252006	Opening angle restraint	2,00	2	
171	9254014	Magnet Locking Plate Glass	2,00	2	

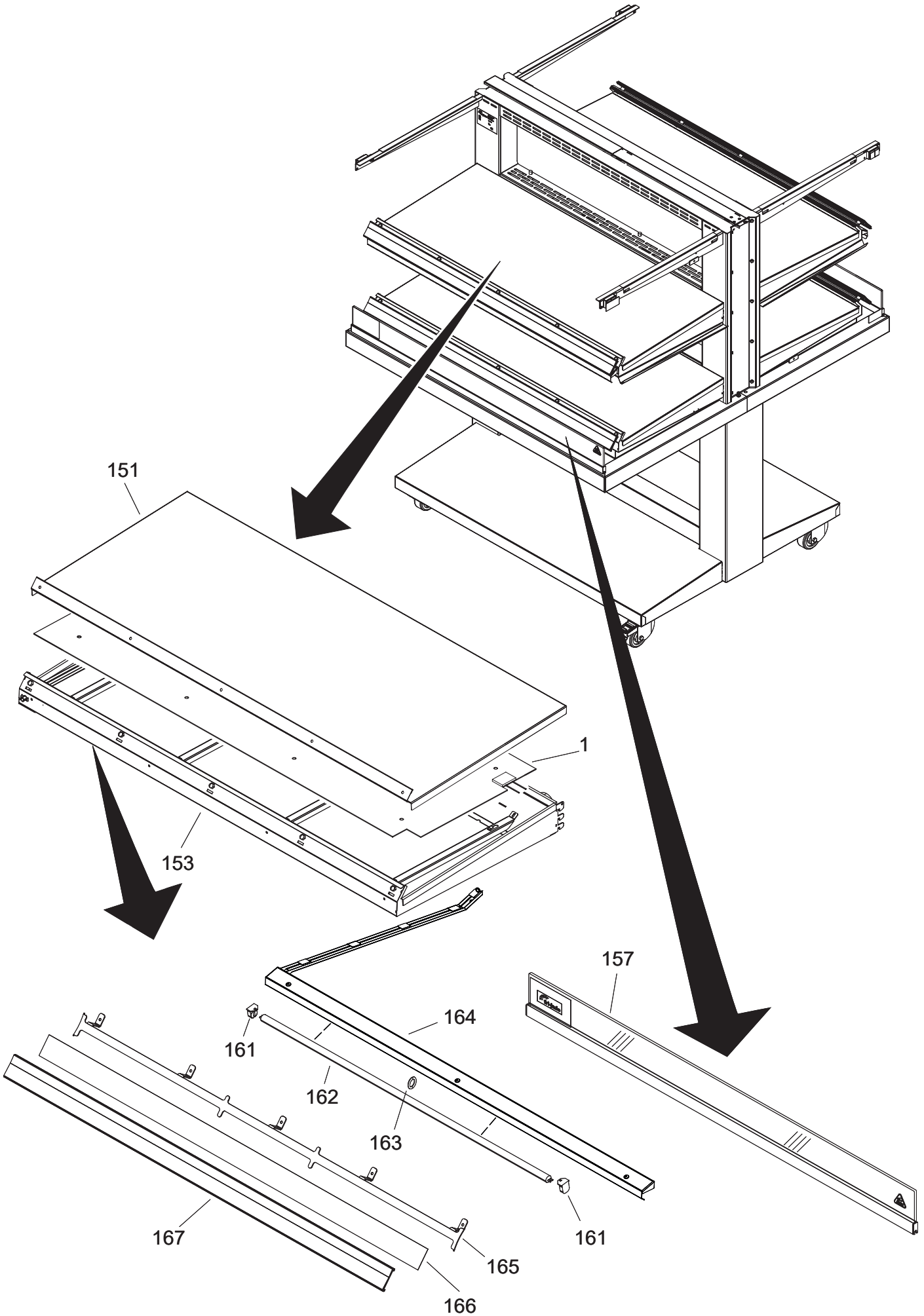

Pos	Part number	Description	Qty	Prio- rity	Com- ment
1	9222428	Heating element 1060 W	4,00	2	
151	9226602	Top plate shelf	2,00	2	
153	9220250	Assembly. underside shelf	2,00	2	
157	9250108	Ass. Child guard	2,00	1	
161	9221025	Lamp base G5	4,00	2	
162	9221027	TL5 21W / 830 foodsave	2,00	2	
163	9221050	O-ring precision inner ø18x5 viton 70	2,00	2	
164	9220252	Assembly lighting 120	2,00	2	
165	9226555	Holder price rail	2,00	2	
166	9222624	Photographic print 4 120mm	2,00	2	
167	9223207	Rail price 120 MD120	2,00	2	

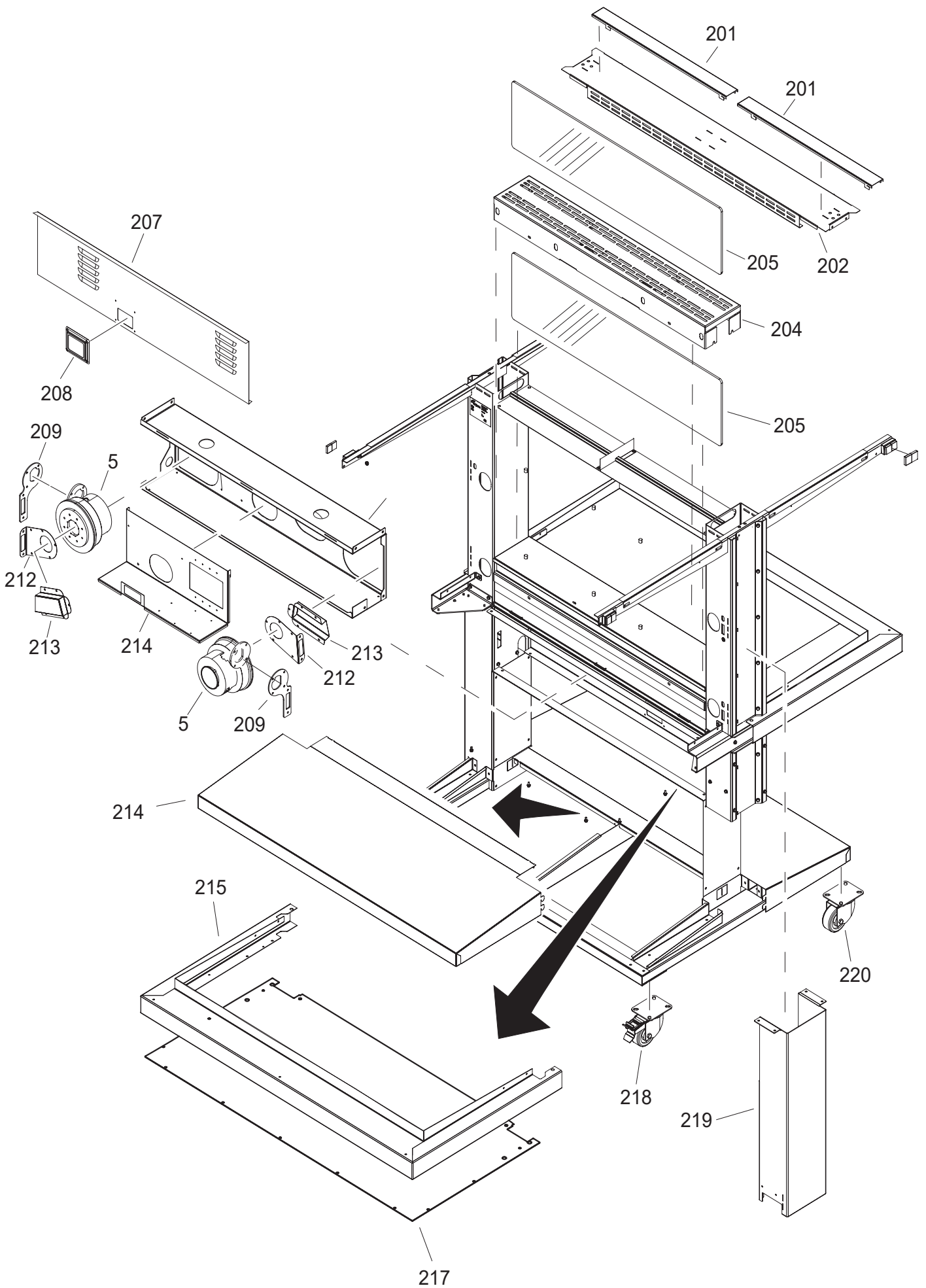

Pos	Part number	Description	Qty	Prio- rity	Com- ment
5	9221075	Blower	2	1	
201	9254030	Cover Section 120	2,00	3	
202	9254029	Middle Ventilation Section 120	1,00	2	
204	9254025	Middle Glass Support Plateau	1,00	2	
205	9252000	Middle glass 120	2,00	2	
207	9254037	Fan and Electro box hood	1,00	1	
208	9194485	Frame Halogen lighting	1,00	2	
209	9252003	Fan-column seal	2,00	2	
212	9254009	Mounting plate fan	2,00	2	
213	9254008	Fan box	2,00	2	
214	9254020	Cover plate	2,00	2	
215	9254024	Frame HI-120	2,00	2	
217	9254026	Panel	2,00	2	
218	9172066	Swivel castor with brake, LHCD 80KM RO SP TS	2,00	2	
219	9254017	Vertical collumn Island Cart	2,00	2	
220	9172065	Swivel castor LPHD 80KM RO	2,00	2	

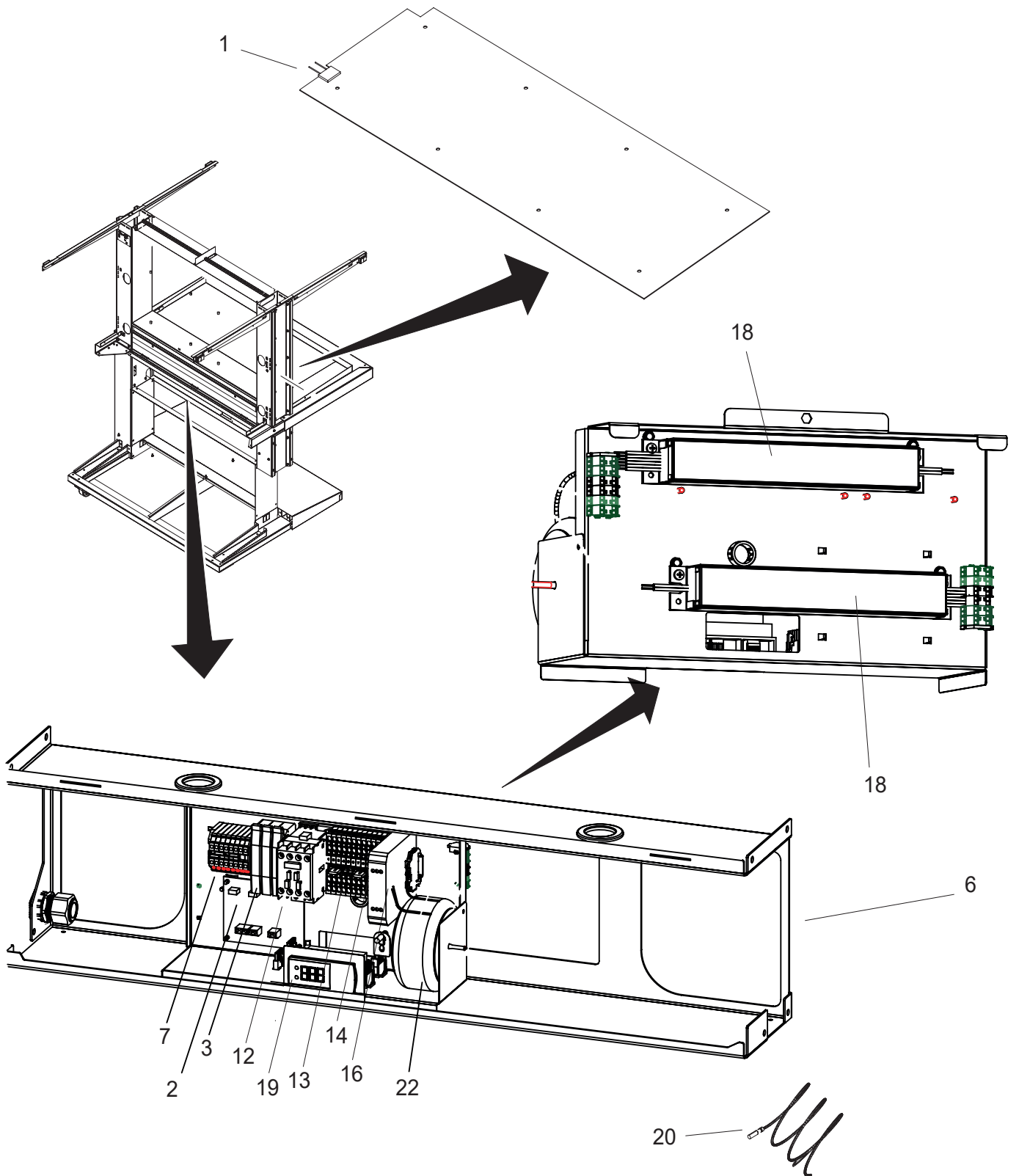

Pos	Part number	Description	Qty	Priority	Comment
1	9222428	Heating element 1060 W	4,00	2	
3	9261169	Fuse ceramic 2,5A	1,00	1	
3	9191197	Fuse 10A	2,00	1	
3	9191218	Fuse holder	3,00	2	
2	9171109	PCB Speed control 24V	2,00	2	
6	9250211	Assembly Electro box	1,00	1	
7	9191254	Terminal block 1 to 6 + 2A	1,00	2	
12	3500069	Contacteur 20-amp 230V	1,00	2	
13	9191238	Bar jumper, 2 contacts	4,00	2	
14	9191240	Terminal rail mounted, 4 pole	5,00	2	
16	9301033	Power supply 24 volt	1,00	2	
18	9221069	Ballast F28T5, F21T5, F14T5 HE	2,00	2	
19	9221109	Thermostat ERC 211	1,00	1	
20	9221011	Sensor PTC 1000	1,00	1	
22	9222302	Trafo 208-120V UL 6N1753	1,00	2	

EMPTY PAGE

EMPTY PAGE

