

Installation Guide

Please visit <https://www.follettice.com/technicaldocuments> for the Operation and Service manual for your unit



Welcome to Follett

Follett Products LLC equipment enjoys a well-deserved reputation for excellent performance, long-term reliability and outstanding after-the-sale support. To ensure that this equipment delivers that same degree of service, review this guide carefully before you begin your installation.

Should you need technical help, please call our Technical Service group at (877) 612-5086 or (610) 252-7301.

Please have your model number, serial number and complete and detailed explanation of the problem when contacting Technical Service.

Getting Started

After uncrating and removing all packing material, inspect the equipment for concealed shipping damage. All freight is to be inspected upon delivery. If visible signs of damage exist, please refuse delivery or sign your delivery receipt “damaged.” Follett Customer Service must be notified within 48 hours. Wherever possible, please include detailed photos of the damage with the original packaging so that we may start the freight claim process.

⚠ CAUTION!

- Do not tilt any unit further than 30° off vertical during uncrating or installation.
 - If the equipment is not transported vertically, a period of at least 24 hours must be allowed before starting. The equipment must be transported and handled exclusively in upright position. This is required to avoid contamination of the refrigerant with compressor oil. Contamination could result in valve and heat exchanger coil failure, problems starting the electric motor, or the risk of gas leak. The manufacturer is not responsible for any problems due to transport executed in conditions other than those specified.
- Controller board is susceptible to electrostatic discharge. Extreme care should be exercised by using a grounding strap when handling and installing control board.
- Refrigeration module area contains mechanical, moving parts. Keep hands and arms clear of this area at all times. If access to this area is required, power to unit must be disconnected first.

	FZRVAC20-LB	FZRVAC25-LB
Capacity	19.7 cu ft (558 L)	24.6 cu ft (697 L)
Usable space	12.8 cu ft (0.36 cu meters)	16.4 cu ft (0.46 cu meters)
Storage system	(4) epoxy-coated shelves	(4) epoxy-coated shelves
Exterior width	29.75" (76 cm)	29.75" (76 cm)
Exterior depth	29" (74 cm)	35" (89 cm)
Exterior depth with handles	30.5" (78 cm)	36.5" (93 cm)
Exterior height with casters	79.5" (202 cm)	79.5" (202 cm)
Interior dimensions (W x D x H)	24" x 22.5" x 56" (61 cm x 58 cm x 143 cm)	24" x 28.5" x 56" (61 cm x 73 cm x 143 cm)
Crated weight	438 lb (199 kg)	467 lb (212 kg)
Max. heat rejection	2400 BTU/hr	2400 BTU/hr

Standard features – all models	
Door	Solid, insulated, stainless steel
Door handle	ADA-compliant, full length handle with integral lock
Interior/exterior material	Heavy-duty, corrosion resistant stainless steel
Casters	(4) dual-wheel swiveling casters with toe locks
Insulation	2.75" (7 cm) thick, CFC-free foam insulation throughout
Air circulation system	Ducted air through back plenum openings (12 - LB) with front face return
Temperature probe	Stainless steel RTD (resistance temperature detectors). One at top on all models.

Refrigeration System

The FZRVAC20/25 series refrigeration system is designed to give many years of trouble-free service. Except for routine cleaning of the air-cooled condenser and related parts, the refrigeration system requires no service or maintenance. The system uses a thermostatic expansion valve (TXV) metering device and is critically charged. Access fittings are not provided. Temporary piercing valves are required to work on the refrigeration system. Follett recommends that if hoses are ever connected to the refrigeration system for service, the refrigerant should be recovered, permanent access valves should be installed and the system evacuated, and recharged by weighing in the correct refrigerant charge (10.6 oz. (300g) R404a).

Note: Do not charge the system by pressures.

Ambients

Intended for indoor use where ambient temperature does not exceed 86 F (30 C) and ambient relative humidity does not exceed 60% RH.

Clearances

To ensure proper ventilation of the refrigeration system, the following clearances are required:

- 16 inches (41 cm) above the freezer
- 2 inches (5 cm) behind freezer
- 9 inches (23 cm) on the left side. If the ambient is <86 F (30 C), no side clearance is required.

Electrical specifications

- 120 V, 60 Hz, 1 phase
- Full load amps: 12FLA, 67 LRA compressor
- Minimum circuit ampacity: 25A with max 60 ft. (18.2 m) wire run between receptacle and breaker using minimum 12 AWG
- Minimum voltage at compressor terminals: 97 Vac when energized
- **Maximum size of branch circuit overcurrent device: 20A dedicated circuit**

Refrigeration specifications

- Refrigerant R404a, 10.6 oz (300 g)
- Compressor amperage: RLA - 9.8A, LRA - 67A
- Compressor winding resistances: C-S (3.5Ω), C-R (0.7Ω), S-R (4.2Ω)
- Evaporator fan motor: RLA - 0.28A, 38Ω or 95Ω
- Condenser fan motor: RLA - 0.58A, 35Ω

Condenser Fan Motor Data:

RLA 0.58A

Ohm 35Ω

Defrost Heater Data:

Evaporator Heater: 400 W, 2.98A–4.0A, 31Ω–35Ω

Drain Pan Heater: 85 W, 0.63A–0.86A, 148Ω–163Ω

Drain Tube Heater: 15 W, 0.11A–0.15A, 909Ω–1005Ω



Total in parallel: 3.88A–5.24A, 25Ω–28Ω

Fascia Heater Data: 70 W, 0.47A–0.65A, 196Ω–216Ω

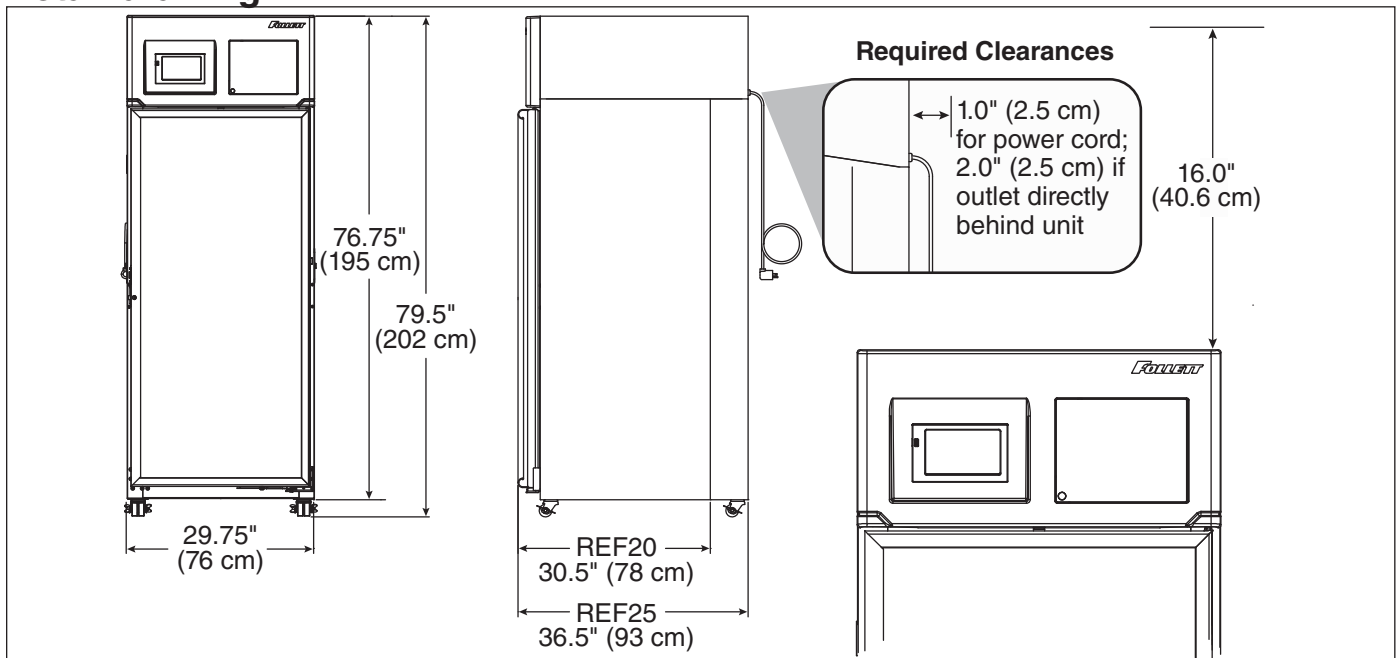
Detail drawing



Installation

 DANGER	
	<ul style="list-style-type: none">• Do not tilt any unit further than 30° off vertical during uncrating or installation• Refrigeration module area contains mechanical, moving parts. Keep hands and arms clear of this area at all times. If access to this area is required, power to unit must be disconnected first.

1. Remove key taped to side of freezer cabinet and unlock door.
2. Remove casters from box packed inside freezer.
Note: California facilities requiring wall and floor anchors – refer to wall anchor kit instructions (#00938241) packed with seismic kit before proceeding with caster installation.
3. Unbolt freezer from pallet.
4. Rotate freezer on pallet to install casters (**Fig. 1.1**).
5. Install casters by hand one at a time using channel locks to tighten, until caster meets against the bottom of cabinet (**Fig. 1.2**).
6. Peel protective film from exterior walls of stainless cabinet.

Adjust self-closing door

1. Roll freezer to desired location and lock as many casters as possible (**Fig 2.1**).
2. If the door appears to be sagging, remove the philips screw (**Fig. 2.2**) holding the Hold Open Bracket to the Hinge Bracket to gain access to the Sag Adjustment Screw (**Fig. 2.3**). Turn the Sag Adjustment Screw to align the door squarely with the freezer cabinet. When finished, reinstall the Hold Open Bracket.
3. Check door for closing tension and adjust if necessary. To check closing tension, open door 1" and turn screw (**Fig. 2.4**) counterclockwise until you achieve positive close. (Light will go out) Then, turn another half turn counterclockwise.

Fig. 1

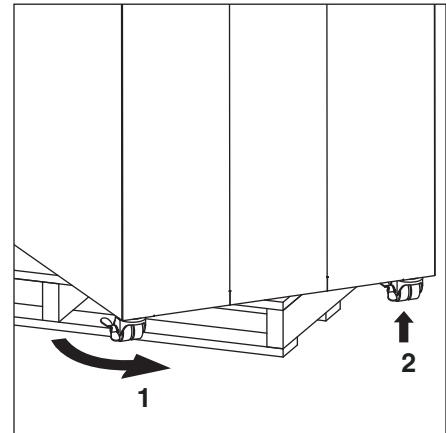
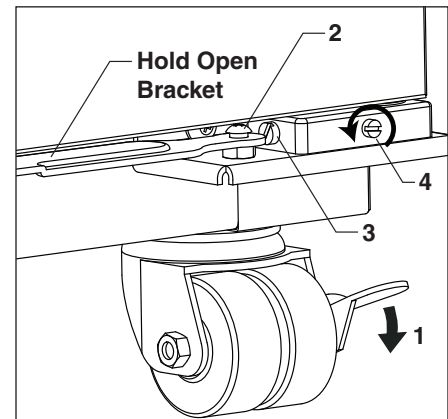

Fig. 2



Install shelves and power up

1. If freezer is equipped with shelves, remove bag containing shelves supports and position them in desired locations on each pilaster and insert shelves (**Fig. 3**).
2. Plug freezer into a 120 V 60 Hz 15A dedicated outlet.

Fig. 3

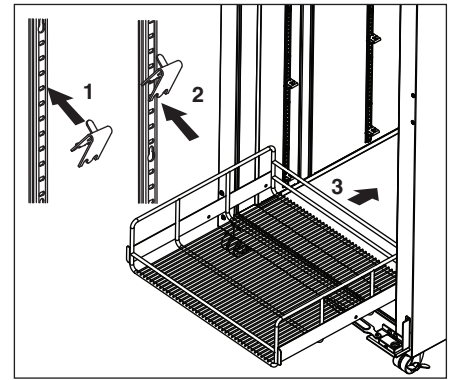

Fill product bottle

1. Remove probe and cap from the top bottle and fill with glycerine supplied with unit (e.g., 60% glycerine and 40% water) (**Fig. 4**). Replace cap and reinsert probe sensor.

Fig. 4

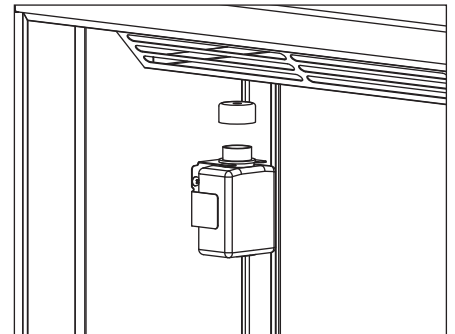

ATTENTION INSTALLER

- It is imperative that the top/bottom probe bottle be filled with a solution that your facility uses to ensure proper operation of unit.
 - Units are equipped with a third-party monitor installation port. Customers are required to refer to CDC Vaccine and Handling Toolkit (cdc.gov) for proper placement of the probe within the cabinet to ensure proper performance.
 - NSF 456 requires the temperature display probe (P4-RTD1 in REF12, REF20/25, FZR20/25, and REF45 models) to be replaced or recalibrated. Follett recommends replacement/recalibration 12 months from the original date of calibration on the Certificate of Traceability supplied with your equipment at the time of purchase. Recalibration or purchasing a new calibrated probe is not covered by the original equipment warranty. To purchase a new Probe with Certificate of Traceability, please contact our Parts Department @ 1-877-612-5086 or partsales@follettice.com
2. Adhere supplied probe wire clips (x4, packaged with manual) to inside wall leading to the probe bottle.
 3. Route probe wire into clips and close the clips.

Power the Unit

1. Press lower left corner of front facade door to access power switch inside (**Fig. 5.1**).

Fig. 5

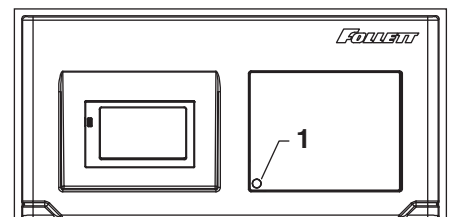

2. Press power switch to turn unit on (**Fig. 6.1**).
3. Connect wiring harness to back-up battery pack.

Fig. 6

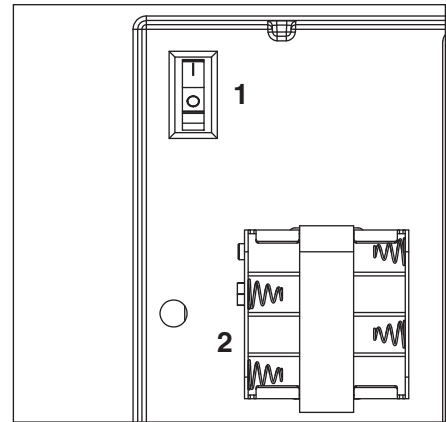

Third-party probe wire routing (if desired)

1. Use a drill or awl to prepare an opening to allow routing of the third-party probe into the cabinet at the location shown (**Fig. 7**).
2. Use permagum sealant to cover hole opening after probe is routed into cabinet.

Fig. 7 (top view)

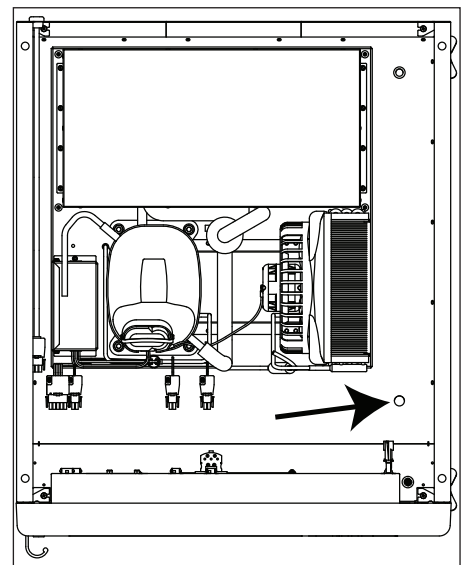

3. Remove front left and right return louver screws to uncover access port (**Fig. 8**).
4. Route probe wire down either side channel in cabinet.
5. Use permagum to seal around probe wire access hole.
6. Reinstall louver screws.

Fig. 8

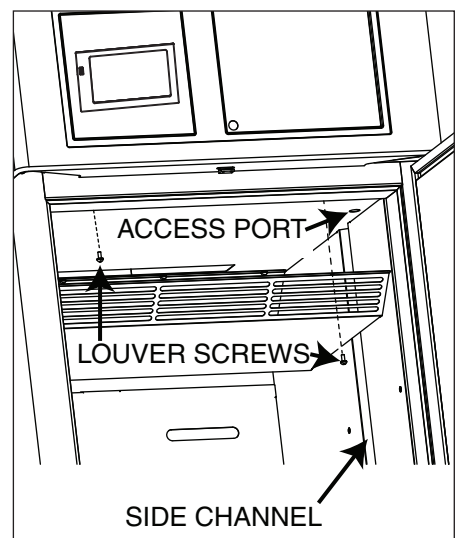

Controller Operation

Use and care of the LCD touchscreen

















The LCD touchscreen utilizes capacitive touch technology. This will allow you to engage the functionality by touching the screen with your fingers, even while you are wearing latex or cotton gloves. Functionality will not engage by touching with an inanimate object, such as a pen or stylus.

- To preserve optimal touch sensitivity, keep the screen clean by using a clean, dry cotton cloth.
- Do not expose the screen to liquids or excessive dust, heat or humidity.

Control function icons and navigation buttons engage functionality of the user interface. Status indicators alert the user to a change of status.

Home screen

The Home Screen consists of three primary information areas: the temperature display, control function display zone and system status display.

Control Functions	System Status	Functions and Settings
 Settings	 Compressor is running	 USB download available (downloading when blinking)
 Alarming	 Evaporator fan is running	 Refrigeration set points
 Light	 Door is open	 Sleep functions
 Information log	 Defrost cycle is in process	 Centigrade to Fahrenheit
 Help		 Probe set points
		 Alarming functions
		 Alarm mute
		 Reset

- Product temperature is displayed in the upper right corner.
- Current selected display probe above temperature readout.
- Primary control function icons are displayed in the lower left corner.
- System status icons will display in lower right corner to indicate a condition has been activated.

High and low temperature display

From the home screen touch the temperature display in the upper right corner. The high/low temperatures will appear below the temperature display. To the left of the high/low temperature, a time and date stamp will be displayed.

View min/max temperature log

1. Press the Temperature Display in the upper right hand corner of the display
 - Will initially display MIN/MAX temperature of Top probe.
2. Press a second time to prompt a reset Top probe MIN/MAX.
3. Press a third time to display HIGH/LOW alarm settings.

Fig. 9



Fig. 10



Fig. 11

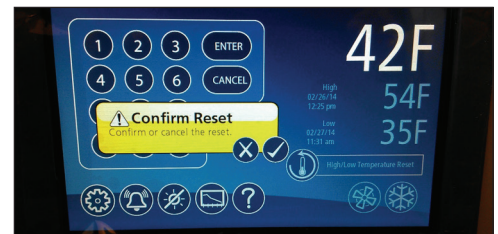

Reset the high and low temperatures

Touch the temperature display a second time and the reset function ⓘ will appear under the high and low temperature. Touch the reset icon and a yellow message box will appear. Press ✓ to confirm reset or ✗ to cancel.

Alarm set point display

From the home screen touch the temperature display three times. The High and low alarm set point will appear under the temperature.

VAC models have the alarms factory preset to -15 C (5 F) and -46 C (-50 F).

Help

- Help is available at any time by touching the ⓘ icon at the bottom of the screen.
- Help is screen-specific; touching the ⓘ icon will display an explanation of the functionality and use of the screen you are currently viewing.
- Touch ✓ to exit help screen.

Settings ⚙️

- Refrigeration Set Point ❄️
 - Touch the number displayed in the box to the right of the Set point label and use the keypad or **UP** and **DOWN** arrows to select product temperature. Press ✓ to accept or ✗ to cancel.
- Sleep Temperature Display 🌙
 - Toggle **ON** to hide the temperature reading immediately on the home screen.
- Set the Sleep Delay 🌙
 - To automatically hide the temperature after 0-600 seconds of inactivity, touch the box to the right of the delay (0-600) box. Use keypad or **UP** and **DOWN** arrows to select from 0-600.
- Temperature 🌡️
 - Toggle between **F** and **C** to select Fahrenheit or Celsius.
- Brightness 💡
 - Touch the number displayed in the box to the right of the Brightness 💡 icon and use the keypad or **UP** and **DOWN** arrows to select from 1-10. Press ✓ to accept or ✗ to cancel.

System Information

- Touch the System Info icon ⓘ to display the model number, unit serial number and software version. Touch the checkbox icon ✓ in the lower right corner of the box to clear.

Fig. 12



Fig. 13

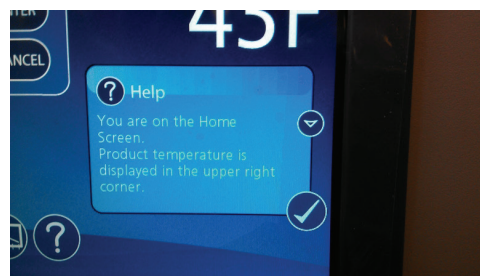

Fig. 14







Fig. 15

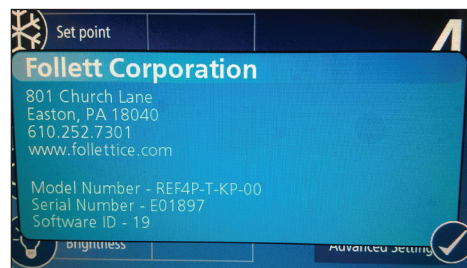

Fig. 16



Alarm or Alert Notifications

- If an alarm or event condition is detected and an alarm is engaged, an alert notification will appear in the left center of the screen with an explanation of the alert condition and a checkbox  at the bottom right of the alert box.
- No further action can be taken on the User Interface until the alert condition is acknowledged and cleared by touching the checkbox .
- Mute 
 - Touch the  icon to mute audible alarm for 10 minutes.

High/Low Alarm

- This unit is equipped with a High and Low Temperature alarm that will give an audible and visual alarm immediately after the top probe falls out of range. The alarm will reappear every 10 minutes until the condition falls back into range.

Door Switch

- This unit is equipped with a door switch that is located in the façade, and a magnet located on the top of the door. With the door closed, the switch reads closed. When the door is opened, the evaporator fans becomes de-energized.

Door Alarm

- This unit is equipped with a door ajar alarm that is factory set for 1 minute. In the event the door switch reads open for longer than 60 seconds (default) an audible and visual alarm will occur. The alarm will clear when the door is closed. The door alarm activation time can be changed from 0-600 seconds in the Advanced Settings Menu under Door Open Alarm Delay.

Power Alarm

- This unit is equipped with a Power Alarm that will sound if the unit loses power for more than five minutes. The Power Loss Alarm box will display every five minutes, then the screen will sleep. An audible alarm will sound every 30 seconds during the power failure. An alarm box will be displayed when power is restored. The event log will record the exact time and date of the power loss and when the power was restored.

Fig. 17

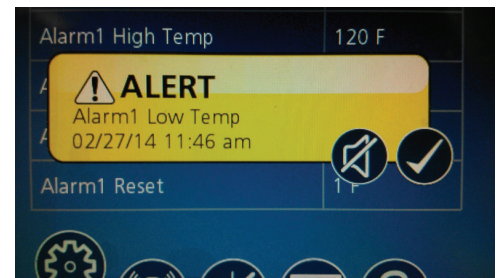

Start-up alarm delay

This unit has a 120 minute time delay between when the unit is energized to when the temperature alarms become active. This delay can be changed in parameters in the controller under **Alarm Startup Delay**.

Setting Alarms









- Alarming Settings control the conditions and timing of event and alarm conditions that result in audible and/or visual alerts.
- To change the high alarm set point, touch the number displayed in the box to the right of the  icon and use the keypad or **UP** and **DOWN** arrows to select an alarm value. Press  to accept or  to cancel.
- To change the low alarm set point, touch the number displayed in the box to the right of the  icon and use the keypad or **UP** and **DOWN** arrows to select alarm value. Press  to accept or  to cancel.
- Audible Alarm 
 - Toggle between **ON** and **OFF** to engage and disengage the audible alarm function.
- Mute 
 - Touch the  icon to mute audible alarm for 10 minutes.

Fig. 18



Alarming Contacts

This unit is equipped with dry contacts that may be connected to a 3rd party monitoring system. The contacts are located on the back of the facade. Touchscreen units utilize Alarm 1. Each set of dry contacts has a Common, a Normally Open and a Normally Closed connection point. By default, Alarm Relay 1 is set to activate with any of the following alarms: Alarm 1 High temp, Alarm 1 Low temp, Door Open Alarm, and Power Loss Alarm.

Fig. 19

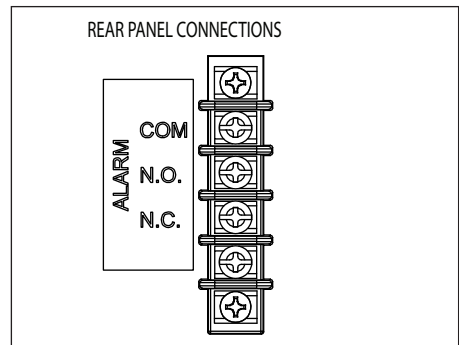

Probe calibration

NSF 456 requires the temperature display probe (P4-RTD1 in REF 12, REF 20/25, FZR 20/25, and REF 45 models) to be replaced or recalibrated. Follett recommends replacement/recalibration 12 months from the original date of calibration on the Certificate of Traceability supplied with your equipment at the time of purchase. Recalibration or purchasing a new calibrated probe is not covered by the original equipment warranty. To purchase a new Probe with Certificate of Traceability, please contact our Parts Department @ 1-877-612-5086 or partsales@follettice.com

The temperature probes can be offset -9.9 to $+9.9$ in the Advanced Menu settings to deliver a more precise temperature reading.

- Select Settings
- Select Advanced settings and enter code 1,1,1,1. Confirm with Check mark
- Using the DOWN arrow, scroll through Advanced Settings to Calibrate screen and select Calibrate
- Place desired probe (P1-control, P2-Defrost, P4-Top probe) in an ice bath and allow 3-5 minutes for temperature stabilization.
- Press "Offset" and use the UP/DOWN arrows to offset the probe reading to the proper value.

Note: In the event of a factory reset, the offset value will return to 0.

Screen saver

The screen saver will replace the home screen and display a blank screen, time and date, or the temperature. When the screen is touched or the unit has an alarm or event, it will return to the home screen. The screen saver can be changed in the advanced setting.

Screen saver function: blank, time and date, or temperature.

Screen saver time (sec): 0—600 seconds between the last touch of the screen to the activation of the screen saver.

Information Logs

- All available graphs, data logs and event logs are accessed through the Information Logs function. The home screen in the Information Logs section displays the product (P4) temperature graph with one week's data. Date and time information is displayed on the horizontal axis.
- This unit comes factory set to display only the product temperature (P4) on the graph. All of the probes can be viewed on the graph if desired. Probes can be added to the graph through the advanced setting under DATALOG. P1 and P2 can be added by selecting the probe and changing the parameter from No to Yes. The selected probe will now display on the graph.
 - P1 control, P2 defrost, P4/RTD1 (Top probe)
- Zoom in (+) or Zoom out (–) on an event/temperature on the home screen will change the time scale.
- Using the left and right arrows below the graph will scroll the graph. All the stored temperature data on the graph is viewable.
- Temperature Log – to display a chronological listing of logged temperatures (latest logged temperature will display first), touch the **Temperature Log** label to the left of the screen. Use the **UP** and **DOWN** arrows to the right of the screen to scroll through the logged temperatures.
- Event Log – to display a chronological listing of events (including errors, alarms and alerts), touch the **Event Log** label to the left of the screen. Use the **UP** and **DOWN** arrows to the right of the screen to scroll through the logged temperatures.

Fig. 20

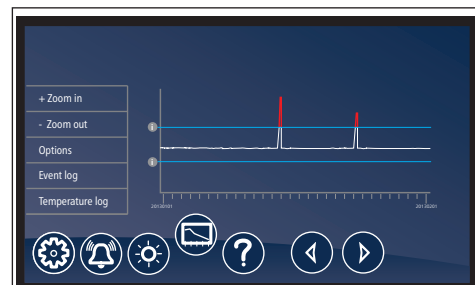

Fig. 21

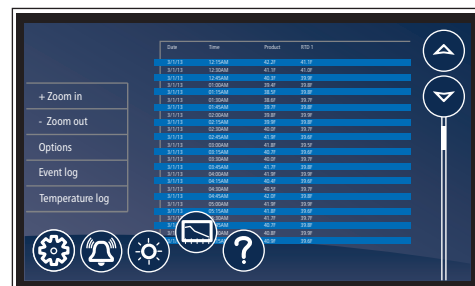
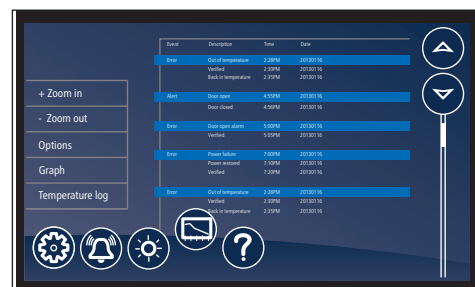

Fig. 22



Data logging

- The controller is capable of storing up to 50,000 readings per probe. The factory setting for the sample rate is every 15 minutes, which will provide enough storage for 520 days. The sample rate can be changed to provide data logging for a longer or shorter time interval by changing the **Sample Rate (Min)** in the advanced settings menu. **0 = off and 360 minutes maximum.**

Data Storage

- Data can be captured different ways. The factory default is for the data to overwrite itself when the memory is full. This can be changed in the advanced setting under **Data storage overwrite**. When this parameter is set to **No**, the system will display an alert when the memory is 75% full. To clear the alert the data must be downloaded.

Data duration alarm

- A reminder can be set to download the data in the **Data duration alarm** in the advanced setting. The data duration can be set from **1 to 180 days**. If the data duration alarm is used, then the **Alarm on data full** parameter in the advanced setting must also be set to **Yes**.

Downloading data

- The touchscreen has the capability of downloading the temperature data and event log via a USB port on the left side of the user interface. The file is a CSV format and is suitable for import directly into Microsoft Excel.

1. Insert the storage device in the USB slot located to the left of the Touchscreen.
2. Select the Graph icon along the bottom of the Touchscreen.
3. Select the USB icon in the lower right hand corner.
4. A yellow alert box with **downloading data** will appear.
5. Press to accept or to cancel.
6. After the unit is done downloading a second yellow alert box will appear asking if you want to **Erase log**.
7. Press to accept or to cancel.

Note: If you chose to erase the data, the data duration timer and the data full alarm will reset. It will also erase the information that is stored on the graph.

One of the two files below will be downloaded depending on which screen is being viewed:

EL XXXX YY - Event Log

TL XXX YY - Temperature Log

XXXX = last 4 digits of serial number

YY = 0-99 number of downloaded file

Data download reminder and data full alarm

- If you plan or are required to download data for a certain time period, you can set a **download data reminder** on the Performance Plus unit. Download data reminder can be found in the advanced setting under **Data duration** and can be set from **1 to 180 days**.







Fig. 23













Fig. 24



Changing and Adding the User Codes

1. Touch Settings  icon.
1. Touch **Advanced Settings**, enter your 4-digit user access code (factory default is 1 1 1 1) in the keypad that appears, and touch the checkmark icon  to access advanced settings screens.
2. Time and date will be displayed. Scroll using the **UP** and **DOWN** arrows until **Change Access Code** is displayed in the Display Setup screen.
3. Touch **Change Access Code** and enter the master code [ENTER]. (By default, the master code is 1 2 3 4 5 6.)
4. Touch the screen to the right of the user code 2 to 40 to overwrite or add the user code.
5. Enter the new code. Press  to accept or  to cancel.
6. Enter the new code again. Press  to accept or  to cancel.
7. Press **DONE** when finished entering access codes.

Time and Date

- To set time and date, press the Settings  icon.
- To display options, touch **Advanced Settings**, enter your 4-digit user access code in the keypad that appears, and touch the checkmark icon  to access advanced settings screens (factory default is 1111).
- Time: touch displayed time and use the keypad to enter the time. Press  to accept or  to cancel.
- AM/PM: touch displayed value to toggle between AM and PM.
- Month: touch number displayed and use the keypad to enter the month. Press  to accept or  to cancel.
- Day: touch number displayed and use the keypad to enter the day. Press  to accept or  to cancel.
- Year: touch number displayed and use the keypad to enter the year. Press  to accept or  to cancel.

Advanced Settings

- Touch **Advanced Settings**, enter your 4-digit user access code in the keypad that appears, and touch the checkmark icon  to access advanced settings screens (factory default is 1111).

Fig. 25

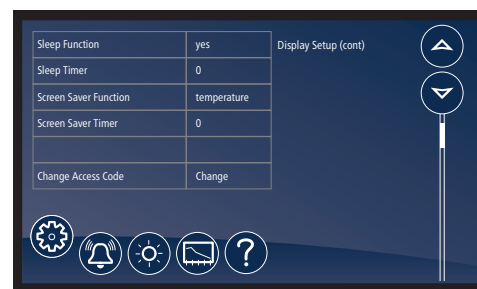
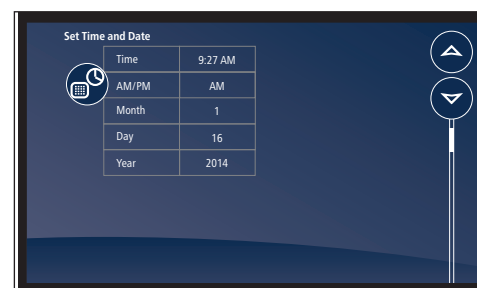

Fig. 26



Fig. 27



Removing drawers

1. Pull drawer forward to stop (**Fig. 28.1**).
2. Lift drawer front to free front rollers from slides (**Fig. 28.2**).
3. Still lifted, pull drawer forward to free back rollers from slides.

Fig. 28

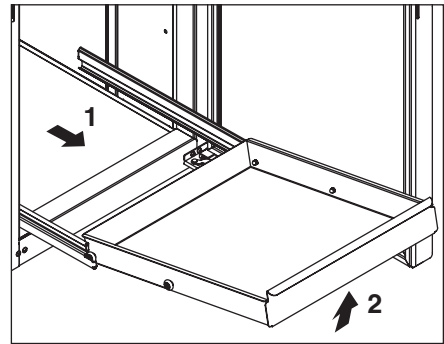

Removing slides

1. Push slides all the way back.
2. Swing bottom of slide away from freezer wall and lift slide off rollers.

Facade removal

The facade is removed by loosening the top left and right Phillips screws on the back of the facade to allow the securing clips to rotate away from the side panels. The facade can simply pull off of the front by pulling it out of the bayonet mounts that secure it to the upper left and right panels. If the facade will be completely removed, the electrical plugs should be disconnected. The ground wire should be removed from the top right grounding screw on the cabinet box, not from the facade (**Fig. 29.1**).

Fig. 29

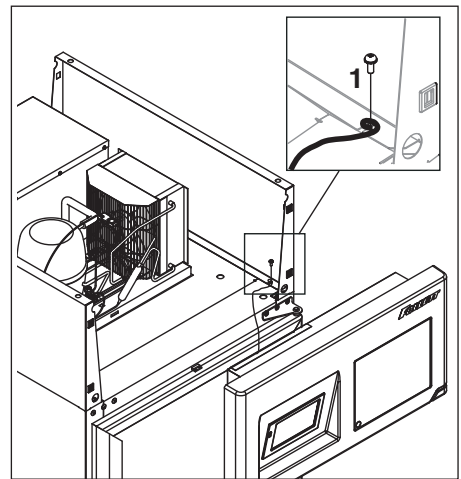

Cleaning

Use non chlorine-based cleaners. Cleaners containing chlorine can cause staining and pitting of the stainless steel.

Disconnect power to unit by turning the power switch off, located on the upper front facade panel, and removing the power cord from the receptacle.

Interior cleaning

Using a sponge or soft cloth, clean unit with a non-abrasive, non-chlorinated, all-purpose detergent. Note: The air plenum should be removed to clean it, as well as behind it (**Fig. 30, 31**). In addition, the shelves should be cleaned as well.

Exterior cleaning

Wipe stainless steel exterior with a soft cloth in the direction of grain as needed. Stainless steel polish may be used to enhance the finish of the unit. The glass door and exterior parts may be cleaned with a soft cloth, window cleaner or other non-abrasive cleaner.

Fig. 30

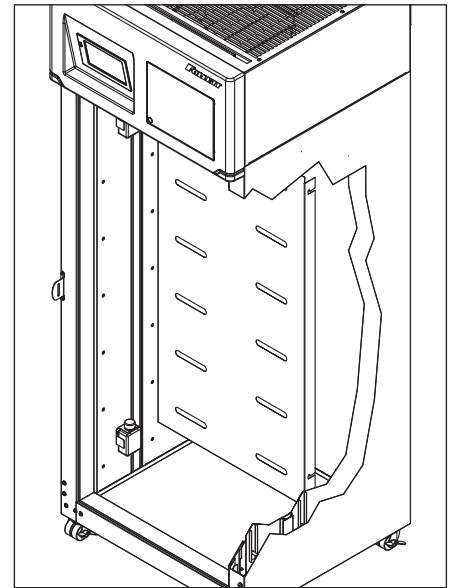
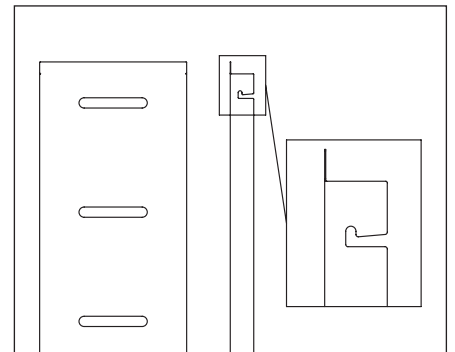

Fig. 31



Annual cleaning

Removal of dust and other particulates from air intake areas and the condenser is important for proper operation. Environments with large amounts of dust may require more frequent cleaning.

1. Disconnect power to unit by turning power switch off (located on upper front facade panel) and removing power cord from receptacle.
2. The condenser can be accessed from top for cleaning. The side panel in front of condenser may be completely removed for easier cleaning by disconnecting facade and removing upper side panel. See Face Removal for facade removal instructions.
3. Inspect drain pan for any debris or obstruction in condensate pan (**Fig. 32.1**).
4. Use a vacuum cleaner with brush attachment to clean condenser, compressor and related parts.
5. Reinstall upper side panel and facade if removed.

Fig. 32

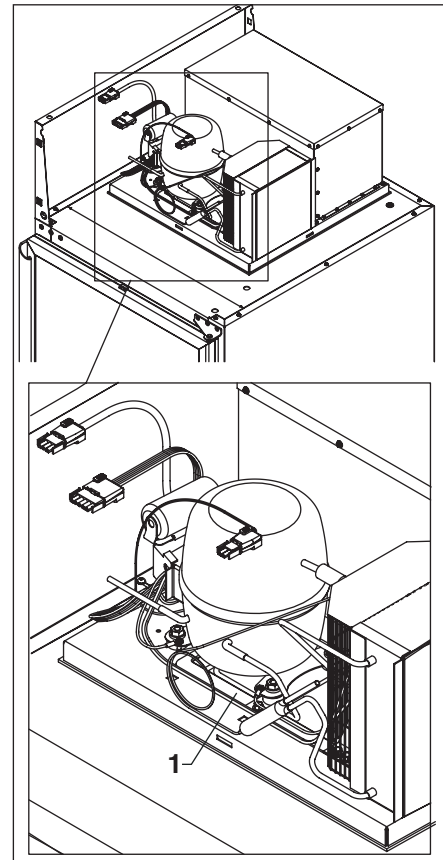

Defrosting

The FZR20/25 series upright freezers control frost accumulation on the evaporator through automatic timed defrost cycles. The evaporator defrosts automatically every 6 hours. The evaporator face mount heater, drain pan heater, and condensate drain line heater energize and any accumulated ice on the evaporator and evaporator drain pan melts and drains out the drain line to the condensate pan located under the compressor. Defrosting will display on the main screen above the product temperature button. Defrost terminates when either 30 minutes has elapsed or the evaporator temperature reading from the defrost probe (P2) reaches 5.0 C (41 F).

Service - System Controls

The temperature controller and evaporator probe (P1-control) indicate when the refrigeration system is required to turn on and off.

The refrigeration system removes heat from the cabinet and rejects it into the surrounding room air.

When the evaporator probe (P1-Control) reaches its predetermined cut-in value (Advanced settings, Viewable), the probe signals the controller to turn on the refrigeration system. The controller sends a 12VDC signal to the normally open compressor relay. The relay then closes, energizing the compressor and condenser fan.

When evaporator probe (P1-control) reaches its predetermined cut-out value (Advanced Settings-Viewable), the controller interrupts the 12VDC signal to the compressor relay, de-energizing the compressor and condenser fan. The evaporator fan runs continuously.

Controller Operation

The controller displays product temperature in degrees C (default) or F to 1 decimal point.

VAC Lab Models

The controller is pre-programmed to deliver approximately –23.9 C (–11 F) product temperature.

All set point operate with a 3.3 C (5.9 F) evaporator offset and a 4.4 C (7.9 F) differential. The set point, along with the differential, determine the cut-in and cut out points of the cooling system. For instance, a unit operating with a –23.9 C (–11 F) set point will cut-in at –20.7 C (–5.1 F) and cut-out at –25.1 C (–13F) according to the P1 control probe located in the return air stream. Cut-in and Cut-out parameters are Viewable in the Advanced Settings Menu.

Sensor Readings/Temperature Display

The Touchscreen is defaulted to display the P4-Top probe which reads the solution temperature of your product simulation bottle. For ease of troubleshooting, the Touchscreen can be toggled to display the P1-control, P2 defrost. To toggle the display for your desired probe, Access Advanced Settings>Display Probe and select the desired probe.

Note: After service is complete it is recommended to restore the display to the P4-Top probe.

Fascia Heater

Factory default for the fascia heater cycle is set to 75%, based on a 20 minute cycle (e.g. 75% = 5 minutes off, 15 minutes on).

Should the need arise, the door schedule can be changed in Advanced Menu>Door Heater.

Reversing the door swing (requires a new door)

FZRVAC20/25 units ship standard with a non heated right hinged door. To change to a left hinged configuration requires a new door.

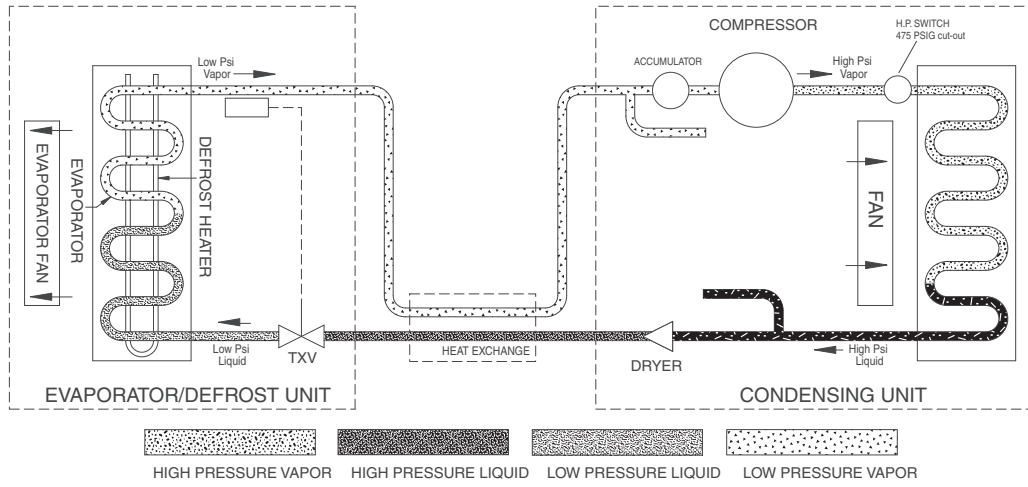

Warranty Registration and Equipment Evaluation

Thank you for purchasing Follett® equipment. We hope you find that our equipment meets or exceeds your expectations, as our goal is to deliver high value products and services that earn your complete satisfaction!

Please review the enclosed installation and operations manual. It is important that the installation be performed to factory specifications, so your equipment operates to its maximum efficiency.

Follett LLC will not be liable for any consequential damages, expenses, connecting or disconnecting charges or any losses resulting from a defect of the machine.

For full warranty details, visit our website www.follettice.com/productwarranties.

Warranty registration and equipment evaluation is important to help us keep track of our equipment and to record the machine's performance. We request that you register Follett equipment warranties on our website www.follettice.com/support and choose Warranty Registration and Equipment Evaluation. It's simple to do; please take a moment to register today. There is also space on the form to provide us with comments and feedback. Please let us know about your experience so we can capture it for our continuous improvement efforts.

We pride ourselves on producing outstanding equipment and we work hard to back it up with outstanding customer and technical support. Please let us know what else we can do to assist you. We would be happy to answer your questions.

Follett HEALTHCARE and Follett are registered trademarks of Follett Products, LLC, registered in the US.



801 Church Lane • Easton, PA 18040, USA
Toll free (877) 612-5086 • +1 (610) 252-7301
www.follettice.com/healthcare

01441500R00
© Follett Products, LLC 8/22