

**Installation Guide  
Serial numbers after L31321**

Please visit <https://www.follettice.com/technicaldocuments>  
for the Operation and Service manual for your unit

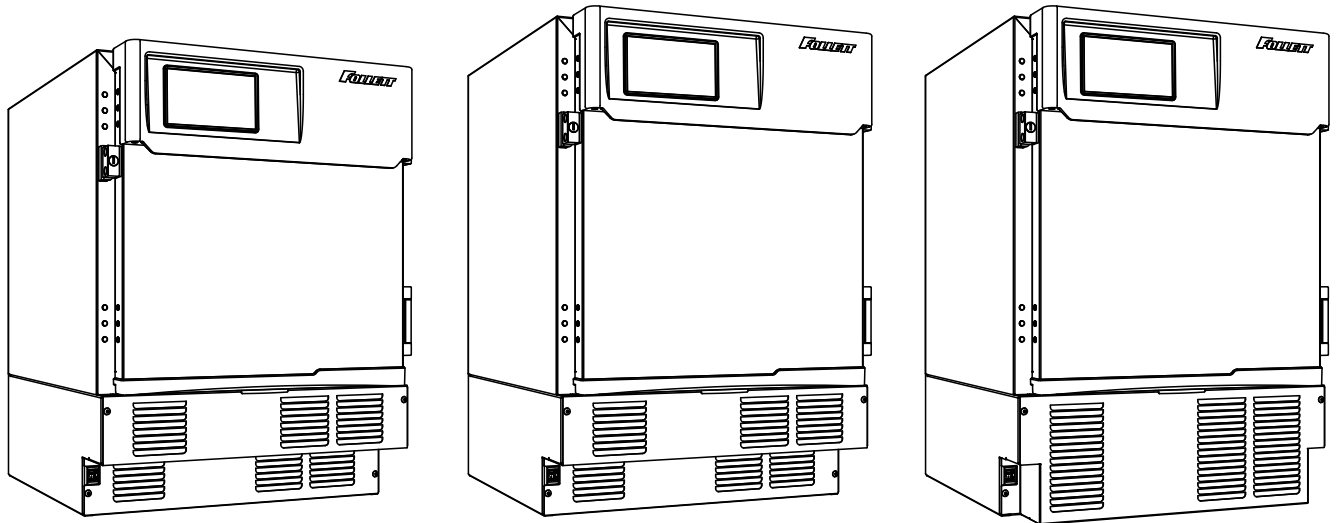

## Welcome to Follett Products LLC

Follett Products equipment enjoys a well-deserved reputation for excellent performance, long-term reliability and outstanding after-the-sale support. To ensure that this equipment delivers that same degree of service, review this guide carefully before you begin your installation.

Should you need technical help, please call our Technical Service group at (877) 612-5086 or (610) 252-7301.

Please have your model number, serial number and complete and detailed explanation of the problem when contacting Technical Service.

## Getting Started

After uncrating and removing all packing material, inspect the equipment for concealed shipping damage. All freight is to be inspected upon delivery. If visible signs of damage exist, please refuse delivery or sign your delivery receipt "damaged." Follett Customer Service must be notified within 48 hours. Wherever possible, please include detailed photos of the damage with the original packaging so that we may start the freight claim process.

# Contents

<b>Welcome to Follett Products LLC</b> .....	<b>1</b>
Getting Started.....	1
<b>Specifications</b> .....	<b>4</b>
Electrical Specifications.....	4
Refrigeration Specifications.....	4
Installation Specifications.....	4
<b>Installation</b> .....	<b>5</b>
Installing Levelers.....	5
Battery Backup (Touchscreen and Keypad units only).....	5
Installing Shelves.....	6
Installing Drawer.....	6
Third-party Probe - Optional.....	6
Reversing the Door Swing – Optional.....	7
Installing Glycerine Solution in Product Simulation Bottle.....	10
<b>Operation</b> .....	<b>11</b>
Temperature Control.....	11
Defrosting.....	11
<b>Controller Operation - Performance Plus</b> .....	<b>12</b>
Controller Display.....	12
Controller Security.....	12
Changing Temperature Display from C to F.....	12
Sleep Function.....	12
Temp Log.....	13
Alarming Functions.....	13
Follett Keypad Lock.....	15
<b>Controller Operation - Performance Plus Touchscreen</b> .....	<b>17</b>
Use and care of the LCD Performance Plus Touchscreen.....	17
<b>Cleaning</b> .....	<b>24</b>
Annual Cleaning.....	24
Wiring Diagram.....	25
Refrigeration System.....	26
Checking Refrigeration System Pressures.....	26
<b>Compressor Information</b> .....	<b>27</b>
<b>Troubleshooting</b> .....	<b>27</b>
<b>Accessories</b> .....	<b>28</b>

Model Number	Item Number	User Interface		Keypad Lock	Stackable/ Use with Pedestal	Ships with Chart Recorder	Drawer
		Performance Plus	Performance Plus Touchscreen				
FZR4P	FZR4P-0-00-00	X			X		
	FZR4P-0-KP-00	X			X		
	FZR4P-T-00-00		X		X		
	FZR4P-T-KP-00		X	X	X		
FZR5P	FZR5P-0-00-00	X			X		
	FZR5P-0-KP-00	X		X	X		
	FZR5P-T-00-00		X		X		
	FZR5P-T-KP-00		X	X	X		
FZR5PLP-T	FZR5PLP-T-00-00		X		X		X
	FZR5PLP-T-KP-00		X	X	X	X	X

## Specifications

FZR4P	31.38" (79.7 cm) H x 23.75" (60.3 cm) W x 27" (68.5 cm) D	Fits below 34" (86.4 cm) high ADA-compatible counter	3.9 cu ft capacity
FZR5P	34.00" height (86.4 cm) H x 23.75" (60.3 cm) W x 27" (68.5 cm) D	Fits below standard 36" (91.4 cm) high counter	4.5 cu ft capacity
FZR5PLP-T	34.00" (86.3 cm) height x 23.75" (60.3 cm) width x 27" (68.5 cm) depth	Fits below standard 36" (91.4 cm) high counter	2 drawers with total storage of 40 cardboard plasma packs 300 ml/pack); max. drawer load of 35 lb (16 kg) each

## Electrical Specifications

- 115 V, 60 Hz, 1 phase
- Full load: 6.7A
- Minimum circuit ampacity: 15A
- Connect to dedicated circuit, fuse or breaker
- Maximum size of branch circuit overcurrent device: 15A
- Follett recommends circuit be protected by GFCI

## Refrigeration Specifications

Refrigerant	Charge Size (oz)	Maximum Design Pressures (psi)	
		High Side	Low Side
R404A	10	385	174

## Installation Specifications

Ambient temperature must not exceed 39 C (100 F).

The front louvered panel must be kept free of any cabinet trim or obstructions to ensure proper ventilation of the refrigeration system.



### **CAUTION!**

- *Equipment must be wired according to local and national electrical codes.*
- *Always disconnect power before servicing freezer.*

# Installation

## Installing Levelers

1. Remove levelers from plastic bag packed inside freezer (**Fig. 1**).
2. Tip freezer back and screw levelers in all the way to stop (they will extend 1/8" below base of FZR).
3. Adjust levelers as needed to level FZR in both directions. To access levelers, remove the lower front panel. Turn levelers clockwise to extend levelers.

**Note:** If you are using this in a food service application and installing in accordance with NSF, you must seal the unit to the floor once it is set in place. Place a 1/8" bead of NSF-approved silicone sealant (not provided) around the base of the unit.

Fig. 1

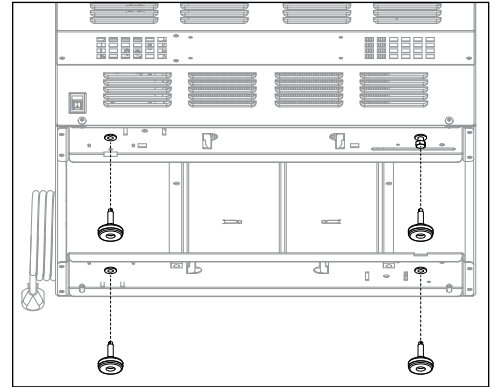

## Battery Backup (Touchscreen and Keypad units only)

1. Provide power to the unit and turn the power switch to the **ON** position.
2. Open the door using the keypad lock and prop the door open so it doesn't close during the battery installation.
3. Turn power switch to the **OFF** position or unplug the unit from the power supply.
4. Remove the four screws (**Fig. 2.1**) on the kick panel at the bottom of the unit.
5. Remove the kick panel and slide the panel to the right of the freezer.

**Note: Take care when removing, some wires are connected to the kick panel (Fig. 2.2).**

6. Find the control module on the left-hand side of the unit, just to the left of the condenser.
7. Locate the battery pack wiring harness that is hanging next to the backup battery pack.
8. Connect the battery pack harness to the battery pack.
9. If a Low Battery Alarm Error is present on the controller display, acknowledge the alarm as follows:
  - Basic controller: Press and hold SET button for 3-5 seconds until RST appears
  - Touchscreen controller: Press the checkbox icon  located in the yellow alert box.
10. Re-install the kick plate.
11. Close the door and check to make sure that the wire on the hinge side of the door is not kinked or pinched.
12. Test operation of the keypad lock while the power to the unit is **OFF** to confirm back-up battery connection.
13. Turn the power switch **ON** or plug the unit back into the power supply.

Fig. 2



## Installing Shelves

1. Remove shelves packed as an accessory (**Fig. 3**).
2. Place top notch of shelf bracket into pilaster, then bottom notch.
3. Press down on top of shelf to lock the shelf into the pilaster.

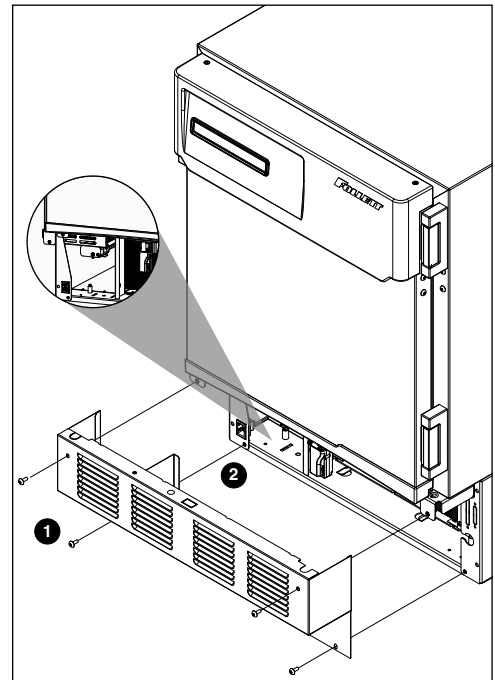
Fig. 3

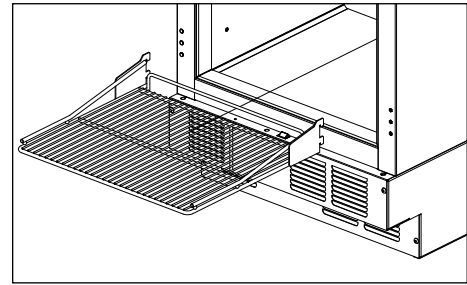

## Installing Drawer

### CAUTION!

- Do not use casters on units with drawers. Personal injury or damage to unit could result.

1. Remove drawer packed as an accessory (**Fig. 4**).
2. Install the two rollers to the threaded holes on each side of the inside of the cabinet.
3. Hang one drawer slide on the each side of the cabinet by holding the slide parallel to the bottom of the cabinet, tipping the slide at a 45 degree angle, and pushing the slide over the two rollers.
4. Once the drawer slides are installed, slide the two rear rollers of the drawer into the slots on the top of the lower channel of the slides. Tip up the front of the drawer and slide the back until the front drawer roller lines up to slot. Drop the front drawer roller into the channel and push the drawer all the way in the cabinet.
5. Test operation of the drawer by sliding the drawer all the way out, then back in.

Fig. 4

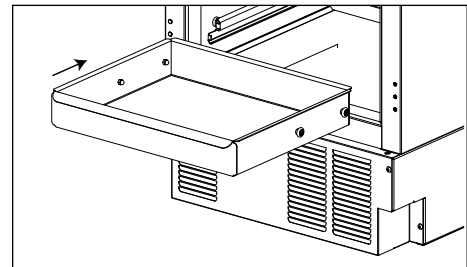

## Third-party Probe - Optional

1. Locate the three sided knockout (**Fig. 5.1**) on the evaporator cover on the inside of the freezer, just left of the fan.
2. Push the knockout with a screw driver until it folds down.
3. Locate the yellow foam circle on the rear of the box (**Fig. 5.2**).
4. Using a screw driver, puncture a hole through the foam to make an access hole for the third-party temperature probe.
5. Fish the temperature probe through the foam circle in the back of the unit, then through the knockout on the evaporator cover.
6. Position the third party probe in the desired location in the freezer cabinet.
7. Use Permagem\* or equivalent sealant to replace foam insulation and ensure proper performance of freezer.

\* Permagem is a registered trademark of the Presstite Engineering Company.

Fig. 5

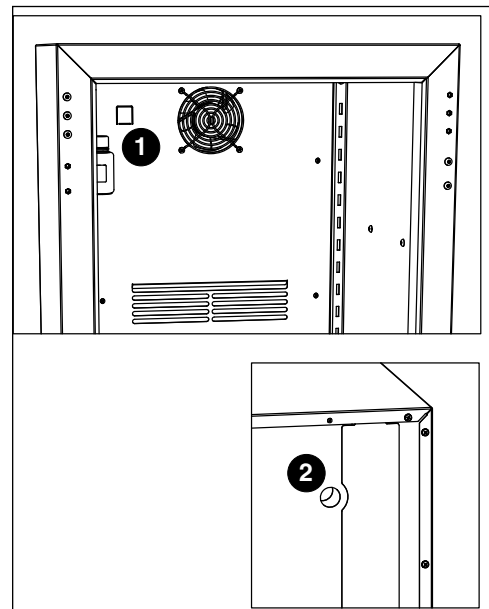

## Reversing the Door Swing – Optional

Tools needed:

- #2 Phillips head screwdriver
  - Flat-head screwdriver
  - Awl
  - Gloves
  - Safety glasses
1. Turn power OFF (and, if applicable, disconnect the battery backup) prior to reversing door swing.
  2. Remove kick panel\* and disconnect reed switch where applicable (**Fig. 6**).
    - \* If the unit has a keypad lock, the door must be open to remove the kick panel.
  3. Find the control module on the left-hand side of the unit, just to the left of the condenser.
  4. Remove the thumb nut (**Fig. 7.1**) securing control module to underside of cabinet (**Fig. 7.2**).
  5. Pull control module forward 1 inch, rotate left as per Fig. 8, and continue to pull the control module forward.

Fig. 6

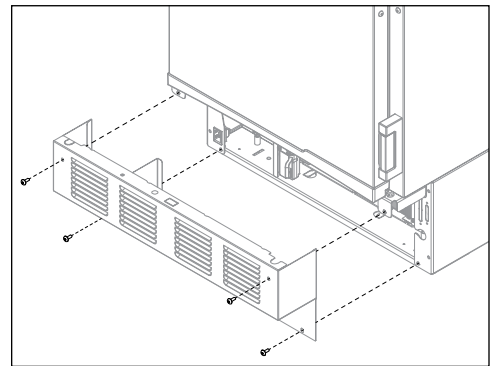

Fig. 7

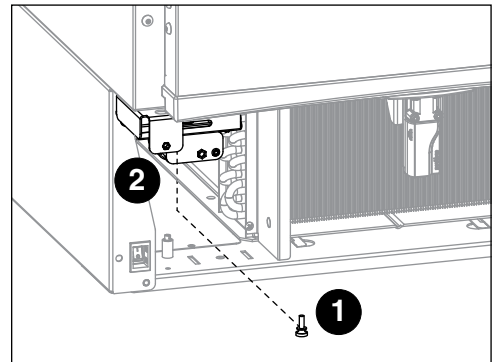
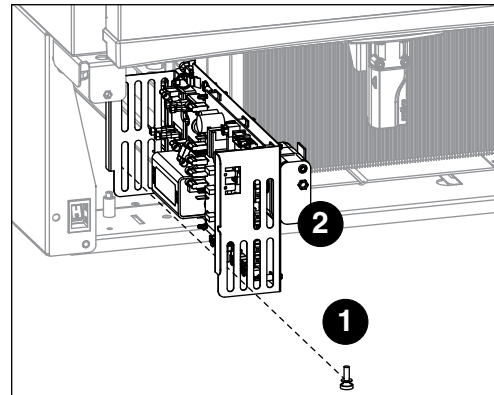

Fig. 8



6. Disconnect the door communication harness from the P10 terminal on the control board.
7. Locate the wire tie securing the door harness to the underside of the cabinet and cut.
8. Locate the ground screw in the front right-hand corner that secures the communication harness ground wire and remove. Do **not** discard the ground screw.
9. Remove the wire and strain relief from the right side panel and pull the communication harness through the opening. **(Fig. 9).**

**Fig. 9**



10. Remove the screw from the white strap on the hinge side of the wire channel (Carefully remove the control wire from the channel ensuring the insulation jacket does not tear.) Route through channel to opposite side of door. Reinstall the wire and strap on the opposite side of the door.

**Fig. 10**

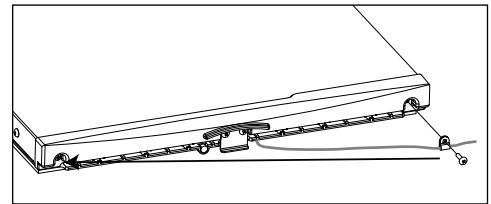

11. Use a flat screwdriver to carefully remove hinge covers.
12. Rotate top of spring assembly (clockwise for left-hand doors and counter-clockwise for right-hand doors) **(Fig. 11.1)** to remove the pin **(Fig. 11.2)**.
13. Relieve torque on the spring.
14. Remove the knockout on the kick panel and move the strain relief to the opposite side.

**Fig. 11**

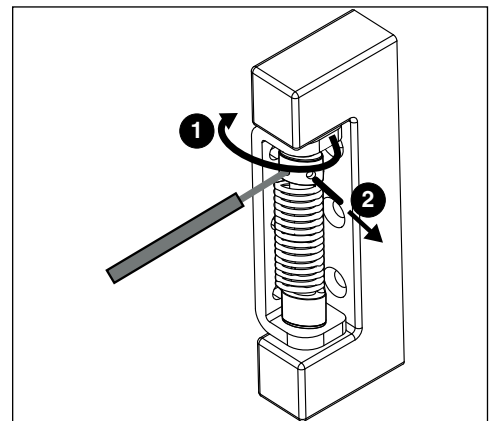

15. With flat-head screwdriver, simultaneously push down and pry the top of the spring out of the top of the hinge (**Fig. 12**).

**Fig. 12**

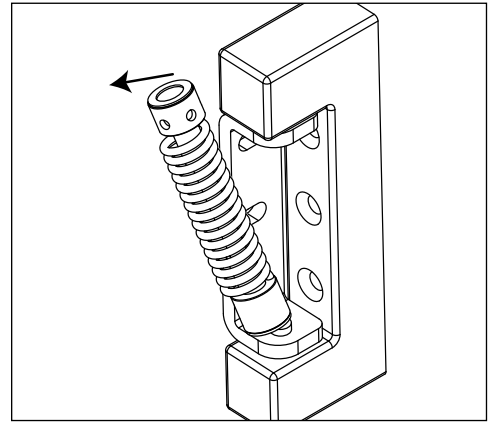

16. Remove screws and latch from refrigerator cabinet and the lock from the door (**Fig. 13**).

**Fig. 13**

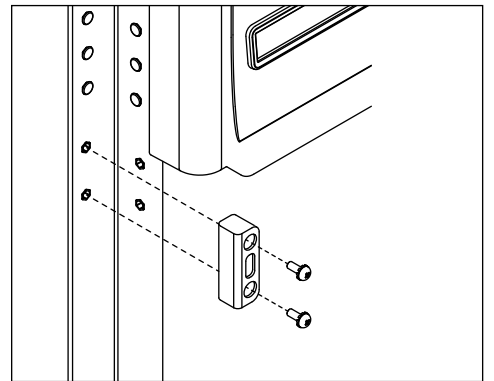

17. Support door and remove screws attaching hinge to refrigerator cabinet and remove the door (**Fig. 14**).
18. Remove the hinge from the door.
19. Remove hinge screws from opposite side of cabinet and transfer to riv-nuts now left exposed from hinge removal on both the cabinet and door side.
20. Reinstall the hinges on the opposite side of the door.  
**NOTE: When reversing the door the hinges must also be flipped upside down**
21. Adjust the hinges on the door by pushing the loose hinges towards the gasket side of the door until the hinge is stopped by the screws. Tightened screws.
22. Remove knock out on left side panel and route door cable and strain relief through opening.
23. Reinstall the door onto the cabinet but keep the mounting screws loose temporarily.
24. Reinstall lock and strike bracket to opposite side of door/cabinet.
25. Reinstall tension spring onto top hinge and adjust for proper closure.
26. When spring is properly tensioned, door should automatically close when held open roughly 1”.
27. Reinstall hinge covers.
28. Route door cable to the P10 terminal on the control board.
29. Using ground screw from Step 7, secure the communication harness ground wire in the front left-hand corner of the base plate. The connection is approximately 2" from the left side and 0.5" from the front.
30. Reinstall control module.
31. Reinstall kickplate.

**Fig. 14**

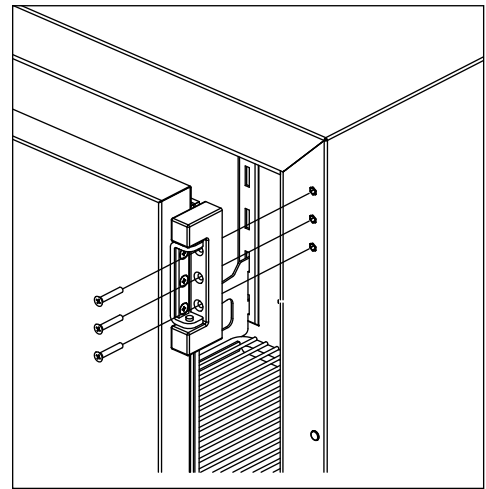

### Installing Glycerine Solution in Product Simulation Bottle

(glycerine not included - P/N00959296)

1. Remove the bottle from the bracket located in the upper left side of the freezer (**Fig. 15**).
2. Remove the top and fill the bottle with a 60/40 solution of glycerine and water.
3. Replace the top (and probe).
4. Reinsert bottle into the bracket.

**Note:** If you are using this in a food service application, and installing in accordance with NSF, you must remove the probe from the bottle. NSF requires that air temperature be displayed.

**Fig. 15**



## Operation

The temperature control board and probe indicate when the refrigeration system is required to turn on and off.

The refrigeration system removes heat from the cabinet interior and rejects it to the surrounding room air. When the cabinet interior temperature rises above the controller cut-in temperature, the controller turns the refrigeration system on. The controller energizes the evaporator fan and solid-state control relay which energizes the condensing unit. The compressor uses a current-style starting relay and a starting capacitor to start the compressor motor.

When the cabinet interior falls below the predetermined cut-out temperature, read by the P1 (control probe), the controller de-energizes the solid state compressor relay and condenser fan motor. The evaporator fan continuously runs to achieve desired product temperature.

Any accumulated frost on the evaporator coils melts during the electric defrost cycle. The condensate drains out of the unit to the condensate tray to the left of the condensing unit. The heat from the condensing unit evaporates any condensate in the drain pan.

## Temperature Control

The temperature control system is preset by the factory to maintain a cabinet temperature of  $-28\text{ C}$  ( $-18\text{ F}$ ). If desired, the set-point temperature can be raised as high as  $-17\text{ C}$  ( $0\text{ F}$ ) by following the instructions in Controller Operation on page 6 for changing the temperature set point. The  $2.2\text{ C}$  ( $4\text{ F}$ ) differential will be maintained regardless of the controller set point.

## Defrosting

The Performance Plus freezer is equipped with an electric defrost to keep the evaporator frost free. Defrost cycle terminates after 30 minutes or when the evaporator reaches  $5\text{ C}$  ( $41\text{ F}$ ) as read via the P2 (defrost) probe.

## Controller Operation - Performance Plus

In normal operation, the controller displays cabinet temperatures in degrees C or user-selected degrees F. F temperatures are displayed to the nearest degree and C temperatures are displayed to one decimal point.

The controller is pre-programmed with a -28 C (-18 to F) set point. **COMP** displays when the compressor is running. If this set point does not meet your specific application needs, instructions for changing the set point are found below.

### Controller Display

The controller display will show the temperature in degrees C or degrees F as selected by the user except when the unit is in an alarm.

The controller has system indicators above the temperature display to let you know when: the compressor is energized (**COMP**), the evaporator fan is energized (**FAN**) or the unit is in defrost (**DEF**).



To display temperature Set-point		
Step	Input	Display
1	Press and release <b>SET</b>	Current set-point temperature will display for approximately 5 seconds. Display will return to current product temperature.

To change temperature Set-point		
Step	Input	Display
1	Press and hold <b>SET</b> for 3 seconds	Set-point will flash.
2	Press <b>UP</b> or <b>DOWN</b> arrows to desired set-point	New temperature set-point will flash on the display.
3	Press and release <b>SET</b> to accept	Product temperature will display.

### Controller Security

The controller can be locked so that the set-points in the controller cannot be changed.

1. To lock, press **UP** and **DOWN** arrows simultaneously until **LOC** appears (approximately 5 s).
2. To unlock the controller, press up and down arrows simultaneously until **UNL** appears. Changes are only accepted when the controller is unlocked.

### Changing Temperature Display from C to F

1. Press **SET** and **UP** arrow simultaneously until **L1** is displayed.
2. Press the **UP** arrow until **UNT** is displayed. Press **SET** then use the **UP** and **DOWN** arrows to change the temperature display from F to C. Press **SET** to accept. The display will return to the temperature in approximately 10 s.

### Sleep Function

Press the **SLEEP** button to blank the display, or press any button to wake the display. If the unit goes into an alarm, the display will wake to display the alarm.

## Temp Log

### High and low log display

1. Press the **UP** arrow to display the highest temperature the freezer has recorded since last reset or power cycle.
2. Press the **DOWN** arrow to display the lowest temperature that the freezer has recorded since last reset or power cycle.

### Reset high and low log

1. Press **UP** or **DOWN** arrow until recorded temperature is displayed.
2. Press and hold **SET** until **RST** is displayed.

## Alarming Functions

### Set high and low alarms

1. Press and hold **SET** and **UP** arrows simultaneously until **L1** is displayed. Use the **UP** and **DOWN** arrows to navigate parameters.
2. The **low** temperature alarm parameter is **AIL**. Once the parameter is displayed, press **SET** to display the low alarm temperature. The alarm temperature will flash on the display. Use the **UP** and **DOWN** arrows to set the alarm temperature. Press **SET** to accept.
3. The **high** temperature alarm parameter is **AIH**. Once the parameter is displayed, press **SET** to display the high alarm temperature. The alarm temperature will flash on the display. Use the **UP** and **DOWN** arrows to set the alarm temperature. Press **SET** to accept.

### Start-up alarm delay

The Performance Plus unit has a 120 minute time delay between when the unit is energized to when the temperature alarms become active. This delay can be change in parameters in the controller under **Alarm Startup Delay (ASd)**.

### Mute the Alarms

The mute button is used to temporarily mute the audible alarm for 10 minutes. If the alarm condition of the unit has not changed in 10 minutes, then the alarm will sound again.

### Alarm acknowledgement and alarm Reset

The alarm will need to be acknowledged after the alarm condition has been resolved, before the alarm will reset. To acknowledge the alarm press and hold set until the RST is displayed.

### Alarming Contacts

This unit is equipped with dry contacts that may be connected to a 3rd party monitoring system. The contacts are located on the back of the unit. Standard Performance Plus units utilize the Alarm 1 set (top 3). Each set of dry contacts has a Common, a Normally Open and a Normally Closed connection point. By default, Alarm Relay 1 is set to activate with any of the following alarms: Alarm 1 High temp, Alarm 1 Low temp, System errors or probe error.

### Probe calibration

The temperature probes can be calibrated from **-9.9 to +9.9**. The calibration is in the second level menu under **P1C** (control probe) **P2C** (defrost) **P3C** (Alarm).

## Alarm Codes

When the unit senses an alarm, the display will flash the following codes.

Value	Description
HA1	Temperature is above the High Alarm#1 set point.
LA1	Temperature is below the low Alarm #1 set point.
HA2	Temperature is above the High Alarm #2 set point.
LA2	Temperature is below the Low Alarm #2 set point.
DFA	Defrost time out (lasted the full 30 minutes)
Lob	Low battery alarm.
dA	Door open alarm.

## Error Codes

Value	Description
P1-P3	Controller is not sensing the probe.
F9	Error saving new parameter values to permanent storage.
F10	Incomplete model configuration.
F11	Number/membrane is sticking.
F21	Key shorted on user interface.
F22	Communication error with user interface.
F23	Communication error with Machine Control.

## Advanced Settings

The freezer can be further customized through the first level (L1) and second level parameters (L2) in the chart below.

1. Press and hold **SET** and **UP** arrows simultaneously until **L1** is displayed.
2. Use the **UP** and **DOWN** arrows to navigate the parameters. When the desired parameter is displayed, press **SET**.
3. Use the **UP** and **DOWN** arrows to navigate the sub menu of the parameter. Press **SET** to accept and the display will return to the parameter list (after 30 seconds the display will return to the temperature display).

Parameter	Display	Description
Beeper Function	bPr	Controls the audible beeper function on the controller. <b>Off, All, door, Alarm, Error.</b>
Beeper Volume	bPu	Sets the volume of the beeper: <b>0</b> (minimum) to <b>10</b> (maximum).
Button Clicks	btc	Sets if a beep should sound each time a button is pressed. <b>Yes</b> or <b>No</b> .
Sleep Function	SLP	Determines if sleep function activated from the panel. <b>Yes</b> or <b>No</b> .
Sleep Timer	SLt	Amount of time before the screen blanks automatically. <b>0 s</b> to <b>600 s</b> .
Alarm1 High Temp	A1H	High temperature to activate alarm1. User set point to 121 C (250 F).
Alarm1 Low Temp	A1L	Low temperature to activate alarm1. User set point to -46 C (-50 F).
Alarm1 Probe	A1P	Probe for Alarm. <b>P1</b> (cabinet air), <b>P2</b> (evaporator), <b>P3</b> (simulation bottle).
Units	unt	Display temperatures in degrees C or F. <b>F</b> or <b>C</b> .

1. Press and hold **SET** and **UP** arrows simultaneously until **L1** is displayed.
2. Press and hold **SET** and **UP** arrows simultaneously again until **L2** is displayed.
3. Use the **UP** and **DOWN** arrows to navigate the parameters. When the desired parameter is displayed, press **SET**.
4. Use the **UP** and **DOWN** arrows to navigate the sub menu of the parameter. Press **SET** to accept and the display will return to the parameter list (after 30 seconds the display will return to the temperature display).

Parameter	Display	Description
Alarm1 Delay	A1d	Alarm1 delay before sounding. <b>0</b> to <b>60</b> minutes
Alarm1 Function	A1F	Defines the action taken when Alarm2 is activated. <b>NO</b> (normally open), <b>NC</b> (normally closed), <b>R1</b> (activate relay), <b>R2</b> (not used), <b>DIS</b> (disable).
Alarm1 Reset	A2r	Temperature difference to reset alarm1. <b>0</b> to <b>10</b> degrees.
Alarm2 Delay	A2d	Alarm1 delay before sounding. <b>0</b> to <b>60</b> minutes.
Alarm2 Function	A2F	Defines the action taken when Alarm2 is activated. <b>NO</b> (normally open), <b>NC</b> (normally closed), <b>R1</b> (activate relay), <b>R2</b> (not used), <b>DIS</b> (disable).
Alarm2 Reset	A2r	Temperature difference to reset alarm1. <b>0</b> to <b>10</b> degrees.
Alarm Ring back	Arb	Defines the time delay until the alarm will resound. <b>0</b> to <b>120</b> minutes
Alarm Startup Delay	ASd	Defines the alarm delay during startup. <b>0</b> to <b>180</b> minutes.
Alarm Silencing	ASL	Determines if the alarms can be silenced or not. <b>Yes, No.</b>
Maintain Alarm	nAL	Determines if the alarm (1-3) should be maintained if the temperatures fall back into range. <b>Yes, No.</b>
Probe 1 Calibration	P1C	Offset value for probe 1 calibration. <b>-9.9</b> to <b>9.9</b> .
Probe 2 Calibration	P2C	Offset value for probe 2 calibration. <b>-9.9</b> to <b>9.9</b> .
Probe 3 Calibration	P3C	Offset value for probe 3 calibration. <b>-9.9</b> to <b>9.9</b> .
Controller Parameter Reset	rSt	Reset to restore factory parameters.

## Follett Keypad Lock

### Default user passcode for first-time users

User Code 01 is factory set by default to **1 2 3 4 5 6**.

**Note: In order to continue using 1 2 3 4 5 6 as a default, user-selectable programming codes must be stored in slots 02 to 40.**

User Codes 02 to 40 do not have any codes set up and are available for user-programming.

Each time a button is pressed, a chirp will be heard.

### To Change the Master Code

The master code is needed to add or change the individual user codes. By default, the master code is set to **1 2 3 4 5 6**.

The master code is stored in User ID # 99.

1. Press **3 6 5**, the **\***, followed by the current Master Code, followed by **ENTER** (5 Chirps will be heard).
2. Press **9 9**, followed by **ENTER**. (3 chirps will be heard).
3. Enter the new master code, followed by **ENTER** (3 chirps will be heard).
4. Re-enter the new master code, followed by **ENTER**. (5 chirps will be heard).
  - Pressing [**CANCEL**] at any point will cancel the routine.

### To Enter or Change a User Code

1. Press **3 6 5**, the **\***, followed by the Master Code, followed by **ENTER**. 5 Chirps will be heard.
2. Enter the user ID (a two digit code from 00 to 40), followed by **ENTER**. 3 chirps will be heard.
3. Enter the new user code (6 numbers), followed by **ENTER**. 3 chirps will be heard.
4. Re-Enter the new User Code, Followed by **ENTER**. 5 chirps will be heard to acknowledge that a new code was entered.

Example: To enter a new user code of 4 4 3 3 5 5 for ID # 15

1. Press **3 6 5 \* 1 2 3 4 5 6 [ENTER]** (5 chirps will be heard).
2. Press **1 5 [ENTER]** (3 chirps will be heard).
3. Press **4 4 3 3 5 5 [ENTER]** (3 chirps will be heard).
4. Press **4 4 3 3 5 5 [ENTER]** (5 chirps will be heard).

The new code has been entered for the ID.

### To Delete a User Code

1. Press **3 6 5**, the **\***, followed by the Master Code, followed by **ENTER**. 5 Chirps will be heard.
2. Enter the user ID to clear, followed by **ENTER** (3 chirps will be heard).
3. Press **3 3 5, #** (3 chirps are heard) (335 = DEL).
4. Enter the user ID to clear, followed by **ENTER** (2 chirps will be heard).
5. Press **3 3 5, #** (5 chirps are heard).

The code assigned to that user ID has been deleted. If an error is encountered, the control will beep continuously for 3 seconds. The Master Code stored in user ID 99 cannot be deleted.

Example: To delete the user code in ID 15:

1. Press **3 6 5 # 1 2 3 4 5 6 [ENTER]** (5 chirps will be heard).
2. Press **1 5 [ENTER]** (3 Chirps will be heard).
3. Press **3 3 5, #** (3 Chirps will be heard) (335 = DEL).
4. Press **1 5 [ENTER]** (2 Chirps will be heard).
5. Press **3 3 5, #** (5 Chirps will be heard).

# Controller Operation - Performance Plus Touchscreen

## Use and care of the LCD Performance Plus Touchscreen

















The LCD touchscreen utilizes capacitive touch technology. This will allow you to engage the functionality by touching the screen with your fingers, even while you are wearing latex or cotton gloves. Functionality will not engage by touching with an inanimate object, such as a pen or stylus.

- To preserve optimal touch sensitivity, keep the screen clean by using a clean, dry cotton cloth.
- Do not expose the screen to liquids or excessive dust, heat or humidity.

Control function icons and navigation buttons engage functionality of the user interface. Status indicators alert the user to a change of status.

### Home screen

The Home Screen consists of three primary information areas: the temperature display, control function display zone and system status display.

Control Functions	System Status	Functions and Settings
 Settings	 Compressor is running	 USB download available (downloading when blinking)
 Alarming	 Evaporator fan is running	 Refrigeration set points
 Light	 Door is open	 Sleep functions
 Information log	 Defrost cycle is in process	 Centigrade to Fahrenheit
 Help		 Probe set points
		 Alarming functions
		 Alarm mute
		 Reset

- Product temperature is displayed in the upper right corner.
- Primary control function icons are displayed in the lower left corner.
- System status icons will display in lower right corner to indicate a condition has been activated.

Fig. 16





Fig. 17



## High and low temperature display

From the home screen touch the temperature display in the upper right corner. The high/low temperatures will appear below the temperature display. To the left of the high/ low temperature a time and date stamp will be displayed.



## Reset the high and low temperatures

Touch the temperature display a second time and the reset function  will appear under the high and low temperature. Touch the reset icon and a yellow message box will appear. Press  to confirm reset or  to cancel.

## Alarm set point display

From the home screen touch the temperature display three times. The High and low alarm set point will appear under the temperature.

## Help

- Help is available at any time by touching the  icon at the bottom of the screen.
- Help is screen-specific; touching the  icon will display an explanation of the functionality and use of the screen you are currently viewing.
- Touch  to exit help screen.

## Settings











- Refrigeration Set Point 
  - Touch the number displayed in the box to the right of the Set point label and use the keypad or **UP** and **DOWN** arrows to select product temperature between  $-18\text{ C}$  ( $0\text{ F}$ ) and  $-37\text{ C}$  ( $-35\text{ F}$ ). Press  to accept or  to cancel.
- Sleep Temperature Display 
  - Toggle **ON** to hide the temperature reading immediately on the home screen.
- Set the Sleep Delay 
  - To automatically hide the temperature after 0-600 seconds of inactivity, touch the box to the right of the delay (0-600) box. Use keypad or **UP** and **DOWN** arrows to select from 0-600.
- Temperature 
  - Toggle between **F** and **C** to select Fahrenheit or Celsius.
- Brightness 
  - Touch the number displayed in the box to the right of the Brightness  icon and use the keypad or **UP** and **DOWN** arrows to select from 1-10. Press  to accept or  to cancel.

Fig. 18



Fig. 19



Fig. 20

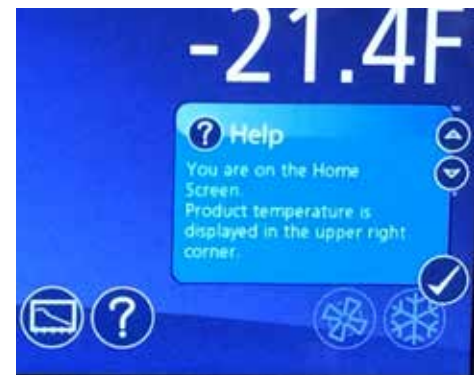

Fig. 21



Fig. 22



## System Information



- Touch the System Info icon  to display the model number, unit serial number and software version. Touch the checkbox icon  in the lower right corner of the box to clear.

Fig. 23



## Alarm or Alert Notifications





- If an alarm or event condition is detected and an alarm is engaged, an alert notification will appear in the left center of the screen with an explanation of the alert condition and a checkbox  at the bottom right of the alert box.
- No further action can be taken on the User Interface until the alert condition is acknowledged and cleared by touching the checkbox .
- Mute 
  - Touch the  icon to mute audible alarm for 15 minutes.

Fig. 24



## Door Switch

- The Performance Plus touchscreen units have a door switch that is located on the kick plate. The door switch will turn on the LED light and turn off the evaporator fan. If the door is open for more than one minute it will also cycle off the compressor. When the door is closed the evaporator fan and compressor will return to service.

## Door Alarm

- The Performance Plus touchscreen units have a door alarm that is factory set for one minute. The alarm will clear when the door is closed. The door alarm activation time can be changed from 0-600 seconds in advanced setting under Door Open Alarm Delay.









## Power Alarm

- The Performance Plus touchscreen units have a Power Alarm that will sound if the unit loses power for more than five minutes. The Power loss alarm box will display every five minutes, then the screen will sleep. An audible alarm will sound every 30 seconds during the power failure. An alarm box will be displayed when power is restored. The event log will record the exact time and date of the power loss and when the power was restored.

## Start-up alarm delay

The Performance Plus unit has a 120 minute time delay between when the unit is energized to when the temperature alarms become active. This delay can be changed in parameters in the controller under **Alarm Startup Delay**.

## Setting Alarms

- Alarming Settings control the conditions and timing of event and alarm conditions that result in audible and/or visual alerts.
- To change the high alarm set point, touch the number displayed in the box to the right of the  icon and use the keypad or **UP** and **DOWN** arrows to select an alarm value. Press  to accept or  to cancel.
- To change the low alarm set point, touch the number displayed in the box to the right of the  icon and use the keypad or **UP** and **DOWN** arrows to select alarm value. Press  to accept or  to cancel.
- Audible Alarm 
  - Toggle between **ON** and **OFF** to engage and disengage the audible alarm function.
- Mute 
  - Touch the  icon to mute audible alarm for 15 minutes.

## Alarming Contacts

This unit is equipped with dry contacts that may be connected to a 3rd party monitoring system. The contacts are located on the back of the unit. Performance Plus touchscreen units utilize Alarm 1 and Alarm 2 set (all 6). Each set of dry contacts has a Common, a Normally Open and a Normally Closed connection point. By default, Alarm Relay 1 is set to activate with any of the following alarms: Alarm 1 High temp, Alarm 1 Low temp, Door Open Alarm, and Power Loss Alarm.

## Probe calibration

The temperature probes can be calibrated from **-9.9 to +9.9** in the advanced setting on the touchscreen models. **P1** control, **P2** defrost, and **P3** Alarm.

## Screen saver

The screen saver will replace the home screen and display a blank screen, time and date, or the temperature. When the screen is touched or the unit has an alarm or event, it will return to the home screen. The screen saver can be changed in the advanced setting.

**Screen saver function:** blank, time and date, or temperature.

**Screen saver time (sec):** 0—600 seconds between the last touch of the screen to the activation of the screen saver.

Fig. 25



Fig. 26

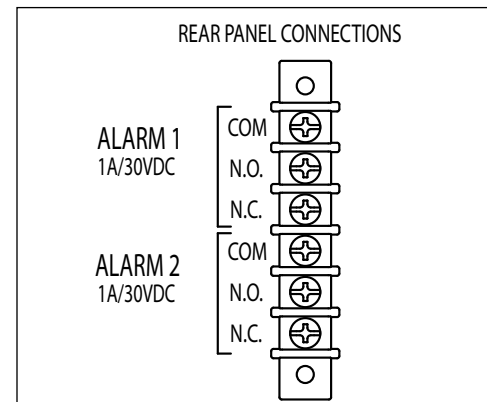

## Information Logs

- All available graphs, data logs and event logs are accessed through the Information Logs function. The home screen in the Information Logs section displays the product (P3) temperature graph with one week's data. Date and time information is displayed on the horizontal axis.
- The Performance Plus units come factory set to display only the product temperature (**P3**) on the graph. All of the probes on the Performance Plus unit can be viewed on the graph if desired. Probes can be added to the graph through the advanced setting under **P1** to **P3** by selecting the probe and changing the parameter from No to Yes. The selected probe will now display on the graph.
  - P1** control, **P2** defrost, **P3** Alarm
- Zoom in (+) or Zoom out (–) on an event/temperature on the home screen will change the time scale.
- Using the left and right arrows below the graph will scroll the graph. All the stored temperature data on the graph is viewable.
- Temperature Log – to display a chronological listing of logged temperatures (latest logged temperature will display first), touch the “**Temperature Log**” label to the left of the screen. Use the **UP** and **DOWN** arrows to the right of the screen to scroll through the logged temperatures.

Fig. 27

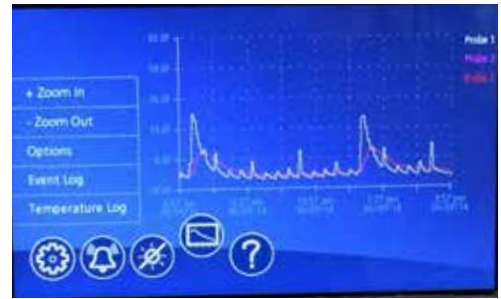

Fig. 28



- Event Log – to display a chronological listing of events (including errors, alarms and alerts), touch the **Event Log** label to the left of the screen. Use the **UP** and **DOWN** arrows to the right of the screen to scroll through the logged temperatures.

Fig. 29



## Data logging

- The Performance Plus controller is capable of storing up to 50,000 readings per probe. The factory setting for the sample rate is every 15 minutes, which will provide enough storage for 520 days. The sample rate can be change to provide data logging for a longer or shorter time interval by changing the **Sample Rate (Min)** in the advanced settings menu. **0 = off and 360 minutes maximum.**

## Data Storage

- Data can be captured different ways. The factory default is for the data to overwrite itself when the memory is full. This can be changed in the advanced setting under **Data storage overwrite**. When this parameter is set to **No**, the system will display an alert when the memory is 75% full. To clear the alert the data must be downloaded.

## Data duration alarm

- A reminder can be set to download the data in the **Data duration alarm** in the advanced setting. The data duration can be set from **1 to 180 days**. If the data duration alarm is used, then the **Alarm on data full** parameter in the advanced setting must also be set to **Yes**.

## Downloading data

- The touchscreen has the capability of downloading the temperature data and event log via a USB port on the left side of the user interface. The file is a CSV format and is suitable for import directly into Microsoft Excel.

- Insert the storage device in the USB slot located to the left of the Touchscreen.
- Select the Graph icon along the bottom of the Touchscreen.
- Select the USB icon in the lower right hand corner.
- A yellow alert box with **downloading data** will appear.
- Press  to accept or  to cancel.
- After the unit is done downloading a second yellow alert box will appear asking if you want to **Erase log**.
- Press  to accept or  to cancel.

**Note:** If you chose to erase the data, the data duration timer and the data full alarm will reset. It will also erase the information that is stored on the graph.

*One of the two files below will be downloaded depending on which screen is being viewed:*

**EL XXXX YY - Event Log**

**TL XXX YY - Temperature Log**

XXXX = last 4 digits of serial number

YY = 0-99 number of downloaded file

## Data download reminder and data full alarm

- If you plan or are required to download data for a certain time period, you can set a **download data reminder** on the Performance Plus unit. Download data reminder can be found in the advanced setting under **Data duration** and can be set from **1 to 180 days**.

## Follett Keypad Lock

For units enabled with keypad and electronic lock feature, keypad will be displayed on left side of screen.

### Default user passcode for first-time users

- Master User Code 01 is factory set by default to **1 2 3 4 5 6**.
- User Codes 01 to 40 are available for user-programming.
- Each time a button is pressed, a chirp will be heard.
- See Page 12 for detailed Follett Keypad Lock instructions.

Fig. 30



Fig. 31



Fig. 32



## Changing and Adding the User Codes







1. Touch Settings  icon.
1. Touch **Advanced Settings**, enter your 4-digit user access code (factory default is 1 1 1 1) in the keypad that appears, and touch the checkmark icon  to access advanced settings screens.
2. Time and date will be displayed. Scroll using the **UP** and **DOWN** arrows until **Change Access Code** is displayed in the Display Setup screen.
3. Touch **Change Access Code** and enter the master code [ENTER]. (By default, the master code is 1 2 3 4 5 6.)
4. Touch the screen to the right of the user code 1 to 40 to overwrite or add the user code.
5. Enter the new code. Press  to accept or  to cancel.
6. Enter the new code again. Press  to accept or  to cancel.
7. Press **DONE** when finished entering access codes.

Fig. 33

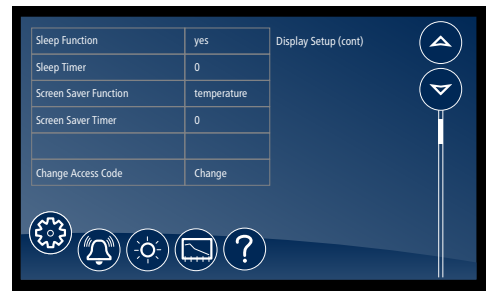

Fig. 34



## Light

- To turn the interior light on (or off), touch the Light icon or the Light Off icon.
- Light timer is in advanced settings.
- The light will also come on when the door is open

## Time and Date











- To set time and date, press the Settings  icon.
- To display options, touch **Advanced Settings**, enter your 4-digit user access code in the keypad that appears, and touch the checkmark icon  to access advanced settings screens (factory default is 1111).
- Time: touch displayed time and use the keypad to enter the time. Press  to accept or  to cancel.
- AM/PM: touch displayed value to toggle between AM and PM.
- Month: touch number displayed and use the keypad to enter the month. Press  to accept or  to cancel.
- Day: touch number displayed and use the keypad to enter the day. Press  to accept or  to cancel.
- Year: touch number displayed and use the keypad to enter the year. Press  to accept or  to cancel.

Fig. 35



## Advanced Settings

- Touch **Advanced Settings**, enter your 4-digit user access code in the keypad that appears, and touch the checkmark icon  to access advanced settings screens (factory default is 1111).

## Cleaning

**Interior:** Using a sponge or soft cloth, clean unit with a non-abrasive, non-chlorinated, all-purpose detergent.

**Exterior:** Wipe exterior with a soft cloth in the direction of grain as needed. Stainless steel polish may be used to enhance the finish of the unit.

## Annual Cleaning

Removal of dust and other particulates from air intake areas and the condenser is important for proper operation. Environments with large amounts of dust may require more frequent cleaning.

**Use only non-chlorine-based cleaners. Cleaners containing chlorine can cause staining and pitting of the stainless steel.**

1. Disconnect power to unit by turning switch on the lower front panel to the **OFF** position and removing power cord from receptacle.
2. Remove lower front and rear panels (**Fig. 36.1**).

**Note:** Front louvered panel may be removed for more frequent cleaning of the condenser as needed.

3. Remove drain pan (**Fig. 36.2**). (FZR4P, FZR5P drain pan location shown.)
4. Clean drain pan with a non-abrasive, non-chlorinated all-purpose detergent.
5. Reinstall drain pan.
6. Use a vacuum cleaner with brush attachment to clean condenser through lower front panel and compressor motor and related parts through lower rear panel.
7. Reinstall lower rear and lower front panels.

**Fig. 36**

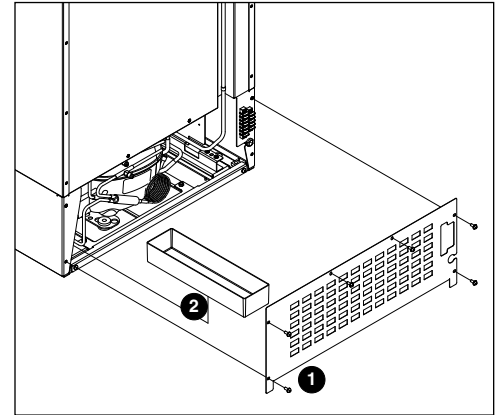

# Wiring Diagram

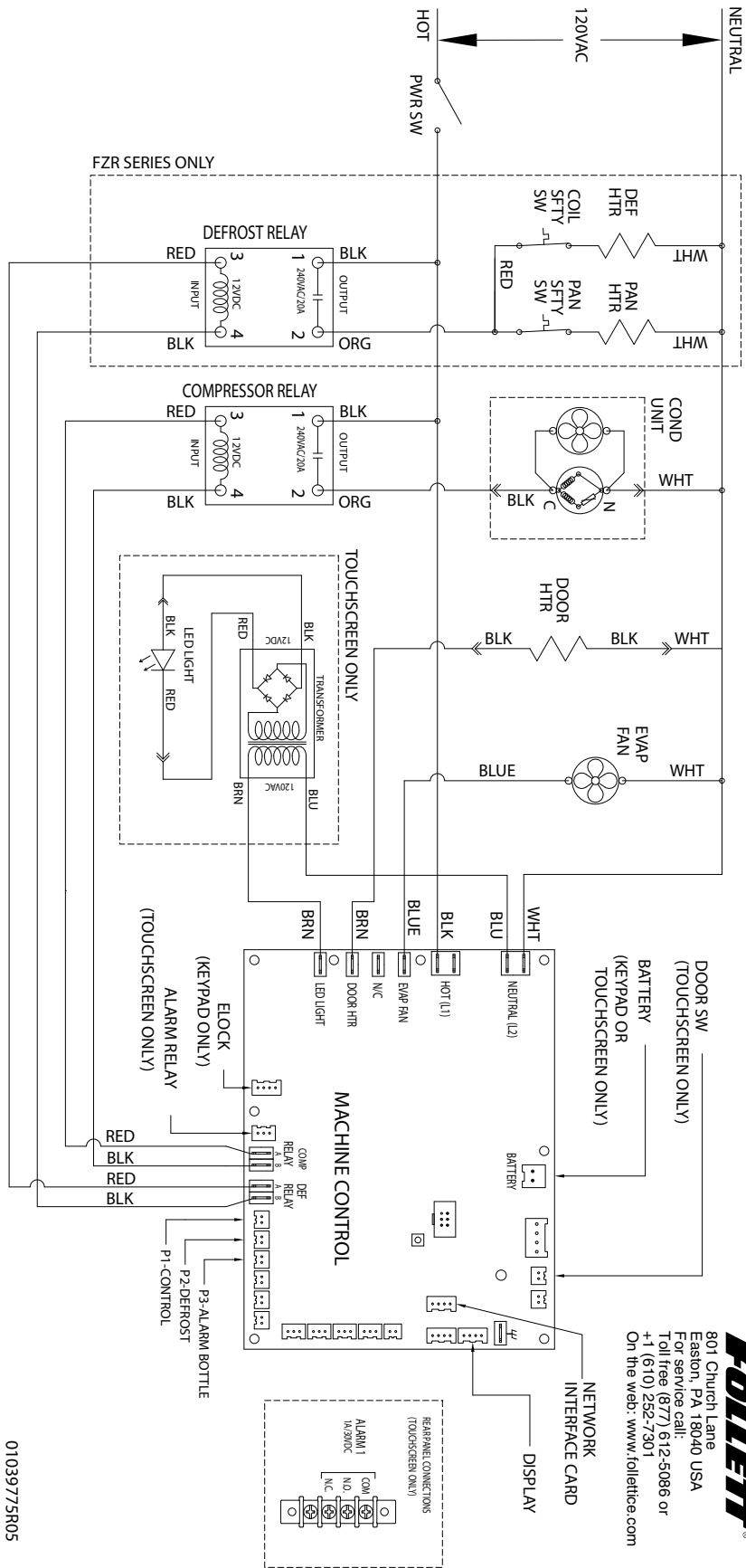

01039775R05

**FOLLETT**  
 801 Church Lane  
 Easton, PA 18040 USA  
 For service call:  
 Toll free (877) 612-5086 or  
 +1 (610) 252-7301  
 On the web: [www.follettice.com](http://www.follettice.com)

## Refrigeration System

The Performance Plus refrigeration system is designed to give many years of trouble-free service. Except for routine cleaning of the air-cooled condenser and related parts, the refrigeration system requires no service or maintenance. The system uses a capillary tube and is critically charged. The connection of refrigeration service hoses to the fittings will almost invariably result in a significant change in the system charge. This change can adversely affect the performance of your freezer. Therefore, Follett recommends that if hoses are ever connected to the refrigeration system for service, the refrigerant should be recovered, the system evacuated, and recharged by weighing in the correct refrigerant charge.

## Checking Refrigeration System Pressures

1. Remove the rear access panel.
2. Turn the power switch to the **ON** position.
3. Verify that the temperature controller is set to the original factory cut-in setting.
4. Allow the freezer to operate and stabilize at least 30 minutes, verifying the cut-out temperature is being reached.
5. If the compressor doesn't cycle after 20 minutes, the following checks must be completed before checking refrigeration pressures:
  - condenser coil is clean and clear
  - condenser fan is running
  - evaporator coil is clean and clear
  - evaporator fan motor is running
  - compressor is running at normal amp draw
6. Measure air temperature at condenser intake grille.
7. Connect refrigerant hoses and verify correct pressures with the temperature chart below.
8. Troubleshoot refrigeration system as needed.

### FZR4P, FZR5P

<b>Condenser inlet air temperature</b>	70 F (21.1 C)	80 F (26.7 C)	100 F (37.8 C)
<b>Suction pressure (psi)</b>	12	13	17
<b>Discharge pressure (psi)</b>	199	226	325

**Note:** Do not attempt to obtain correct refrigeration pressures by adjusting the system charge.

## Refrigeration System Diagram

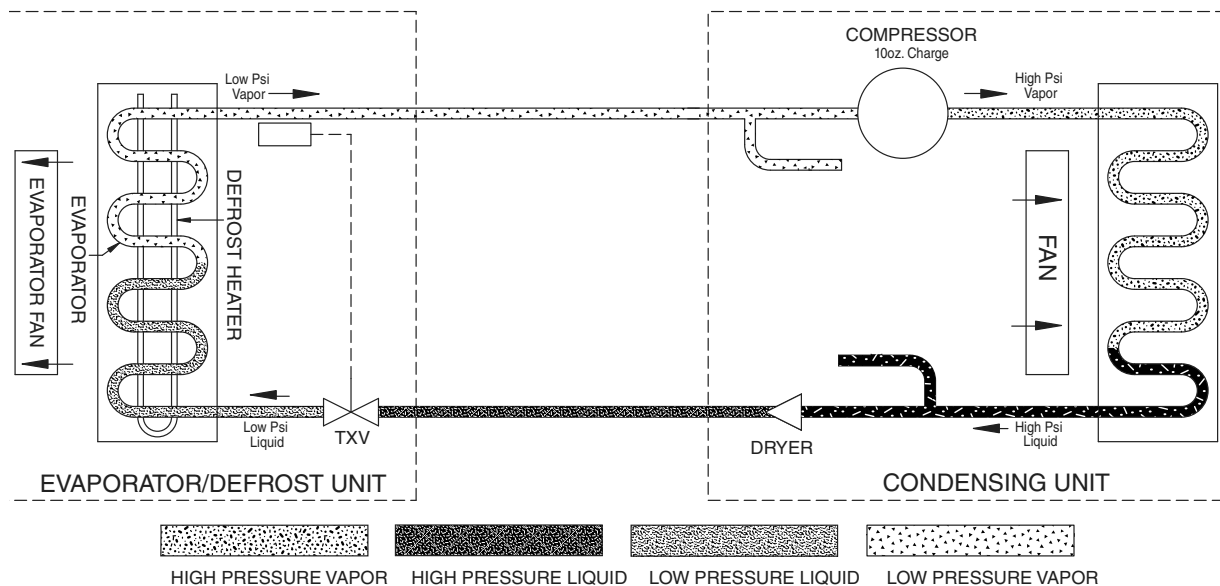

## Compressor Information

Compressor	NF7CLX
Run load amps (RLA)	4.1
Lock rotor amps (LRA)	28
Ohms start winding to common	5.4
Ohms run winding to common	1.7
Ohms start winding to run winding	7.2

## Troubleshooting

### Before calling for service

1. Check that unit is plugged in.
2. Test outlet with another appliance to verify power.

Symptom	Possible Cause	Solution
Refrigerator does not operate (no components run).	Power switch faulty or in OFF position; loose connection.	Turn power switch to ON; check switch and connections.
	Refrigerator not plugged in.	Connect plug.
	No power to cord.	Restore power.
	Temp controller not energizing components.	Check controller contact terminals for power. Replace controller if needed.
	Probe not sensing set point temperature.	Replace controller and/or probe.
Compressor does not run.	Thermal overload open or defective.	Allow to cool or replace.
	Capacitor and/or relay defective.	Replace as required.
	Compressor defective.	Replace compressor.
Evaporator fan motor does not run.	Defective fan motor.	Replace fan motor.
Refrigerator does not shut off.	Controller not sensing cut-off temperature.	Replace controller and/or probe.
	Controller keeping refrigeration system energized.	Replace controller.
	Control relay faulty.	Replace control relay.
Refrigerator does not maintain temperature (all components run).	Condenser or evaporator coil needs cleaning.	Clean coils.
	Faulty door gasket.	Replace door gasket.
	Excessively high ambient or inadequate air clearance.	Maximum recommended ambient is 100 F (38 F).
	Refrigerant leak.	Locate and repair leak.
	Incorrect refrigerant charge.	Recover, evaluate and weigh in correct charge.
	Plugged capillary tube.	Replace capillary tube and filter drier.
	Inefficient compressor.	Consult technical services.

If problems persist after following this basic troubleshooting guide, call Follett's technical service group at (877) 612-5086.

## Accessories

The following accessories are available for Performance Plus undercounter freezers. Instruction sheets are available in the download section of the Follett website ([www.follettice.com](http://www.follettice.com)).

### Temperature Surveillance Module Accessory (P/N [00168674](#))

- Reference instruction 00168609 (packed with module)

### Pedestal Base (P/N [01059120](#))

- Reference instruction 01062488 (packed with base)

### Stacking Kit - Performance Plus to Performance Plus (P/N [01054006](#))

- Reference instruction 01054022 (packed with stacking kit)

### Universal ADC Bracket (P/N [01059096](#))

- Reference instruction 01062470 (packed with bracket)

### Digital Data Logger (P/N [01057561](#))

- Reference instruction 01057579 (packed with digital data logger)

### Stacking Kit Legacy to Performance Plus (P/N [01067172](#))

- Reference instruction 01067180

**Note: new kickplates may need to be ordered, please contact Follett for more information.**

### Stacking Kit Countertop to Performance Plus (includes one straight kick plate) (P/N [01100759](#))

- Reference instruction 01103084

### Caster Kit (P/N [01053636](#))

- Reference instruction 01067578

### Seismic Kit (P/N [01059104](#))

- Reference instruction 01068097

### Straight Kick Plate Kit (P/N [01067016](#))

- Reference instruction 01067560

### Drawer Kit (includes one straight kick plate) (P/N [01053644](#))

- Reference instruction 01067586

### Two-drawer Kit (includes one straight kick plate) (P/N [01067750](#))

- Reference instruction 01067586

### Facia Door Heater Kit REF4 (P/N [01099431](#))

- Reference instruction 01099456

### Facia Door Heater Kit REF5 (P/N [01099449](#))

- Reference instruction 01099456

### Remote Alarm Accessory (P/N [01092022](#))

- Reference instruction 01095868

### Wall Mount Kit (P/N [00153700](#))

- Reference instruction 00153692

## Hardware and Electrical Components

Reference #	Description	Part #
Not shown	Board, control, FZR4P/5P/PLPC (serial numbers E98967 and above)	01111186
Not shown	Board, control, FZR4P/5P/PLP-KP (serial numbers E98967 and above)	01111194
Not shown	Board, control, FZR4P/5P/PLP-T (serial numbers E98967 and above)	01111202
Not shown	Board, control, FZR4P/5P/PLP-T-KP (serial numbers E98967 and above)	01111210
Not shown	Key pad driver board	01034735
Not shown	Compressor/defrost relay	01042092
Not shown	Temperature probe	01062801
Not shown	Refrigeration scrader valve caps	206230

## Temperature Surveillance Module (Chart Recorder) Related Items

Reference #	Description	Part #
Not shown	Bracket, bottle, 125 mL	00171132
Not shown	Gasket, bottle, 125 mL	00171124
Not shown	Bottle, with cap, 125 mL (gasket not included)	00171116
Not shown	Battery	00112177
Not shown	Chart paper, 6" 7-day, 7 day (qty 60)	00162099
Not shown	Pens, replacement (qty 6)	00162081
Not shown	Probe, chart recorder	00162073

## Digital Data Logger Related Items

Reference #	Description	Part #
Not shown	Temperature probe certificate of traceability Calibration by Dickson (NIST) and ISO/IEC 17025	01057595
Not shown	DicksonWare software and USB cable	01057603
Not shown	AC power adapter	01057611
Not shown	60 ml product simulation bottle	00112037
Not shown	Velcro, hook and loop fastener	206406
Not shown	Glycerol	00959296





## Warranty Registration and Equipment Evaluation

Thank you for purchasing Follett Products LLC equipment. We hope you find that our equipment meets or exceeds your expectations, as our goal is to deliver high value products and services that earn your complete satisfaction!

Please review the enclosed installation and operations manual. It is important that the installation be performed to factory specifications, so your equipment operates to its maximum efficiency.

Follett Products LLC will not be liable for any consequential damages, expenses, connecting or disconnecting charges or any losses resulting from a defect of the machine.

For full warranty details, visit our website [www.follettice.com/productwarranties](http://www.follettice.com/productwarranties).

Warranty registration and equipment evaluation is important to help us keep track of our equipment and to record the machine's performance. We request that you register Follett equipment warranties on our website [www.follettice.com/support](http://www.follettice.com/support) and choose Warranty Registration and Equipment Evaluation. It's simple to do; please take a moment to register today. There is also space on the form to provide us with comments and feedback. Please let us know about your experience so we can capture it for our continuous improvement efforts.

We pride ourselves on producing outstanding equipment and we work hard to back it up with outstanding customer and technical support. Please let us know what else we can do to assist you. We would be happy to answer your questions.

Follett HEALTHCARE and Advantage are trademarks of Follett Products, LLC.  
Follett is a registered trademark of Follett Products, LLC, registered in the US.



801 Church Lane • Easton, PA 18040, USA  
Toll free (877) 612-5086 • +1 (610) 252-7301  
[www.follettice.com/healthcare](http://www.follettice.com/healthcare)

01351469R00  
© Follett Products LLC 2/21