

**SERVICE MANUAL  
FRYMASTER H14 SERIES  
ELECTRIC FRYER**

This equipment chapter is to be installed in the Fryer Section of the *Equipment Manual*.

**FOR YOUR SAFETY**  
Do Not Store or use gasoline or other flammable vapors and liquids in the vicinity of this or any other appliance.

**MANUFACTURED  
BY  
FRYMASTER CORPORATION  
P.O. BOX 51000  
SHREVEPORT, LOUISIANA 71135-1000  
PHONE: 1-318-865-1711  
TOLL FREE: 1-800-551-8633  
1-800-24 FRYER  
FAX: 1-318-862-2394**

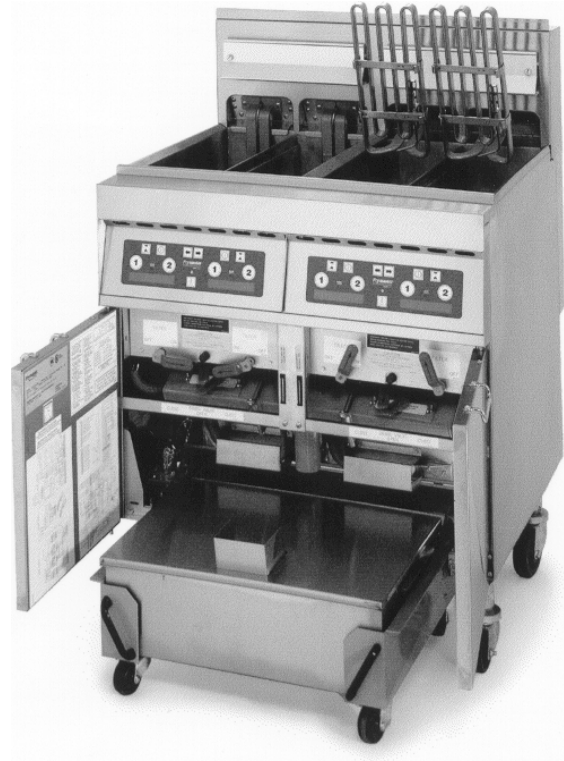

**TABLE OF CONTENTS**

WARRANTY STATEMENT .....Page i  
INTRODUCTION .....Page 1-1  
INSTALLATION INSTRUCTIONS .....Page 2-1  
OPERATING FRYERS WITH M100B COOKING COMPUTERS .....Page 3-1  
OPERATING FRYERS WITH THERMOSTAT CONTROLLERS .....Page 4-1  
OPERATING THE BUILT-IN FILTRATION SYSTEM .....Page 5-1  
PREVENTIVE MAINTENANCE AND TROUBLESHOOTING .....Page 6-1  
SERVICE PROCEDURES AND WIRING DIAGRAMS .....Page 7-1  
PARTS LIST .....Page 8-1

The Frymaster Corporation, 8700 Line Avenue 71106, 5489 Campus Drive 71129  
P.O. Box 51000, Shreveport, Louisiana 71135-1000  
PHONE 318-865-1711 FAX 318-219-7135

### **WARNING**

IMPROPER INSTALLATION, ADJUSTMENT, ALTERATION, SERVICE OR MAINTENANCE CAN CAUSE PROPERTY DAMAGE, INJURY OR DEATH. READ THE INSTALLATION, OPERATING AND MAINTENANCE INSTRUCTIONS THOROUGHLY BEFORE INSTALLING OR SERVICING THIS EQUIPMENT.

### **WARNING**

FOR YOUR SAFETY, DO NOT STORE OR USE GASOLINE OR OTHER FLAMMABLE VAPORS AND LIQUIDS IN THE VICINITY OF THIS OR ANY OTHER APPLIANCE.

### **COMPUTERS**

#### **FCC**

This device complies with Part 15 of the FCC rules. Operation is subject to the following two conditions: 1) This device may not cause harmful interference, and 2) This device must accept any interference received, including interference that may cause undesired operation. While this device is a verified Class A device, it has been shown to meet the Class B limits

#### **CANADA**

**This digital apparatus does not exceed the Class A or B limits for radio noise emissions as set out by the ICES-003 standard of the Canadian Department of Communications.**

**Cet appareil numerique n'emet pas de bruits radioelectriques depassany les limites de classe a et b prescrites dans la norme NMB-003 edictee par le ministre des communications du Canada.**

### **WARNING**

THIS PRODUCT CONTAINS CHEMICALS KNOWN TO THE STATE OF CALIFORNIA TO CAUSE CANCER AND/OR BIRTH DEFECTS OR OTHER REPRODUCTIVE HARM.

Operation, installation and servicing of this product could expose you to airborne particles of glasswool or ceramic fibers, crystalline silica, and/or carbon monoxide. Inhalation of airborne particles of glasswool or ceramic fibers is known to the State of California to cause cancer. Inhalation of carbon monoxide is known to the State of California to cause birth defects or other reproductive harm.

FRYMASTER ELECTRIC FRYERS ARE MANUFACTURED FOR USE WITH THE TYPE VOLTAGE SPECIFIED ON THE FRYER RATING PLATE LOCATED ON THE FRYER DOOR. FOR PROPER INSTALLATION PROCEDURES IN THE UNITED STATES, REFER TO THE LATEST EDITION OF THE NATIONAL ELECTRIC CODE ANSI/N.F.P.A. NO. 70; IN CANADA, CANADIAN ELECTRICAL CODE PART 1, CSA-22.1. FOR INSTALLATION IN COUNTRIES OTHER THAN THE UNITED STATES AND CANADA, REFER TO THE NATIONAL CODE APPROPRIATE FOR THE COUNTRY IN WHICH THE EQUIPMENT IS BEING INSTALLED.

INFORMATION ON THE CONSTRUCTION AND INSTALLATION OF VENTILATING HOODS MAY BE OBTAINED FROM THE LATEST EDITION OF THE "STANDARD FOR THE INSTALLATION OF EQUIPMENT FOR THE REMOVAL OF SMOKE AND GREASE LADEN VAPORS FROM COMMERCIAL COOKING EQUIPMENT," N.F.P.A. NO. 96. COPIES OF THESE ELECTRICAL STANDARDS ARE AVAILABLE FROM THE NATIONAL FIRE PROTECTION ASSOCIATION, BATTERY MARCH PARK, QUINCY, MASS. 02269

## **WARRANTY STATEMENT**

Frymaster, L.L.C. makes the following limited warranties to the original purchaser only for this equipment and replacement parts:

### ***A. WARRANTY PROVISIONS - FRYERS***

1. The Frymaster Corporation warrants all components against defects in material and workmanship for a period of one year.
2. All parts, with the exception of the frypot, heating elements and fuses, are warranted for one year after installation date of fryer.
3. If any parts, except fuses, become defective during the first year after installation date, Frymaster will also pay straight-time labor costs to replace the part, plus up to 100 miles/160 km of travel (50 miles/80 km each way).

### ***B. WARRANTY PROVISIONS - FRYPOTS***

(Applies to fryers installed on or after January 1, 1995, only.)

If a frypot develops a leak within seven years after installation, Frymaster will, at its option, either replace the entire battery or replace the frypot, allowing up to the maximum time per the Frymaster time allowance chart hours of straight-time labor plus up to 100 miles/160 km of travel (50 miles/80 km each way) to change the frypot.

### ***C. WARRANTY PROVISIONS - HEATING ELEMENTS***

(Applies to fryers installed on or after January 1, 1995, only.)

1. The Frymaster Corporation warrants the heating elements against defective material or workmanship for a period of three years from the original installation date, parts only.
2. This warranty does not cover ancillary components, including the hi-limit, temperature probe, and contactors.

### ***D. WARRANTY PROVISIONS - COOKING COMPUTER***

1. The Frymaster Corporation warrants the M-100B Cooking Computer against defective material or workmanship for a period of one year from the original installation date, parts and labor. Replacements for defective units during the second and third year are available at a reduced rate.
2. During this warranty period, Frymaster will, at its option, repair or replace defective cooking computer returned with new or factory rebuilt and functionally operative units.

3. For replacement of defective computers under warranty, call your local Frymaster Factory Authorized Service Center. All computers replaced under the Frymaster exchange program are covered by a one-year (parts only) warranty.

#### ***E. PARTS RETURN***

All defective in-warranty parts must be returned to a Frymaster Authorized Factory Service Center within 60 days for credit. After 60 days, no credit will be allowed.

#### ***F. WARRANTY EXCLUSIONS***

This warranty does not cover equipment that has been damaged due to misuse, abuse, alteration, or accident such as:

- improper or unauthorized repair (including any frypot which is welded in the field);
- failure to follow proper installation instructions and/or scheduled maintenance procedures as prescribed in your MRC cards. Proof of scheduled maintenance is required to maintain the warranty;
- improper maintenance;
- damage in shipment;
- abnormal use;
- removal, alteration, or obliteration of either the rating plate or the date code on the heating elements;
- operating the frypot without shortening or other liquid in the frypot;
- no fryer will be warranted under the seven-year program for which a proper start-up form has not been received.

This warranty also does not cover:

- transportation or travel over 100 miles/160 km (50 miles/80 km each way), or travel over two hours;
- overtime or holiday charges;
- consequential damages (the cost of repairing or replacing other property which is damaged), loss of time, profits, use or any other incidental damages of any kind.

There are no implied warranties of merchantability or fitness for any particular use or purpose.

# CHAPTER 1: INTRODUCTION

## 1.1 General

Read the instructions in this manual thoroughly before attempting to operate this equipment. This manual covers all configurations of models MH14 and BIMH14 fryers built since July 1999. Models designated MH14 do not have built-in filtration systems. Models designated BIH14 are equipped with FootPrint III built-in filtration systems.

H14 Series fryers feature deep cold-zones and easy to clean, open frypots with tilt-up elements. The fryers are controlled by multi-product cooking computers or optional thermostat controllers. Fryers in this series come in full or split-pot arrangements, and can be purchased as single units or grouped in batteries of up to five fryers.

## 1.2 Safety Information

Before attempting to operate your unit, read the instructions in this manual thoroughly.

Throughout this manual, you will find notations enclosed in double-bordered boxes similar to the ones below.

**CAUTION** boxes contain information about actions or conditions that *may cause or result in a malfunction of your system*.



**WARNING** boxes contain information about actions or conditions that *may cause or result in damage to your system*, and which may cause your system to malfunction.



**DANGER** boxes contain information about actions or conditions that *may cause or result in injury to personnel*, and which may cause damage to your system and/or cause your system to malfunction.



Fryers in this series are equipped with automatic safety features:

1. Two high temperature detection features shut off power to the elements should the controlling thermostat fail.
2. A safety switch built into the drain valve prevents the elements from heating with the drain valve even partially open.

### **1.3 Computer Information**

This equipment has been tested and found to comply with the limits for a Class A digital device, pursuant to Part 15 of the FCC rules. While this device is a verified Class A device, it has been shown to meet the Class B limits. These limits are designed to provide reasonable protection against harmful interference when the equipment is operated in a commercial environment. This equipment generates, uses and can radiate radio frequency energy and, if not installed and used in accordance with the instruction manual, may cause harmful interference to radio communications. Operation of the equipment in a residential area is likely to cause harmful interference in which case the user will be required to correct the interference at his own expense.

The user is cautioned that any changes or modifications not expressly approved by the party responsible for compliance could void the user's authority to operate the equipment.

If necessary, the user should consult the dealer or an experienced radio and television technician for additional suggestions.

The user may find the following booklet prepared by the Federal Communications Commission helpful: "How to Identify and Resolve Radio-TV Interference Problems". This booklet is available from the U.S. Government Printing Office, Washington, DC 20402, Stock No. 004-000-00345-4.

### **1.4 European Community (CE) Specific Information**

The European Community (CE) has established certain specific standards regarding equipment of this type. Whenever a difference exists between CE and non-CE standards, the information or instructions concerned are identified by means of shadowed boxes similar to the one below.

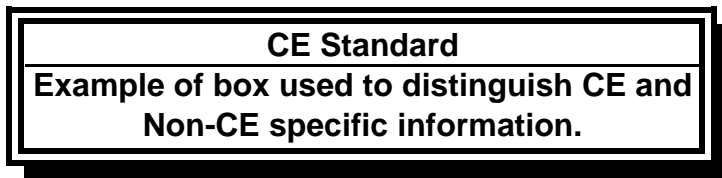

## 1.5 Shipping Damage Claim Procedure

### ***What to do if your equipment arrives damaged:***

Please note that this equipment was carefully inspected and packed by skilled personnel before leaving the factory. The freight company assumes full responsibility for safe delivery upon acceptance of the equipment.

1. File Claim for Damages Immediately—Regardless of extent of damage.
2. Visible Loss or Damage—Be sure this is noted on the freight bill or express receipt and is signed by the person making the delivery.
3. Concealed Loss or Damage—If damage is unnoticed until equipment is unpacked, notify Freight Company or carrier immediately and file a concealed damage claim. This should be done within 15 days of date of delivery. Be sure to retain container for inspection.

## 1.6 Service Information

McDonald's store personnel perform routine maintenance. For non-routine maintenance or repairs, or for service information, contact your local Frymaster Authorized Service Center (FASC). Service information may also be obtained by calling the Frymaster Technical Services Department (1-800-24FRYER). The following information will be needed in order to assist you efficiently:

Model Number \_\_\_\_\_

Serial Number \_\_\_\_\_

Voltage \_\_\_\_\_

Nature of the Problem \_\_\_\_\_

\_\_\_\_\_

\_\_\_\_\_

**RETAIN AND STORE THIS MANUAL IN A SAFE PLACE FOR FUTURE USE.**

## CHAPTER 2: INSTALLATION INSTRUCTIONS

### 2.1 General

Proper installation is essential for the safe, efficient, trouble-free operation of this appliance. Any unauthorized alteration of this equipment will void the Frymaster warranty.

 **DANGER**

Copper wire suitable for at least 167° F (75° C) MUST be used for power connections.

 **DANGER**

The electrical power supply for this appliance MUST be the same as indicated on the rating and serial number plate located on the inside of the fryer door.

 **DANGER**

This appliance MUST be connected to the voltage and phase as specified on the rating and serial number plate located on the inside of the fryer door.

 **DANGER**

All wiring connections for this appliance MUST be made in accordance with the wiring diagrams furnished with the equipment. Wiring diagrams are located on the inside of the fryer door.

 **DANGER**

Do not store or use gasoline or other flammable vapors and liquids in the vicinity of this or any other appliance.

In the event of a power failure, the fryer(s) will automatically shut down. If this occurs, turn the power switch OFF. Do not attempt to start the fryer(s) until power is restored.

This appliance must be kept free and clear of combustible material, except that it may be installed on combustible floors.

A clearance of 6 inches (15cm) must be provided at both sides and back adjacent to combustible construction. A minimum of 24 inches (61cm) should be provided at the front of the equipment for servicing and proper operation.

 **WARNING**

Do not block the area around the base or under the fryers.

The duct system, the hood, and the filter bank must be cleaned on a regular basis and kept free of grease. See the appropriate Maintenance Requirement Cards.

## 2.2 After Fryers Are Under The Fry Station Hood

Adjust casters so that fryers are level and at the proper height in the fry station hood. If necessary, level the fryer(s) by loosening the locking screw on the caster leg and screwing the caster in or out. When fryer is level and at proper height, retighten the locking screw on the caster leg.

Secure the fryer in place under the hood with the restraining hardware installed with the hood.

## 2.3 Power Requirements

**⚠ DANGER**  
**Copper wire suitable for at least 167°F (75°C) MUST be used for power connections.**

MODEL	VOLTAGE	PHASE	WIRE SERVICE	MIN. SIZE	AWG (mm <sup>2</sup> )	AMPS PER LEG		
						L1	L2	L3
H14	208	3	3	6	(16)	39	39	39
H14	240	3	3	6	(16)	34	34	34
H14	480	3	3	8	(10)	17	17	17
H14	220/380	3	4	6	(16)	21	21	21
H14	240/415	3	4	6	(16)	20	20	21
H14	230/400	3	4	6	(16)	21	21	21
14 SERIES	208	3	3	6	(16)	39	39	39
	240	3	3	6	(16)	34	34	34
EPRI	220/380	3	4	6	(16)	21	21	21
UNITS	240/415	3	4	6	(16)	20	20	20

**⚠ DANGER**  
**The electrical power supply for this appliance MUST be the same as indicated on the rating and serial number plate located on the inside of the fryer door.**

**⚠ DANGER**  
**This appliance MUST be connected to the voltage and phase as specified on the rating and serial-number plate located on the inside of the fryer door.**

**⚠ DANGER**  
**All wiring connections for this appliance MUST be made in accordance with the wiring diagrams furnished with the equipment. Wiring diagrams are located on the inside of the fryer door.**

## **2.4 Frypot Boil-Out**

Before the fryer is first used for cooking product, it should be boiled out to ensure that any residue from the manufacturing process has been completely eliminated.

Also, after the fryer has been in use for a period of time, a hard film of caramelized vegetable oil will form on the inside of the frypot. This film should be periodically removed by following the boil-out procedure.

Refer to Fryers Maintenance Requirement Card (MRC) 14A for the boil-out procedure.

## CHAPTER 3: OPERATING FRYERS WITH M100B™ COOKING COMPUTERS

### 3.1 Equipment Setup and Shutdown Procedures

#### Setup

 **WARNING**

**Fill the frypot to the bottom oil level line with vegetable oil before pressing the ON/OFF switch  to the ON position. Failure to do so could damage the frypot.**

0. Fill the frypot with vegetable oil to the bottom OIL LEVEL line located on the rear of the frypot. This will allow for oil expansion as heat is applied. Do not fill cold oil any higher than the bottom line; overflow may occur as heat expands the oil.
0. Ensure that the power cord(s) is/are plugged into the appropriate receptacle(s). Verify that the face of the plug is flush with the outlet plate, with no portion of the prongs visible.
0. Ensure that the vegetable oil level is at the *top* OIL LEVEL line when the vegetable oil *is at its programmed cooking temperature*. It may be necessary to add vegetable oil to bring the level up to the proper mark, *after the oil has reached the programmed cooking temperature*.

 **CAUTION**

**Do not add vegetable oil to the fryer between the time the computer is turned on and the time it reaches programmed cooking temperature. Doing so is likely to cause RECOVERY LOCKOUT (REC LOC). See Section 3.4.**

#### Shutdown

0. Press the ON/OFF switch  to the OFF position (the display will show OFF).
2. Filter vegetable oil and clean fryers.
3. Place the frypot covers on frypots.

### 3.2 Introduction To The M-100B™ Cooking Computer

The M-100B cooking computer, illustrated on the following page, automatically maintains fryer temperature to cook products according to preprogrammed cooking specifications. The computer also acts as a cooking process timer, displaying the remaining cooking time for each product and alerting the operator by sound and display message to shake or pull the product at the correct time. It also signals quality control (hold-time) limits. The computer automatically adjusts cooking times to compensate for variances in product temperature and basket load so that, for example, a full basket of cold fries will be cooked to the same quality as half a basket of fries at room temperature.

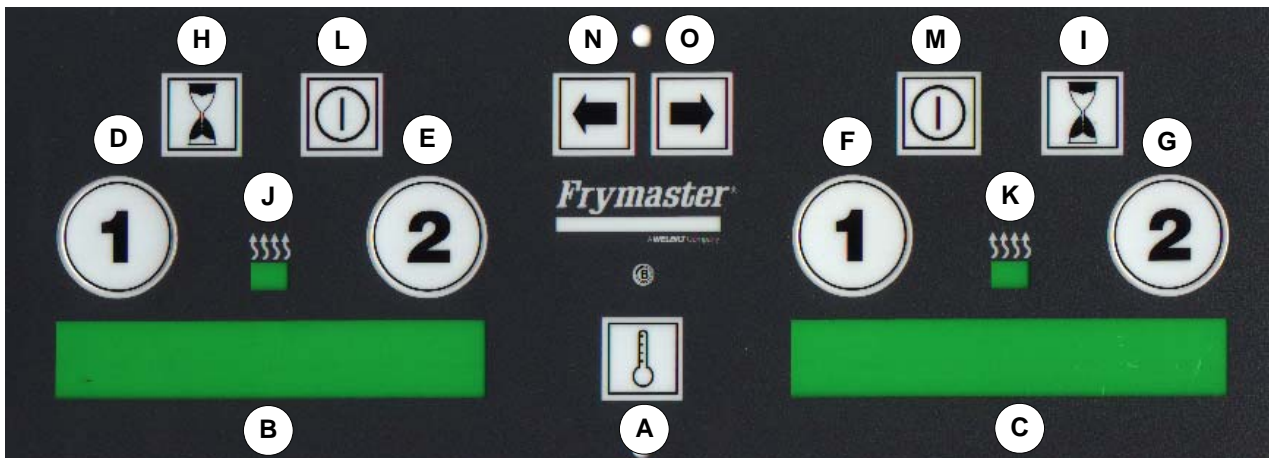

ITEM	DESCRIPTION
A	Temperature Display Switch
B	Left LED Display
C	Right LED Display
D	Cook Switch #1, Left
E	Cook Switch #2, Left
F	Cook Switch #1, Right
G	Cook Switch #2, Right
H	Recovery/Use Time Recall Switch, Left
I	Recovery/Use Time Recall Switch, Right
J	Light - Left Heating Mode Indicator
K	Light - Right Heating Mode Indicator
L	Switch - Left ON/OFF
M	Switch - Right ON/OFF
N	Switch - Left Product Selection
O	Switch - Right Product Selection

To quickly determine the software version number and the current configuration of an M-100B computer, with the computer turned OFF (**OFF** in both displays) press the temperature check  switch. The displays will automatically cycle through the version number, power configuration (gas or electric), EPRA configuration (On or Off), and frypot configuration (full- or split-).

The M-100B is factory-programmed with McDonalds's cooking specifications for a group of seven standard products. The cooking times and temperature settings for these factory-programmed products can be changed by store personnel if required. Additionally, two *test menus* are available for store personnel to program product names, cooking times, temperature settings, and shake or duty times for products not included on the factory-programmed menu. The test menus can also be set to automatically adjust the cooking rate to compensate for product variances.

For units equipped with built-in filtration, the computer times the polishing process and alerts the operator when the polishing time has elapsed. (**Polishing** refers to circulating the vegetable oil through the filtration system for a specified time.)







The fryer has two built-in high-limit protection features. If the temperature in the frypot reaches approximately 410°F (210°C), the computer opens the heat relay circuit, turning the elements off. If the temperature in the frypot reaches 450°F (232°C), a mechanical high-limit shuts off electrical power to the elements. The operator should periodically test each of the high-limit protection features to verify that they are operating correctly. Refer to Grills/Fryers Maintenance Requirement Card (MRC) 15 for the procedure.

### 3.3 M-100B™ Computer Operating Instructions

 **WARNING**

**Before pressing the on/off switch  to the ON position, ensure that the frypot is properly filled with vegetable oil. See Section 3.1.**







#### *Operating the Computer on Full-Vat Fryers*

0. Turn ON the cooking computer by pressing the right ON/OFF switch . A product name (for example, **FR FRIES**) will appear in the right LED display.
0. If the frypot temperature is below 180°F (82°C), the computer will automatically enter a warm-up cycle (often called a melt cycle). The heating elements will cycle on and off repeatedly, allowing the vegetable oil to heat gradually, without scorching. During the warm-up cycle, the right heating mode indicator  will alternately illuminate and go out as the elements cycle on and off. Within about 45 minutes, the computer will exit the warm-up cycle and the heat mode indicator  will remain continuously illuminated.
0. The M-100B computer allows the operator to use both sides of the computer if desired. By having both sides of the computer on, the operator can select two products that have the same cooking temperature, but different cooking times. Using a pair of twin baskets, both products can be cooked at the same time.
0. To activate the left side of the computer, press the left ON/OFF switch . A product name will be displayed in the left LED display.
0. Select the product to be cooked by pressing the right product selection switch  (or, if both sides of the computer are ON, the left product selection switch ) until the desired product is displayed.

Once the frypot temperature is above 180°F (82°C), but still 15°F (8°C) or more below the setpoint temperature for the product displayed (for example, french fries), the computer will alternately display **LOW TEMP** and **FR FRIES**, and the right heating mode indicator  will remain continuously illuminated.

The cooking cycle cannot be started until the cooking oil is within ±15°F (8°C) of the programmed setpoint. When the frypot temperature is within ±15°F (8°C) of the programmed setpoint, the product name will be displayed continuously, indicating that the fryer is ready to cook the displayed product.

## **Operating the Computer on Split-Vat Fryers**

1. Turn ON the cooking computer by pressing the ON/OFF switches . Pressing the left switch turns on the left side of the computer; pressing the right switch turns on the right side. A product name (for example, **FR FRIES**) will appear in the LED display corresponding to the switch pressed.
2. If the frypot temperature is below 180°F (82°C), the computer will automatically enter a warm-up cycle (often called a melt cycle). The heating elements will cycle on and off repeatedly, allowing the vegetable oil to heat gradually, without scorching. During the warm-up cycle, the heating mode indicator  will alternately illuminate and go out as the elements cycle on and off. Within 45 minutes, the computer will exit the warm-up cycle and the heat mode indicator  will remain continuously illuminated.
3. Select the product to be cooked by pressing the left or right product selection switches  , depending upon the vat in which you wish to cook.
4. Once the frypot temperature is above 180°F (82°C), but still 15°F (8°C) or more below the setpoint temperature for the product displayed (for example, french fries), the computer will alternately display **LOW TEMP** and **FR FRIES**, and the heating mode indicator  will remain continuously illuminated.
5. The cooking cycle cannot be started until the cooking oil is within ±15°F (8°C) of the programmed setpoint. When the frypot temperature is within ±15°F (8°C) of the programmed setpoint, the product name will be displayed continuously, indicating that the fryer is ready to cook the displayed product.

## **Viewing the Frypot Temperature (Actual or Setpoint)**

To display the actual frypot temperature, press the temperature check switch  once. To display the setpoint temperature, press the switch twice.

## **Cooking Product (Full-Vat or Split-Vat)**

1. Fill basket(s) with product, lower the basket into the vegetable oil, then press the cook switch (① or ②) that corresponds to the full- or split-vat to be used. This will activate the cooking cycle of the product.  

Example 1: In a full-vat fryer, press cook switch ① when the first basket of twin baskets of fries is dropped. Halfway through the first cooking cycle, drop the second basket and press cook switch ②.

Example 2: The M-100B is programmed to cook Crispy Chicken (**CSPY**) and Chicken McNuggets (**NUG**) in the same side of a split-vat arrangement. Cook switch ① corresponds to Crispy Chicken, and cook switch ② corresponds to Chicken McNuggets.
2. The display will show the number of minutes and seconds of cooking time remaining.

3. At the programmed shake time, an audible alarm will sound and the display will flash **SHAKE**. After shaking the basket, press the corresponding cook switch, ① or ②, to cancel the alarm.
0. After the completing the cooking time, an audible alarm will sound and the display will flash **pu l l**. Remove the indicated basket and press the corresponding cook switch, ① or ②, to cancel the alarm. If no other products are being cooked in the frypot, the display shows **7:00 QA** indicating that the quality timer is counting down. If the quality time is set for some time other than 7:00 minutes, the display starts counting down from that time. (QA is not available for McChicken, Crispy Chicken or Filet-o-Fish).
0. When the quality time expires, an audible alarm will sound, and the display will flash **QA**. Cancel the alarm by pressing the corresponding cook switch, ① or ②.

**NOTE:** When you initiate a new cook cycle, the quality time will automatically reset.

### 3.4 M-100B™ Computer Problem Condition Indicators

#### *Open Drain Valve Indication*

If, when the ON/OFF  switch is pressed to the ON position, the display reads **IGNITION FAILURE**, verify that the drain valve is fully closed. A drain safety switch built into the drain valve assembly prevents the elements from being energized if the valve is not completely closed. After verifying that the valve is fully closed, turn the computer OFF\* for at least 5 seconds, then turn it back on. If the message reappears, there is a problem in the electrical circuitry of the fryer or the computer; contact your Frymaster Factory Authorized Service Center (FASC).

\* On early-version M-100B split-vat units, BOTH computers must be turned off, even though the problem condition may be associated with only one vat.

#### *Low Temperature Indication*

If the frypot temperature drops to more than 45°F (25°C) below the programmed setpoint temperature during the cooking cycle, the cook switches will lock, the display will flash **LOW TEMP** and an audible alarm will sound. If the frypot temperature returns to a range between 45°F (25°C) to 15°F (8°C) of setpoint, the audible alarm will stop, but the cook switches remain locked and the display alarm continues flashing. All functions return when the frypot temperature is within 15°F (8°C) of the programmed setpoint.

#### *Probe Failure Indication*

If the temperature probe fails, the display will flash **PROBE FAILURE** and an audible alarm will sound. To cancel the alarm, turn the computer OFF. In split-vat fryers, turn off the side in which the failure occurred. If a probe fails during the high-limit test, **PROBE FAILURE** is displayed.

**NOTE:** If the temperature probe fails in the left side of a split-vat, that side cannot be turned back ON once it has been turned OFF.

## Recovery Out of Range (REC LOC)

**Recovery time** is an indication of the condition of the fryer. When the fryer is first turned on, the computer records the amount of time it takes to heat the cooking oil from 250°F (121°C) to 300°F (149°C). Also, anytime the temperature of the oil drops below 180°F (82°C), such as when cold oil is added, the computer will check the recovery time. If the fryer takes longer than 1 minute and 40 seconds to recover, the display will show **REC LOC** and the computer will lock out.

To clear the **REC LOC** condition, enter the program mode (see *How to Enter the Program Mode* in on page 3-10) and push the temperature check switch  (see **diagram below**).

It is easy to view the currently recorded recovery time with the computer ON. Press the recovery recall switch  for the frypot you wish to check. On full-vat units, press the right switch.

If **REC LOC** occurs three or more times within a week, verify that oil is not being added while the fryer is heating (that is, while a heat mode indicator  is illuminated) and that the fryer's power cord is fully plugged in. If oil is not being added while the fryer is heating, and the power cord is fully plugged in, have the fryer checked by a qualified service agent.

## Clearing REC-LOCK

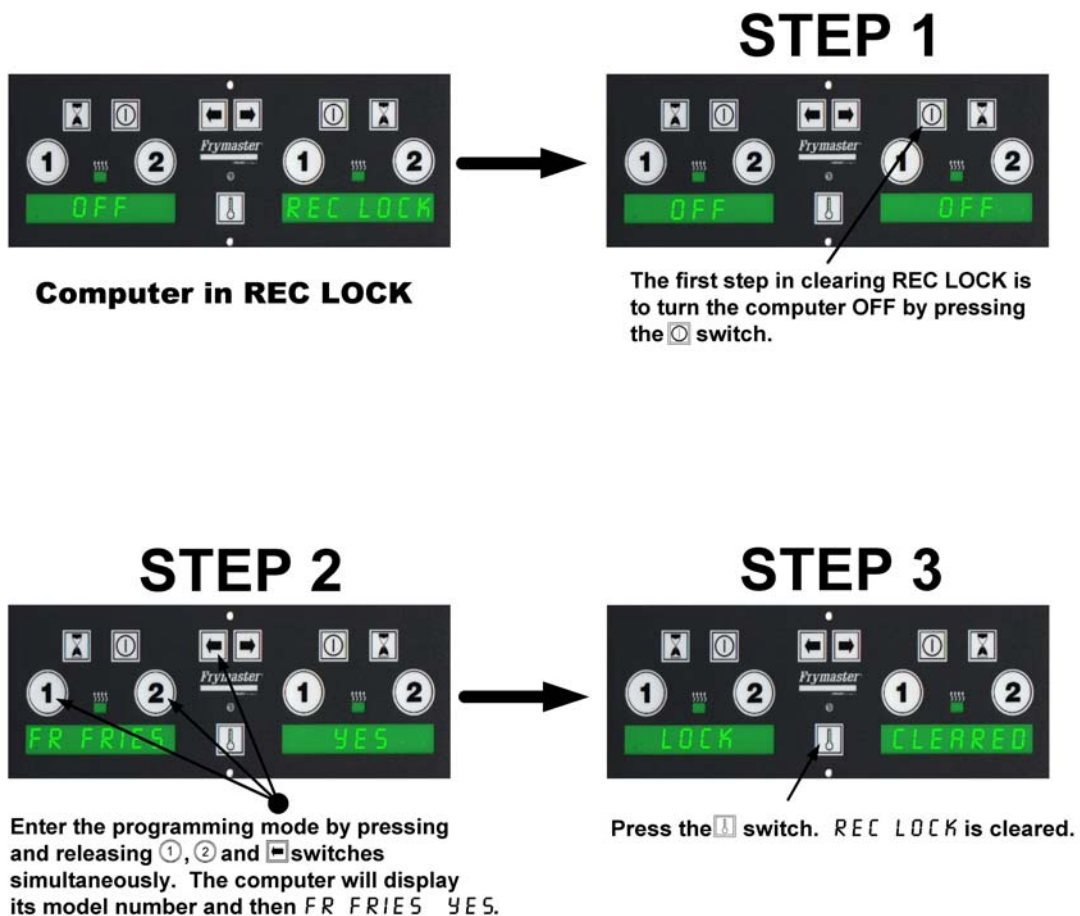

## 3.5 M-100B™ Computer Set-Up and Programming Instructions

The M-100B computer has three modes of operation. In addition to the *Cooking Mode*, which was discussed in Sections 3.3 and 3.4, there is a *Setup Mode* and a *Programming Mode*. (The cooking mode is the computer's default mode – when the computer is turned on, it comes up in the cooking mode.)

In the Setup Mode, the operator can:

- change the computer's display language
- configure the computer for use on electric or gas fryers
- configure the computer for use on either a full-vat or a split-vat fryer
- specify how the computer displays product names and temperatures
- calibrate computer temperature to actual frypot temperature
- activate or deactivate the frypot BOIL OUT feature

In the Program Mode, the operator can:

- reset the computer to the factory default settings
- change the shake, pull, and QA (hold) times for menu items
- change the cooking temperature setpoints for menu items
- add products and cooking parameters to the two test menus
- suppress a duty function in a menu item
- turn the display of a menu item in the factory-programmed menu on or off
- display usage information that is automatically recorded by the computer

### 3.5.1 M-100B™ Computer Setup Mode

#### How to Enter the Setup Mode

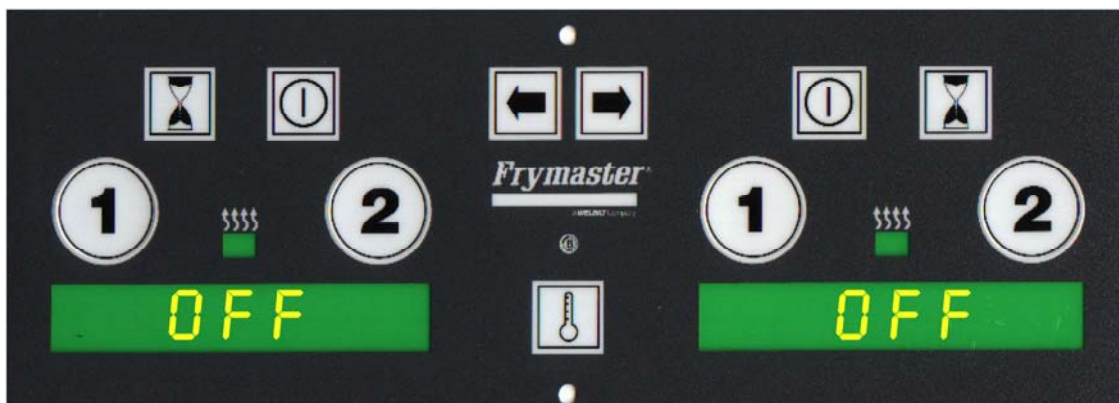

1. Turn both sides of the computer OFF by pressing the  switches. OFF will appear in both LED displays.





2. Press the right ,  and  switches simultaneously.

3. Release all 3 switches at the same time. **M100B**, then **SETUP** will appear briefly in the left display, then **BOIL-OUT** will appear in the left display and **YES** or **NO** will appear in the right display.



### How to Change the Computer's Display Language

1. Enter the setup mode. See *How to Enter the Setup Mode* on page 3-7.
2. Press and release the  switch until the word **l a n g u a g e** appears in the left LED display.
3. Press the right ① or ② switch until the desired language (English, French, French-Canadian, Spanish, or Portuguese) is displayed in the right LED display.
4. When the desired language is displayed, press either ON/OFF switch  to lock in the selection. The right display will show **l o a d i n g** for about 5 seconds, indicating that the computer's display language is being changed, then both displays will change to **OFF**.

### How to Configure the Computer for Use on an Electric Fryer





1. Enter the setup mode. See *How to Enter the Setup Mode* on page 3-7.
2. Press and release the  switch until **GAS Yes** or **GAS no** appears in the LED displays.
3. **Gas nO** indicates the computer is configured for use on an electric fryer; **Gas YES** indicates the computer is configured for use on a gas fryer. Press the right ① or ② switch to change the configuration.
4. Press the  switch to save the settings.
5. Press either ON/OFF switch  to save the setting and exit the setup mode. Both displays will change to **OFF**.

### How to Configure the Computer for Use on Either a Full-Vat or a Split-Vat Fryer

1. Enter the setup mode. See *How to Enter the Setup Mode* on page 3-7.
2. Press and release the  switch until **1 vat** appears in the left display.
3. Press the right ① or ② switch to toggle back and forth between full-vat (**yes**) or split-vat (**NO**).
4. Press the  switch to save the settings.
5. Press either ON/OFF switch  to exit the setup mode. Both displays will change to **OFF**.







### How to Change Computer Product/Temperature Displays



1. Enter the setup mode. See *How to Enter the Setup Mode* on page 3-7.

2. Press and release the  switch until the word **DISPLAY** appears in the left display.
3. Press the right  or  switch to toggle back and forth between constant product display (**CONSTANT**) or alternating temperature and product display (**ALT**).
4. Press the  switch to save the settings.
5. Press either ON/OFF switch  to exit the setup mode. Both displays will change to **OFF**.





### How to Calibrate Computer Temperature to Actual Frypot Temperature

**NOTE:** For this procedure, *actual frypot temperature* refers to the temperature of the oil in the frypot as measured with a good-grade thermometer or pyrometer. The computer's temperature can only be adjusted  $\pm 5^{\circ}\text{F}$  ( $\pm 3^{\circ}\text{C}$ ). The computer cannot be adjusted to a temperature greater than  $375^{\circ}\text{F}$  ( $191^{\circ}\text{C}$ ).

1. Enter the setup mode. See *How to Enter the Setup Mode* on page 3-7.
  1. Press and release the  switch until **CALIB** appears in the display.
  1. Press the temperature check switch . The frypot temperature sensed by the computer will be displayed. In split-vat units, the temperatures for each side will be displayed.
  1. **For the left side of a split-vat:** Press the left  switch to go UP a degree (maximum of 5 for Fahrenheit or 3 for Celsius). Press the left  switch to go DOWN a degree (maximum of 5 for Fahrenheit or 3 for Celsius).
- For the right side of a split-vat or for a full-vat:** Press the right  switch to go UP a degree (maximum of 5 for Fahrenheit or 3 for Celsius). Press the right  switch to go DOWN a degree (maximum of 5 for Fahrenheit or 3 for Celsius).



1. Press the  switch to save the settings.
1. Press either ON/OFF switch  to exit the setup mode. Both displays will change to **OFF**.

### How to Activate or Deactivate the Frypot BOIL-OUT Feature

0. Enter the setup mode. See *How to Enter the Setup Mode* at the beginning of this section.
0. Press and release the  switch until **BOIL-OUT** appears in the display.
0. Press the right  or  switch to toggle the boil-out mode ON or OFF.
0. Press the  switch to save the settings.
0. Press either ON/OFF switch  to exit the setup mode. Both displays will change to **OFF**.

## 3.5.2 M-100B™ Computer Programming Mode



### How to Enter the Program Mode

1. Press the ON/OFF  switches until both displays of cooking computer indicate OFF. Press the *left* product selection switch  and the *left* ① and ② cook switches simultaneously. Release all three switches at the same time.
2. When the program mode has been entered, the display will flash M-100B computer briefly, followed by the software version number. After a few seconds, Fr fries yes or Fr fries no will be displayed, depending upon previous program settings.

### How to Reset the Computer to the Factory Defaults

While in the program mode, press all 4 cook switches (left and right ① and ②) simultaneously to reset the computer to the factory defaults. See *How to Enter the Program Mode* above. Updating menu will flash in the display, followed by epra cleared and cooks cleared. After a few seconds, Fr fries yes will be displayed, indicating that the computer has been reset to the factory defaults.

### How to Change the Shake, Pull, Or Quality Times for Menu Items

1. Enter the program mode. (See *How to Enter the Program Mode* above.)
2. Press and release the  switch until the product to be changed appears in the left display.
3. Press and release the  switch until the function to be changed (SHAKE, PULL, or QA) appears in the left display. The current time setting and automatic (AUTO) or manual (MAN) alarm cancel mode options appear in the right display.



**NOTE:** *Shake Time* refers to the programmed time at which the operator will be prompted by an audible alarm to shake the basket, but not stop the cooking process. *Pull Time* refers to the programmed time at which the product is fully cooked and at which the operator will be prompted by an audible alarm to remove the basket from the cooking oil. *QA Time* refers to the maximum time that a product may be held after the cooking cycle has completed.

**NOTE:** When the programmed time has elapsed, the automatic alarm-cancel mode (AUTO) audible alarm will sound three times and then stop. When the programmed time has elapsed, the manual alarm cancel mode (MAN) audible alarm will sound until the operator presses the cook switch (① or ②) that was pressed to start the cooking cycle.



4. Press the right ② switch to toggle between automatic alarm cancel mode (AUTO) and manual alarm cancel mode (MAN).

- To change the times, use the following switches:

Left		Minutes (in increments of ten)
Left	①	Minutes (in increments of one)
Left	②	Seconds (in increments of ten)
Right	①	Seconds (in increments of one)

- Press the  switch to lock in the new settings, and either ON/OFF switch  to exit the programming mode. Both displays will show **OFF**.

### How to Change the Cooking Temperature Setpoint





- Enter the program mode. See *How to Enter the Program Mode* on page 3-10.
- Press and release the  switch until the menu item to be changed is displayed.
- Press the  switch to show the cooking temperature setpoint, displayed as **SET-TEMP** in the left display. The current setpoint temperature is in the right display (for example-**350F**). The temperature will be in Fahrenheit (**F**) or Celsius (**C**). Pressing the right  switch toggles the computer between Fahrenheit (**F**) and Celsius (**C**).
- To change the temperature, use the following switches:

Left	①	Hundreds
Left	②	Tens
Right	①	Ones

**NOTE:** The computer cannot be programmed for a temperature greater than 375°F (191°C).

- Exit the program mode by pressing either ON/OFF switch .





### How to Enter a Product Name in a Test Menu

- Enter the program mode. See *How to Enter the Program Mode* on page 3-10.
- Press the  switch to select Test Menu 1 or 2.
- Press the  switch to enter the edit mode. The right display will show **EDIT** and a blinking cursor will appear in the left display.
- To enter a letter, use the left  switch to go UP in the alphabet. Use the left  switch to go DOWN in the alphabet.

**NOTE:** Characters available are the letters A-Z and the numbers 0-9. Special characters \*, , -, ?, and / are also available, as is a blank space.



**NOTE:** Pressing the left  switch will reset the product name to the factory defaults.





- To move to a different character position, use the  or  switches.

- To EXIT and SAVE the product name entry, press the  switch. **SAVE** will flash in the right display, followed by **YES** or **NO**, indicating whether the menu item is active or not. Press the right  or  switch to toggle between yes and no.
- Press the  switch to cycle through the Duty Times, Pull Time, QA (hold) Time, and Cooking Temperature Setpoint settings. Program the times and the set point in accordance with the section that follows.



### How to Program Duty Times, Pull Time, QA Time, and Setpoint for a Test Menu Item

**NOTE:** *Duty Time* refers to an operator-specified time within a cooking cycle when the computer will sound an alarm to prompt a particular duty such as shaking the basket.

- Enter the program mode. See *How to Enter the Program Mode* on page 3-10.
- Press the  switch to select the desired test menu.
- Press the  switch. **DUTY1** will appear in the left display. The currently programmed time appears in the right display. To program the time, use the following switches:

Left		Minutes (in increments of ten)
Left		Minutes (in increments of one)
Left		Seconds (in increments of ten)
Right		Seconds (in increments of one)



Press the right  switch to toggle between the manual alarm cancel mode (**MAN**) and the automatic alarm cancel mode (**AUTO**).



**NOTE:** In the automatic alarm cancel mode (**AUTO**), when the programmed time has elapsed, an audible alarm will sound three times and then stop. In the manual alarm cancel mode (**MAN**), when the programmed time has elapsed, an audible alarm will sound until the operator presses the cook switch ( or ) that was pressed to start the cooking cycle.



- Press the  switch, **DUTY2** appears in the left display. The currently programmed time appears in the right display. Program the time in the same manner as Duty1 time.

**NOTE:** Enter a time of **OO:OO** to bypass this option.





**NOTE:** In the steps that follow, *Pull Time* refers to the programmed time at which the product is fully cooked and an audible alarm will prompt removal of the basket from the cooking oil. *QA Time* refers to the maximum time that a product may be held after the cooking cycle has completed.

- Press the  switch to display **PULL** in the left window. Program the pull time in the same manner as the duty times.
- Press the  switch to display **QA** in the left window. Program the QA time in the same manner as the duty times.







- Press the  switch to show the cooking temperature setpoint, displayed as **SET-TEMP** in the left display. The current setpoint temperature is in the right display (for example-**350F**). The temperature will be in Fahrenheit (**F**) or Celsius (**C**). Pressing the right  switch toggles the computer between Fahrenheit (**F**) and Celsius (**C**). To change the temperature, use the following switches:

Left		Hundreds
Left		Tens
Right		Ones





**NOTE:** The computer cannot be programmed for a temperature greater than 375°F (191°C).

- Press the  switch to show the status of the Test Menu Cook Time Compensation feature. The display will show **PROBE** in the left window and **YES** or **NO** in the right window. With the feature set to **YES**, the cooking time of the product will be temperature-compensated; with the feature set to **NO**, the product cooking time will not be compensated. Press the right  or  switch to toggle between **YES** or **NO**.
- Exit the program mode by pressing the right  switch. Both displays will show **OFF**.

### How to Suppress a Shake, QA, or Duty Function



- Enter the program mode. See *How to Enter the Program Mode* on page 3-10.
- Press and release the  switch until menu item to be modified is displayed in the left window.
- Press and release the  switch until the function to be suppressed is displayed in the left window.
- Use the cook switches , ,  from left to right to set the time display to read **000**. This will suppress the function during the cooking cycle. To reactivate the function, follow steps 1 through 3 to enter a time for the function.
- Exit the program mode by pressing the right  switch.

### How to Turn the Display of a Factory-Programmed Menu Item On and Off

- Enter the program mode. See *How to Enter the Program Mode* on page 3-10.
- Press and release the  switch until the menu item to be turned on or off is displayed in the left window.
- The right display will show **YES** or **NO**. To turn the menu item **OFF**, press either of the right  or  switches to set the option to **NO**. To turn the menu item **ON**, change the option to **YES**.
- Exit the Program Mode by pressing the right  switch. Both displays will read **OFF**.

## How to Display “Use Time” Information





**NOTE:** This feature is used to determine the total amount of time that a fryer has been cooking.

1. Enter the program mode. See *How to Enter the Program Mode* on page 3-10.
2. Press the left  switch to display use time for the left side of a dual-vat unit. Press the right  switch to display use time for a full-vat unit or the right side of a dual-vat unit.
3. To reset use time data to zero, while pressing one of the  switches, press the same side's ① and ② switches, then release them simultaneously.

**NOTE:** The simultaneous release of these three switches is critical. If not done correctly, data will not reset.



## How to Display the Product Cycle Accumulator Information

**NOTE:** This feature keeps a running total of cooking cycles per product.

1. Enter the program mode. See *How to Enter the Program Mode* on page 3-10.
2. Press the left or right  switch.
3. For the left vat, press the  switch. For the right or for a full-vat, press the  switch. A running total of cooking cycles per product will be displayed.
4. To clear the accumulated times from computer memory, press either  switch, then the  switch.

## How to Use the Filter Countdown Timer

**NOTE:** This feature starts a five-minute countdown timer to time the polishing of vegetable oil during the filtering process. **Polishing** refers to circulating the vegetable oil through the filtration system for a specified time. This feature does not have any direct control over the filtration process; it is only a timer.

1. With the computer ON, press and release the  switch until **FILTER** appears in the display. (For split-vat units, press and release the  switch for the left vat.)
2. Press either of the right ① or ② switches. The computer will begin to countdown from five minutes to zero. (For split-vat units, press either of the left ① or ② switches for the left vat.)

## CHAPTER 4: OPERATING FRYERS WITH ANALOG CONTROLLERS

### 4.1 Equipment Setup and Shutdown Procedures

#### Setup

 **WARNING**

**Fill the frypot to the bottom oil level line with vegetable oil before pressing the power switch to the ON position. Failure to do so could damage the frypot.**

Fill the frypot with vegetable oil to the bottom OIL LEVEL line located on the rear of the frypot. This will allow for oil expansion as heat is applied. Do not fill cold oil any higher than the bottom line; overflow may occur as heat expands the oil.

Ensure that the power cord(s) is/are plugged into the appropriate receptacle(s). Verify that the face of the plug is flush with the outlet plate, with no portion of the prongs visible.

Set the thermostat knob to the desired frying temperature.

Ensure that the vegetable oil level is at the *top* OIL LEVEL line when it *is at its intended cooking temperature*. It may be necessary to add vegetable oil to bring it up to the proper level.

#### Shutdown

1. Press the POWER switch to the OFF position (the POWER light will go out).
2. Filter vegetable oil and clean fryers.
3. Place the frypot covers on the frypots.

### 4.2 Introduction to the Analog Controller

The analog controller, illustrated on the following page, is used to adjust and maintain vegetable oil at the temperature indicated by the thermostat knob. The fryer has two built-in high-limit protection features. If the temperature in the frypot reaches approximately 410° F (210° C), the computer opens the heat relay circuit, turning the elements off. If the temperature in the frypot reaches 450° F (232° C), a mechanical high-limit shuts off electrical power to the elements. The operator should periodically test each of the high-limit protection features to verify that they are operating correctly. Refer to page 4-3, Analog Controller High-Limit Check, or the Grills/Fryers Maintenance Requirement Card (MRC) 15 for the procedure.

The analog controller has no timing features. Shake, pull, and QA (hold) times must be monitored by the operator.

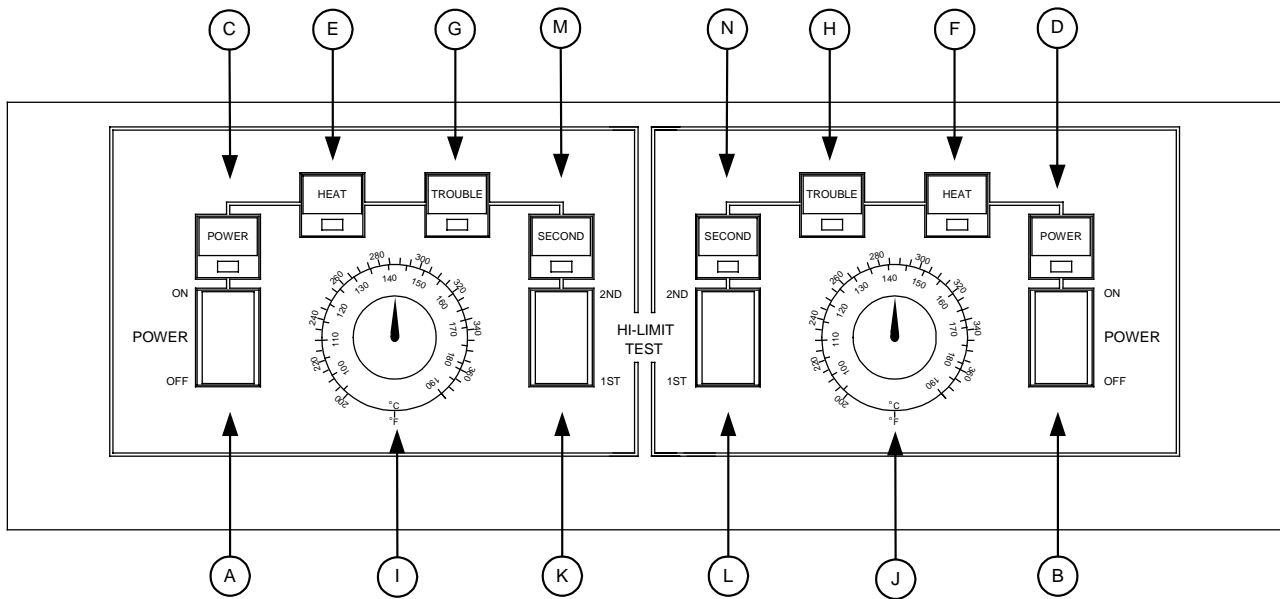

**SPLIT VAT CONTROLLER ILLUSTRATED  
FULL VAT CONTROLLER HAS ONLY LEFT SET OF CONTROLS**

ITEM	DESCRIPTION
A	Power Switch, Left or Full-Vat - Controls electrical power to fryer.
B	Power Switch, Right Vat - Controls electrical power to fryer.
C	Power-On Light, Left or Full-Vat - Indicates when electrical power to fryer is ON.
D	Power-On Light, Right Vat - Indicates when electrical power to fryer is ON.
E	Heating Mode Light, Left or Full-Vat - Indicates when heating element is ON.
F	Heating Mode Light, Right Vat - Indicates when heating element is ON.
G	Trouble Light, Left or Full-Vat - Indicates over high-limit or problem in heat control circuitry.
H	Trouble Light, Right Vat - Indicates over high-limit or problem in heat control circuitry.
I	Thermostat Control Knob, Left or Full-Vat - Sets desired frying temperature.
J	Thermostat Control Knob, Right Vat - Sets desired frying temperature.
K	Hi-Limit Test Switch, Left or Full-Vat - Tests high-limit thermostat for left vat (or full-vat).
L	Hi-Limit Test Switch, Right Vat - Tests high-limit thermostat for right vat.
M	Second Hi-Limit Test Light, Left or Full-Vat - Indicates fryer is in second high-limit test mode.
N	Second Hi-Limit Test Light, Right Vat - Indicates fryer is in second high-limit test mode.

### 4.3 Analog Controller Operating Instructions

 **WARNING**

**Before pressing the power switch to the ON position, ensure that the frypot is properly filled with vegetable oil. See Section 4.1.**

1. Verify that the thermostat knob is set to the desired cooking temperature. For split-vat units, set both knobs.
2. Press the power switch to the ON position. The POWER light will illuminate. For split-vat units, both power switches must be placed in the ON position if both vats are to be used.
3. If the frypot temperature is below 180° F (82° C), the controller will automatically enter a warm-up cycle (often called a melt cycle). The heating elements will cycle on and off repeatedly, allowing the vegetable oil to heat gradually, without scorching. During the warm-up cycle, the heating mode light will alternately illuminate and go off as the elements cycle on and off. Within about 45 minutes, the controller will exit the warm-up cycle and the heating mode light will remain continuously illuminated.
4. When the vegetable oil temperature reaches the thermostat knob setpoint, the elements will cycle OFF and the heating mode light will go off, indicating that the fryer is ready for the cooking process to begin.

### 4.4 Analog Controller High-Limit Check

**Tools needed:** Maple Paddle

**Note:** Conduct this test when fryer will not be needed for about one hour, and when the vegetable oil is due to be changed. Discard the vegetable oil after completing this check

**Note:** Check high-limit on only one vat at a time.

 **CAUTION**

**Grease filters must be in place and exhaust fans MUST be ON during entire high-limit control-check procedure.**

1. The vegetable oil should be at the normal/shortening level line. Add vegetable oil if necessary.
2. Remove the computer probe from the probe holder and replace it with fry vat probe.
3. Turn the vat power switch to “ON” and set thermostat knob to its highest setting, and wait for heating light to go OFF.

**Note:** You must agitate vegetable oil during the entire high-limit control-check procedure with a maple paddle.

 **CAUTION**

If after completing both high-limit tests you find only the second high-limit operates properly, the vat can be used if it is absolutely necessary, but with extreme care. The controller must be replaced immediately after this period of necessity. If the second high-limit does not work the vat must not be used until the second high-limit has been replaced. If the first high-limit feature activates at less than 400°F (204°C), do not replace the controller unless it interferes with proper cooking. If the second high-limit activates at less than 425°F (218°C), do not replace it unless it prevents you from checking the first high-limit feature.

4. Press and hold "first high-limit" position of the vat high-limit test switch.

**Result:** Electrical element or gas burner turns OFF and "TROUBLE" light comes ON. Vegetable oil temperature should be between 400° and 425°F (204° and 218°C).

5. Press and hold "second high-limit" position of the vat high-limit test switch.

**Note:** When the trouble light comes ON, or the temperature exceeds 425°F (218°C), release switch.

**Result:** Electrical elements or gas burner turns OFF and the second high-limit will come ON. The vegetable oil temperature should be between 425° and 450°F (218° and 232°C).

 **CAUTION**

When the second high-limit light comes on, or the temperature exceeds 450°F (232°C), release switch.

6. Turn the power switch to the "OFF" position. One vat must remain ON to ensure hood fan remains ON.

7. Remove the fry vat probe and reinstall the computer probe into the vat.

8. Allow vegetable oil to cool for one hour before discarding. See statement on discarding oil (Chapter 5).

**Note:** Hot oil must not be transported until it cools to 100°F (38°C) or less.

High-Limit check is complete. Repeat procedure for each remaining vat.

## CHAPTER 5: OPERATING THE BUILT-IN FILTRATION SYSTEM

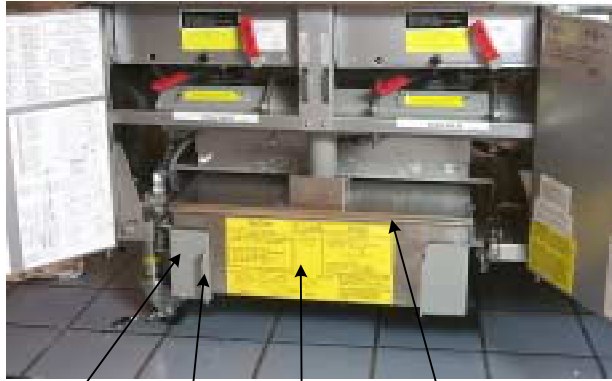

- ①
- ⑤
- ②
- ④

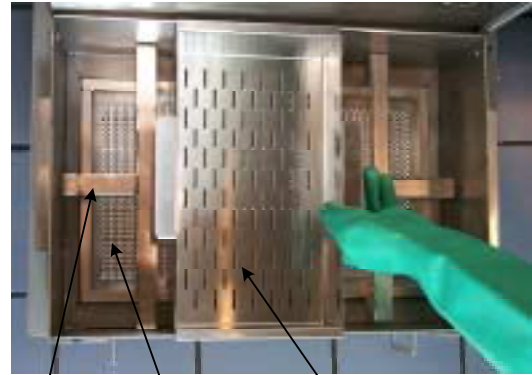

- ③
- ⑥
- ⑦

ITEM	DESCRIPTION	FUNCTION
1	Filter Base Assembly	Housing for filter pan.
2	Filter Pan Assembly	Collects vegetable oil during filtering process.
3	Filter Paper Hold-down Ring	Secures filter paper or pad in place.
*	O-ring, Filter Pan	Seals pan suction line.
4	Pan Cover	Covers filter pan assembly.
*	Screw, Pan Cover Hinge	Attaches pan cover to filter pan.
5	Filter Base Handle	Means to pull filter assembly from fryer.
6	Filter Paper Screen	Fits under filter paper/pad to allow passage of oil when filtering.
7	Crumb Screen	Collects heavy breading when draining oil into filter pan.
* Not Illustrated		

## 8.1 STEP-BY-STEP FILTRATION INSTRUCTIONS



Switch computer to OFF.



Slide the filter pan from the fryer cabinet.

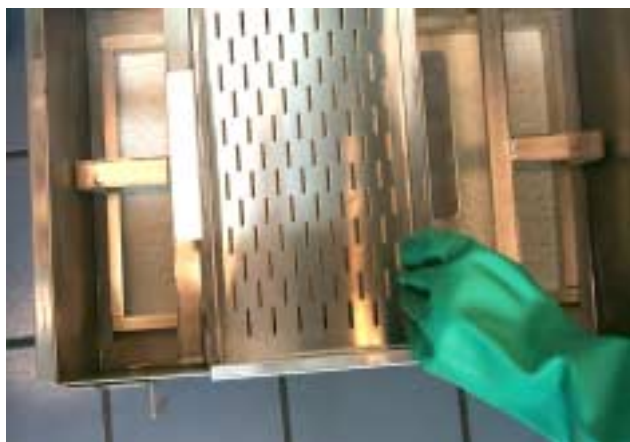

Open the filter-cover, and remove and clean the crumb tray.



Remove and clean the hold-down ring.  
Remove and discard the dirty paper or pad.



Remove and clean the filter screen.



Make sure the inside of the pan is free of all food and breading particles that could prevent the screen from sealing against the bottom of the pan.



Install the filter screen in the bottom of the pan. Proper operation of the filter system depends upon proper placement of the filter screen. Never filter with the screen alone.

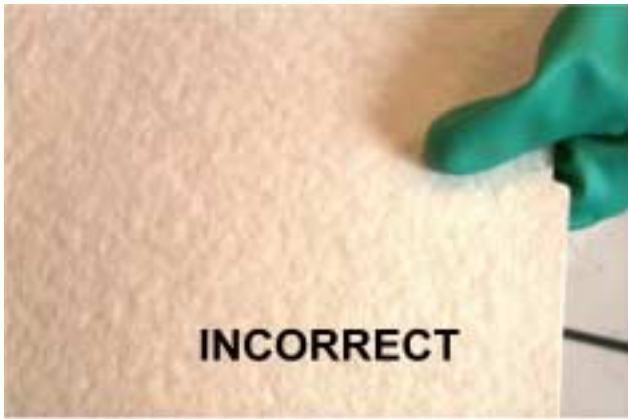

The filter pad is placed in the pan with the heavily textured side facing up. When filter paper is used, one sheet is placed over the screen and 8-ounces of filter powder is spread evenly on the top of the paper.



**WARNING: Do Not Use Filter Powder on Filter Pads**



Place pad evenly on filter screen. If paper is used, position the paper on top of the pan with the edges evenly overlapping. **Ensure that the screen is in place prior to pad or paper placement.**

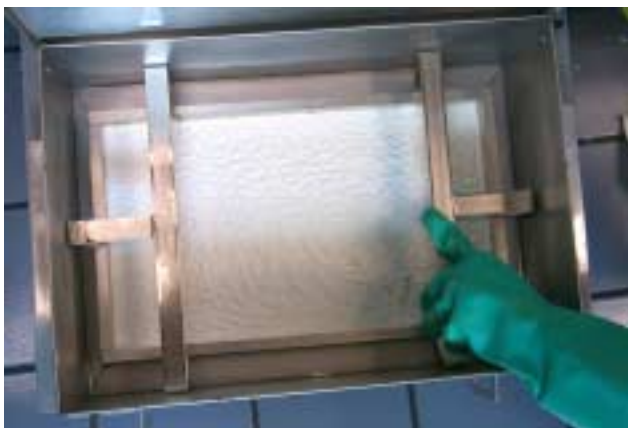

Install hold-down ring over pad, or use ring to push filter paper to the bottom of the pan. Push down firmly to properly seat the paper/pad.



Use 8-ounces of filter powder and spread it evenly over filter paper. **Remember, Do Not Use filter powder on filter pads.**

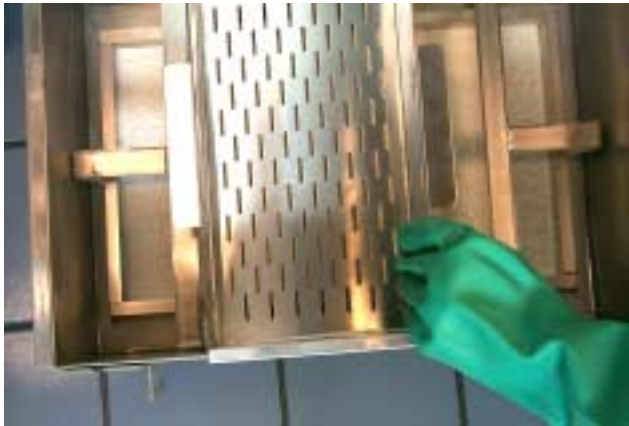

Replace crumb screen inside the filter pan. It's imperative that the crumb screen is installed prior to filtering, for optimum filter-system performance.



Slide the filter pan back inside fryer cabinet.



Important: Filter shortening or oil at operating temperature. Filtering at the end of the day ensures that the shortening or oil is at proper temperature.



Drain-Valve Handle

Return Handle

Return handle and drain-valve handle location.



With fryer off, open drain valve.



When frypot empties into filter pan, turn return handle to ON. Filter pump will activate.



Turn the computer back ON and use right arrow key  to step through selection, stopping on FILTER. Press right ② button to initiate five-minute timer for filtering.



The computer will countdown the process, although it does not control the filtering.



The oil moves through the filter, the frypot and out the open frypot-drain during filtering.



Polishing is a timed process that cleans the oil and washes small particles from the frypot.



When the final seconds of the process tick off, FILTER will flash in the display, indicating the filter time has elapsed.





Close the drain-valve and leave the filter pump on to fill the frypot.



With the drain-valve closed, frypot fills with oil.



When the filter pan empties, bubbles will form in the frypot. Allow bubbling to continue 15-20 seconds to ensure the oil return lines are clear of shortening.



Turn off filter pump.



Turn the filter alarm off by pressing .



Top up oil level. Some oil may be lost in filtering process.

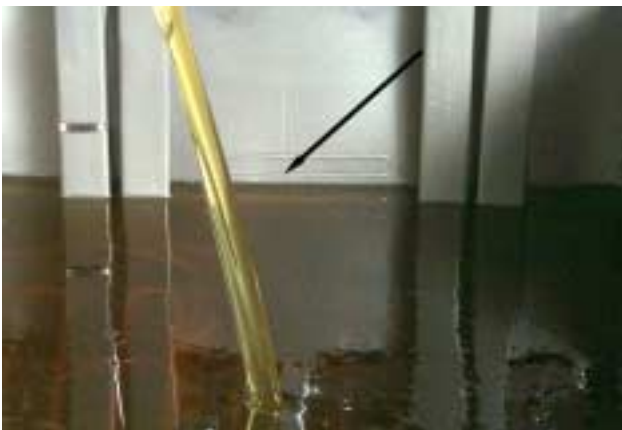

Fill to first mark in frypot.



The oil may drop below operating temperature during the filtering process. In that case, the fryer will display Low-Temp and heat the oil when it is turned on.



Return fryer to operation, or filter another frypot in the battery. Remember, only one frypot can be filtered at a time.

## 8.2 CARE AND CLEANING OF YOUR FRYER AND FILTER SYSTEM

**CAUTION:** Never operate the fryer or filter system without vegetable oil in the system.

1. Filter vegetable oil as often as needed. If a heavy volume of breaded food is fried, filter as often as every hour. Filtering often increases the life of the vegetable oil and produces a better-tasting product. The best rule to follow is to *"filter before you think it is needed"*. Even with a product such as french fries, you should filter two to three times per day for best results.
2. Periodically clean the frypot. Cleaning the frypot, combined with disposing of old vegetable oil enhances the flavor of the food product. After the fryer is empty, drain the frypot and close the drain valve. Fill the frypot to the OIL LEVEL line (or the bottom line for fryers equipped with two oil-level lines) with water and the correct amount of **McD All Purpose Concentrate (APC) Cleaner HSC**. Place the baskets into the frypot and bring the solution to a simmer at 195° F (90.5° C) for 1 hour. Turn OFF the fryer, drain the solution and wipe the frypot clean and dry.

**NOTE:** Do not drain water into the filter pan. Water will damage the filter pump enough to require replacement. Use a stockpot or bucket.

3. The filter pan and filter base assembly must be cleaned on initial start-up and periodically thereafter.
  - a. To clean the filter pan, lift pan from the filter base. Take the filter pan to a sink filled with warm water and grease-cutting detergent.
  - b. Scrub the filter pan with the frypot brush shipped with the fryer.
  - c. Rinse the filter pan thoroughly to remove the detergent. Wipe dry with a clean, dry cloth or paper towels.

- d. To clean the filter base assembly, use a sponge or cloth soaked with a water and grease-cutting solution. Be careful not to get water on the pump/motor assembly.
- e. Wipe filter-base assembly dry with a clean, dry cloth or paper-towel.

 **CAUTION**

**All water MUST be removed from the suction tube before inserting filter pan.**

- f. Wipe the inside and outside of the tube with clean, dry cloths or paper towels.
- g. Insert filter pan into the filter base assembly.

**NOTE:** To drain old oil or boil-out solution, drain in an appropriate container. **DO NOT DRAIN WATER IN THE FILTER PAN.**

 **WARNING**

**The filter pan MUST never be used to dispose of, or transport spent-cooking oil/shortening to the disposal area. Cooking oil /shortening MUST always be allowed to cool below 100°F (38°C) before transporting to the disposal area. A shortening disposal unit (MSDU) is available and highly recommended for safety.**

**⚠ CAUTION**

***Statement on discarding oil:*** Hot cooking-oil is dangerous and will cause severe burns. Handle with extreme caution. When discarding old cooking oil, drain from the fryer into a Vegetable Oil Disposal Unit (MSDU50) - available from your local distributor. The disposal unit should be taken to the disposal site and the old cooking oil pumped into the grease storage container for proper disposal.



MSDU50

# CHAPTER 6: PREVENTIVE MAINTENANCE AND TROUBLESHOOTING

## 6.1 Preventive Maintenance

Preventive Maintenance (PM) procedures are contained in McDonald's Preventive Maintenance System Maintenance Requirement Cards (MRC) 12, 14, 14A, and 15. The cards are distributed with this manual, but are not an integral part of the manual. A replacement card set may be ordered using part number 819-5432. To order both the card set and the Operator's Manual, use part number 819-5569. To order both the card set and the Service Manual, use part number 819-5625.

## 6.2 Troubleshooting

This section provides an easy reference guide to some of the common problems that may occur during the operation of this equipment. The troubleshooting guides that follow are intended to help correct, or at least accurately diagnose, problems with this equipment. Although the chapter covers the most common problems reported, you may encounter problems that are not covered. In such instances, the Frymaster Technical Services staff will make every effort to help you identify and resolve the problem.

When troubleshooting a problem, always use a process of elimination starting with the simplest solution and working through to the most complex. Never overlook the obvious – anyone can forget to plug in a cord or fail to close a valve completely. Most importantly, always try to establish a clear idea of why a problem has occurred. Part of any corrective action involves taking steps to ensure that it doesn't happen again. If a controller malfunctions because of a poor connection, check all other connections, too. If a fuse continues to blow, find out why. Always keep in mind that failure of a small component may often be indicative of potential failure or incorrect functioning of a more important component or system.

***Before calling a service agent or the Frymaster HOTLINE (1-800-24FRYER):***

- **Verify that electrical cords are securely plugged in.**
- **Verify that circuit breakers are on.**
- **Verify that frypot drain valves are fully closed.**

 **DANGER**

**Never attempt to move a fryer containing hot cooking oil or to transfer hot cooking oil from one container to another.**

 **DANGER**

**Use extreme care when testing electrical circuits. Live circuits will be exposed.**

 **WARNING**

**Inspection, testing, and repair of electrical equipment should be performed only by qualified service personnel. The equipment should be unplugged when servicing, except when electrical tests are required.**

## 6.2.1 Troubleshooting Fryers Equipped with M100B Computers

### Fryer Off

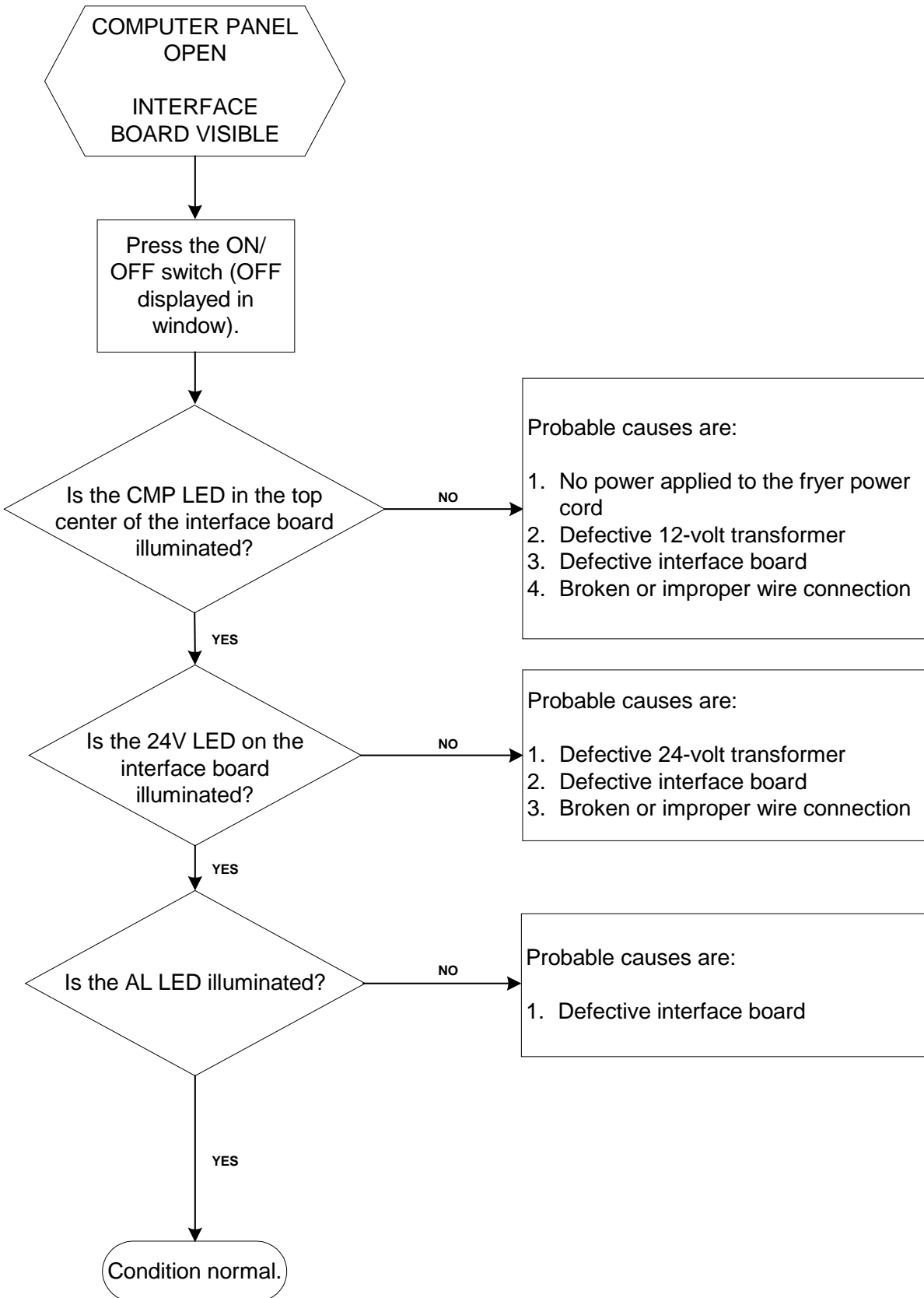

# Fryer Heating Oil

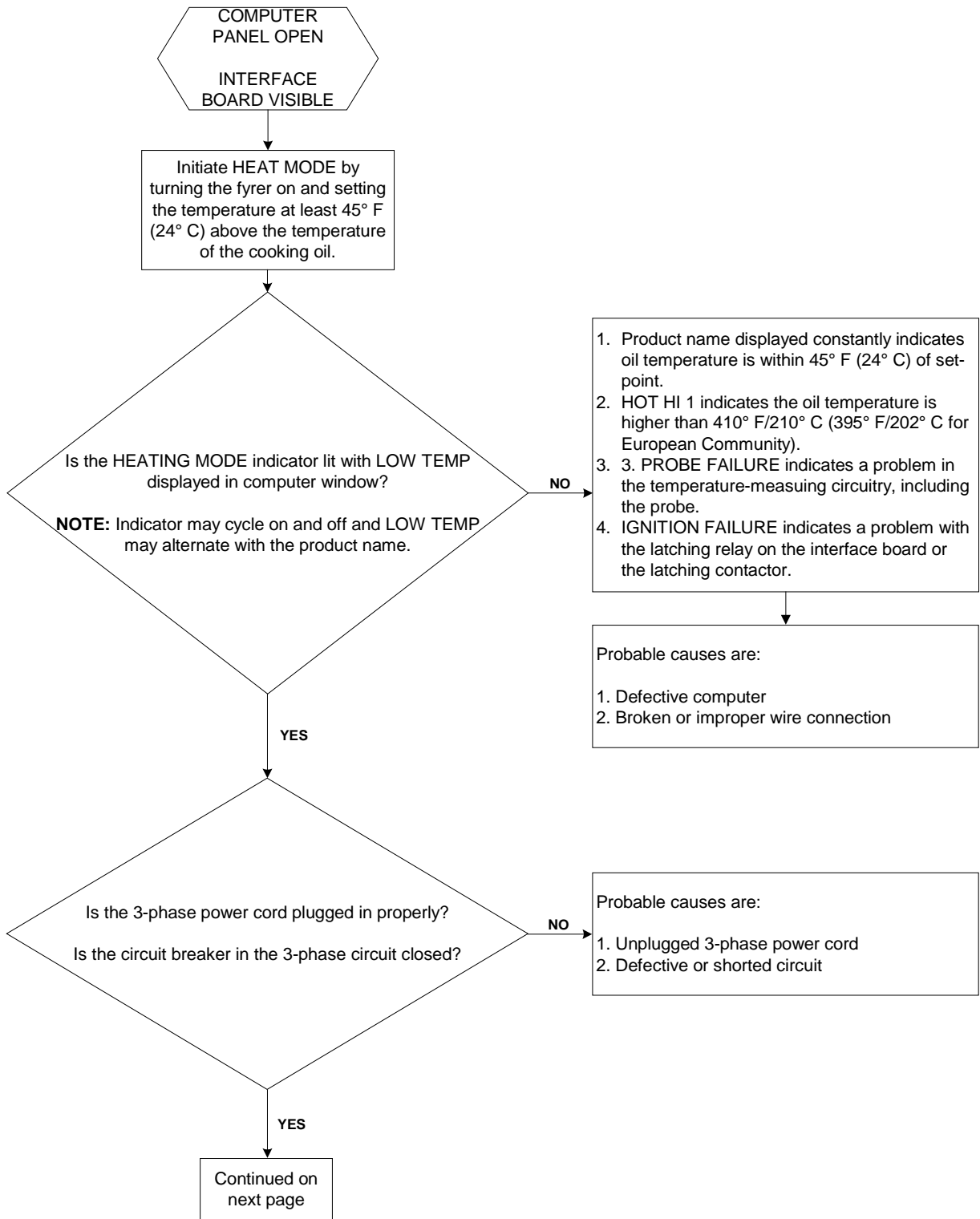

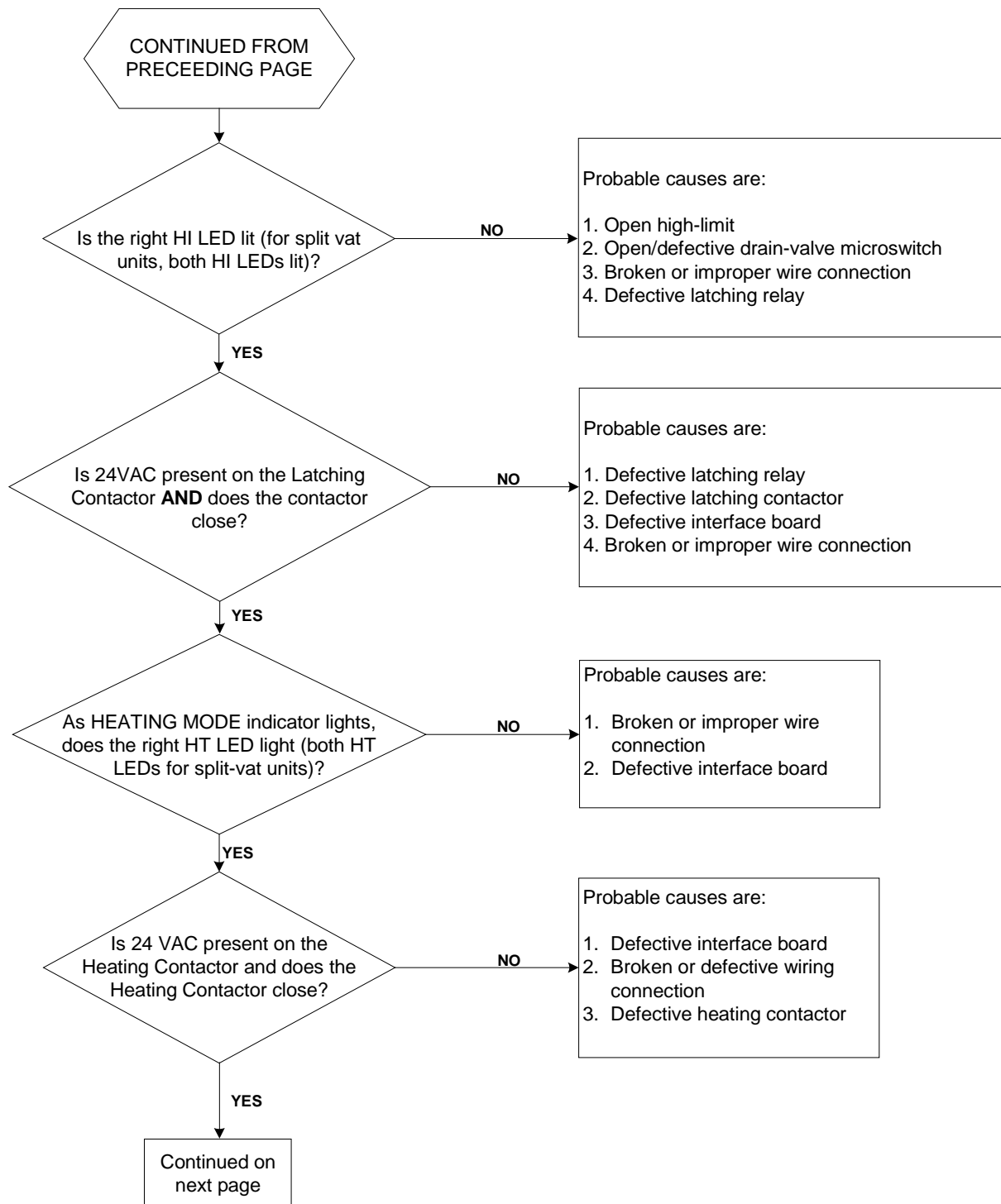

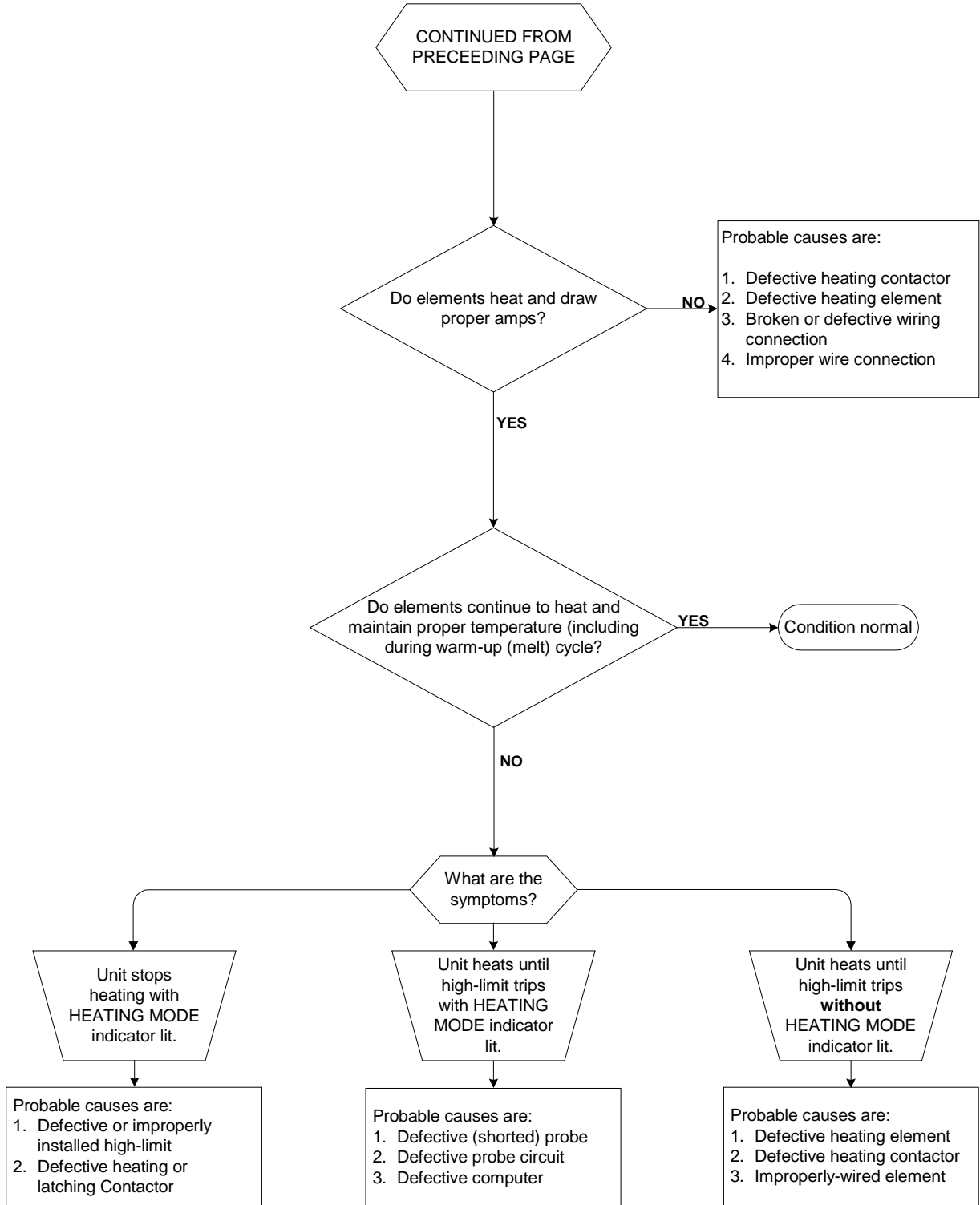

## 6.2.2 Troubleshooting Fryers Equipped with Analog Controllers

### Fryer Off

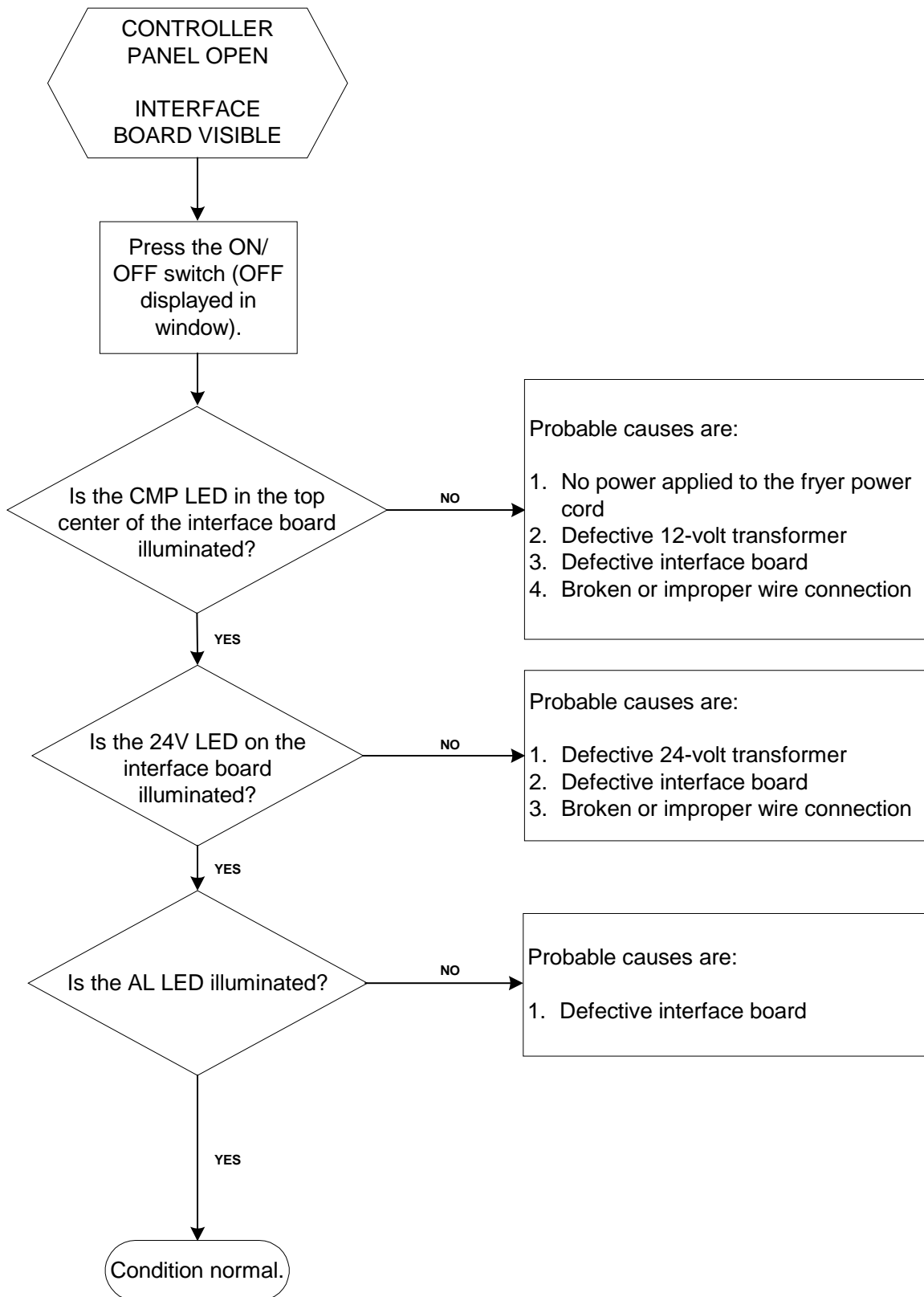

# Fryer Heating Oil

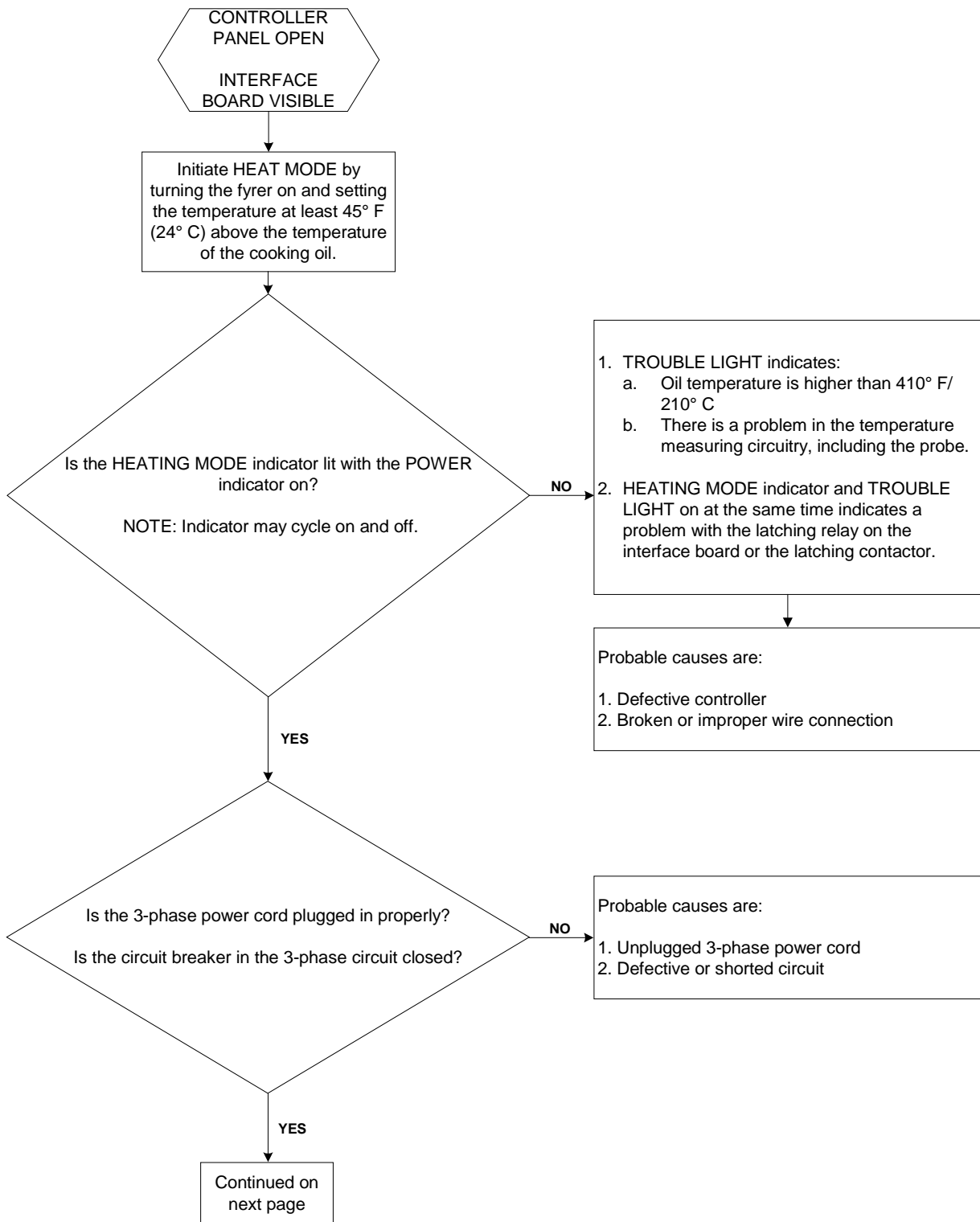

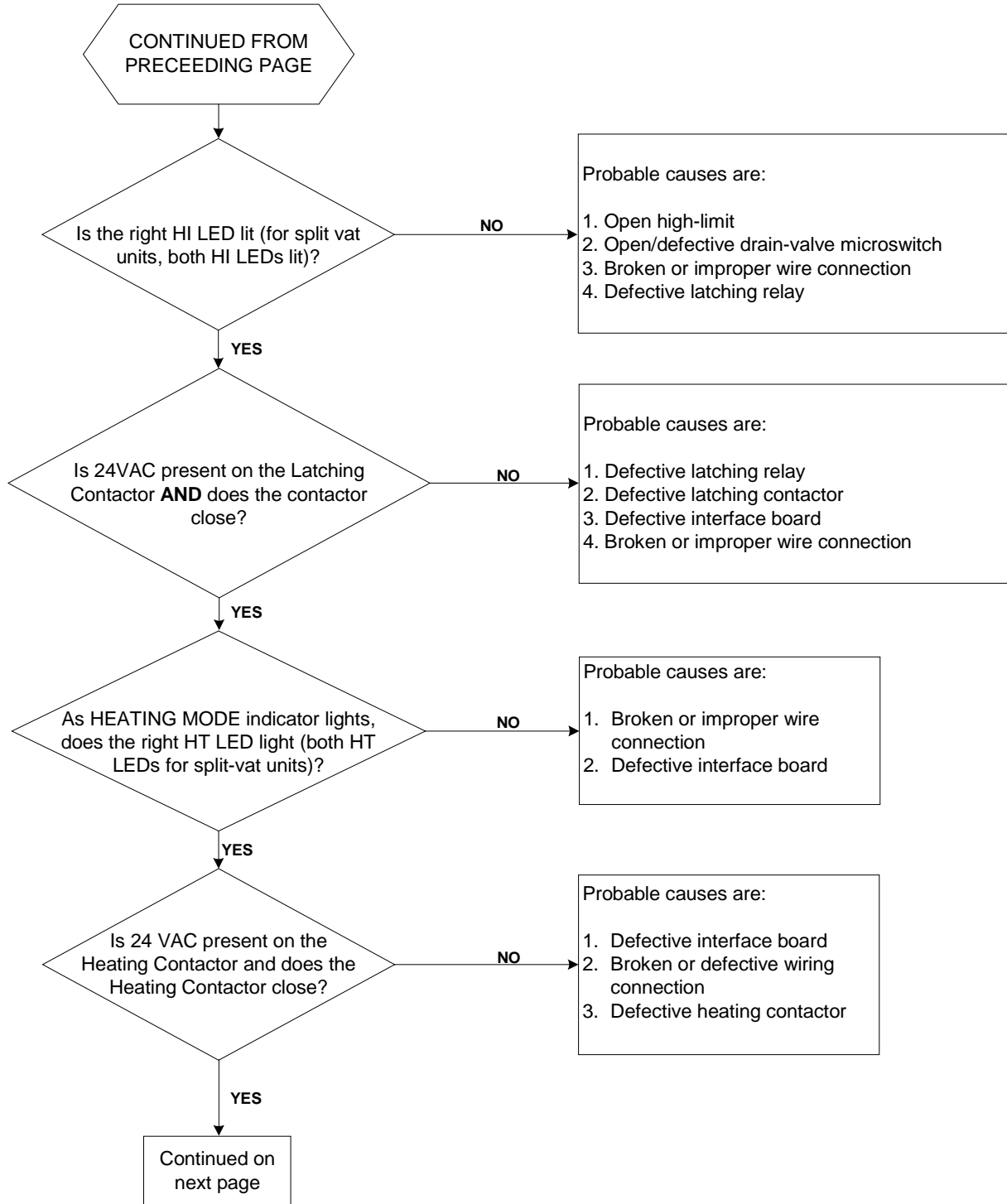

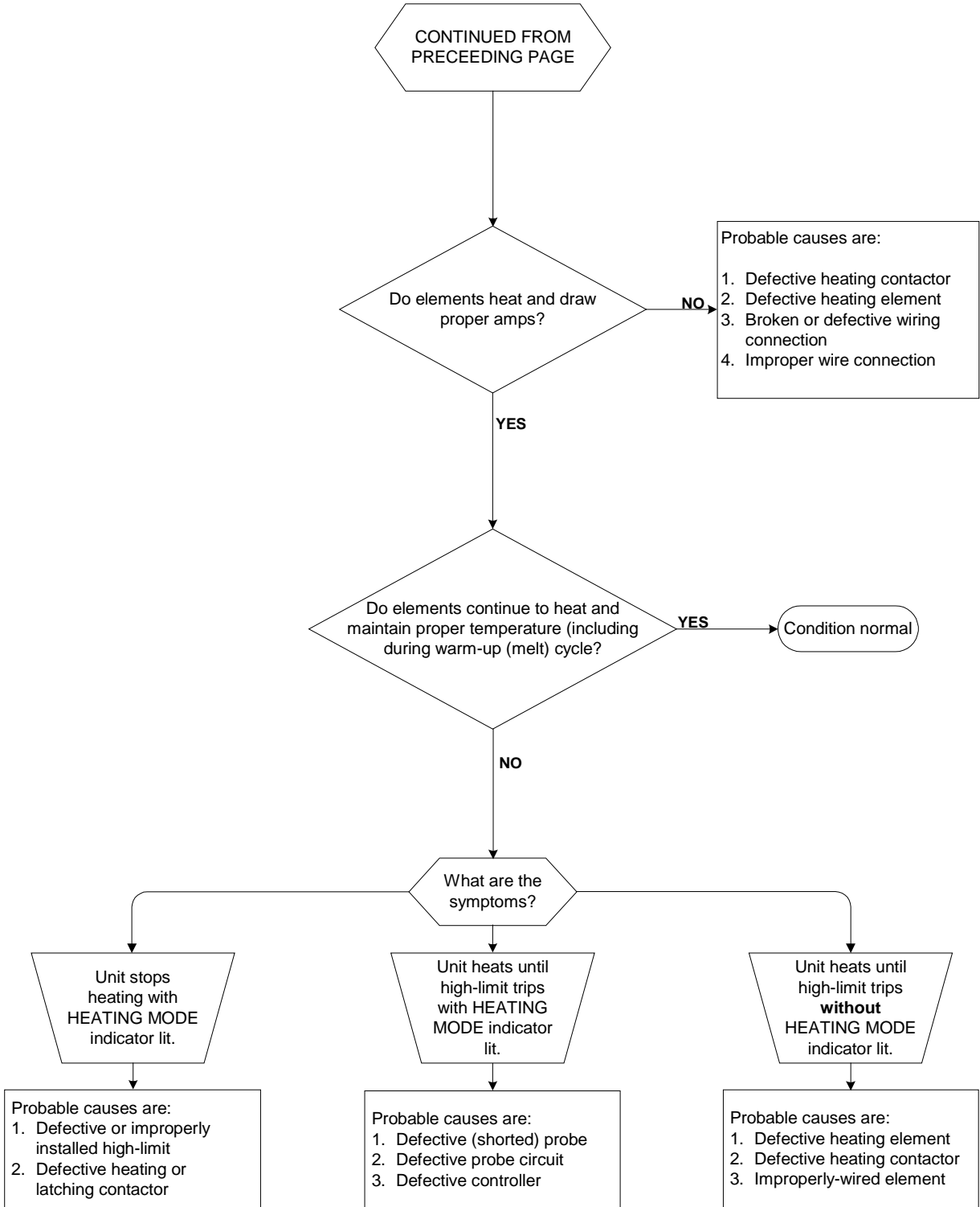

## 6.2.3 Troubleshooting the Built-in Filtration System (BIH14 units only)

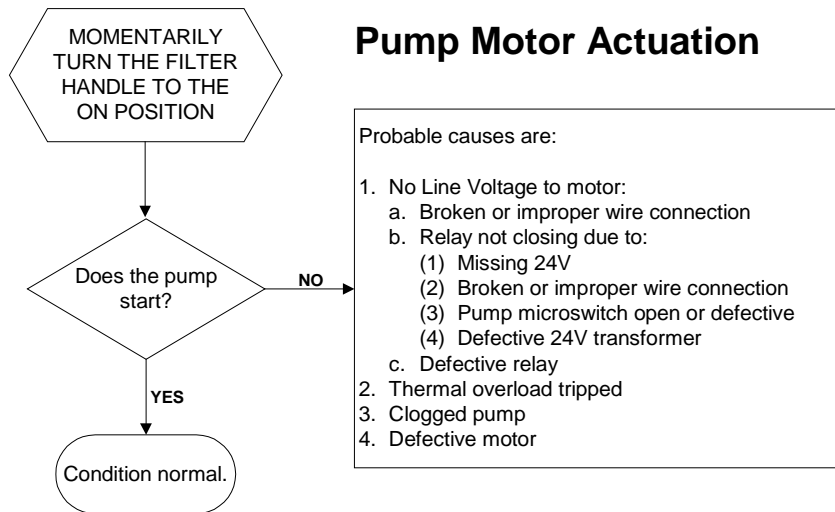

### Filter System Operation

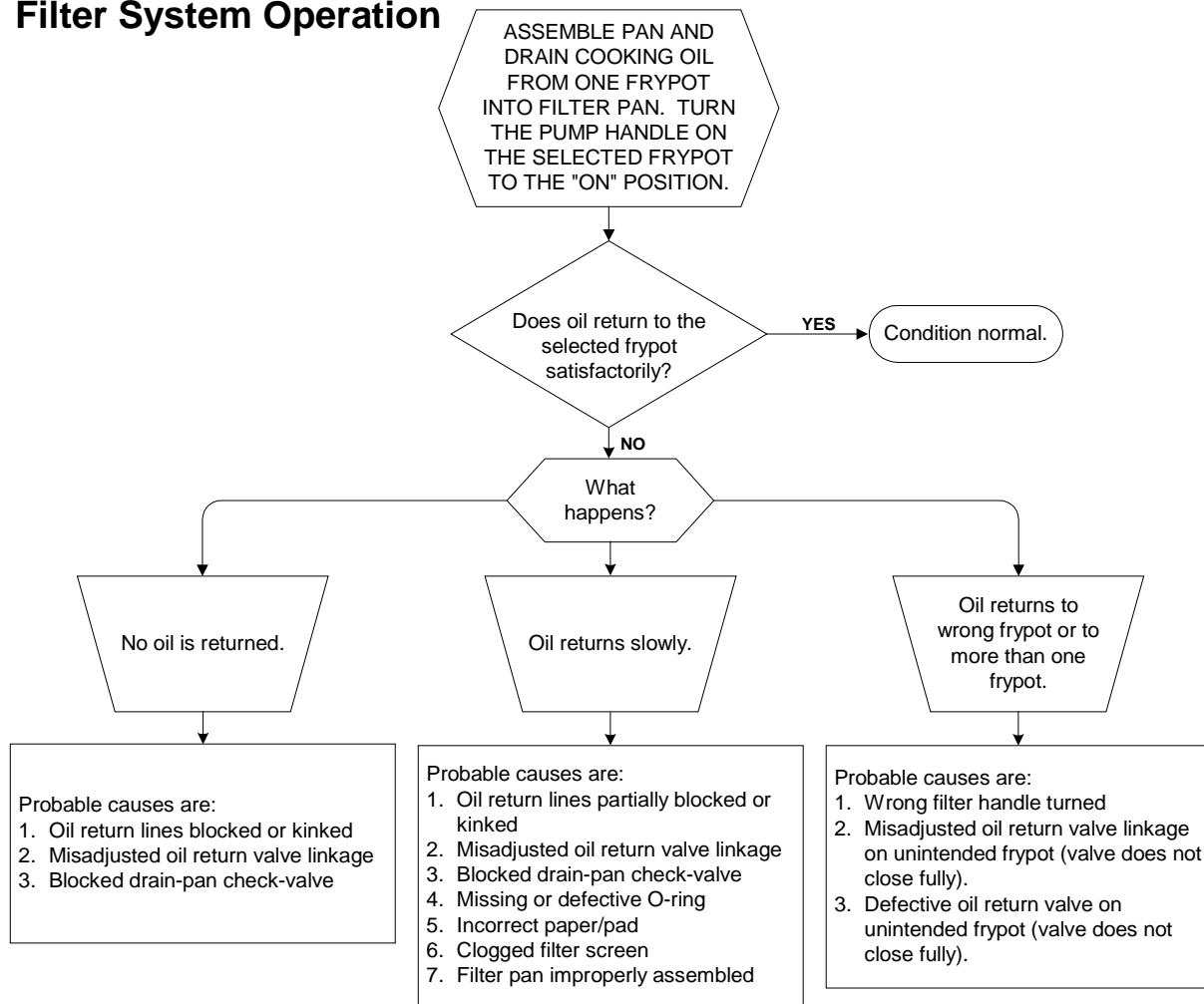

## CHAPTER 7: SERVICE PROCEDURES

Before performing any maintenance on your Frymaster fryer, you must disconnect the electrical power supply.

When electrical wires are disconnected, it is recommended that they be marked in such a way to facilitate re-assembly.

### 7-1: REPLACE CONTROLLER

1. Unscrew and remove two control panel screws.



2. Control panel is hinged at the bottom and will swing open from the top.



3. Unplug wiring harness at plug on back of controller.
4. Control panel including controller can be removed by lifting the assembly from the hinged slots in the control panel frame.
5. Reverse procedures to install new controller.



## 7-2: REPLACE INTERFACE BOARD

1. Unplug all power cords. Perform Procedure 7-1, Steps 1-4, Replace Computer/Controller.

2. Unplug wire harness from the interface board. Remove all wiring from the terminals of the interface board, ensuring that each wire is marked for reattachment.



Wire Harness/Connector

3. Remove the screws securing the control panel frame. Set the control panel frame/screws aside.



Screws securing control panel frame

4. Remove the screws securing the top cap. Set the top cap/screws aside.

5. Remove the screws securing the component box. Set the component box drop down enough so that the wire harness can be unplugged from the back of the assembly.

6. Remove the nuts from each corner of the interface board and slide the board from the studs. Install the new interface board by reversing the previous procedures. Ensure that wire harnesses are connected to back of interface board prior to securing component box. Also ensure that wiring and wire harnesses are connected to the proper terminals.

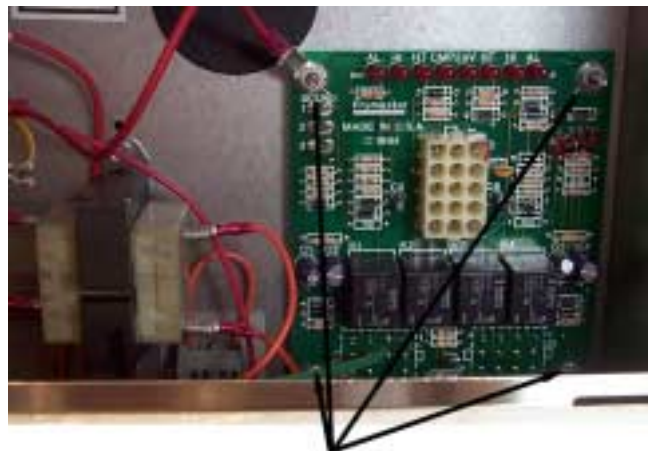

Nuts securing interface board

### 7-3: REPLACE TRANSFORMER

1. Unplug all power cords. Perform Procedure 7-1, Steps 1-4, Replace Computer/Controller.
2. Remove all wiring from the terminals of the transformer to be replaced.
3. Remove the screws that secure the transformer to the component box.
4. Install the new transformer by reversing the preceding procedures. Make sure you reconnect the wiring to the proper terminals and the harnesses to the correct connectors.

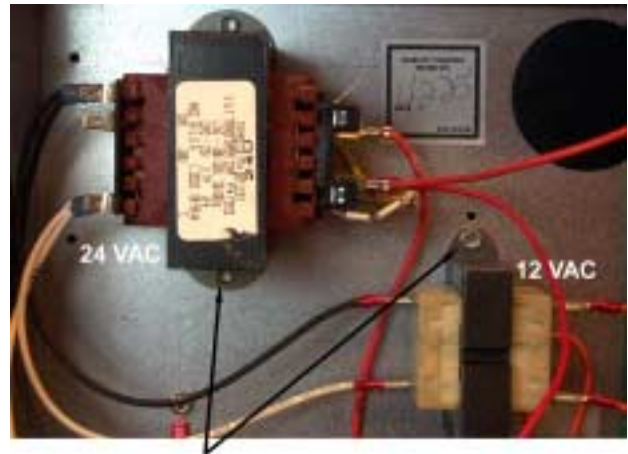

Screws securing transformers

### 7-4: REPLACE TEMPERATURE PROBE

1. Unplug fryer from the electrical source.
2. Drain the cooking oil from the frypot.
3. Remove the fryer from the exhaust hood to gain access to the rear of the fryer.
4. Remove the screws from the top, center and bottom back covers. Set the covers and screws aside.
5. Remove the screws securing the tilt housing cover. Set the tilt housing cover aside.



Screws securing back covers and tilt housing

## 7-4: REPLACE TEMPERATURE PROBE (cont.)

6. Disconnect the wire harness containing the probe wiring. It may be necessary to remove the wire ties.
7. Use a pin-pusher to remove the probe wires from the connector. Mark each wire for re-assembly.

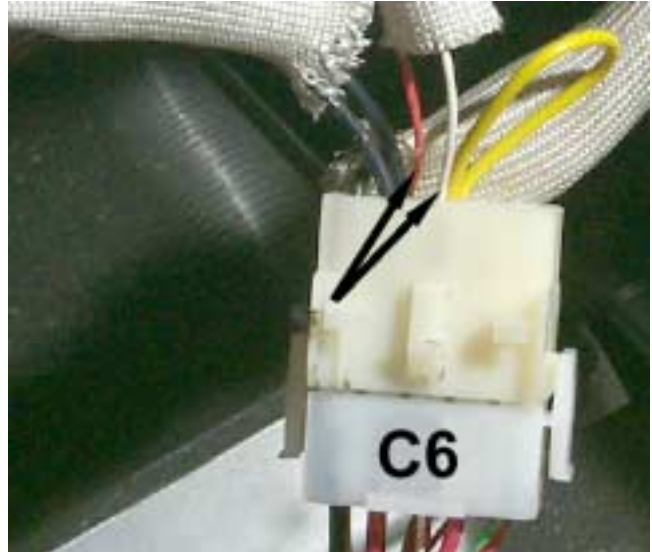

Use a pin-pusher to remove probe wires from connector

8. Remove the screw(s) securing the probe bracket to the element.



9. Thread the probe wire through the hole in the tilt plate assembly and remove the probe and the securing components from the element.
10. Remove the probe from the probe bracket. Place the new probe into the bracket.



Thread probe wire through hole in tilt plate assembly, then remove probe and components from element.

## 7-4: REPLACE TEMPERATURE PROBE (cont.)

11. Place the new temperature probe assembly onto the element and secure with the screws removed earlier. Clip the probe onto the rear of the element. The temperature probe assembly should be oriented in the same manner as the probe being replaced.
12. Thread the probe wires into the harness connector as removed in Step 7.
13. Lower the element into the frypot.



Secure probe to element with metal Ty-Wrap

New probe assembly properly installed in tilt plate

14. Place the tilt housing cover over the tilt housing assembly and secure with screws
15. Install the top, center and bottom back covers and secure with screws.



Tilt housing cover in place

## 7-5: REPLACE HEATING ELEMENT

1. Perform Procedure 7-4, Replace Temperature Probe, Steps 1-7.
2. Remove the element wires from the connector. Press down on either side of the connector while pulling up on the top portion. The connector will open from the top. Pull all wires from the connector.

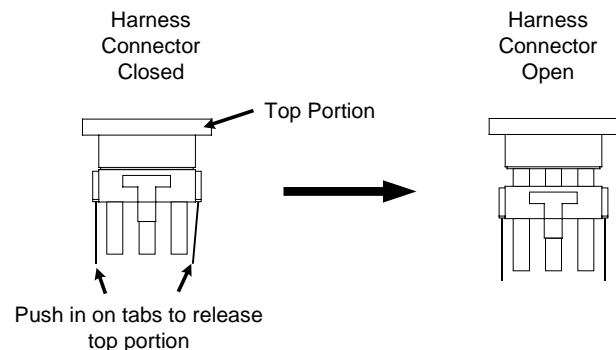

## 7-5: REPLACE HEATING ELEMENT (cont.)

3. Remove the screws securing the temperature probe bracket from the element. Remove the probe clamp (metal Ty-Wrap). Set the temperature probe and probe-securing components aside.

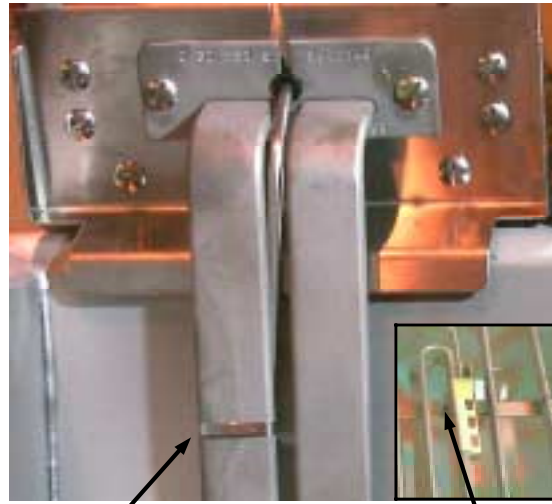

Remove probe clamp (metal Ty-Wrap), and screws securing probe bracket to element

4. Disconnect the element springs.



Disconnect element springs here

## 7-5: REPLACE HEATING ELEMENT (cont.)

5. Remove the element mounting screws and pull the element out of the frypot.
6. Install the temperature probe and probe-securing components onto the replacement element.
7. Install the replacement element in the frypot and secure with the mounting screws removed in Step 5.

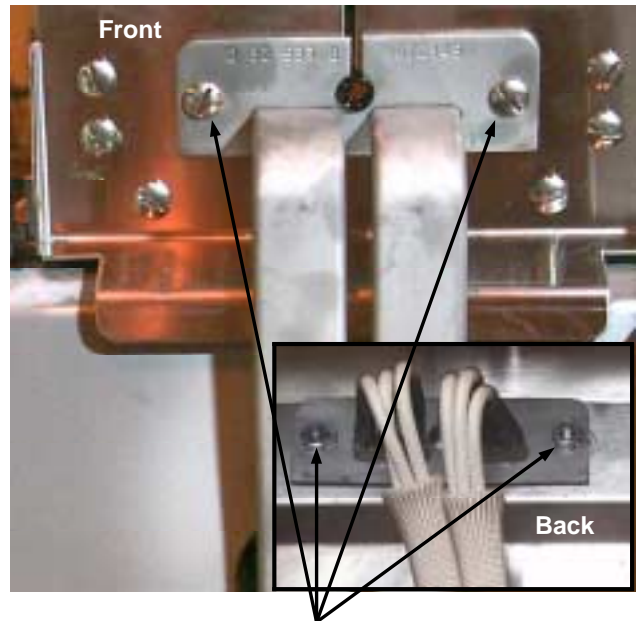

Element-mounting screws and nuts  
(Inset Photo- back of tilt plate)

8. Route the element leads (terminals) to the rear of the fryer.
9. When replacing the right element (as viewed from the rear of the fryer), insert pin terminals into the corresponding pin-holes in the 6-pin connector. When all pin terminals have been fully inserted, close the connector by sliding the halves together until the tabs snap back into place (reverse procedure in Step 2).



Proper element-wire routing is essential to prevent wire chafing while raising and lowering elements.

## 7-5: REPLACE HEATING ELEMENT (cont.)

10. When replacing the left element (as viewed from the rear of the fryer), use the 9-pin connector, inserting the leads from the replacement element and closing the connector, see previous step.
11. Insert the connector(s) into the receptacle(s) on the rear of the contactor box, ensuring that the latches lock the connectors in place (see Step 9).
12. Install the temperature probe wires (marked for re-assembly) in the corresponding pin locations.
13. Reconnect the element spring.
14. Place the tilt housing cover over the tilt housing assembly and secure with screws.
15. Install covers and secure with screws.
16. Position fryer under exhaust hood.

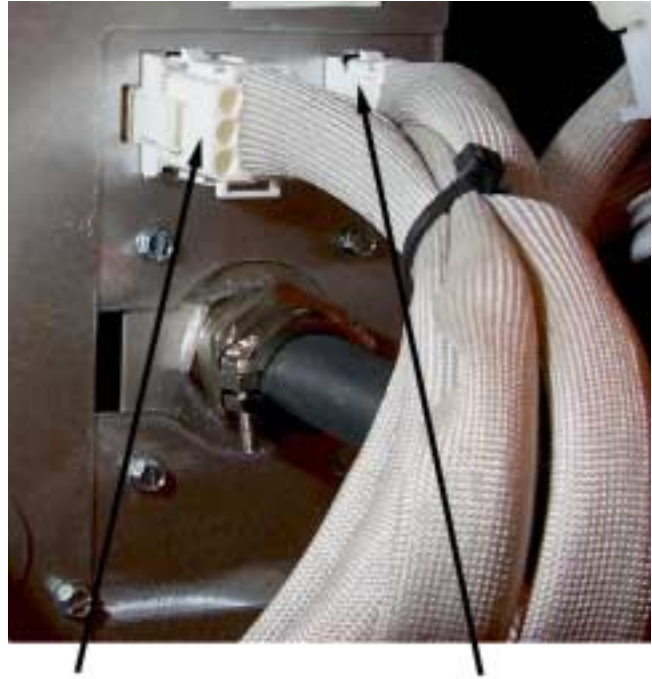

Left element— 9-pin connector

Right element— 6-pin connector

## 7-6: REPLACE HIGH-LIMIT

1. Perform Procedure 7-4, Replace Temperature Probe, Steps 1-4.
2. Disconnect the wire harness containing the high-limit wires.
3. Use a pin-pusher to remove the two high-limit wires from the wire harness connector. For split-pot fryers, remove only the wires for the high-limit to be replaced. Mark each wire for re-assembly.
4. Remove the high-limit from the frypot using an open-end wrench or other suitable tool.
5. Apply Loc-Tite PST 567 sealant to the replacement high-limit threads.
6. Screw the replacement high-limit into the frypot and tighten securely. **DO NOT OVERTIGHTEN.**
7. Insert the replacement high-limit wires into the proper pin-holes in the connector. The same two pin-holes from which the defective high-limit wires were removed.
8. Reconnect the wire harness connector.
9. Install and secure the back covers.
10. Position the fryer under the exhaust hood.

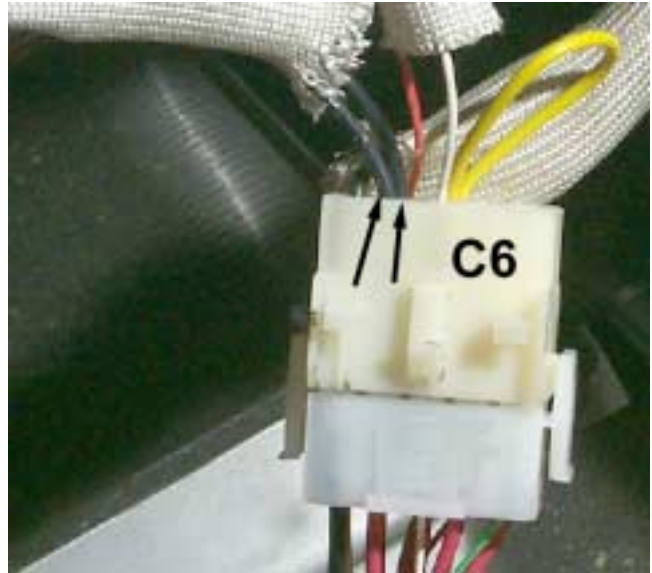

Use a pin-pusher to remove high-limit wires from connector

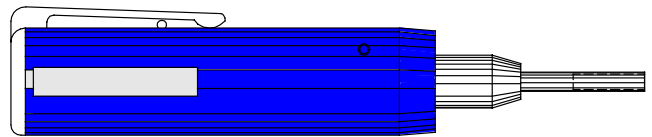

Pin Pusher— P/N 807-0928



Place tool here when removing and installing high-limit

## **7-7: REPLACE FRYPOT**

1. Perform Procedure 7-4, Replace Temperature Probe, Steps 1-7.
2. Perform Procedure 7-1, Replace Computer/Controller, Steps 1-6.
3. Disconnect the wire harness containing the high-limit wires.
4. Use a pin-pusher to remove the high-limit wires from the wire harness connector.
5. Remove the high-limit from the frypot.
6. Disconnect the wire-harnesses connected to the contactor box.
7. Remove the screws securing the capping piece from the fryer. Remove the capping piece and set aside. It may be necessary to remove the wiring covers from the front of the contactor box.
8. If the fryer has a built-in filtration system, remove all the plumbing from the frypot, including rear-flush and square-drain plumbing.
9. Remove the screws securing the frypot to the front frame of the fryer.
10. Carefully lift the frypot from the cabinet.
11. Remove the drain valve from the old frypot and install on the new frypot.
12. Apply Loc-Tite Sealant PST 567 to the high-limit threads. Install the high-limit into the new frypot.
13. Disconnect the tilt plate springs from the old frypot.
14. Remove the securing screws from the tilt plate. Lift the tilt plate/heating element assembly from the old frypot and install on the new frypot.
15. Follow the preceding steps in reverse to install the new frypot into the fryer.
16. NOTE: Apply Loc-Tite Sealant PST 567 to all pipefittings prior to installation.

## 7-8: REPLACE CONTACTOR

1. Perform Procedure 7-4, Replace Temperature Probe, Steps 1-3.
2. Remove the screws securing the bottom and center rear access covers. Set the screws and covers aside.
3. If present, remove the screws securing the wiring covers to the front of the contactor box (**optional on old-style contactor boxes**). Set the screws and covers aside.
4. Disconnect the wire harnesses from the front and rear of the contactor box.



Screws securing wire cover to contactor box (optional on old-style contactor boxes)

5. Remove the screws securing the contactor box to the bottom frame of the fryer.
6. Pull the contactor box through the access opening in the rear of the fryer.
7. Remove the screws securing the contactor box cover. Set the screws and covers aside.



Location of screws securing contactor box to bottom frame

8. Remove all wiring connected to the contactor terminals inside the contactor box. Mark each wire for re-assembly.



Mark each wire for re-assembly, then remove all wiring connected to the contactor(s) to be replaced.

9. Remove the contactor mounting screws and remove the contactor.



Contactor mounting screws

10. Install the new contactor and connect the wiring removed in Step 8.
11. Install the contactor box by following the previous steps in reverse order.



Latching Contactor

Mercury (Heating)  
Contactor

## 7-10: BUILT-IN FILTER SYSTEM SERVICE PROCEDURES

### Filtration Problem Resolution

One of the most common errors is placing the filter paper on the bottom of the filter pan rather than over the filter screen.

**⚠ CAUTION**  
**ENSURE THAT FILTER SCREEN IS IN PLACE PRIOR TO FILTER PAPER PLACEMENT AND FILTER PUMP OPERATION. IMPROPER SCREEN PLACEMENT IS THE MAJOR CAUSE OF FILTER SYSTEM MALFUNCTION**

Whenever the complaint is “the pump is running, but no oil is being filtered,” check the installation of the filter paper, and ensure that the correct size is being used. While you are checking the filter paper, verify that the O-ring on the bottom of the filter pan is present and in good condition. A missing or worn o-ring allows the pump to take in air and decreases its efficiency.

If the pump motor overheats, the thermal overload will trip and the motor will not start until it is reset. If the pump motor does not start, press the red reset switch (button) located on the rear of the motor.



If the pump starts after resetting the thermal overload switch, then something is causing the motor to overheat. A major cause of overheating is when several frypots are filtered sequentially at one time, thus overheating the pump and motor. Allow the pump motor to cool at least 30 minutes before resuming operation.

Pump overheating can be caused by:

- Solidified shortening in the pan or filter lines,

Or

- Attempting to filter unheated oil or shortening.

Cold oil and shortening are more viscous, causing the pump motor to loadup and overheat.

## 7-10: BUILT-IN FILTER SYSTEM SERVICE PROCEDURES (cont.)

If the motor runs but the pump does not, there is a blockage in the pump. Incorrectly sized or installed paper/pads will allow food particles and sediment to pass through the filter pan and into the pump. When sediment enters the pump, the gears bind, causing the motor to overload, again tripping the thermal overload. Solidified shortening in the pump will also cause it to seize, with the same result.

A pump seized by debris or hard shortening can usually be freed by manually moving the gears with a screwdriver or other instrument.

Disconnect power to the filter system.

Remove the input plumbing from the pump.

Use a screwdriver to manually turn the gears, in which:

- Turning the pump gears in reverse will release a hard particle.
- Turning the pump gears forward will push softer objects and solid shortening through the pump and allow free movement of the gears.

Incorrectly sized or installed paper/pads will also allow food particles and sediment to pass through and clog the suction tube on the bottom of the filter carriage. Particles large enough to block the suction tube may indicate that the crumb tray is not being used.

Pan blockage can also occur if shortening is left in the pan and allowed to solidify. The heater strip on the suction tube is designed to prevent residual shortening from solidifying in the tube. Heater strips do not prevent residual shortening from solidifying in the pan.

Blockage removal can be accomplished by forcing the item out with an auger or drain snake. Compressed air or other pressurized gases should not be used to force out the blockage.

For FootPrint III systems built before October, 1999, all heater tapes are wired directly into the line VAC source (see wiring diagram, page 7-14). They remain energized as long as the unit is plugged in. In systems built in October, 1999 and later, oil return line heater tapes have been eliminated. In these units, the only heater tape used is on the suction tube and pump. This tape is still wired directly into the line voltage. A pair of vacuum-breaking solenoids is wired into the 24 VAC circuit.

*The redesigned FPIII is distinguished from original-design units by the absence of casters on the filter base assembly. The redesign incorporated an improved oil return system that allows oil/shortening to drain back to the filter pan when the filter system is turned off, eliminating the need for most heated oil return components.*

### FREEING A SEIZED PUMP

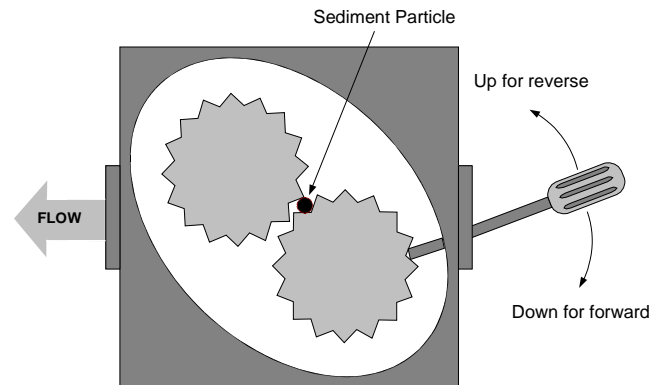

## 7-10: BUILT-IN FILTER SYSTEM SERVICE PROCEDURES (cont.)

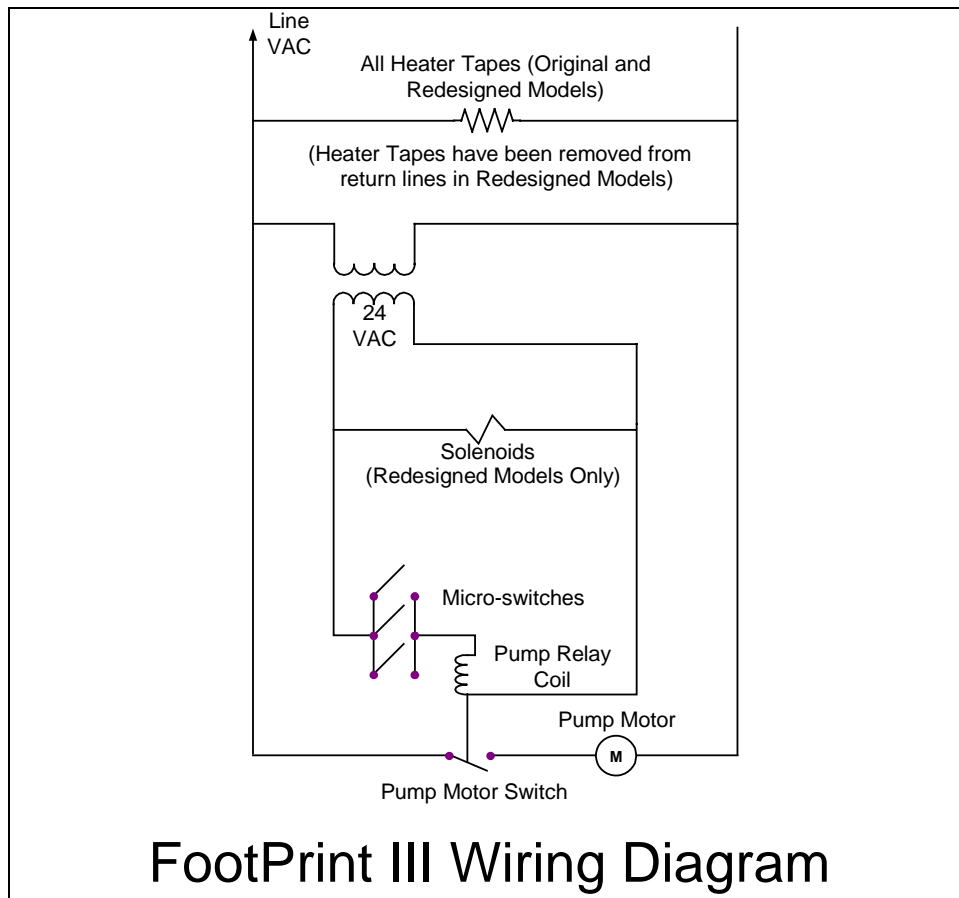

Operation of the redesigned FP-III system is the same as for the original design.

<b>ORIGINAL VS REDESIGNED FP-III FILTRATION SYSTEM</b>	
<b>Original System</b>	<b>Redesigned System</b>
Return lines and manifolds wrapped with silicone strip heaters and aluminum tape.	No heater strips or aluminum tape on return lines.
Filter base assembly connected to unit with a black, heated return hose beneath the filter.	Non-heated Teflon hose with a swivel joint connects the filter base assembly to the unit above the filter.
Filter base assembly equipped with swivel casters.	Filter base assembly has no casters.
Operator-removable filter base assembly. (Filter base assembly stoplocks in cabinet can be rotated to remove tray.)	Filter base assembly is not removable except by a qualified service technician. (Filter base assembly stoplocks fitted with a screw and nut to prevent filter removal.)
Oil/shortening remains in return lines when filter system is turned off.	Oil/shortening gravity-drains back to the filter pan when filter system is turned off, leaving no oil or shortening in return lines.
Return drain-manifolds are constructed with pipe nipples, elbows and other plumbing components.	Return drain manifolds are one-piece with an in-line solenoid valve to facilitate gravity drain-back to filter pan.

## 7-11: ELECTRIC INTERFACE BOARD DIAGNOSTIC CHART

The following diagram and charts provide ten quick system checks that can be performed using only a multimeter.

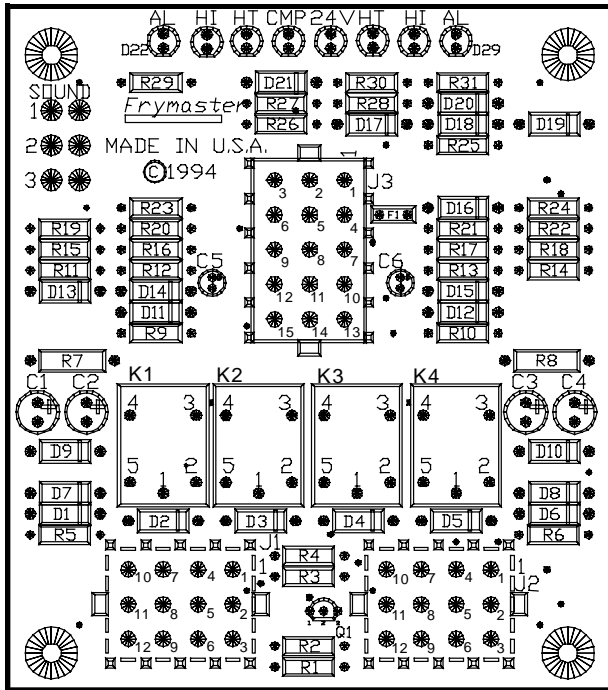

**Note:** The sealed relays are not replaceable. If a relay fails the interface board must be replaced.

Diagnostic LED Legend

CMP indicates power from 12V transformer  
 24 indicates power from 24V transformer  
 HI (RH) indicates output (closed) from right Latch relay  
 HI (LH) indicates output (closed) from left Latch relay  
 HT (RH) indicates output from right Heat relay  
 HT (LH) indicates output from left Heat relay  
 AL (RH) indicates output (open) from right Latch relay  
 AL (LH) indicates output (open) from left Latch relay

Meter Setting	Test	Pin	Pin	Results
12 VAC Power	50 VAC Scale	1 of J2	3 of J2	12-16 VAC
24 VAC Power	50 VAC Scale	2 of J2	Chassis	24-30 VAC
*Probe Resistance (RH)	R X 1000 OHMS	11 of J2	12 of J2	See Chart
*Probe Resistance (LH)	R X 1000 OHMS	3 of J1	2 of J1	See Chart
Hi-Limit Continuity (RH)	R X 1 OHMS	7 of J2	4 of J2	0 - OHMS
Hi-Limit Continuity (LH)	R X 1 OHMS	4 of J1	7 of J1	0 - OHMS
Latch Contactor Coil (RH)	R X 1 OHMS	8 of J2	Chassis	3-10 OHMS
Latch Contactor Coil (LH)	R X 1 OHMS	5 of J1	Chassis	3-10 OHMS
Heat Contactor Coil (RH)	R X 1 OHMS	9 of J2	Chassis	18-25 OHMS
Heat Contactor Coil (LH)	R X 1 OHMS	6 of J1	Chassis	18-25 OHMS

**\*Disconnect 15-Pin harness from the computer/controller before testing the probe circuit.**

# COMMON ELECTRIC McDONALD'S H14 SERIES— FULL-VAT

7-12: WIRING DIAGRAMS, SIMPLIFIED

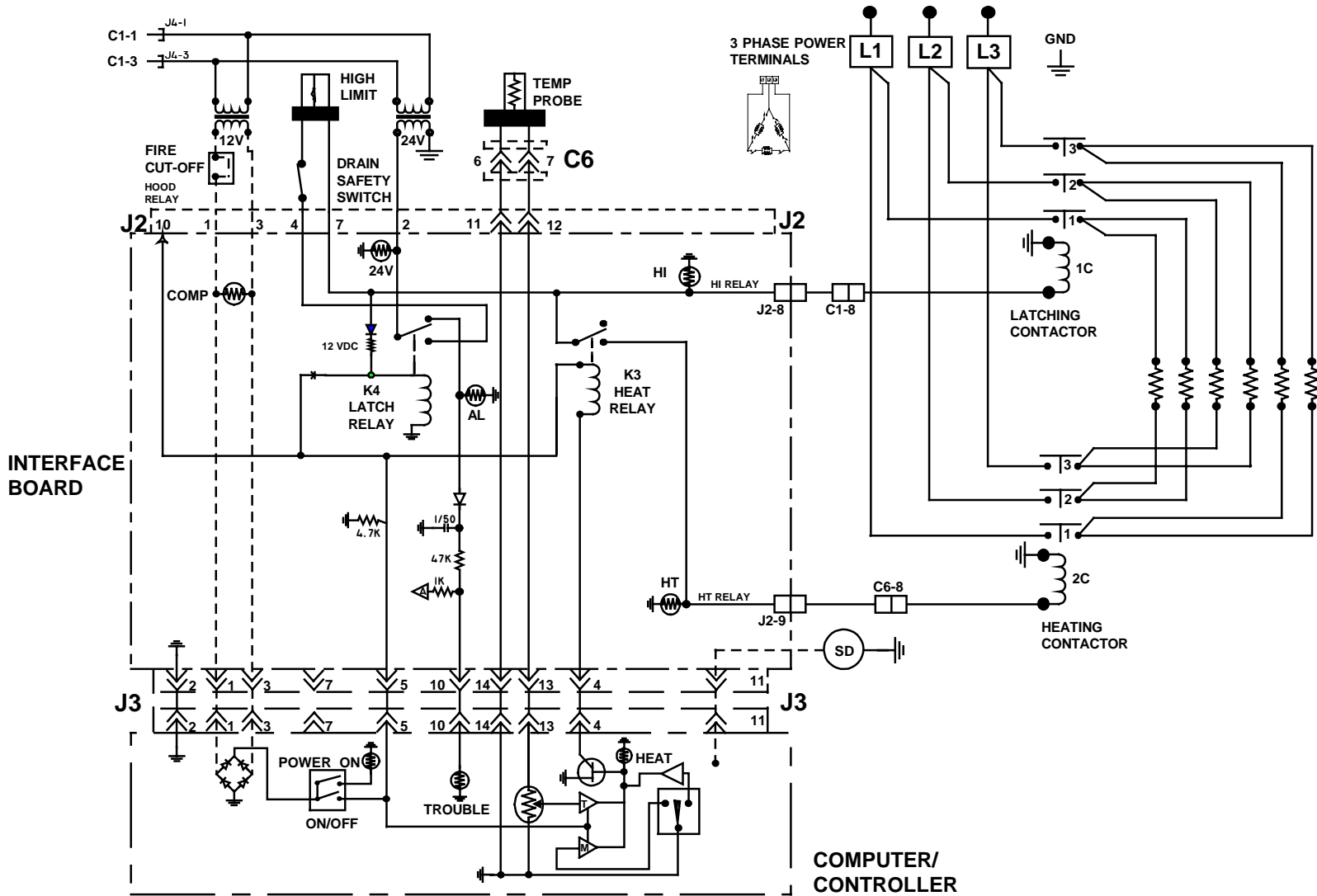

7-17

# COMMON ELECTRIC McDONALD'S H14 SERIES— DUAL-VAT

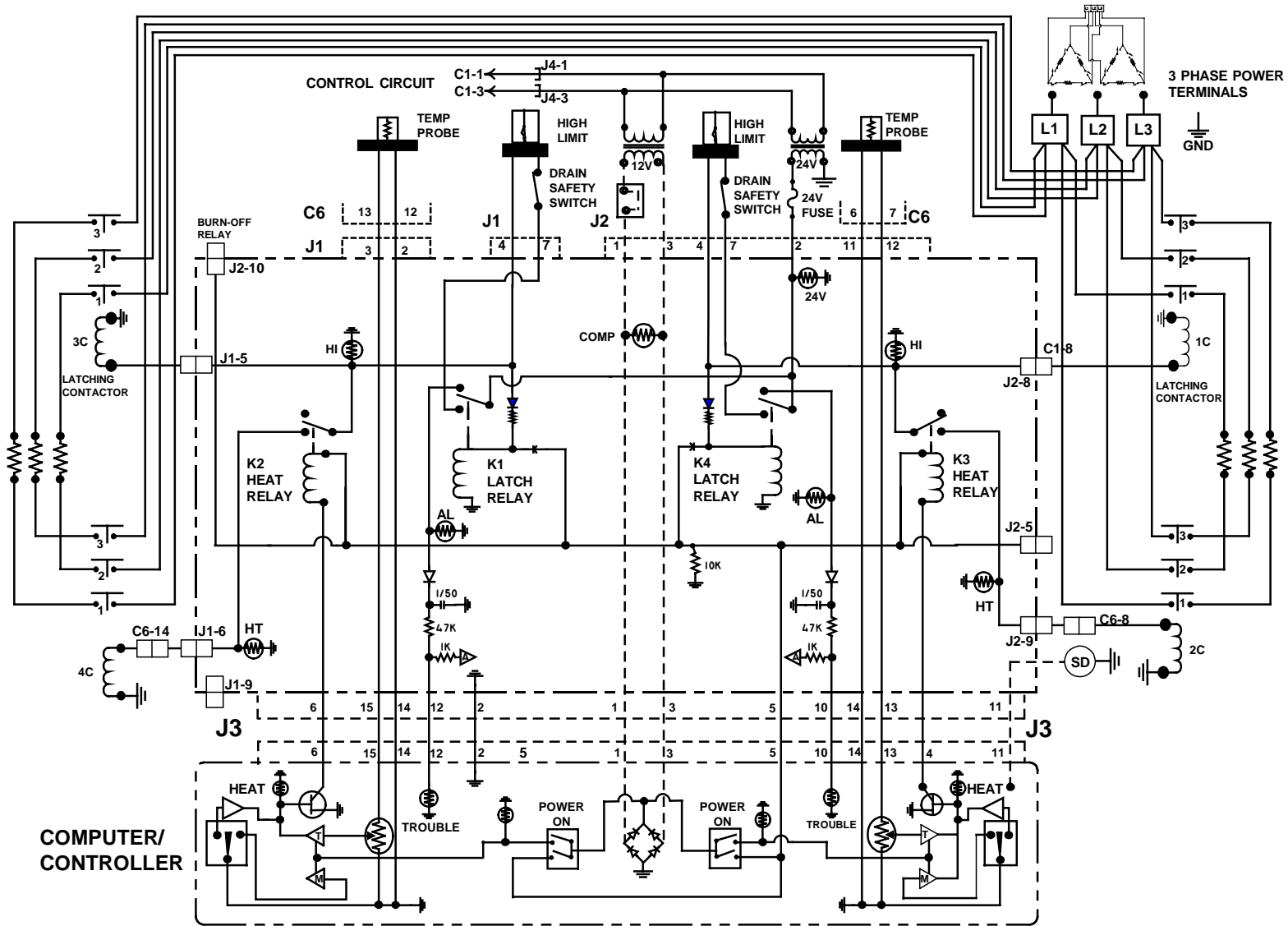

7-18

# COMMON ELECTRIC McDONALD'S H14 SERIES- FULL-VAT— EXPORT WYE

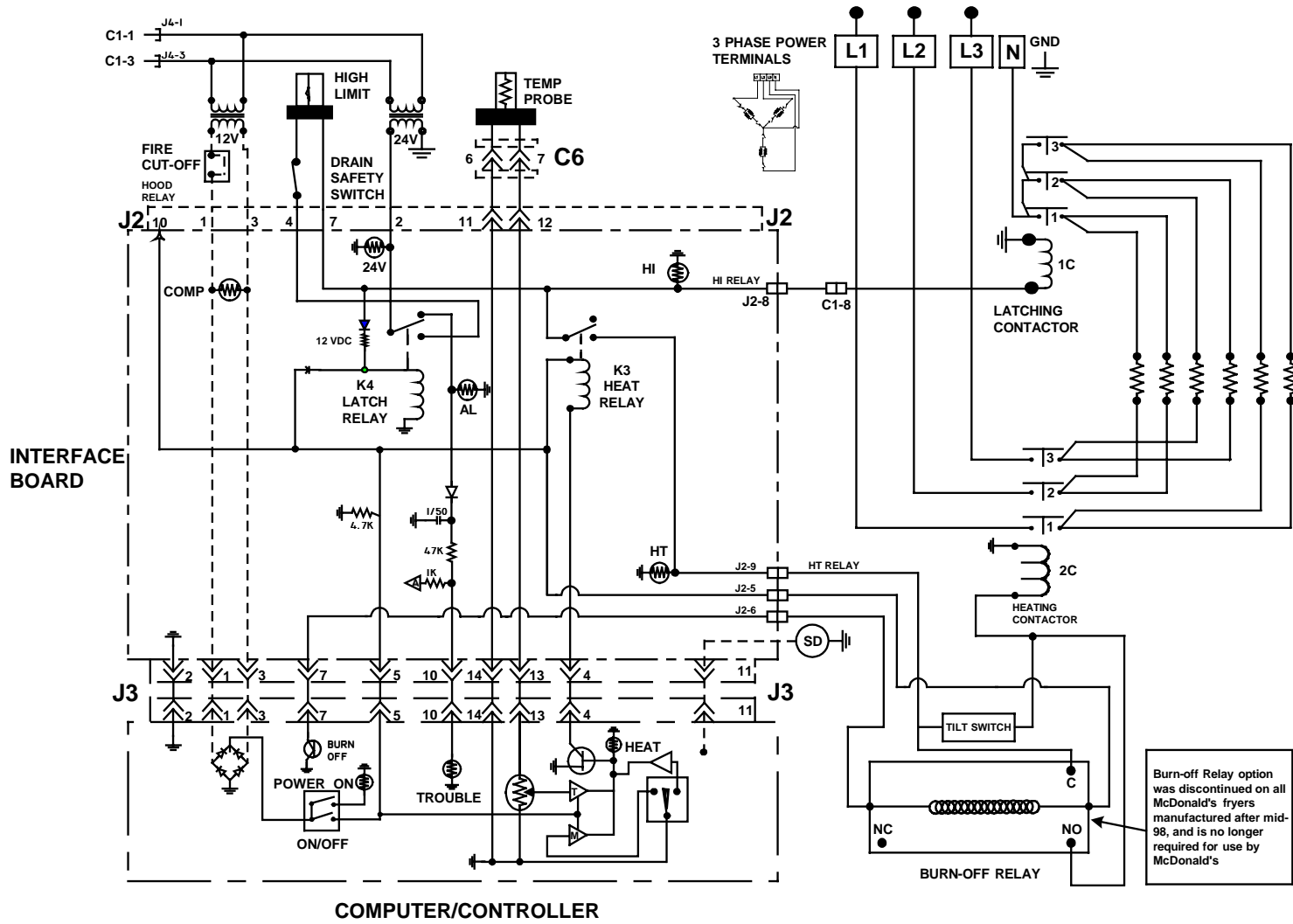

7-1-19

# COMMON ELECTRIC McDONALD'S H14 SERIES- DUAL-VAT— EXPORT WYE

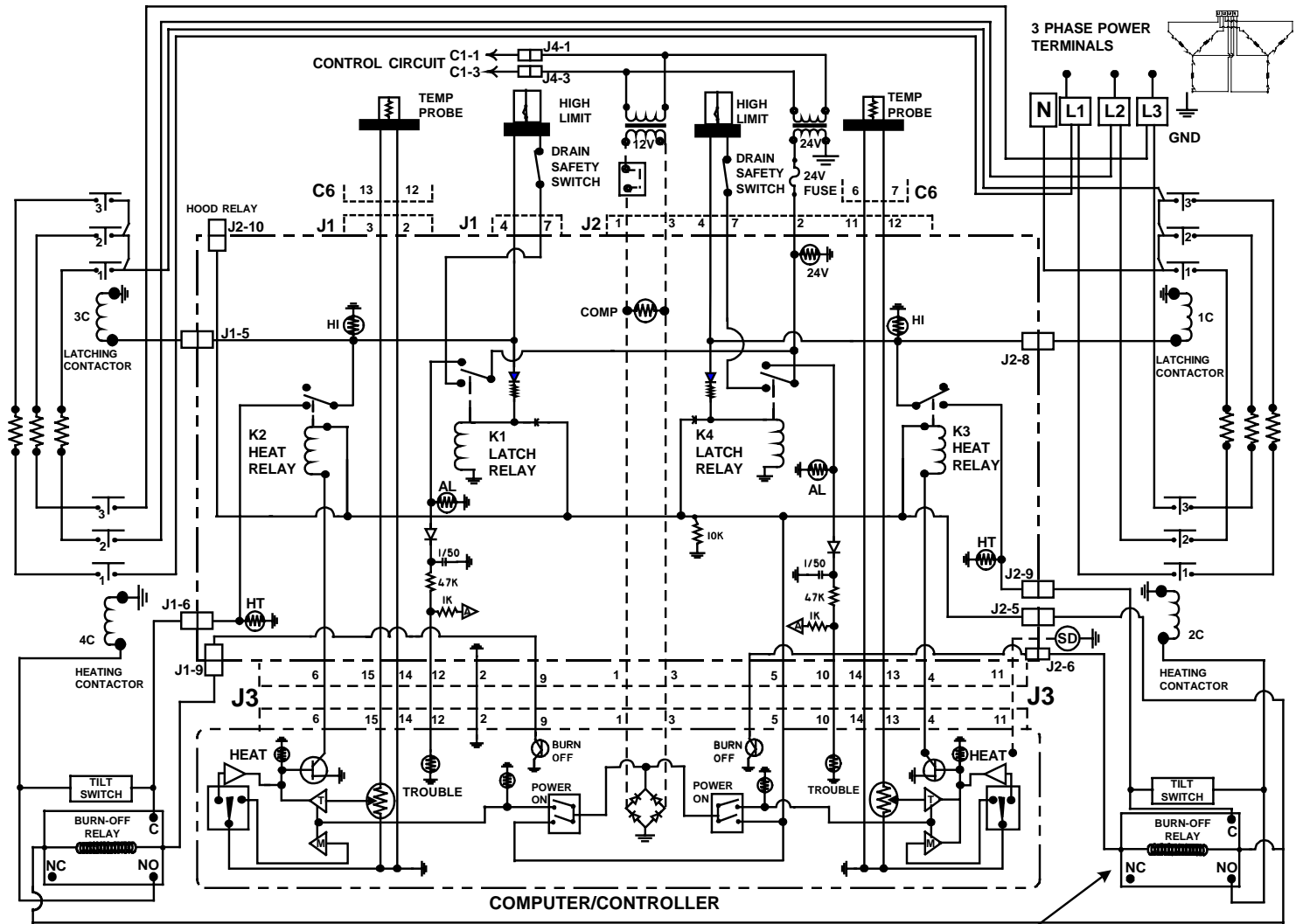

Burn-off Relay option was discontinued on all McDonald's fryers manufactured after mid-98, and is no longer required for use by McDonald's







# McDonald's European Community (CE) XBIH14

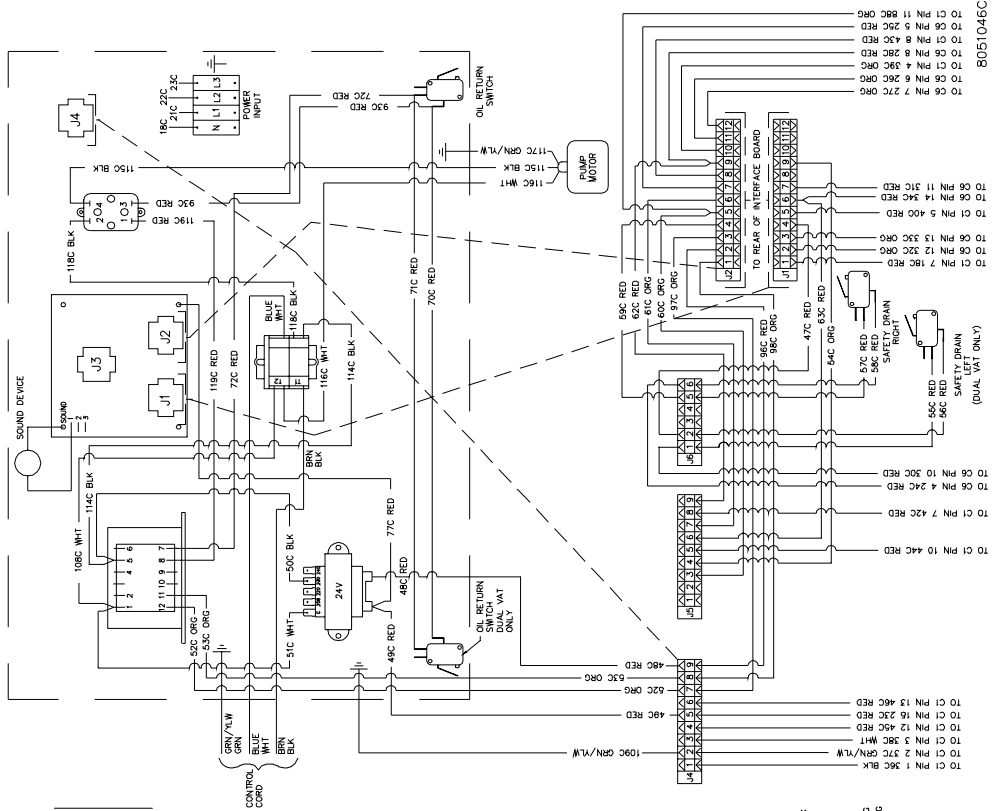

VOLTS  
208  
220  
230  
240

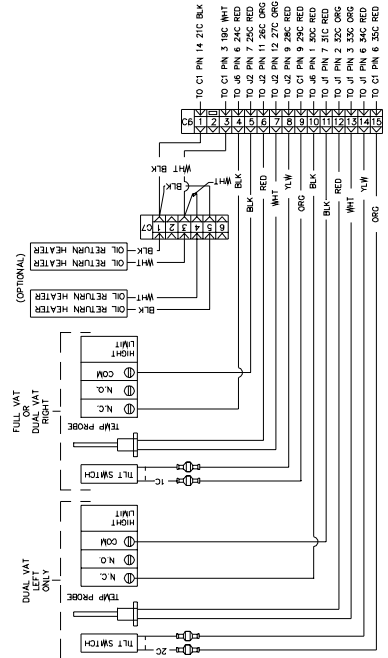
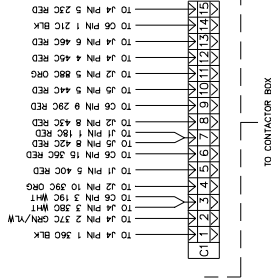
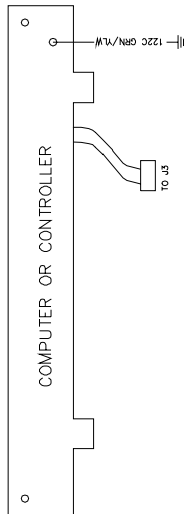

8051045C

# McDonald's Domestic Contactor

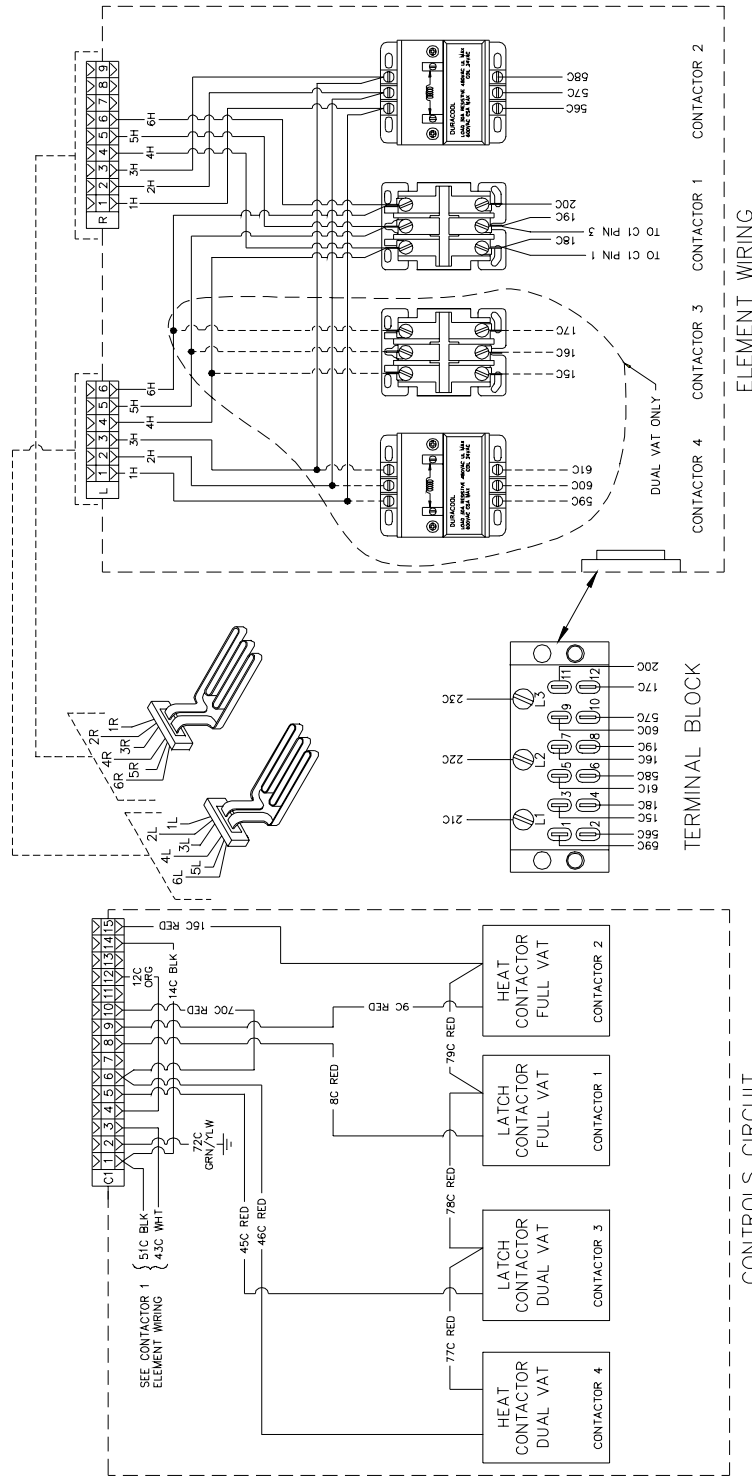

8051190A

# McDonald's European Community (CE) WYE Contactor

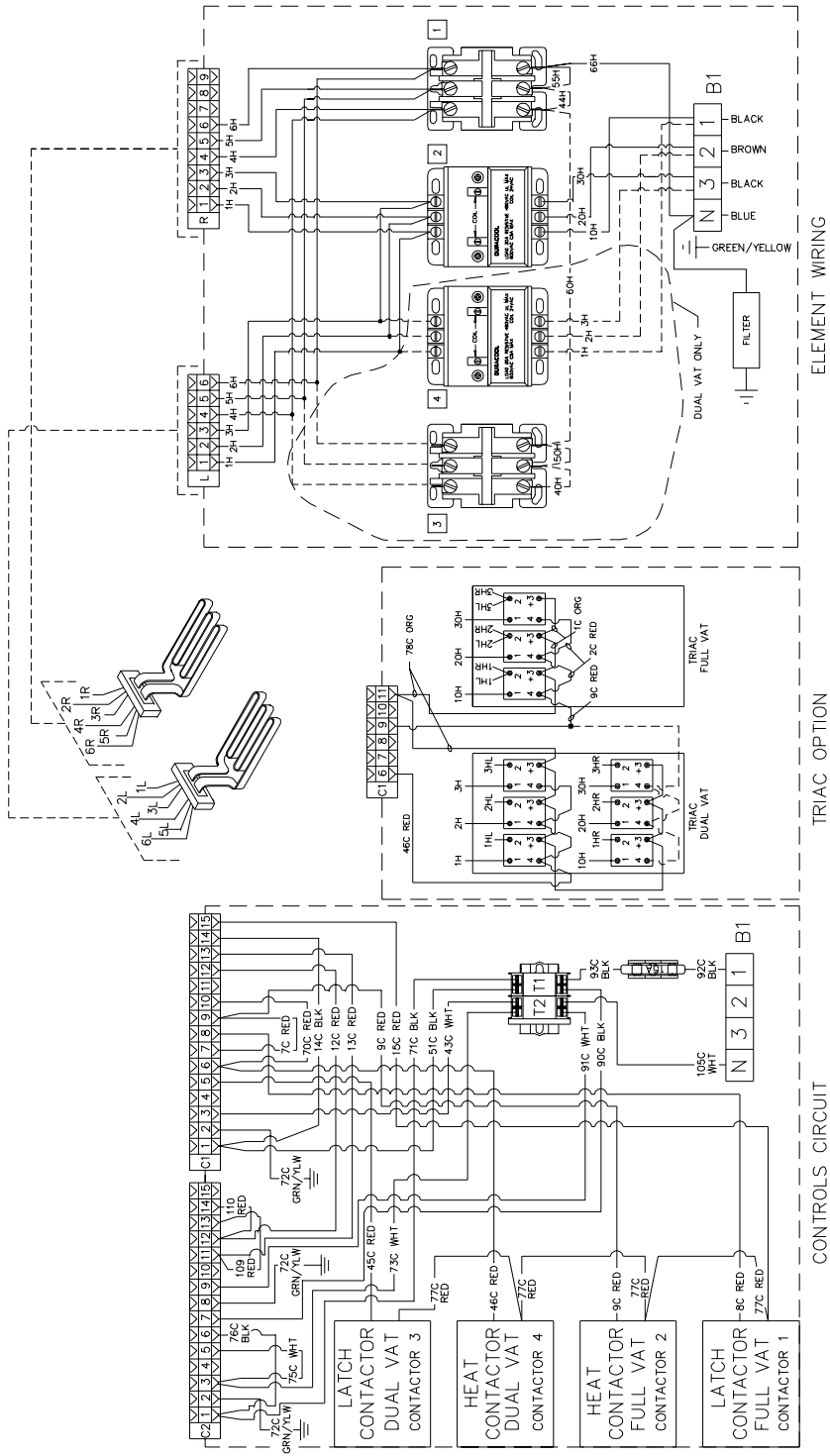

8050542C

# McDonald's European Community (CE) XBIH14 Contactor

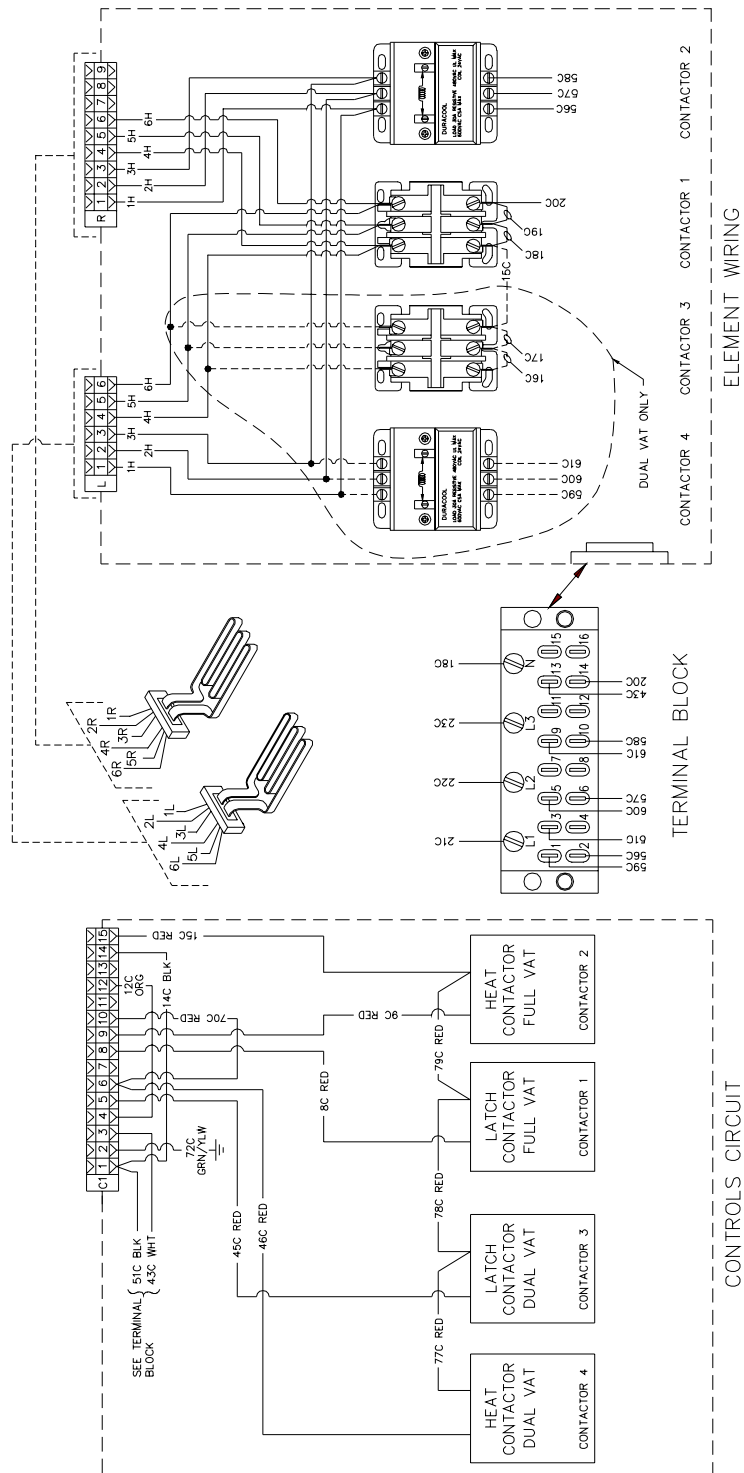

# McDonald's 440/480V Contactor

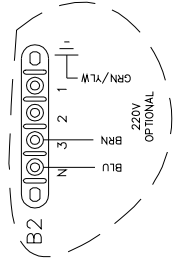
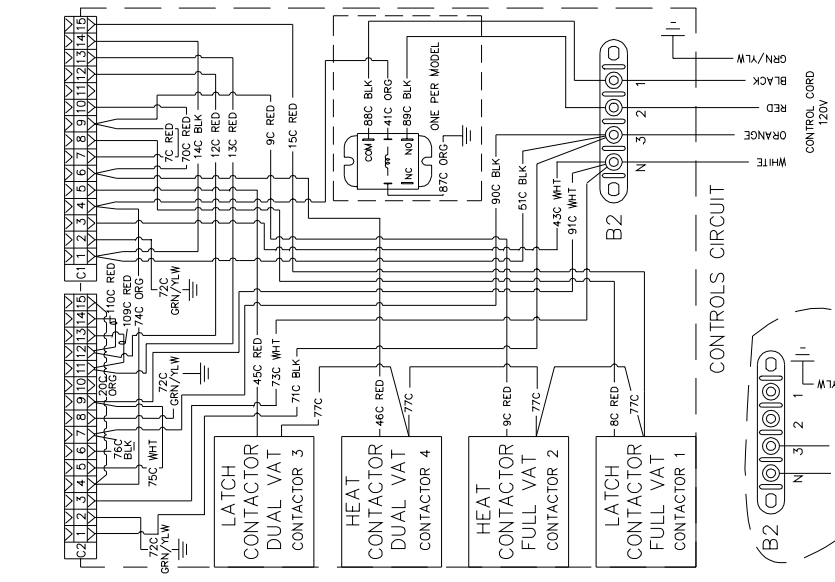
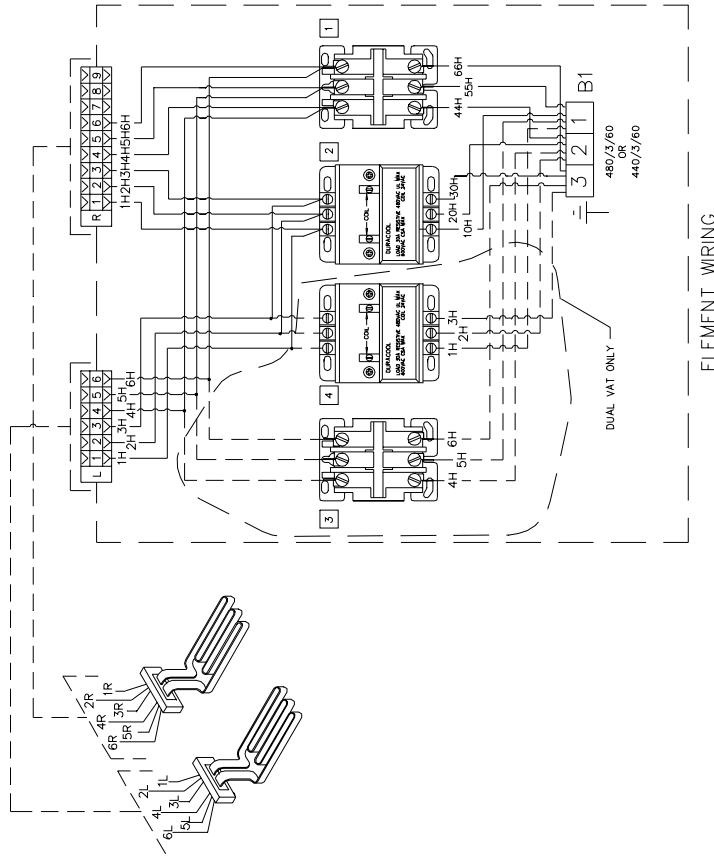

8050881B



# McDonald's Domestic Control Cord

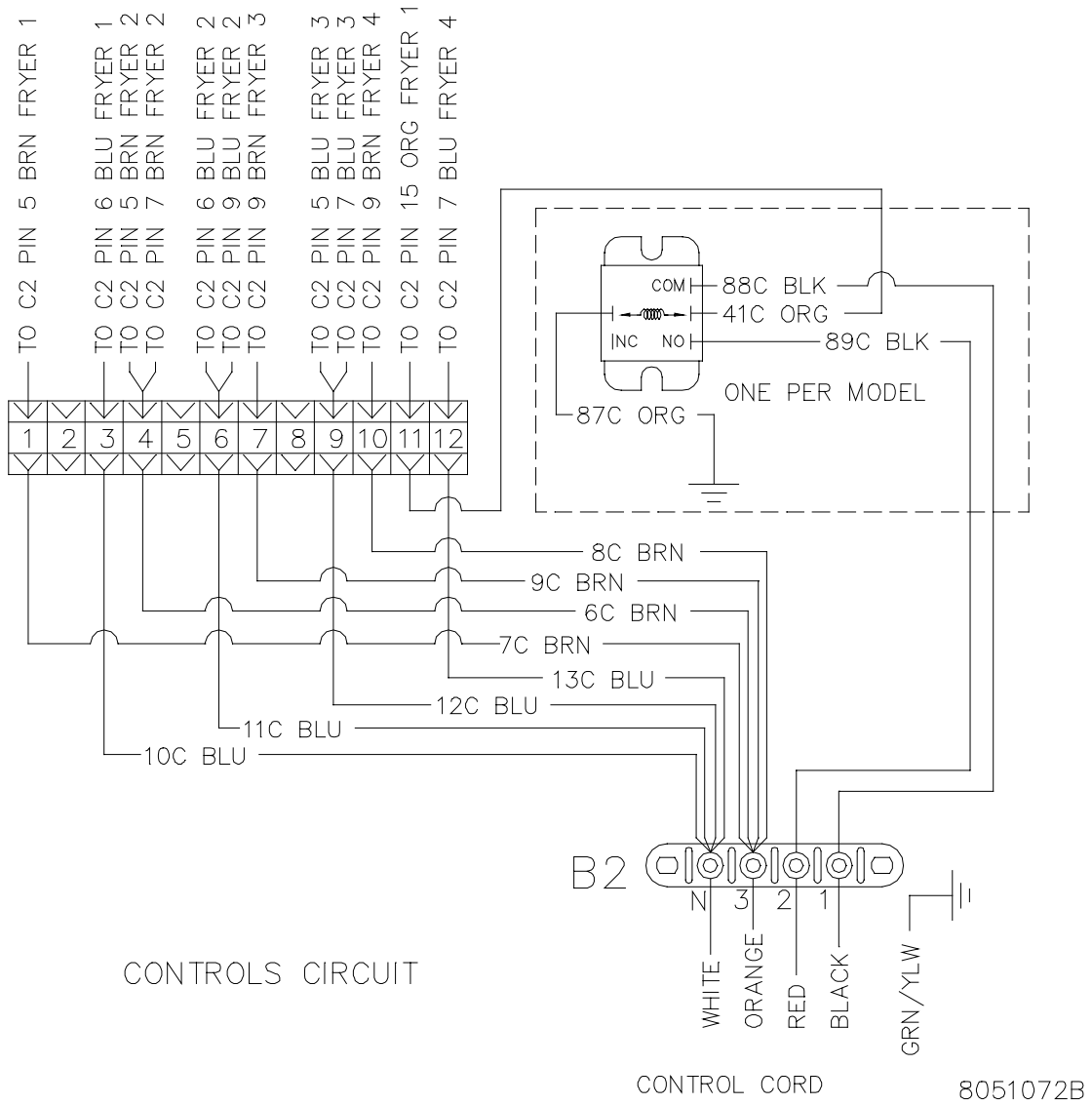

# McDonald's English Control Cord

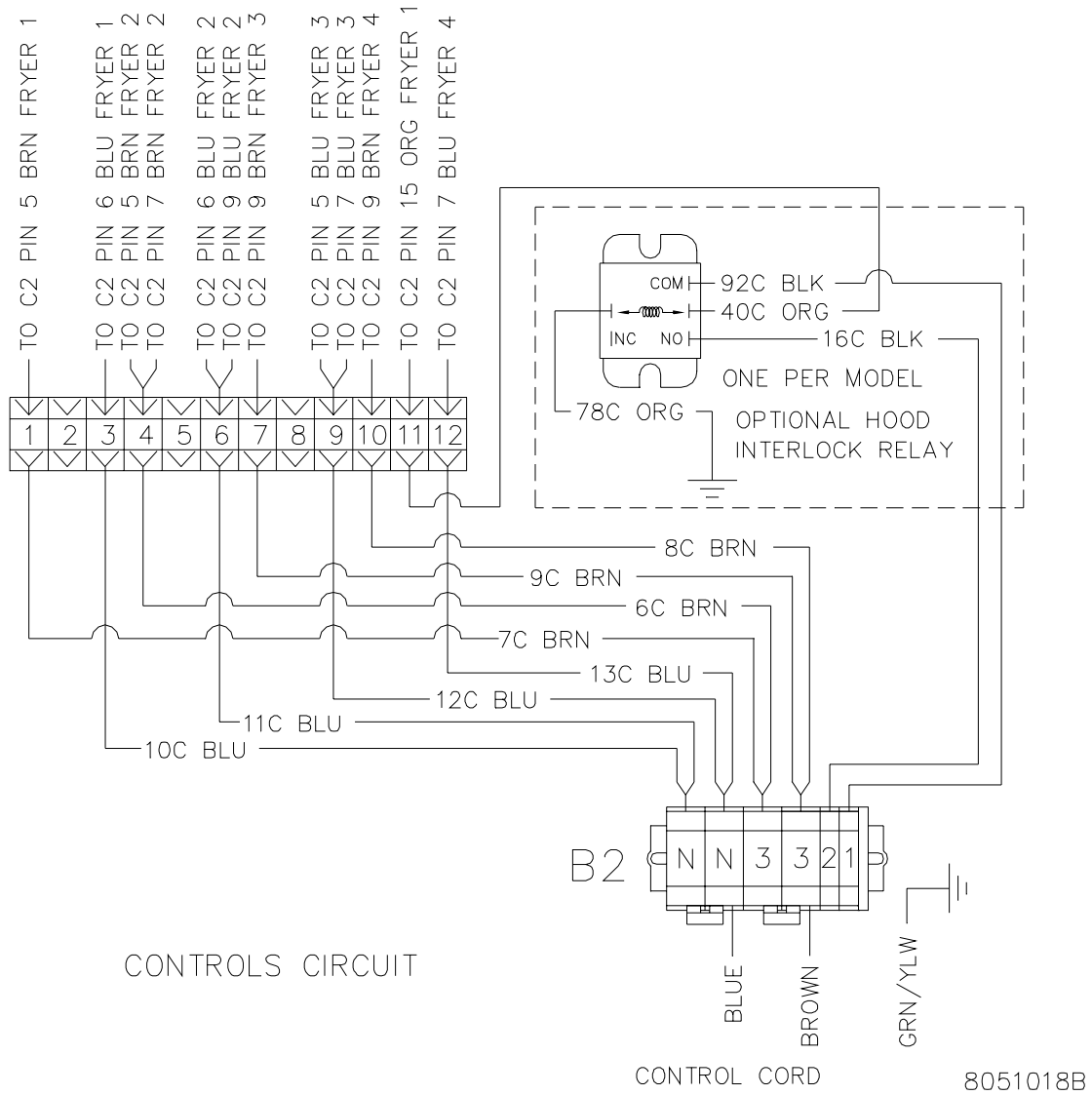

# 7-13: WIRING DIAGRAMS, FILTER UNITS

## Footprint III, Early Configuration.

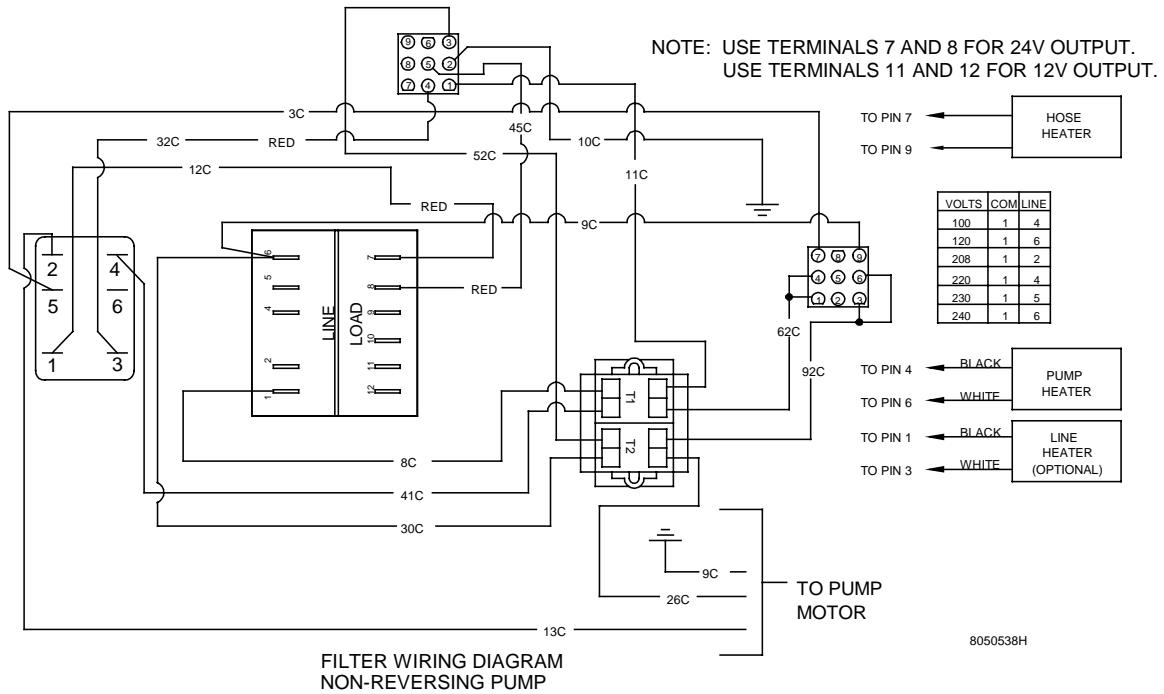

## Footprint III, Late Configuration

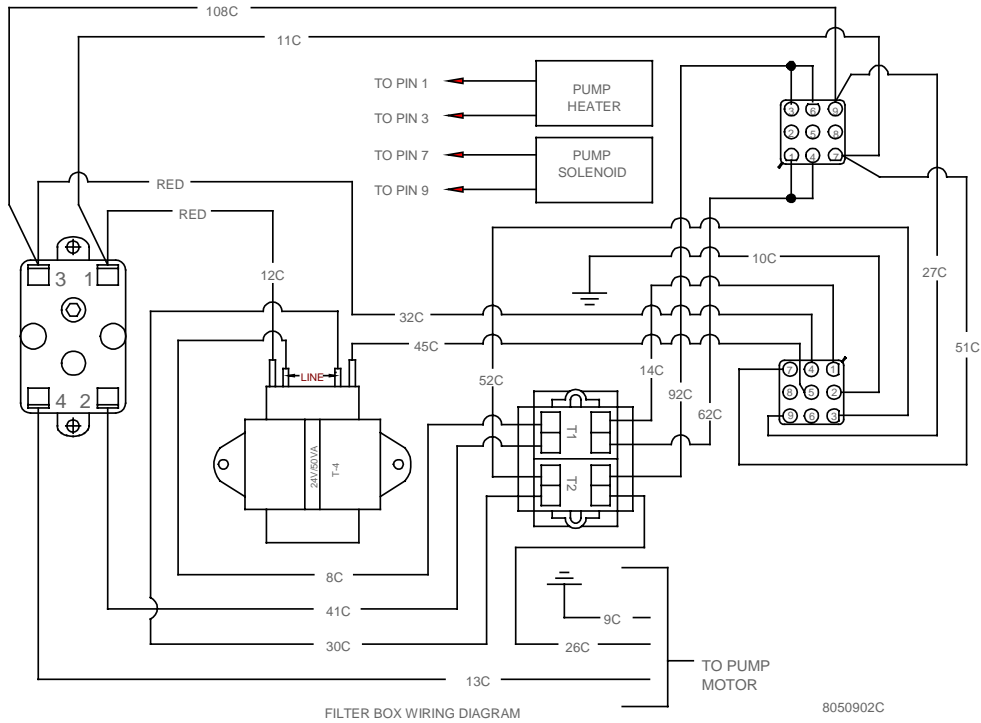

# H14 SERIES ELECTRIC FRYERS

## CHAPTER 8: PARTS LIST

### 8.1 Accessories

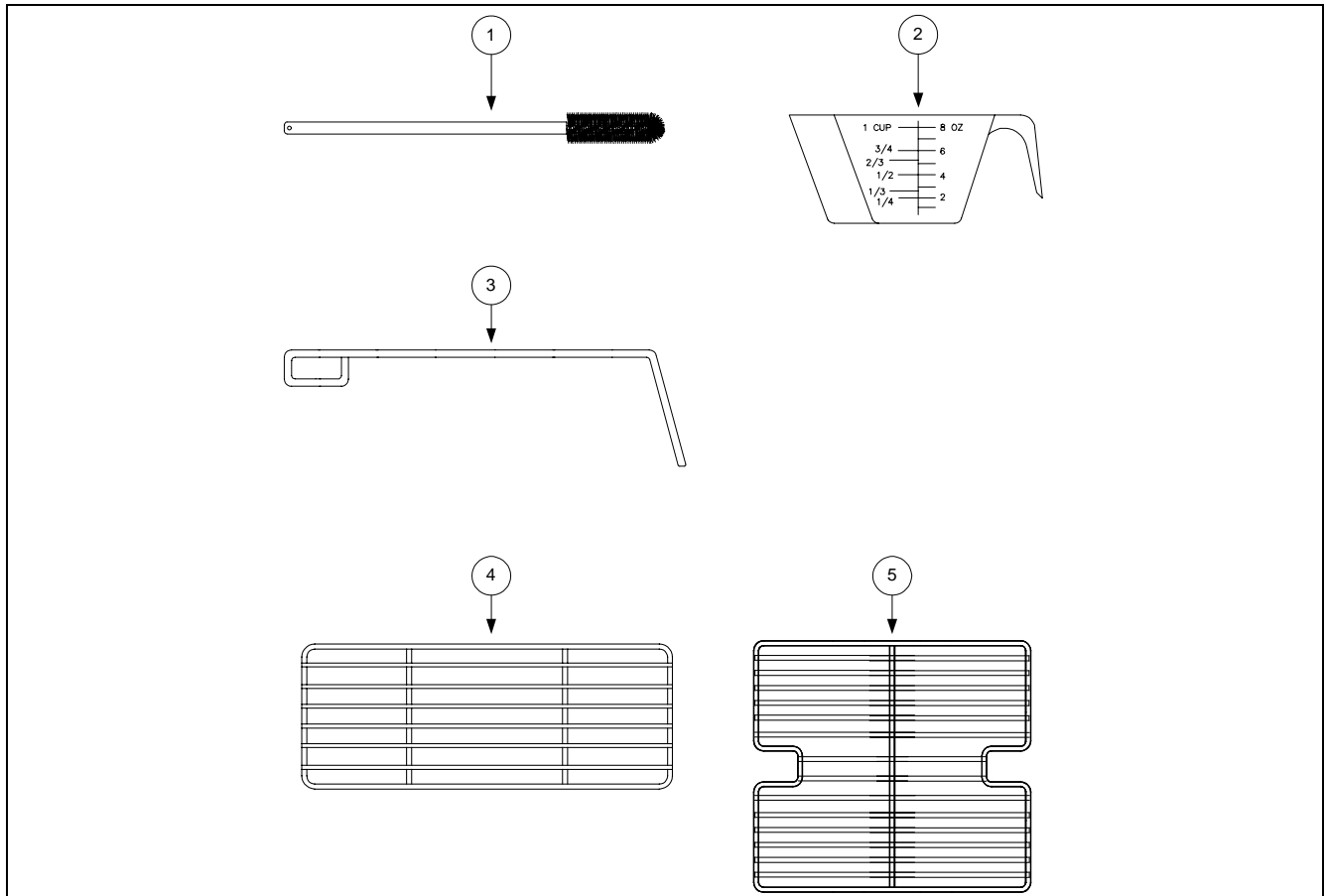

ITEM	PART #	COMPONENT
1	803-0209	Brush, FV/DV Frypot
2	803-0046	Cup, Measuring, Plastic, #1040
3	803-0197	Fryer Friend 27" (Clean-out Rod)
4	803-0106	Rack, Electric Dual-Vat Basket Support
5	803-0132	Rack, H50 Full-Vat With Probe Guard Basket
*	803-0002	Carton, Filter Powder
*	803-0170	Filter Pack- 100 Sheets
*	803-0219	Pad, McDonald's FPIII Universal Filter
*	806-0486	Cover, Frypot
* Not Illustrated		

## 8.2 Cabinet Assemblies and Component Parts

### 8.2.1 MH/BIH114 Cabinet Assembly, Single FootPrint

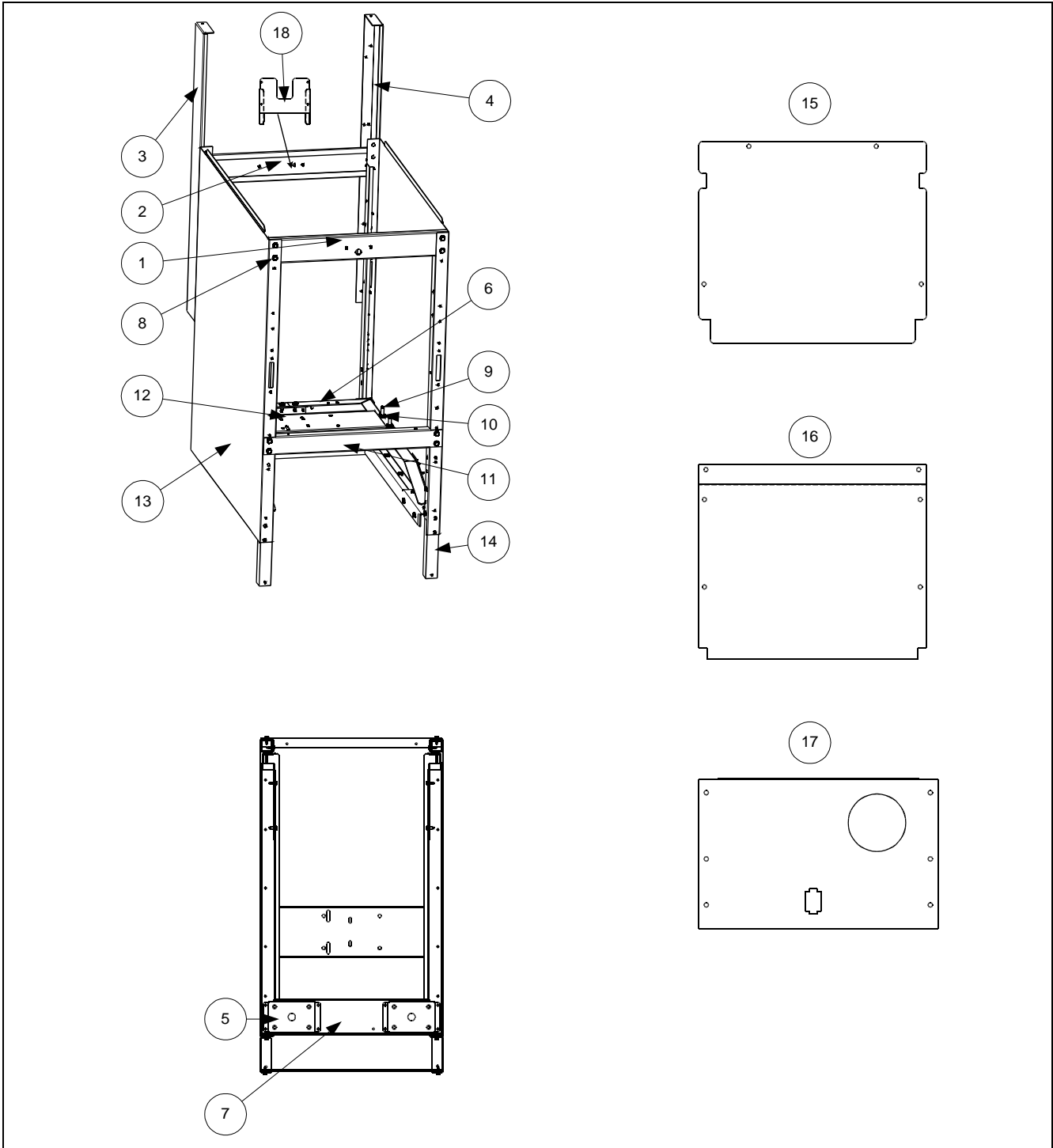

ITEM	PART #	COMPONENT
1	200-0129	Rail, Top Front Single
*	806-4910SP	Rail, Top Front Single (BIH114 prior to 1/99)
2	200-0130	Brace, Rear Horizontal
3	201-0137	Upright- rear enclosure
4	202-0137	Upright- rear enclosure
5	806-8059	Pad, Leg Assembly
6	806-8062	Rail, Pan Filter Assembly
7	806-8935SP	Base Assembly, FM 3-PIECE
	900-5313	Channel, CE FM Single Rear
	901-5316	Channel, CE FM LT Single Side
	902-5316	Channel, CE FM RT Single Side
*	806-7003SP	Base Assembly, Single Common Electric
8	826-1374	Screw, #10-1/2 Hex Head (Qty: 25)
9	826-1334	Bolt, 1/4-20 X 1 1/4 Hex Head (Qty: 5)
10	826-1368	Nut, Flange 1/4-20 Serrated (Qty: 10)
11	900-4391SP	Brace, Cabinet Front
*	900-4393SP	Brace, Cabinet Front (BIH114 prior to 1/99)
*	900-2733	Brace, Contactor Box, Front, N/F
*	900-2734	Brace, Support Contactor Box, Common Electric, N/F
12	900-8582	Mount, Motor Single FootPrint
13	910-2456SP	Side , Cabinet
*	911-9314SP	Side, Cabinet (BIH114 prior to 1/99)
*	912-9314SP	Side, Cabinet (BIH114 prior to 1/99)
14	910-8659	Leg, Cabinet Front, Single FootPrint
*	910-7925	Leg, Cabinet Front (BIH114 prior to 1/99)
15	900-2717SP	Back, Upper Cabinet
*	910-2912	Back, Upper Cabinet (BIH114 prior to 1/99)
16	900-5141	Back, Center Cabinet
17	900-8449	Back, Lower Cabinet
*	910-2911	Back, Lower Cabinet (BIH114 prior to 1/99)
18	900-9585	Heat Shield, Wire, Common Electric

## 8.2.2 MH/BIH214, 314, 414, 514 Cabinet Assemblies

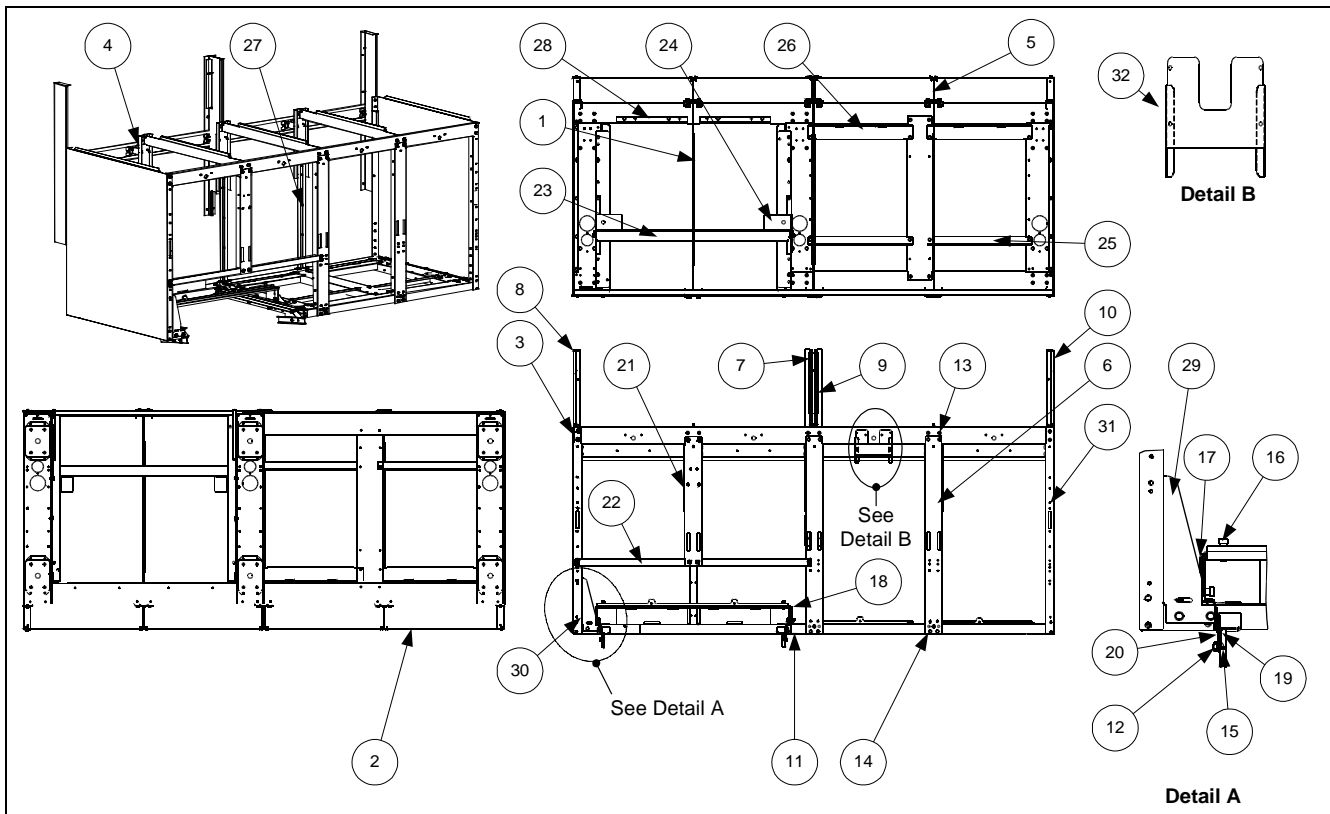

ITEM	PART #	COMPONENT
1	<a href="#">200-0076</a>	Divider, Cabinet, Common Electric
2	200-0084	Brace, Rear Horizontal, 2 Battery (Quad and Double)
*	200-0085	Brace, Rear Horizontal, 3 Battery (Triple)
3	200-0091	Rail, Top- Quad Cabinet
*	200-0072	Rail, Top- Triple Cabinet
*	200-0081SP	Rail, Top- Double Cabinet
4	200-0092	Support, Rear, Common Electric
5	200-0126	Brace, Rear Support
6	200-0138	Door Post, Common Electric (Triple, Quad w/filter; Double, Triple, Quad N/F)
7	201-0093	Enclosure, Rear Upright with Hole (Quad Only)
8	201-0137	Upright, Rear Enclosure, Common Electric
9	202-0093	Enclosure, Rear Upright with Hole (Quad Only)
10	202-0137	Upright, Rear Enclosure, Common Electric
11	<a href="#">806-7005SP</a>	Base, Filter Assembly, Common Electric- Quad
*	<a href="#">806-6513SP</a>	Base, Filter Assembly, Common Electric- Triple
*	806-6511SP	Base, Filter Assembly, Common Electric- Double
*	806-6997SP	Base Assembly, Common Electric N/F- Double
*	806-6999SP	Base Assembly, Common Electric N/F- Triple
*	806-7001SP	Base Assembly, Common Electric N/F- Quad
12	<a href="#">826-1376</a>	Nut, 10-32 (Qty: 10)

ITEM	PART #	COMPONENT
13	826-1374	Screw, #10 ½-Inch (Qty: 25)
14	809-0413	Spacer, Door Post (Quad and Triple Only)
15	809-0422	Screw, Shoulder- 10-32 x .40
16	809-0538	Bolt, Shoulder- ¼-20 x 3/8
17	823-2290	Front Bridge Support, Left
18	823-2291	Front Bridge Support, Right
19	900-1957	Lock Filter
20	900-1959	Bracket, Mounting, Filter Lock
21	900-2463	Post, Center Door, Common Electric
22	900-2464SP	Brace, Lower, Front Horizontal, Common Electric
23	900-2514	Bridge, Common Electric
24	900-2653	Plate, Swivel, Common Electric
25	900-2718	Brace, Contactor, Front, Common Electric w/Filter-Quad
*	200-0078	Brace, Contactor, Front, Common Electric [(w/Filter-Triple), N/F- Quad)
*	200-0075	Support, Contactor, Front, Common Electric N/F
26	900-2720	Brace, Contactor, Rear, Common Electric-Quad
*	200-0077	Brace, Contactor, Rear, Common Electric [(w/Filter-Triple), N/F- Quad)
*	200-0074	Support, Contactor, Rear, Common Electric N/F
27	900-2861SP	Support, Bottom, Common Electric
28	900-5988	Support, Rear, Bridge Filter, Common Electric
29	901-1810	Gusset, Cabinet, Left
*	902-1810	Gusset, Cabinet, Right (BIH214 Only)
30	901-1948	Channel, Side Support
31	910-2456SP	Cabinet Side, Common Electric
*	900-8452	Back, Lower Quad
*	900-8451	Back, Lower Triple
*	900-8450	Back, Lower Double
*	900-5145	Back, Center Triple
*	900-5143	Back, Center Double
*	900-2511	Back, Upper Triple
*	900-2465	Back, Upper Double
32	900-9585	Heat Shield, Wire, Common Electric

\* Not Illustrated

### 8.3 Casters, Legs and Associated Hardware

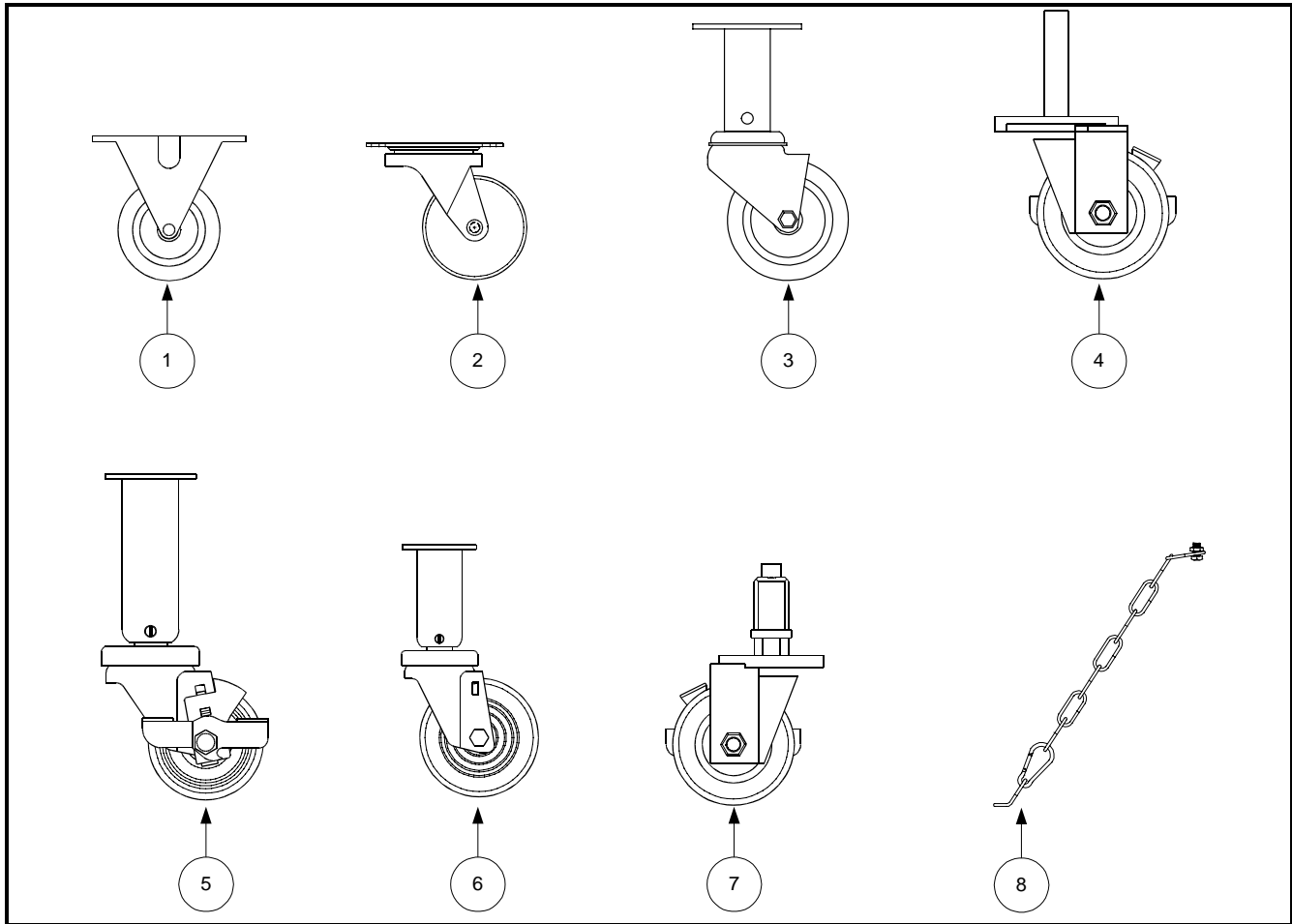

ITEM	PART #	COMPONENT
1	810-0005	Caster, Rigid
2	810-0006	Caster, Swivel-Rokite
3	810-0327	Caster, Adjustable, Without Brake
4	810-1565	Caster, Stud, Single FP 3", With Lock
5	810-0944	Caster, Adjustable 3" With Brake
6	812-1326	Caster W/A, 152-2 Adjustable With Brake
7	823-2844	Caster W/A, Front Common Electric, Single FootPrint
8	826-0900	Chain Restraint Kit (for use on fryers w/casters)

## 8.4 Component Box Assemblies/Associated Component Parts

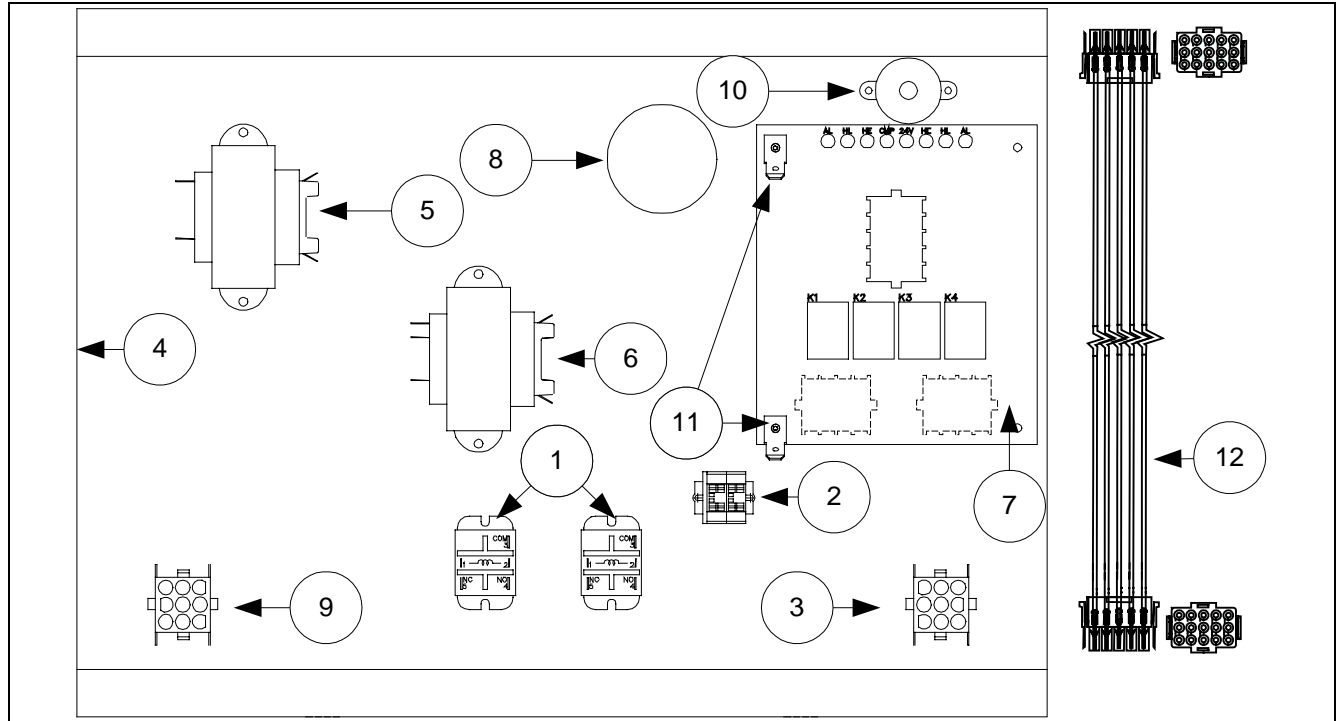

ITEM	PART #	COMPONENT
1	807-1683	Relay, Burnoff (McDonald's CE Models Only)
2	810-1164	Terminal Block Wire Assembly
3	806-6863SP	Wire Assembly, Burnoff, Full-Vat (McDonald's CE only)
3	806-6864SP	Wire Assembly, Burnoff, Dual-Vat (McDonald's CE only)
4	806-8244	Component Box/Stud Assembly
5	807-2191	12 VAC Transformer, 208-240 V
5	807-2192	12 VAC Transformer, 100-120V
6	807-2180	24 VAC Transformer, 208-240 V
6	807-2181	24VAC Transformer, 100-120V
7	806-6336	Interface Board
8	807-1084	Bushing
9	806-6854SP	Wiring Assembly, Transformer
10	806-7179SP	Sound Device
11	826-1337	Terminal Tab (Qty: 5)
12	806-2071	Cable Assembly, Computer/Interface Board

# 8.5 Control Panel Assemblies/Top Caps/Door Assemblies/Related Components

## 8.5.1 Control Panel Assemblies and Top Caps

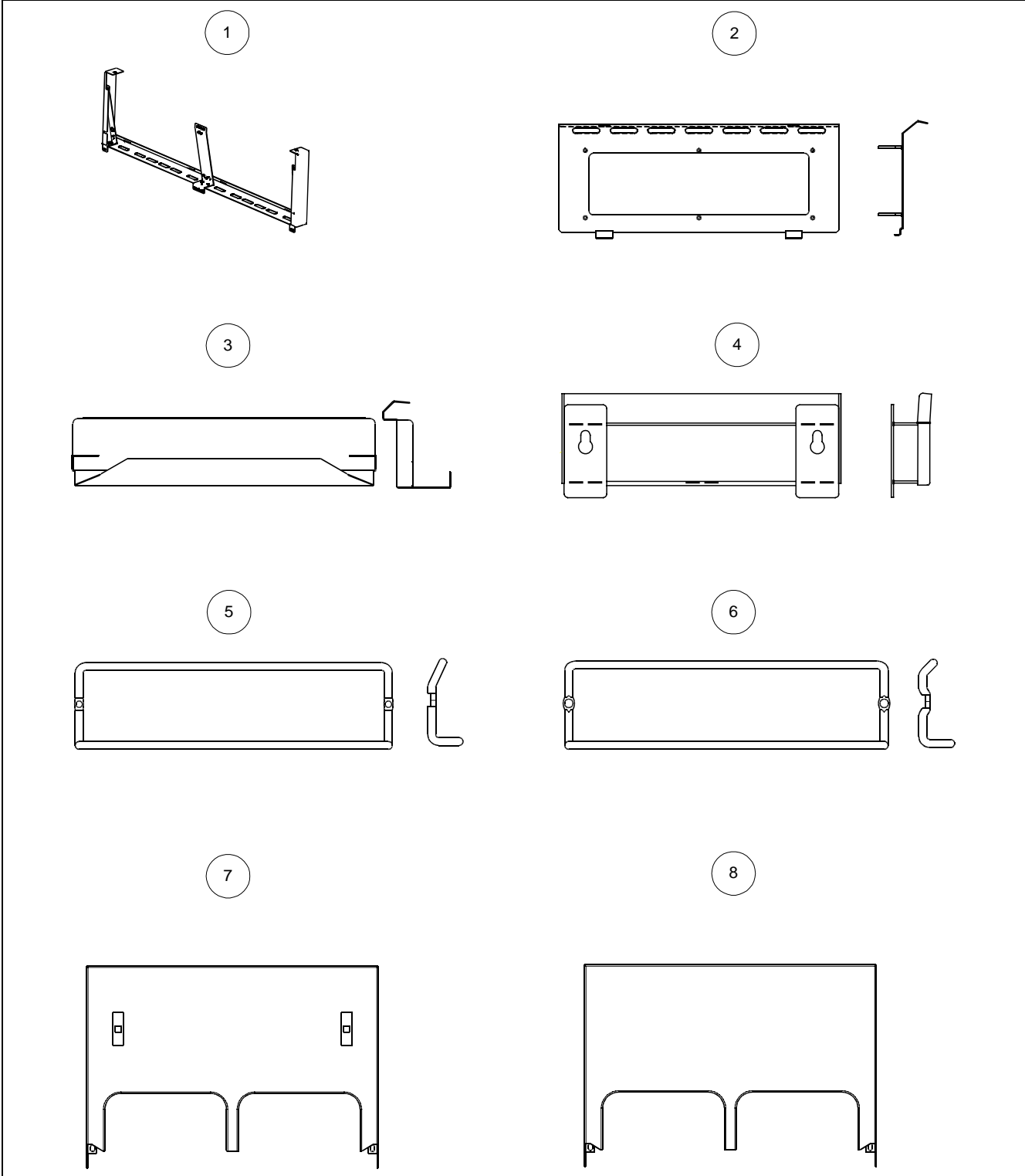

ITEM	PART #	COMPONENT
1		Control Panel Assembly
	806-9821SP	Center Brace, Control Panel (Double, Triple, Quad)
	809-0396	Screw, #6-32 x 3/8 Phillips Pan Head, Type F
	900-2732	Bracket, Control Panel Support
	910-4808	Frame, Control Panel Bottom, Single
	910-7045	Frame, Control Panel Bottom, Double
	910-9256	Frame, Control Panel Bottom, Triple
	910-9419	Frame, Control Panel Bottom, Quad
	911-2730	End, Control Panel (Left)
	912-2730	End, Control Panel (Right)
2	823-2307	Control Panel, with Slot
3	824-0577	Top Cap, Single Fryer
*	824-0575	Top Cap, Two-Fryer Battery
*	824-0576	Top Cap, Three-Fryer Battery
*	824-0578	Top Cap, Four-Fryer Battery
4	823-1618	Basket Hanger, McDonald's
5	810-1401	Basket Hanger, Wire
6	810-1403	Basket Hanger, Wire-Offset
7	824-0532	Housing, MAC114 Tilt w/o cap/splash
*	824-0534	Housing, MAC214 Tilt w/o cap/splash
*	824-0535	Housing, MAC314 Tilt w/o cap/splash
*	824-0536	Housing, MAC414 Tilt w/o cap/splash
*	910-7443	Top Connecting Strip (for fryers w/o cap/splash)
*	910-2420	Strip, MAC114 Electric Hood (for fryers w/o cap/splash)
*	910-2439	Strip, MAC 414 Electric Hood (for fryers w/o cap/splash)
*	910-2440	Strip, MAC 314 Electric Hood (for fryers w/o cap/splash)
*	910-2441	Strip, MAC 214 Electric Hood (for fryers w/o cap/splash)
8	824-0645	Housing, MAC114 HE Tilt with cap/splash
*	824-0647	Housing, MAC214 HE Tilt with cap/splash
*	824-0648	Housing, MAC314 HE Tilt with cap/splash
*	824-0646	Housing, MAC414 HE Tilt with cap/splash
*Not Illustrated		

### 8.5.1 Door Assembly Components

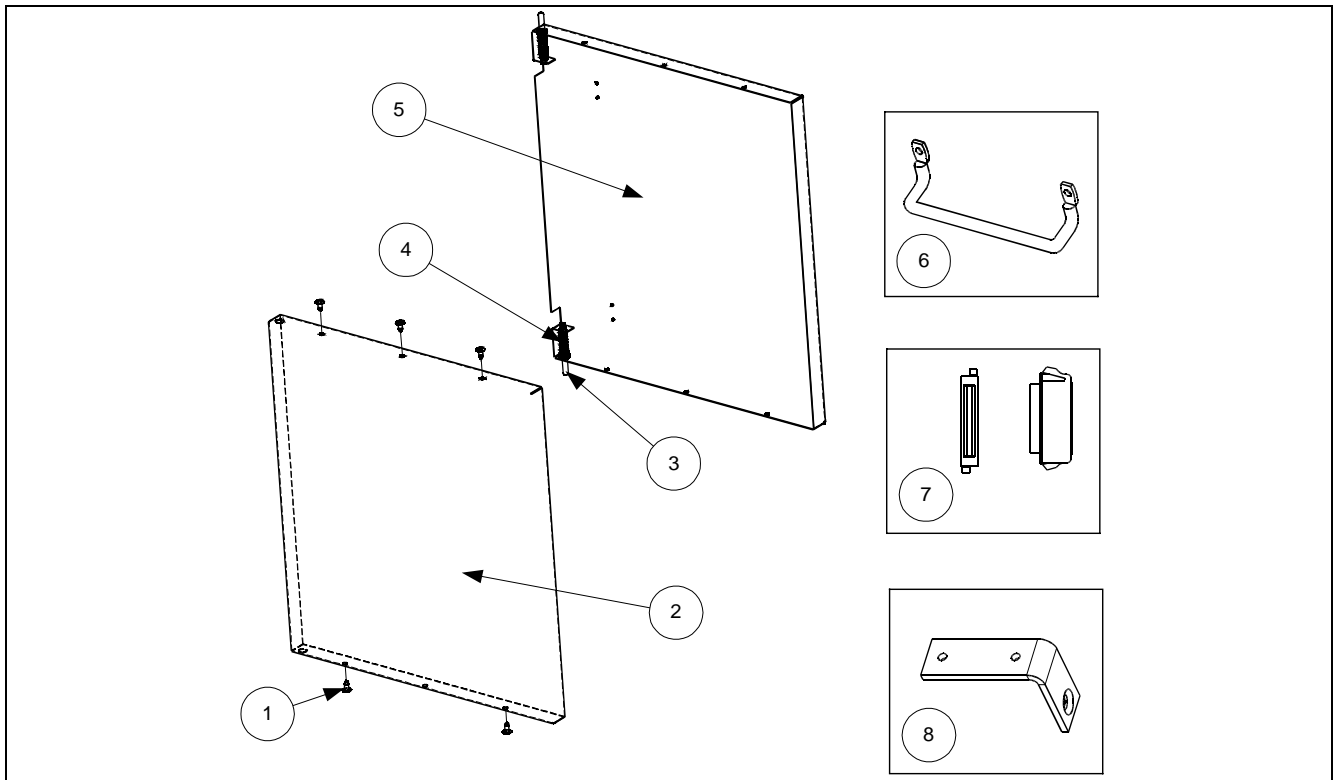

ITEM	PART #	COMPONENT
	806-6545SP	Door Assembly, Universal
1	809-0266	Screw, #10- 1/2-inch
2	824-0137SP	Panel, Door
3	806-4487SP	Door Pin Assembly
*	809-0193	Washer, Flat 1/4-Inch Nylon (Door Pin Bushing)
4	826-1343	Spring, Door Hinge (Qty: 10)
5	900-2485	Liner, Door
6	810-1422	Handle, Wireform, Door
7	810-1105	Magnet, Door
8	810-1508	Hinge, Universal Door
* Not Illustrated		

## 8.6 Controller Assemblies

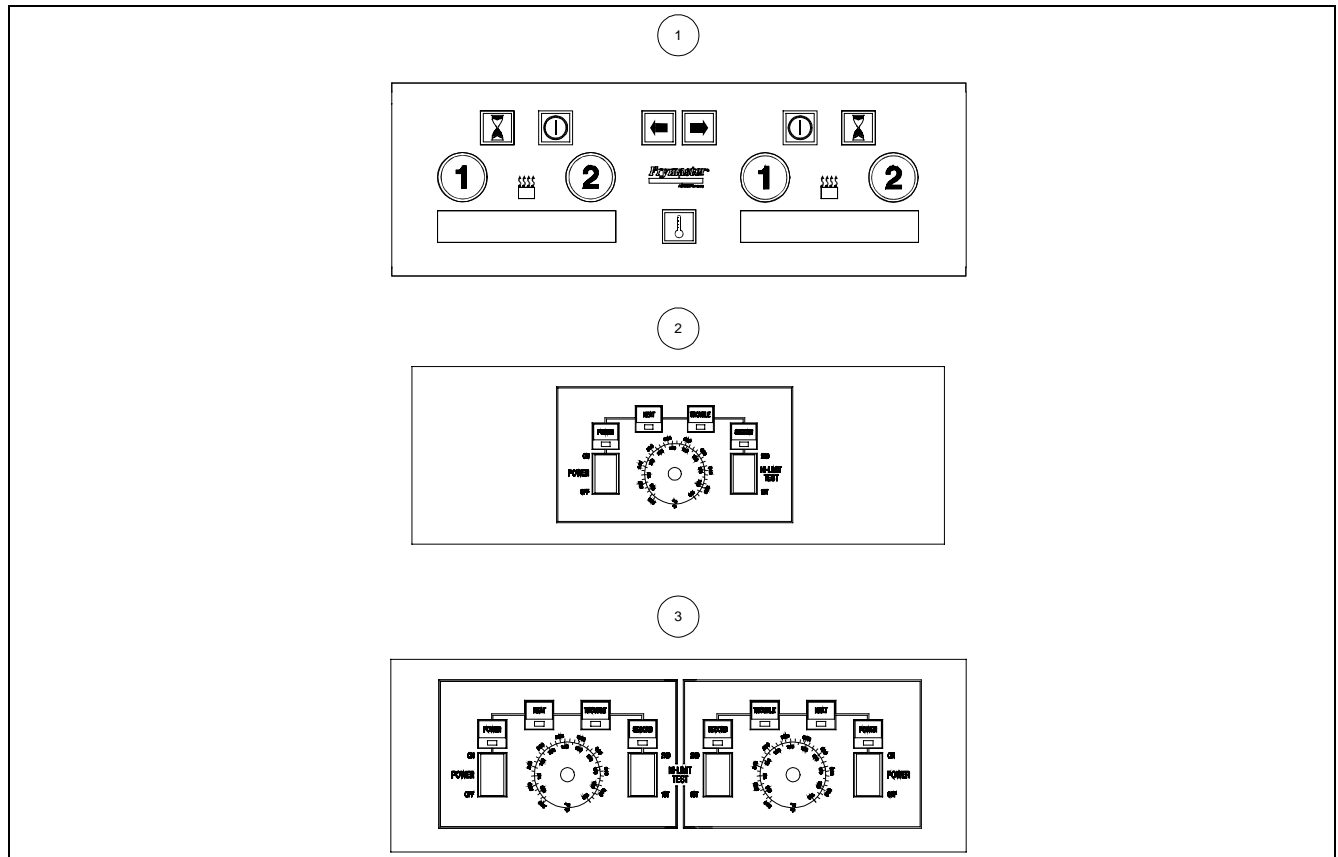

ITEM	PART #	COMPONENT
1	806-7990	Computer, M100B
*	806-8000	Computer, M100B Standard, Electric
*	806-8036	Computer, M100B, International
*	806-8103	Computer, M100B, CE Electric
2	<a href="#">806-7436</a>	Controller, Full-Vat, MH/BIH14
3	<a href="#">806-7437</a>	Controller, Dual-Vat, MH/BIH14
* Not Illustrated		

## 8.7 Drain System Components

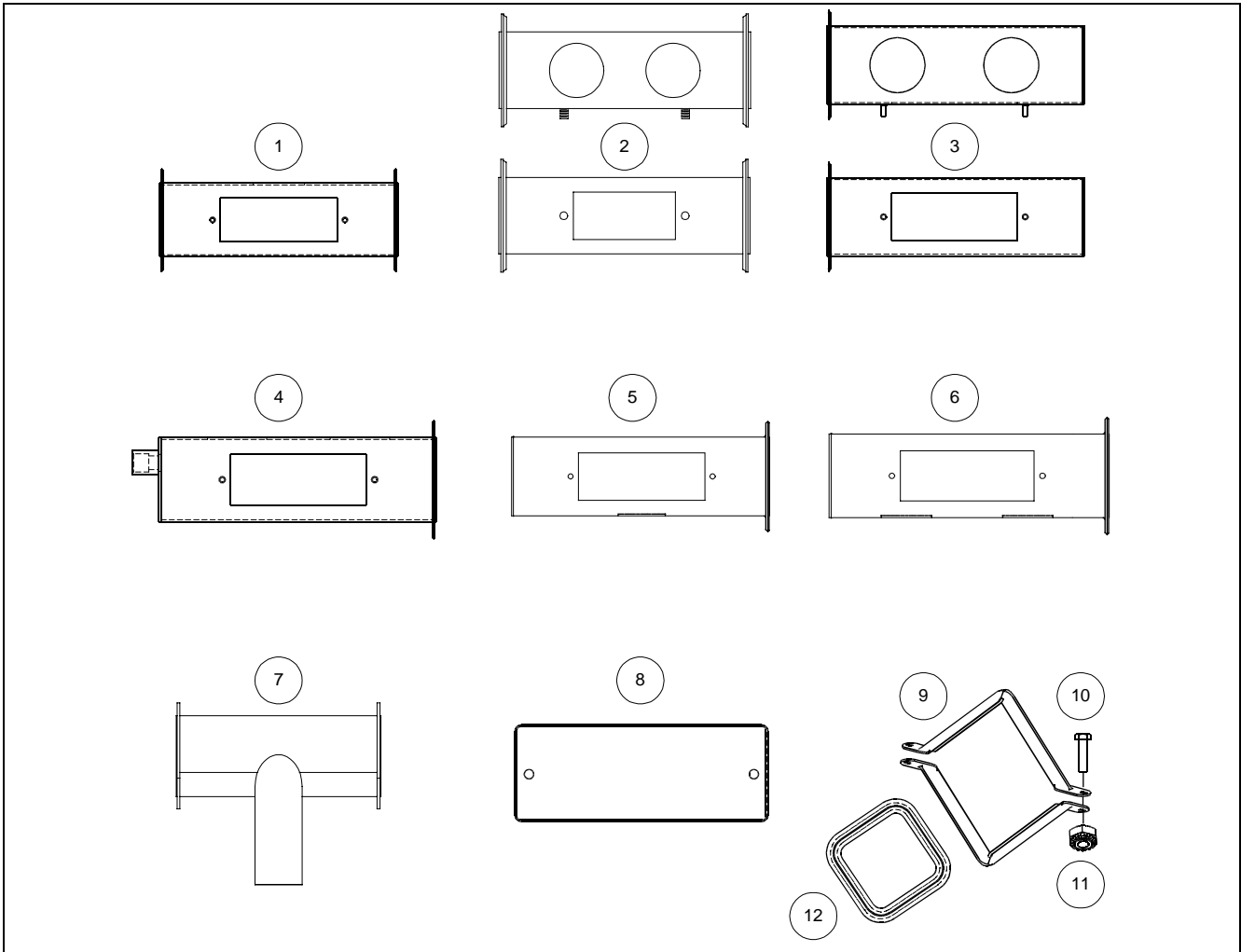

ITEM	PART #	COMPONENT
1	823-0718	Drain Tube, Left End, 2.5 x 8.0"
2	823-0725	Drain Tube, Left End, Dual-Vat, 2.5 x 8.0"
3	823-1551	Drain Tube, Right End, Dual Vat
4	823-2636	Drain Tube, Left End, Dual-Vat
*	823-2637	Drain Tube, Left End, Full-Vat
5	823-1549	Drain Tube, Right End, Full-Vat
6	823-1543	Drain Tube, Right End, Dual-Vat
7	823-2336	Drain, FootPrint
8	826-1348	Cover, Drain Cleanout (Qty: 5)
9	810-0396	Clamp, 2.5" Drain, Filter Magic (Two Required Per Union)
10	826-1375	Screw, 10-32 x 3/4 Hex Trim HD SS (Qty: 5)
11	8261376	Nut, 10-32 Hex (Qty: 10)
12	816-0032	Gasket, Square Drain

\* Not Illustrated

# 8.8 Electrical Components: Contactors, Elements and Related Components

## 8.8.1 Contactors

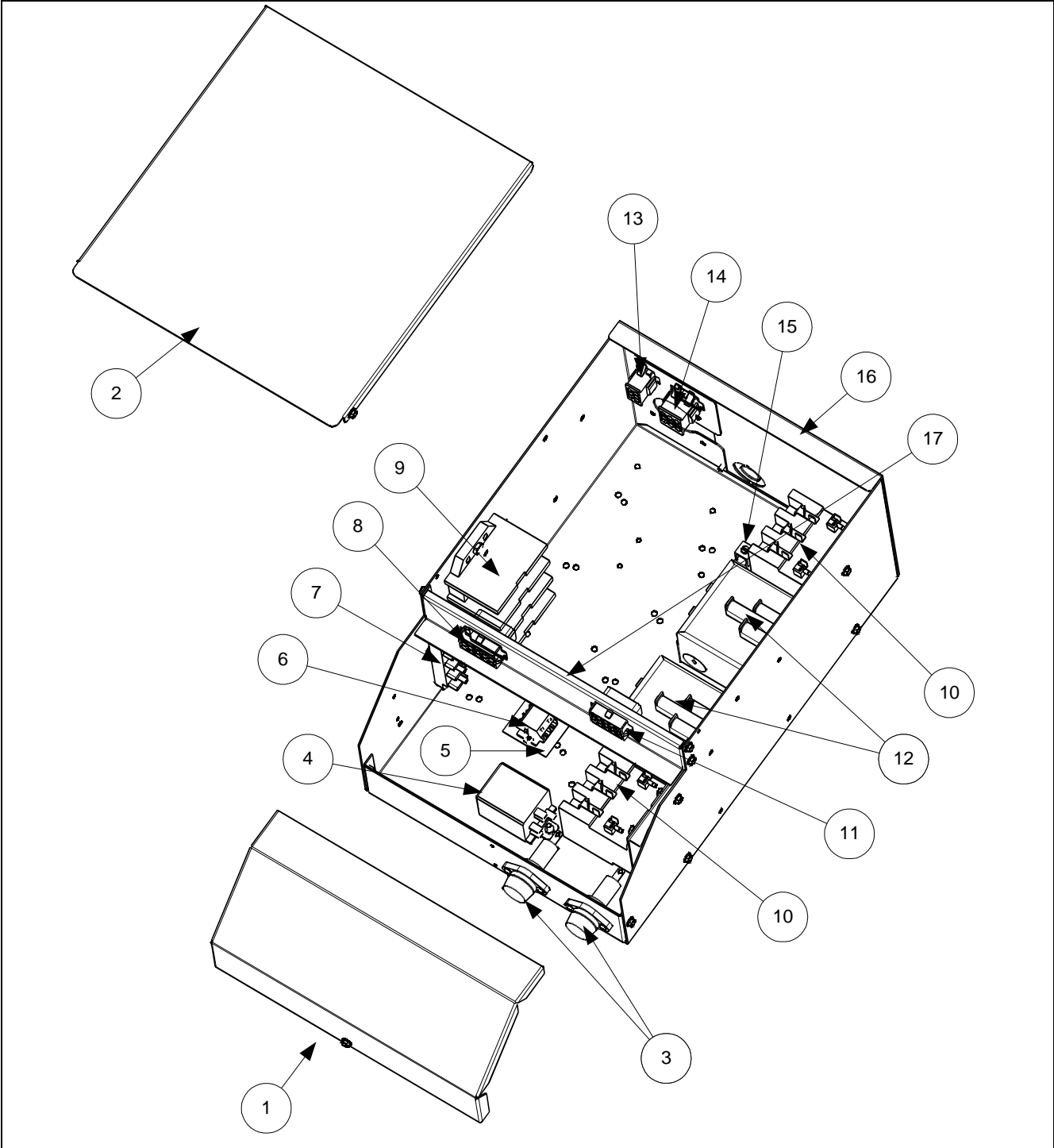

ITEM	PART #	COMPONENT
1	900-5445	Front Cover, Contactor Box
2	900-5446	Top Cover, Contactor Box
3	807-0922	Holder, Buss Fuse
*	807-2278	Fuse, 20 Amp
4	807-2515	Relay, 120V SPDT, 10A
5	816-0217	Paper, Insulating Terminal Block (CE)
6	810-1164	Terminal Block
7	807-1973	Terminal Post
8		C1 Wiring Assembly
	806-7664SP	McDonald's Domestic, Full-vat
	806-7669SP	McDonald's Domestic, Dual-vat
	806-8095SP	McDonald's CSA, Full-vat
	806-8096SP	McDonald's CSA, Dual-vat
	806-7197SP	McDonald's Export, Full-vat
	806-8017SP	McDonald's Export, Dual-vat
9	807-2464	Power Block, Delta
10	810-1202	Contactor, 3-Pole 600V 40 Amp
11		C2 Wiring Assembly
	806-8269	McDonald's Domestic, Full- and Dual-vat
	806-7666SP	McDonald's Export, Full- and Dual-vat
	806-8094	McDonald's CSA, Full- and Dual-vat
12	807-1071	Contactor, Mercury 24 VAC 30 Amp
13	806-7183SP	Wire Assembly, Left, Dual-vat
*	806-7186SP	Wire Assembly, Left, Full-vat
14	806-7185SP	Wire Assembly, Right, Full- and Dual-vat
15	807-0070	Terminal, Ground Lug
16	900-5447	Back Cover, Contactor Box
17	900-5782	Bracket, Connector-Common Electric
* Not Illustrated		

### 8.8.2 Elements and Related Components

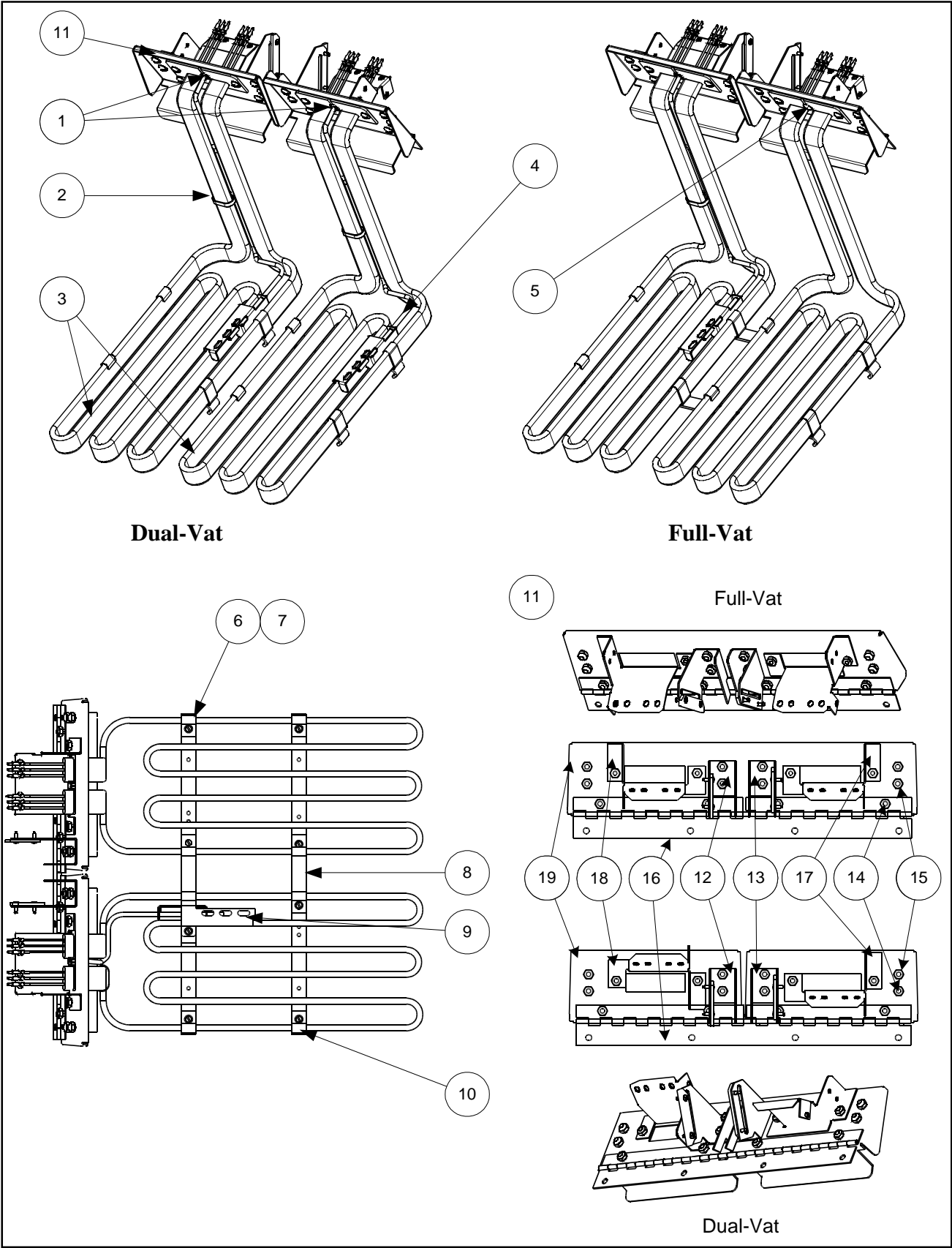

ITEM	PART #	COMPONENT
1	826-1339	Bushing, .375 Split (Qty: 10)
2	809-0567	Ty-Wrap, Metal
3		Heating Element
	807-2639	Heating Element, 208V 7 kW
	807-2641	Heating Element, 220V 8.5 kW
	807-2642	Heating Element, 230V 7 kW
	807-2643	Heating Element, 230V 8.5 kW
	807-2644	Heating Element, 240V 7 kW
	807-2645	Heating Element, 240V 8.5 kW
	807-2651	Heating Element, 480V 7 kW
	806-8474SP	Heating Element Assembly, 240V 14 kW Full-Vat
	806-8520SP	Heating Element Assembly, 230V 15.6 kW Full-Vat
	806-8523SP	Heating Element Assembly, 230V 17 kW Dual-Vat
4	807-2478	Temperature Probe
5	816-0480	Dome Plug, .375 OD. (Full-Vat Only)
6	809-0518	Screw #8 32 x 3/8-inch
7	910-2042	Clamp, Element
8	910-3681	Element Support, Full-Vat
*	910-5214	Element Support, Dual-Vat
9	910-5022	Bracket, Temperature Probe
10	910-5213	Clamp, H14/H17 Element
11	106-0003SP	Tilt Plate Assembly, Full-vat
*	106-0004SP	Tilt Plate Assembly, Dual-vat
		Tilt Plate Assembly, Individual Components
12	806-8285SP	Spring Slot Bracket Assembly, Right
13	806-8286SP	Spring Slot Bracket Assembly, Left
*	810-0297	Spring, Element
14	826-1330	Screw, 10-32 x 3/8 (Qty: 25)
15	826-1376	Nut, 10-32 (Qty: 10)
16	810-0035	Hinge, Stainless Steel Split—14-Inch
17	901-8509	Bracket, Element Support, Left
18	902-8509	Bracket, Element Support, Right
19	910-9640	Plate, Tilt, Full-Vat (1 Required)
19	910-9641	Plate, Tilt, Dual-Vat (2 Required)
*	826-1061	Tilt Switch, Mercury Non-CE (Full-Vat requires one switch and Dual-Vat requires two.)
*	826-2228	Tilt Switch, CE (Full-Vat requires one switch and Dual-Vat requires two.)
* Not Illustrated		

### 8.8.3 Hood Relay Box, Power Cords and Hood Cords

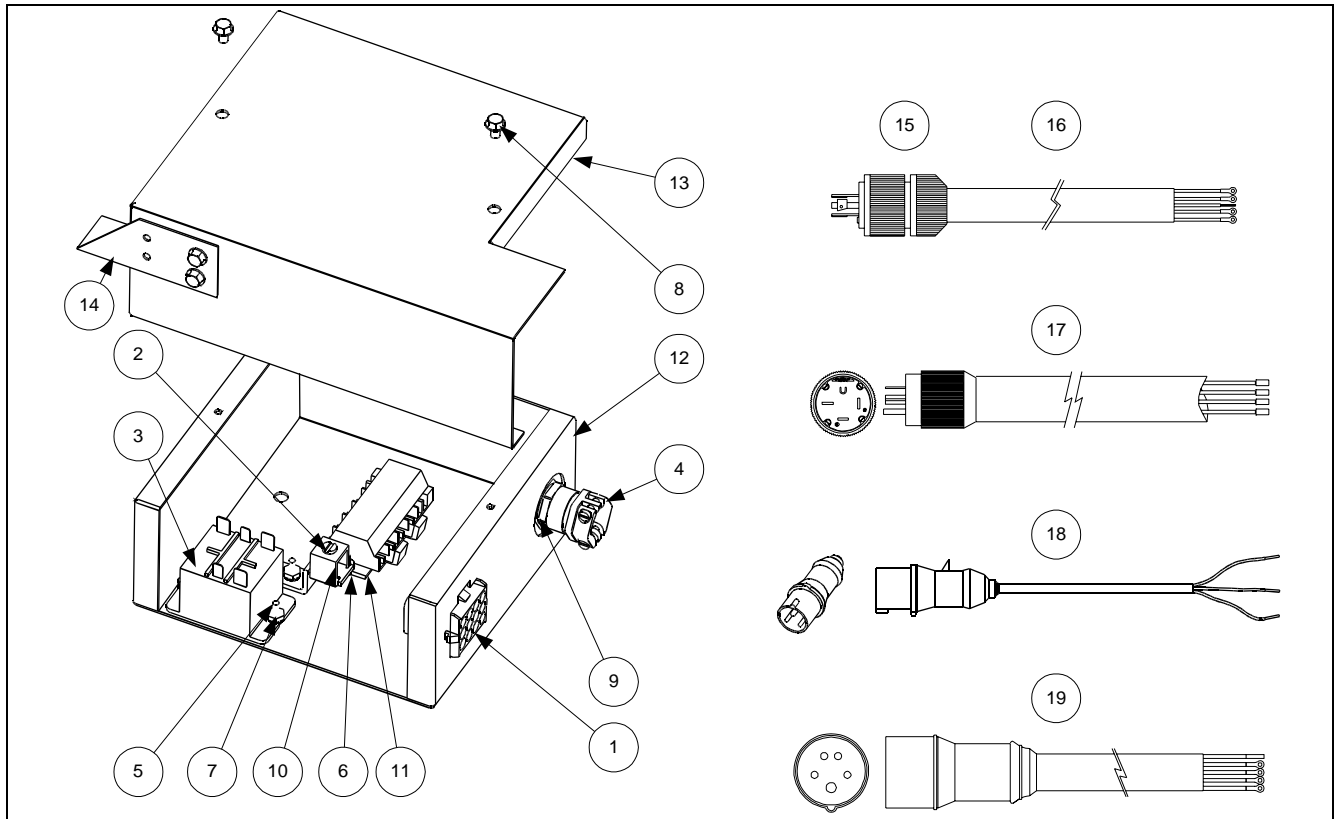

ITEM	PART #	COMPONENT
1	806-9381SP	Wire Assembly, CE Mac
*	806-9389SP	Wire Assembly, Non-CE Mac
2	807-0070	Terminal, Ground Lug
3	807-1683	Hood Relay, 12VDC
4	807-1694	Strain Relief, HE
5	826-1363	Screw, #8- 32 x 1/2 (Qty: 25)
6	809-0238	Nut, 4-40 Hex
7	809-0247	Nut, 8-32 Hex
8	809-0359	Screw, #8- 32 x 1/4 Hex-slotted
9	809-0492	Nut, Lock
10	809-0656	Screw, 4-40 x 3/8 Round-slotted
11	810-1163	Terminal Block, Screwless
*	807-1973	Terminal, Post (Non-CE)
12	900-8024	Box, Control Cord, CE Mac
13	900-8025	Cover, Control Cord Box
14	901-1530	Bracket, Attaching, Control Panel
15	807-1558	Plug, 4 Pole 5 Wire 20A
16	806-5229	Cordset, 120V 5 Wire (Plug not included)
17	807-2392	Cordset, Power, 3 Phase, 4-Wire w/Plug
18	807-1696	Cordset, Power, Europe, 3-Wire w/Plug
19	806-8164SP	Cordset, Power, Full-vat Export

# 8.9 Filter Base/Pan Assemblies

## 8.9.1 Filter Base Assemblies

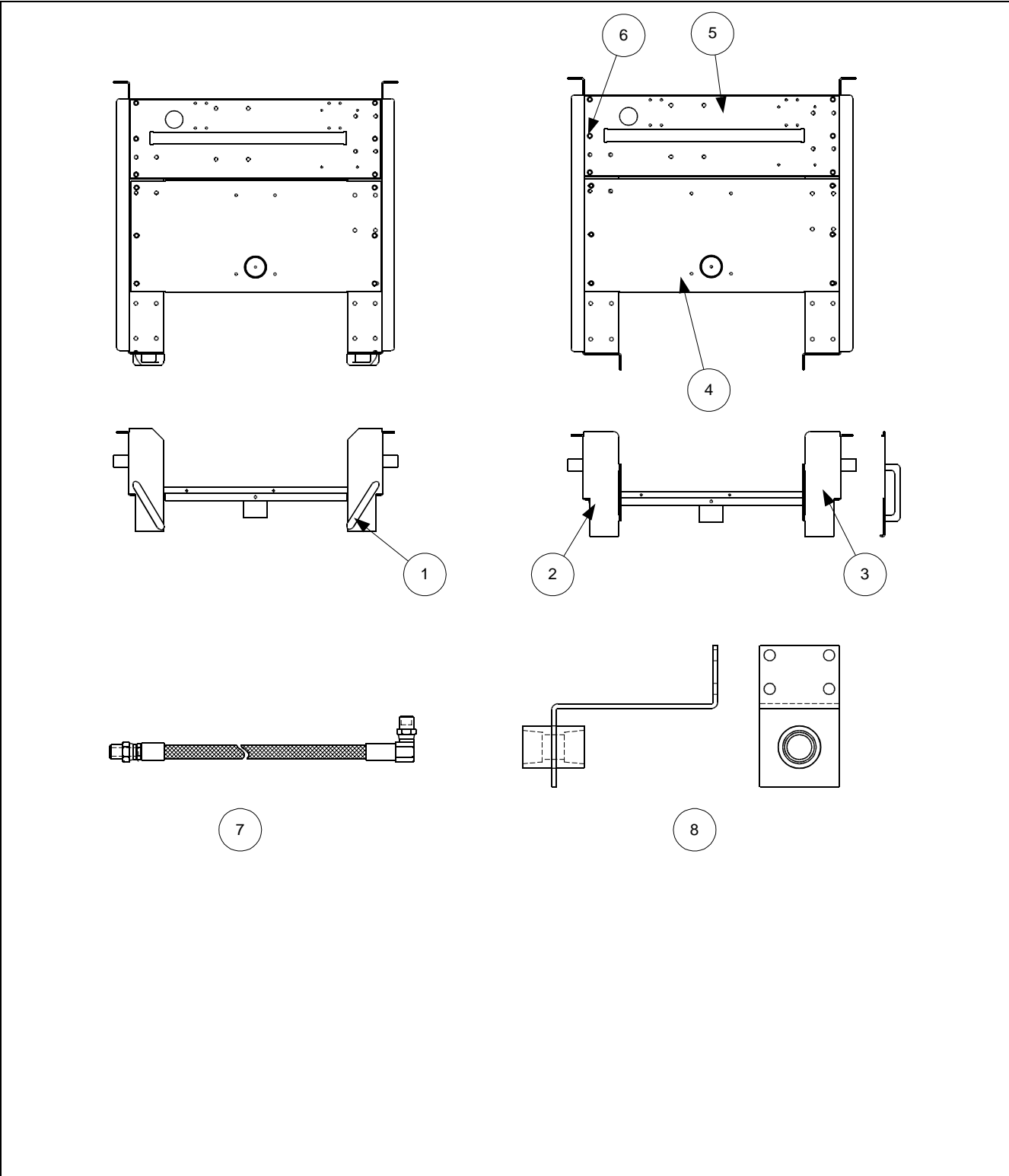

ITEM	PART #	COMPONENT
	806-8648SP	Filter Base Assembly, FootPrint III
1	810-0180	Handle, Filter Base Assembly
*	826-1360	Screw, #10-24 x 5/16 [Qty: 25 (to attach P/N 810-0180)]
2	901-8542	Filter Base, Left Side
3	902-8542	Filter Base, Right Side
4	823-2289	Filter Pan Support
5	900-5396	Motor Support
6	826-1374	Screw, #10-1/2 Hex Head (Qty: 25)
*	900-5477	Cover, Motor (August 1997 and later)
*	824-0558	Cover, Motor (Prior to August 1997)
*	900-1949	Standoff, Filter Wiring Box
7	810-1423	Hose, Oil Return
8	823-2638	Bracket, Oil Return Hose
<p>NOTE: P/N 810-0180 (Pull Handle) is available as a replacement for damaged handles on base assemblies manufactured from 8/97 to 8/99, If damaged filter bases need replacement, they must be replaced with P/N 901-8542 and 902-8542, in which includes handles. Filter bases with replaceable handles are no longer available.</p>		
<p>*Not Illustrated</p>		

# 8.9.2 Filter Pan Assemblies

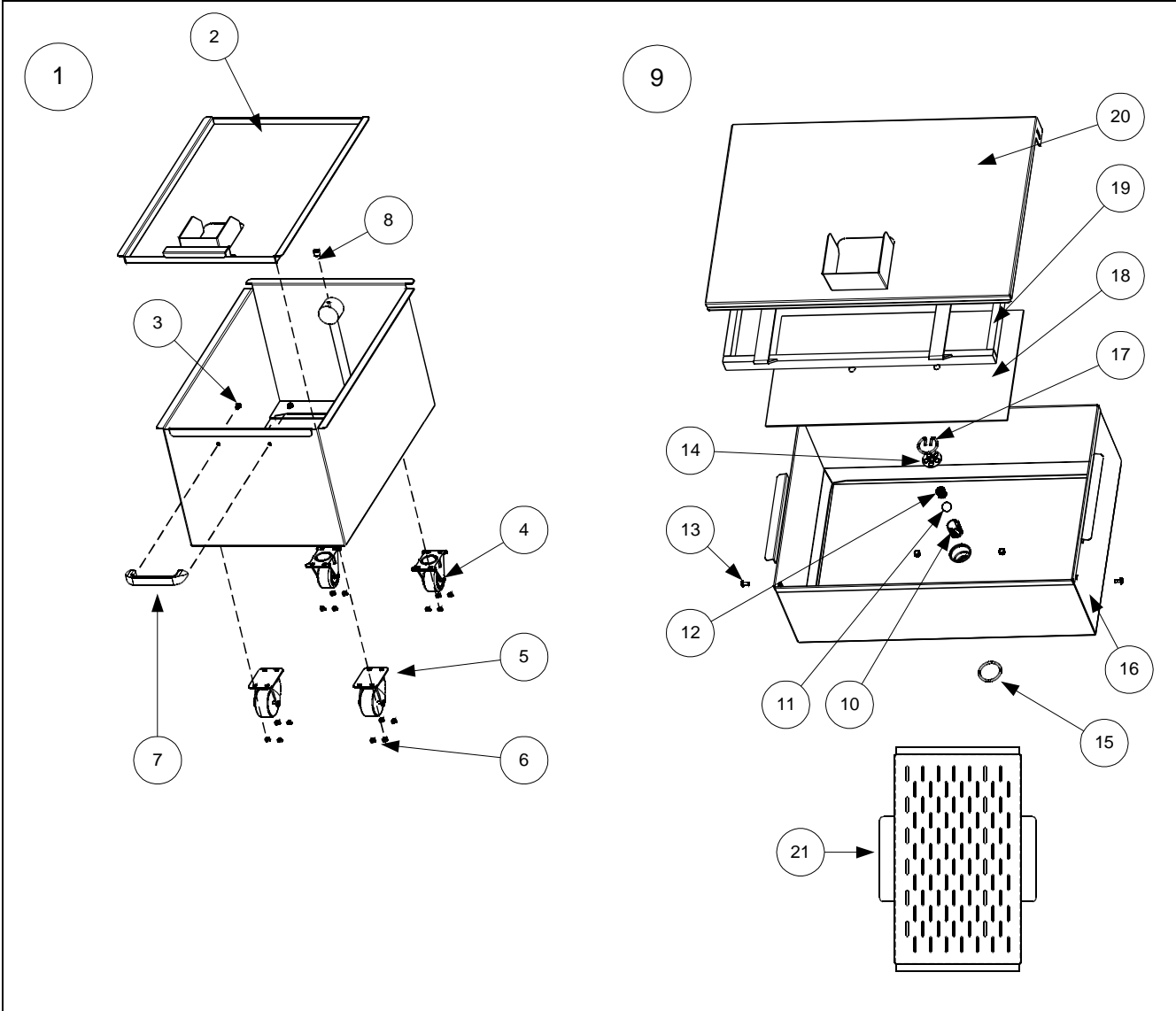

<b>ITEM</b>	<b>PART #</b>	<b>COMPONENT</b>
1	806-9546SP	Filter Pan Assembly, Single FootPrint
2	806-9547SP	Cover Assembly, Filter Pan
*	809-0045	Nut, 10-32
*	809-0117	Screw, 10-32 x 3/8 SS
*	809-0185	Washer, Flat #10
*	910-1816	Handle, Filter Pan, Single FootPrint
3	826-1360	Screw, 10-24 x 5/16 (Qty: 25)
4	810-0005	Caster, Rigid
5	810-0006	Caster, Swivel
6	826-1376	Nut, 10-32 (Qty: 10)
7	810-0180	Handle, Door
8	813-0411	Plug, Pipe-1/8 Internal Hex
9	806-6423SP	Filter Pan Assembly, FootPrint III
10	810-1388	Tube, Check Valve
11	810-0948	Ball, Check Valve
12	810-0946	Spring, Check Valve
13	809-0422	Screw, Shoulder 10-32 x 7/16
14	900-5448	Strain Plate, Check Valve
15	816-0181	O-Ring, Check Valve
16	823-2234SP	Filter Pan
17	810-1387	Retainer, Check Valve
18	900-8818	Screen
19	810-1405	Hold-down Ring
20	823-2027	Cover, Filter Pan
21	824-0430	Crumb Screen
*Not Illustrated		

## 8.10 Filter Pump and Motor Assemblies

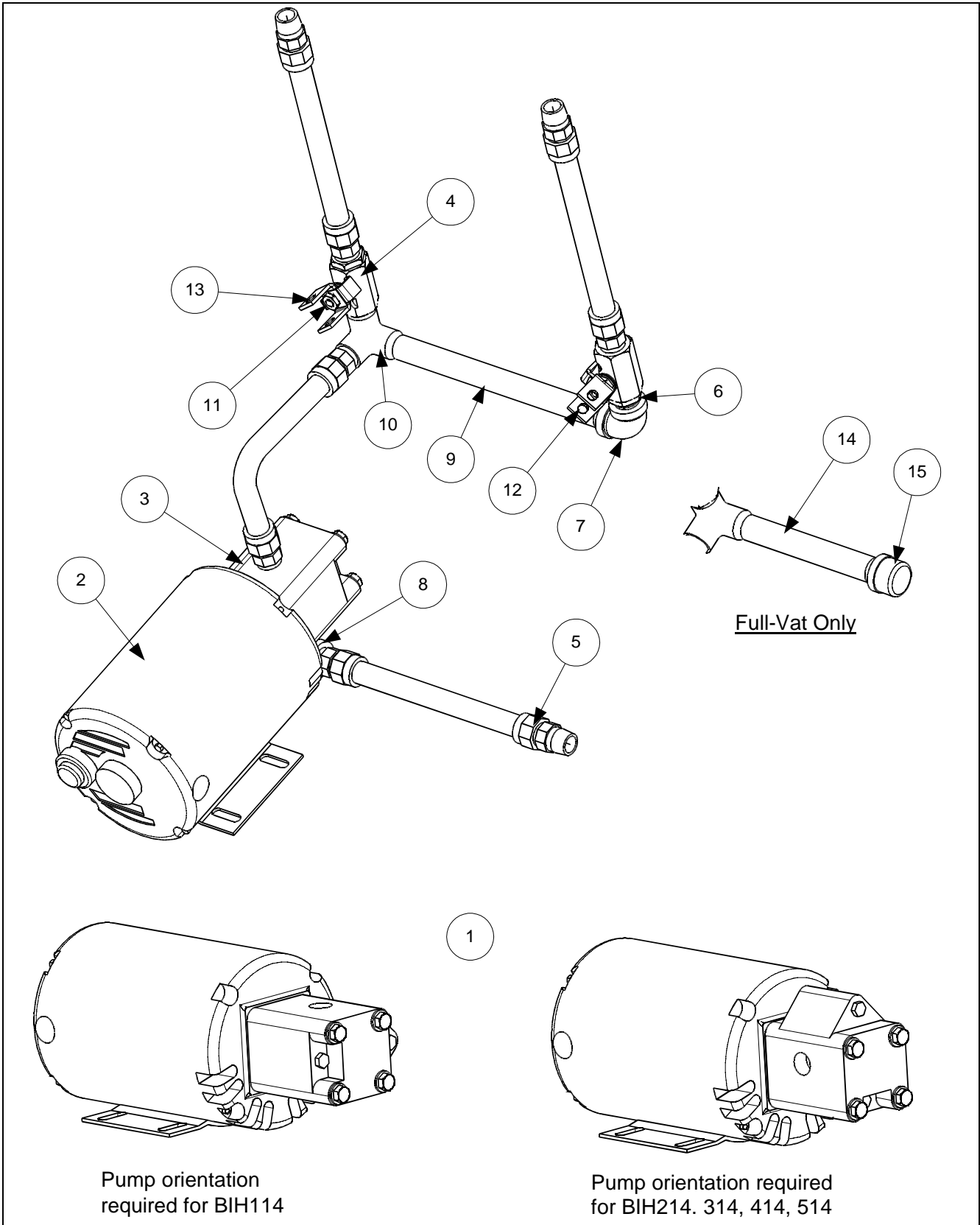

<b>ITEM</b>	<b>PART #</b>	<b>COMPONENT</b>
1	806-6118SP	Pump and Motor Assembly, 250V 50/60 Hz
2	826-1269	Motor and Gasket Kit, 230V 50/60 Hz
*	826-1266	Motor and Gasket Kit, 208V 50/60 Hz
3	807-1995	Pump, Viking 4 GPM
*	809-0514	Cap Screw, 5/16-18 Hex Head
*	809-0194	Washer, Flat 5/16-inch
*	816-0093	Gasket, Pump/Motor
4	810-0278	Gemini Valve without Handle
5	810-1067	Flex Line, Oil Return, 11-inch
6	813-0022	Nipple, 1/2-inch x Close (Dual-Vat Configuration)
7	813-0062	Elbow, 1/2-inch 90 Degree (Dual-Vat Configuration)
8	813-0165	Elbow, 1/2 x 1/2-inch 90 Degree
9	813-0253	Nipple, 1/2 x 10-inch (Dual-Vat Configuration)
10	813-0331	Elbow, 1/2-inch, With Side Outlet
11	900-2935	Nut, Retainer; Oil Return Valve
12	901-2772	Handle, Valve, Rearflush Left (Dual-Vat Configuration)
13	902-2772	Handle, Valve, Rearflush Right
14	813-0098	Nipple, 1/2 x 6.5-inch
15	813-0469	Cap, Pipe 1/2-inch
* Not Illustrated		

## 8.11 Filtration Systems: Oil Return Plumbing and Linkage Assemblies

### 8.11.1 Oil Return Plumbing Assemblies and Components

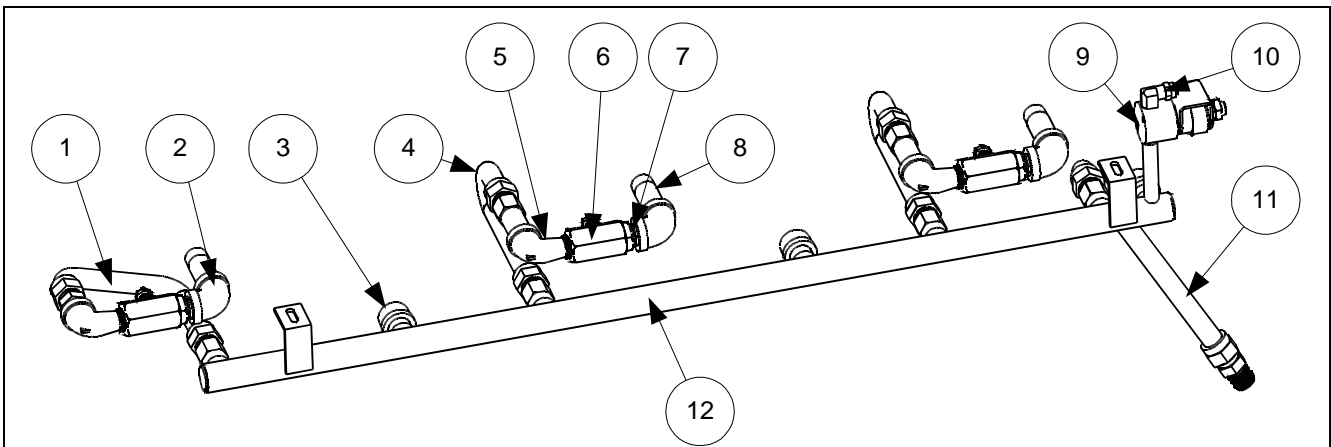

Manifold assembly for all H214, 314 and 414 fryers manufactured after 9/99.  
Multiple-battery fryers of five or more require a special one-piece manifold

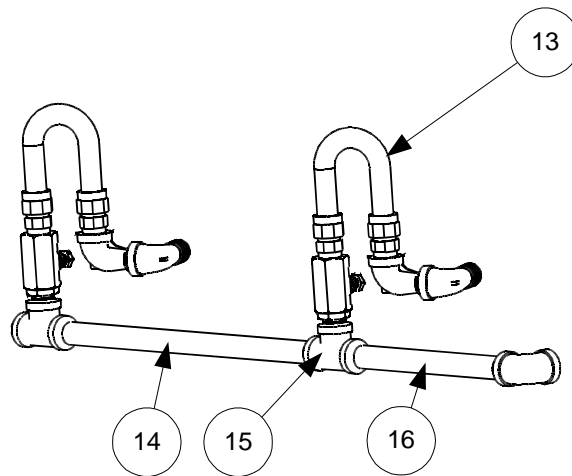

Manifold components for all H214, 314, 414 and 514 fryers  
manufactured before 9/99.

<b>ITEM</b>	<b>PART #</b>	<b>COMPONENT</b>
1	106-0002SP	Flex Line Assembly, With Male/Female Ends
2	813-0062	Elbow, ½-inch 90°
3	813-0469	Cap, Pipe ½-inch
4	106-0054SP	Flex Line Assembly, With Female Ends
5	813-0165	Elbow, Street, ½ x ½-inch 90°
6	810-0278	Gemini Valve, Without Handle
7	813-0022	Nipple, ½-inch Close NPT
8	813-0265	Nipple, ½ x 2.5-inch NPT
9	807-2484	Vent Valve, Solenoid ¼-inch NPT
*	812-1322SP	Vent Tube, Teflon 3/8-inch OD
10	810-1372	Fitting, 90°, ¼-inch NPT: 3/8 Tube
11	806-9439SP	Flex Line Assembly, 14-inch with Male/Female Ends
12	810-1517	Manifold, Oil Return, RF H314/17/22
*	810-1516	Manifold, Oil Return, RF H214/17/22
*	810-1518	Manifold, Oil Return, RF H414/17/22
13	810-1067	Flex Line, Oil Return, 11-inch
14	813-0509	Nipple, ½ x 14.5-inch NPT
15	813-0003	Tee, ½ x ½ x ½-inch
16	813-0275	Nipple, ½ x 9-inch NPT
*	813-0093	Nipple, ½ x 4-inch NPT
* Not Illustrated		

## 8.11.2 Oil Return Linkage Assemblies and Components

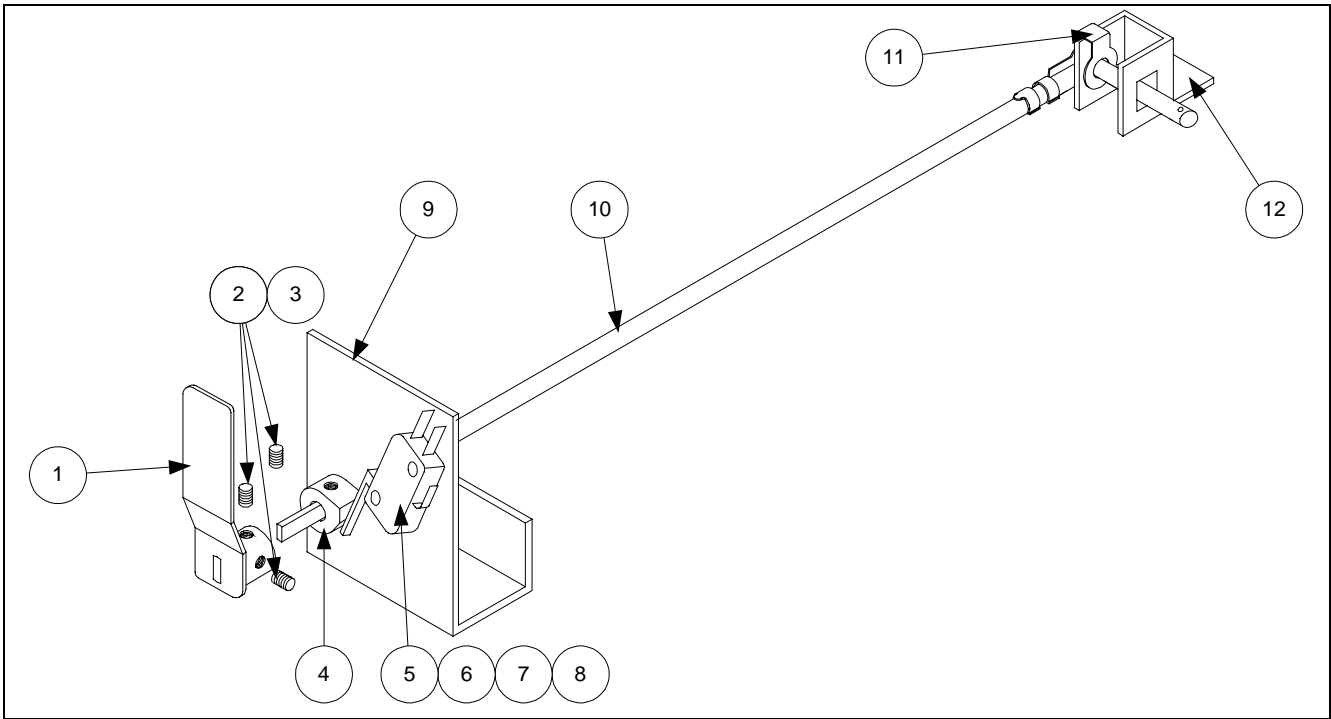

ITEM	PART #	COMPONENT
1	823-2337	Handle, Oil Return, Left
*	823-2338	Handle, Oil Return, Right
2	826-1377	Screw, Set 10-32 x 1/4 (Qty: 25)
3	815-0789	Loctite® Threadlocker 242
4	810-1186	Cam, Microswitch
5	807-2103	Microswitch
6	816-0220	Insulation, Microswitch/Bracket
7	826-1359	Screw, 4-40 x 3/4-inch (Qty: 25)
8	826-1366	Nut, 4-40 Hex with External Tooth (Qty: 25)
9	900-2571	Bracket, Microswitch
10	810-1180	Shaft, Rotating Arm
11	809-0601	Clip, Clevis 5/16-inch
12	901-2772	Handle, Valve, Rear Flush, Left
12	902-2772	Handle, Valve, Rear Flush, Right

\* Not Illustrated

## 8.12 Frypot Assemblies and Drain Valve Components

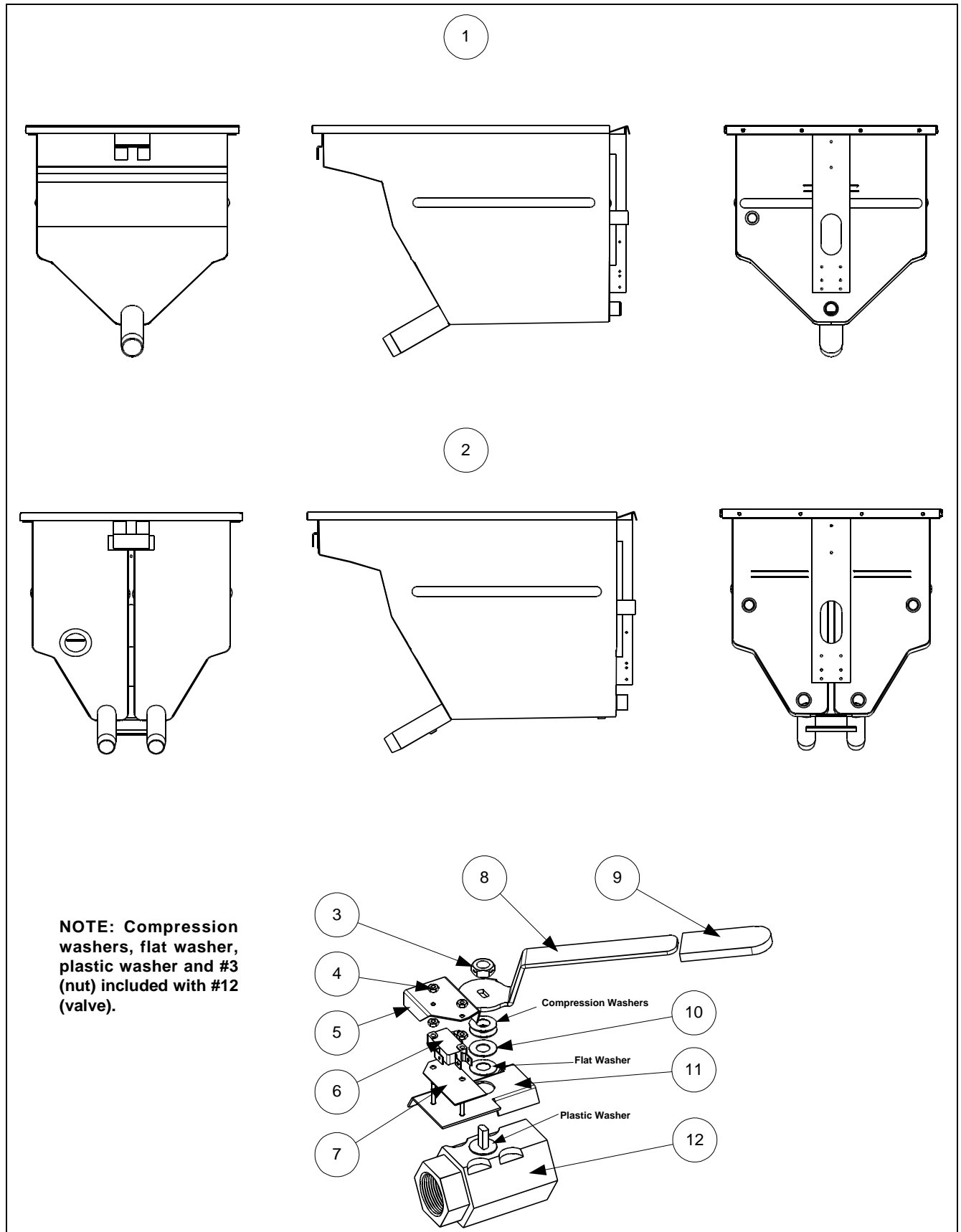

ITEM	PART #	COMPONENT
1	823-2454SP	Frypot Assembly, Full-Vat
2	823-2460SP	Frypot Assembly, Dual-Vat
		Drain Valve Assembly, Dual-Vat
3	809-0539	Nut, 3/8-16 2-Way Lock
4	826-1366	Nut, 4-40 Hex (Qty: 25)
5	901-2348	Cover, Safety Switch, Left DV
*	902-2348	Cover, Safety Switch, Right DV
6	807-2104	Microswitch
7	816-0220	Insulation, Microswitch/Bracket
8	900-2607	Drain Valve Handle, Left DV
*	900-2608	Drain Valve Handle, Right DV
9	814-0047	Sleeve, Valve Handle, Red with Logo
10	810-1165	Washer, Teflon
11	806-8194	Bracket, Microswitch, Left DV
*	806-8195	Bracket, Microswitch, Right DV
12	810-1338	Valve, 1 Inch Universal
*	806-7434SP	Drain Valve Assembly, Full-Vat
		Drain Valve Components, Full-Vat
3	809-0540	Nut, 2-Way Lock
4	826-1366	Nut, 4-40 Hex (Qty: 25)
5	900-2841	Cover, Safety Switch
6	807-2103	Microswitch
7	816-0220	Insulation, Microswitch/Bracket
8	900-2609	Drain Valve Handle
9	814-0047	Sleeve, Valve Handle, Red with Logo
10		<i>Not used on Full-vat Drain Valve Assemblies</i>
11	806-8137	Bracket, Microswitch
12	810-1020	Valve, Gemini 1-1/4-inch
* Not Illustrated		

### 8.13 Thermostats and Related Components

ITEM	PART #	COMPONENT
*	806-8035	High-Limit Thermostat (Dual-vat; Coded Red)
*	806-7543	High-Limit Thermostat (Full-vat; Coded Black)
*	806-8132	High-Limit Thermostat [All European Community (CE); Coded Yellow]
* Not Illustrated		