

Replacement Parts

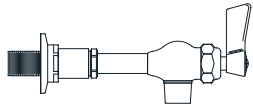

12882
CONTROL VALVE

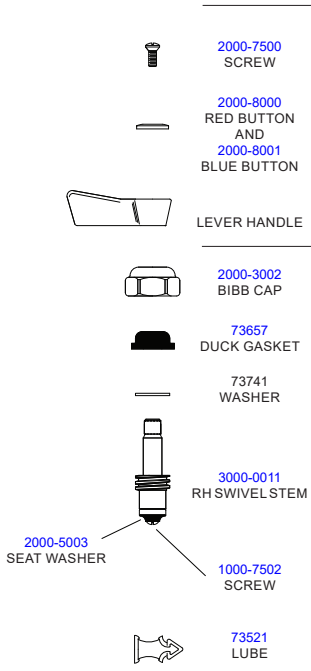

2000-0002
HANDLE LEVER KIT

10022 (36")
SUPPLY LINE
1/2" F X 1/2" F

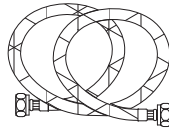

10006 (36")
SUPPLY LINE
1/2" M X 1/2" F

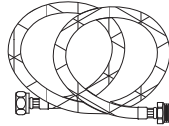

3000-0000
RH SWIVEL STEM
REPAIR KIT



2400-2103
ELBOWS

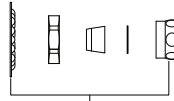

73791
SLIP JOINT KIT

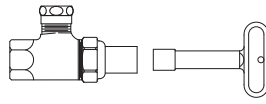

1792
ANGLESTOP
WITH KEY

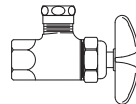

1790-1
ANGLESTOP
W/ CROSS
HANDLES



FAHB-TD-SBSL Product Installation Guide

Since 1936, Fisher Manufacturing Company has manufactured heavy-duty, high quality plumbing products and hardware specialties for the food service industry. For three generations, the Fisher family has adhered to a strict dedication of and overall value. When you install Fisher products... you install the best. Our hardware is manufactured with the standardization of internal mechanisms. All chrome plating is triple plated copper, nickel and chrome for durability. Every piece of equipment we make is rigorously tested in both our modern in-house testing center and in actual field situations under extreme conditions. Every detail is thoroughly checked. Before we make our products available to you, they pass each and every test. You get proven performance. Guaranteed.



Limited One Year Warranty

Fisher Manufacturing Company warrants its products and parts thereof (except as noted below) against defects in materials or workmanship for a period of one year after the date of original purchase. During this period Fisher Manufacturing Company will replace a defective product or part without charge to you, provided that the entire product is delivered to Fisher Manufacturing Company. All transportation and insurance charges for shipping the product to and from Fisher Manufacturing Company must be borne by you. Charges for transportation and insurance may, at the option of Fisher Manufacturing Company, be refunded depending upon our investigation of the warranty claim. This warranty does not cover external finish (except at date of original purchase) or labor costs not specifically authorized by Fisher Manufacturing Company.

#12882 - FAUCET SBSLH FILL 5.00 GPM

A full and complete copy of our One Year limited warranty is available upon request.

Warning: This product can expose you to chemicals including Lead, Nickel (Metallic), Di(2-ethylhexyl) phthalate (DEHP) which are known to the State of California to cause cancer, and Lead, Di(2-ethylhexyl) phthalate (DEHP) which are known to the State of California to cause birth defects or reproductive harm. For more information go to:

www.P65Warnings.ca.gov.

KEEP THIS MANUAL FOR FUTURE REFERENCE



ANSI/A112.18.1M, ANSI/NSF 61.9

FISHER MANUFACTURING COMPANY - TOLL FREE: 800-421-6162 FAX: 800-832-8238

FISHER
MANUFACTURING COMPANY
PO BOX 60, TULARE, CA 93275
(800)421-6162, FAX: (800)832-8238
www.fisher-mfg.com

Installation Instructions for Faucets

BE SURE TO CHECK WITH YOUR LOCAL DEPARTMENT HAVING JURISDICTION REGARDING BACKFLOW PREVENTION

Installation Notes:

- Be sure to shut off water supply before beginning.
- Use pipe thread sealant such as PST on all threaded joints.
- Check the packaging for missing items BEFORE beginning installation. If items are missing, contact your supplier.

Tools Required for Installation

- Medium Sized Crescent Wrench
- Pipe Thread Sealant



Package Contents

The box should contain the following:

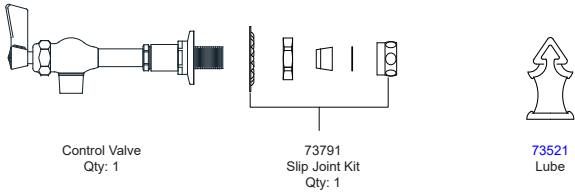

Installation Instructions

1. Mount control valve body to the backsplash by inserting the nipple through the backsplash and tighten the control valve
2. Attach the elbow and supply line as required. Be sure to use pipe thread sealant on all threads.
3. Turn on water supply and check for leaks. Remove the aerator from the control valve and turn on the water and let run for a few seconds, to remove any debris from the control valve. Turn off water and attach the aerator on the control valve.

Step 1

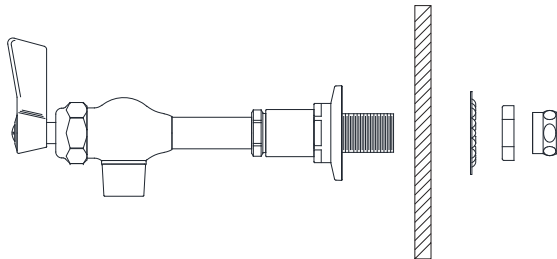

Installation Instructions Continued

Step 2

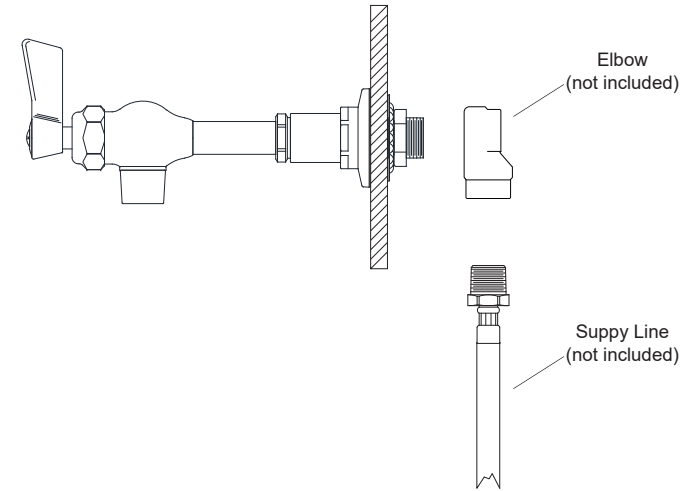

Step 3

