



UNDER COUNTERS, WORKTOPS AND FOOD PREP TABLES REFRIGERATORS AND FREEZERS

Manual for installation, use, and maintenance





CONTENTS

1	RECEIVING AND INSPECTING THE EQUIPMENT	3
2	SPECIFICATIONS.....	4
3	DIMENSIONS.....	7
4	INSTALLATION.....	13
4.1	UNCRATING	13
4.2	LOCATION	13
4.3	DATAPLATE	14
4.4	INSTALLATION OF CASTORS OR OPTIONAL LEGS.....	14
4.5	LEVELING.....	15
4.6	ELECTRICAL CONNECTIONS.....	16
4.7	SHELVING INSTALLATION.....	16
5	OPERATION.....	17
5.1	ELECTRONIC CONTROL.....	17
5.2	OTHER FUNCTIONS	19
6	MAINTENANCE	20
6.1	CLEANING THE CONDENSER COIL.....	20
6.2	GASKET	21
6.3	DOORS/HINGES.....	21
6.4	DRAIN.....	22
7	WIRING DIAGRAMS	23
8	TROUBLE SHOOTING	27
9	WARRANTY	28



1 RECEIVING AND INSPECTING THE EQUIPMENT

Up on receiving your new Fagor Refrigerator, check the package and the machine for any damages that may have occurred during transportation. Visually inspect the exterior of the package. If damaged, open and inspect the contents with the carrier. Any damage should be noted and reported on the delivering carrier's receipt.

In the event that the exterior is not damaged, yet up on opening, there is concealed damage to the equipment notify, the carrier immediately. Notification should be made verbally as well as in written form. Request an inspection by the shipping company of the damaged equipment. Retain all crating material until inspection has been made. Contact the dealer through which you purchased the unit.

Check the compressor compartment housing and visually inspect the refrigeration package. Be sure lines are secure and base is still intact.

A NOTE FROM OUR QUALITY CONTROL MANAGER

CONGRATULATIONS ON YOUR NEW PURCHASE. WE WOULD LIKE TO WELCOME YOU TO THE FAGOR TEAM. THE UNIT IN FRONT OF YOU IS A GREAT PIECE OF EQUIPMENT THAT WILL BECOME ONE OF YOUR MOST RELIABLE TOOLS IN YOUR DAILY OPERATIONS FOR YEARS TO COME!

PRIOR TO SHIPPING YOUR UNIT, OUR TRAINED SERVICE TECHNICIANS TESTED YOUR UNIT FOR A PERIOD OF 12 HOURS. THIS PERFORMANCE TEST WAS RECORDED AND A COPY OF THE RESULTS IS INCLUDED WITH THIS SERVICE MANUAL. DURING THIS TEST, OUR HIGHLY QUALIFIED PERSONNEL INSPECTED YOUR MACHINE FOR LEAKS, LOSE COMPONENTS, AND IMPROPER NOISE LEVELS. WE ALSO TESTED THE COOLING PERFORMANCE IN AN EFFORT TO GIVE YOU THE BEST AND MOST RELIABLE UNIT POSSIBLE.



2 SPECIFICATIONS

TABLES REFRIGERATOR AND FREEZER											
MODEL	Capa. (Cu.Ft.)	Top Pans	Shlvs.	Temperature Operation		Pressure in Suction Line*	NEMA PLUG	BTU	Oz.	Ref.	Ship Weight
				Set Point	Cut in						
FU/WR-27	6.1	-	2	-2°C / 28°F	-4°C a 1°C (25°F a 36°F)	10-16 PSIG	5-15P	1449	8.5	R-134a	204
FU/WR-48	11.8	-	4	-2°C / 28°F	-4°C a 1°C (25°F a 36°F)	10-16 PSIG	5-15P	1666	9.8	R-134a	289
FU/WR-60	15	-	4	-2°C / 28°F	-4°C a 1°C (25°F a 36°F)	10-16 PSIG	5-15P	2104	10.6	R-134a	343
FU/WR-72	18.2	-	6	-2°C / 28°F	-4°C a 1°C (25°F a 36°F)	10-16 PSIG	5-15P	2104	10.6	R-134a	413
FU/WF-27	6.1	-	2	-20°C (-4°F)	-18°C / -0°F	12-16 PSIG	5-15P	2493	9.5	R-404A	204
FU/WF-48	11.8	-	4	-20°C (-4°F)	-18°C / -0°F	12-16 PSIG	5-15P	2493	19.4	R-404A	289
FU/WF-60	15	-	4	-20°C (-4°F)	-18°C / -0°F	12-16 PSIG	5-15P	2493	19.4	R-404A	343
FST-27-8	-	8	1	-2°C / 28°F	-4°C a 1°C (25°F a 36°F)	10-16 PSIG	5-15P	1449	8.5	R-134a	214
FST-48-8	-	8	2	-2°C / 28°F	-4°C a 1°C (25°F a 36°F)	10-16 PSIG	5-15P	1666	9.8	R-134a	305
FST-48-12	-	12	2	-2°C / 28°F	-4°C a 1°C (25°F a 36°F)	10-16 PSIG	5-15P	1666	9.8	R-134a	305
FST-60-8	-	8	2	-2°C / 28°F	-4°C a 1°C (25°F a 36°F)	10-16 PSIG	5-15P	2104	10.6	R-134a	370
FST-60-16	-	16	2	-2°C / 28°F	-4°C a 1°C (25°F a 36°F)	10-16 PSIG	5-15P	2104	10.6	R-134a	370
FST-72-12	-	12	3	-2°C / 28°F	-4°C a 1°C (25°F a 36°F)	10-16 PSIG	5-15P	2104	10.6	R-134a	455
FST-72-18	-	18	3	-2°C / 28°F	-4°C a 1°C (25°F a 36°F)	10-16 PSIG	5-15P	2104	10.6	R-134a	455
FMT-27-12	-	12	1	-2°C / 28°F	-4°C a 1°C (25°F a 36°F)	10-16 PSIG	5-15P	1449	8.5	R-134a	255
FMT-48-18	-	18	2	-2°C / 28°F	-4°C a 1°C (25°F a 36°F)	10-16 PSIG	5-15P	1666	9.8	R-134a	327
FMT-60-24	-	24	2	-2°C / 28°F	-4°C a 1°C (25°F a 36°F)	10-16 PSIG	5-15P	2104	10.6	R-134a	380
FMT-72-30	-	30	3	-2°C / 28°F	-4°C a 1°C (25°F a 36°F)	10-16 PSIG	5-15P	2104	10.6	R-134a	465
SUR-46	14.6	-	2	-2°C / 28°F	-4°C a 1°C (25°F a 36°F)	10-16 PSIG	5-15P	1666	9.8	R-134a	318
SUR-67	18.7	-	4	-2°C / 28°F	-4°C a 1°C (25°F a 36°F)	10-16 PSIG	5-15P	2104	10.6	R-134a	490
FPT-46	15.4	6	2	-22°C / -8°F	-4°C a 1°C (25°F a 36°F)	10-16 PSIG	5-15P	1666	10.6	R-134a	318
FPT-67	26	9	4	-22°C / -8°F	-4°C a 1°C (25°F a 36°F)	10-16 PSIG	5-15P	2104	10.6	R-134a	490

Note:

* The pressure in the suction line is recommended at 32°C/90°F maximum of ambient temperature.



UNDERCOUNTERS,WORKTOPSAND FOODPREPTABLESREFRIGERATORSANDFREEZERS,ELECTRICAL SPECS											
MODEL	AMPS	HP	VOLTAGE	NEMA Plug	BREAKER Size*	Wiregagerecommendedfor2%voltage drop insupplycircuits**					
						40ft ***	60ft	80ft	100ft	120ft	140ft
FU/WR-27	2.7	1/6	115	5-15P	15amp	14AWG	14AWG	12AWG	12AWG	12AWG	10AWG
FU/WR-48	5.4	1/4	115	5-15P	15amp	14AWG	14AWG	12AWG	12AWG	12AWG	10AWG
FU/WR-60	6.7	1/3	115	5-15P	15amp	14AWG	12AWG	12AWG	10AWG	10AWG	10AWG
FU/WR-72	6.7	1/3	115	5-15P	15amp	14AWG	12AWG	12AWG	10AWG	10AWG	10AWG
FU/WF-27	8.2	3/4	115	5-15P	15amp	14AWG	12AWG	10AWG	10AWG	8AWG	8AWG
FU/WF-48	8.5	3/4	115	5-15P	15amp	14AWG	12AWG	10AWG	10AWG	8AWG	8AWG
FU/WF-60	8.5	3/4	115	5-15P	15amp	14AWG	12AWG	10AWG	10AWG	8AWG	8AWG
FST-27-8	2.7	1/6	115	5-15P	15amp	14AWG	14AWG	12AWG	12AWG	12AWG	10AWG
FST-48-8	5.4	1/4	115	5-15P	15amp	14AWG	14AWG	12AWG	12AWG	12AWG	10AWG
FST-48-12	5.4	1/4	115	5-15P	15amp	14AWG	14AWG	12AWG	12AWG	12AWG	10AWG
FST-60-16	6.7	1/3	115	5-15P	15amp	14AWG	12AWG	12AWG	10AWG	10AWG	10AWG
FST-72-18	6.2	1/3	115	5-15P	15amp	14AWG	12AWG	12AWG	10AWG	10AWG	10AWG
FMT-27-12	2.7	1/6	115	5-15P	15amp	14AWG	14AWG	12AWG	12AWG	12AWG	10AWG
FMT-48-18	5.4	1/4	115	5-15P	15amp	14AWG	14AWG	12AWG	12AWG	12AWG	10AWG
FMT-60-24	6.7	1/3	115	5-15P	15amp	14AWG	12AWG	12AWG	10AWG	10AWG	10AWG
FMT-72-30	6.2	1/3	115	5-15P	15amp	14AWG	12AWG	12AWG	10AWG	10AWG	10AWG
SUR-46	5.4	1/4	115	5-15P	15amp	14AWG	12AWG	12AWG	10AWG	10AWG	10AWG
SUR-67	6.7	1/3	115	5-15P	15amp	14AWG	12AWG	12AWG	10AWG	10AWG	10AWG
FPT-46	5.1	1/4	115	5-15P	15amp	14AWG	12AWG	12AWG	10AWG	10AWG	10AWG
FPT-67	6.5	1/3	115	5-15P	15amp	14AWG	12AWG	12AWG	10AWG	10AWG	10AWG

Note:

* Breaker sizes are recommended to protect the equipment by overload; this breaker only must be dedicated for the equipment.

** If the equipment is installed faraway of the circuit breaker, these are the wire gauge recommend to connect the appliance; if the distance is higher that the chart values, please contact an electrician.

*** Distance in feet from the breaker or the power supply to the appliance.



UNDERCOUNTERS, WORKTOPS AND FOOD PREP TABLES REFRIGERATORS AND FREEZERS, ELECTRICAL SPECS											
MODEL	AMPS	HP	VOLTAGE	NEMA Plug	BREAKER Size*	Wire gauge recommended for 2% voltage drop in supply circuits**					
						40ft ***	60ft	80ft	100ft	120ft	140ft
FU/WR-27	2.1	1/4	220	2P+TT	15amp	14AWG	14AWG	12AWG	12AWG	12AWG	10AWG
FU/WR-48	2.8	1/4	220	2P+TT	15amp	14AWG	14AWG	12AWG	12AWG	12AWG	10AWG
FU/WR-60	3.5	3/8	220	2P+TT	15amp	14AWG	12AWG	12AWG	10AWG	10AWG	10AWG
FU/WR-72	3.2	3/8	220	2P+TT	15amp	14AWG	12AWG	12AWG	10AWG	10AWG	10AWG
FST-27-8	2.1	1/4	220	2P+TT	15amp	14AWG	14AWG	12AWG	12AWG	12AWG	10AWG
FST-48-8	2.8	1/4	220	2P+TT	15amp	14AWG	14AWG	12AWG	12AWG	12AWG	10AWG
FST-48-12	2.8	1/4	220	2P+TT	15amp	14AWG	14AWG	12AWG	12AWG	12AWG	10AWG
FST-60-16	3.5	3/8	220	2P+TT	15amp	14AWG	12AWG	12AWG	10AWG	10AWG	10AWG
FST-72-18	3.2	3/8	220	2P+TT	15amp	14AWG	12AWG	12AWG	10AWG	10AWG	10AWG
FMT-27-12	2.1	1/4	220	2P+TT	15amp	14AWG	14AWG	12AWG	12AWG	12AWG	10AWG
FMT-48-18	2.8	1/4	220	2P+TT	15amp	14AWG	14AWG	12AWG	12AWG	12AWG	10AWG
FMT-60-24	3.5	3/8	220	2P+TT	15amp	14AWG	12AWG	12AWG	10AWG	10AWG	10AWG
FMT-72-30	3.2	3/8	220	2P+TT	15amp	14AWG	12AWG	12AWG	10AWG	10AWG	10AWG
SUR-46	2.8	1/4	220	2P+TT	15amp	14AWG	12AWG	12AWG	10AWG	10AWG	10AWG
SUR-67	3.5	3/8	220	2P+TT	15amp	14AWG	12AWG	12AWG	10AWG	10AWG	10AWG
FPT-46	2.5	1/4	220	2P+TT	15amp	14AWG	12AWG	12AWG	10AWG	10AWG	10AWG
FPT-67	3.5	3/8	220	2P+TT	15amp	14AWG	12AWG	12AWG	10AWG	10AWG	10AWG

Note:

* Breaker sizes are recommended to protect the equipment by overload; this breaker only must be dedicated for the equipment.

** If the equipment is installed faraway of the circuit breaker, these are the wire gauge recommend to connect the appliance; if the distance is higher that the chart values, please contact an electrician.

*** Distance in feet from the breaker or the power supply to the appliance.



3 DIMENSIONS

Under Counters

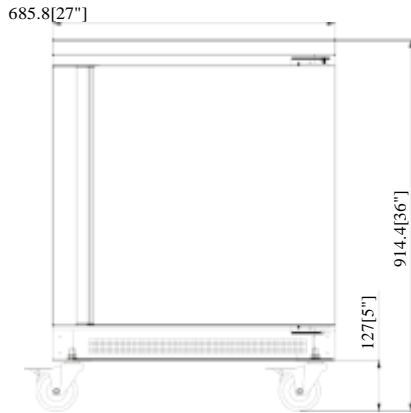

FRONTVIEW
FUR/FUF-27

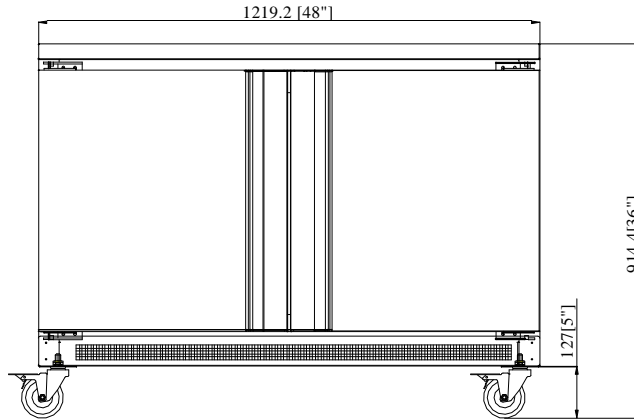

FRONTVIEW
FUR/FUF-48

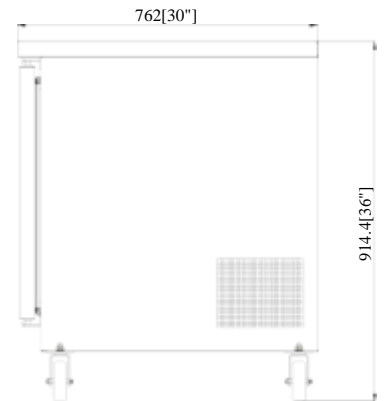

SIDEVIEW
FOR ALLSIZES

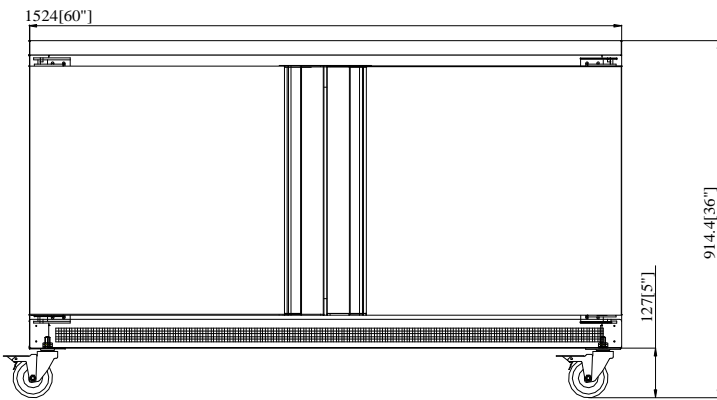

FRONTVIEW
FUR/FUF-60

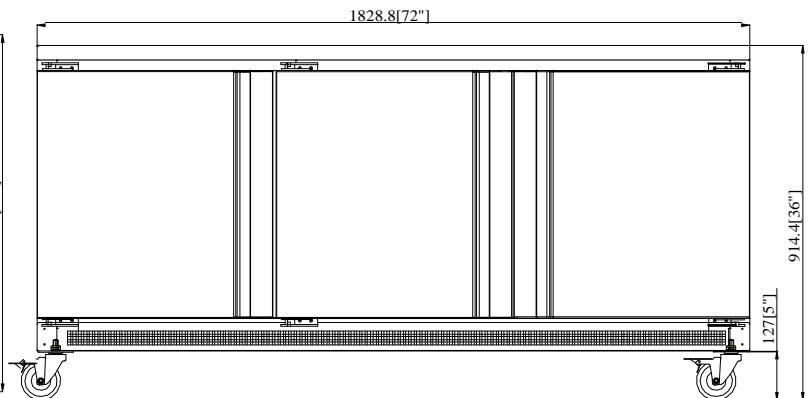

FRONTVIEW
FUR-72



Worktops

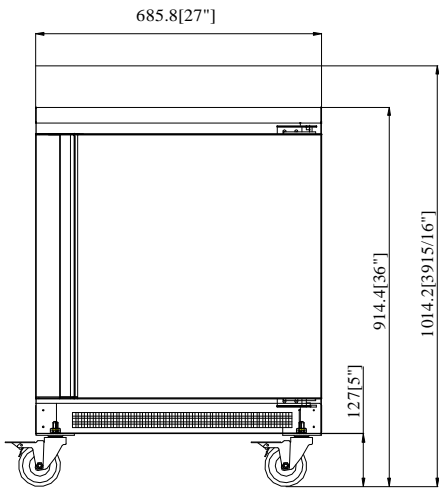

FRONTVIEW
FWR/FWF-27

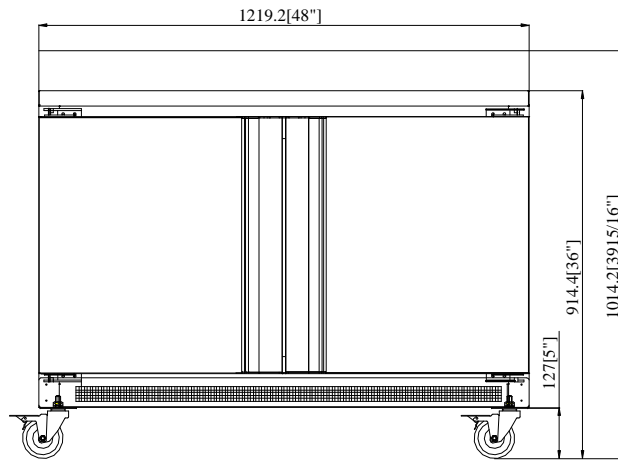

FRONTVIEW
FWR/FWF-48

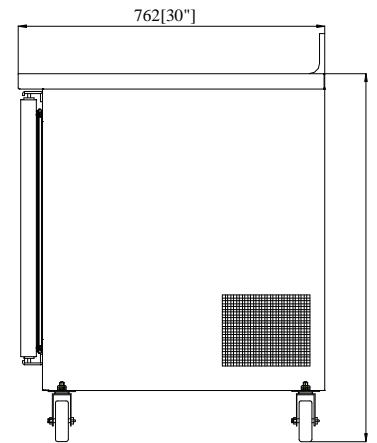

SIDEVIEW
FOR ALLSIZES

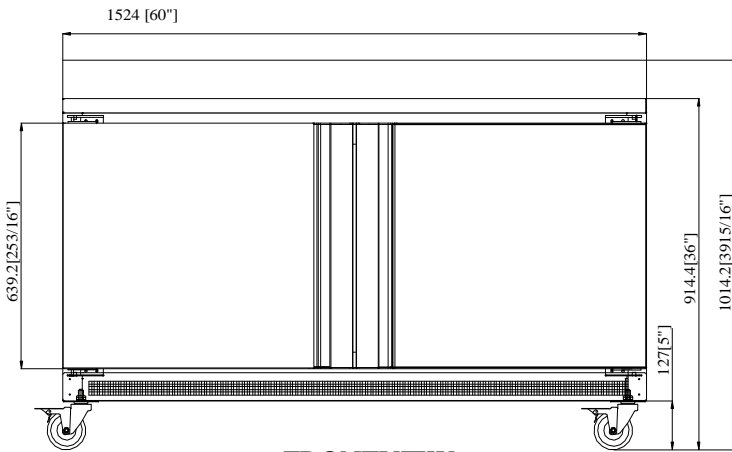

FRONTVIEW
FWR/FWF-60

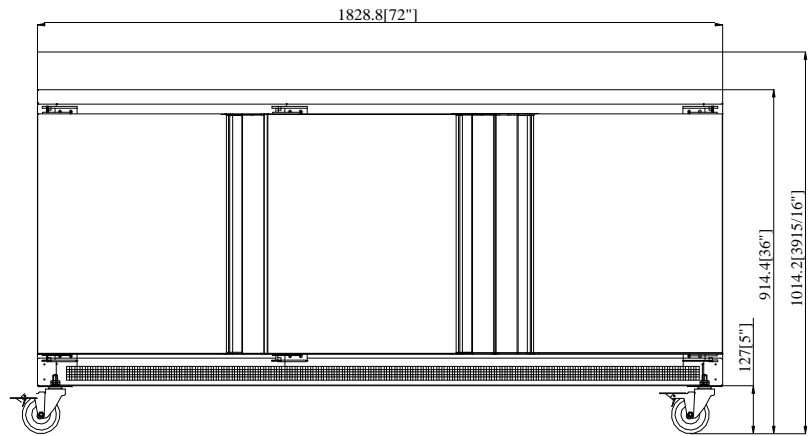

FRONTVIEW
FWR-72



Salad Tables

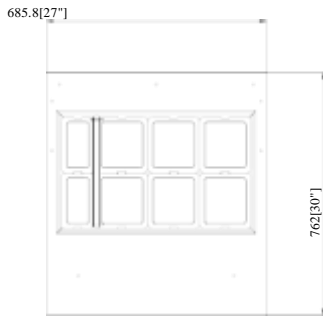

TOPVIEW FST-27-8

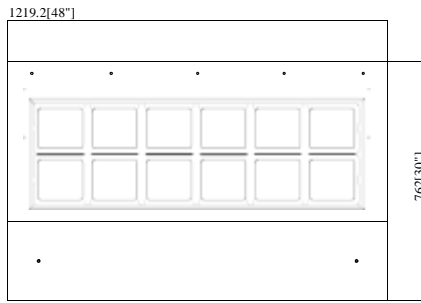

TOPVIEW
FST-48-12

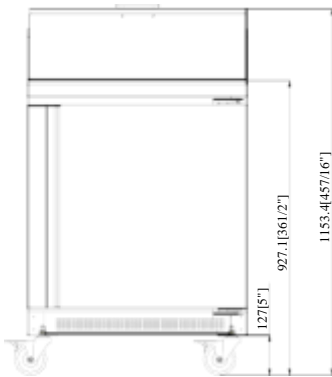

FRONTVIEW
FST-27-8

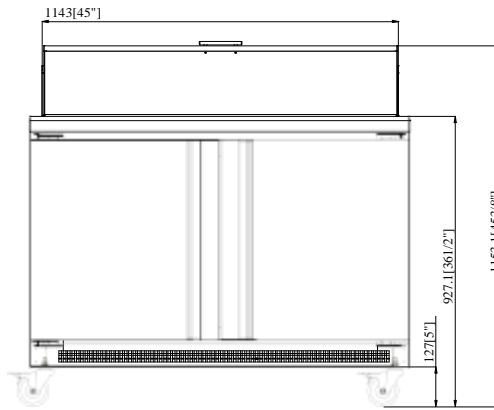

FRONTVIEW
FST-48-12

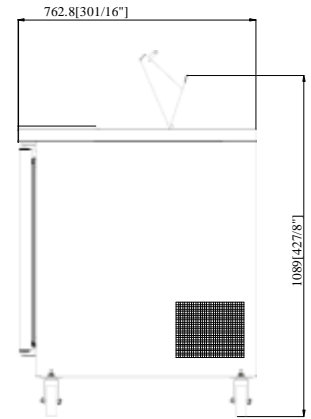

SIDEVIEW FOR
ALLSIZES

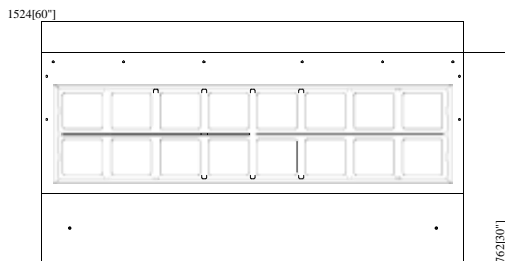

TOPVIEW FST-60-16

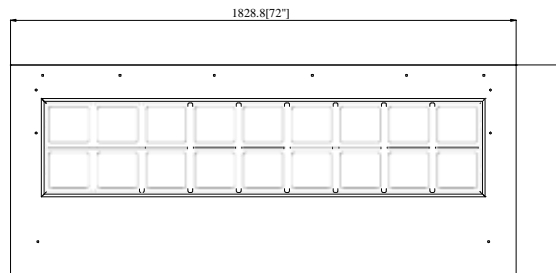

TOPVIEW FST-72-18

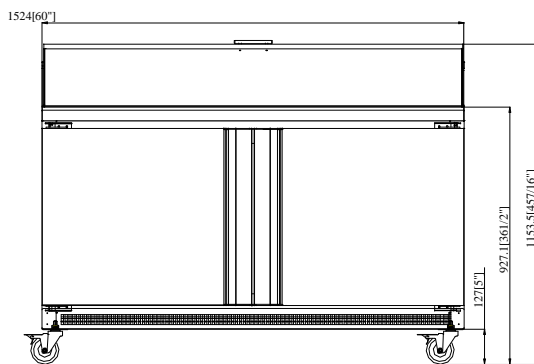

FRONTVIEW
FST-60-16

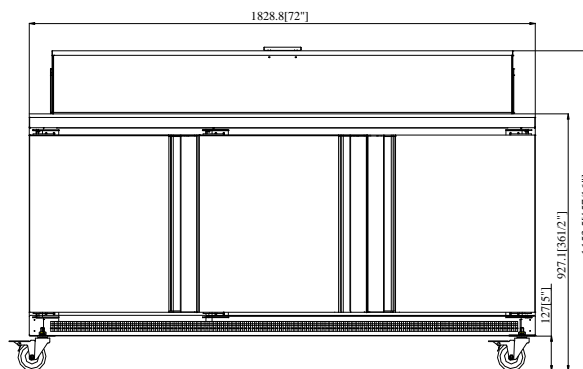

FRONTVIEW
FST-72-18



Mega top Tables

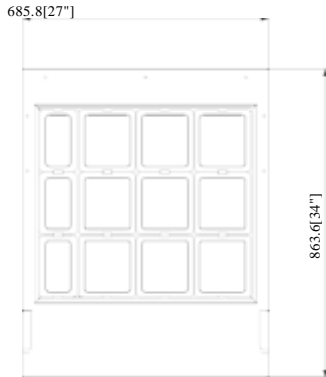

TOPVIEW
FMT-27-12

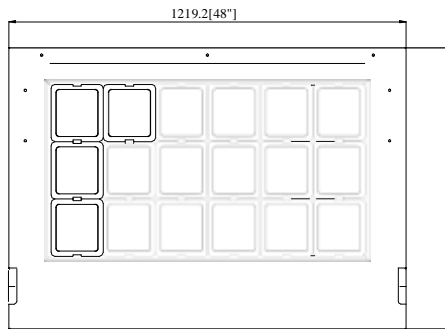

TOPVIEW
FMT-48-18

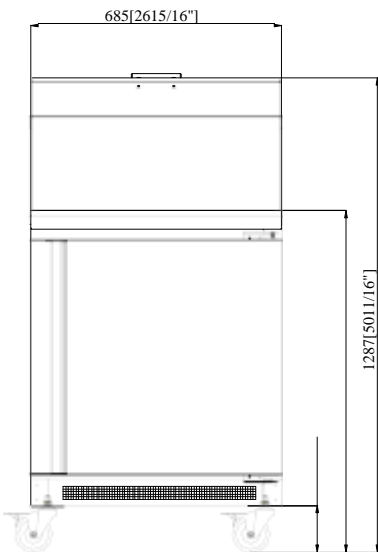

FRONTVIEW
FMT-27-12

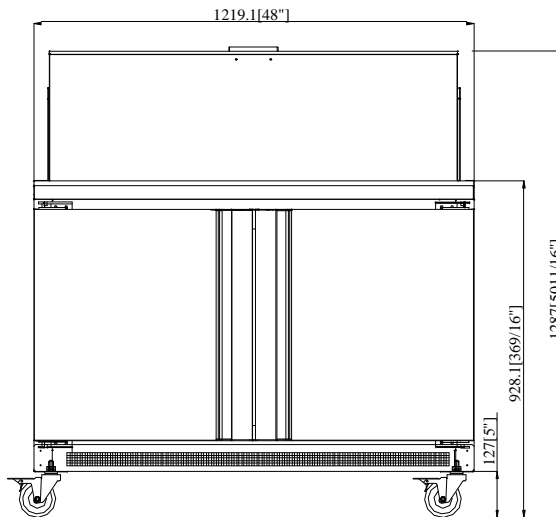

FRONTVIEW
FMT-48-18

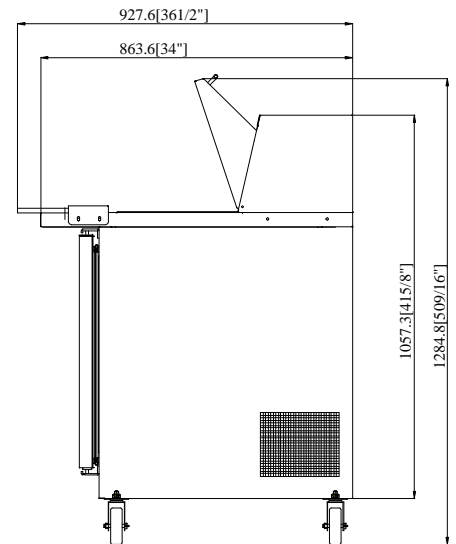

SIDEVIEW
FOR ALLSIZES



Mega top Tables (continuation)

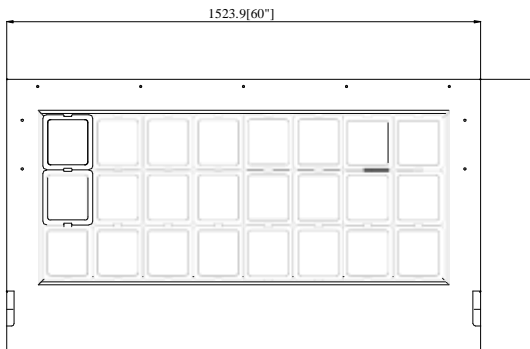

TOPVIEW
FMT-60-24

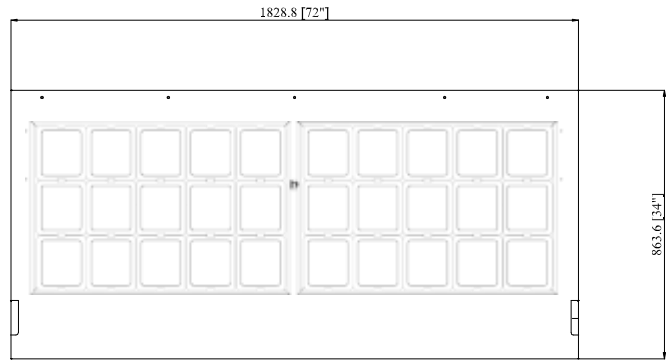

TOPVIEW
FMT-72-30

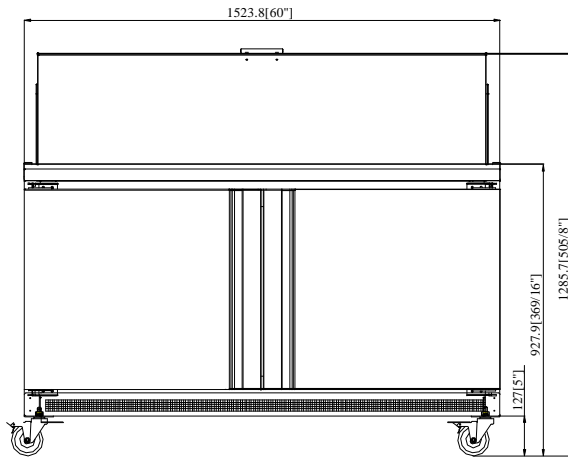

FRONTVIEW
FMT-60-24

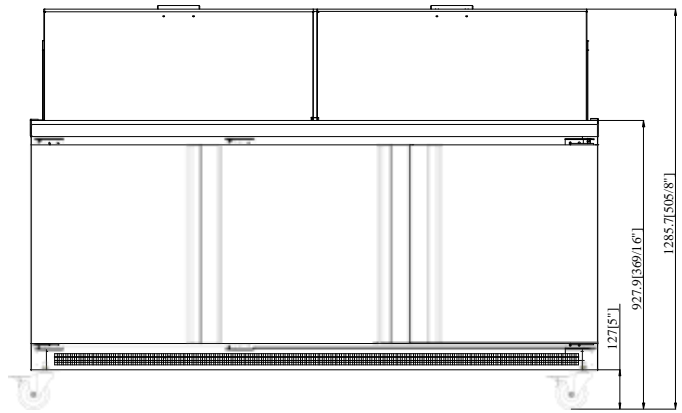

FRONTVIEW
FMT-72-30



Pizza Tables

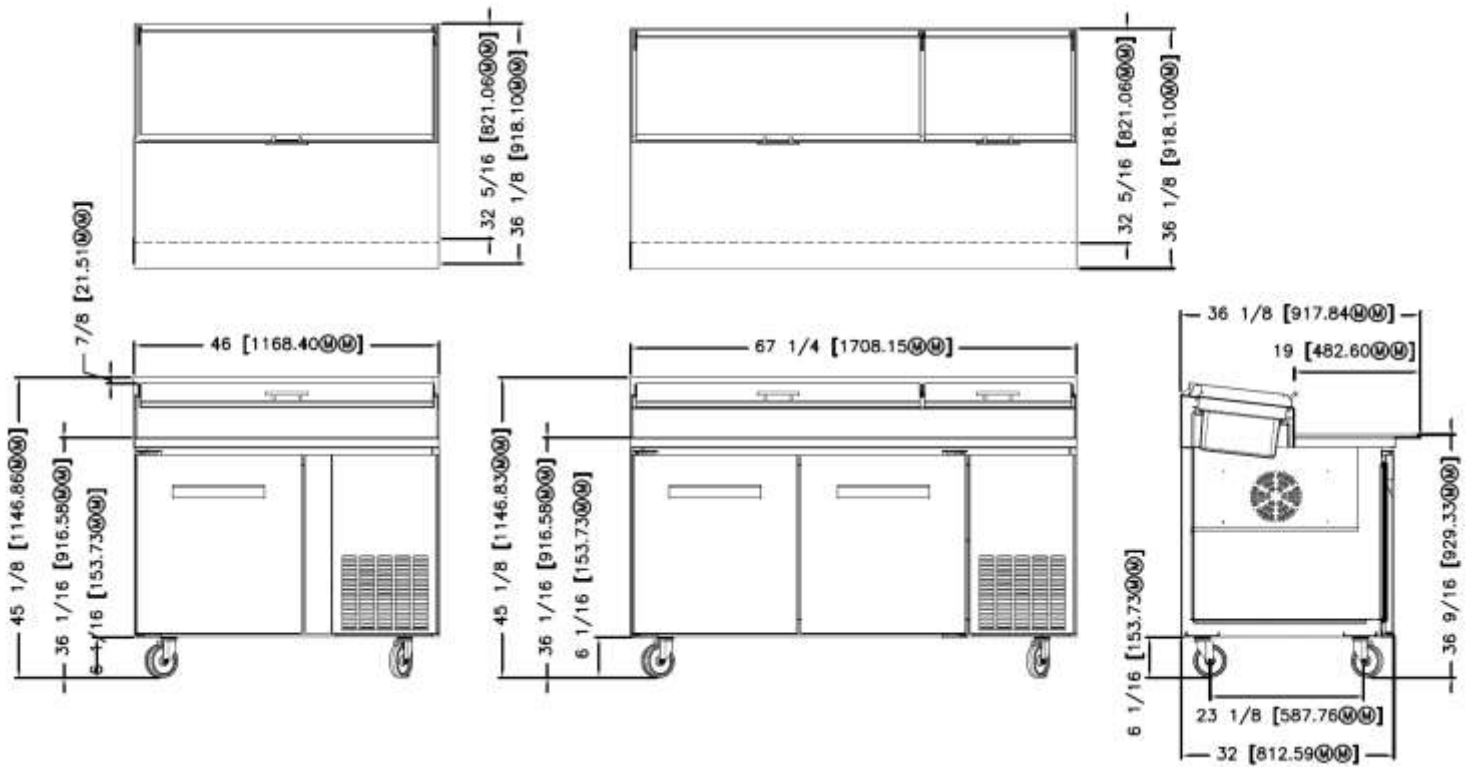

Sur Tables

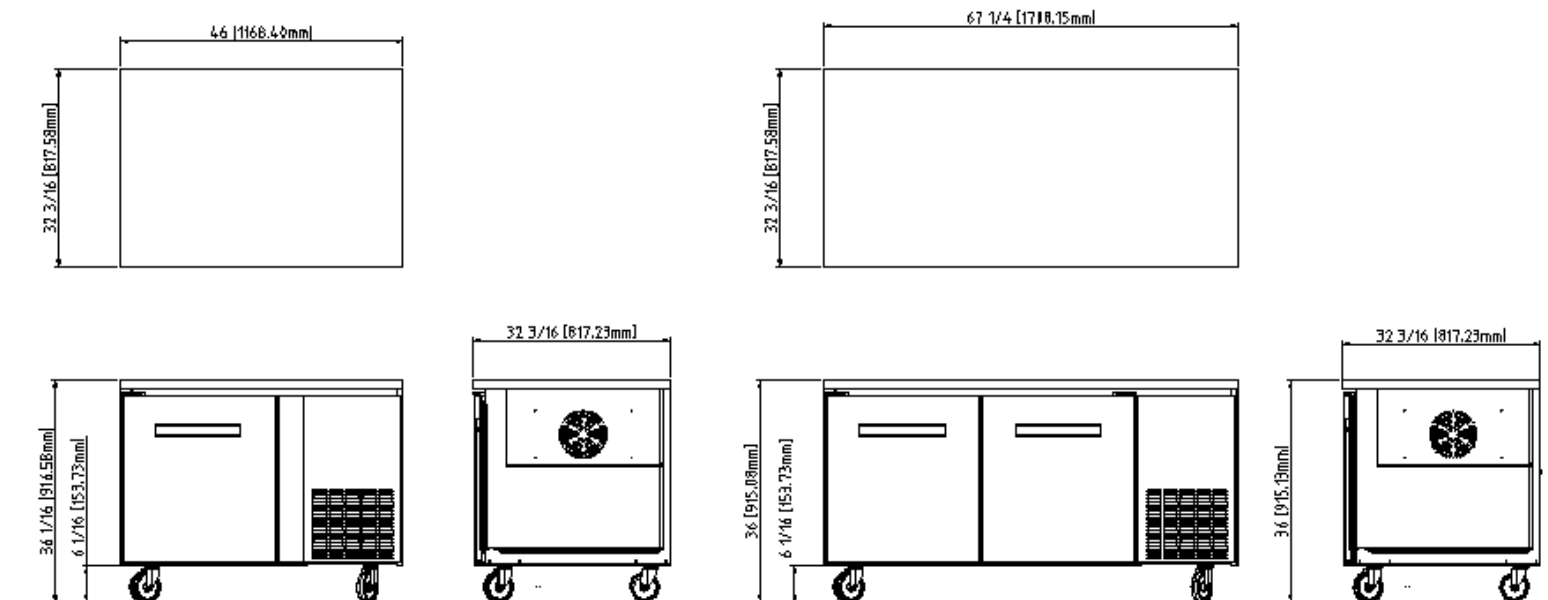



4 INSTALLATION

4.1 UNCRATING

Remove the outer packaging. **Cut the 4 clamps that hold the refrigerator to the skid. Lift the unit off the skid.**

If machine was laid down during this operation, remember to leave the cabinet up right for 24 hours before connecting to power source.

4.2 LOCATION

Units represented in this manual are intended for indoor use only. Be sure the location chosen has a floor strong enough to support the total weight of the unit and its contents. For the most efficient operation, be sure to provide at least three (3) inches between sides, back and top of the unit.

The unit should not be installed under ambient temperatures higher than 100 °F. If the relative humidity is higher than 60 %, the door frames may sweat water. This is not a malfunctioning of the unit.



THE MACHINES NEEDS TO BE INSTALLED 2 FEET AWAY FROM ANY HEAT SOURCES.

WARNING

The following actions will void your warranty:

- Modification of power cord.**
- Connecting the unit to any extension cord.**
- Neglecting to install the castors or optional legs.**

Inside cabinet

The first cleaning must happen when you unpack the unit and before it is turned ON. For this, you have to clean the unit with warm water and mild detergent. When it is cleaned and dry, proceed to install accessories and plug your unit in to a dedicated outlet. **WAIT 24 HOURS BEFORE PLACING PRODUCT IN THE UNIT.** This will guarantee that it is working properly. **Consequential damages are not covered under warranty.**

Outside cabinet:

Be sure that the unit has access to ample air to breathe. Avoid hot corners and locations near stoves and ovens. It is recommended the unit be installed no closer than 3" from any wall. The place where the refrigerator is placed must be open and clean. This will reduce the amount of debris and dirt on the condenser fan and coil.



4.3 DATAPLATE

The data plate is located inside the cabinet, near the top front, left corner. Under no circumstances should the data plate be removed from the unit. The data plate is essential to identify the particular features of your machine and it is of great benefit to installers, operators, and maintenance personnel. It is recommended that, in the event the data plate is removed, you copy down the essential information in this manual for reference before installation. Removal of data plate will void the warranty.



4.4 INSTALLATION OF CASTORS OR OPTIONAL LEGS

To obtain maximum strength and stability of the unit, be sure that castors are secure and unit is level. Inside the unit you will find a Castor kit which includes: four castor wheels, leveling shims, and assembly tool.

Installation of castors:

- 1) Cut the 4 straps that hold the refrigerator to the pallet.
- 2) Slide out unit until castor holes are exposed. CASTORS WITH BRAKES MUST BE INSTALLED IN THE FRONT OF THE UNIT
- 3) Carefully, lift the unit high enough to install the casters.
- 4) Repeat the same operation to install the remaining castors.

CAUTION! NEVER LAY MACHINE ON ITS BACK! IF NEEDED, LEAVE THE CABINET UP RIGHT FOR 24 HOURS BEFORE CONNECTING TO POWER SOURCE. TO AVOID DAMAGE TO LOWER FRAME, SLOWLY RAISE UNIT TO UP RIGHT POSITION



FAILURE TO MEET THIS REQUIREMENT CAN CAUSE COMPRESSOR FAILURE AND UNIT DAMAGE. THIS WILL NOT BE COVERED UNDER WARRANTY!

- 6) For leveling, insert shims between the castor and the frame rail. Install the desired number of shims. Make sure the slot of the shim is in contact with the threaded stem of the castor.FIG.2
- 7) If more than one shim is used, turn the slot of the shim approximately 90 angles. **If shims are installed in line, they may slip out.**
- 8) Turn the bearing race clockwise to tighten and secure the castor. Use provided tool to secure all castors properly. FIG.3



FIG.1



FIG.2



FIG.3

Optional legs are hand-tightened. Thread leg into cabinet bottom frame rail. The end of the leg is adjustable for easy leveling.

Caution! To avoid damage to lower rail assembly, slowly raise unit to up right position

Caution! When lifting unit remember to leave the cabinet up right for 24 hours before plugging in to power source. Failure to meet this requirement can cause compressor failure and unit damage.

4.5 LEVELING

Set unit in its final location. A level cabinet looks better and will perform better. Effective condensate removal and door operation will be effected by leveling. Machine must be leveled front to back and side to side with a level tool. Castors kit will include shims for leveling. Insert the shim between the castor and the frame rail. (See installation of castors). Lock front castors so cabinet does not move. Ensure drain hose is inside drain pan.



4.6 ELECTRICAL CONNECTIONS

Refer to the amperage data in this manual, or on data plate, and your local code or the National Electrical Code to be sure unit is connected to the proper power source. Verify correct incoming voltage according to the Data Plate information.

Do not, under any circumstances, cut or remove the ground prong from the power cord. Fagor units must be properly grounded.

NEVER USE AN EXTENSION CORD! Fagor will not warranty any unit that has been connected to an extension cord.

Fagor equipment must be grounded and connected in accordance with NEC Article 422 Appliances.



DANGER: Power must be turned off and disconnected from the power source whenever performing maintenance, repair or cleaning the condensing unit. If machine is still running when power is off, disconnect power at the circuit breaker before unplugging the machine.



WARNING: Machine and compressor warranties are void if failure is due to improper electrical installation.

4.7 SHELVING INSTALLATION

- 5) Hook shelf rails onto shelf pilasters
- 6) Position all shelf rails equal in distance from the floor for level shelves
- 7) Wire shelves are oriented so that cross support bars are facing down

Note: Single door Reach-ins include an air flow guard on the rear of the shelves as well as a lip to maintain an air space at the rear of the cabinet

- 8) Place shelves on shelf clips, making sure all corners are seated properly



5 OPERATION

5.1 ELECTRONIC CONTROL

After connecting your unit, turn ON rocker switch located next to the controller. The display will light up showing the temperature inside the unit. Also, the compressor and fan icons will flash for a period of three minutes. After this delay the unit will start cooling.

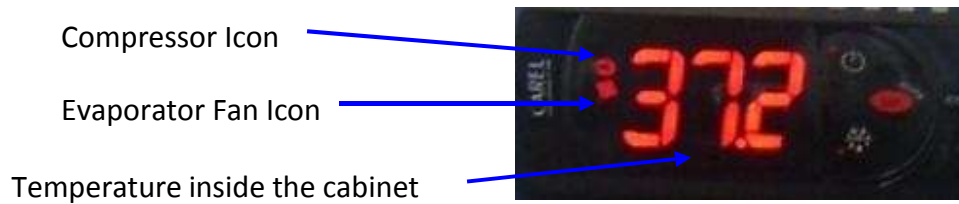

Verify you don't have any alarms on the temperature controller. If after you turn ON the equipment the controller shows the alarm icon or an error code, call for technical service. They will help you fix the problem.

Note: The controller on the equipment is programmed to display internal temperatures in Fahrenheit (°F). To change to Celsius (°C), see point 4.2.

Description of Buttons on the Controller



To increase Set Point of Temperature
To turn the unit ON/OFF without unplugging the equipment (press and hold 3 seconds)

To Change the set point
To access programming mode

To decrease Set Point of Temperature
To set a manual defrost (press and hold 3 seconds)

Changing the Set Point of the temperature on the controller

The unit comes with a factory default set point (-8°F Freezers, 32°F Refrigerators). These set values will make the unit perform at its maximum capacity. Therefore, it is not recommended to change the set point. If set point needs to be changed, follow the next steps.

Note:

If you change the set point of temperature, the performance of the equipment will change. Changes made in the parameters of the controller **will not be covered under warranty.**



1. Push the SET button for one (1) second. You should see a flashing number. Release the button.

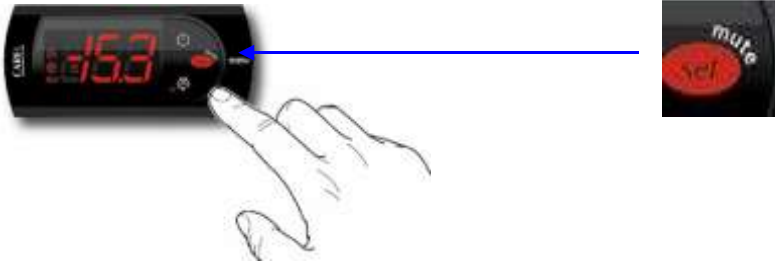

2. Press the up and down arrows to increase or decrease the set temperature. Then press the set button to save the new set point.



Note:

The maximum value you can set in the controller is:
 For Refrigerators: 5°C (40°F), For freezers: -16°C(2°F)

3. If you wish decrease the value of the set point for a new temperature, press the button DOWN arrow (see the picture below. Press this button to reach the desired value. Release the button and then press the SET button to keep, and save, the new value.



Note:

The minimum value you can set in the controller is:
 For refrigerators:-1°C (30°F), for Freezers:-23°C(-8°F)

Changing the reading temperature from °F to °C or vice versa.

To change the reading of the temperature from °F to °C or vice versa, you need access to the programming mode in the controller. To do this, press and hold the SET button for five (5) seconds until "PS" is shown in the display. Release the button and press the SET button one time. Now you will see the number zero (0). With the button UP arrow, set a value of "22" and then press the SET button. You will see the "PS" again. Use the button DOWN arrow to find the parameter "EZY" and press the SET button one time. Using the UP or DOWN button set a value according to the chart below.



For Refrigerators	EZY Value	Application
Temperature in °F	3	Refrigeration
Temperature in °C	4	Refrigeration

For Freezers	EZY Value	Application
Temperature in °F	1	Freezer
Temperature in °C	2	Freezer
Temperature in °F	3	Refrigeration
Temperature in °C	4	Refrigeration

Note:

Freezer equipment can be used like a refrigerator by selecting the value of the parameter “EZY” according to the chart above. Refrigerators must never be used like a freezer.

After you chose the value for the EZY parameter, press and hold the SET button for 5seconds. You will see the temperature on the display in °F or °C according to your selection.

5.2 OTHER FUNCTIONS

Manual Defrost

To select manual defrost, hold the button DOWN arrow for 5seconds. The snow flake icon will appear on the display. When this icon is solid it indicates that the equipment is in Defrost mode.

To exit manual defrost, hold the DOWN button arrow for 5seconds. The snow flake icon will turn off. Wait 2 minutes for the compressor to start.

Note:

If the equipment doesn't reach the temperature, first verify that the defrost cycle is not ON.

The unit will go into defrost every six hours for an average of 20 minutes. The defrost cycle is time initiated and temperature terminated.

NOTE!

Good air flow inside the cabinet is critical. Do not block air flow to the fans. Allow three inches of space along the front, back, and sides.

CAUTION!

Do not introduce hot foods, chemical or corrosive products, drugs, or open beverage bottles.

The unit must run for at least 24 hours before any product is placed inside. Failure to do so may ice up the evaporator coil. Consequently, the unit will never reach the desired set point. This failure will not be covered under warranty.



6 MAINTENANCE

Stainless Steel Care and Cleaning

Proper cleaning of stainless steel requires soft cloths or plastic scouring pads. Never use steel pads, wire brushes, or scrapers!

Cleaning solutions need to be alkaline or non-chloride cleaners. Any cleaner containing chlorides will damage the protective film of the stainless steel. Chlorides are commonly found in hard water, salts, house hold and industrial cleaners. If a cleaner containing chloride is used, be sure to rinse repeatedly and dry thoroughly up on completion.

Stainless steel must be cleaned every day with soap and water. Extreme stains or grease should be cleaned with a non-abrasive cleaner and plastic scrub pad. When using a stainless steel chemical cleaner, make sure it is recommended for commercial applications.

Never use an acid based cleaning solution! Many food products have an acidic content which can deteriorate the stainless steel finish. Be sure to clean ALL food products from any stainless steel surface. Failure to do so, will result in spots and rust on the surface affected.

6.1 CLEANING THE CONDENSER COIL



DANGER: Power must be turned off and disconnected from the power source whenever performing maintenance, repair or cleaning the condensing unit.

Disconnect machine. Remove front bottom panel and carefully slide out the condensing unit.

The condenser coil requires regular cleaning. It is recommended every 30-60 days, depending on the accumulation of dust and grease.

If the build upon the coil consists of only light dust and debris, the condenser coil can be cleaned with a simple brush. Heavier dust build up may require a vacuum or even compressed air to blow through the condenser coil.

If heavy grease is present, there are de-greasing agents available for coils. The condenser coil may require to be sprayed with de-greasing agent and then to be dried with compressed air. **Be sure all electrical and mechanical parts are dry before turning ON the power.**



Never use high pressure water for cleaning the condenser coil. Water can damage the electrical components located near or at the condenser coil. Do not place filter material in front of condenser coil. This material blocks air-flow to the coil similar to having a dirty coil!

If you keep the Condenser clean, you will minimize your service expense and lower your electrical costs. Failure to maintenance clean condenser coil can initially cause high temperatures and excessive run times. Continuous operation with dirty or clogged condenser coils can result in compress or failures. **This will not be covered under warranty.**

Neglecting the condenser coil cleaning procedures WILL VOID YOUR WARRANTY.

To put back the condensing unit, slide in the unit carefully in. BE SURE THE DRAIN PIPE IS LOCATED OVER THE DRAIN PAN. Replace front bottom panel.

6.2 GASKET

Gaskets require regular cleaning to prevent mold and mildew build up and to keep the elasticity of the gasket. Gasket cleaning can be done with the use of warm soap and water. Avoid the use of chemical cleaning products on gaskets as this can cause them to become brittle and prevent proper sealing. Also, never uses hard tools or knives to scrape or clean the gasket which could possibly tear the gasket and rip the bellows.

Gaskets can easily be replaced and do not require the use of tools or authorized service personnel. To remove the gasket, pull the gasket towards you. To replace gasket, press the gasket against the groove of the door the gasket will “snap” back into place.

6.3 DOORS/HINGES

During transportation the doors hinges may become loose. If the door(s) don't look aligned, tighten the screws that hold the hinge brackets to the frame of the unit. If the doors are loose or sagging, this can cause the hinge to pull out of the frame which may damage the doors and the door hinges. In some cases, this fix or adjustment may require a qualified service agent or maintenance personnel.



6.4 DRAIN

Each unit comes equipped with a drain pan located outside the unit. The drain pan catches the condensation produced inside the evaporator coil. If the drain hose become loose or disconnected from moving or bumping the unit, you may find a puddle of water inside/outside of the unit. Replace or fix any lose connections. IF YOU NOTICE EXCESSIVE WATER ACCUMULATION ON THE INSIDE OF THE UNIT, be sure the drain tube is connected firmly and not kinked or bent. It is the owner's responsibility to maintain the drain pan leveled, and with the drain hose inside of the pan.

Units installed in a humid environment will produce large amounts of water in the drain pan. This is NOT a malfunction of the unit. It is the customer's responsibility to clear the drain pan as necessary to avoid puddles of water underneath the unit.

Do not store open containers with liquids inside the unit. This will increase the amount condensation inside and outside of the unit, and the evaporator coil will freeze up.

Do not store hot products inside the unit. This will increase the amount of condensation inside and outside of the unit, and the evaporator coil will freeze up.

The unit must be level and on a strong surface. When moving the unit, check the drain piping to make sure it was not disconnected or moved out of the drain pan. This will not be covered under warranty.



7 WIRING DIAGRAMS

FU/WR/FST/FMT-27

Color Estándar / Standard Color	Calibre AWG (AWG Size)	Ref.	Símbolo /Symbol	Descripción/Description	Símbolo /Symbol	Descripción/Description
Verde/Green	18 AWG	A	VE	Ventilador de Evaporador/Evaporator's Fan	RDE	Resistencia de Descarga/Defrost Resistance
Azul Oscuro/Dark Blue	16 AWG	B	COM	Compresor/Compressor	RG	Resistencia de Desagüe/Drain Resistance
Marrón/Brown	16 AWG	C	VC	Ventilador de Condensador/Condenser Fan	CONT	Contactora/Auxiliar Contactor
Azul Claro/Light Blue	18 AWG	D	LAM	Lámpara/Light	JB	Araña de Conexiones/Junction Box
Marrón/Brown	18 AWG	E	CE	Controlador Electrónico/Electronic Controller	TA	Termostato Mecánico/Thermostat
Azul Oscuro/Dark Blue	18 AWG	F	MP	Micro-interruptor Puerta/Door Micro-Switch	T1	Sensor de Ambiente/ Environment Sensor
Amarillo/Yellow	18 AWG	G	INT	Interruptor Principal/Main Switch	T2	Sensor Deshielo/ Defrost Sensor
Rojo/Red	18 AWG	H	RM	Resistencia de Marco/Frame Resistance	INT-L	Interruptor Lámpara/Light Switch
Negro/Black	16 AWG	I				
Blanco/White	18 AWG	J				
Blanco/White	14 AWG	K				
Negro/Black	14 AWG	L				
Negro Rayado/Black Striped	14 AWG	M				

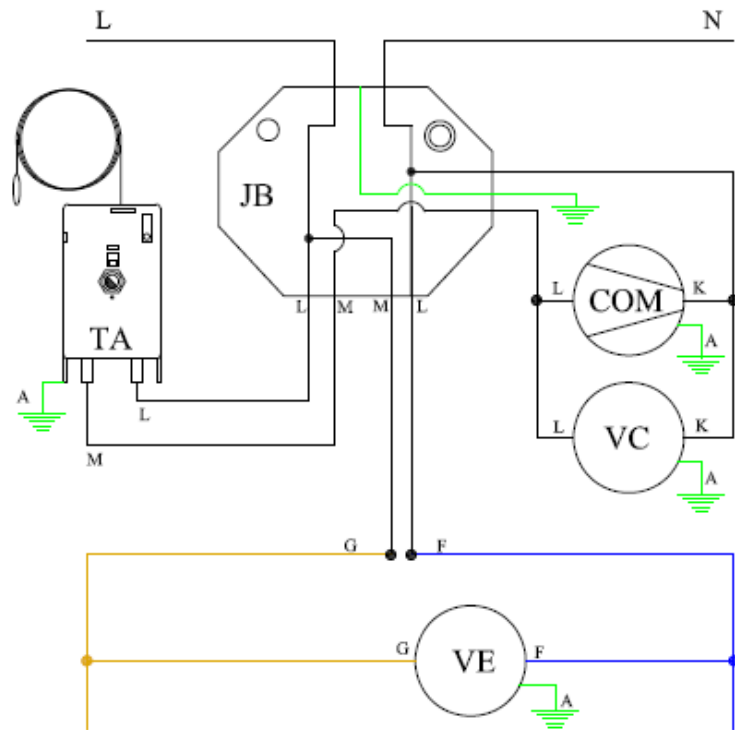



FU/WR/FST/FMT-48-60-72

Color Estándar / Standard Color	Calibre AWG (AWG Size)	Ref.	Símbolo /Symbol	Descripción/Description	Símbolo /Symbol	Descripción/Description
Verde/Green	18 AWG	A	VE	Ventilador de Evaporador/Evaporator's Fan	RDE	Resistencia de Descarche/Defrost Resistance
Azul Oscuro/Dark Blue	16 AWG	B	COM	Compresor/Compressor	RG	Resistencia de Desague/Drain Resistance
Marrón/Brown	16 AWG	C	VC	Ventilador de Condensador/Condenser Fan	CONT	Contacto/Auxiliar Contactor
Azul Claro/Light Blue	18 AWG	D	LAM	Lampara/Light	JB	Araña de Conexiones/Junction Box
Marrón/Brown	18 AWG	E	CE	Controlador Electrónico/Electronic Controller	TA	Termostato Mecánico/Thermostat
Azul Oscuro/Dark Blue	18 AWG	F	MP	Micro-interruptor Puerta/Door Micro-Switch	T1	Sensor de Ambiente/ Environment Sensor
Amarillo/Yellow	18 AWG	G	INT	Interruptor Principal/Main Switch	T2	Sensor Deshielo/ Defrost Sensor
Rojo/Red	18 AWG	H	RM	Resistencia de Marco/Frame Resistance	INT-L	Interruptor Lámpara/Ligh Switch
Negro/Black	16 AWG	I				
Blanco/White	18 AWG	J				
Blanco/White	14 AWG	K				
Negro/Black	14 AWG	L				
Negro Rayado/Black Striped	14 AWG	M				

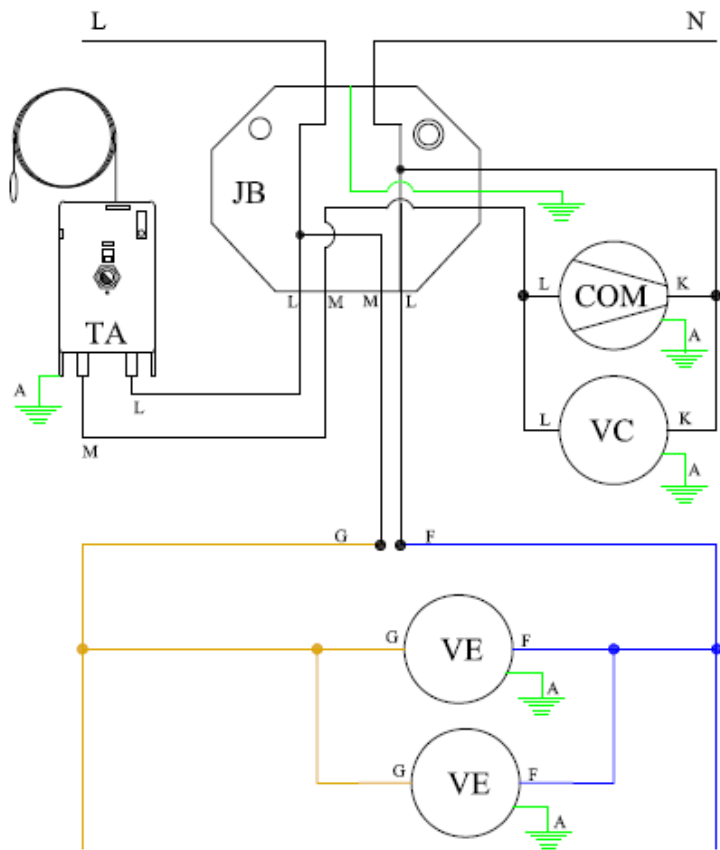



FU/WF -27

Color Estándar / Standard Color	Calibre AWG (AWG Size)	Ref.	Símbolo /Symbol	Descripción/Description	Símbolo /Symbol	Descripción/Description
Verde/Green	18 AWG	A	VE	Ventilador de Evaporador/Evaporator's Fan	RDE	Resistencia de Descarga/Defrost Resistance
Azul Oscuro/Dark Blue	16 AWG	B	COM	Compresor/Compressor	RG	Resistencia de Desague/Drain Resistance
Marrón/Brown	16 AWG	C	VC	Ventilador de Condensador/Condenser Fan	CONT	Contactora/Auxiliar Contactor
Azul Claro/Light Blue	18 AWG	D	LAM	Lámpara/Light	JB	Araña de Conexiones/Junction Box
Marrón/Brown	18 AWG	E	CE	Controlador Electrónico/Electronic Controller	TA	Termostato Mecánico/Thermostat
Azul Oscuro/Dark Blue	18 AWG	F	MP	Micro-interruptor Puerta/Door Micro-Switch	T1	Sensor de Ambiente/ Environment Sensor
Amarillo/Yellow	18 AWG	G	INT	Interruptor Principal/Main Switch	T2	Sensor Deshielo/ Defrost Sensor
Rojo/Red	18 AWG	H	RM	Resistencia de Marco/Frame Resistance	INT-L	Interruptor Lámpara/Ligh Switch
Negro/Black	16 AWG	I				
Blanco/White	18 AWG	J				
Blanco/White	14 AWG	K				
Negro/Black	14 AWG	L				
Negro Rayado/Black Striped	14 AWG	M				

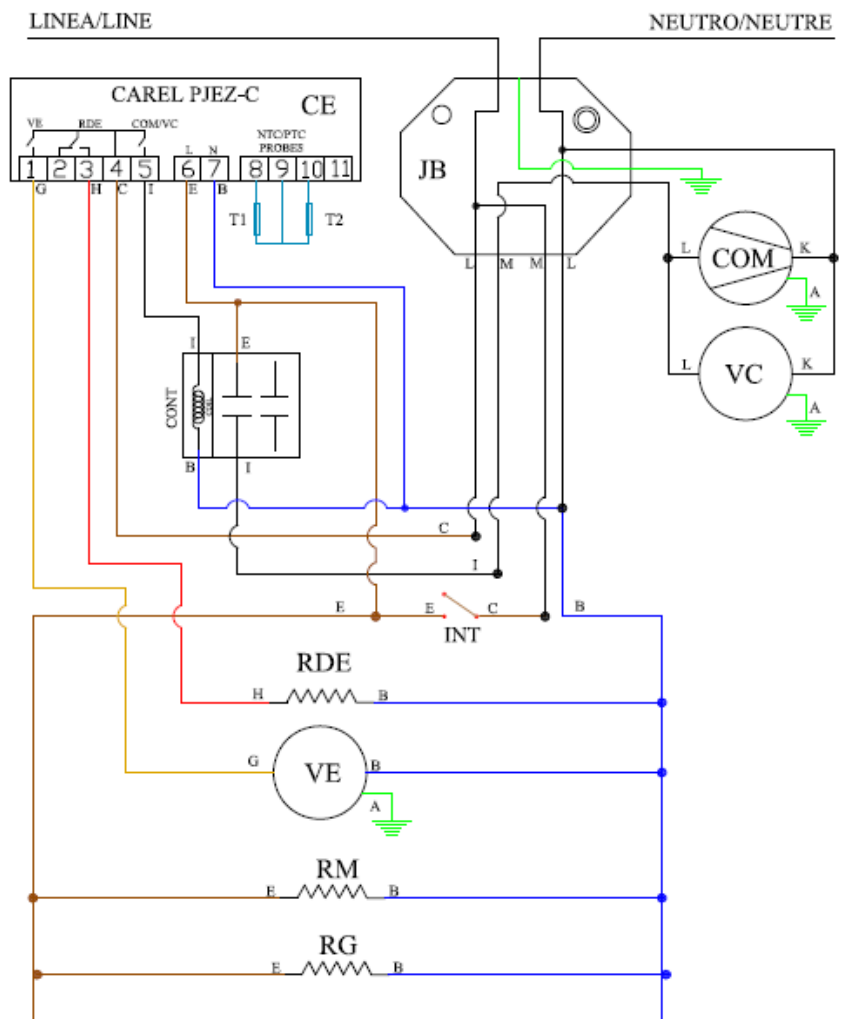



FU/WF-48-60

Color Estándar / Standard Color	Calibre AWG (AWG Size)	Ref.	Símbolo /Symbol	Descripción/Description	Símbolo /Symbol	Descripción/Description
Verde/Green	18 AWG	A	VE	Ventilador de Evaporador/Evaporator's Fan	RDE	Resistencia de Descarche/Defrost Resistance
Azul Oscuro/Dark Blue	16 AWG	B	COM	Compresor/Compressor	RG	Resistencia de Desague/Drain Resistance
Marrón/Brown	16 AWG	C	VC	Ventilador de Condensador/Condenser Fan	CONT	Contacto/Auxiliar Contactor
Azul Claro/Light Blue	18 AWG	D	LAM	Lámpara/Light	JB	Araña de Conexiones/Junction Box
Marrón/Brown	18 AWG	E	CE	Controlador Electrónico/Electronic Controller	TA	Termostato Mecánico/Thermostat
Azul Oscuro/Dark Blue	18 AWG	F	MP	Micro-interruptor Puerta/Door Micro-Switch	T1	Sensor de Ambiente/ Environment Sensor
Amarillo/Yellow	18 AWG	G	INT	Interruptor Principal/Main Switch	T2	Sensor de Dañido/ Defrost Sensor
Rojo/Red	18 AWG	H	RM	Resistencia de Marco/Frame Resistance	INT-L	Interruptor Lámpara/Ligh Switch
Negro/Black	16 AWG	I				
Blanco/White	18 AWG	J				
Blanco/White	14 AWG	K				
Negro/Black	14 AWG	L				
Negro Rayado/Black Striped	14 AWG	M				

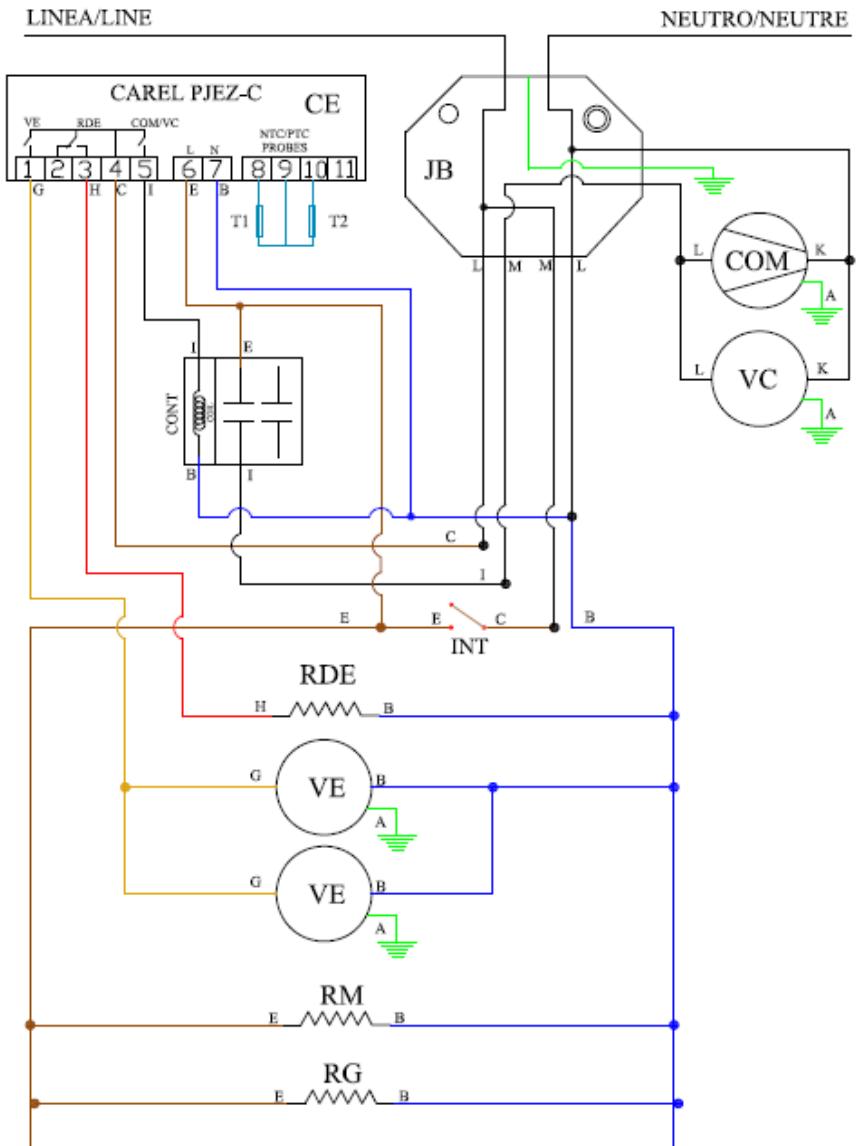



8 TROUBLE SHOOTING

Follow the next steps before requesting warranty service. Failure to do so may result in service charges for you and may void your warranty:

- 1) Refrigerator doesn't work:
 - a. Check that the machine is still connected.
 - b. Check that the ON/OFF button is in the ON position.

- 2) Refrigerator doesn't reach temperature:
 - a. Check that the thermostat is not in OFF position.
 - b. Check that the machine is not in the defrost cycle.
 - c. Ensure Equipment is in a ventilated place and removed minimum of 2 inches from any other appliance and away from any heat source.
 - d. The environment maximum temperature must be 38°C / 100°F.
 - e. To insure proper air flow, product must not be placed higher than the maximum level mark located on the internal wall of the unit.
 - f. If FREEZER, check that the temperature is not Celsius (°C).
 - g. Check that the gasket is in good condition and door is sealed.
 - h. Check that the fan is moving. Open the door and press and hold door switch for verification.
 - i. Don't put any food inside until the unit has reached the proper temperature.
 - j. If FREEZER, food must be previously frozen before being placed inside the cabinet.
 - k. Be sure castors or legs were installed.
 - l. If FREEZER, end user must defrost unit and wait if after wards unit works

- 3) There is water inside the refrigerator:
 - a. Check that the drain pan inside the cabinet is in position.
 - b. Check that there is not food clogging the drain line.

- 4) There is water under the refrigerator:
 - a. Check that the drain pipe is over the pan.
 - b. Check that the cabinet is level.

Warning:

To insure proper operation of equipment, it is recommended that the unit is on for 8 hours prior to the introduction of perishables.



9 WARRANTY

AS OF APRIL 1, 2014

Three Years Parts & Labor Warranty: Fagor Commercial, Inc. ("Fagor") Warrants to the first-end-user purchaser (the "User") that the Fagor brand equipment sold hereunder, except for parts and accessories which carry the warranty of a supplier (the "Equipment") will be free from defects in material and factory workmanship under normal conditions of use and maintenance and upon proper installation and start-up in accordance with the User manual supplied with each Fagor unit. The obligation of this warranty is covered by Fagor for a period of three (3) years from the date of installation (Warranty commencement date), but in no event to exceed thirty-nine (39) months from the date of shipment from Fagor. Warranty is Not Transferable.

Warranty Coverage: If there is a defect in material or factory workmanship covered by this Warranty reported to Fagor during the period the applicable Warranty is in force and effect, Fagor will repair or replace, at Fagor's option, that part of the Equipment that has become defective and will cover reasonable labor cost within the corresponding warranty period of time. Fagor shall bear all reasonable labor costs in connection with the installation of these replacement parts, provided that, the installation is conducted by Fagor or its authorized representative. Charges for warranty travel time round trip, total two (2) hours or up to 100 miles total. Any charges exceeding those stated herein must have prior authorization by Fagor. In case Fagor deems the equipment non-repairable, said equipment will be replaced and the replacement unit(s) will carry the same warranty period from the original unit's installation date (original Warranty commencement date).

Additional Two Year Compressor Part Warranty: In addition to the warranty set above, Fagor warrants the sealed compressor (part only) for an additional two (2) years based on the original installation date, but not to exceed thirty-nine (39) months after shipment from the manufacturer. This warranty is for defects, both in workmanship and material, under the normal and proper use and maintenance service. The two (2) year extended warranty only applies to sealed parts of the compressor and does not apply to any other part or component, including, but not limited to cabinet, temperature control, refrigerant, motor starting equipment, fan assembly, or any other electrical or mechanical component.

Exclusions from and Conditions to Warranty Coverage: This Warranty does not cover parts or accessories, which (a) carry the warranty of a supplier or (b) are abused. Application of this Warranty is further conditioned upon the following:

- **Installation:** The Equipment must be properly installed in accordance with Fagor's installation procedures and by a professional technician.
- **No Alteration:** The Equipment must not have been modified or altered from its condition at the date of original installation.
- **Use:** FAGOR EQUIPMENT IS NOT DESIGNED FOR PERSONAL, FAMILY, OR HOUSEHOLD PURPOSES, AND ITS SALE FOR SUCH PURPOSES IS NOT INTENDED. IN THE EVENT THE EQUIPMENT IS SO USED, THIS WARRANTY SHALL BE NULL AND VOID, AND THE EQUIPMENT IS SO USED, THIS WARRANTY SHALL BE NULL AND VOID, AND THE EQUIPMENT SHALL BE DEEMED TO HAVE BEEN SOLD "AS IS-WHERE IS" WITHOUT ANY WARRANTY OF ANY KIND, INCLUDING WITHOUT LIMITATION ANY WARRANTY OF TITLE, NON-INFRINGEMENT, MERCHANTABILITY OR FITNESS FOR A PARTICULAR PURPOSE.



- Proper Maintenance and Operation: The Equipment must be properly maintained and operated in accordance with Fagor's maintenance and operating procedures. All service, labor and parts must be acquired from Fagor or its authorized service representative for the User's area.
- This warranty is void if failure is a direct result of handling and/or transportation, fire, water, accident, misuse, acts of god(s), attempted repair by unauthorized persons, improper installation, if serial number has been removed or altered, or if unit is used for purpose other than it was originally intended.

Failure to comply with any of these conditions will void this Warranty. In addition, this Warranty does not cover defects due to apparent abuse, misuse or accident.

Parts Warranty Coverage: Fagor warrants all new machine parts produced or authorized by Fagor to be free from defects in material and workmanship for a period of 90 days from the Warranty Commencement Date. If any defect in material and workmanship is found to exist within the warranty period, Fagor will replace the defective part without charge. Defective parts become the property of Fagor.

Fagor will have no responsibility to honor claims received after the date the applicable Warranty expires. Notwithstanding the foregoing, any claim with reference to the Equipment or any parts therefore for any cause shall be deemed waived unless submitted by the User to Fagor within (30) days after the date the User discovered, or should have discovered, the claim. In connection with all claims under this Warranty, Fagor will have the right, at its own expense, to have its representatives inspect the Equipment at the User's premises and to request all of the User's records pertaining to the Equipment to determine whether a defect exists, whether the conditions set forth in this Warranty have been satisfied, and whether or not the applicable Warranty is in effect.

THE FOREGOING WARRANTY IS IN LIEU OF AND EXCLUDES ALL OTHER WARRANTIES NOT EXPRESSLY SET FORTH HEREIN, WHETHER EXPRESS OR IMPLIED BY OPERATION OF LAW OR OTHERWISE, INCLUDING BUT NOT LIMITED TO ANY REPRESENTATION OF PERFORMANCE AND ANY IMPLIED WARRANTIES OF TITLE, NON-INFRINGEMENT, MERCHANTABILITY OR FITNESS FOR A PARTICULAR PURPOSE. NO OTHER WARRANTIES ARE AUTHORIZED ON BEHALF OF FAGOR UNLESS SPECIFICALLY ISSUED BY FAGOR.

Fagor shall have no liability for incidental or consequential losses, damages including without limitation or expenses, loss of sales, spoiled food, profits or goodwill, claims whether or not on account of refrigeration failure or punitive or exemplary damages directly or indirectly arising from the sale, handling or use of the Equipment or from any other cause relating thereto, whether arising in contract, tort, warranty, strict liability or otherwise. Fagor's liability hereunder in any case is expressly limited, at Fagor's election, to repair or replacement of Equipment or parts therefore or to the repayment of, or crediting the user with, an amount equal to the purchase price of such goods.



Terms & Conditions

Prices & Specifications: Fagor reserves the right to change the prices and specifications of the equipment and/or material without notice. Prices are FOB Fagor warehouses. All orders are subject to acceptance by Fagor Commercial, Inc.

Terms: All orders are subject to credit approval. All Invoices not paid within the specified terms will be subject to a 1.5% per month delinquency charge. Buyer agrees to pay all costs of collection including such attorney's fees as may be allowed by law.

Taxes: This price list does not include any Federal, State, City or Local taxes, which may apply and are subject thereto.

Shipment: Requested carrier will be used upon request. Fagor has the right to ship via any responsible carrier if requested carrier is unavailable. Shipping charges are payable by consignee and any claims arising as such charges shall be resolved between the carrier and the consignee. Shipping dates are approximates. Fagor is not responsible for any delays in deliveries that are beyond our control.

Damaged Merchandise: Inspect shipment for any damage, before accepting it. If damaged, open and inspect the contents with the carrier. Any damage should be noted and reported on the delivering carrier's receipts. Fagor assumes nor responsibility for damages while in transit.

Concealed Damage: If there is concealed damage to the equipment, notify the carrier immediately. Notification should be made verbally as well as in written form. Request an inspection by the shipping company of the damaged equipment. Retain all crating material until inspection has been made.

Cancellations & Returns: Cancelled orders and returned merchandise are subject to a 25% restocking and handling charge. Written authorization is required for a return of any equipment. All equipment returned must be in its original factory crate; freight prepaid and must be in the same condition as originally shipped by Fagor. Returns will only be authorized within 30 days of invoice date.

Warranty: Register your product with Fagor Commercial to validate you warranty. Service calls must be made directly through Fagor service department. 1-(866)-463-2467 or e-mail: us.service@onneragroup.com.

*You may register your product online at <http://www.fagorcommercial.com>



13105NW 47thAve
Miami, Fl. 33054
Tel:(305) 7790170
Fax:(305)7790173 1-866-GO-FAGOR
www.fagorcommercial.com
