

▶ Hot Water Dispenser HWD_2102 With Portion Control Domestic and Export Version



This user guide is only for FETCO HWD-2102 models built after March 2020

The user guide for models built before March 2020 follows next.

Table of Contents

Operator And User Sections

Operating Instructions.....	3
Operating Principles	4
Adjusting Temperature and Dispense Portion.....	5
Error Messages	7
Cleaning & Maintenance.....	8

Professional Service Sections

Equipment Setup	9
Parts Diagrams	11
Wiring Diagram	14

Contact Information

FETCO®

Food Equipment Technologies Company
600 Rose Road
Lake Zurich • IL • 60047-0429 • USA

Internet: www.fetco.com

©2013-2020 Food Equipment Technologies Company

Go to fetco.com for the latest version of all information

Phone: (800) 338-2699 (US & Canada)
(847) 719-3000

Fax: (847) 719-3001

Email: sales@fetco.com

techsupport@fetco.com

PATENTS: WWW.fetco.com/patents

P119 REVISED March 2020



FETCO HWD-2102 push-button commercial hot water dispensers with portion control

Electrical Configurations								
Configuration Code	Heater Configuration	Voltage	Phase	Wires	Electrical Connection	KW	Amp Draw	Flow Rate* Per hour
H210210	1 X 1.4 KW	100-120	single	2+G	NEMA 5-15P	1.5	12.5	3.6 Gal/13.6 liters
H210220	1 X 2.1 KW	100-120	single	2+G	NEMA 5-20P	2.2	18.3	5.4Gal/20.4 liters
H210230	1 X 3.2 KW	200-240	single	2+G	NEMA 6-15P	3.3	13.8	8.2Gal/31.0 liters
H210240	1 X 3.2 KW	200-240	single	2+G	cord only without plug	3.3	13.8	8.2Gal/31.0 liters

*Flow rate based on 55°F/13°C water mains supply and dispensing From (“READY” Light ON)
 Portion Control: factory calibrated to dispense portion of 200ml/6.8oz—at timer setting: 5sec
 Portion control is user selectable: 40-1200cc/1.4-40.6fl.oz. Portion size is controlled by setting dispense timer.
 Actual portions and temperatures shown are estimated and are influenced by mains flow rate and temperature

Power Plug Configurations

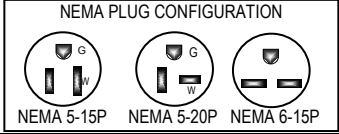

NEMA 5-15P NEMA 5-20P NEMA 6-15P

Please see wiring diagrams located in back pages for installation notes.

Specifications and Requirements								
Capacities & Measurements								
Brewer	Height	Width	Depth	Empty Weight	Filled Weight	Hot Water Tank Capacity	Shipping Weight	Shipping Dimensions
HWD-2102	19 ¹ / ₃₂ inch 483 mm	8inch 203 mm	16 ¹ / ₈ inch 410 mm	19 lb 8.6kg	36 lb 16.3kg	1.8 gal 6.9 liter	25lb 11.3kg	26 X 13 X 17in 660 X 330 X 432mm

Water Requirements
Water Connection: Inlet: 1/4 inch male flare fitting Mains Pressure: 20-75 psig (0.02-0.517 mPa) (45psi/0.310 mPa preferred) Minimum Flow Rate: 1 gpm or 3.8lpm All commercial hot water dispensers to be supplied with filtered water from mains
The following are the factory settings—and range of variables that are adjustable: Portion Control: Delivery volume: factory set at 16 seconds=630ml/21.3oz (Portion control is user selectable from minimum to maximum single dispense is 40ml/1.4 ounces to 1200ml/40.5 ounces by 1 sec to 30seconds timer adjustment) Temperature Control: Water temperature is factory set at maximum—96°C/205°F (Temperature is user selectable 78-96°C/189° to 205°F) Hot Water Tank Temperature, as set by factory: 96°C/205°F inside water tank (at sea level) Electrical Requirements: See electrical configuration charts (above).

Dimensions & Utility Connections HWD_2102

DRAWING1201.00005.00

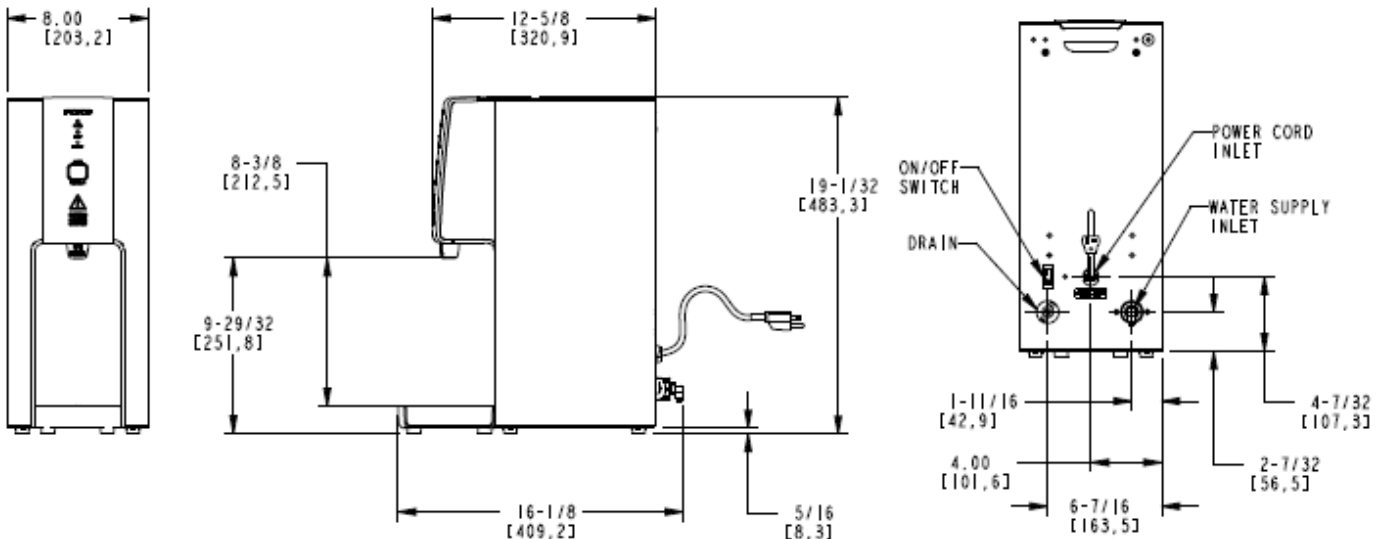

Operating Instructions

To Start:

Follow equipment installation and set up procedures.

If desired, set any custom dispense temperature or dispense volume

→ *Instructions for setting dispense temperature & volume located on page 5*

1. Open water supply valve
2. Power unit "ON" from rear power switch.
3. →Unit will fill and heat (up to 20 minutes for a new unit).
-After unit is filled and heated:
4. Ready Lamp will glow green
5. HWD_2102 may be operated when Ready Lamp is "off" (after initial fill).
6. When ready: the white control panel backlight intensity will slowly pulsate.

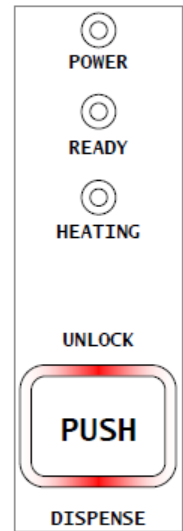

NOTE→ the HWD_2102 should be left "ON". The hot water tank is well insulated to control energy loss. Standby heat loss is ≤ 100 watts per hour.

HWD_2102 has two dispense modes: **MANUAL** and **PORTION CONTROLLED**

To dispense with **MANUAL CONTROL**—[Press and Hold!]

- 1) Press UNLOCK/DISPENSE pad for 1-3 seconds to unlock and activate dispensing system
-Border of UNLOCK/DISPENSE pad will change: turning steady red signaling activation
- 2) Remove finger from pad
-Border of UNLOCK/DISPENSE pad will **glow steady red: ready to dispense**
- 3) Press center of UNLOCK/DISPENSE pad to dispense.
-Keep finger on pad until dispense is complete.
-Dispense automatically stops when time out is complete, or if finger is removed.

Multiple dispenses are possible when the UNLOCK/DISPENSE light pad is steady and red colored. Reactivate next dispense portion by retouching pad. Finger must be on pad to dispense.

To dispense with **PORTION CONTROL**—[Touch and Hold!]

- 1) Press and hold UNLOCK/DISPENSE pad for 3 seconds to unlock and activate dispensing system.
-Border of UNLOCK/DISPENSE pad will **rapidly strobe signaling activation**
- 2) Remove finger from pad
-Selected portion will automatically complete
- 3) If needed: tap center of UNLOCK/DISPENSE pad to stop dispense.
-Dispense automatically stops when time out is complete, or if pad is tapped again.

NOTE→ Dispense is unlocked and will function only when border of UNLOCK/DISPENSE pad is steady red.

The UNLOCK/DISPENSE pad rapidly flashes red if finger remains on it after dispensing without dispensing.

If finger remains on the UNLOCK/DISPENSE pad more than 30 seconds while rapidly flashing red-the controls "lock out" and READY LIGHT & HEATING LIGHT will flash rapidly to show a fault state.

NOTE→All controls are disabled during fault state. **To clear fault state:**

Switch machine "OFF" for about ten seconds, and then toggle back "ON" (Control Reset).

After controls initiate, hot water tank level and temperature are checked by internal electronics-

The "READY" light will activate if digital check is "clear".

NOTE→ The check and fault clear may take approximately 2 minutes for filled and preheated unit; up to 20-30 minutes for a new and empty unit.

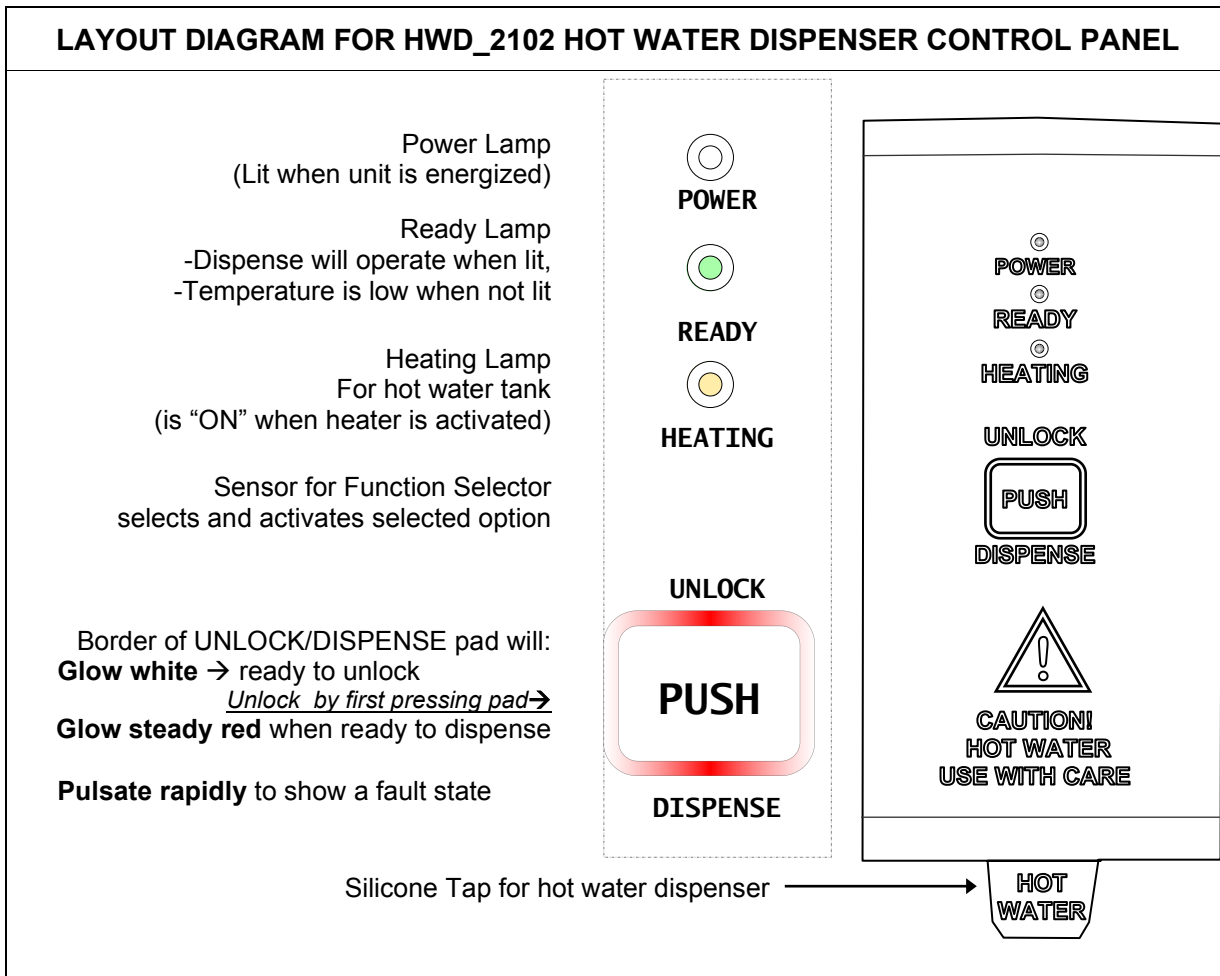

Operating Principles

The HWD_2102 delivers precision portions of water at selected volume and temperature.

Unit is factory set at 96°C/205°F. The green "READY" lamp must be lit.

If the green "READY" lamp is not lit the unit will dispense water-but not at selected temperature.

Unit is factory calibrated at the optimum dispense portion of 200ml/6.8oz).

Automatic portion dispense is by pressing "DISPENSE" and removing finger.

Larger or different portion may be overridden by maintaining "ON" activation

Hot water is drawn from the faucet, the fill valve cycles on and off to replenish the hot water tank.

When dispensing water at a rate that exceeds the unit's capacity to heat, the ready light will go off to show that the selected preset temperature is not available. Always observe the "READY" lamp

When the green "READY" lamp is lit – proper dispense temperature is enabled.

When heating or reheating, the green "READY" light will turn off and the "HEATING" light will display

The dispense valve faucet is protected by a silicone bumper over the tap.

NOTE→ Dispense flow rate is given for typical 50psi/0.310mPa water supply pressure.

!Differences in water supply pressure affect flow rate, and quantity of hot water dispensed!

NOTE→ After exceeding the maximum optimum dispense portion of 20fl.oz/600cc the hottest water supply in the hot water tank begins to become depleted. The "READY" lamp will turn off. Dispenser faucet does not "lock-out" and may allow less heated water to dispense. For the highest selected dispense when "READY" lamp is lit.

NOTE→ When the HWD_2102 is powered on (or after controller reset) - the controls check and adjust tank level and temperature. Allow approximately 2 minutes for filled and heated unit; up to 20-30 minutes for a new and empty unit.

Adjusting Temperature and Dispense Portion

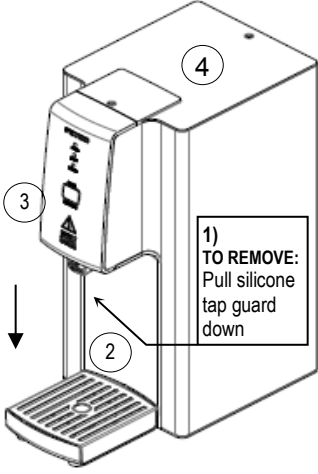
<p>1) Open the cover panel</p> <p>To access controls</p> <ol style="list-style-type: none"> 1) Remove silicone tap guard first 2) Remove lower face panel 3) Upper face panel next, 4) Top panel last 	<p>2) Accessing control settings</p> <p>Access the temperature and dispense portion with three rotary switches</p> <p>Dials are marked S3 TH (temperature) S2 time(x) 1 } (portion) S1 time(x) 10 }</p> <p>To access rotary switches for adjusting Unplug the machine before disassembly or changing settings</p> <ul style="list-style-type: none"> -Turn off power -Pull off silicone tap guard -Remove all screws and panels to access control board for adjustments. -Temperature and portion dials are located under upper face panel (#3) <p>See below for settings & make adjustment(s)</p> <p>Reinstall and tighten all screws before power-up Do not operate until all covers and screws in place. NOTICE: Reinstall ribbon connector into CN-3 if it is detached-SEE BELOW</p>
 <p>1) TO REMOVE: Pull silicone tap guard down</p>	<p>Reinstall covers -Reverse steps 1-4 (above)</p>
<p>IMPORTANT When Changing Settings: After adjusting dials, or following reassembly and plugging in. 1) Switch machine "OFF" for about ten seconds 2) Toggle back "ON" (Control Reset)</p>	

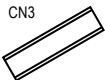
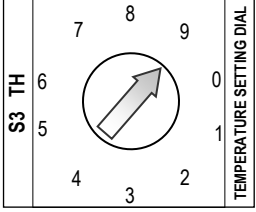
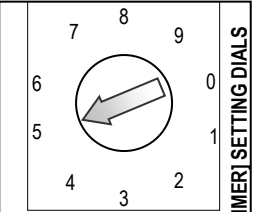
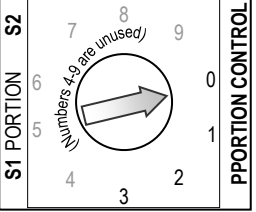
<p>3) To set water portion and temperature controls</p> <p>Actual portions and temperatures shown are estimated and are influenced by mains flow rate and temperature</p>																																												
<p>Upper Dial (Marked: S3) Set temperature Base temperature begins at 78°C/172°F, and increments in two degree Celsius units. Add two degrees for each dial position numerical value in degrees Celsius (°C) to 78° base to a maximum of 96°C/205°F Unit is factory set at 96°C/205°F.</p> <div style="border: 1px solid black; padding: 5px; margin: 10px 0;"> <p>CN3  Reinstall ribbon connector into ←CN-3 if detached. This connection is the dispense switch</p> </div> <p>Lower Dials (Marked S1 & S2) Set dispense volume The two lower dials control the hot water volume to be delivered by setting the dispense time in seconds. The timer dials are additive and control flow for 1 to 30 seconds or approximately 40-1200ml (1.3-40.6 fluid ounces.) 36-42 ml/1.2-1.4oz is dispensed in 1 second.</p> <p>Actual volume delivered is affected by flow rate (the supply water line pressure). Lower water pressure or pressure drops may lower flow rate. Higher pressure will increase flow rate. Unit is factory set at 5 seconds 200ml/6.8oz.</p>																																												
<p>Dial Settings for Temperature</p> <table border="1" style="width: 100%; border-collapse: collapse; text-align: center;"> <thead> <tr> <th>Upper dial Temperature Setting</th> <th>Deg. C</th> <th>Deg. F</th> </tr> </thead> <tbody> <tr><td>0</td><td>78</td><td>172</td></tr> <tr><td>1</td><td>80</td><td>176</td></tr> <tr><td>2</td><td>82</td><td>180</td></tr> <tr><td>3</td><td>84</td><td>183</td></tr> <tr><td>4</td><td>86</td><td>187</td></tr> <tr><td>5</td><td>88</td><td>190</td></tr> <tr><td>6</td><td>90</td><td>194</td></tr> <tr><td>7</td><td>92</td><td>197</td></tr> <tr><td>8</td><td>94</td><td>201</td></tr> <tr><td>9</td><td>96</td><td>205</td></tr> </tbody> </table>					Upper dial Temperature Setting	Deg. C	Deg. F	0	78	172	1	80	176	2	82	180	3	84	183	4	86	187	5	88	190	6	90	194	7	92	197	8	94	201	9	96	205							
Upper dial Temperature Setting	Deg. C	Deg. F																																										
0	78	172																																										
1	80	176																																										
2	82	180																																										
3	84	183																																										
4	86	187																																										
5	88	190																																										
6	90	194																																										
7	92	197																																										
8	94	201																																										
9	96	205																																										
<p>Dial Settings for Dispense Volume</p> <table border="1" style="width: 100%; border-collapse: collapse; text-align: center;"> <thead> <tr> <th>Bottom</th> <th>Top</th> <th>Sec</th> <th>ml</th> <th>oz</th> </tr> </thead> <tbody> <tr><td>0+</td><td>0=</td><td>1</td><td>40</td><td>1.4</td></tr> <tr><td>0+</td><td>1=</td><td>1</td><td>40</td><td>1.4</td></tr> <tr><td>0+</td><td>5=</td><td>5</td><td>200</td><td>6.8</td></tr> <tr><td>0+</td><td>6=</td><td>6</td><td>240</td><td>8.1</td></tr> <tr><td>1+</td><td>5=</td><td>15</td><td>600</td><td>20.3</td></tr> <tr><td>2+</td><td>5=</td><td>25</td><td>1000</td><td>33.8</td></tr> <tr><td>3+</td><td>0=</td><td>30</td><td>1200</td><td>40.6</td></tr> </tbody> </table> <p>Volumes above are an example at typical 0.34MPa/50PSI water pressure.</p>					Bottom	Top	Sec	ml	oz	0+	0=	1	40	1.4	0+	1=	1	40	1.4	0+	5=	5	200	6.8	0+	6=	6	240	8.1	1+	5=	15	600	20.3	2+	5=	25	1000	33.8	3+	0=	30	1200	40.6
Bottom	Top	Sec	ml	oz																																								
0+	0=	1	40	1.4																																								
0+	1=	1	40	1.4																																								
0+	5=	5	200	6.8																																								
0+	6=	6	240	8.1																																								
1+	5=	15	600	20.3																																								
2+	5=	25	1000	33.8																																								
3+	0=	30	1200	40.6																																								

Designs, materials, specifications, physical dimensions, firmware and software protocol for equipment or replacement parts are subject to review and change by FETCO without notice

TABLE OF TECHNICAL DATA

TEMPERATURE	PORTION Portion size is controlled by dispense time	
Top Dial	Center Dial Timer	Bottom Dial Timer
SW3=Temperature	SW2 Time seconds	SW1=Time-10s
Celsius scale used	Volume setting - 1 sec increments	Volume setting - 10 sec increments
0 = 78C (172°F)	0=1second (Default to 40ml)	0=add <u>0</u> seconds
1 = 80 C (176°F)	1=1 sec. or 40ml	1=add <u>10</u> seconds
2 = 82 C (180°F)	2=2 sec. or 80ml	2=add <u>20</u> seconds
3 = 84 C (183°F)	3=3 sec. or 120ml	3=add <u>30</u> seconds
4 = 86 C (187°F)	4=4 sec. or 160ml	4 {Inactive position}
5 = 88 C (190°F)	5=5sec. or 200ml	5 {Inactive position}
6 = 90 C (194°F)	6=6 sec. or 240ml	6 {Inactive position}
7 = 92 C (198°F)	7=7 sec. or 280ml	7 {Inactive position}
8 = 94 C (201°F)	8=8 sec. or 320ml	8 {Inactive position}
9 = 96 C (205°F)	9=9 sec. or 360ml	9 {Inactive position}
Factory set at maximum— 96°C/205°F	Factory calibrated setting: 200ml/6.8oz set at 5sec at 96°C/205°F Settings in table may vary and are given for the conditions below: Mains 0.34MPa/50PSI and Flow Rate:3.8lpm/1 gpm at 55°F/13°C	

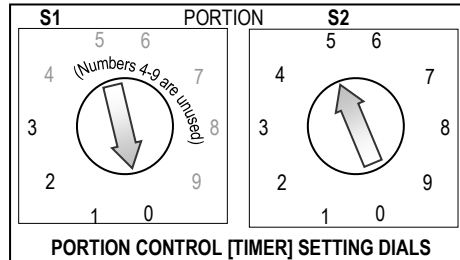
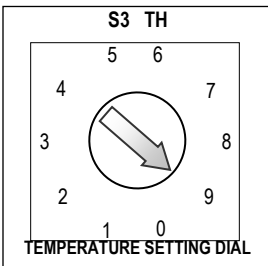

Correction for altitude table

Altitude		Boiling Point	
(ft)	(m)	(°f)	(°c)
-250	-76	212.5	100.3
0	0	212	100
500	152	211	99.5
1000	305	210.1	98.9
1500	457	209.1	98.4
2000	610	208.1	97.8
2500	762	207.2	97.3
3000	914	206.2	96.8
3500	1067	205.3	96.3
4000	1219	204.3	95.7
4500	1372	203.4	95.2
5000	1524	202.4	94.7
5500	1676	201.5	94.2
6000	1829	200.6	93.6
6500	1981	199.6	93.1
7000	2134	198.7	92.6
Corrections to compensate for boiling point changes due to elevation. Allow 5-10%			

Portion size setting:

Flow is 40ml per second and is proportional to mains pressure.
The two timer dials are additive and control flow for 1 to 30 seconds
Dispense volume at 1-30 seconds is approximately 40-1200ml
(1.3-40.6 fluid ounces)

Portion time =
SW1 (0, 10, 20, 30) + SW2 (0-9)

Min Time = 1 second- Will default to 40ml if SW1 & SW2 are set to 0

Max Time is 30 Seconds

Range: 1 sec to 30 seconds minimum to maximum single dispense
is 40ml/1.4 ounces to 1200ml/40.5 ounces

50psi/3.4bar/0.344MPa
Mains Pressure: 45-75 psig (0.31-0.517 mPa)
(0.34MPa/50PSI preferred)

IMPORTANT When Changing Settings, after adjusting dials, or following reassembly and plugging in:

- 1) Switch machine "OFF" for about ten seconds
- 2) Toggle back "ON" (Control Reset) .

Error Messages

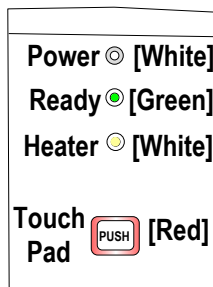

The UNLOCK/DISPENSE pad rapidly flashes red if finger remains on it after dispensing and no water is dispensed.

If finger remains on the UNLOCK/DISPENSE pad more than 35 seconds while rapidly flashing red-the controls “lock out” and READY LIGHT & HEATING LIGHT will flash rapidly to show a fault state. See keyboard errors 1 & 2 in chart below

All controls are disabled during fault state.

To clear Fault State:

Switch machine “OFF” for about ten seconds, and then toggle back “ON” (Control Reset)

After controls initiate, hot water tank level and temperature are checked- then the “READY” light will activate.

NOTE→This will take approximately 2 minutes for filled and heated unit; up to 20-30 minutes for a new/empty unit

Color of LED-See above			Error Messages	
“READY”	“HEATER”	“TOUCH PAD”	Error type	
Green	White	Red		
BLINK	BLINK	BLINK	System error	
BLINK	Off	Off	Thermistor short	Shorting out the thermistor will cause the thermistor error at once
BLINK	Off	ON	Thermistor open	Opening the thermistor will cause the thermistor error at once
BLINK	ON	Off	Initial fill error	Tank has not filled in 6 minutes
BLINK	ON	ON	Fill error	Tank does not re-fill after 1 minute
BLINK	BLINK	Off	Boil error	If the heater is on→and Tank temperature is not increasing according to software logic and the tank temperature > 92C
BOIL ERROR-This means that the water in the tank is boiling, flat temperature—no increase to set point. This fault usually occurs at higher elevations where boiling point is reduced from lower barometric pressure compared to sea level. Recommended action: review boiling point correction for altitude table (page-6) with suggested setting for the operator at higher elevations.				
BLINK	BLINK	ON	Heater open	If the heater is on→and Tank temperature is not increasing according to software logic and the tank temperature < 92C
HEATER OPEN- This means that the power board or that the heater control triac is sending power to the heater, but the heating element is faulty or damaged-(OPEN-circuit). Fault is with the damaged heating element or bad connection or control circuit problems Recommended action. Check all wiring, internal and external connections –if good: service as follows: In order of repair 1: Test & replace heater 2: Replace triac 3: Replace control board				
BLINK	Off	BLINK	Heater shorted TRIAC Failure	If the heater is supposed to be off →and The heater is off during (7 min) temperature rise time and the tank temperature is greater than the software logic calculates
HEATER SHORTED-The triac is stuck closed, (MAKE position in Make/Break contactor code). Power is always getting to the heater meaning it is out of the control system. Traic and solid state relays fail CLOSED, in the Make Position. This fault usually occurs from a stuck (faulty) triac. The heating element is powered thru damaged triac (no signal to triac but it is conducting power to the heater) Recommended action. Replace triac—Check all wiring, internal and external connections.				
BLINK	ON	BLINK	Keyboard error 1	1. Press and hold the button with unit idle. After 3 seconds unit goes into proportional mode As soon as unit begins to dispense a 45 second timer is started unit will stop dispensing after the programmed timed keyboard error is caused if the button remains held for more than 45 seconds
			Keyboard error 2	2. Press and release then press to have a manual dispense if the button remains held for more than 30 seconds-->the dispense will stop. 45 Seconds after the dispense stops the unit goes into keyboard error

Cleaning & Maintenance

Daily:

1. Check the drip tray and empty if necessary.

Quarterly:

1. Inspect all fittings and hoses for leaks.
2. Inspect inside of tank for lime deposits. De-lime tank and probes if necessary.
(This procedure to be performed by a qualified service technician)

Notice:

Turn off power before any cleaning procedure, including wiping the exterior for appearance reasons.
Dry the exterior, especially the face panel, before turning on power.

WARNING:

1. Equipment is designed for commercial use only. Equipment is not for household use.
2. Do not apply any type of spray cleaner on the face panel of this equipment.
3. Never use solvent or solvent based cleaner or petroleum based polish on this equipment.
4. Dry the face of the HWD-2102 before turning on power.
5. No user serviceable parts; refer to qualified service technician for repair and adjustments.
6. Dangerous high voltage and high temperatures inside
7. Unplug machine before disassembly or changing settings
8. Operation requirements and maintenance for commercial cooking appliances differ from household appliances.
9. Operators must be trained for this equipment and must understand the use, maintenance and kitchen hazards.
10. Do not attempt to move hot beverage equipment once it is filled. Drain equipment before moving.
11. The HWD-2102 Hot Water Boilers provides very hot water from the faucet when it is activated.
12. HWD-2102 may continue to dispense very hot water from the faucet after the electronic touchpad is completely disabled, or if the power is turned off, or by unplugging the unit.
13. Keep these instructions for training and future reference

WARNING-

Do not plug-in this equipment or attempt to operate without all covers in place and all screws fastened

Labels and warnings BACK PANEL of equipment
(1046.00035.00)











WARNING

All electrical connections must be in accordance with local electrical codes and any other applicable codes.
If the supply cord is damaged, it must be replaced by the manufacturer, its service agent, or similarly qualified persons in order to avoid a hazard.
To prevent an electric shock hazard this device must be bonded to equipment in close proximity with an equipotential bonding conductor. This device is equipped with a grounding lug for this purpose and is marked with the following symbol



For "CE" marked equipment only

	WARNING To reduce risk of electric shock or fire.
	FETCO® Hot Beverage Equipment is for commercial use only.
	Do not remove or open cover. No user serviceable parts inside. Refer installation and service to qualified personnel.
	Caution, disconnect from power supply before servicing.
	GROUND: National Electrical Code requires separate grounding wire.
	Use dedicated circuit with capacity rated by local code or National Electrical Code for the current draw of this equipment. Check serial number plate on right side for power requirements.
	Locate unit away from source of heat. Do not install or use near combustibles.
	THIS APPLIANCE IS ENERGIZED WHENEVER IT IS CONNECTED TO A POWER SOURCE
	FAILURE TO COMPLY RISKS EQUIPMENT DAMAGE, PROPERTY DAMAGE, FIRE, OR SHOCK HAZARD
Notice	This equipment must be installed with a backflow protection device to comply with federal, state or local municipality codes.
Notice	Read the user guide before installing and operating this unit.

For qualified service technicians

Equipment Setup

1. Read User Guide noting all instructions. Review the dimensions for the unit you are installing.
2. Verify that it will fit in the space intended for it.
3. Verify that the counter or table will support the total weight of the equipment and any dispensers when filled.
4. Place the equipment on the counter or stand.

Water Connection

1. Water supply inlet is a $\frac{3}{8}$ inch male flare fitting.
2. The HWD-2102 Hot Water Dispenser can be connected to a cold or hot water line.
3. (Cold water is preferred for best beverage flavor, but hot water will allow for greater output.)
4. Install a shut off water valve near the equipment to facilitate service. An in-line water filter should be used and installed after the water shut off valve and in a position to facilitate filter replacement.
5. Flush the water supply line and filter **before** connecting it to the unit.
6. Verify that the water line will deliver a flow rate of at least 1gpm/ (3.8lpm) per minute and water pressure is between 20-75 psig (0.31-0.517 mPa) (0.34MPa/50PSI preferred) before making any connections.
7. Use a wrench on the factory fitting when connecting the incoming water line. This will reduce stress on the internal connections and reduce the possibility of leaks developing after the install has been completed.

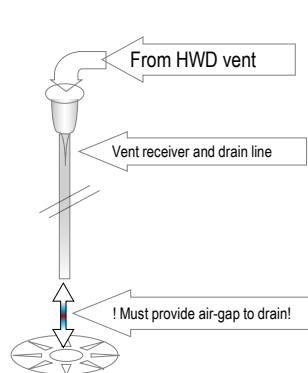
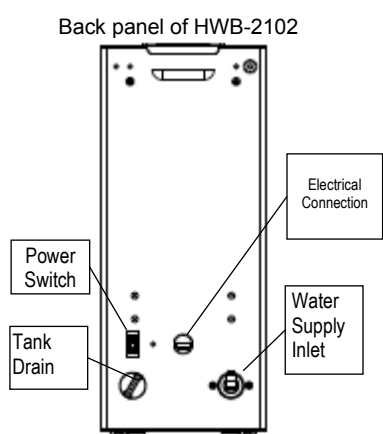

Attach a Vent Drain

NOTE→ When the HWD_2102 is initially filled and powered "ON", water may flow from the vent drain. This is normal, and caused by expansion of the large amount of cold water in the hot water tank.

All equipment with vent drains should be attached to tubing that exits into a plumbed drain system.

A drain line should be used for the tank vent. Materials: use $\frac{1}{4}$ " i.d. heavy wall silicone tubing or $\frac{3}{8}$ " i.d. rigid tubing only.

IMPORTANT: Allow a 4" to 12" air-gap from the end of the drain line to main drain.

NOTE→ Consult local plumbing codes.

Electrical Connection: Always refer to the wiring diagrams when connecting equipment electrical utilities

8. If Cord Connected: Do not use multiple taps for the plug. Consult local codes to determine if a single circuit is required for the cord and plug installed. Do not use extension cords for commercial food equipment
9. Verify that the actual voltage at the electrical service connection is compatible with the specifications on the equipment serial number label. Make sure the electrical service will match the current draw of the equipment.
10. Access the terminal block for electrical connection in the front of the unit by following the illustration above.
11. A fused disconnect switch or circuit breaker on the incoming power line must be conveniently located near the equipment and its location and markings known to the operators.
12. The body of the unit must be grounded to a suitable building ground.

Tank Drain

The water tank must be drained before maintenance procedures, and when the unit is to be relocated or shipped.

13. Disconnect power to the unit.
14. Move the unit near a sink or obtain a container to large enough to hold four gallons of water.
15. Remove the tank cover and allow the tank to cool to a safe temperature.
16. The tank drain is located on the back of the unit. Turn the drain plug one-quarter turn in either direction.
17. Pull the plug out far enough to expose the silicone tube.
18. Using pliers loosen the hose clamp and move it back over the tube.
19. Crimp the tube an inch or two away from the drain plug to prevent water from flowing.
20. Use the other hand to pull the drain plug out of the tube.
21. Release the crimped tube and allow the water to flow into the sink or container. Tank capacity is 2.0 gal/7.5 liter

Final Setup

1. Turn on the incoming water supply line and inspect both inside and outside of the equipment for leaks in all fittings and tubes
2. Turn on the incoming power.
3. Turn on the power switch, located in the back of the unit.
4. The LED indicator lights will show “Heating” (see illustration Page 4) on start-up
5. The hot water tank will begin filling and will stop when the water is sensed by the probe at the top of the tank. The heaters are disabled by the control board until the tank is full. Unit may need to be restarted during first fill.
6. The temperature and water tank fill level are pre-set at the factory. There is no need to turn off the heaters during the installation process. The heaters are disabled by the control board until the tank is full of water. The heating process will start automatically when the tank has filled.
7. Heaters will turn on when covered by water. Touch Panel displays status while the water is heating—there is no “Filling” light. After the water has reached the set temperature, the “ready” icon will turn on.
8. Inspect for leaks. Look closely in the top and beneath the equipment and check all fittings during this inspection.

Operator Training

Review the operating procedures with the equipment operators. Pay attention to the following areas:

1. Show the location and operation of the water shut off valve as well as the circuit breaker for the unit.
2. We recommend leaving the power to the equipment on overnight. The water tank is well insulated and will use very little electricity to keep the tank hot. Leaving the equipment in the “on” position will also avoid delays at the beginning of shifts for the hot water dispenser to reach operating temperature.

Standby heat loss is ≤ 100 watts per hour.

Installation safety and hygiene directions-For International and CE equipment

1. Access to the service area is restricted to persons having safety/hygiene knowledge and practical experience of the coffee brewer. This appliance must be installed in locations where it can be overseen by trained personnel.
2. For proper operation, this appliance must be installed indoors where the temperature is between 10°C/50°F to 35°C/95°F. Drain and remove all liquid from equipment and lines if exposed to freezing temperatures.
3. All commercial cooking equipment, including this unit, is not intended for use by children or persons with reduced physical, sensory, or mental capabilities. Ensure proper supervision of children and keep them away from the unit.
4. Children should be supervised to ensure that they do not play hot beverage equipment.
5. This unit must be installed and serviced by qualified personnel only.
6. Installation must conform to all local electrical and plumbing codes. Installation by unqualified personnel will void the unit warranty and may lead to electric shock or burn, as well as damage to unit and/or its surroundings.
7. If the power cord requires repair or replacement-it must be performed by the manufacturer or authorized service personnel with the specified cord only from the manufacturer in order to avoid a hazard.
8. Review the dimensions for the unit and verify that it will fit properly in the space intended for it. Verify that the counter or table will support the total weight of the filled brewer and dispensers (See: Technical Data Page 2).
9. Place the brewer on the counter or stand. When the brewer is in position, level it front to back as well as side-to-side by adjusting the legs.
10. Do not tilt appliance more than 10° to insure safe operation.
11. Unit is for protected indoor use only. Do not steam clean or use excessive water on unit.
12. This unit is not “jet-proof” construction. Do not pressure wash or use jet spray to clean this unit.
13. The unit is not waterproof-do not submerge or saturate with water.

Do not operate if unit has been submerged or saturated with water.

Equipment exposed to flood and contaminated must not be used due to electrical and food safety.

Parts Diagrams

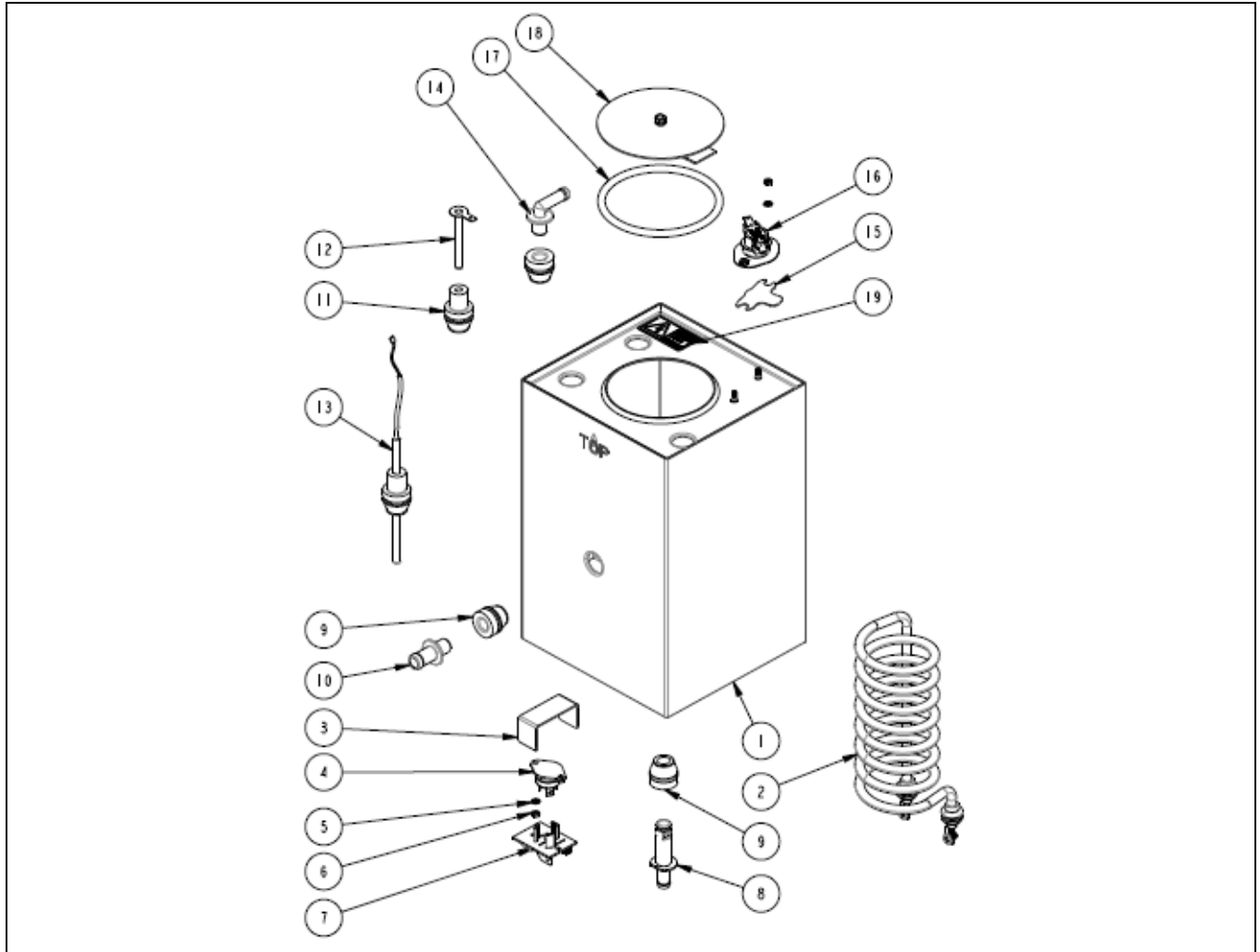

Drawing 1104.00150.00 TANK ASSEMBLY, HWD-2102

REF	QTY	Part Number	NAME
1	1	1114.00149.00	TANK WELDMENT, HWD-2102, GROMMET DESIGN
1	1	1107.00014.00	HEATER ASSEMBLY, IMMERSION 1440W/120VAC
1	1	1107.00008.00	HEATER ASSEMBLY, IMMERSION 2100W/120VAC
2	1	1107.00015.00	HEATER ASSEMBLY IMMERSION, 3200W/240VAC
3	1	1003.00109.00	BRACKET, HEAT SINK
4	1	1059.00001.00	TRIAC 40A, 600V
5	4	1083.00009.00	WASHER, #6 SCREW , INTL TOOTH LOCKWASHER
6	4	1084.00010.00	NUT, HEX, #6-32, UNDERSIZED, ZINC PLATED
7	1	1051.00016.00	BOARD, TRIAC DRIVE WITH RC FILTER
8	1	1023.00166.00	FITTING, COLD WATER INLET, GROMMET DESIGN
9	3	1024.00050.00	GROMMET, SILICONE, 11.4mm ID
10	1	1023.00167.00	FITTING, BREW, GROMMET DESIGN
11	2	1024.00053.00	LEVEL AND TEMP PROBE GROMMET
12	1	1112.00002.00	PROBE WELDMENT, WATER LEVEL 2.25" LG
13	1	54026	PROBE, TEMPERATURE 5" LONG, 50k
14	1	1023.00183.00	FITTING, DILUTION, TBS-2121
15	1	1003.00005.00	BRACKET, ONE SHOT THERMOSTAT
16	1	1053.00004.00	THERMOSTAT, SINGLE SHOT, 25A
17	1	1024.00007.00	O-RING, DASH #344, TANK COVER
18	1	1102.00007.00	TANK COVER ASSEMBLY
19	1	1044.00004.00	LABEL, DANGER, HIGH VOLTAGE

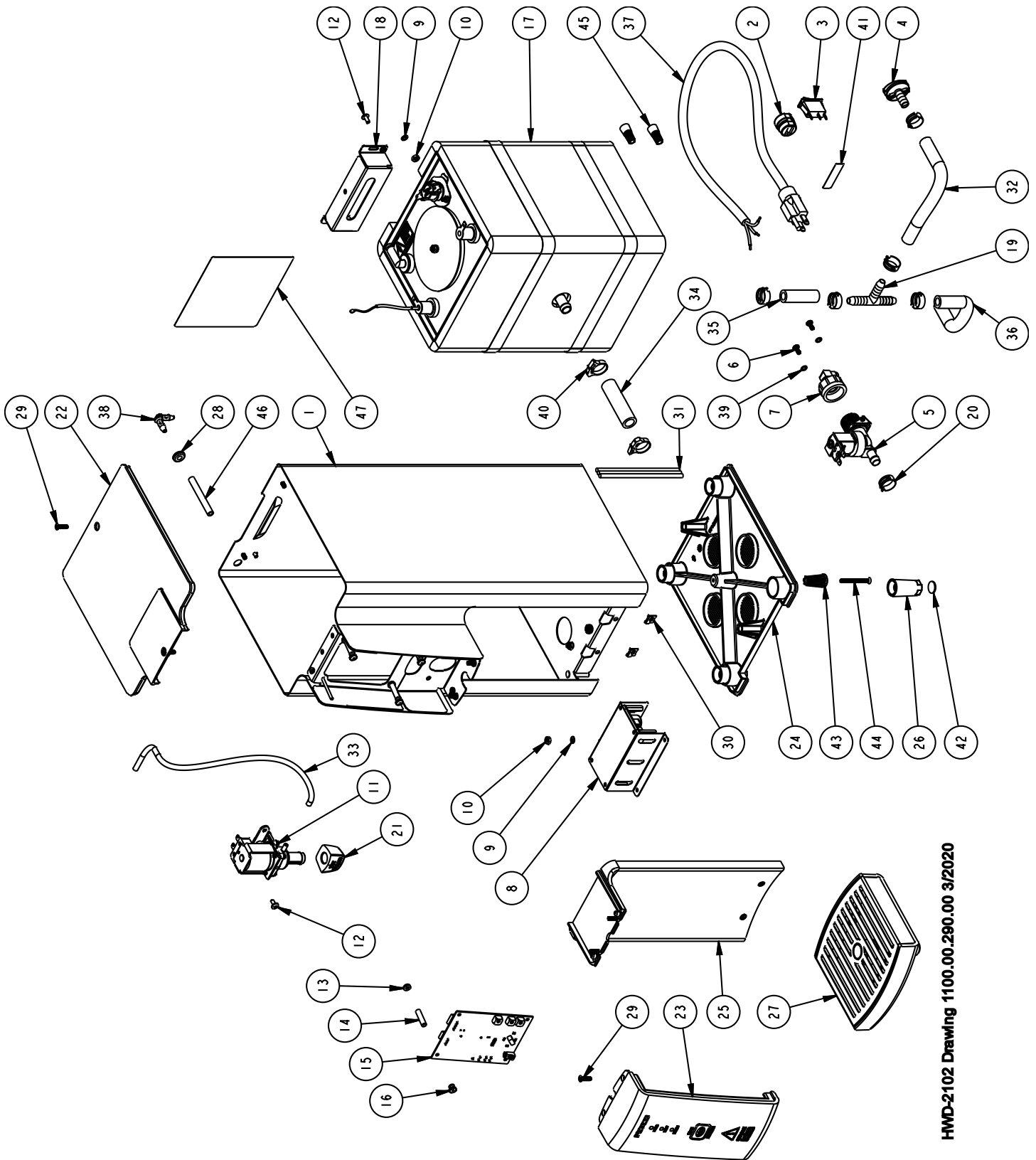

HWD-2102 Drawing 1100.00.290.00 3/2020

REF	QTY	Part Number	NAME	Parts Breakdown HWD-2102, Drawing 1101.00290.00
1	1	1111.00028.00	BODY, WELDMENT, HWD-2102	
2	1	1086.00020.00	BUSHING, STRAIN RELIEF, .425"-.475" DIA CABLE	
3	1	1058.00020.00	SWITCH, PWR ROCKER RED, ILLUM. 250VAC	
4	1	1023.00147.00	PLUG, TANK SERVICE DRAIN FOR 18 GA AND UP BODY	
5	1	1057.00059.00	VALVE, 0.66 GPM BRN FLOW REG, 180DEG/24VDC	
6	2	1082.00010.00	SCREW, PAN HD. PHIL. MACH., M4x10 ZINC-PLATED	
7	1	1102.00164.00	ADAPTER ASSY, 3/4" BSP X 1/4 SAE FLARE	
8	1	1102.00159.00	POWER SUPPLY ASSEMBLY, HWD-2100	
9	4	1083.00011.00	WASHER, #8 SCREW SIZE, INTERNAL TOOTH LOCK	
10	4	1084.00006.00	NUT, 8-32 18-8 HEX MACHINE SCREW	
11	1	1102.00179.00	DISPENSE VALVE ASSEMBLY, HWD-2102	
12	4	1082.00023.00	SCREW, #8-32 X 3/8 TRUSS HD PHIL., MACHINE	
13	4	1083.00010.00	WASHER, #10 SCREW W/NEOPRENE-BONDED SEAL	
14	4	1029.00020.00	SPACER, RND. UNTREADED, #6 SCREW SIZE, 1/4" OD X 1"LG.	
15	1	1108.00021.00	BOARD ASS'Y., SOFTWARE, HWD-2102 EXPORT	
16	4	1029.00018.00	NUT, #6 KNURLED THUMB	
17	1	1104.00150.00	TANK ASS'Y., HWD-2102, 1440W/120VAC	
17	1	1104.00151.00	TANK ASS'Y., HWD-2102, 2100W/120VAC	
17	1	1104.00148.00	TANK ASS'Y., HWD-2102, 3200W/240VAC	
18	1	1112.00115.00	BRACKET WELDMENT, TANK LOCK, HWD-2100	
19	1	1029.00002.00	FITTING, HOSE BARB TEE, SIZE 3/8"	
20	6	1086.00003.00	UNICLAMP, 15.9 HOSE OD CLAMP	
21	1	1029.00017.00	FAUCET, SILICONE, HWD-2100	
22	1	1023.00153.00	TOP COVER, HWD-2102	
23	1	1102.00250.00	ASSEMBLY FRONT PANEL, MEMBRANE SWITCH, HWD-2102	
24	1	1023.00154.00	BOTTOM BASE, HWD-2102	
25	1	1023.00152.00	FRONT PANEL BOTTOM, HWD-2102	
26	4	1023.00136.00	LEG, HWD-2100	
27	1	1102.00156.00	DRIP TRAY ASSEMBLY, HWD-2100	
28	1	1024.00041.00	PUSH IN GROMMET, 1/4"ID (7/16" PANEL HOLE)	
29	10	1082.00058.00	SCREW, # 8-32 X 5/8, FLAT HD, PH, 18-8 SS	
30	2	1084.00027.00	NUT, CLIP ON (J-NUT), #8-32, 18-16 GA., BPF	
31	1	1402.00071.00	HARNESS, UNIVERSAL RETROFIT, HWD-2102	
32	1	1025.00039.00	TUBE, 5/8" OD X 3/8 ID X 10" LG, DRAIN	
33	1	1025.00040.00	TUBE, 1/4" OD X .125" ID X 16" LG, VENT	
34	1	1025.00017.04	TUBE, SILICONE, 3/4" OD X 1/2" ID X 3.00" LG, DISPENSE	
35	1	1025.00042.00	TUBE, 5/8" OD X 3/8" ID X 2" LG, BOTTOM TANK	
36	1	1025.00046.00	TUBE, 5/8" OD X 3/8" ID X 5.0" LG, DOUBLE VALVE	
37	1	1063.00016.00	POWER CORD, 120VAC W/NEMA 5-15P PLUG	
37	1	1063.00015.00	POWER CORD, 120 VAC, 12/3 AWG .20 AMP , W/5-20P NEMA PLUG	
37	1	1063.00032.00	POWER CORD., NEMA 6-15P, 15A/250V, W/O TERMINALS	
38	1	1029.00023.00	FITTING, SINGLE BARBED ELBOW, 1/4", KYNAR	
39	2	1083.00005.00	WASHER, M4 18-8 SS, INT. TOOTH LOCKWASHER	
40	2	1086.00002.00	CLAMP, HOSE, SIZE "G" NYLON	
41	1	1044.00001.00	LABEL "FOR USE ON IND. CIRCUIT"	
42	4	1029.00025.00	FOOT, ANTI-SLIP, 0.60" DIA DISC	
43	1	1023.00155.00	PLUG, BOTTOM BASE, HWD-2100	
44	1	1082.00091.00	SCREW #8-32 X 1.75" FLAT HD PH, MACHINE	
45	2	1064.00004.00	WIRE CONNECTOR, SCREW ON, MODEL 74B, YELLOW	
46	1	1025.00045.00	TUBE, 5/16" OD X 3/16" ID X 2.5" LG, PROP VALVE	
47	1	1046.00035.00	LABEL, WARNING "TO REDUCE RISK OF ELECTRIC SHOCK OR FIRE"	

Wiring Diagram

FETCO FOOD SERVICE TECHNOLOGY COMPANY
 2150 S. MARIANA AVE. #100
 TAMPA, FL 33629
 PHONE: 813-281-1000 FAX: 813-281-1001
 WWW.FETCO.COM

ZWS: MARD
 WIRING: HWD-2102, Q.L., N + GND, 1 HEATER, UNIVERSAL

DRAWING NO.
 1401.00049.00

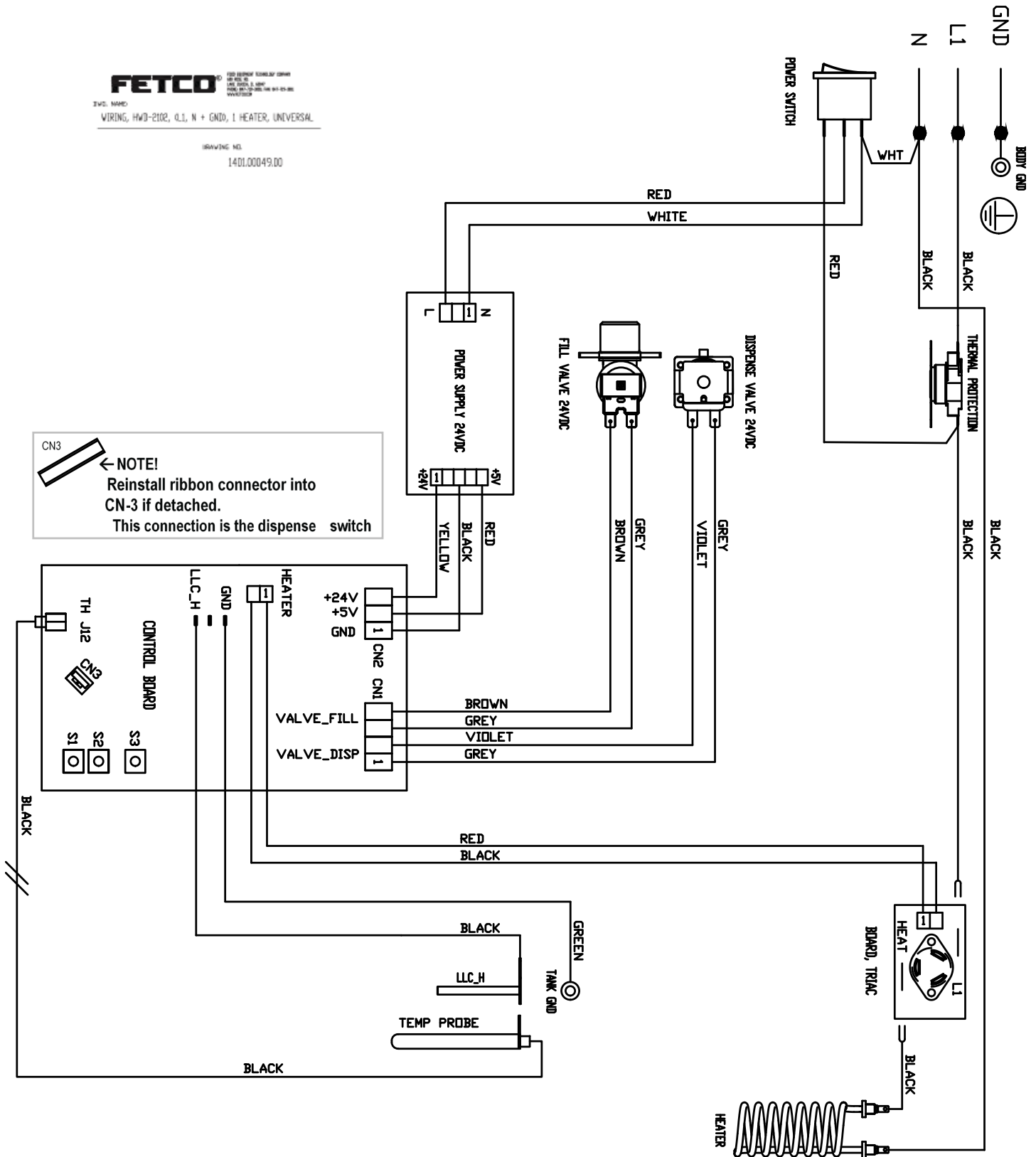

NOTE!
 Reinstall ribbon connector into CN-3 if detached.
 This connection is the dispense switch

▶ Hot Water Dispenser HWD_2102 With Portion Control Domestic and Export Version



This user guide is only for FETCO HWD-2102 models built **before** March 2020.

Table of Contents

Operator And User Sections

Operating Instructions.....	3
Operating Principles	4
Error Messages	6
Cleaning & Maintenance.....	7

Professional Service Sections

Equipment Setup	8
Parts Diagrams.....	10
Wiring Diagram.....	13

Contact Information

FETCO®

Food Equipment Technologies Company
600 Rose Road
Lake Zurich • IL • 60047-0429 • USA

Internet: www.fetco.com

©2013-2018 Food Equipment Technologies Company



fetco.com

Go to fetco.com for the latest version of all information

Phone: (800) 338-2699 (US & Canada)
(847) 719-3000

Fax: (847) 719-3001

Email: sales@fetco.com

techsupport@fetco.com

PATENTS: WWW.fetco.com/patents

P119 August 2019



FETCO HWD-2102 push-button commercial hot water dispensers with portion control

Electrical Configurations								
Configuration Code	Heater Configuration	Voltage	Phase	Wires	Electrical Connection	KW	Amp Draw	Flow Rate* Per hour
H210210	1 X 1.4 KW	100-120	single	2+G	NEMA 5-15P	1.5	12.5	3.6 Gal/13.6 liters
H210220	1 X 2.1 KW	100-120	single	2+G	NEMA 5-20P	2.2	18.3	5.4Gal/20.4 liters
H210230	1 X 3.2 KW	200-240	single	2+G	NEMA 6-15P	3.3	13.8	8.2Gal/31.0 liters
H210240	1 X 3.2 KW	200-240	single	2+G	cord only without plug	3.3	13.8	8.2Gal/31.0 liters

*Flow rate based on 55°F/13°C water mains supply and dispensing From (“READY” Light ON)
 Portion Control: factory calibrated to dispense portion of 200ml/6.8oz—at timer setting: 5sec
 Portion control is user selectable: 40-1200cc/1.4-40.6fl.oz. Portion size is controlled by setting dispense timer.
 Actual portions and temperatures shown are estimated and are influenced by mains flow rate and temperature

Power Plug Configurations

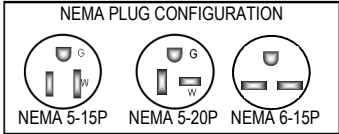

NEMA 5-15P NEMA 5-20P NEMA 6-15P

Please see wiring diagrams located in back pages for installation notes.

Specifications and Requirements								
Capacities & Measurements								
Brewer	Height	Width	Depth	Empty Weight	Filled Weight	Hot Water Tank Capacity	Shipping Weight	Shipping Dimensions
HWD-2102	19 ¹ / ₃₂ inch 483 mm	8inch 203 mm	16 ¹ / ₈ inch 410 mm	19 lb 8.6kg	36 lb 16.3kg	1.8 gal 6.9 liter	25lb 11.3kg	26 X 13 X 17in 660 X 330 X 432mm

Water Requirements
Water Connection: Inlet: 3/8 inch male flare fitting Mains Pressure: 20-75 psig (138-0.517 mPa) (45psi/0.310 mPa preferred) Minimum Flow Rate: 1½ gpm All commercial hot water dispensers to be supplied with filtered water from mains
The following are the factory settings—and range of variables that are adjustable: Portion Control: Delivery volume: factory set at 16 seconds=630ml/21.3oz (Portion control is user selectable from minimum to maximum single dispense is 40ml/1.4 ounces to 1200ml/40.5 ounces by 1 sec to 30seconds timer adjustment) Temperature Control: Water temperature is factory set at maximum—88°C/190°F (Temperature is user selectable 87-96°C/189° to 205°F) Hot Water Tank Temperature, as set by factory: 96°C/205°F inside water tank (at sea level) Electrical Requirements: See electrical configuration charts (above).

Dimensions & Utility Connections HWD_2102

DRAWING1201.00005.00

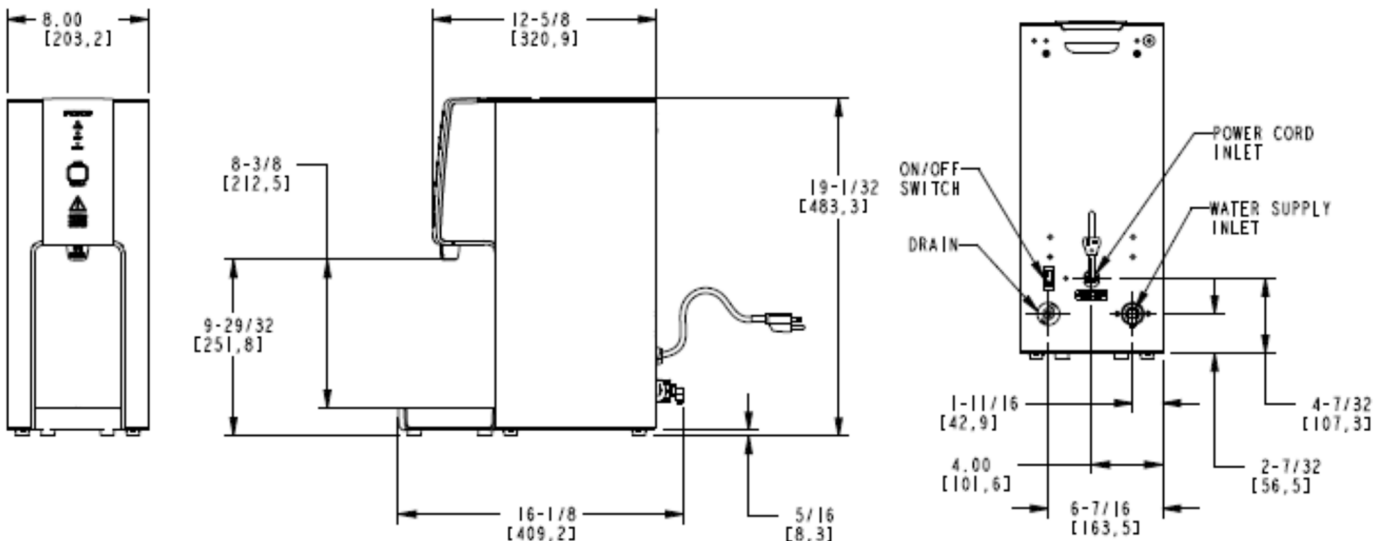

Operating Instructions

To Start:

Follow equipment installation and set up procedures.

If desired, set any custom dispense temperature or dispense volume

→ *Instructions for setting dispense temperature & volume located on page 5*

1. Open water supply valve
2. Power unit "ON" from rear power switch.
3. →Unit will fill and heat (up to 20 minutes for a new unit).
-After unit is filled and heated:
4. Ready Lamp will glow green
5. HWD_2102 may be operated when Ready Lamp is "off" (after initial fill).
6. When ready: the white control panel backlight intensity will slowly pulsate.

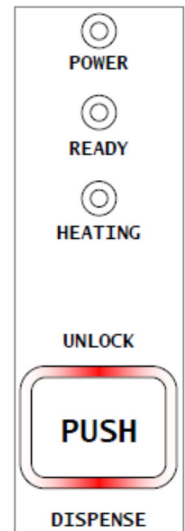

NOTE→ the HWD_2102 should be left "ON". The hot water tank is well insulated to control energy loss. Standby heat loss is ≤ 100 watts per hour.

HWD_2102 has two dispense modes: **MANUAL** and **PORTION CONTROLLED**

To dispense with **MANUAL CONTROL**—[Press and Hold!]

- 1) Press UNLOCK/DISPENSE pad for 1-3 seconds to unlock and activate dispensing system
-Border of UNLOCK/DISPENSE pad will change: turning steady red signaling activation
- 2) Remove finger from pad
-Border of UNLOCK/DISPENSE pad will **glow steady red: ready to dispense**
- 3) Press center of UNLOCK/DISPENSE pad to dispense.
-Keep finger on pad until dispense is complete.
-Dispense automatically stops when time out is complete, or if finger is removed.

Multiple dispenses are possible when the UNLOCK/DISPENSE light pad is steady and red colored
Reactivate next dispense portion by retouching pad. Finger must be on pad to dispense.

To dispense with **PORTION CONTROL**—[Touch and Hold!]

- 1) Press and hold UNLOCK/DISPENSE pad for 3 seconds to unlock and activate dispensing system.
-Border of UNLOCK/DISPENSE pad will **rapidly strobe signaling activation**
- 2) Remove finger from pad
-Selected portion will automatically complete
- 3) If needed: tap center of UNLOCK/DISPENSE pad to stop dispense.
-Dispense automatically stops when time out is complete, or if pad is tapped again.

NOTE→ Dispense is unlocked and will function only when border of UNLOCK/DISPENSE pad is steady red.

The UNLOCK/DISPENSE pad rapidly flashes red if finger remains on it after dispensing without dispensing.

If finger remains on the UNLOCK/DISPENSE pad more than 30 seconds while rapidly flashing red-the controls "lock out" and READY LIGHT & HEATING LIGHT will flash rapidly to show a fault state.

NOTE→All controls are disabled during fault state. **To clear fault state:**

Switch machine "OFF" for about ten seconds, and then toggle back "ON" (Control Reset).

After controls initiate, hot water tank level and temperature are checked by internal electronics-

The "READY" light will activate if digital check is "clear".

NOTE→ The check and fault clear may take approximately 2 minutes for filled and preheated unit; up to 20-30 minutes for a new and empty unit.

LAYOUT DIAGRAM FOR HWD_2102 HOT WATER DISPENSER CONTROL PANEL

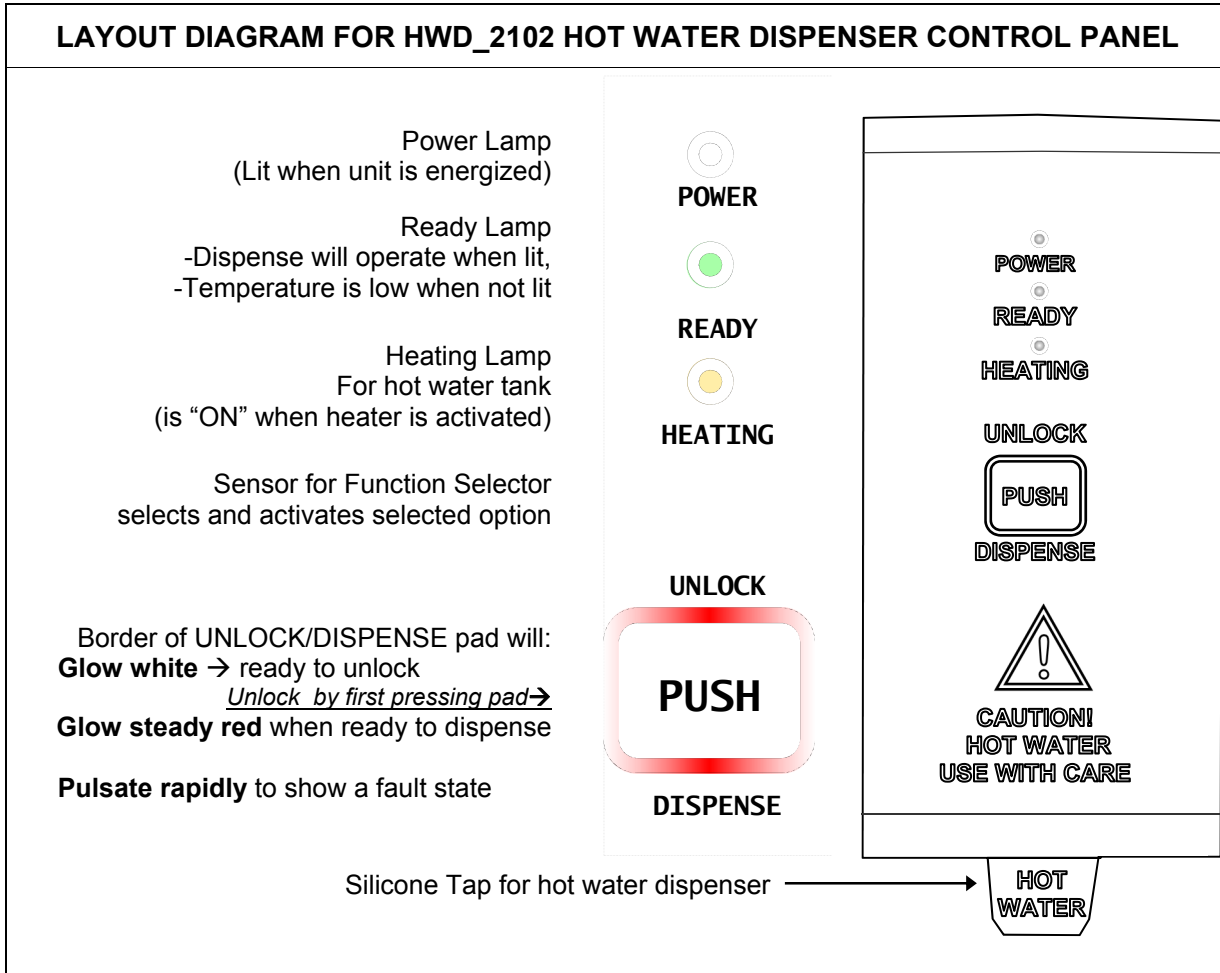

Operating Principles

The HWD_2102 delivers precision portions of water at selected volume and temperature.

Unit is factory set at 96°C/205°F. The green “READY” lamp must be lit.

If the green “READY” lamp is not lit the unit will dispense water-but not at selected temperature.

Unit is factory calibrated at the optimum dispense portion of 200ml/6.8oz).

Automatic portion dispense is by pressing “DISPENSE” and removing finger.

Larger or different portion may be overridden by maintaining “ON” activation

Hot water is drawn from the faucet, the fill valve cycles on and off to replenish the hot water tank.

When dispensing water at a rate that exceeds the unit’s capacity to heat, the ready light will go off to show that the selected preset temperature is not available. Always observe the “READY” lamp

When the green “READY” lamp is lit – proper dispense temperature is enabled.

When heating or reheating, the green “READY” light will turn off and the “HEATING” light will display

The dispense valve faucet is protected by a silicone bumper over the tap.

NOTE→ Dispense flow rate is given for typical 50psi/0.310mPa water supply pressure.

!Differences in water supply pressure affect flow rate, and quantity of hot water dispensed!

NOTE→ After exceeding the maximum optimum dispense portion of 20fl.oz/600cc the hottest water supply in the hot water tank begins to become depleted. The “READY” lamp will turn off. Dispenser faucet does not “lock-out” and may allow less heated water to dispense. For the highest selected dispense when “READY” lamp is lit.

NOTE→ When the HWD_2102 is powered on (or after controller reset) - the controls check and adjust tank level and temperature. Allow approximately 2 minutes for filled and heated unit; up to 20-30 minutes for a new and empty unit.

Two Upper Dials (Marked: S3 and S2)

Temperature selection.

Base temperature begins at 50°C/122°F, in Celsius units.
 -Factory set, is 88°C/190°F.
 Add dial position numerical value in degrees Celsius (°C) to 90° base to a maximum of 97°C/207°F

DIAL SETTING POSITIONS		SETTING EXAMPLES			
Temperature Setting S2 (Lower dial)	Temperature Setting S3 (Upper dial)	DIAL		Deg.	Deg.
		S2	S3	C	F
NA	0 (0)	6	6	66	150
NA	1 (+1)	7	1	71	160
NA	2 (+2)	7	7	77	170
NA	3 (+3)	8	2	82	180
NA	4 (+4)	8	5	85	185
5 (+50)	5 (+5)	8	8	88	190
6 (+60)	6 (+6)	9	3	93	199
7 (+70)	7 (+7)	9	4	94	201
8 (+80)	8 (+8)	9	6	96	205
9 (+90)	9 (+9)	9	7	97	207

IMPORTANT When Changing Settings:

Switch machine "OFF" for about ten seconds, and then toggle back "ON" (Control Reset) after adjusting dials, or following reassembly and plugging in.

Remove all screws and panels to access control board for adjustments.

Pull off silicone tap guard

Reinstall
 1) Lower face panel first,
 2) Upper face panel next,
 3) Top panel last

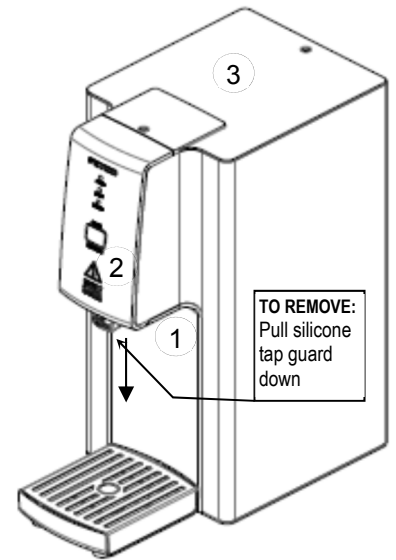

Remove covers to access dials for setting temperature and dispense volume.

Do not operate unless all covers and screws in place
 Unplug machine before disassembly or changing settings.

Switch machine "OFF" for about ten seconds, and then toggle back "ON" (Control Reset)

S1 Timer Dial (Bottom Dial, Marked: S1)

For dispense time and volume to be delivered

This dial controls flow for 4 seconds to 40 seconds or approximately 158-1575ml or 5-55 fluid ounces.

For best temperature regulation-do not exceed 16 seconds.

Brewer is factory set at dial position-"3"
 Calibrated to 16 sec—the maximum optimum dispense portion of 21fl ounces or 630 ml.
 Each dial position of 0-9 increments is four seconds from the base of position "0" (at four seconds)

Bottom dial marked S1		Dispenses (approximately)	
Dial position	Sec	ml	ounces
0	4	158	5.3
1	8	315	10.7
2	12	473	16
3	16	630	21.3
4	20	788	26.6
5	24	945	32
6	28	1103	37.3
7	32	1260	42.6
8	36	1418	48
9	40	1575	53.3

Dial S3

Set temperature

Temperature on dials starts at 50°C (97°C shown)
 Each number 1 °C

Dial S2

Set temperature

Temperature on dials starts at 50°C (97°C shown)
 Each number 10 °C

Dial S1

Set Portion (time)

Units are 4 sec intervals
 0 starting at 4 seconds
 Shows 16 seconds

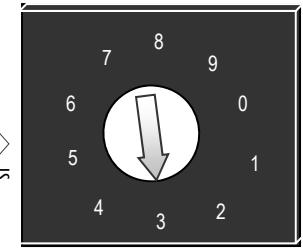
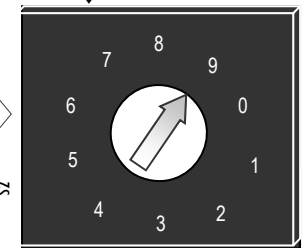
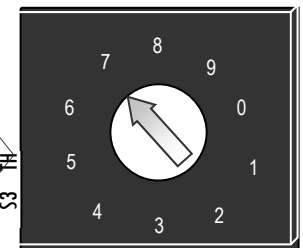

Adds to 97°C

TEMPERATURE SETTING DIALS

Correction for altitude table			
Altitude		Boiling Point	
(ft)	(m)	(°f)	(°c)
-250	-76	212.5	100.3
0	0	212	100
500	152	211	99.5
1000	305	210.1	98.9
1500	457	209.1	98.4
2000	610	208.1	97.8
2500	762	207.2	97.3
3000	914	206.2	96.8
3500	1067	205.3	96.3
4000	1219	204.3	95.7
4500	1372	203.4	95.2
5000	1524	202.4	94.7
5500	1676	201.5	94.2
6000	1829	200.6	93.6
6500	1981	199.6	93.1
7000	2134	198.7	92.6

Error Messages

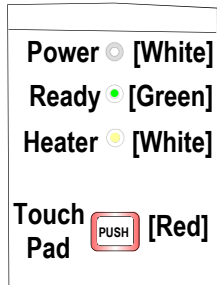

The UNLOCK/DISPENSE pad rapidly flashes red if finger remains on it after dispensing and no water is dispensed.

If finger remains on the UNLOCK/DISPENSE pad more than 35 seconds while rapidly flashing red-the controls “lock out” and READY LIGHT & HEATING LIGHT will flash rapidly to show a fault state. See keyboard errors 1 & 2 in chart below

All controls are disabled during fault state.

To clear Fault State:

Switch machine “OFF” for about ten seconds, and then toggle back “ON” (Control Reset)

After controls initiate, hot water tank level and temperature are checked- then the “READY” light will activate.

NOTE→ This will take approximately 2 minutes for filled and heated unit; up to 20-30 minutes for a new/empty unit

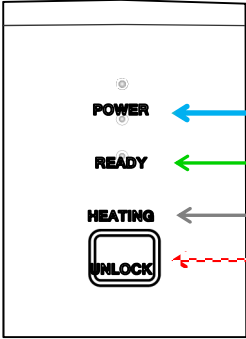
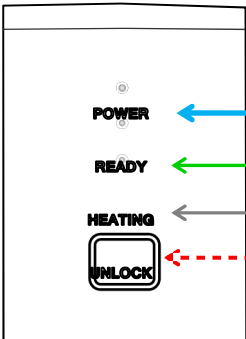
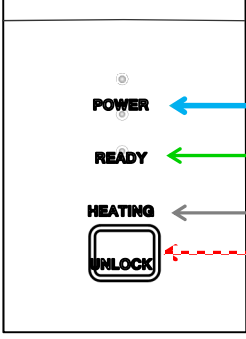
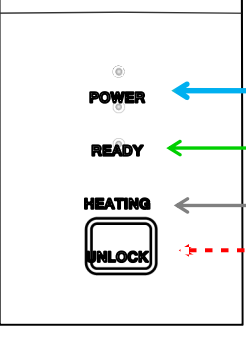
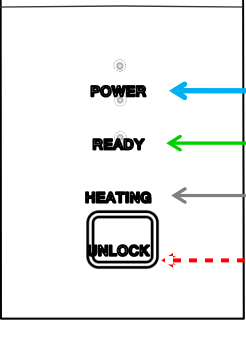
 <p>POWER ← (Steady) READY ← (1X slower blinking) HEATING ← (2X faster blinking) UNLOCK ← (Inactive)</p>	<p><u>Problem with Water Supply</u> <u>-INITIAL FILL</u></p> <p>Power lamp—(steady) READY lamp →(1X) slower blinking HEATING lamp →(2X) faster blinking Touch Pad →(INACTIVE)</p>	<p>* * * □</p>	<p>Hot water tank not filled in 6 minutes. Problem with water supply. Problem with fill valve.</p>
 <p>POWER ← (Steady) READY ← (1X slower blinking) HEATING ← (2X faster blinking) UNLOCK ← (Glowing Bright White)</p>	<p><u>Problem with Water Supply</u> <u>-REFILL</u></p> <p>Power lamp—(steady) READY lamp →(1X) slower blinking HEATING lamp →(2X) faster blinking Touch Pad →(Glowing Bright White)</p>	<p>* * * □</p>	<p>Hot Water Tank not filling or refilling fast enough. Check water filter-replace if old. Problem with fill valve. Check water level probe, all connections and wires</p>
 <p>POWER ← (Steady) READY ← (2X faster blinking) HEATING ← (1X slower blinking) UNLOCK ← (Inactive)</p>	<p><u>Problem with Temperature Probe</u></p> <p>Power lamp—(steady) READY lamp →(2X) faster blinking HEATING lamp →(1X) slower blinking Touch Pad →(INACTIVE)</p>	<p>* * * □</p>	<p>Tank not heating Heater failure Check heat circuit Probe sheath flooded Check probe, connections and wires</p>
 <p>POWER ← (Steady) READY ← (2X faster blinking) HEATING ← (2X faster blinking) UNLOCK ← (First: Rapid flashing, Second: Inactive)</p>	<p><u>Problem with Touch Pad</u></p> <p>Power lamp—(steady) READY lamp →(2X) faster blinking HEATING lamp →(2X) faster blinking Touch Pad →First: Rapid flashing Second: Inactive</p>	<p>* * * * 1: □, □, □ 2: □</p>	<p>Finger left on touch pad too long after activating “DISPENSE”</p>
 <p>POWER ← (Steady) READY ← (2X faster blinking) HEATING ← (2X faster blinking) UNLOCK ← (Glowing Bright White OR Inactive)</p>	<p><u>Problem with Touch Pad</u></p> <p>Power lamp—(steady) READY lamp →(2X) faster blinking HEATING lamp →(2X) faster blinking Touch Pad →Glowing Bright White (OR-INACTIVE)</p>	<p>* * * * □</p>	<p>Front cover not fastened. Condensation on contacts Solvent or strong cleaner damaged face plate</p>

Cleaning & Maintenance

Daily:

1. Check the drip tray and empty if necessary.

Quarterly:

1. Inspect all fittings and hoses for leaks.
2. Inspect inside of tank for lime deposits. De-lime tank and probes if necessary.
(This procedure to be performed by a qualified service technician)

Notice:

Turn off power before any cleaning procedure, including wiping the exterior for appearance reasons.
Dry the exterior, especially the face panel, before turning on power.

WARNING:

1. Equipment is designed for commercial use only. Equipment is not for household use.
2. Do not apply any type of spray cleaner on the face panel of this equipment.
3. Never use solvent or solvent based cleaner or petroleum based polish on this equipment.
4. Dry the face of the HWD-2102 before turning on power.
5. No user serviceable parts; refer to qualified service technician for repair and adjustments.
6. Dangerous high voltage and high temperatures inside
7. Unplug machine before disassembly or changing settings
8. Operation requirements and maintenance for commercial cooking appliances differ from household appliances.
9. Operators must be trained for this equipment and must understand the use, maintenance and kitchen hazards.
10. Do not attempt to move hot beverage equipment once it is filled. Drain equipment before moving.
11. The HWD-2102 Hot Water Boilers provides very hot water from the faucet when it is pulled.
12. HWD-2102 may continue to dispense very hot water from the faucet after the electronic touchpad is completely disabled, or if the power is turned off, or by unplugging the unit.
13. Keep these instructions for training and future reference

WARNING-

Do not plug-in this equipment or attempt to operate without all covers in place and all screws fastened

Labels and warnings BACK PANEL of equipment
(1046.00035.00)











WARNING

All electrical connections must be in accordance with local electrical codes and any other applicable codes.
If the supply cord is damaged, it must be replaced by the manufacturer, its service agent, or similarly qualified persons in order to avoid a hazard.
To prevent an electric shock hazard this device must be bonded to equipment in close proximity with an equipotential bonding conductor. This device is equipped with a grounding lug for this purpose and is marked with the following symbol



For "CE" marked equipment only

	WARNING	To reduce risk of electric shock or fire.
		FETCO® Hot Beverage Equipment is for commercial use only.
		Do not remove or open cover. No user serviceable parts inside. Refer installation and service to qualified personnel.
		Caution, disconnect from power supply before servicing.
		GROUND: National Electrical Code requires separate grounding wire.
		Use dedicated circuit with capacity rated by local code or National Electrical Code for the current draw of this equipment. Check serial number plate on right side for power requirements.
		Locate unit away from source of heat. Do not install or use near combustibles.
		THIS APPLIANCE IS ENERGIZED WHENEVER IT IS CONNECTED TO A POWER SOURCE
		FAILURE TO COMPLY RISKS EQUIPMENT DAMAGE, PROPERTY DAMAGE, FIRE, OR SHOCK HAZARD
Notice		This equipment must be installed with a backflow protection device to comply with federal, state or local municipality codes.
Notice		Read the user guide before installing and operating this unit.

For qualified service technicians

Equipment Setup

1. Read User Guide noting all instructions. Review the dimensions for the unit you are installing.
2. Verify that it will fit in the space intended for it.
3. Verify that the counter or table will support the total weight of the equipment and any dispensers when filled.
4. Place the equipment on the counter or stand.

Water Connection

1. Water supply inlet is a $\frac{3}{8}$ inch male flare fitting.
2. The HWD-2102 Hot Water Dispenser can be connected to a cold or hot water line.
3. (Cold water is preferred for best beverage flavor, but hot water will allow for greater output.)
4. Install a shut off water valve near the equipment to facilitate service. An in-line water filter should be used and installed after the water shut off valve and in a position to facilitate filter replacement.
5. Flush the water supply line and filter **before** connecting it to the unit.
6. Verify that the water line will deliver a flow rate of at least $1\frac{1}{2}$ gpm/ (5.7lpm) per minute and water pressure is between 45-75 psig (0.31-0.517 mPa) (0.34MPa/50PSI preferred) before making any connections.
7. Use a wrench on the factory fitting when connecting the incoming water line. This will reduce stress on the internal connections and reduce the possibility of leaks developing after the install has been completed.

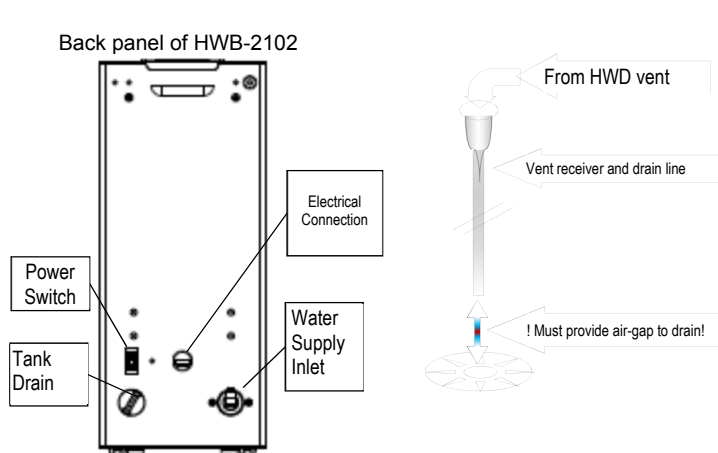

Attach a Vent Drain

NOTE→ When the HWD_2102 is initially filled and powered "ON", water may flow from the vent drain. This is normal, and caused by expansion of the large amount of cold water in the hot water tank.

All equipment with vent drains should be attached to tubing that exits into a plumbed drain system.

A drain line should be used for the tank vent. Materials: use $\frac{1}{4}$ " i.d. heavy wall silicone tubing or $\frac{3}{8}$ " i.d. rigid tubing only.

IMPORTANT: Allow a 4" to 12" air-gap from the end of the drain line to main drain.

NOTE→ Consult local plumbing codes.

Electrical Connection: Always refer to the wiring diagrams when connecting equipment electrical utilities

1. If Cord Connected: Do not use multiple taps for the plug. Consult local codes to determine if a single circuit is required for the cord and plug installed. Do not use extension cords for commercial food equipment
2. Terminal Block: The HWB-2100 model series requires grounded service to the terminal block (illus. 1)
3. Verify that the actual voltage at the electrical service connection is compatible with the specifications on the equipment serial number label. Make sure the electrical service will match the current draw of the equipment.
4. Access the terminal block for electrical connection in the front of the unit by following the illustration above.
5. A fused disconnect switch or circuit breaker on the incoming power line must be conveniently located near the equipment and its location and markings known to the operators.
6. The body of the unit must be grounded to a suitable building ground.

Tank Drain

The water tank must be drained before maintenance procedures, and when the unit is to be relocated or shipped.

1. Disconnect power to the unit.
2. Move the unit near a sink or obtain a container large enough to hold four gallons of water.
3. Remove the tank cover and allow the tank to cool to a safe temperature.
4. The tank drain is located on the back of the unit. Turn the drain plug one-quarter turn in either direction.
5. Pull the plug out far enough to expose the silicone tube.
6. Using pliers loosen the hose clamp and move it back over the tube.
7. Crimp the tube an inch or two away from the drain plug to prevent water from flowing.
8. Use the other hand to pull the drain plug out of the tube.
9. Release the crimped tube and allow the water to flow into the sink or container. Tank capacity is 2.0 gal/7.5 liter

Final Setup

1. Turn on the incoming water supply line and inspect both inside and outside of the equipment for leaks in all fittings and tubes
2. Turn on the incoming power.
3. Turn on the power switch, located in the back of the unit.
4. The LED indicator lights will show “Heating” (see illustration Page 4) on start-up
5. The hot water tank will begin filling and will stop when the water is sensed by the probe at the top of the tank. The heaters are disabled by the control board until the tank is full. Unit may need to be restarted during first fill.
6. The temperature and water tank fill level are pre-set at the factory. There is no need to turn off the heaters during the installation process. The heaters are disabled by the control board until the tank is full of water. The heating process will start automatically when the tank has filled.
7. Heaters will turn on when covered by water. Touch Panel displays status while the water is heating—there is no “Filling” light. After the water has reached the set temperature, the “ready” icon will turn on.
8. Inspect for leaks. Look closely in the top and beneath the equipment and check all fittings during this inspection.

Operator Training

Review the operating procedures with the equipment operators. Pay attention to the following areas:

1. Show the location and operation of the water shut off valve as well as the circuit breaker for the unit.
2. We recommend leaving the power to the equipment on overnight. The water tank is well insulated and will use very little electricity to keep the tank hot. Leaving the equipment in the “on” position will also avoid delays at the beginning of shifts for the hot water dispenser to reach operating temperature.
Standby heat loss is ≤ 100 watts per hour.

Installation safety and hygiene directions-For International and CE equipment

1. Access to the service area is restricted to persons having safety/hygiene knowledge and practical experience of the coffee brewer. This appliance must be installed in locations where it can be overseen by trained personnel.
2. For proper operation, this appliance must be installed indoors where the temperature is between 10°C/50°F to 35°C/95°F. Drain and remove all liquid from equipment and lines if exposed to freezing temperatures.
3. All commercial cooking equipment, including this unit, is not intended for use by children or persons with reduced physical, sensory, or mental capabilities. Ensure proper supervision of children and keep them away from the unit.
4. Children should be supervised to ensure that they do not play hot beverage equipment.
5. This unit must be installed and serviced by qualified personnel only.
6. Installation must conform to all local electrical and plumbing codes. Installation by unqualified personnel will void the unit warranty and may lead to electric shock or burn, as well as damage to unit and/or its surroundings.
7. If the power cord requires repair or replacement-it must be performed by the manufacturer or authorized service personnel with the specified cord only from the manufacturer in order to avoid a hazard.
8. Review the dimensions for the unit and verify that it will fit properly in the space intended for it. Verify that the counter or table will support the total weight of the filled brewer and dispensers (See: Technical Data Page 2).
9. Place the brewer on the counter or stand. When the brewer is in position, level it front to back as well as side-to-side by adjusting the legs.
10. Do not tilt appliance more than 10° to insure safe operation.
11. Unit is for protected indoor use only. Do not steam clean or use excessive water on unit.
12. This unit is not “jet-proof” construction. Do not pressure wash or use jet spray to clean this unit.
13. The unit is not waterproof-do not submerge or saturate with water.

Do not operate if unit has been submerged or saturated with water.

Equipment exposed to flood and contaminated must not be used due to electrical and food safety.

Parts Diagrams

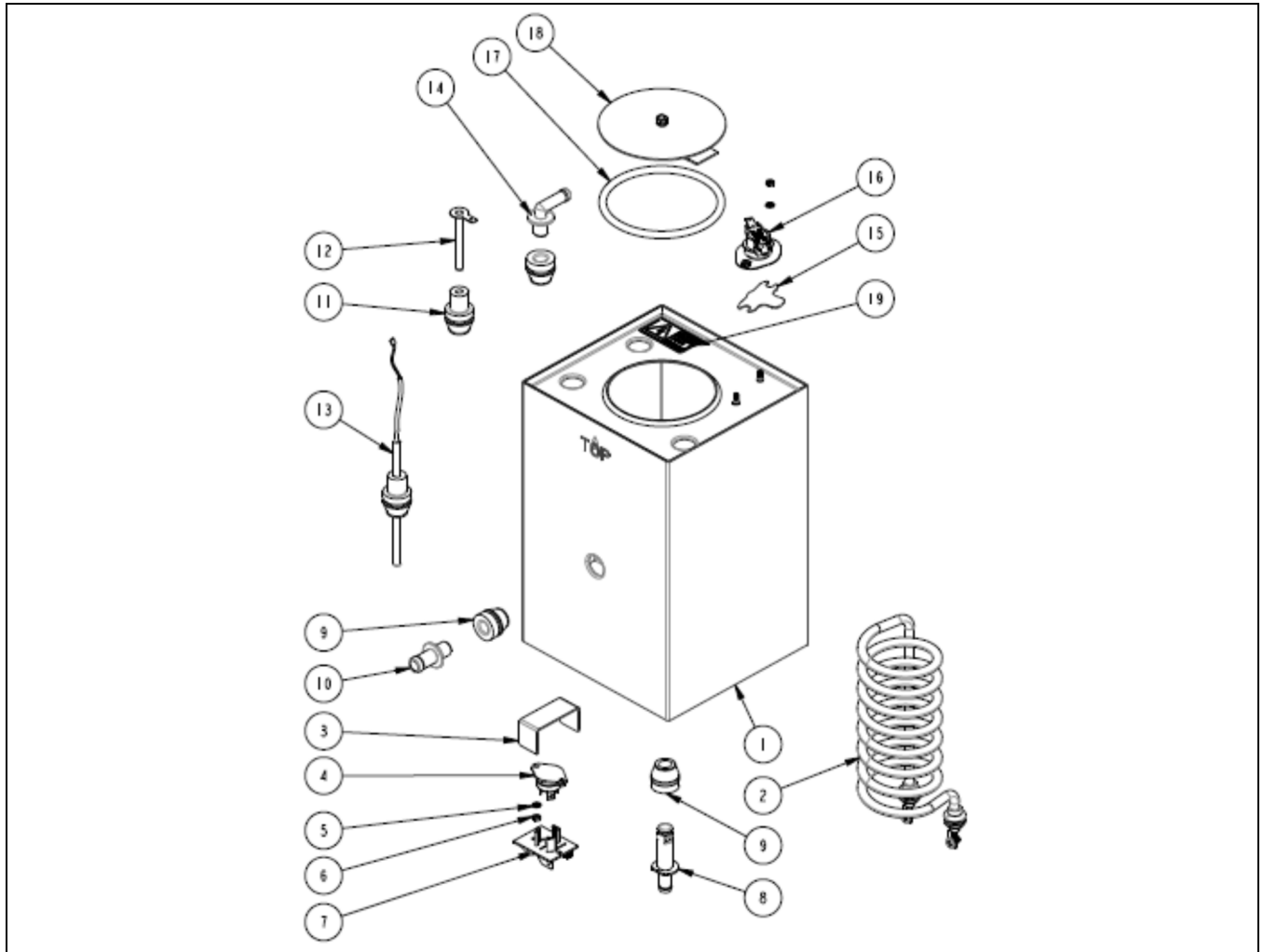

Drawing 1104.00150.00 TANK ASSEMBLY, HWD-2102

REF	QTY	Part Number	NAME
1	1	1114.00149.00	TANK WELDMENT, HWD-2102, GROMMET DESIGN
1	1	1107.00014.00	HEATER ASSEMBLY, IMMERSION 1440W/120VAC
1	1	1107.00008.00	HEATER ASSEMBLY, IMMERSION 2100W/120VAC
2	1	1107.00015.00	HEATER ASSEMBLY IMMERSION, 3200W/240VAC
3	1	1003.00109.00	BRACKET, HEAT SINK
4	1	1059.00001.00	TRIAC 40A, 600V
5	4	1083.00009.00	WASHER, #6 SCREW , INTL TOOTH LOCKWASHER
6	4	1084.00010.00	NUT, HEX, #6-32, UNDERSIZED, ZINC PLATED
7	1	1051.00016.00	BOARD, TRIAC DRIVE WITH RC FILTER
8	1	1023.00166.00	FITTING, COLD WATER INLET, GROMMET DESIGN
9	3	1024.00050.00	GROMMET, SILICONE, 11.4mm ID
10	1	1023.00167.00	FITTING, BREW, GROMMET DESIGN
11	2	1024.00053.00	LEVEL AND TEMP PROBE GROMMET
12	1	1112.00002.00	PROBE WELDMENT, WATER LEVEL 2.25" LG
13	1	54026	PROBE, TEMPERATURE 5" LONG, 50k
14	1	1023.00183.00	FITTING, DILUTION, TBS-2121
15	1	1003.00005.00	BRACKET, ONE SHOT THERMOSTAT
16	1	1053.00004.00	THERMOSTAT, SINGLE SHOT, 25A
17	1	1024.00007.00	O-RING, DASH #344, TANK COVER
18	1	1102.00007.00	TANK COVER ASSEMBLY
19	1	1044.00004.00	LABEL, DANGER, HIGH VOLTAGE

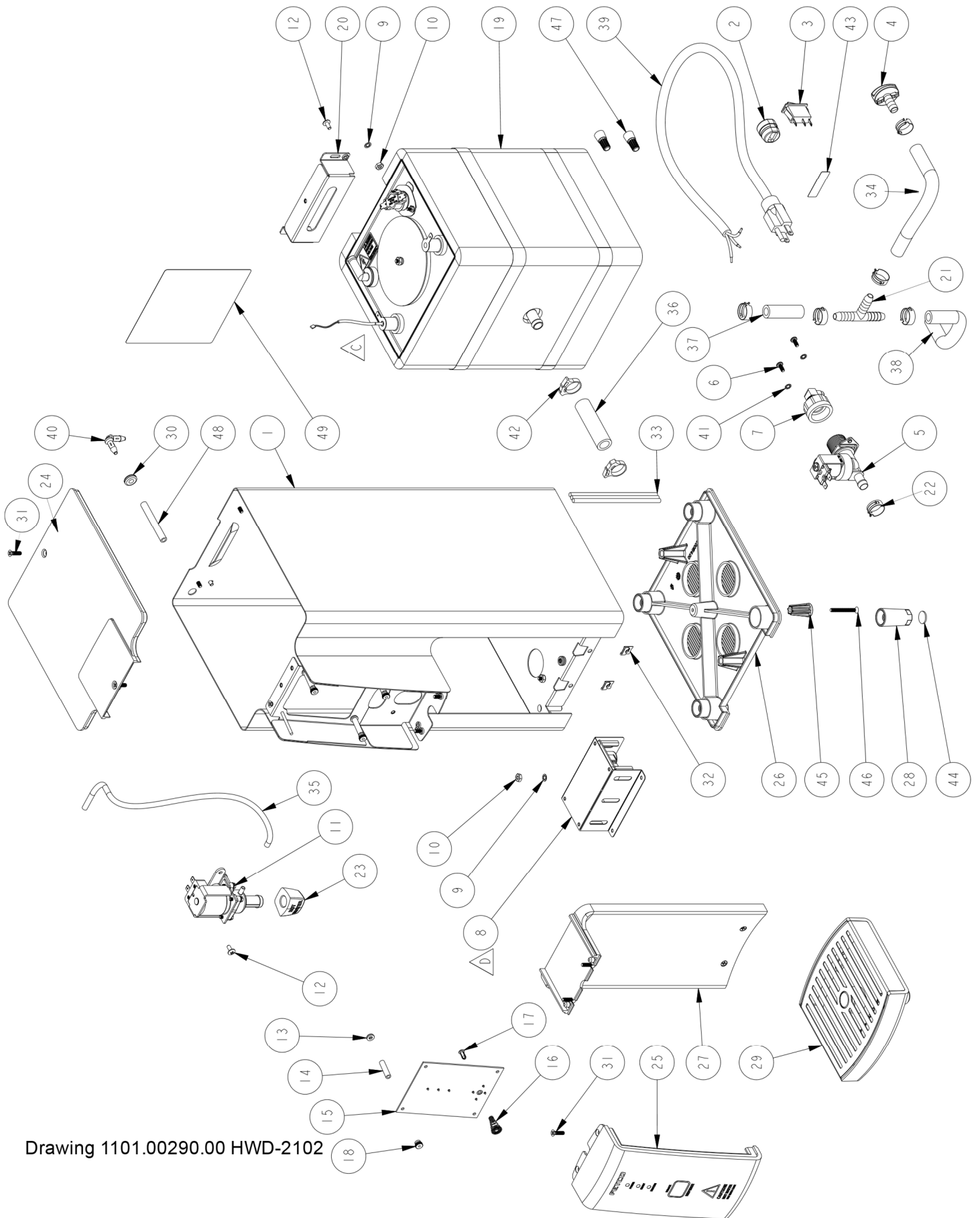

Drawing 1101.00290.00 HWD-2102

REF	QTY	Part Number	NAME	Parts Breakdown HWD-2102, Drawing 1101.00290.00
1	1	1111.00028.00	BODY, WELDMENT, HWD-2102	
2	1	1086.00020.00	BUSHING, STRAIN RELIEF, .425"-.475" DIA CABLE	
3	1	1058.00020.00	SWITCH, PWR ROCKER RED, ILLUM. 250VAC	
4	1	1023.00147.00	PLUG, TANK SERVICE DRAIN FOR 18 GA AND UP BODY	
5	1	1057.00059.00	VALVE, 0.66 GPM BRN FLOW REG, 180DEG/24VDC	
6	2	1082.00010.00	SCREW, PAN HD. PHIL. MACH., M4x10 ZINC-PLATED	
7	1	1102.00164.00	ADAPTER ASSY, 3/4" BSP X 1/4 SAE FLARE	
8	1	1102.00159.00	POWER SUPPLY ASSEMBLY, HWD-2100	
9	4	1083.00011.00	WASHER, #8 SCREW SIZE, INTERNAL TOOTH LOCK	
10	4	1084.00006.00	NUT, 8-32 18-8 HEX MACHINE SCREW	
11	1	1102.00179.00	DISPENSE VALVE ASSEMBLY, HWD-2102	
12	4	1082.00023.00	SCREW, #8-32 X 3/8 TRUSS HD PHIL., MACHINE	
13	4	1083.00010.00	WASHER, #10 SCREW W/NEOPRENE-BONDED SEAL	
14	4	1029.00020.00	SPACER, RND. UNTREADED, #6 SCREW SIZE, 1/4" OD X 1"LG.	
15	1	1108.00015.00	CONTROL BOARD/SOFTWARE HWD-2102	
16	1	1085.00008.00	SPRING CONICAL, HWD-2100 CTRL BOARD	
17	1	1087.00006.00	RIVET, 0.187" DIA, PLASTIC, BLACK	
18	1	1029.00018.00	NUT, #6 KNURLED THUMB	
19	1	1104.00150.00	TANK ASS'Y., HWD-2102, 1440W/120VAC	
19	1	1104.00151.00	TANK ASS'Y., HWD-2102, 2100W/120VAC	
19	1	1104.00148.00	TANK ASS'Y., HWD-2102, 3200W/240VAC	
20	1	1112.00115.00	BRACKET WELDMENT, TANK LOCK, HWD-2100	
21	1	1029.00002.00	FITTING, HOSE BARB TEE, SIZE 3/8"	
22	6	1086.00003.00	UNICLAMP, 15.9 HOSE OD CLAMP	
23	1	1029.00017.00	FAUCET, SILICONE, HWD-2100	
24	1	1023.00153.00	TOP COVER, HWD-2102	
25	1	1023.00151.00	FRONT PANEL TOP, HWD-2102	
26	1	1023.00154.00	BOTTOM BASE, HWD-2102	
27	1	1023.00152.00	FRONT PANEL BOTTOM, HWD-2102	
28	4	1023.00136.00	LEG, HWD-2100	
29	1	1102.00156.00	DRIP TRAY ASSEMBLY, HWD-2100	
30	1	1024.00041.00	PUSH IN GROMMET, 1/4"ID (7/16" PANEL HOLE)	
31	10	1082.00058.00	SCREW, # 8-32 X 5/8, FLAT HD, PH, 18-8 SS	
32	2	1084.00027.00	NUT, CLIP ON (J-NUT), #8-32, 18-16 GA., BPF	
33	1	1402.00071.00	HARNESS, UNIVERSAL RETROFIT, HWD-2102	
34	1	1025.00039.00	TUBE, 5/8" OD X 3/8 ID X 10" LG, DRAIN	
35	1	1025.00040.00	TUBE, 1/4" OD X .125" ID X 16" LG, VENT	
36	1	1025.00017.04	TUBE, SILICONE, 3/4" OD X 1/2" ID X 3.00" LG, DISPENSE	
37	1	1025.00042.00	TUBE, 5/8" OD X 3/8" ID X 2" LG, BOTTOM TANK	
38	1	1025.00046.00	TUBE, 5/8" OD X 3/8" ID X 5.0" LG, DOUBLE VALVE	
39	1	1063.00016.00	POWER CORD, 120VAC W/NEMA 5-15P PLUG	
40	1	1029.00023.00	FITTING, SINGLE BARBED ELBOW, 1/4", KYNAR	
41	2	1083.00005.00	WASHER, M4 18-8 SS, INT. TOOTH LOCKWASHER	
42	2	1086.00002.00	CLAMP, HOSE, SIZE "G" NYLON	
43	1	1044.00001.00	LABEL "FOR USE ON IND. CIRCUIT"	
44	4	1029.00025.00	FOOT, ANTI-SLIP, 0.60" DIA DISC	
45	1	1023.00155.00	PLUG, BOTTOM BASE, HWD-2100	
46	1	1082.00065.00	SCREW #8-32 X 1 1/2", FLAT HD. PH. 18-8 SS	
47	2	1064.00004.00	WIRE CONNECTOR, SCREW ON, MODEL 74B, YELLOW	
48	1	1025.00045.00	TUBE, 5/16" OD X 3/16" ID X 2.5" LG, PROP VALVE	
49	1	1046.00035.00	LABEL, WARNING "TO REDUCE RISK OF ELECTRIC SHOCK OR FIRE"	

Wiring Diagram

FETCO®

FLUID EQUIPMENT TECHNOLOGY COMPANY
 600 ROSS RD.
 LAKE ZURICH, IL 60047
 PHONE: 847-719-2000, FAX: 847-719-3001
 WWW.FETCO.COM

WIRING, HWD-2102, L1, N+GND, 1 HEATER, DOMESTIC
 DRAWING NO. 1401.00040.00

