

FETCO® User's Guide and Operator Instructions

www.fetco.com

FETCO Coffee Brewer: CBS-2111XTS Extractor Touch Screen Models



Table of Contents

Description & Features	3	Error Codes	14
Operational Description	4	Operator Training	15
Basic Screens	4	Service Guide to a Successful Installation	16
Instructions to access the Programming Menu	5	Drawings and Wiring Diagrams/Parts	18
How to calibrate the flow rate	10	Hot water faucet installation instructions	22

Contact Information

FETCO®
 Food Equipment Technologies Company
 600 Rose Road
 Lake Zurich • IL • 60047-0429 • USA
Internet: www.fetco.com
 ©2016-2020 Food Equipment Technologies Company

Phone: (800) 338-2699 (US & Canada)
 (847) 719-3000
Fax: (847) 719-3001
Email: sales@fetco.com
 techsupport@fetco.com
 PATENTS: WWW.fetco.com/patents

FETCO CBS-2111 Coffee Brewer with bypass (hot water bypass)

CBS-2111-Capacities & Measurements								
Brewer	Height	Width		Depth	Empty Weight	Filled Weight	Hot Water Tank Capacity	
		No hot water faucet	One hot water faucet					
CBS-2111	737 mm 29 inch	229 mm 9 inch	292 mm 11.5 inch	533 mm 21 inch	14.4kg 32 lb	48.3kg 106.5 lb	11.9 liter 3.1 gallon	

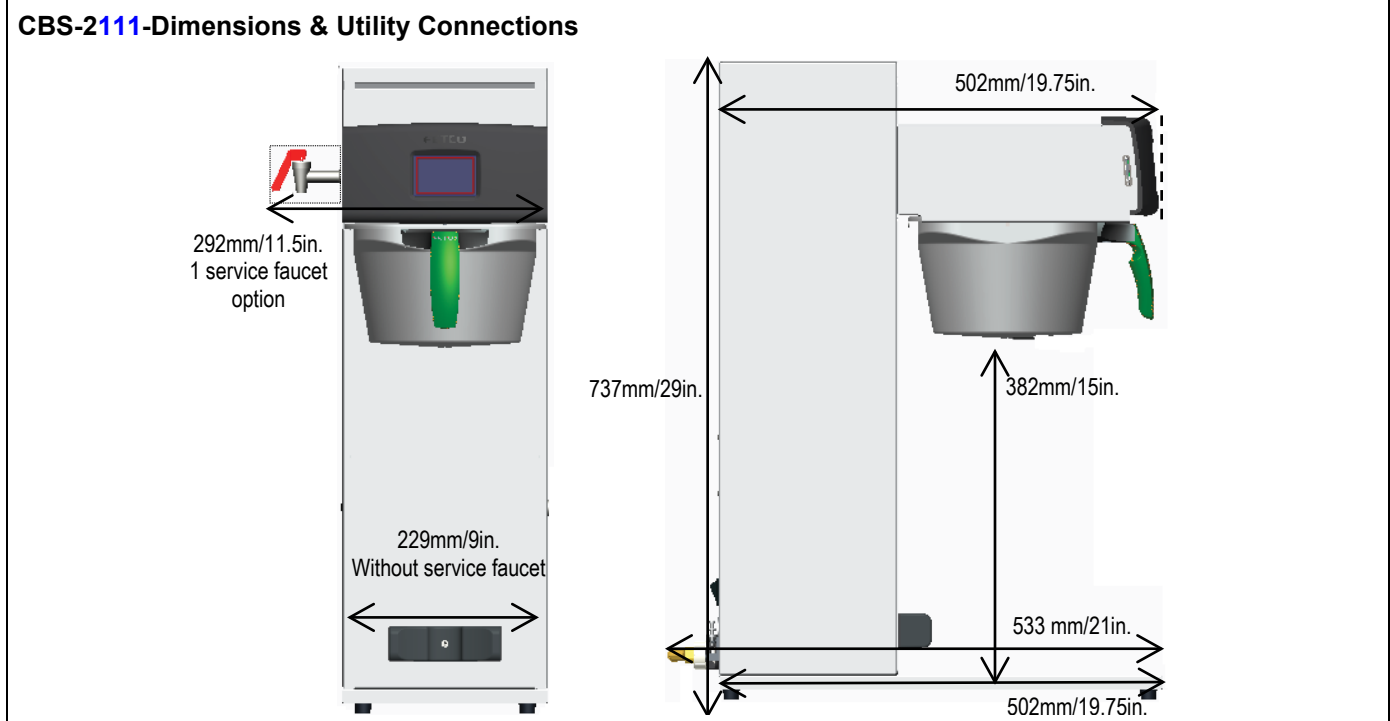

CBS-2111-Electrical Configurations							
Configuration Code	Heater Configuration	Voltage	Phase	Wires	Electrical Connection	KW	Amp Draw
C211191	1 X 3KW	200-240	single	2+G	cord and plug	3.1	10.8-12.9

Please see wiring diagrams located in back pages for installation notes.

CBS-2111-Water Requirements
<p>Water Connection: Inlet: 3/8 inch male flare fitting Mains Pressure: 0.31-0.517 mPa 0.34MPa/50PSI preferred (45-75 psig). Minimum Flow Rate: 5.7 liter/minute (1½ gpm). All commercial hot water dispensers to be supplied with filtered water from mains</p>
<p>The following are the factory settings—and ranges of variables that are adjustable:</p>
<p>Brew volume: 6 liter Batch: (default all recipes: 4 liters brew+2 liters bypass) RANGE [0.50-6.00 liter BREW] [0-4.00 liter BYPASS]</p>
<p>Total Brew Cycle—Factory setting: 9:30 minutes [6 minute brew time+1.5 minute drip delay+2minute bypass] RANGE [1:00-12:00 minute BREW] [0:30-12:00 minute BYPASS DELAY]</p>
<p>Temperature Control—as set by factory: 90°C inside hot water tank (at sea level). -RANGE User selectable: 80-97°C/176°-207°F -Brew Temperature may be individually set for each of the eight recipes.</p>
<p>Coffee Filter Size: 15" X 5 ½ "— standard FETCO # F001</p>

Description & Features

Description

- The CBS-2111 Coffee brewer with hot water bypass has user interactive touch screen display & control.
- Batch size is preset to brew 6.0 liter/1.6 gallon with a ratio of 4 liter brew to 2 liter hot water bypass.
- All eight batch sizes, brew to bypass ratios, and temperatures are programmable to any customer preference

Features

- Low profile
- High-Volume Coffee brewer with hot water bypass feature
- Eight programmable recipes: Factory set with two user adjustable permanent recipes
- Six additional recipes may be optionally programmed or hidden
- Individual recipe temperatures can be set by use
- Hot water tank recovers rapidly and may be quickly lowered for specialty recipe temperature with “PURGE” function

The following can be accessed and programmed:

- BATCH SIZE & BYPASS [Hot Water Bypass] Infinitely variable-factory set at 4.0 liter brew/2.00 liter hot water bypass.
- BREW TEMPERAURE
- PURGE TO LOWER BREW TEMPERATURE: OPTIONAL SELECTION! Operator may use PURGE touch key. Holding the key for the maximum five seconds releases 150 cc/4 fl.oz hot tank water to reduce brew temperature.
- PULSE BREW: Using information entered, the software calculates how much water to dispense for brew and for hot water “BYPASS”. The total dispense time is divided into on/off cycles that dispenses the correct amount of water and pauses to drain the brew basket. Pulse brew can be set by the operator. Factory set is four on/off fill/drain cycles. Controls automatically cycle valves to dispense the correct amount of water set in the recipe.
- RECIPES are all adjustable. Recipes 1&5 are permanent; recipes 2, 3, 4, 6, 7, 8 can be programmed or hidden. See pages 6-13 for programming, adjustments and calibration.

ICON Definition Table					
ICON	Definition	ICON	Definition	ICON	Definition
	Ready to brew		Brew time		Brew valve cyle is “open”, and is cascading water.
	Brewer not ready for this recipe (may be overridden)		Batch Size		Brew valve paused. Pulse brew-drain
	Hot water tank - filled		Temperature icon		Waiting Hot water bypass ready to start- paused (delay)
	Hot water tank – filling/refilling		When blinking: Hot water tank temperature over setting. Purge to reduce water temperature		Drip-out
	Heating/ At Temperature				Hot Water bypass “ON”
	Toggle from menu screen 1-4 to 5-8		Press purge key to reduce water temperature		“STOP”

<p>FETCO XTS EXTRACTOR TOUCHSCREEN CBS_2111 © 2016 all rights reserved</p>	<p>←Brewer is “READY”</p> <p>←Hot water tank is heated and full</p> <p>←Hot water tank temperature (°C)</p>	<p>Menu 1 of 8 →</p> <p>Menu 3 of 8 →</p> <p>Purge Key →</p>	<p>Menu 2 of 8 ←</p> <p>Menu 4 of 8 ←</p> <p>Continue to Menus 5-8 ←</p>
FETCO CBS-2111 home screen		FETCO CBS-2111 recipe screen	

Operational Description

Basic Screens :Recipes, Brew, Starting Menus and General Brewing Sequence

8 DEFAULT RECIPE SCREENS –Toggle button between screens to access recipes 1-4 and 5-8

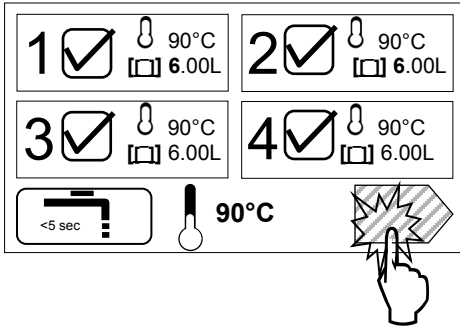

TOUCH AND HOLD 2-3 seconds
Toggle to recipe-choose 1-8
←Menus 1-4
Touch right pointing arrow for 5-8
Menus 5-8→
Touch left pointing arrow to go back

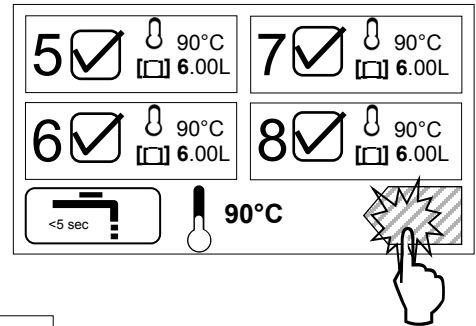

Touch Menu ICON #1 to START BREW
Touch for 2-3 seconds to begin brew.
Have container under brew funnel

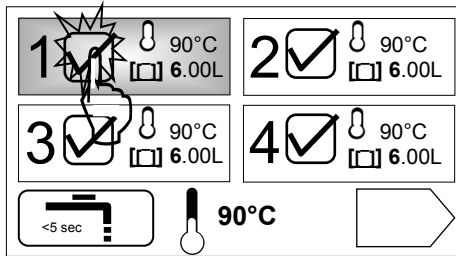

Screens with informational icons shown for factory set recipe #1-(See Icon table for more information)

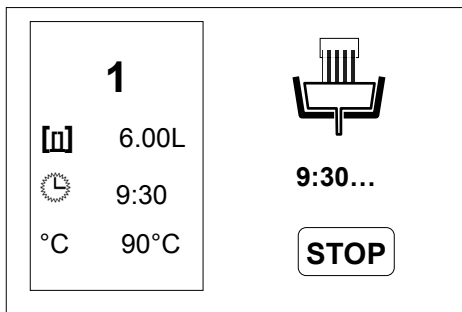

Pulse Brew brew icon→ brew in progress
Brew-valve is open in pulse brew mode.
Valve opens-closes for pulse brew
Left box shows recipe settings

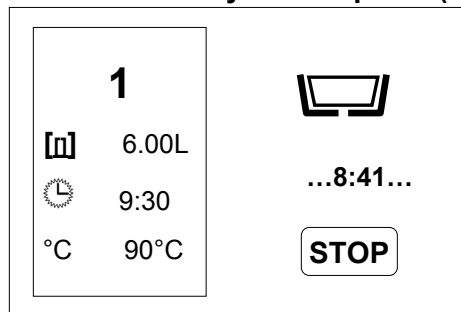

Pulse Brew brew icon→ brew in progress paused icon brew-valve is closed

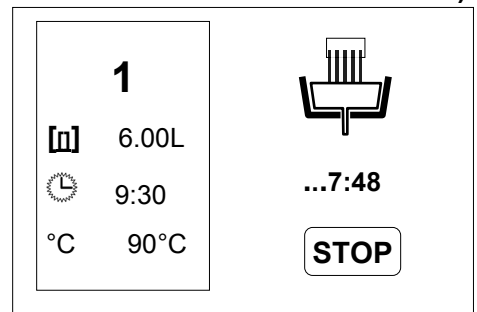

Icons showing open state in pulse brew mode-(brew-valve reopened)
Brewing and Pause icons cycle...

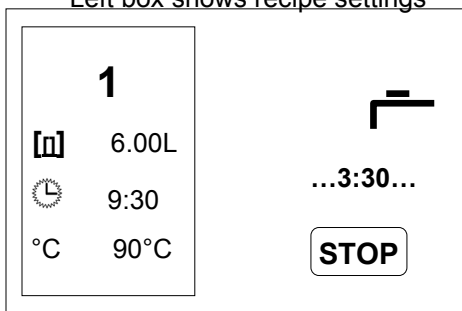

Brew completed. 1:00 min bypass delay for drip-out and hot water tank recovery
User can determine any bypass delay
See following page for programming

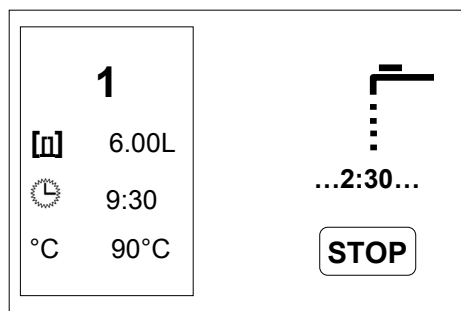

Bypass is cycling and is turned ON

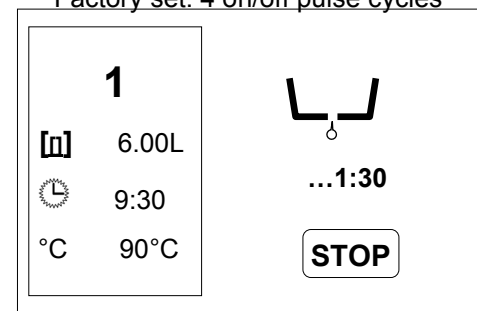

Drip Delay
1:30 minutes
At 0:00, recipe screen will refresh
Icons shown for factory set recipe #1

Instructions to access the Programming Menu



To access programming
 Power-off then power-on the equipment...
 ← 1) Switch CBS-2111 power “OFF”
and then
 2) Turn main power switch to “ON”
 (switch is located on the lower back)
 The touch screen will illuminate.
Immediately
 Touch and hold finger to enter programming →
 In 5-8 seconds “PROGRAM” screen will appear. “PROGRAM” in first column below

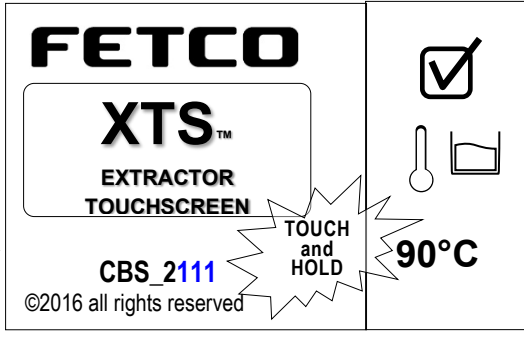

Programming-category screens: Menu Tree Menu Features: Batch Parameters

XTS Main Menu

Menu Chart

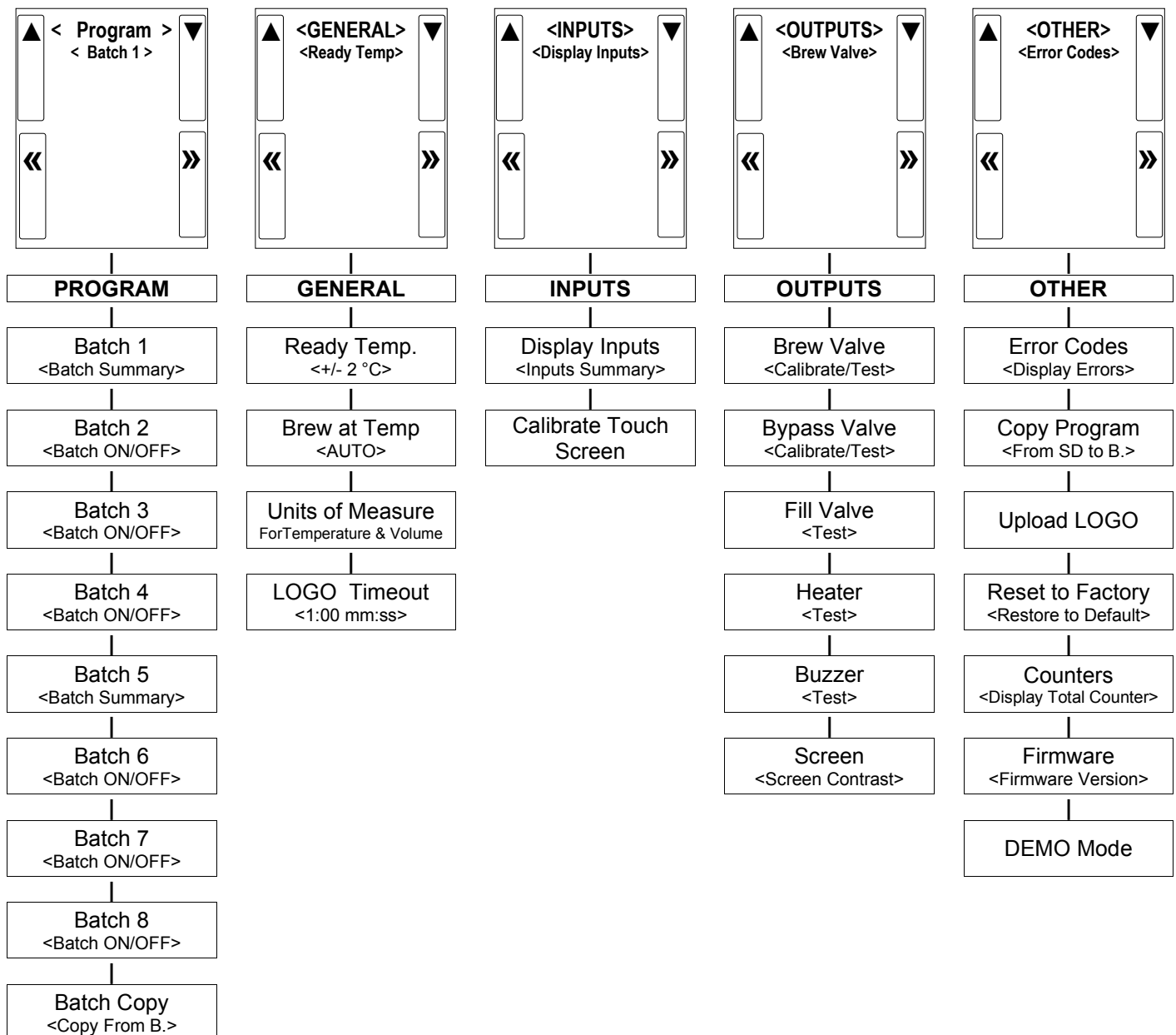

PROGRAM	Programming Items	Factory set Default	Programming Range	Notes
Batch 1 *	• Batch Summary	Display Summary	Batch1 Summary →→	Summary-continued
			Batch Name 1 Brew Temp. 90°C Brew Volume 4.00 Liter Brew Time 6:00 Bypass Vol. 2.00 Liter Total Time 9:30	Bypass Delay 1:00 Number of Pulses 4 Prewet Percent 0% Prewet Delay 0:00 Drip Delay 1:30 Alarm At End NO
	• Batch Temp	90 °C	90 °C 80 97	This sets the brew temperature for batch-1
	• Brew Volume	4.00 liter [0.50-4:00]	4.00 liter 0.50 6:00	Volume of Coffee (to hot water bypass [2:1])
	• Bypass Volume	2.00 liter	2.00 liter 0:00 5.50	Volume of HOT water to add to hot brew
	• Bypass Delay	1:00 mm:ss	1:00 mm:ss 0:00 12:00	Allows for hot water tank recovery
	• Prewet Percent	0%	0 % 0 15	Prewetting helps stabilize ground coffee
Pause after prewet spray completes	• Prewet Delay.	0:00 mm:ss	0:00 mm:ss 0 1	This feature appears ONLY if Prewet >0:00
	• Brew Time	6:00 mm:ss	6:00 mm:ss 1:00 12:00	
	• Nr Of Pulses	4	4 1 30	
This is a Safety Feature	• Drip Delay	1:30 mm:ss	1:30 mm:ss 0:30 10:00	NEVER remove brewbasket during drip-out
	• Alarm at End	NO	NO YES NO	
Notice→	*Batches 1 & 5 are mandatory and are always permanently selected Batch 2,3,4,6,7&8 may each be selectively hidden with the Batch ON/OFF selector screen			
Batch 2	• Batch ON/OFF	ON	ON ON OFF	
	• Batch Summary	Display Summary		[See BATCH 1]
	• Batch Temp	90 °C	90 °C 80 97	This sets the brew temperature for batch-1
	• Brew Volume	4.00 liter [0.50-4:00]	4.00 liter 0.50 6:00	Volume of Coffee (to hot water bypass [2:1])
	• Bypass Volume	2.00 liter	2.00 liter 0:00 5.50	Volume of HOT water to add to hot brew
	• Bypass Delay	1:00 mm:ss	1:00 mm:ss 0:00 12:00	Allows for hot water tank recovery
	• Prewet Percent	0%	0 % 0 15	Prewetting helps stabilize ground coffee
Pause after prewet spray completes	• Prewet Delay.	0:00 mm:ss	0:00 mm:ss 0 1	This feature appears ONLY if Prewet >0:00
	• Brew Time	6:00 mm:ss	6:00 mm:ss 1:00 12:00	
	• Nr Of Pulses	4	4 1 30	
This is a Safety Feature	• Drip Delay	1:30 mm:ss	1:30 mm:ss 0:30 10:00	NEVER remove brewbasket during drip-out
	• Alarm at End	NO	NO YES NO	

PROGRAMMING MENU-Continued

PROGRAM Continued	Programming Items	Factory set Default	Programming Range	Notes
Batch 3	(See Batch 2)			
Batch 4	(See Batch 2)			
Batch 5	(See Batch 1)			
Batch 6	(See Batch 2)			
Batch 7	(See Batch 2)			
Batch 8	(See Batch 2)			
Batch Copy	Copy From Batch	COPY from B.(1-8)?		
	Copy To Batch	COPY to B.(1-8)?		
	Copy?	B1→B2? (example)	<div style="text-align: center;">NO</div>	
*Batch 1& 5 are mandatory and cannot be disabled. Other batches can be disabled ["hidden"], and removed from display				

Programming Batch Temperature

Individual temperature settings can be programmed for all eight recipes. This accommodates many different brew temperature requirements of the coffee product used. The hot water tank temperature automatically sets to the lowest programmed recipe setting. If a brew is started for a higher temperature setting, the brewer will pause and quickly heat the hot water tank to the temperature setting of the recipe before starting the brew. This is rapid: taking only minutes.

Tank temperature is too low for brew setup

- 1) If the tank temperature is LOWER than the temperature setting—the brewer will display the “Not Ready” icon:
 The hot water tank will quickly reheat and the “Ready” icon will display when heated to the set temperature:

Tank temperature is too high for brew setup

- 2) If the tank temperature is HIGHER than the temperature setting—the brewer will flash the “PURGE” icon:
“PURGE” to cool feature

Purge is drawing a small amount of hot water from the hot water tank—the temperature of the tank is automatically reduced by cool, fresh refill water from the mains. When the “PURGE” icon is activated for 5 seconds approximately ≈150ml/4 fl.oz hot water is released as bypass water and the tank temperature is reduced.

- a) The hot water tank temperature can be quickly lowered by touching the “PURGE” icon for five seconds. The single purge is adequate for most adjustments.

Note: the purged water increases the contents of the dispenser. The 150ml released is a negligible addition for most brews—but should be noted for dispensers without headspace or for multiple purges

- b) Water may be drawn from the hot water service faucet to lower hot water tank temperature. The “PURGE” function is preferred as it offers better control.

- c) Tank temperature override

The brew can be started at the high temperature by touching and holding the “START” icon to override the icon. The brew may be exposed to some brewing water that is higher than temperature setpoint.

Recipe temperature setting table				Purge to lower brew water temperature				
GENERAL Factory Set Temperature Summary				SETTINGS BY USER Temperature Summary as Set By User Fill this in and save for future reference				Recipes show the temperature setting. These can be set by user from 80-97°. Touch the purge icon for 5 sec. This will lower hot water tank temperature 3-4 degrees
1	90°C	5	90°C	1		5		
2	90°C	6	90°C	2		6		
3	90°C	7	90°C	3		7		
4	90°C	8	90°C	4		8		

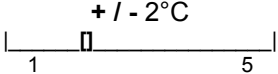
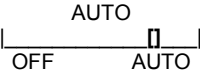
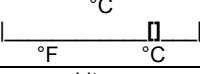
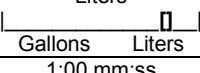
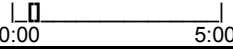
GENERAL	Programming Items	Factory set Default	Programming Range (display)	Notes
Ready Temp		+ / - 2°C		Range when "READY" icon will show
Brew at Temp.	"OFF" allows brewing at any temperature.	AUTO		SEE NOTE! (Below)
Units of Meas. <Toggle Temp-Vol.>	• Temperature	°C		
<Toggle Temp-Vol.>	• Volume	Liters		
Logo Timeout		1:00 mm:ss		

NOTE: FOR BREW AT TEMPERATURE DEFINITIONS

BREW AT TEMP: AUTO
(DEFAULT: FACTORY PROGRAMMED INTO BREWER)

This allows the "BREW START" to active.
If the hot water tank is at the selected temperature—the brew will start.
If the temperature is too low—*not at the selected temperature*, the brewer will wait until the proper temperature is reached and then wil automatically begin brewing.
A thermometer icon screen will display showing the tank temperature. (example: right)

IMPORTANT:

ALWAYS have dispenser(s) under the brew baskets when in the BREW AT TEMP mode.

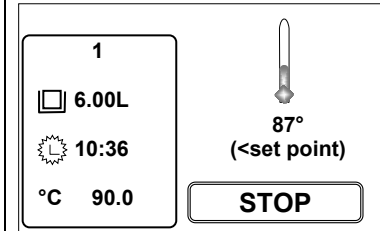

BREW AT TEMP: OFF **USER SELECTABLE**

Allows brewing at any temperature. (Not recommended-it is possible to start brew with brew water at incorrect temperature.)

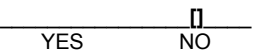
INPUTS	Programming Items	Factory set Default	Programming Range (display)	Notes
Display Inputs	• Input Summary		Brew Basket Sensor <input type="checkbox"/> Liquid Level Sensor <input checked="" type="checkbox"/> Temperature Probe <input checked="" type="checkbox"/> SD Card <input type="checkbox"/>	
Cal. Touch Scr		Calibrate	Calibrate 	If <u>Yes</u> : Follow directions on the touch screen

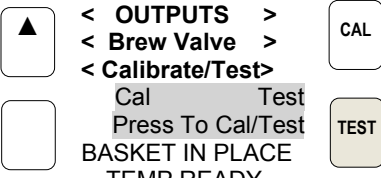
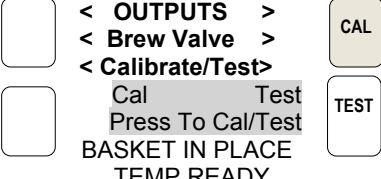
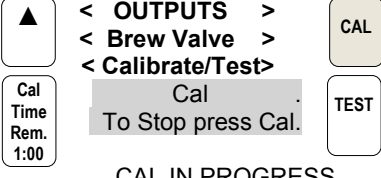
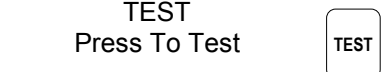
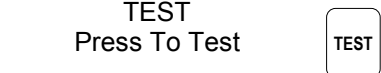
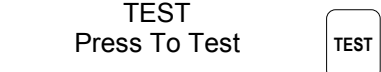
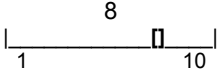
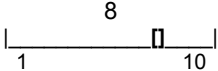
OUTPUTS	Programming Items	Factory set Default	Programming Range (display)	Notes
Brew Valve Calibrate/Test	• Brew Valve	(Press to test)	 <p>< OUTPUTS > < Brew Valve > < Calibrate/Test> Cal Test Press To Cal/Test BASKET IN PLACE TEMP READY</p>	Runs valve to verify flow. Have container under brew basket!
Brew Valve- CALIBRATE	• Brew Valve		 <p>< OUTPUTS > < Brew Valve > < Calibrate/Test> Cal Test Press To Cal/Test BASKET IN PLACE TEMP READY</p>	See pages 10-12 for detailed calibration procedure and screens
BYPASS Valve- CALIBRATE	• BYPASS Valve		 <p>< OUTPUTS > < Brew Valve > < Calibrate/Test> Cal Test To Stop press Cal. CAL IN PROGRESS</p>	See pages 10-12 for detailed calibration procedure and screens
Fill Valve	• Fill Valve Test	(Press to test)	 <p>TEST Press To Test</p>	Operates fill valve. Have container under both brew baskets!
Heater	• Heater Test	(Press to test)	 <p>TEST Press To Test</p>	Energizes Heater(s) Use for servicing.
Buzzer	• Buzzer Test	(Press to test)	 <p>TEST Press To Test</p>	Confirms “BEEP” Use for servicing.
Screen	• Screen Contrast	Contrast		
	• S. Brightness	Brightness		

How to calibrate the flow rate for the brew valve or bypass valve

Set the flow rates of brew valve to adjust for taste profile and for batch size.

Built-in algorithms in Brewer controller software corrects brew parameter to customer preferences or to trim variations in flow control components

NOTICE: This operation requires operator to activate brew or bypass function for one minute—and to measure the output

1) MEASURE THE FLOW RATE:

- Enter programming mode, scroll left to “OUTPUTS”
- Scroll down to “Brew Valve Calibrate/Test”
- (or)
- “Bypass Valve Calibrate/Test”
- Next: scroll down to “Calibrate Test”

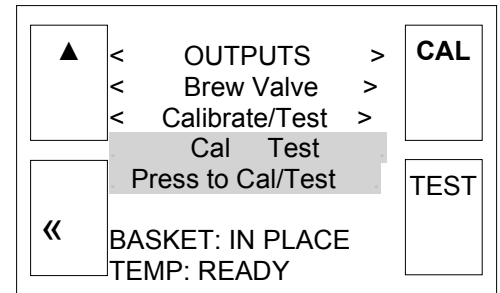

- Place 3 liter/1 gal measuring container under empty brew basket.
- The water dispensed may be accurately measured or weighed. Use a scale for at least 3 kg/8lb
- Press The CAL button. **→! The valve will open for one minute**
- It is very important for this test to measure the flow for the entire minute.**

Measure the results of the flow in the measuring container and hold the number.

2) **AUTOMATIC** Built-in CALIBRATE THE FLOW RATE

- Enter this number, in milliliters, into the calibration slider for the Valve tested in the OUTPUT MENU.
- Enter in milliliters.** If measured in fluid ounces (fl.oz) multiply by 29.57 to convert to milliliters
- After entering the measured volume, exit PROGRAMMING and return to the normal screens

By entering the new flow rate number into the brewer, the software automatically corrects the valve flow discrepancy



From calibrate-test screen, brewer automatically dispenses for 60 seconds. The calibration test flow is carefully measured in milliliters.

A 3 liter/1 gal measuring container is recommended.

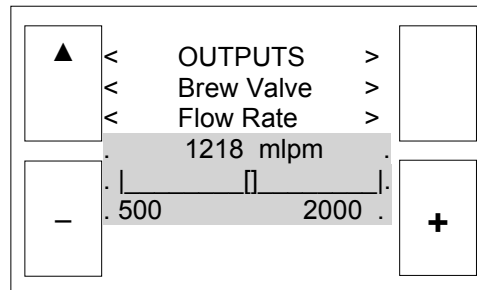

Scroll from the calibrate-test screen into the FLOW RATE screen. Enter the calibration test flow on the slider using the + and - icons. EXIT and SAVE as prompted.

Built in software will automatically calibrate the BREW valve.

Calibration must be repeated for the BYPASS valve

EXAMPLE: Calibrate BREW VALVE.

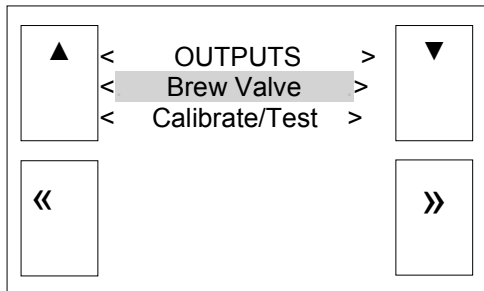

1) Enter PROGRAMMING menu
 (See page 5: INSTRUCTIONS TO ACCESS PROGRAMMING MENUS)
 Scroll to “**OUTPUTS**” in PROGRAMMING
 Scroll down to **BREW VALVE**

(The following areas may be accessed in this PROGRAMMING position: BREW VALVE, BYPASS VALVE, Fill Valve, Heater, Buzzer, Screen. To access these: with the 2nd level highlighted as shown—scroll through the positions with the right/left arrows. Only the Brew and Bypass valves can be calibrated)

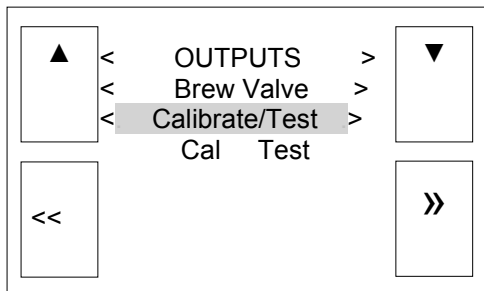

Scroll down to “**Calibrate/Test**”

(The following areas may be accessed in this PROGRAMMING position: Calibrate/Test and Flow Rate. To access these: with the 3rd level highlighted as shown—scroll through the positions with the right/left arrows. CBS-2111 automatically calibrates based on the flow entered. The highlighted FLOW RATE is used to enter the flow rate and for Service and to fine tune the flow.)

Scroll down to “**Cal Test**”

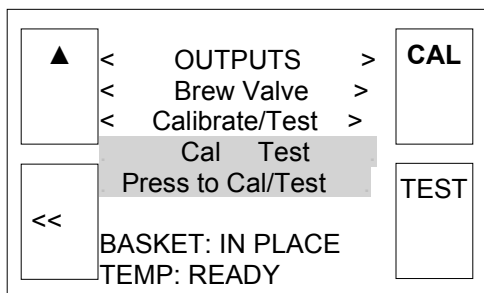

Have 3 Liter/1Gallon measuring container under brew basket

In “Cal Test”

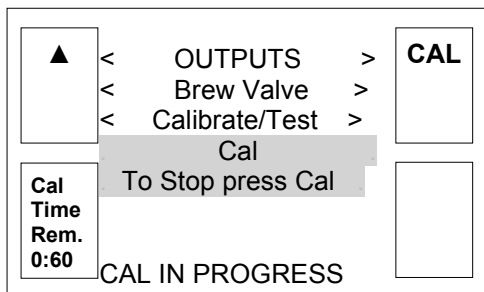

PRESS CAL and remove finger—do not hold

The CBS-2111 will dispense for exactly one minute and automatically stop.

Carefully measure the amount of water, in milliliters, that was dispensed
 This is the calibration test flow
 The calibration results are entered into the slider that automatically displays

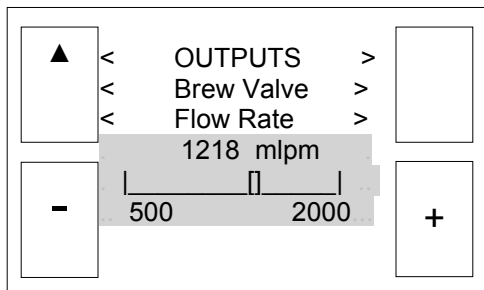

ENTER THE CALIBRATION TEST FLOW RESULTS

The calibration is adjusted by the CBS-2111XTS software by entering the amount of water into the slider that was dispensed in 60 seconds.
The slider shows 1218 mlpm (milliliters per minute)—enter your results.
 Using the + and – icons, enter the amount of water dispensed on the slider.
 Enter in milliliters (multiply fluid ounces by 29.6 to obtain milliliters)

Scroll UP and OUT and save calibration as directed by screen prompts.

Brew valve is automatically calibrated on saving the test flow entered.

EXIT TO COMPLETE CALIBRATION

EXAMPLE: Calibrate BYPASS VALVE.

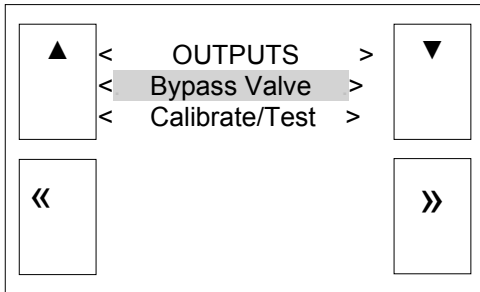

1) Enter PROGRAMMING menu
 (See page 5: INSTRUCTIONS TO ACCESS PROGRAMMING MENUS)
 Scroll to “**OUTPUTS**” in PROGRAMMING
 Scroll down to **BYPASS VALVE**

(The following areas may be accessed in this PROGRAMMING position: BREW VALVE, BYPASS VALVE, Fill Valve, Heater, Buzzer, Screen. To access these: with the 2nd level highlighted as shown—scroll through the positions with the right/left arrows. Only the Brew and Bypass valves can be calibrated)

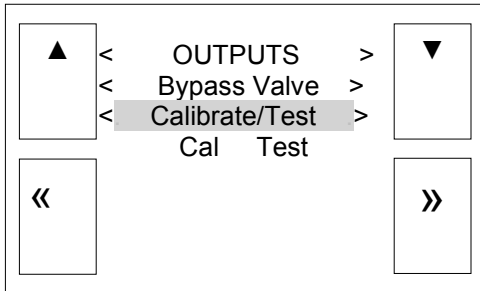

Scroll down to “**Calibrate/Test**”

(The following areas may be accessed in this PROGRAMMING position: Calibrate/Test and Flow Rate. To access these: with the 3rd level highlighted as shown—scroll through the positions with the right/left arrows. CBS-2111 automatically calibrates based on the flow volume entered. The highlighted FLOW RATE is used to enter the flow rate and for Service and to fine tune the flow.)

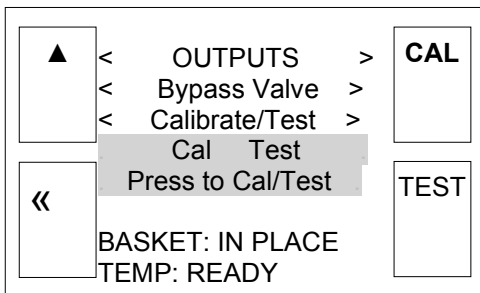

Scroll down to “**Cal Test**”

Have 3 Liter/1Gallon measuring container under bypass basket

In “Cal Test”

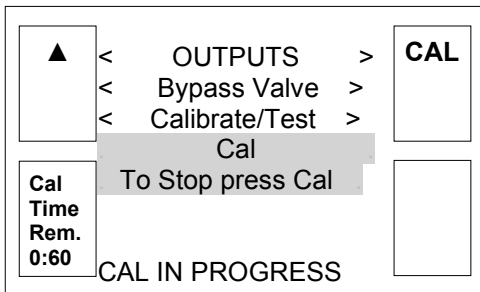

PRESS CAL and remove finger—do not hold

The CBS-2111 will dispense for exactly one minute and automatically stop.
 Carefully measure the amount of water, in milliliters, that was dispensed
 This is the calibration test flow
 The calibration results are entered into the slider that automatically displays

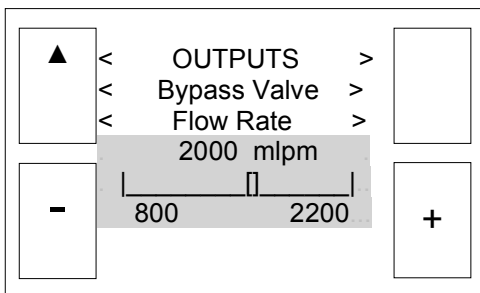

ENTER THE CALIBRATION TEST FLOW RESULTS
 The calibration is adjusted by the CBS-2111XTS software by entering the amount of water into the slider that was dispensed in 60 seconds.
The slider shows 1218 mlpm (milliliters per minute)-enter your results.
 Using the + and – icons, enter the amount of water dispensed on the slider.
 Enter in milliliters (multiply fluid ounces by 29.6 to obtain milliliters)

Scroll UP and OUT and save calibration as directed by screen prompts.

Bypass valve is automatically calibrated on saving the test flow entered.

OTHER	Programming Items	Factory set Default	Programming Range (display)	Notes
Error Codes	• Display Errors	(Codes)	1: 2: 3:	Chart on next page
	• Reset Errors	(Reset)	Reset ----- <input type="checkbox"/> YES NO	!!Clear only with guidance from factory or service !!
Copy Program	• From SD to B.	SD→ Brewer	SD→ Brewer ----- <input type="checkbox"/> YES NO	Setup upload Please insert SD card with the setup data!
	• From B to SD	Brewer→ SD	Brewer→ SD ----- <input type="checkbox"/> YES NO	Setup download Please insert SD card with sufficient space (≥2GB)
Upload Logo		Upload Logo	UPLOAD LOGO Are you sure ----- <input type="checkbox"/> YES NO	Please insert SD card with logo file!
Res to Factory		Reset to default	Reset to Default Are you sure ----- <input type="checkbox"/> YES NO	Completely overwrites all user setup, including user logo.
Counters	• Display Counters -OR- • Reset Counters	Counters Display Total Counters	TOTAL COUNTER Brews 0 Brews activated 0 Brew [liters] 0 Bypass Activated 0 Bypass. L [liters] 0 Fill valve Activated 0 Fill Valve [liters] 0 Heater Activated 0 Heater "on" time 0	Resetting will restart counters from zero when selected
	• Reset Counters	Reset All Counters	Reset All Counters Are you sure ----- <input type="checkbox"/> YES NO	
Firmware	• Firmware Version -Software type	Firmware Version	Display Versions CBS/TBS_2111 SW ver. 1.05 HW ver. BL ver. 1.1.4 QP ver. 4.5.03	Displays firmware version
	• Update Firmware	UPDATE	UPDATE ----- <input type="checkbox"/> YES NO	Firmware upload Please insert SD card with the firmware file!
DEMO Mode [Not on all units]	DEMO ON/OFF	May not be included	OFF ----- <input type="checkbox"/> ON OFF	Demonstrates the controls for training. Disables all components in demo mode.
Some software versions will not have "DEMO- MODE"				

Error Codes			
→Contact specialized personnel for error codes			
Code	Description	Possible Cause	Corrective Action
001	Software error-error on start up or corrupted software	Improper start-up or shutdown	Restart , if still fault: reload software
050	Short-circuit in temperature probe	Probe failure.	Replace probe.
051	Open temperature probe.	Bad probe connection, or probe failure.	Check all connections. Replace probe if necessary.
100	Initial Fill Error. Initial fill time was more than 11 minutes after power up.	Water supply flow rate is too low.	Watch for short potting during brew cycle. Investigate cause of low flow rate. (Clogged water filter...)
101	Error on refill Tank did not refill within 3 minutes.	Water supply flow rate is too low.	Watch for short potting during brew cycle. Investigate cause of low flow rate. (Clogged water filter...)
102	Unwanted fill;	Possible leak in tank, fitting, or valve.	Occurs during pre-fill, low probe is uncovered
201	Heater open, high limit thermostat, or Solid State Relay (SSR) fault	Failure of: heating element, SSR, high Limit or low voltage	Check and replace heating elements if necessary.
255	Touch pad error	Usually from longer than 2 min contact. Or faulty reassembly after service	Restart , if still fault: reload software. If mechanical: reassemble correctly
INSERT BREW BASKET 		Brew basket must be in place <u>This is a SAFETY FEATURE</u>	Insert brew basket into brewer rails to enable brewer

! → Never attempt to remove a brew basket-during brew-this is a safety feature

Operator Training

Review the operating procedures with whoever will be using the brewer.

Pay particular attention to the following areas:

1. Always pre-heat the dispensers before the first use of each day by filling them half way with hot water, and letting them stand for at least 5 minutes.
2. Do not remove the brew basket from a coffee brewer until it has stopped dripping.
3. Make sure the dispenser is empty before brewing into it.
4. Show how to attach covers, close, and or secure the dispensers for transporting.
5. Show the location and operation of the water shut off valve as well as the circuit breaker for the brewer.
6. Steam from the tank will form condensation in the vent tubes. This condensation will drip into and then out of the brew baskets. Up to 1/4 cup/118cc discharging overnight is possible. Place an appropriate container under each brew basket when not in use.
7. We recommend leaving the power to the brewer on overnight. The water tank is well insulated and very little electricity is used to keep the tank hot. Leaving the brewer in the "ON" position will also avoid delays at the beginning of shifts for the brewer to reach operating temperature.

Cleaning & Maintenance

After Each Brew:

1. Dispose of used coffee filter and grounds/spent tea leaves and rinse brew basket.
2. Never strike a brew basket or hit it against a hard surface.
This will damage the brew cone, and may damage the brew basket support rails
3. Rinse dispensers before reuse.

Every Day:

1. Wash brew basket with hot sudsy water.
2. Pull CSD from the spray head, it is magnetically attached. Use gloves or a heavy towel. → Wash off any film and reattach. Use vinegar if limescale filming is present.
3. Clean dispensers with hot suds water and a brush, rinse and air dry.
4. Use only a soft cloth and hot suds on the outside to avoid scratches. Never use abrasives that will scratch surface.

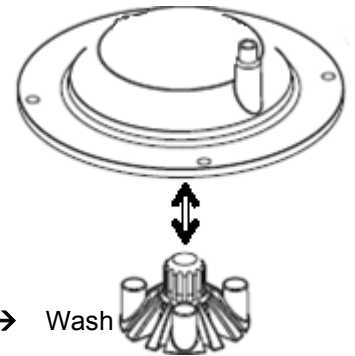

Weekly

1. Use a commercial coffee dispenser cleaner such as URNEX™, TABZ™, DIP-IT™ or Squeak 'n Clean™.
2. Carefully Follow the instructions supplied with the cleaning product
3. Never use spray cleaners, solvent, solvent based cleaner or petroleum based polish anywhere on dispensers

Warning

1. Turn off power before any cleaning procedure, including wiping the exterior for appearance reasons.
2. Dry the exterior, especially the face panel, before turning on power.
3. Do not apply any type of spray cleaner on the face panel of this equipment.
4. Never use solvent or solvent-based cleaner or petroleum based polish anywhere on this equipment.
5. Dry the face of the touch pad before turning on power
6. Do not electrically energize this equipment or attempt operation without all covers in place and all screws fastened.
7. Unplug machine before disassembly or servicing.

Safety Notes

1. Professional installation is required. This appliance is manufactured only for commercial use
2. Operational requirements and maintenance for commercial cooking appliances differ from household appliances.
3. Operators must be trained for this equipment and must understand the use, maintenance and hazards.
4. Access to the service area is restricted to persons having safety/hygiene knowledge and practical experience of the coffee brewer. This appliance must be installed in locations where it can be overseen by adult trained personnel.
5. Do not attempt to move hot beverage equipment once it is filled. Drain equipment before moving.
6. FETCO commercial coffee brewers prepare large amounts of coffee or tea in a single batch using very hot water
7. Commercial coffee brewers provides very hot water from the sprayhead, brew basket and faucet when it is pulled.
8. Brewers may continue to dispense very hot water from the mechanically operated faucet after the electronic touchpad is completely disabled by turning off the power switch on the lower back of the unit, or unplugging the unit.
9. For safety, do not remove brew basket during the brew.

Keep these instructions for training and future reference.

Service Guide to a Successful Installation

(For Qualified Service Technicians Only)

General:

1. If not installed correctly by qualified personnel, the brewer will not operate properly and damage may result.
2. Utilize only qualified beverage equipment service technicians for service and installation.
3. Always have an empty dispenser under sprayhead of all coffee brewing equipment-including when at idle
4. Damages resulting from improper installation are not covered by the warranty, and will void the warranty.
5. Optional Hot Water Service Faucet is separate. See Page 22 for installation instructions. Install before startup.

Below are the key points to consider before installation:

Electrical:

1. All CBS_Series brewers require **an electrical ground wire**. Installation without grounding is dangerous.
2. Note Equipotentiality Terminal, if present, (To identify the terminals which, when connected together, bring the various parts of equipment or of a system to the same potential, not necessarily being the earth (ground) potential, e.g. for local bonding.)
3. Verify voltages, polarity, circuits, and circuit breaker access before attaching equipment.
4. Brewers in this series wire differently in regards to a neutral wire. Review the wire diagrams.
5. The electrical diagram is located in the Users Guide and online at www.fetco.com.
6. Make sure of the tight grounding of the equipment and use the external ground bolt.
7. The installation must comply with applicable federal, state, and local codes having jurisdiction at your location. Check with your local inspectors to determine what codes will apply.

→See wiring diagrams for connections

Plumbing:

1. North America: All installations must comply with applicable federal, state, or local plumbing codes.
2. All Others: The water and waste piping and connections shall comply with the International Plumbing Code 2003, International Code Council (ICC), or to the Uniform Plumbing Code 2003 (IAPMO).
3. Use an inline water filter for all beverage equipment.
4. Install the filter unit after a water shutoff valve and in a position to facilitate filter replacement.
5. The water line and newly installed filter cartage must be flushed thoroughly prior to connecting it to the brewer to prevent debris from contaminating the machine.
6. Verify that the water line will provide a flow rate of at least 1½gpm/(5.7lpm) per minute and the water pressure is between 20-75 psig (138-517kPa) before making any connections.
7. Use a wrench on the factory fitting when connecting the incoming water line. This will reduce stress on the internal connections and reduce the possibility of leaks developing after the install has been completed
8. Install a backflow prevention device. Most municipalities require a recognized backflow preventer.

Usable on all hot beverage and cold beverage equipment is a WATTS® SD-2 or SD-3.

WATTS spring loaded double check valve models are accepted by most zoning authorities.

→The check valve should be as close to the water supply inlet of the beverage equipment as possible.

Tank Drain

The water tank must be drained before maintenance procedures, and when the unit is to be relocated or shipped

1. Disconnect power to unit.
2. Move the unit near a sink or obtain a container large enough to hold four gallons of water and a hose clamp.
Note that the tank may hold more than four gallons and that the drain line will be clamped to empty the container.
3. NOTE: Multiple buckets may be needed during the draining, see tank volumes below
4. Remove the tank cover and allow the tank to cool to a safe temperature
5. The tank drain is located on the back of the unit. Turn the drain plug one-quarter turn in either direction
6. Pull the plug out far enough to expose the silicone tube
7. Using pliers loosen the hose clamp and move it back over the tube.
8. Crimp the tube an inch or two away from the drain plug to prevent water from flowing.
9. Use the other hand to pull the drain plug out of the tube.
10. Release the crimped tube and allow the water to flow into the sink or container.

Brewer	Hot Water Tank Capacity
CBS-2111XTS	11.9 liter 3.1 gallon

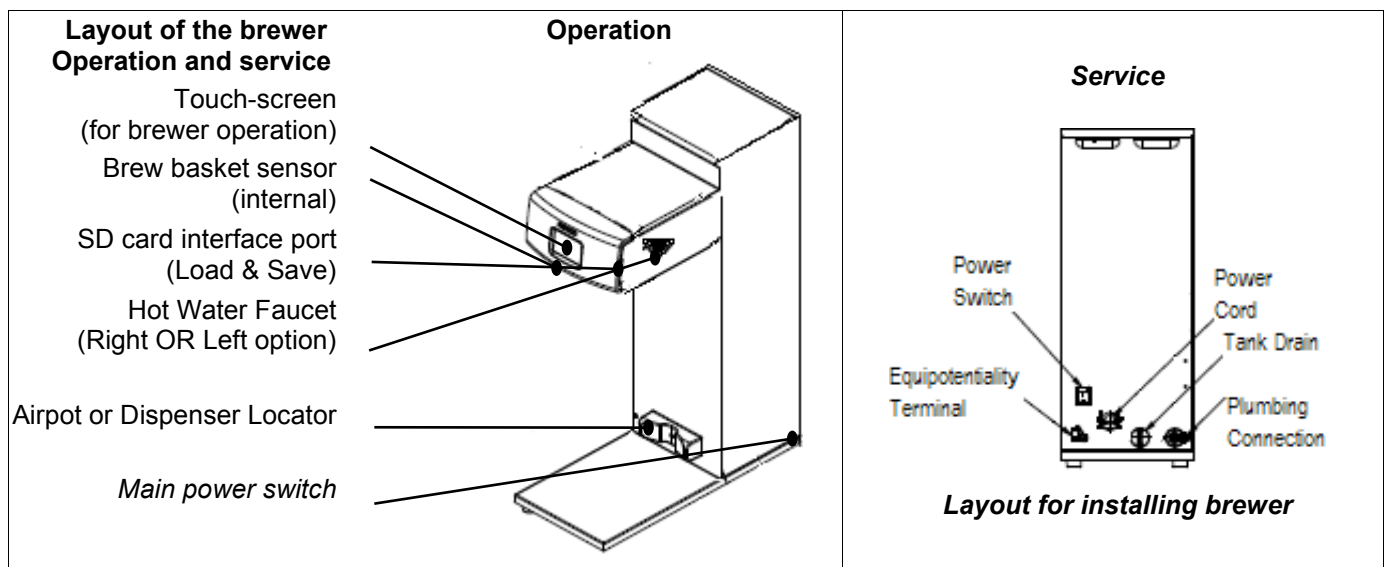

Installation safety and hygiene directions

1. Access to the service area is restricted to persons having safety/hygiene knowledge and practical experience of the coffee brewer. This appliance must be installed in locations where it can be overseen by trained personnel.
2. For proper operation, this appliance must be installed indoors where the temperature is between 10°C/50°F to 35°C/95°F. Drain and remove all liquid from equipment and lines if exposed to freezing temperatures.
3. All commercial cooking equipment, including this unit, is not intended for use by children or persons with reduced physical, sensory, or mental capabilities. Ensure proper supervision of children and keep them away from the unit.
4. Children should be supervised to ensure that they do not play hot beverage equipment.
5. This unit must be installed and serviced by qualified personnel only.
6. Installation must conform to all local electrical and plumbing codes. Installation by unqualified personnel will void the unit warranty and may lead to electric shock or burn, as well as damage to unit and/or its surroundings.
7. If the power cord requires repair or replacement-it must be performed by the manufacturer or authorized service personnel with the specified cord only from the manufacturer in order to avoid a hazard.
8. Review the dimensions for the unit and verify that it will fit properly in the space intended for it. Verify that the counter or table will support the total weight of the brewer and dispensers when filled (See: Technical Data).
9. Place the brewer on the counter or stand. When the brewer is in position, level it front to back as well as side-to-side by adjusting the legs.
10. Brewers will need a sturdy supported surface for operation. Do not move brewers when filled.
11. Do not tilt appliance more than 10° to insure safe operation.
12. Unit is for protected indoor use only. Do not steam clean or use excessive water on unit.
13. This unit is not "jet-proof" construction. Do not pressure wash or use jet spray to clean this unit.
14. The unit is not waterproof-do not submerge or saturate with water.

Equipment exposed to flood and contaminated must not be used due to electrical and food safety. Do not operate if unit has been submerged or saturated with water.

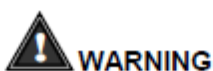

All electrical connections must be in accordance with local electrical codes and any other applicable codes. If the supply cord is damaged, it must be replaced by the manufacturer, its service agent, or similarly qualified persons in order to avoid a hazard.

To prevent an electric shock hazard this device must be bonded to equipment in close proximity with an equipotential bonding conductor. This device is equipped with a bonding lug for this purpose and is marked with the following symbol



	WARNING	To reduce risk of electric shock or fire.
		FETCO® Hot Beverage Equipment is for commercial use only.
		Do not remove or open cover. No user serviceable parts inside. Refer installation and service to qualified personnel.
		Caution, disconnect from power supply before servicing.
		GROUND: National Electrical Code requires separate grounding wire.
		Use dedicated circuit with capacity rated by local code or National Electrical Code for the current draw of this equipment. Check serial number plate on right side for power requirements.
		Locate unit away from source of heat. Do not install or use near combustibles.
		THIS APPLIANCE IS ENERGIZED WHENEVER IT IS CONNECTED TO A POWER SOURCE
		FAILURE TO COMPLY RISKS EQUIPMENT DAMAGE, PROPERTY DAMAGE, FIRE, OR SHOCK HAZARD
	Notice	This equipment must be installed with a backflow protection device to comply with federal, state or local municipality codes.
	Notice	Read the user guide before installing and operating this unit.

Labels and warnings for hot beverage equipment

For BACK PANEL of equipment (1046.00035.00)

Drawings and Wiring DiagramsParts

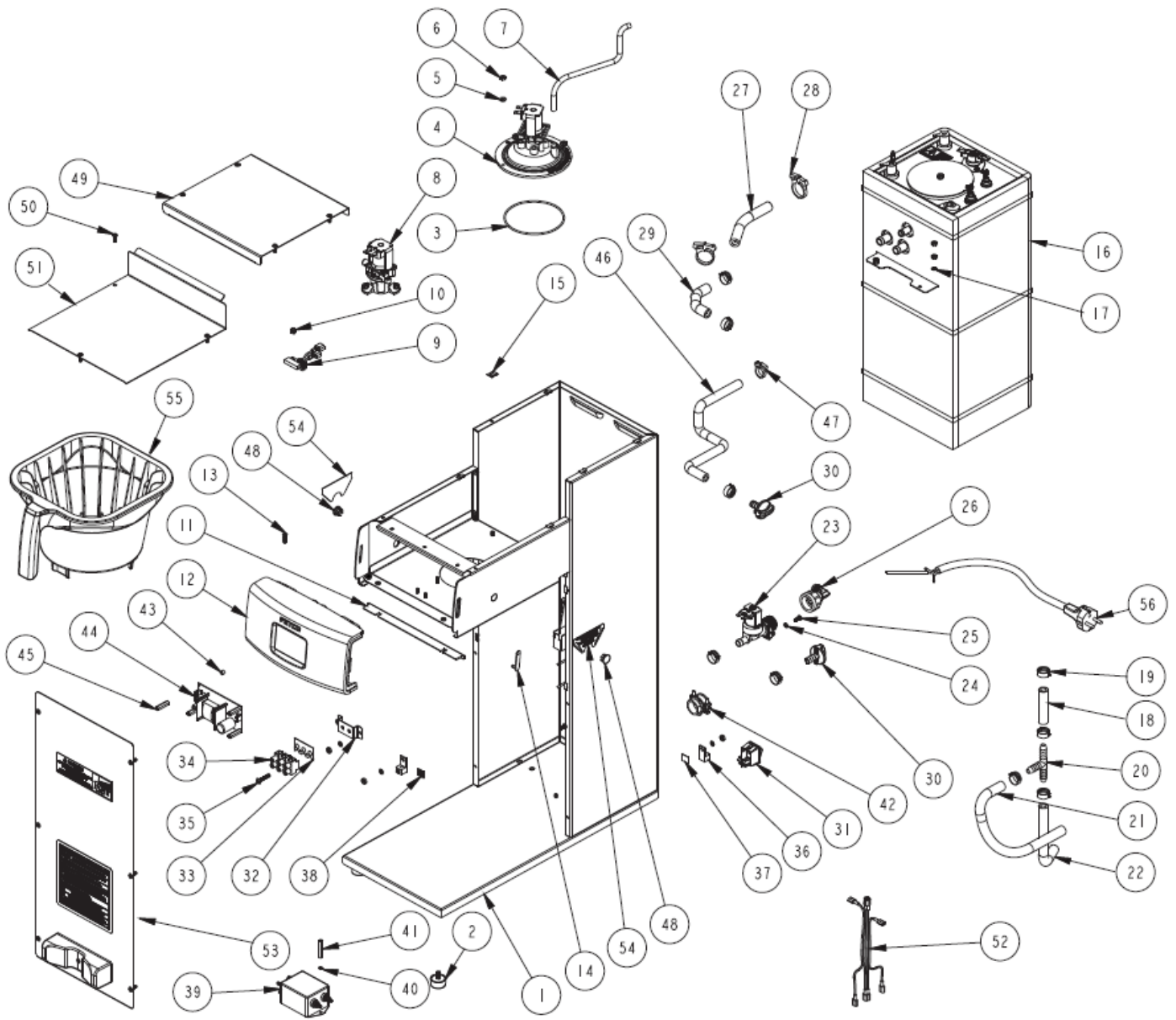

Drawing 1101.00513.00 ASSEMBLY, 3kW/240VAC, CBS-2111

Ref#	Qty	Part number	Description
1	1	1111.00082.00	WELDMENT, TBS-2111
2	4	1073.00021.00	VIBRATION MOUNT, SINGLE END MALE, 1/4-20, TBS-2111
3	1	1024.00063.00	O-RING, 3 15/16" x 3/32" CS, DASH # 154, BUNA-N, DURO-A50
4	1	1102.00203.00	ASSEMBLY, SPRAY HOUSING, DSV P11 DESIGN
5	6	1083.00010.00	WASHER, #10 SCREW W/NEOPRENE-BONDED SEAL
6	14	1084.00006.00	NUT, 8-32 18-8 HEX MACHINE SCREW
7	1	1025.00012.00	TUBE, 5/16"OD X 3/16"ID X 11.00"LG
8	1	1102.00345.00	ASSEMBLY, BYPASS VALVE, TBS-2111
9	1	1102.00113.00	SWITCH, REED, ASSEMBLY
10	2	1029.00006.00	NUT, FINGER, #4-40 NYLON
11	1	1024.00059.00	GASKET, FRONT 4A
12	1	1102.00354.00	ASSEMBLY, FRONT PANEL, TBS-2111
13	4	1082.00058.00	SCREW, # 8-32 X 5/8, FLAT HD, PH, 18-8 SS
14	1	1024.00040.00	CARD PLUG, HWD-2100
15	12	1084.00011.00	NUT, CLIP ON (J-NUT), #6-32, 22-20 GA., BLK-PH FINISH
16	1	1104.00143.00	TANK ASSEMBLY, 3kW/240VAC, TBS-2111
17	6	1083.00011.00	WASHER, #8 SCREW SIZE, INTERNAL TOOTH LOCK
18	1	1025.00119.00	TUBE, 5/8"OD x 3/8"ID x 2.50"LG
19	9	1086.00003.00	UNICLAMP, 15.9 HOSE OD CLAMP
20	1	1029.00002.00	FITTING, HOSE BARB TEE, SIZE 3/8"
21	1	1025.00114.00	DRAIN TUBE, 5/8"OD x 3/8"ID x 12"LG., CBS-2121
22	1	1025.00004.00	TUBE, 5/8"OD X 3/8"ID X 8"LG, TANK WATER INLET
23	1	1057.00043.00	SOLENOID VALVE, 6L/min, 180 DEG, 24VDC
24	2	1083.00005.00	WASHER, M4 18-8 INTERNAL TOOTH LOCKWASHER
25	2	1082.00010.00	SCREW, M4x10 ZINC-PLATED PAN HD. PHILLIPS MACH.
26	1	1102.00243.00	ADAPTER ASSY, 3/4" BSP x 1/4" NPT x 3/8" TUBE
27	1	1025.00046.00	TUBE, 5/8" OD X 3/8" ID X 5.0" LG, DOUBLE VALVE
28	2	1086.00018.00	HEYCO HOSE CLAMP DIA. .875-1.00
29	1	1025.00011.00	TUBE, 5/8 OD x 3/8 ID x 4.25" LG
30	2	1023.00147.00	PLUG, TANK SERVICE DRAIN FOR 18 GA AND UP BODY
31	1	1058.00024.00	SWITCH, POWER, DOUBLE POLE, 16A, 125/250 VAC
32	1	1112.00246.00	WELDMENT BRACKET TERMINAL BLOCK, 3 POLE
33	1	1052.00025.00	PLATE, MARKING #BS1016E
34	1	1052.00022.00	EUROSTRIP HE10 TERMINAL BLOCK., 3 POLE, 50AMP, 18-8
35	2	1082.00082.00	SCREW, PHILLIP HD., 8-32 THREAD
36	2	1065.00009.00	GROUND LUG CONNECTOR, 14-2 AWG, ALUMINUM
37	1	1044.00013.00	LABEL EQUIPOTENTIALITY, CE
38	1	1044.00012.00	LABEL GROUND, CE
39	1	1052.00029.00	EMI FILTER, TWO LINE 20A, 120/250VAC
40	2	1083.00009.00	WASHER, #6 SCREW, INTL TOOTH LOCKWASHER
41	2	1081.00061.00	STANDOFF, 1/4 HEX x 1 1/4 LG., #6-32 THREAD
42	1	1086.00008.00	CONNECTOR, CABLE CLAMP, 3/4"
43	4	1081.00006.00	SPACER, 6MM OD x 3.2MM ID x 5MM LG, Z/P
44	1	1052.00001.00	POWER SUPPLY, 90-264VAC/24VDC, 1.8A
45	4	1029.00012.00	SPACER, .25" HEX X 1" LG, FEM #4-40 THREAD
46	1	1025.00120.00	TUBE, 9/16"OD X 5/16"ID X 13.00"LG
47	1	1086.00001.00	CLAMP, HOSE, 15.0-17.2 DIA RANGE
48	2	1086.00047.00	CAP PLUG, PANEL, 15/32 ID x 5/8 OD, TBS-2111
49	1	1001.00338.00	COVER, TOP, TBS-2111
50	13	1082.00017.00	SCREW, TRUSS HD. PHIL. MACHINE, # 6-32 X 1/2 LG.
51	1	1001.00337.00	COVER, UPPER BASE, TBS-2111
52	1	1402.00093.00	HARNESS, UNIVERSAL, TBS-2111
53	1	1102.00344.00	ASSEMBLY, FRONT COVER, TBS-2111
54	2	1046.00006.00	LABEL, WARNING, "HOT WATER FAUCET"
54	1	B015280BN2	BREW BASKET-PLASTIC (STANDARD)
55	1	B023280B1	BREW BASKET-STAINLESS STEEL- (OPTIONAL)
56	1	1063.00030.00	CORD PWR, 16A/250VAC, EU1-16P PLUG, W/O CONNECTOR, CE

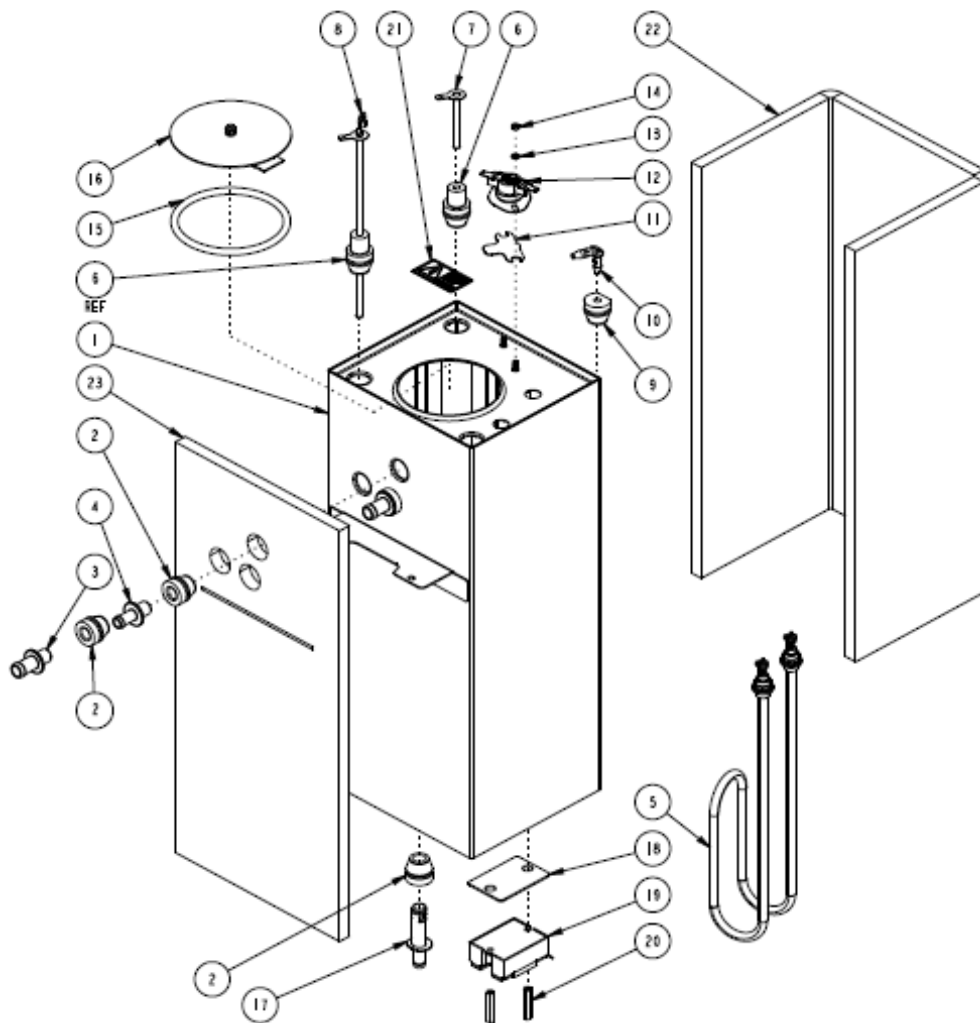

Drawing 1104.00143.00 TANK ASSEMBLY, 3kW/240VAC, CBS-2111

Ref#	Qty	Part number	Description
1	1	1114.00145.00	WELDMENT, TANK, TBS-2111
2	4	1024.00050.00	GROMMET, SILICONE, 11.4mm ID
3	2	1023.00167.00	FITTING, BREW, GROMMET DESIGN
4	1	1023.00168.00	FITTING, HOT WATER, GROMMET DESIGN
5	1	1107.00018.00	HEATER ASSEMBLY, IMMERSION 3000W/240VAC
6	2	1024.00053.00	LEVEL AND TEMP PROBE GROMMET
7	1	1112.00002.00	PROBE WELDMENT, WATER LEVEL 2.25" LG
8	1	1102.00161.00	PROBE ASSEMBLY, TEMP. AND LLC, HWD-2100
9	1	1024.00062.00	GROMMET, SHORT, SILICONE, LEVEL AND TEMP PROBE
10	1	1029.00023.00	FITTING, SINGLE BARBED ELBOW, 1/4", KYNAR
11	1	1003.00005.00	BRACKET, ONE SHOT THERMOSTAT
12	1	1053.00004.00	THERMOSTAT, SINGLE SHOT, 25A
13	2	1083.00009.00	WASHER, #6 SCREW, INTL TOOTH LOCKWASHER
14	2	1084.00010.00	NUT, HEX, #6-32, UNDERSIZED, ZINC PLATED
15	1	1024.00007.00	O-RING, DASH #344, TANK COVER
16	1	1102.00007.00	TANK COVER ASSEMBLY
17	1	1023.00166.00	FITTING, COLD WATER INLET, GROMMET DESIGN
18	1	1003.00140.00	ALUMINUM BRACKET FOR SSR
19	1	1052.00033.00	RELAY, SOLID STATE, 50A/480VAC, W/BUILD IN VARISTOR
20	2	1081.00042.00	STANDOFF, 1/4" HEX
21	1	1044.00004.00	LABEL, DANGER, HIGH VOLTAGE
22	1	1022.00101.00	BACK INSULATION, TANK, TBS-2111
23	1	1022.00102.00	FRONT INSULATION, TANK, TBS-2111

1102.00203.00		Spray Housing Assembly Parts		CBS-2111XTS	
Ref.	QTY	PART NO	DESCRIPTION		
1	1	1102.00203.00	Complete Spray Housing		
2	1	1102.00019.00	Replacement, Cascade Spray Dome		
3	1	#3 Contained in KIT 1000.00097.00	VALVE DIAPHRAGM		
3	1		ADAPTER PLATE, SPACER		
3	1		PLUNGER, DISPENSE VALVE 24VDC		
3	1		SPRING, DISPENSE VALVE 24VDC		
3	1		1057.00022.00	COIL AND FRAME ASSEMBLY DSV11 24VDC	
3	4	1082.00076.00	SCREW, #6-20 X 1/2", PHIL		
4	1	1102.00020.00	SPRAY HOUSING ASSY CSD DESIGN		
4	1	#4 Contained in KIT 1000.00096.00	O-RING, AS568A-019, BUNA-N		
4	1		1102.00019.00	ASSEMBLY, CASCADE SPRAY DOME	
4	1		ADAPTER, SPRAY HSG, DSV11 VALVE		
4	2		SCREW, M3.9x13, CHEESE PH		
4	1		1024.00063.00	O-RING, Lower 3 15/16" x 3/32"	
5	Valve rebuild kit 1000.00098.00		Kit contains: SPRING DIAPHRAGM PLUNGER		

Brew Basket Parts

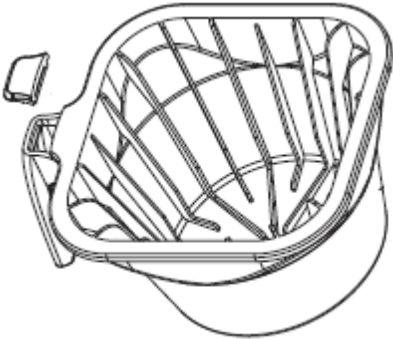
STANDARD Plastic Brew Basket															
Part Number	CBS-2111														
Part Number B015280BN2 – Complete Plastic Brew Basket															
<p>Brown colored insert is standard</p>  <p>Brew basket handle plug for polymeric brew baskets is available in optional colors.</p>	<table border="1"> <thead> <tr> <th>Part Number</th> <th>Plug Insert color</th> </tr> </thead> <tbody> <tr> <td>1023.00195.00</td> <td>BROWN PLUG, BB HANDLE</td> </tr> <tr> <td>1023.00194.00</td> <td>BLACK PLUG, BB HANDLE</td> </tr> <tr> <td>1023.00190.00</td> <td>RED PLUG, BB HANDLE</td> </tr> <tr> <td>1023.00191.00</td> <td>GREEN PLUG, BB HANDLE</td> </tr> <tr> <td>1023.00192.00</td> <td>ORANGE PLUG, BB HANDLE</td> </tr> <tr> <td>1023.00180.00</td> <td>BLUE PLUG, BB HANDLE</td> </tr> </tbody> </table>	Part Number	Plug Insert color	1023.00195.00	BROWN PLUG, BB HANDLE	1023.00194.00	BLACK PLUG, BB HANDLE	1023.00190.00	RED PLUG, BB HANDLE	1023.00191.00	GREEN PLUG, BB HANDLE	1023.00192.00	ORANGE PLUG, BB HANDLE	1023.00180.00	BLUE PLUG, BB HANDLE
	Part Number	Plug Insert color													
	1023.00195.00	BROWN PLUG, BB HANDLE													
	1023.00194.00	BLACK PLUG, BB HANDLE													
	1023.00190.00	RED PLUG, BB HANDLE													
	1023.00191.00	GREEN PLUG, BB HANDLE													
	1023.00192.00	ORANGE PLUG, BB HANDLE													
1023.00180.00	BLUE PLUG, BB HANDLE														

OPTIONAL Stainless Steel Brew Basket			
Ref#	Qty	Part Number	Description
←		B023280b1	COMPLETE STAINLESS STEEL BREW BASKET
1	1	1112.00515.00	BREW BASKET WELDMENT (CONE ONLY)
2	1	1046.00025.00	BREW BASKET WARNING LABEL
3	1	1082.00040.00	SCREW, 1/4-20X.5, FL-HD, PH., W/NYLON PATCH
4	1	1009.00005.00	WIRE BASKET
5	1	1102.00064.00	HANDLE W/MAGNET ASSEMBLY, BLACK
Optional colored handle		1102.00065.00	HANDLE W/MAGNET ASSEMBLY, RED
Optional colored handle		1102.00066.00	HANDLE W/MAGNET ASSEMBLY, GREEN
Optional colored handle		1102.00067.00	HANDLE W/MAGNET ASSEMBLY, ORANGE

Hot water service faucet, if required by operator, is installed before initial set-up

CBS-2111XTS is supplied with part number 1000.00109.00 hot water faucet accessory set.

→ Professional installation is required. Do not connect water or electrical utilities before installing.

1) Remove top cover-as shown →

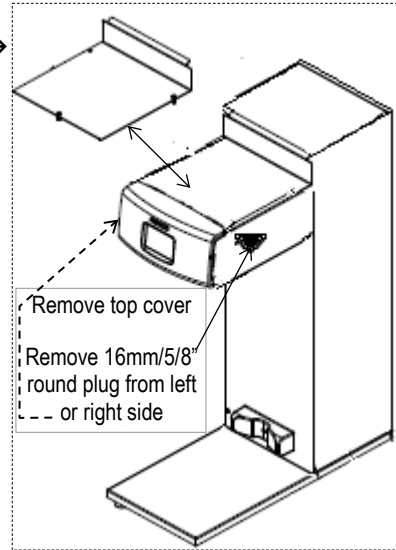

- 2) Remove the 16mm/5/8" round plug from the enclosure
Select either the left or right side-(left side shown)
- 3) From outside of brewer-Install faucet assembly
- 4) From inside of brewer-Thread jam nut on faucet stub.
- 5) Tighten jam nut firmly against enclosure wall
- 6) Locate plugged hot water supply silicone tube.

As Supplied
Locate the plugged end of
silicone tube from hot water tank



- 7) Remove plug from hot water supply silicone tube
- 8) Place clamp 2-3 inches from open tube end as shown

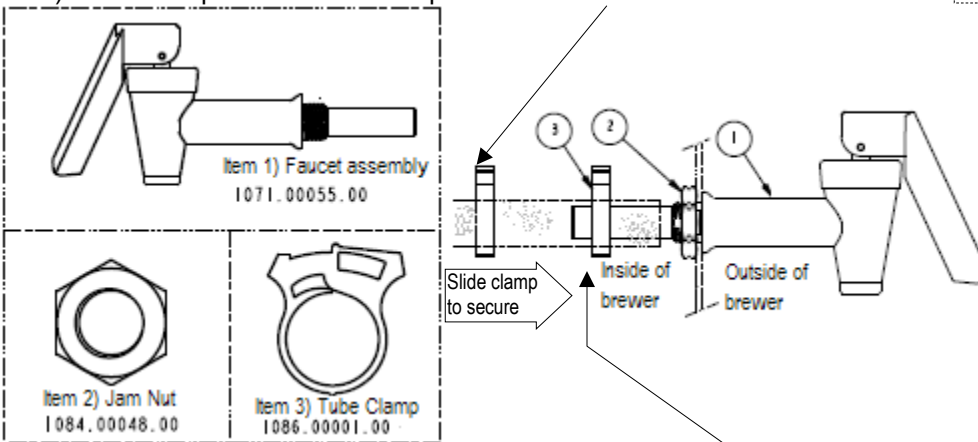

- 9) Push open end of silicone tube over faucet stub
- 10) Slide clamp over tube and secure. Tube and clamp must be secure
- 11) Fill brewer and test faucet-check for leaks and reinstall top cover

Configurable Dispenser Locator

Factory configured for 7 inch dispenser

To Configure for wider dispensers:

Remove screw and 7 inch adapter as shown

