

## INTEGRATED NETWORK AV RECEIVER

# AVR-X1400H

# AVR-S730H



- For purposes of improvement, specifications and design are subject to change without notice.
- Please use this service manual with referring to the operating instructions without fail.
- Some illustrations using in this service manual are slightly different from the actual set.

*Click here!*

### On-line service parts list

URL:<http://dmedia.dmglobal.com/Document/DocumentDetails/23150>

[Online Parts List](#) (P5 to P7)

### On-line owner's manual

NA: <http://manuals.denon.com/AVRX1400H/NA/EN/index.php>

EU: <http://manuals.denon.com/AVRX1400H/EU/EN/index.php>

AP: <http://manuals.denon.com/AVRX1400H/AP/ZH/index.php>

NA: <http://manuals.denon.com/AVRS730H/NA/EN/index.php>

## CAUTION IN SERVICING

## ELECTRICAL

## MECHANICAL

## REPAIR INFORMATION

## UPDATING

Please refer to the **MODIFICATION NOTICE**.

**Confidential**

# CAUTION IN SERVICING

## SAFETY PRECAUTIONS

## NOTE FOR SCHEMATIC DIAGRAM

## NOTE FOR PARTS LIST

## INSTRUCTIONS FOR HANDLING SEMICONDUCTORS AND OPTICAL UNIT

### Online Parts List

[Accessing the Parts List](#)

[Logging in to New SDI and Accessing the Parts List](#)

[Accessing the Part List from the Model Asset Screen](#)

[PRINTED CIRCUIT BOARDS Parts Table](#)

[Downloading the Parts List as an Excel File](#)

[Revision History](#)

[Searching Part Numbers or Ref. Numbers](#)

## CAUTION IN SERVICING.

[Initializing This Unit](#) **AVR-X1400H**

[JIG FOR SERVICING](#)

[Initializing This Unit](#) **AVR-S730H**

[JIG FOR SERVICING](#)

# SAFETY PRECAUTIONS

The following items should be checked for continued protection of the customer and the service technician.

## Leakage current check

Before returning the set to the customer, be sure to carry out either (1) a leakage current check or (2) a line to chassis resistance check. If the leakage current exceeds 0.5 milliamps, or if the resistance from chassis to either side of the power cord is less than 460 kohms, the set is defective. Be sure to test for leakage current with the AC plug in both polarities, in addition, when the set's power is in each state (on, off and standby mode), if applicable.

### CAUTION

**Please heed the following cautions and instructions during servicing and inspection.**

#### ⊙ Heed the cautions!

Cautions which are delicate in particular for servicing are labeled on the cabinets, the parts and the chassis, etc. Be sure to heed these cautions and the cautions described in the handling instructions.

#### ⊙ Cautions concerning electric shock!

- (1) An AC voltage is impressed on this set, so if you touch internal metal parts when the set is energized, you may get an electric shock. Avoid getting an electric shock, by using an isolating transformer and wearing gloves when servicing while the set is energized, or by unplugging the power cord when replacing parts, for example.
- (2) There are high voltage parts inside. Handle with extra care when the set is energized.

#### ⊙ Caution concerning disassembly and assembly!

Through great care is taken when parts were manufactured from sheet metal, there may be burrs on the edges of parts. The burrs could cause injury if fingers are moved across them in some rare cases. Wear gloves to protect your hands.

#### ⊙ Use only designated parts!

The set's parts have specific safety properties (fire resistance, voltage resistance, etc.). Be sure to use parts which have the same properties for replacement. The burrs have the same properties. In particular, for the important safety parts that are indicated by the  $\triangle$  mark on schematic diagrams and parts lists, be sure to use the designated parts.

#### ⊙ Be sure to mount parts and arrange the wires as they were originally placed!

For safety reasons, some parts use tapes, tubes or other insulating materials, and some parts are mounted away from the surface of printed circuit boards. Care is also taken with the positions of the wires by arranging them and using clamps to keep them away from heating and high voltage parts, so be sure to set everything back as it was originally placed.

#### ⊙ Make a safety check after servicing!

Check that all screws, parts and wires removed or disconnected when servicing have been put back in their original positions, check that no serviced parts have deteriorate the area around. Then make an insulation check on the external metal connectors and between the blades of the power plug, and otherwise check that safety is ensured.

(Insulation check procedure)

Unplug the power cord from the power outlet, disconnect the antenna, plugs, etc., and on the power. Using a 500V insulation resistance tester, check that the insulation resistance value between the inplug and the externally exposed metal parts (antenna terminal, headphones terminal, input terminal, etc.) is 1M  $\Omega$  or greater. If it is less, the set must be inspected and repaired.

### CAUTION

**Concerning important safety parts**

Many of the electric and the structural parts used in the set have special safety properties. In most cases these properties are difficult to distinguish by sight, and the use of replacement parts with higher ratings (rated power and withstand voltage) does not necessarily guarantee that safety performance will be preserved. Parts with safety properties are indicated as shown below on the wiring diagrams and the parts list in this service manual. Be sure to replace them with the parts which have the designated part number.

- (1) Schematic diagrams Indicated by the  $\triangle$  mark.
- (2) Parts lists Indicated by the  $\triangle$  mark.

The use of parts other than the designated parts could cause electric shocks, fires or other dangerous situations.

## NOTE FOR SCHEMATIC DIAGRAM

### WARNING:

Parts indicated by the  $\triangle$  mark have critical characteristics. Use ONLY replacement parts recommended by the manufacturer.

### CAUTION:

Before returning the set to the customer, be sure to carry out either (1) a leakage current check or (2) a line to chassis resistance check. If the leakage current exceeds 0.5 milliamps, or if the resistance from chassis to either side of the power cord is less than 460 kohms, the set is defective.

### WARNING:

DO NOT return the set to the customer unless the problem is identified and remedied.

### NOTICE:

ALL RESISTANCE VALUES IN OHM. k=1,000 OHM / M=1,000,000 OHM

ALL CAPACITANCE VALUES ARE EXPRESSED IN MICRO FARAD, UNLESS OTHERWISE INDICATED. P INDICATES MICRO-MICRO FARAD. N INDICATES NANO FARAD. EACH VOLTAGE AND CURRENT ARE MEASURED AT NO SIGNAL INPUT CONDITION. CIRCUIT AND PARTS ARE SUBJECT TO CHANGE WITHOUT PRIOR NOTICE.

## NOTE FOR PARTS LIST

1. Parts indicated by "nsp" on this table cannot be supplied.
2. When ordering a part, make a clear distinction between "1" and "1" (i) to avoid mis-supplying.
3. A part ordered without specifying its part number can not be supplied.
4. Part indicated by "@" mark is not illustrated in the exploded view.

**WARNING:** Parts indicated by the  $\triangle$  mark have critical characteristics. Use ONLY replacement parts recommended by the manufacturer.

## INSTRUCTIONS FOR HANDLING SEMICONDUCTORS AND OPTICAL UNIT

Electrostatic breakdown of the semi-conductors or optical pickup may occur due to a potential difference caused by electrostatic charge during unpacking or repair work.

### 1. Ground for Human Body

Be sure to wear a grounding band (1 M ohm) that is properly grounded to remove any static electricity that may be charged on the body.

### 2. Ground for Workbench

Be sure to place a conductive sheet or copper plate with proper grounding (1 M ohm) on the workbench or other surface, where the semi-conductors are to be placed. Because the static electricity charge on clothing will not escape through the body grounding band, be careful to avoid contacting semi-conductors with your clothing

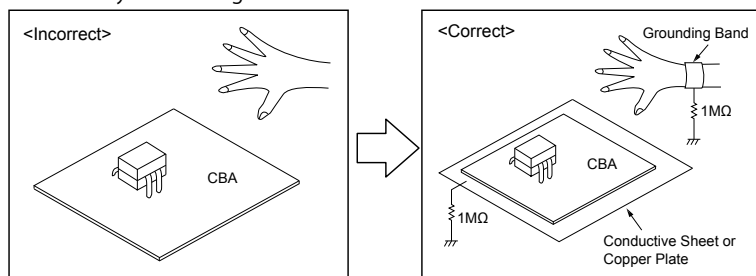

## Accessing the Parts List

- (1) Click the URL link on the cover of the service manual.  
Examples of display

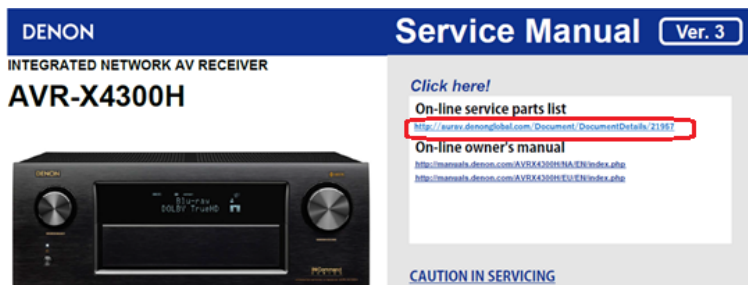

**NOTE:** If the web browser does not open automatically, copy the URL and paste it into the address bar of the web browser and then press Enter.

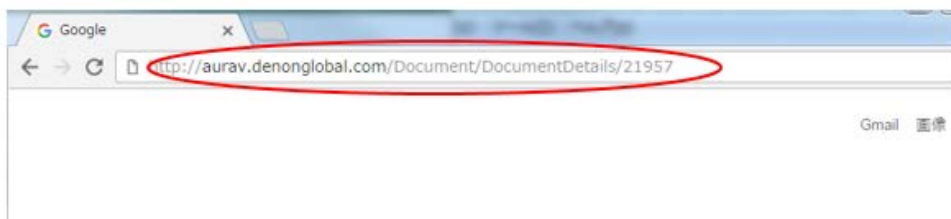

- (2) When the login screen is displayed, enter your username and password.
- (3) Enter the 5 letters shown as the blue CAPTCHA code as single-byte characters.  
If the text is unclear, click "**Refresh**" to change the CAPTCHA code, and enter it again.



- (4) Press the "**Login**" button.

## Logging in to New SDI and Accessing the Parts List

- (1) Access New SDI from the URL below.  
<http://dmedia.dmglobal.com>
- (2) When the login screen is displayed, enter your username and password.
- (3) Enter the 5 letters shown as the blue CAPTCHA code as single-byte characters.  
If the text is unclear, click "**Refresh**" to change the CAPTCHA code, and enter it again.



- (4) Press the "**Login**" button.
- (5) When the Home screen is displayed, click "**Advanced Search**".



- (6) Enter the following search conditions and click "**Search**".  
Keyword : Model name    Brand : brand name    Asset Type : Part list

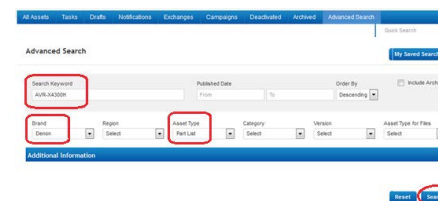

- (7) Click the model name when the search results are displayed.

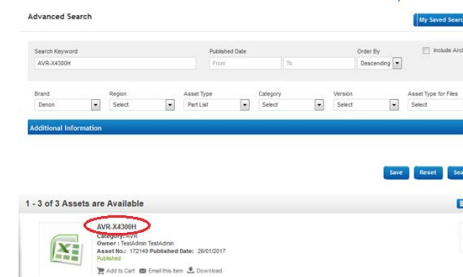

## Accessing the Part List from the Model Asset Screen

- (1) Display Model Asset from New SDI.
- (2) Click the section displayed as ▼ Link to Part Lists under the model name.

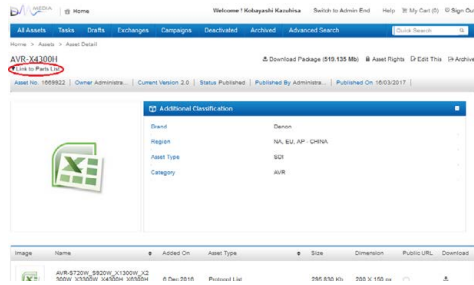

**NOTE:** If the ▼ Link to Parts List section is not displayed, download the parts table from the Asset list.

## Downloading the Parts List as an Excel File

- (1) Displays the Parts List. Click the Download icon.

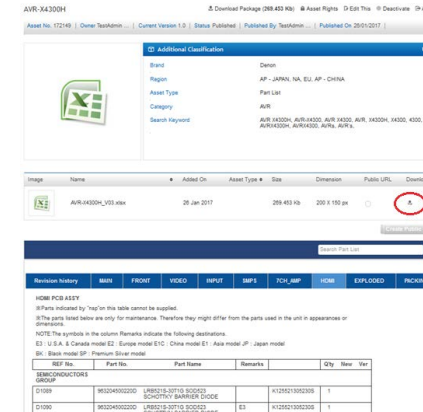

## PRINTED CIRCUIT BOARDS Parts Table

- (1) Display the Parts List. Click the PCB name in the blue bar to display the parts list for the board.

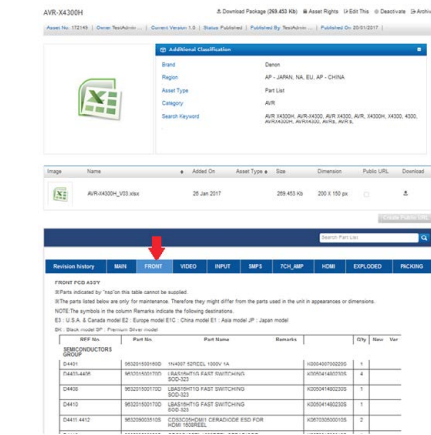

Left and right arrow icons are displayed if the circuit board name does not fit in the blue bar. Click these icons to display a different part of the name when necessary.

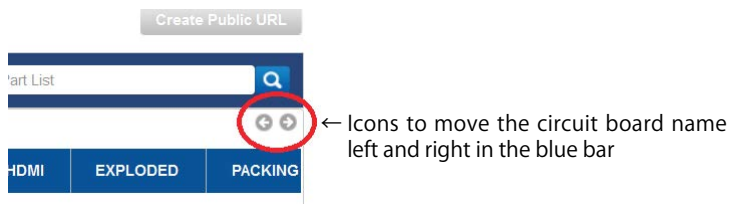

## Revision History

- (1) Click "Revision history" in the blue bar.

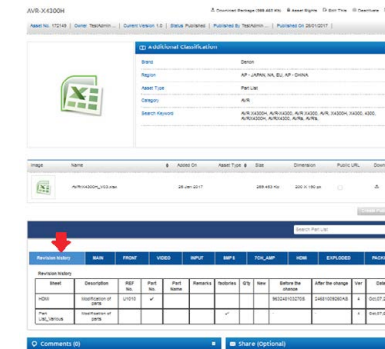

The following details are displayed.

- Sheet : Name of the changed sheet
- Description : Description of the changes
- Remarks : Destination, color information
- Factories : Factory number
- Ver : Version number after revision if changes were made to the parts list
- Date : Date of changes

## Searching Part Numbers or Ref. Numbers

You can search a Parts List for part numbers or Ref. numbers.

- (1) Enter the part number or Ref. number in the search window of the Parts List, and press the search button.
- (2) The search results are displayed.  
The name of the sheet in which the search part is used and the part's line are displayed.

S.No.	Sheet	REF No.	Part No.	Part Name	Remarks	Qty	New	Ver
1	MAIN	D4007	00279041905	15S133-0034-AJIAL LRC	K0000133000405	1		
2	MAIN	D4016	00279041905	15S133-0034-AJIAL LRC	K0000133000405	1		
3	MAIN	D4019	00279041905	15S133-0034-AJIAL LRC	K0000133000405	1		
4	MAIN	D4031.4032	00279041905	15S133-0034-AJIAL LRC	K0000133000405	2		
5	MAIN	D4037	00279041905	15S133-0034-AJIAL LRC	K0000133000405	1		
6	INPUT	D4014.4012	00279041905	15S133-0034-AJIAL LRC	K0000133000405	3		
7	SMP5	D4150	00279041905	15S133-0034-AJIAL LRC	K0000133000405	1		

- (3) Next, click the "Sheet" section of the search results.

S.No.	Sheet	REF No.	Part No.	Part Name	Remarks	Qty	New	Ver
1	MAIN	D4007	00279041905	15S133-0034-AJIAL LRC	K0000133000405	1		
2	MAIN	D4016	00279041905	15S133-0034-AJIAL LRC	K0000133000405	1		
3	MAIN	D4019	00279041905	15S133-0034-AJIAL LRC	K0000133000405	1		

- (4) The Board Part Table opens and the line on which the searched part number appears is highlighted.

REF No.	Part No.	Part Name	Remarks	Qty	New	Ver
<b>SEMICONDUCTORS GROUP</b>						
D4000-4004	9032015001700	LBAS15HTIG FAST SWITCHING 500-323		K0000414802205	5	
D4001	9032015001700	LBAS15HTIG FAST SWITCHING 500-323		K0000414802205	1	
D4008	9032015002000	DIODE BRIDGE D105B80 800V10A STRAIGHT TYPE		K041008002205	1	
D4013	9032015001700	LBAS15HTIG FAST SWITCHING 500-323		K0000414802205	1	
D4014	9032015001500	1N4001 52REEL 1000V 1A		K0004007002205	1	
D4016	00279041905	15S133-0034-AJIAL LRC		K0000133000405	1	

# CAUTION IN SERVICING.

## Initializing This Unit AVR-X1400H

Make sure to initialize this unit after replacing the microcomputer or any peripheral equipment, or the digital PCB.

1. Press the power button to turn off the power.
2. While holding down buttons "**ZONE2 SOURCE**" and "**DIMMER**" simultaneously, press the power button to turn on the power.
3. Release the buttons after confirming that the display flashes at 1-second intervals.
  - \* The unit is initialized.Use network initialization mode to initialize the network related settings.

**NOTE :**

- If the unit fails to enter the service mode in step 3, repeat the procedure from step 1.
- Initializing the device restores the customized settings to the factory settings. Write down your settings in advance and reconfigure the settings after initialization.

AVR-X1400H

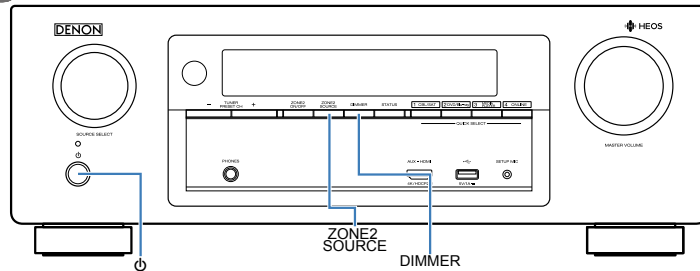

## JIG FOR SERVICING

Use the following jigs (extension cable kit) when repairing the PCBs.  
Order with your dealer for the jigs your dealer if necessary.

8U-110084S : EXTENSION UNIT KIT : 1 Set  
(See [JIG FOR SERVICING](#))

## Initializing This Unit AVR-S730H

Make sure to initialize this unit after replacing the microcomputer or any peripheral equipment, or the digital PCB.

1. Press the power button to turn off the power.
2. While holding down buttons "**TUNER PRESET CH +**" and "**TUNE -**" simultaneously, press the power button to turn on the power.
3. Release the buttons after confirming that the display flashes at 1-second intervals.
  - \* The unit is initialized.Use network initialization mode to initialize the network related settings.

**NOTE :**

- If the unit fails to enter the service mode in step 3, repeat the procedure from step 1.
- Initializing the device restores the customized settings to the factory settings. Write down your settings in advance and reconfigure the settings after initialization.

AVR-S730H

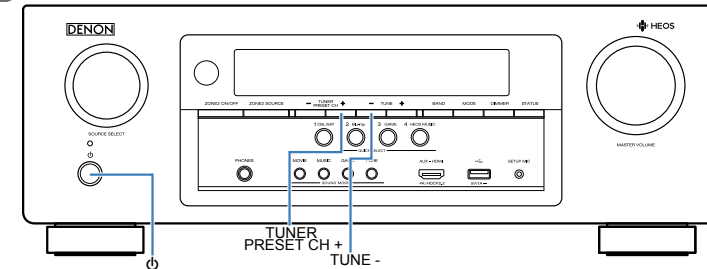

## JIG FOR SERVICING

Use the following jigs (extension cable kit) when repairing the PCBs.  
Order with your dealer for the jigs your dealer if necessary.

8U-110084S : EXTENSION UNIT KIT : 1 Set  
(See [JIG FOR SERVICING](#))

# ELECTRICAL

## SCHEMATIC DIAGRAMS

SCH01 HDMI\_RX  
SCH02 HDMI\_TX  
SCH03 OSD  
SCH04 DIGITAL SUPPLY  
SCH05 MCU  
SCH06 MCU\_LEVEL\_CHG  
SCH07 DIR\_SRC  
SCH08 PLD  
SCH09 DSP  
SCH10 MAIN DAC  
SCH11 NETWORK  
SCH12 ANALOG  
SCH13 MAIN  
SCH14 FRONT HDMI  
SCH15 DIFF-AMP  
SCH16 FRONT  
SCH17 REGULATOR  
SCH18 SMPS

## PRINTED CIRCUIT BOARDS

DIGITAL, F HDMI, TUNER, PHONE  
DIFF-AMP, BIAS-TR, PHONE WIRE GUIDE, FRONT  
CABLE GUIDE, HDMI CABLE GUIDE, REGULATOR  
MAIN  
FRONT, USB&MIC, STANDBY, SMPS

## LEVEL DIAGRAM

FRONT ch  
CENTER, SURROUND ch  
SURROUND BACK ch  
SUBWOOFER ch  
ZONE2 ch

## BLOCK DIAGRAM

ANALOG AUDIO DIAGRAM  
DIGITAL AUDIO DIAGRAM  
VIDEO DIAGRAM

## POWER DIAGRAM

## WIRING DIAGRAM

## SEMICONDUCTORS

1. IC's  
2. FL DISPLAY



HDMI\_TX PART

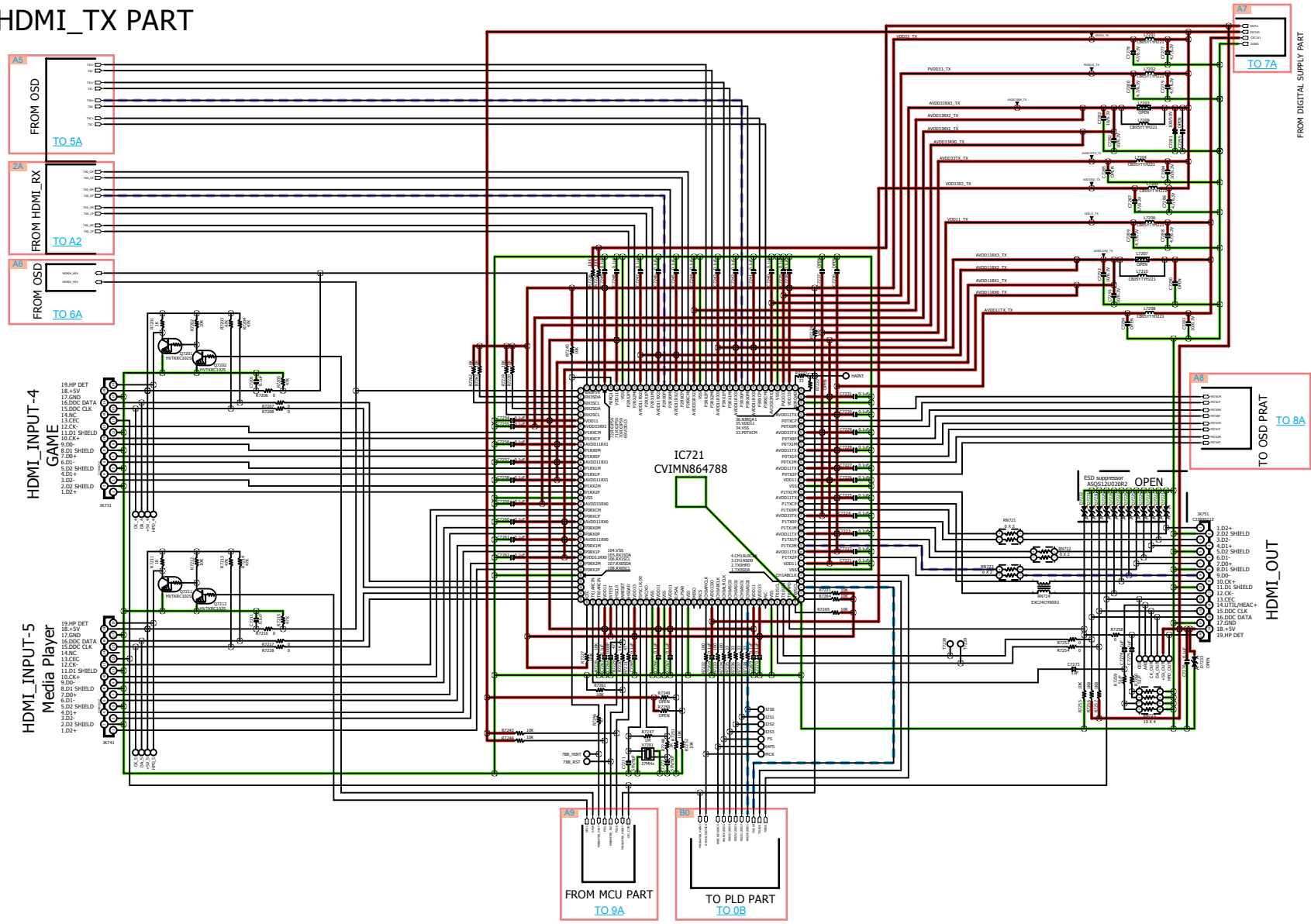

Caution in servicing

Electrical

Mechanical

Repair Information

Updating

OSD PART

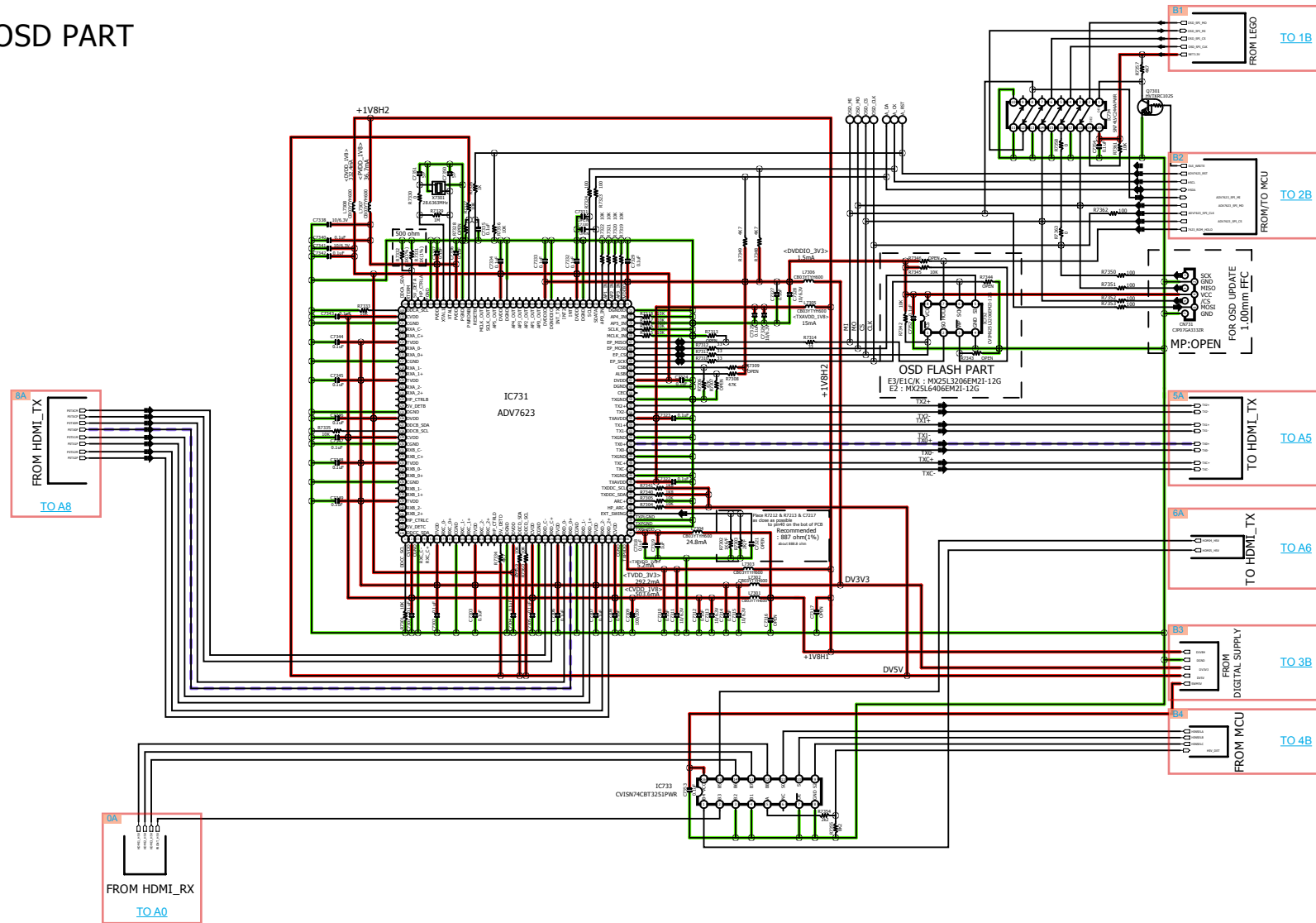

GND LINE    POWER+ LINE    POWER- LINE    ANALOG AUDIO    DIGITAL AUDIO    TMDS SIGNAL    ANALOG VIDEO    STBY POWER

DIGITAL SUPPLY PART

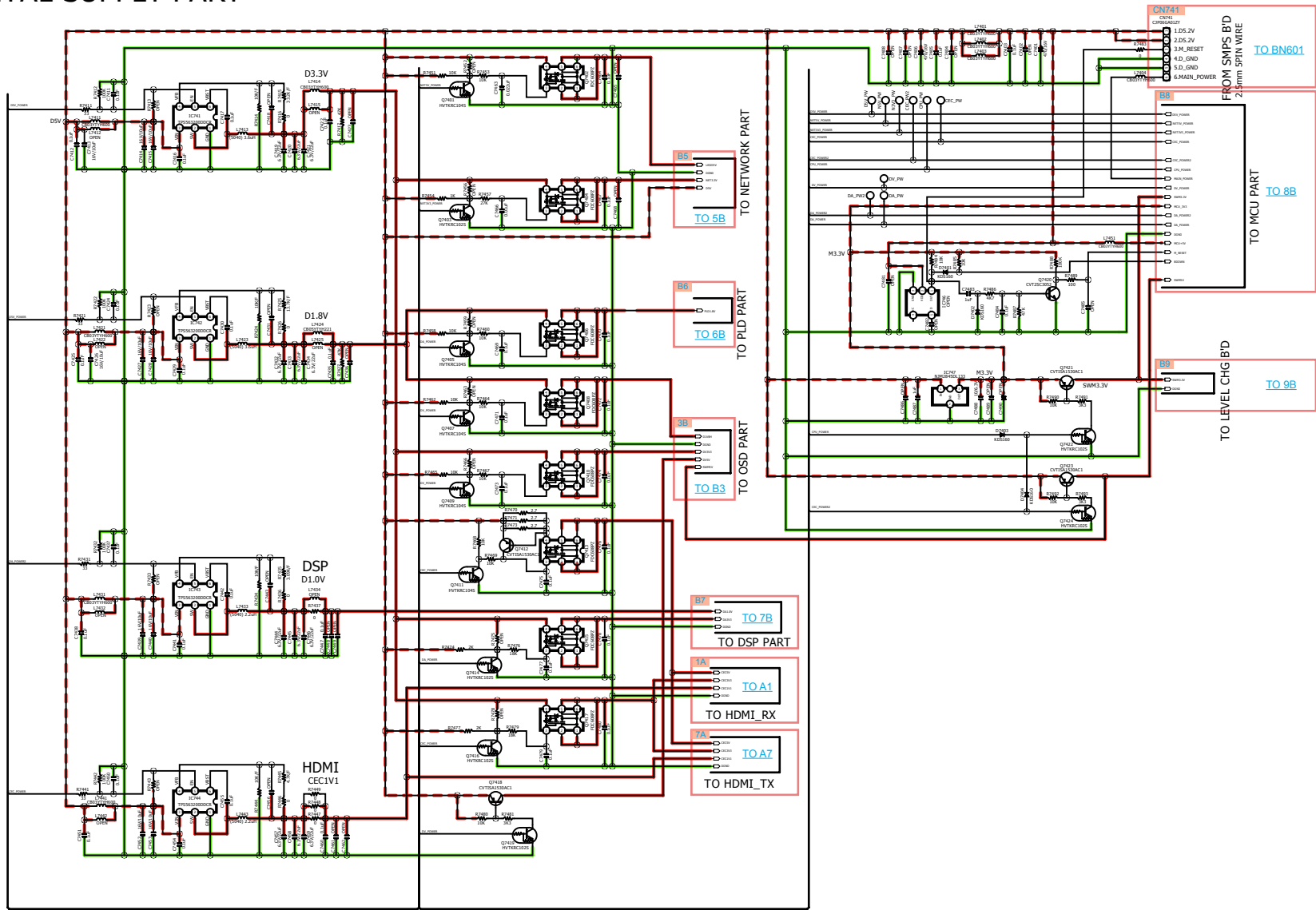

GND LINE    POWER+ LINE    POWER- LINE    ANALOG AUDIO    DIGITAL AUDIO    TMDS SIGNAL    ANALOG VIDEO    STBY POWER

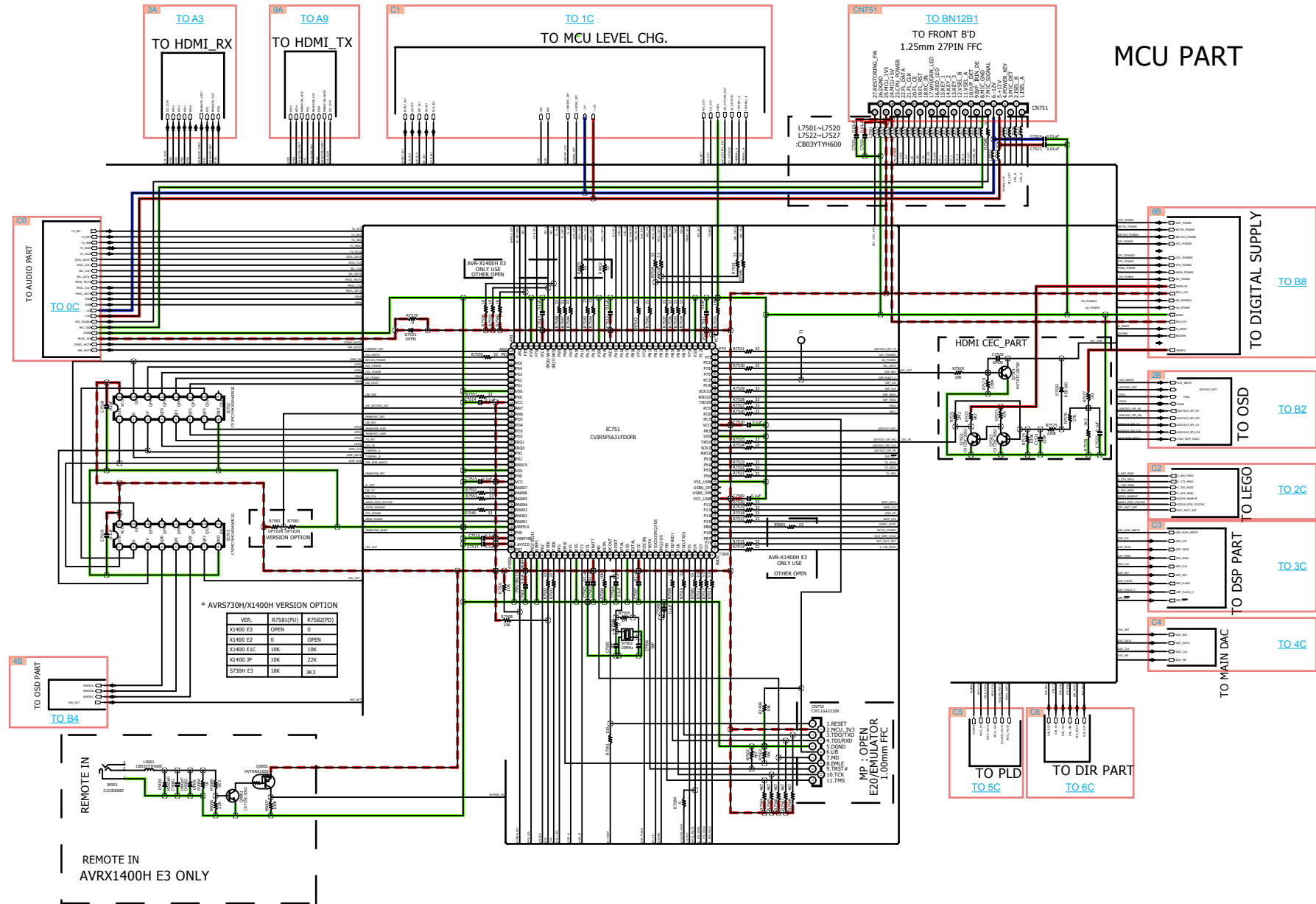

GND LINE    POWER+ LINE    POWER- LINE    ANALOG AUDIO    DIGITAL AUDIO    TMS SIGNAL    ANALOG VIDEO    STBY POWER

MCU\_LEVEL\_CHG PART

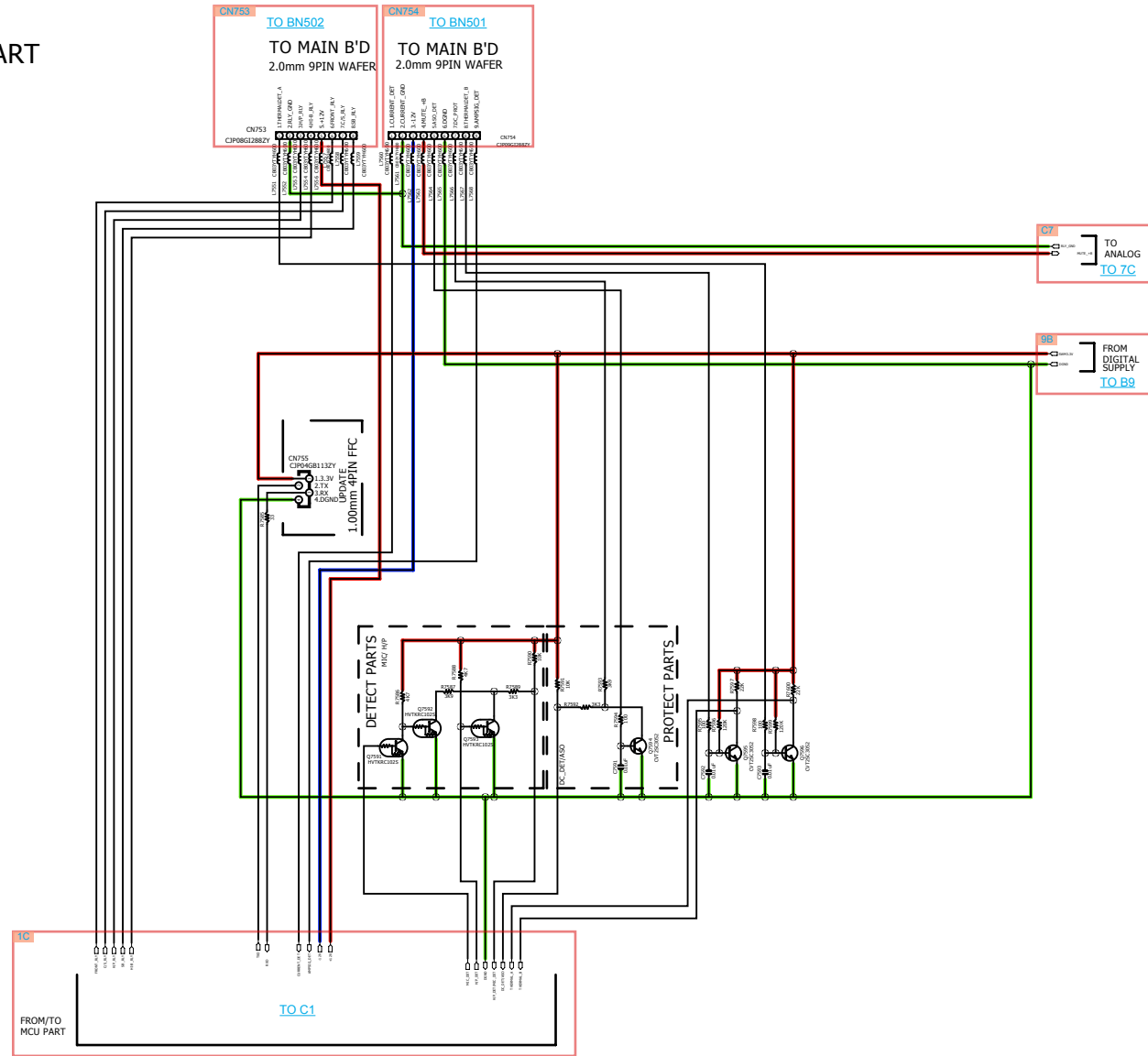

GND LINE POWER+ LINE POWER- LINE ANALOG AUDIO DIGITAL AUDIO TMDS SIGNAL ANALOG VIDEO STBY POWER

DIR PART

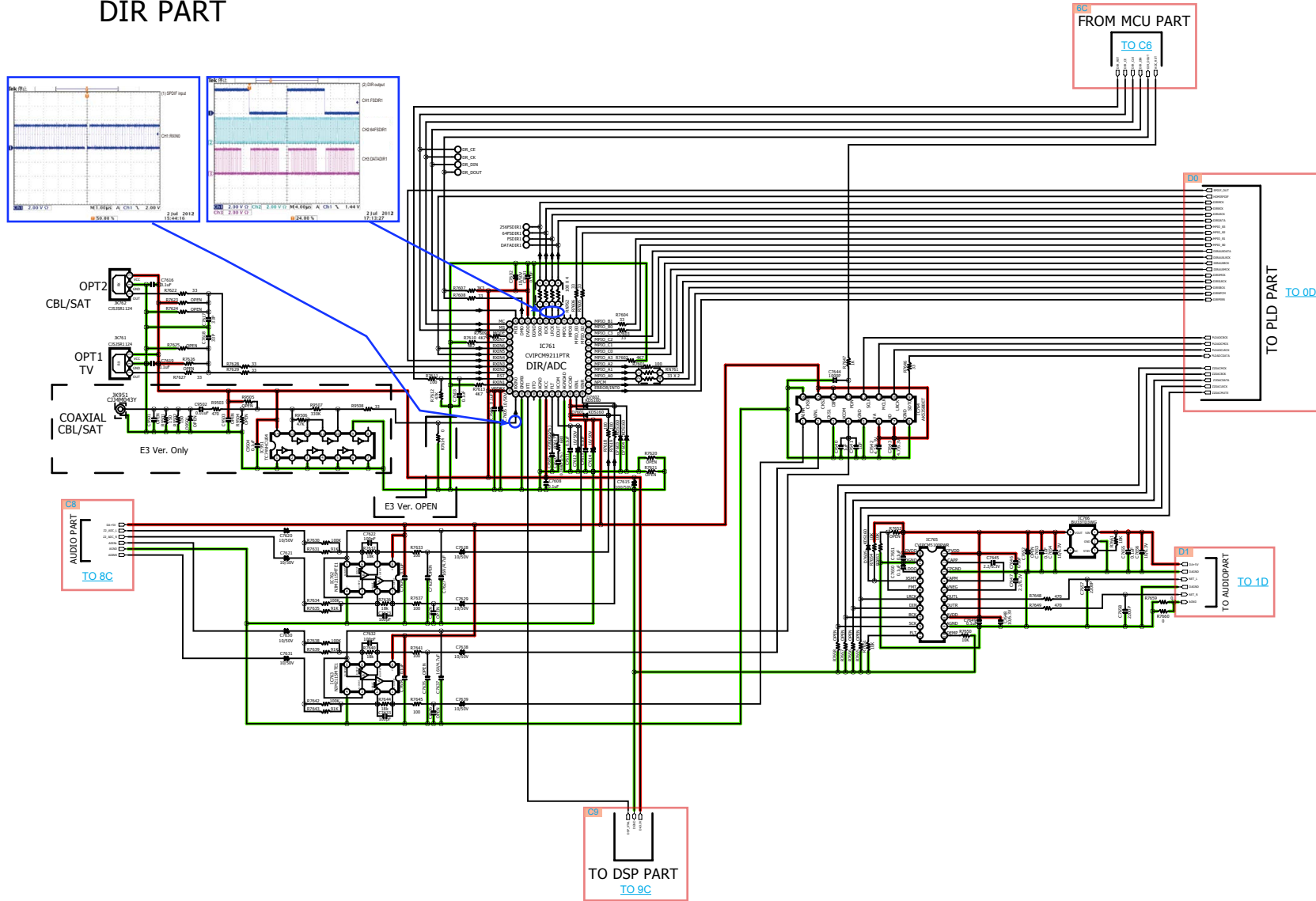

GND LINE POWER+ LINE POWER- LINE ANALOG AUDIO DIGITAL AUDIO TMSD SIGNAL ANALOG VIDEO STBY POWER

PLD PART

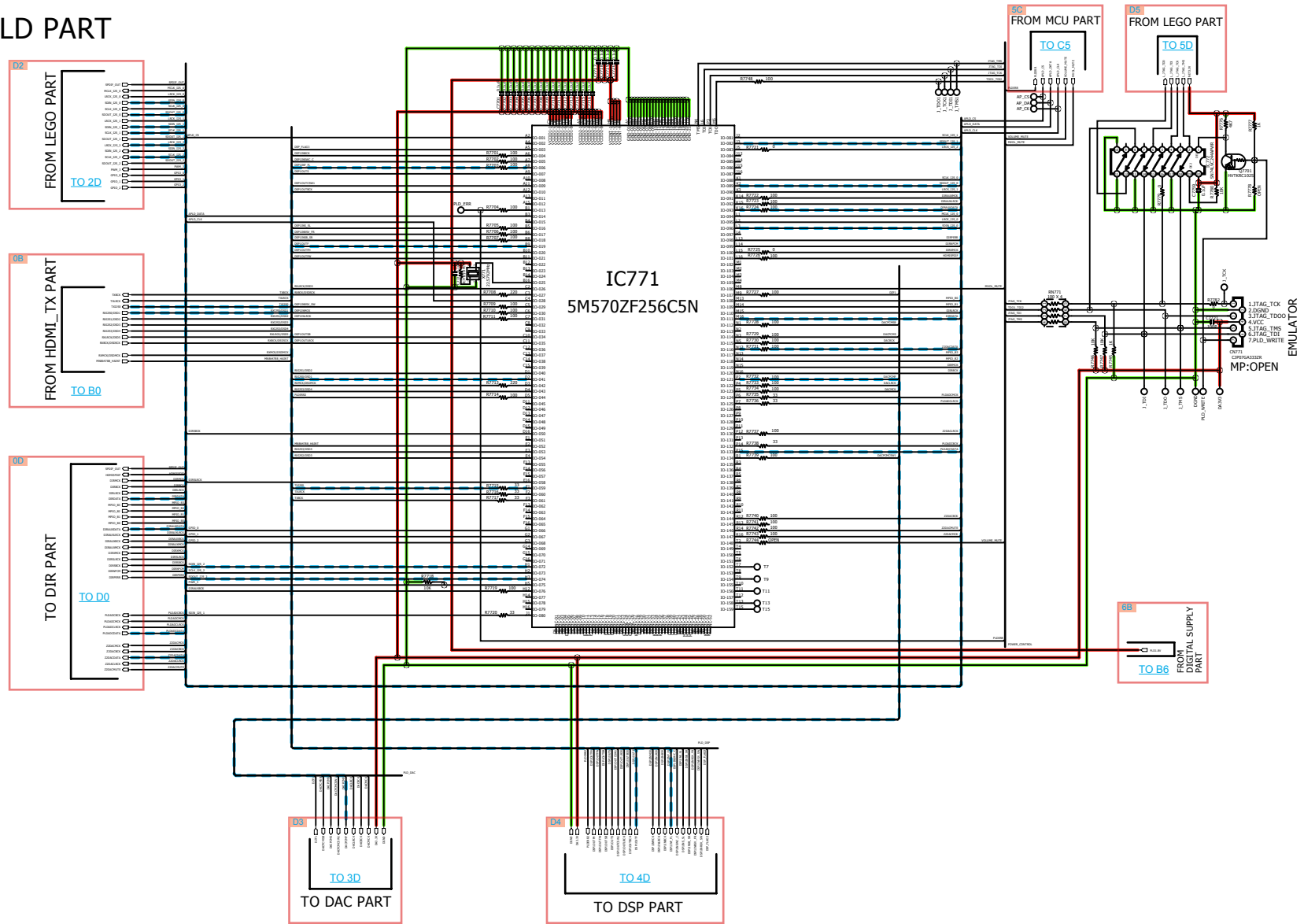

GND LINE    POWER+ LINE    POWER- LINE    ANALOG AUDIO    DIGITAL AUDIO    TMS SIGNAL    ANALOG VIDEO    STBY POWER

DSP PART

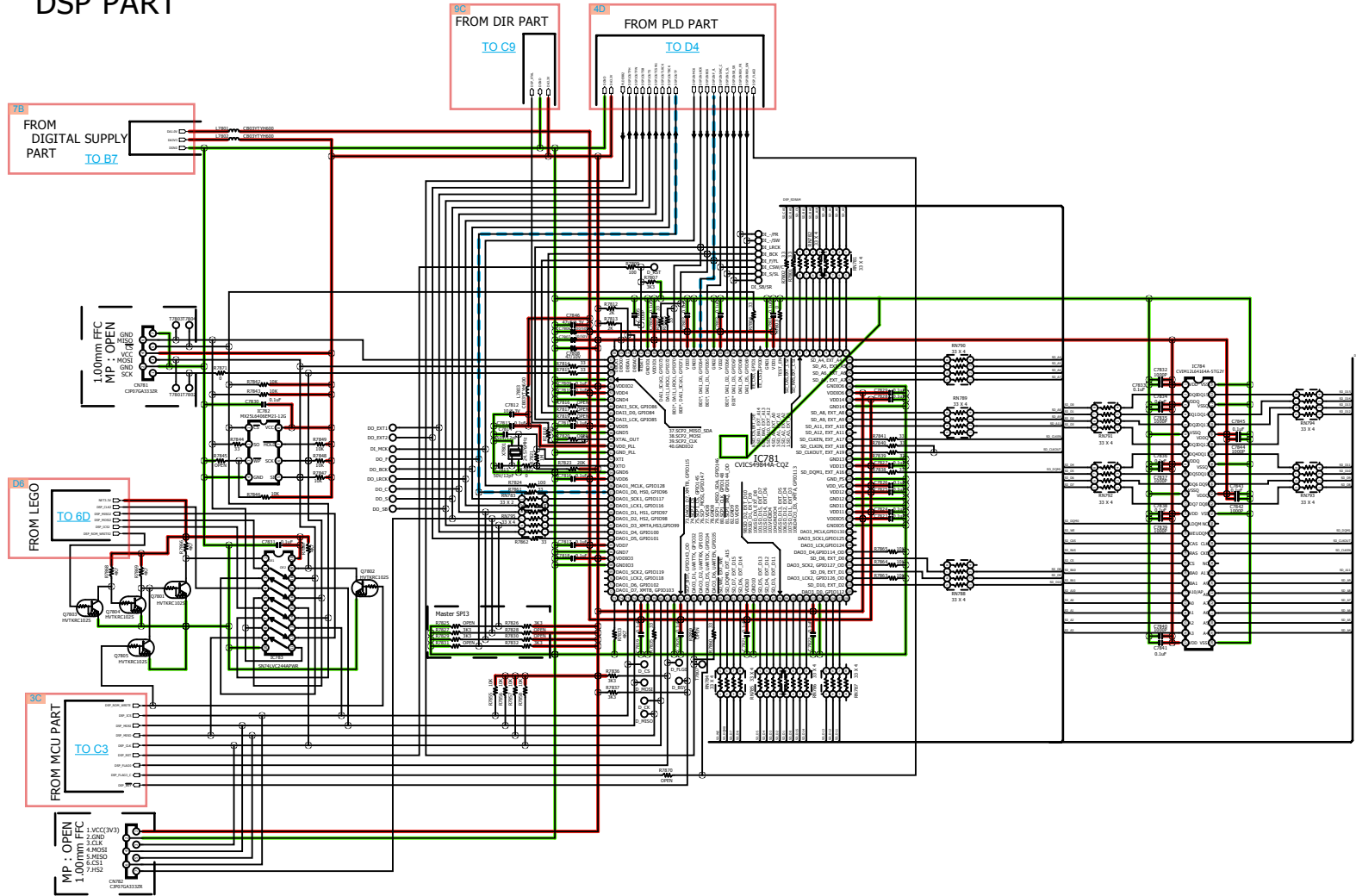

— GND LINE   
 — POWER+ LINE   
 — POWER- LINE   
 — ANALOG AUDIO   
 — DIGITAL AUDIO   
 — TMSD SIGNAL   
 — ANALOG VIDEO   
 — STBY POWER



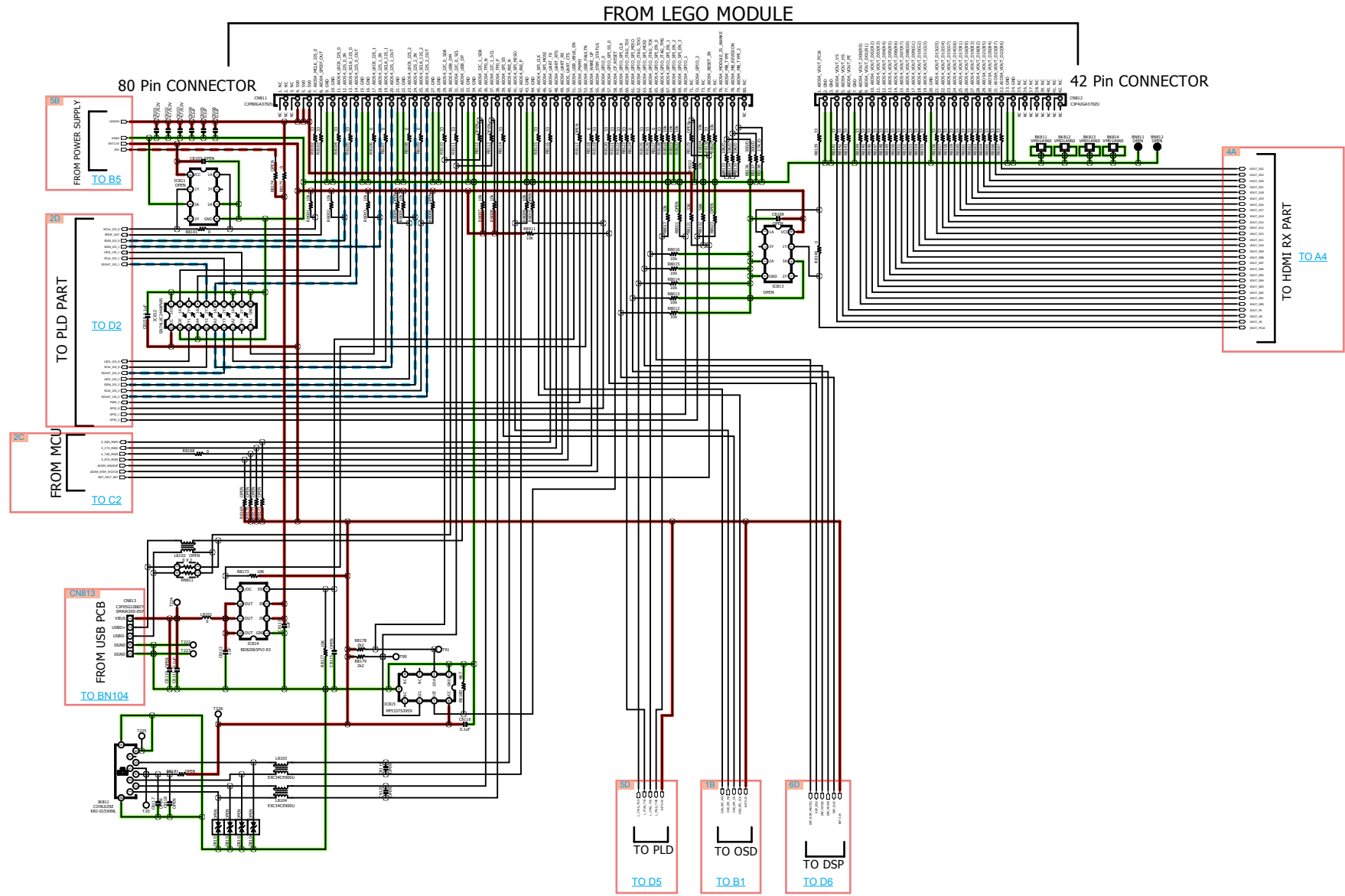

— GND LINE   
 — POWER+ LINE   
 — POWER- LINE   
 — ANALOG AUDIO   
 — DIGITAL AUDIO   
 — TMDS SIGNAL   
 — ANALOG VIDEO   
 — STBY POWER

ANALOG PART

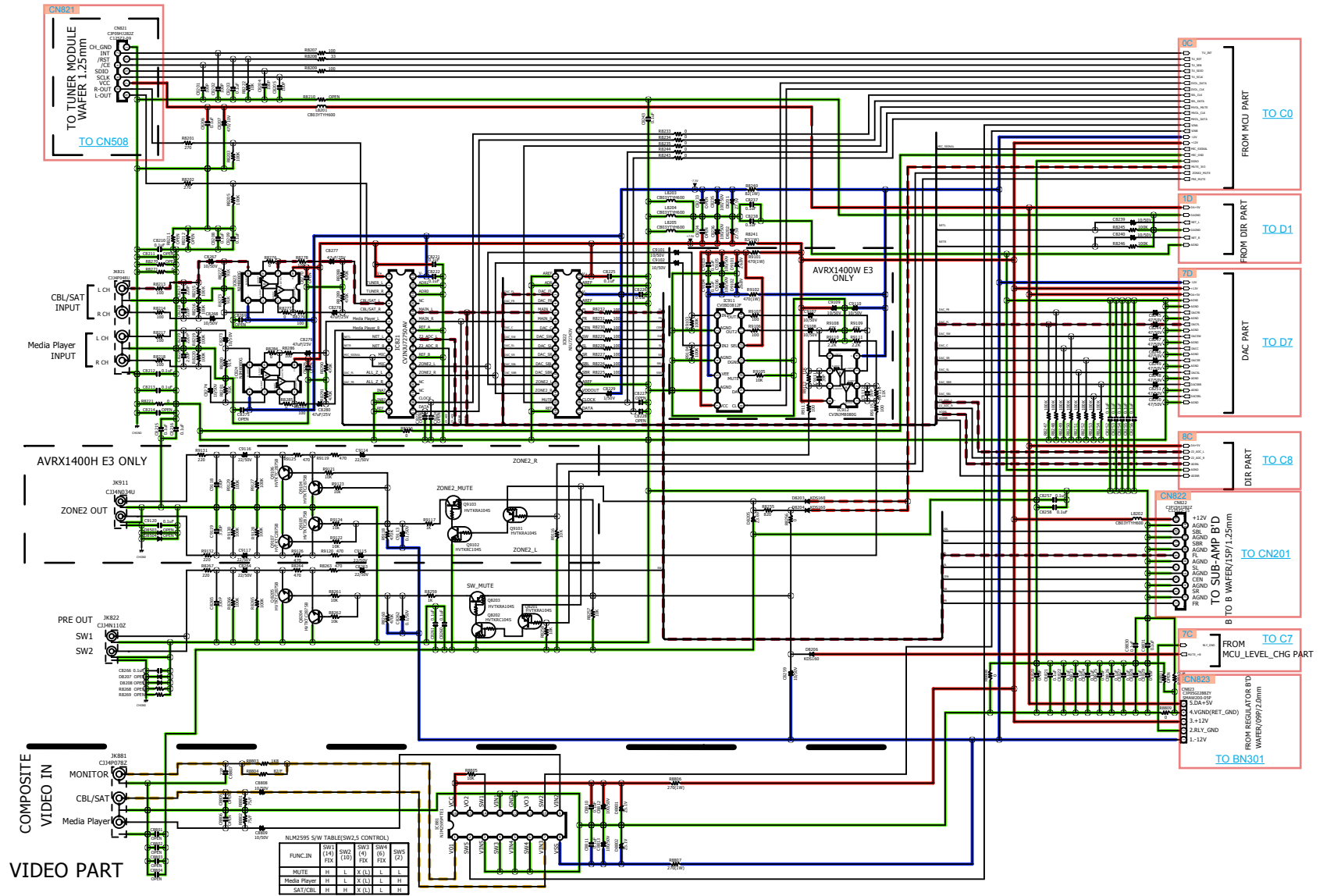

GND LINE    POWER+ LINE    POWER- LINE    ANALOG AUDIO    DIGITAL AUDIO    TMD5 SIGNAL    ANALOG VIDEO    STBY POWER

MAIN PART

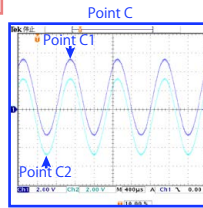
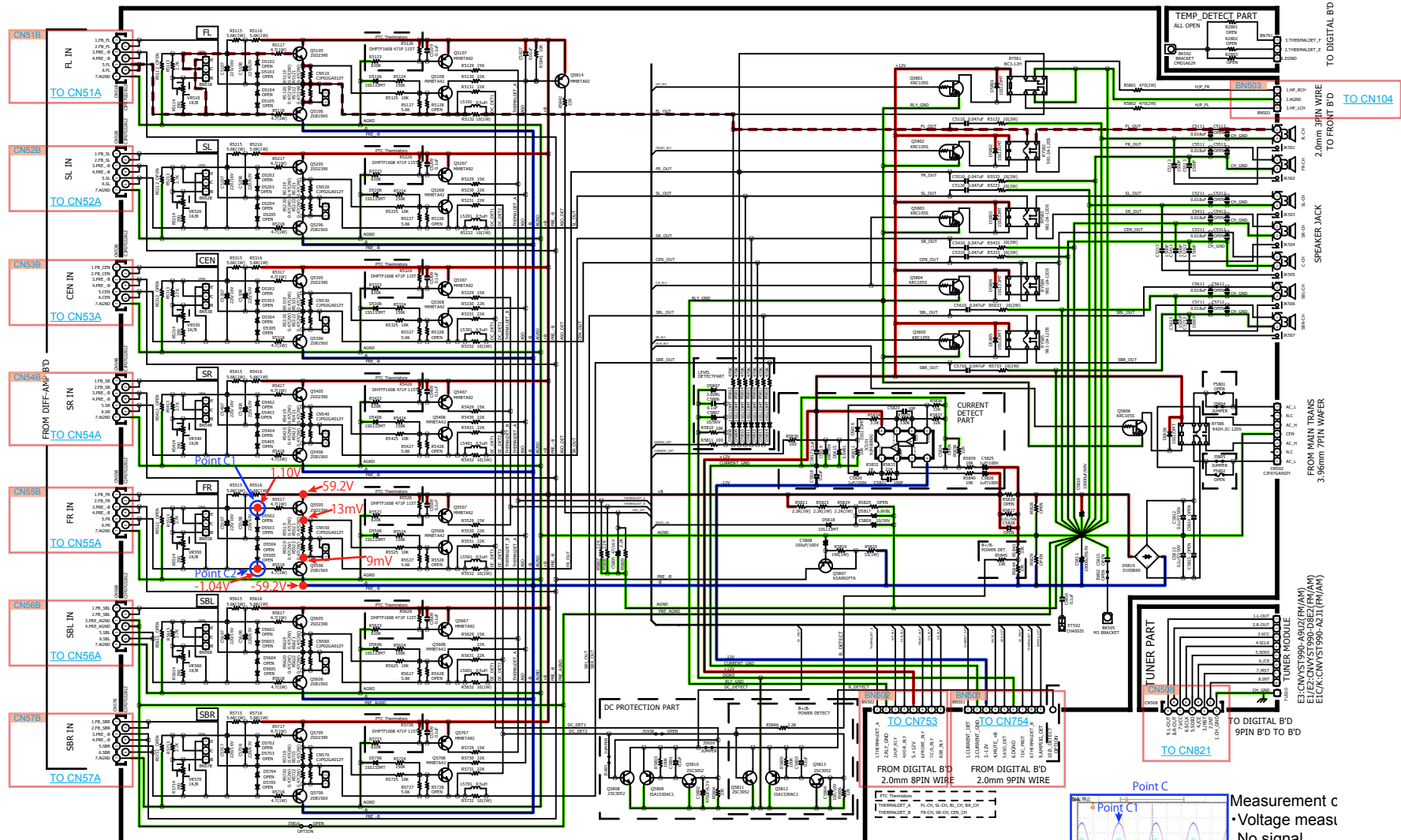

Measurement c  
 • Voltage meas  
 No signal  
 • Waveform me:  
 INPUT: 200m  
 Surround mod  
 VOL: 70  
 Speaker load:

Caution in servicing

Electrical

Mechanical

Repair Information

Updating

FRONT\_HDMI PART

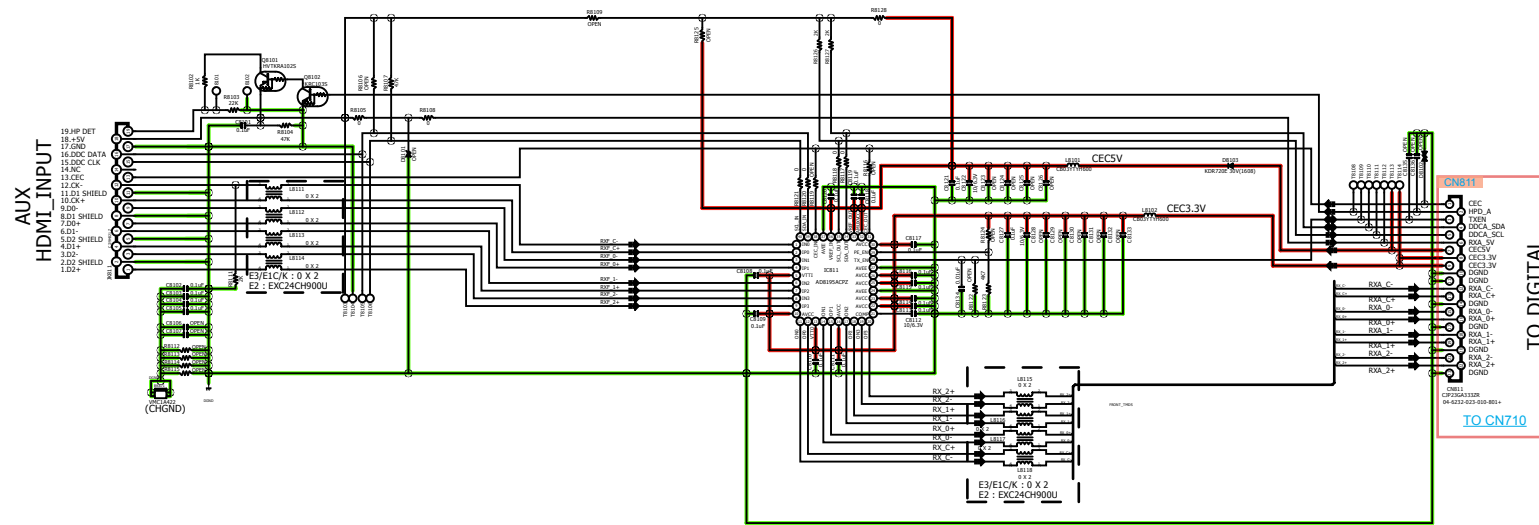

GND LINE POWER+ LINE POWER- LINE ANALOG AUDIO DIGITAL AUDIO TMS SIGNAL ANALOG VIDEO STBY POWER

# AVR-S730H/X1400H DIFF-AMP PART

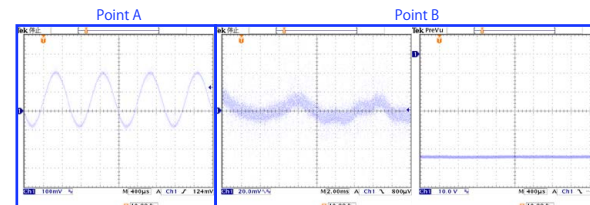
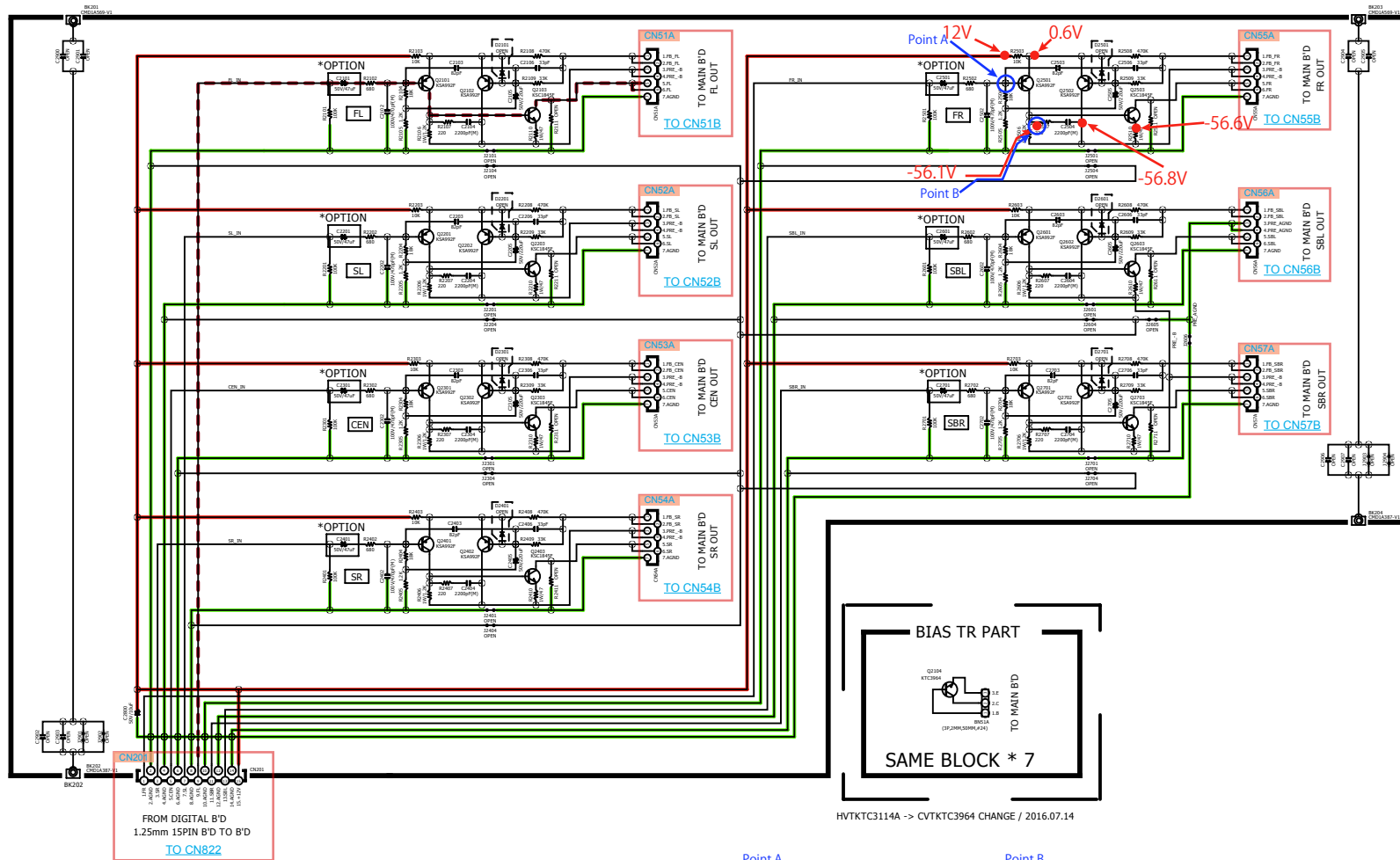

Measurement condition  
 • Voltage measurement  
 No signal  
 • Waveform measurement  
 INPUT: 200mVrms / 1KHz (,  
 Surround mode: MCh Stere  
 VOL: 70  
 Speaker load: 8ohms

GND LINE    POWER+ LINE    POWER- LINE    ANALOG AUDIO    DIGITAL AUDIO    TMDS SIGNAL    ANALOG VIDEO    STBY POWER

FRONT PART

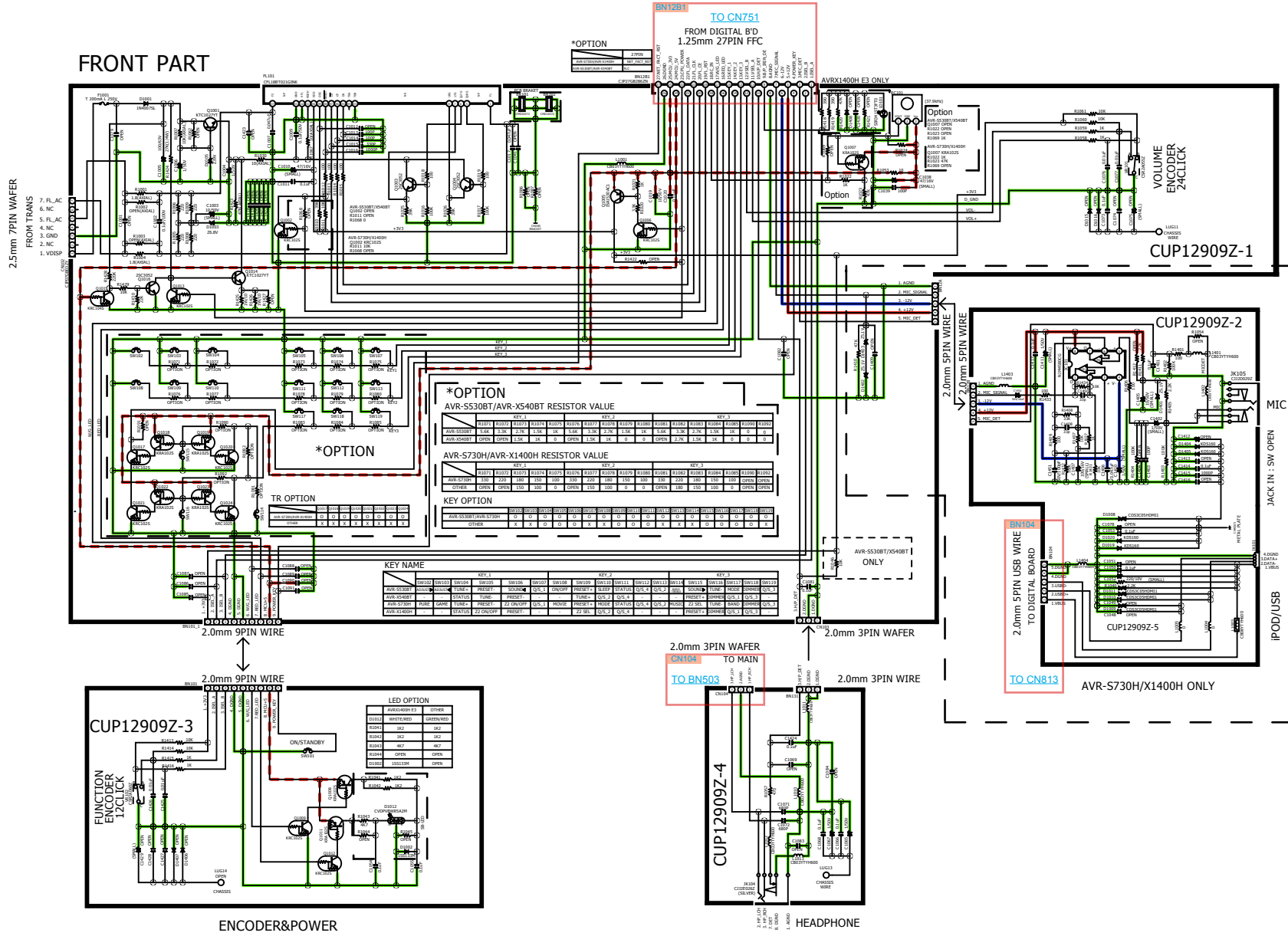

- GND LINE
- POWER+ LINE
- POWER- LINE
- ANALOG AUDIO
- DIGITAL AUDIO
- TMSD SIGNAL
- ANALOG VIDEO
- STBY POWER

### REGULATOR PART

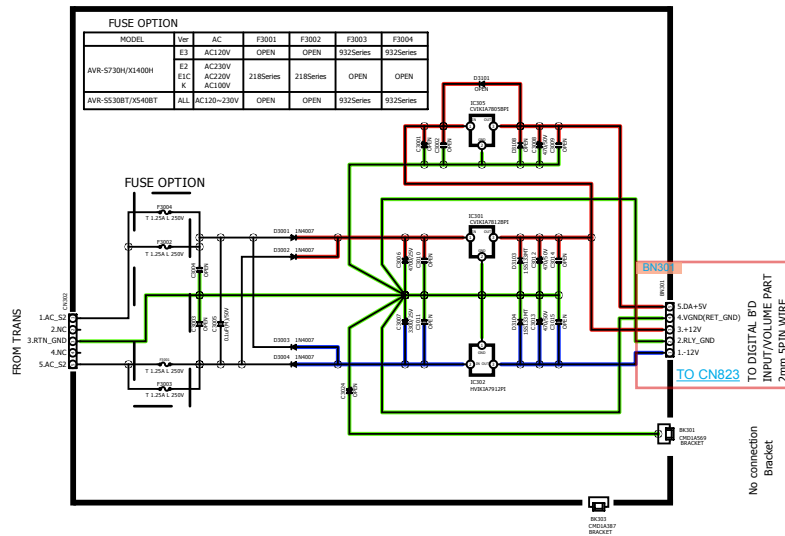

GND LINE    POWER+ LINE    POWER- LINE    ANALOG AUDIO    DIGITAL AUDIO    TMDS SIGNAL    ANALOG VIDEO    STBY POWER



# PRINTED CIRCUIT BOARDS

## DIGITAL, F HDMI, TUNER, PHONE

**Lead-free Solder**  
When soldering, use the Lead-free Solder (Sn-Ag-Cu).

DIGITAL (A SIDE)

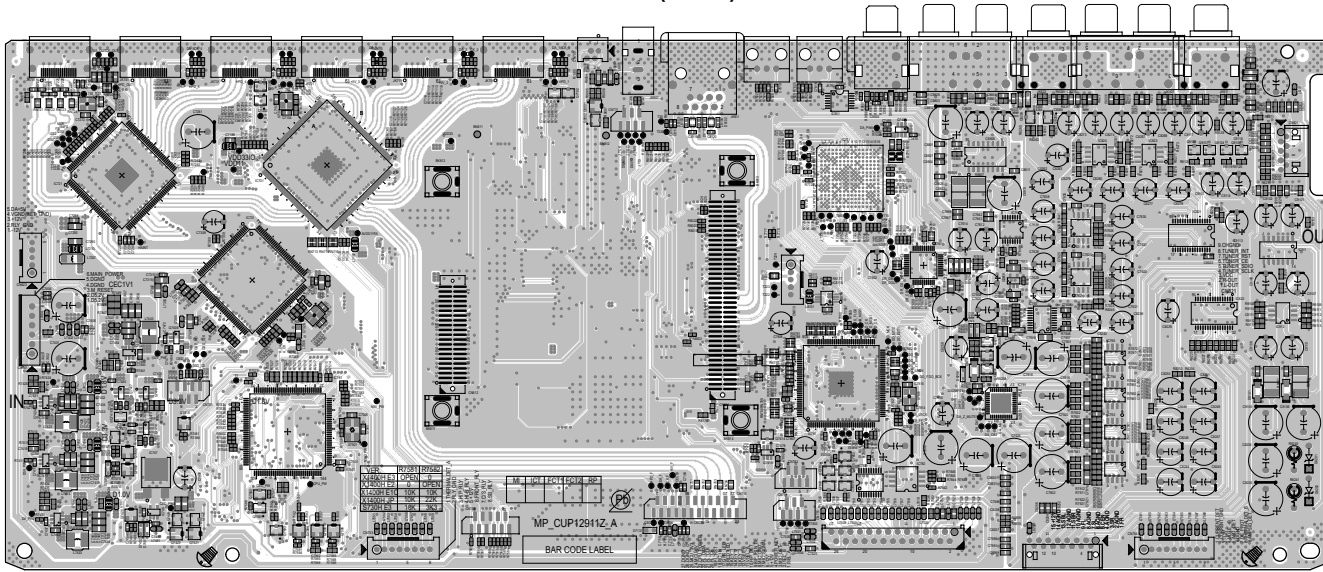

DIGITAL (A SIDE)

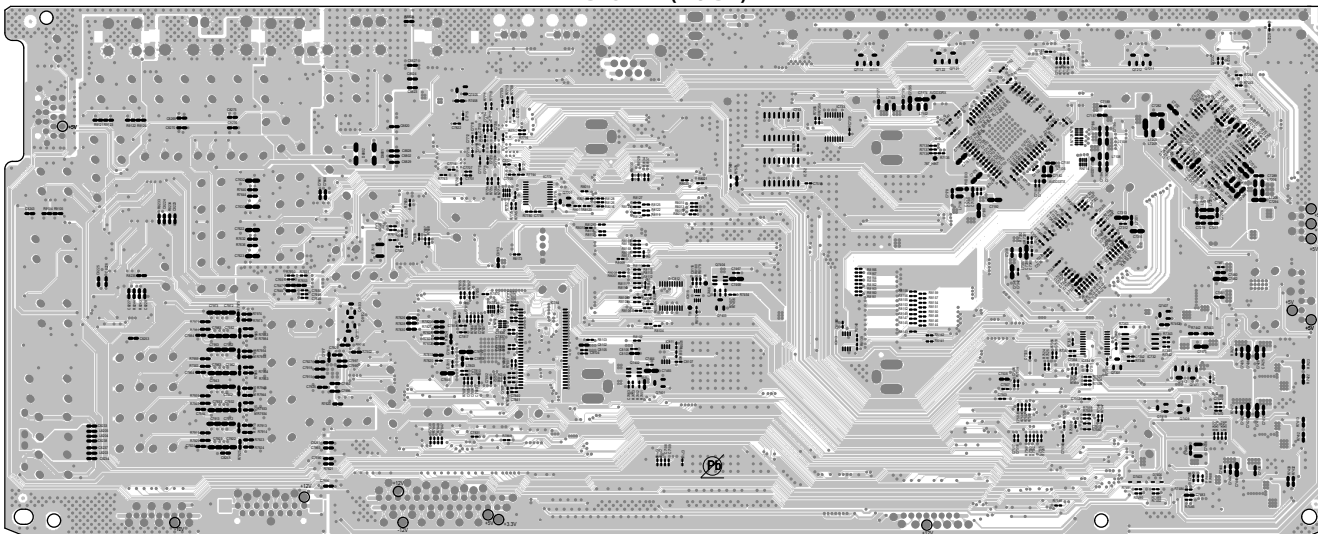

F HDMI (A SIDE)

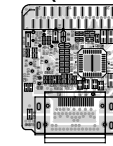

F HDMI (B SIDE)

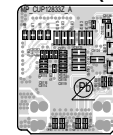

TUNER (A SIDE)

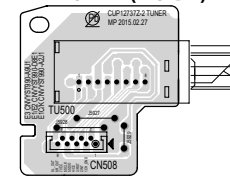

TUNER (B SIDE)

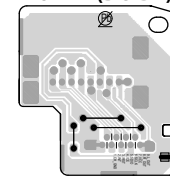

PHONE (A SIDE)

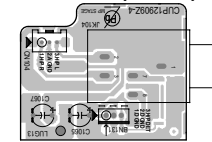

PHONE (B SIDE)

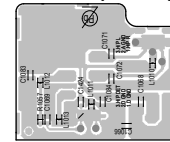

Caution in servicing

Electrical

Mechanical

Repair Information

Updating

DIFF-AMP (A SIDE)

DIFF-AMP (B SIDE)

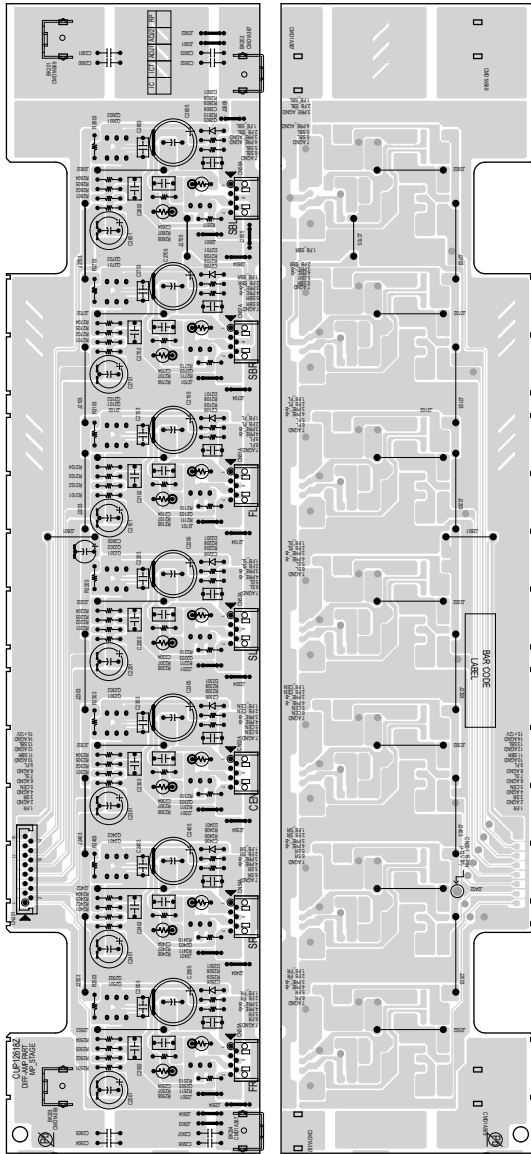

BIAS-TR (A SIDE) BIAS-TR (B SIDE) PHONE WIRE GUIDE (A SIDE)

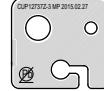

FRONT CABLE GUIDE (A SIDE)

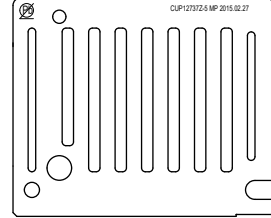

HDMI CABLE GUIDE (A SIDE)

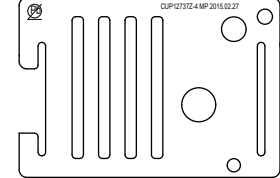

REGULATOR (A SIDE)

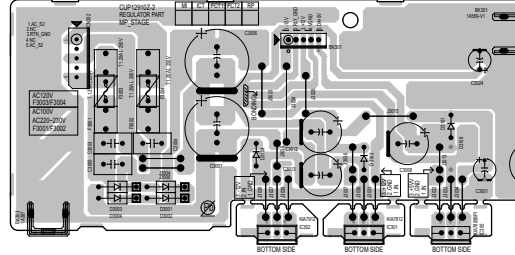

REGULATOR (B SIDE)

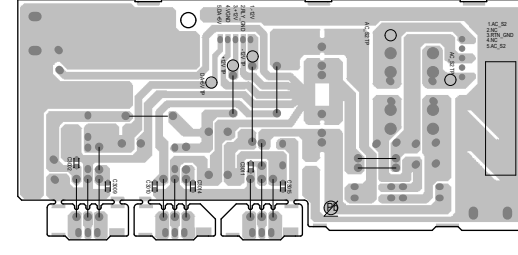



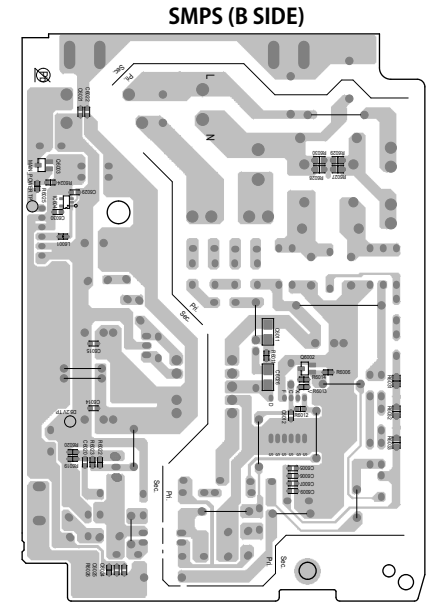
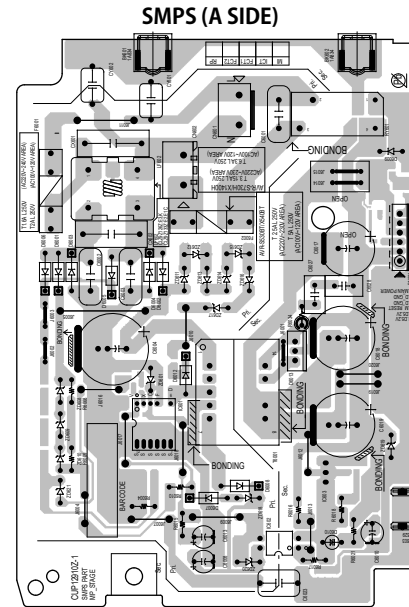
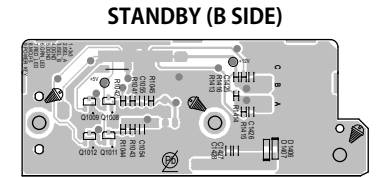
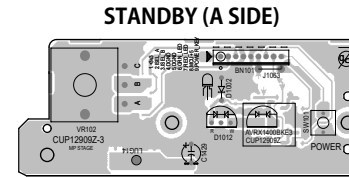
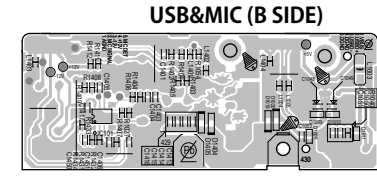
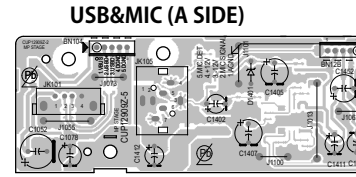
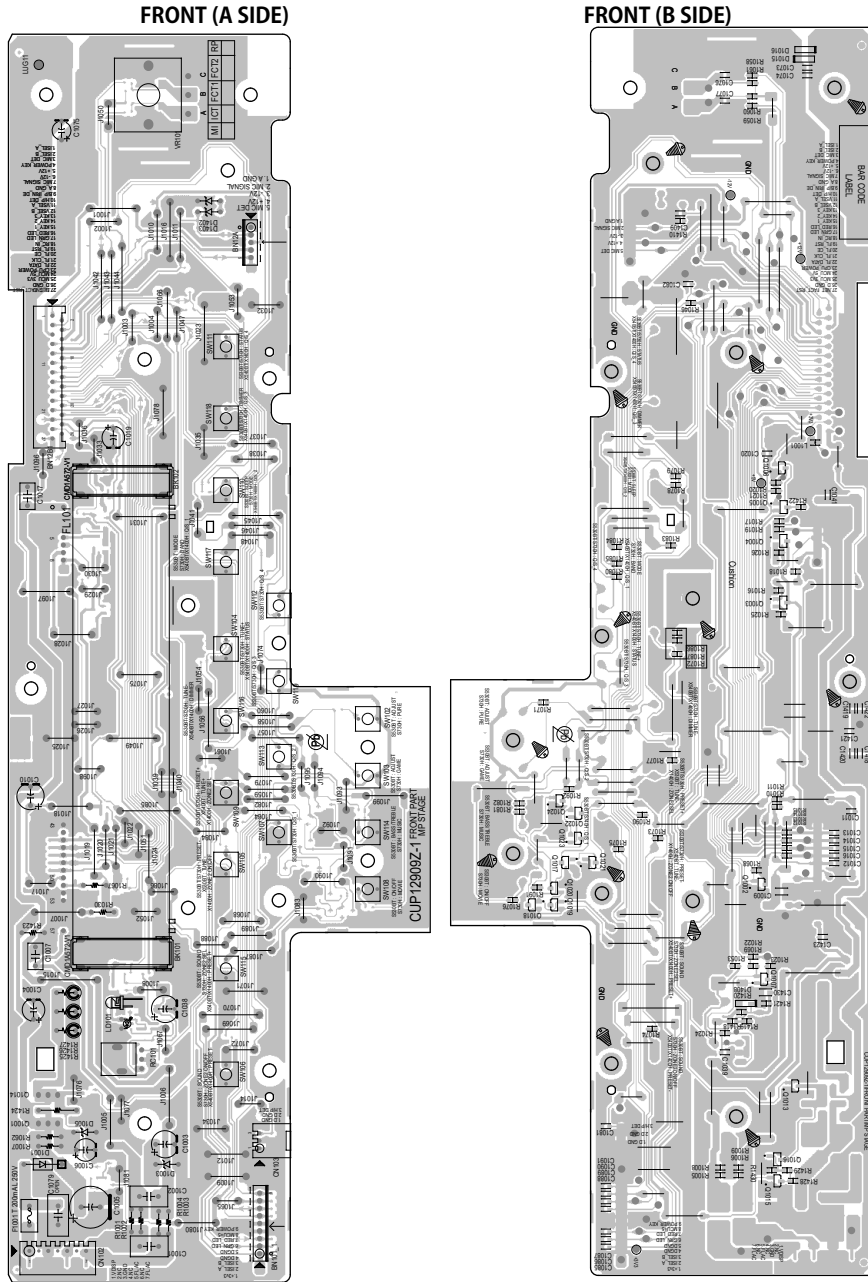

### AVRS730H/X1400H LEVEL DIAGRAM

#### FRONT CHANNEL

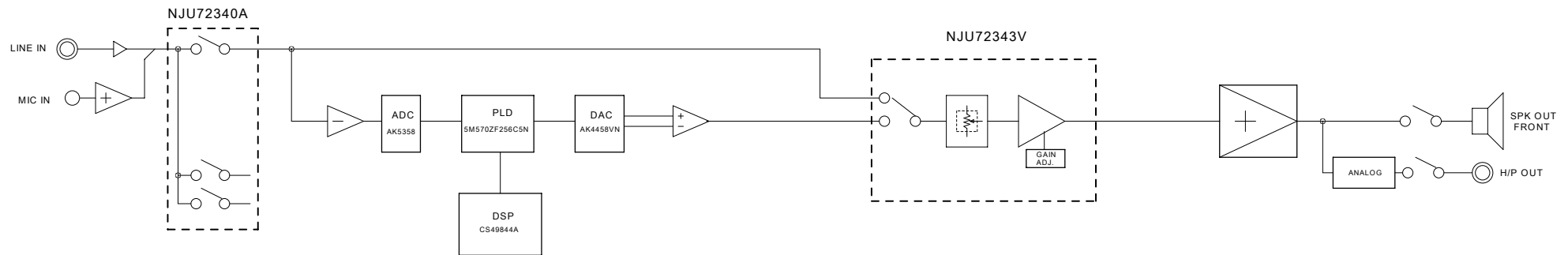

VOLUME IC : NJU72343 NON CLIP MAX SIGNAL LEVEL 4.2Vrms

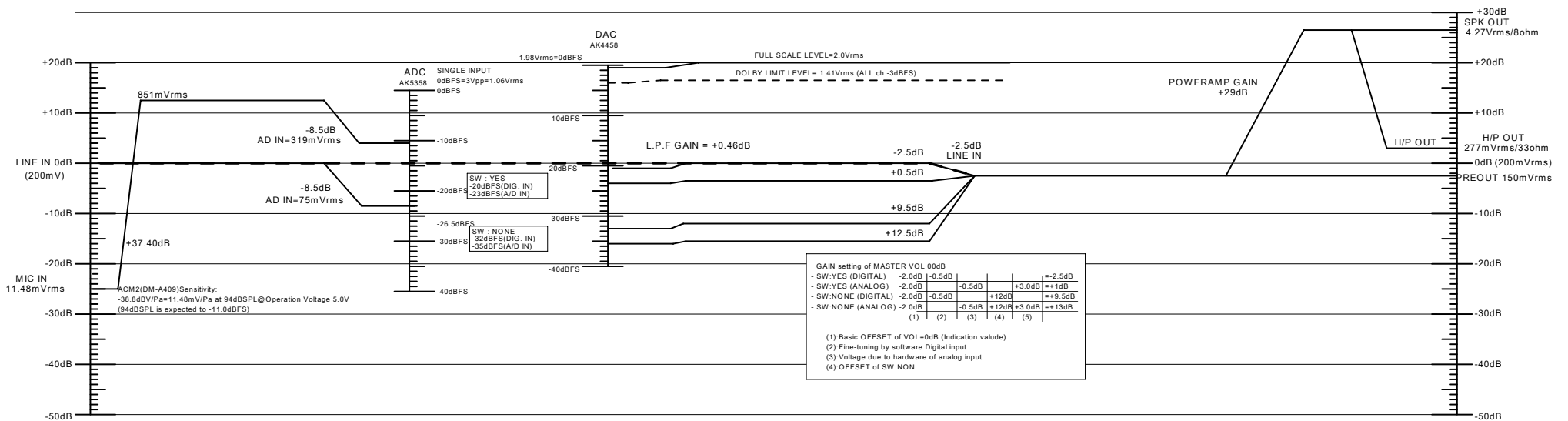

AVRS730H/X1400H LEVEL DIAGRAM

CENTER/SURROUND CHANNEL

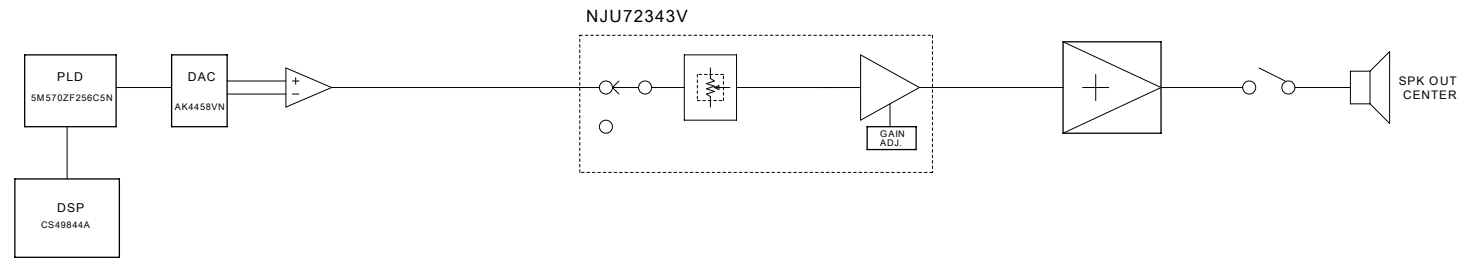

VOLUME IC : NJU72343 NON CLIP MAX SIGNAL LEVEL 4.2Vrms

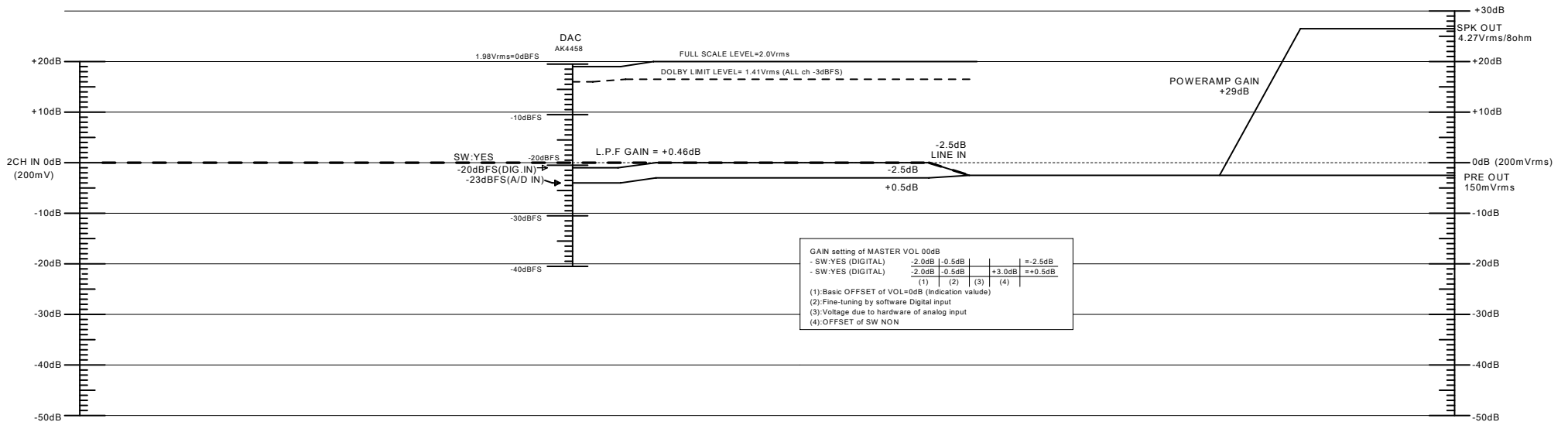

AVRS730H/X1400H LEVEL DIAGRAM

**SURROUND BACK CHANNEL**

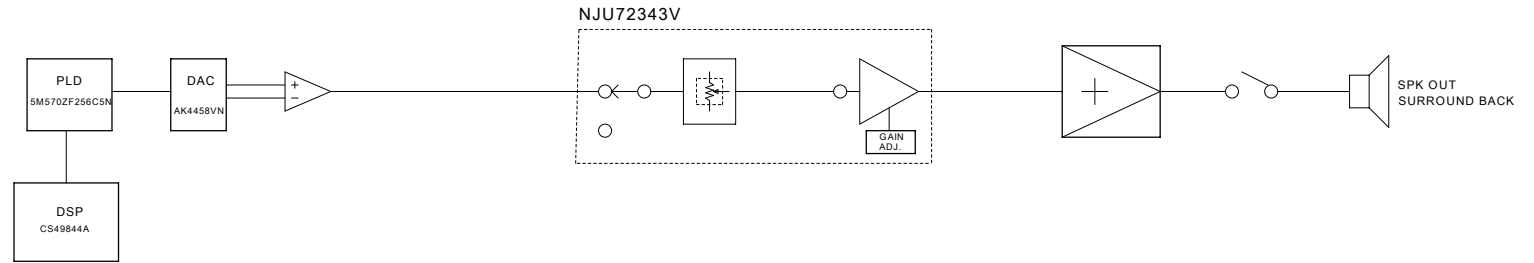

VOLUME IC : NJU72343 NON CLIP MAX SIGNAL LEVEL 4.2Vrms

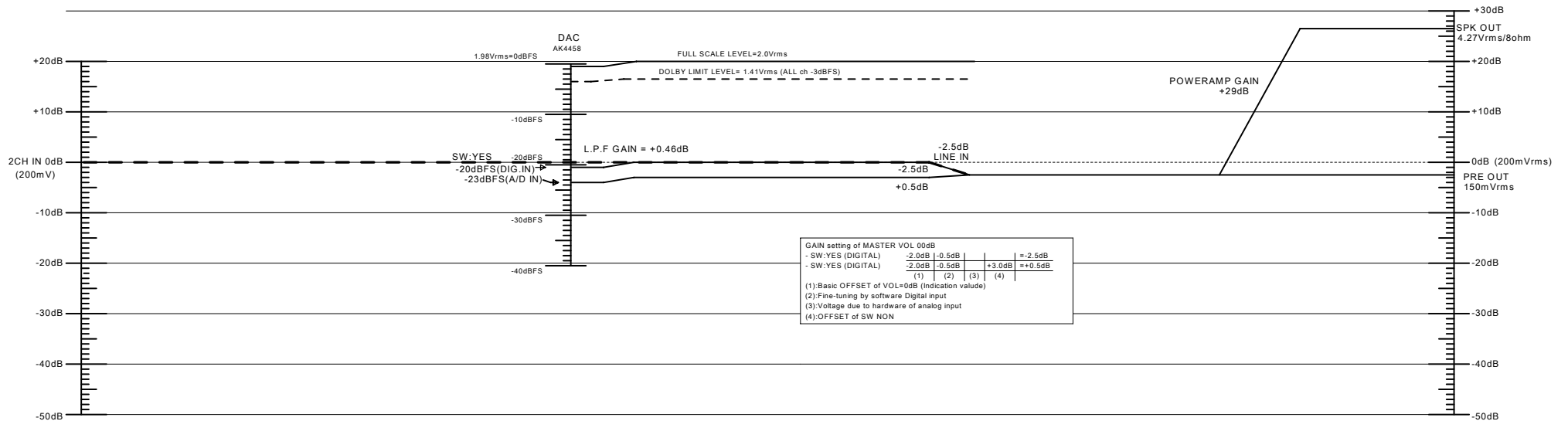

AVRS730H/X1400H LEVEL DIAGRAM

**SUBWOOFER CHANNEL**

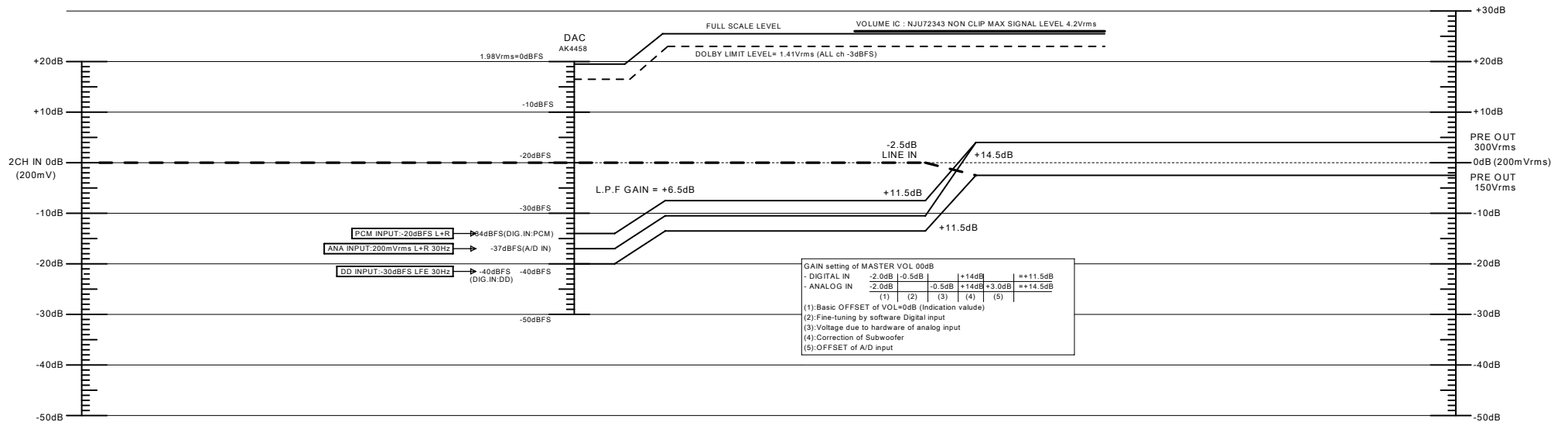
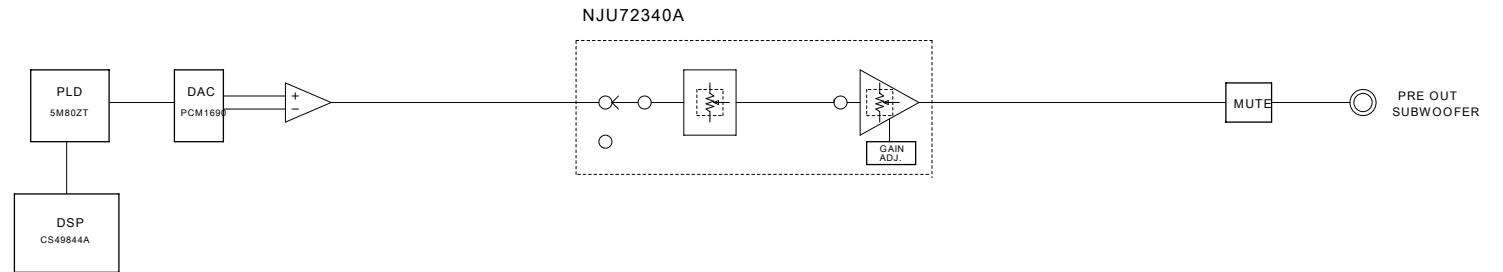

# AVRS730H/X1400H LEVEL DIAGRAM

## ZONE2

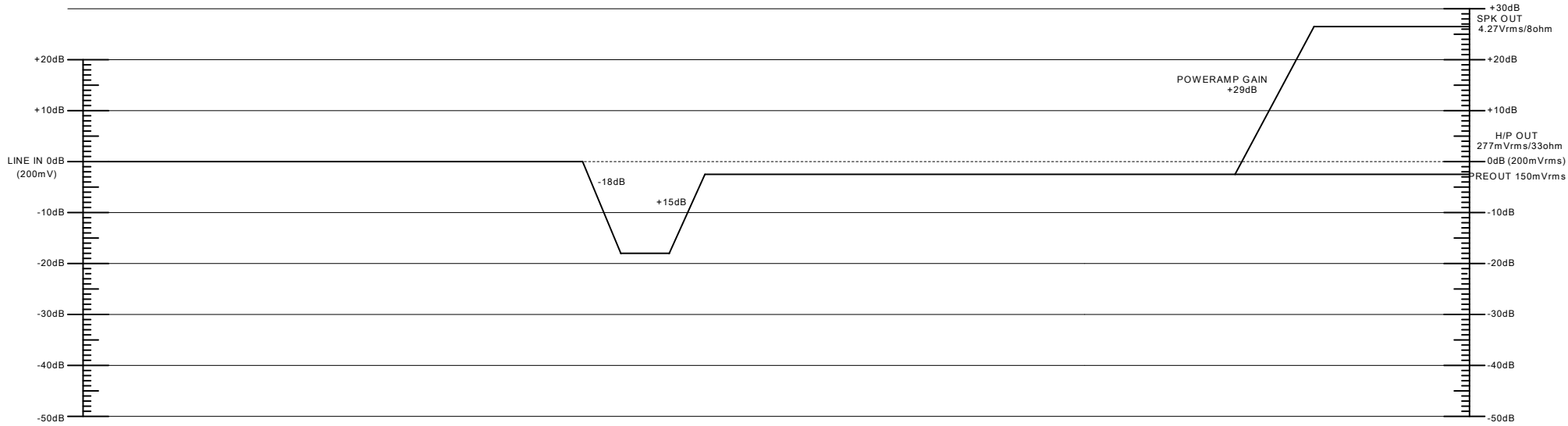
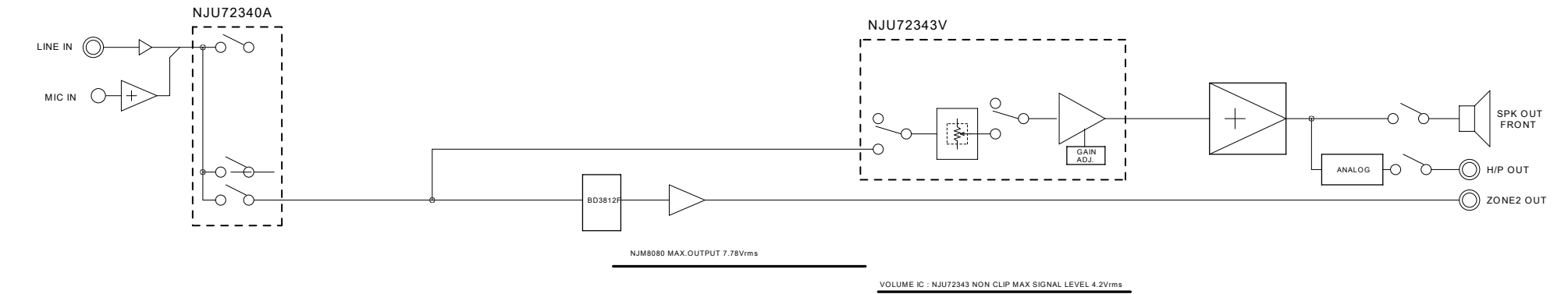

### AVRS730H/X1400H ANALOG AUDIO BLOCK

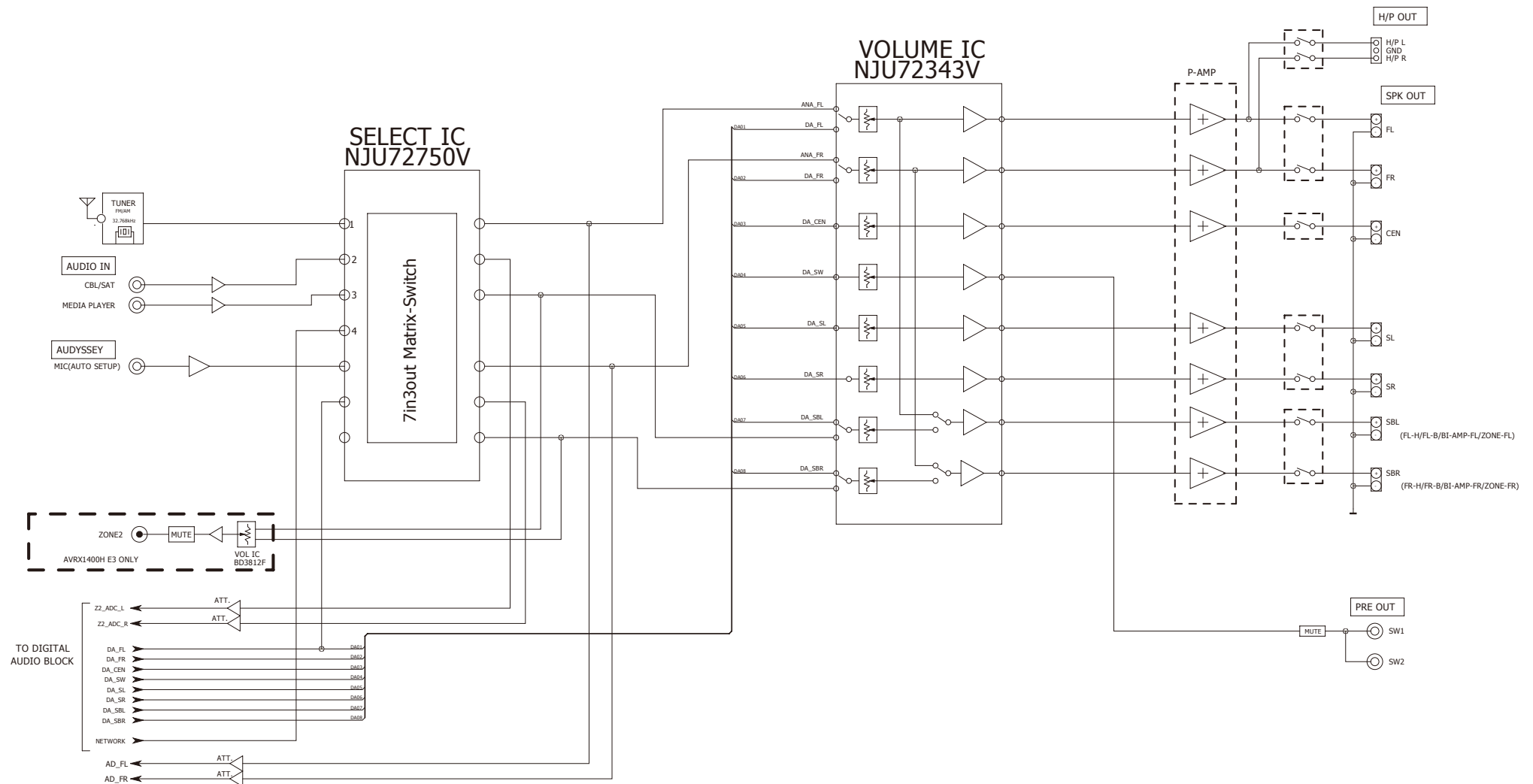



# AVRS730H/X1400H VIDEO BLOCK

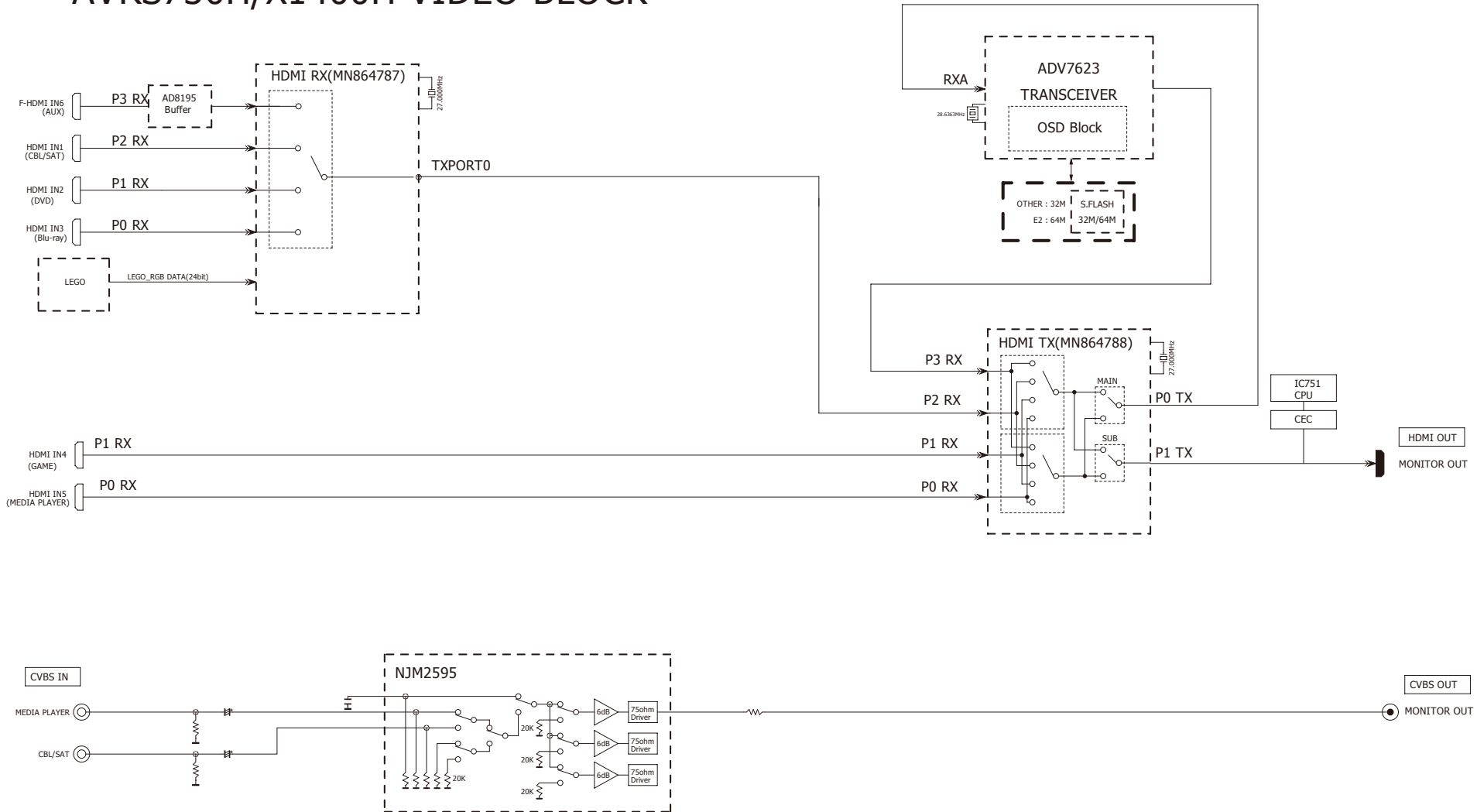

Caution in servicing

Electrical

Mechanical

Repair Information

Updating

## AVRS730H/X1400H VCC DIAGRAM

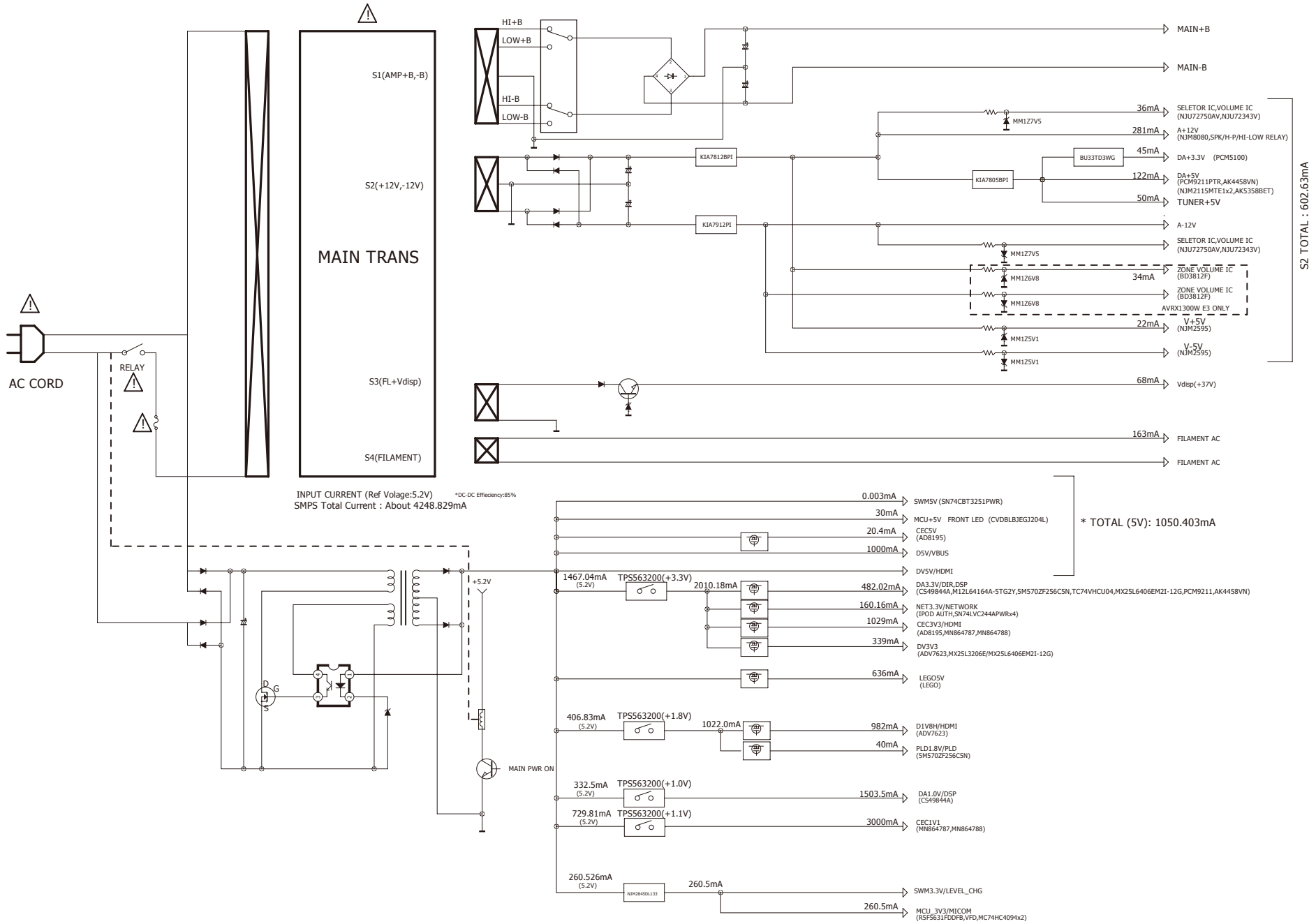

## AVRS730H/X1400H WIRING DIAGRAM

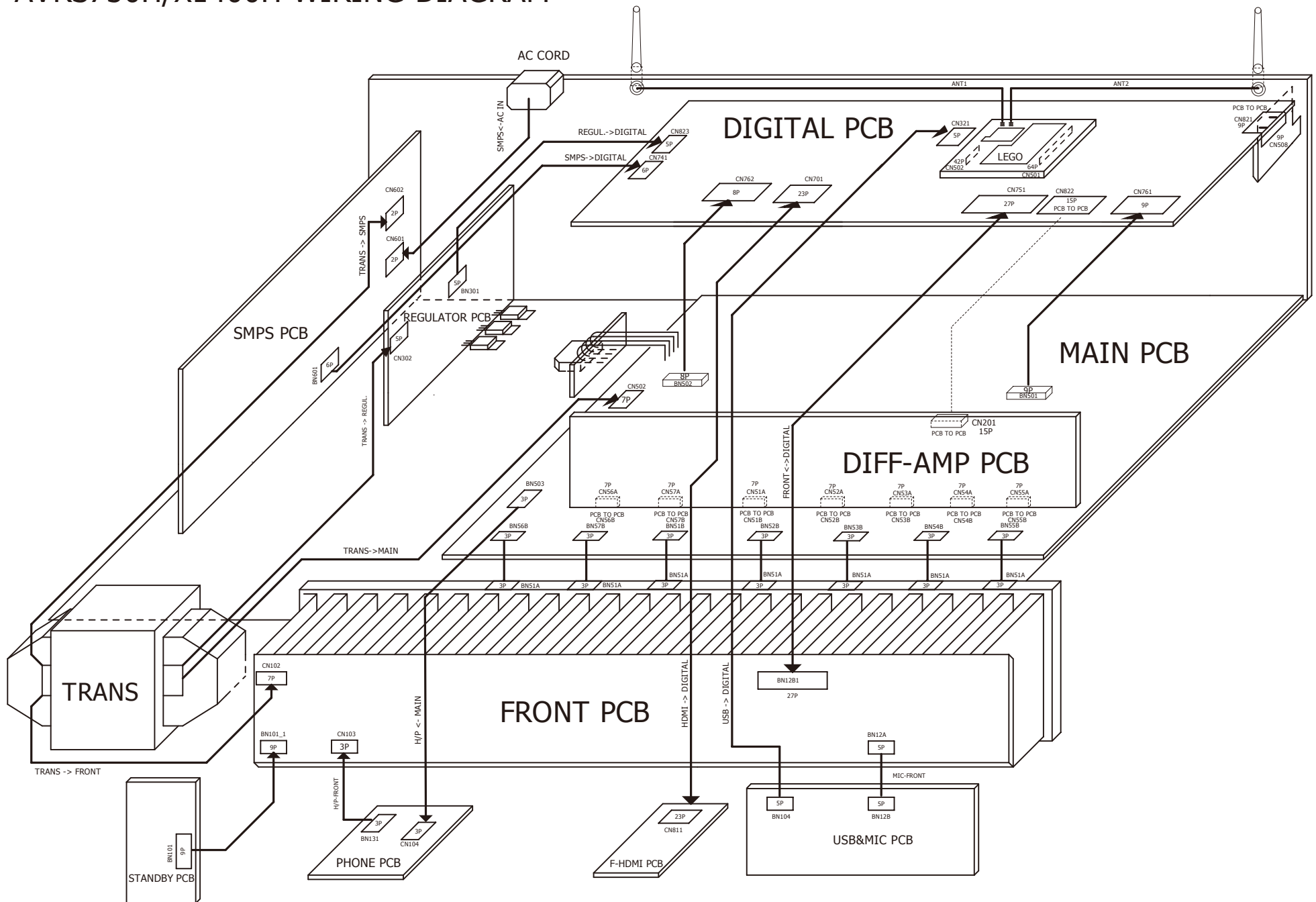

Caution in servicing

Electrical

Mechanical

Repair Information

Updating

Only major semiconductors are shown, general semiconductors etc. are omitted to list.  
The semiconductor which described a detailed drawing in a schematic diagram are omitted to list.

## 1. IC's

### ADV7623 (DIGITAL\_OSD : IC731)

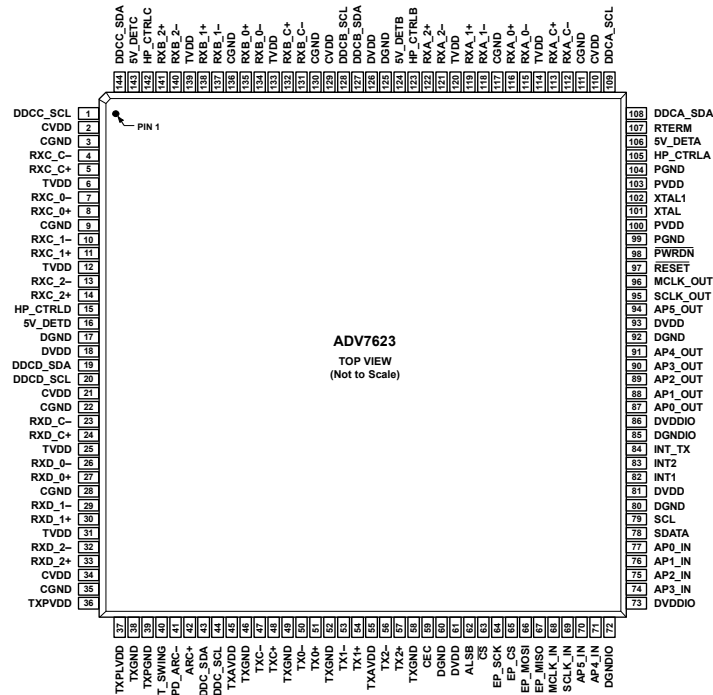

**ADV7623**  
TOP VIEW  
(Not to Scale)

#### Pin Function Descriptions

Pin No.	Mnemonic	Type	Description
1	DDCC_SCL	Digital input	HDCP Slave Serial Clock Port C. DDCC_SCL is a 3.3 V input that is 5 V tolerant.
2	CVDD	Power	Receiver Comparator Supply Voltage (1.8 V).
3	CGND	Ground	TVDD and CVDD Ground.
4	RXC_C-	HDMI input	Digital Input Clock Complement of Port C in the HDMI Interface.
5	RXC_C+	HDMI input	Digital Input Clock True of Port C in the HDMI Interface.
6	TVDD	Power	Receiver Terminator Supply Voltage (3.3 V).
7	RXC_0-	HDMI input	Digital Input Channel 0 Complement of Port C in the HDMI Interface.
8	RXC_0+	HDMI input	Digital Input Channel 0 True of Port C in the HDMI Interface.
9	CGND	Ground	TVDD and CVDD Ground.
10	RXC_1-	HDMI input	Digital Input Channel 1 Complement of Port C in the HDMI Interface.
11	RXC_1+	HDMI input	Digital Input Channel 1 True of Port C in the HDMI Interface.
12	TVDD	Power	Receiver Terminator Supply Voltage (3.3 V).

Pin No.	Mnemonic	Type	Description
13	RXC_2-	HDMI input	Digital Input Channel 2 Complement of Port C in the HDMI Interface.
14	RXC_2+	HDMI input	Digital Input Channel 2 True of Port C in the HDMI Interface.
15	HP_CTRLD	Digital output	Hot Plug Detect for Port D.
16	5V_DET	Digital input	5 V Detect Pin for Port D in the HDMI Interface.
17	DGND	Ground	DVDD Ground.
18	DVDD	Power	Digital Supply Voltage (1.8 V).
19	DDCC_SDA	Digital I/O	HDCP Slave Serial Data Port D. DDCC_SDA is a 3.3 V input/output that is 5 V tolerant.
20	DDCC_SCL	Digital input	HDCP Slave Serial Clock Port D. DDCC_SCL is a 3.3 V input that is 5 V tolerant.
21	CVDD	Power	Receiver Comparator Supply Voltage (1.8 V).
22	CGND	Ground	TVDD and CVDD Ground.
23	RXD_C-	HDMI input	Digital Input Clock Complement of Port D in the HDMI Interface.
24	RXD_C+	HDMI input	Digital Input Clock True of Port D in the HDMI Interface.
25	TVDD	Power	Receiver Terminator Supply Voltage (3.3 V).
26	RXD_0-	HDMI input	Digital Input Channel 0 Complement of Port D in the HDMI Interface.
27	RXD_0+	HDMI input	Digital Input Channel 0 True of Port D in the HDMI Interface.
28	CGND	Ground	TVDD and CVDD Ground.
29	RXD_1-	HDMI input	Digital Input Channel 1 Complement of Port D in the HDMI Interface.
30	RXD_1+	HDMI input	Digital Input Channel 1 True of Port D in the HDMI Interface.
31	TVDD	Power	Receiver Terminator Supply Voltage (3.3 V).
32	RXD_2-	HDMI input	Digital Input Channel 2 Complement of Port D in the HDMI Interface.
33	RXD_2+	HDMI input	Digital Input Channel 2 True of Port D in the HDMI Interface.
34	CVDD	Power	Receiver Comparator Supply Voltage (1.8 V).
35	CGND	Ground	TVDD and CVDD Ground.
36	TXPVDD	Power	1.8 V Power Supply for Digital and I/O Power Supply. This pin supplies power to the digital logic and I/Os. It should be filtered and as quiet as possible.
37	TXPLVDD	Power	1.8 V Power Supply.
38	TXGND	Ground	TXPVDD Ground.
39	TXPGND	Ground	TXPLVDD Ground.
40	EXT_SWING	Analog input	This pin sets the internal reference currents. Place an 887 Ω resistor (1% tolerance) between this pin and ground.
41	HPD_ARC-	Analog input	Hot Plug Detect Signal. This pin indicates to the interface whether the receiver is connected. It supports 1.8 V to 5 V CMOS logic levels.
42	ARC+	Analog input	Audio Return Channel Input (5 V Tolerant).
43	TXDCC_SDA	Digital I/O	Serial Port Data I/O to Receiver. This pin serves as the master to the DDC bus. It supports a 5 V CMOS logic level.
44	TXDCC_SCL	Digital output	Serial Port Data Clock to Receiver. This pin serves as the master clock for the DDC bus. It supports a 5 V CMOS logic level.
45	TXAVDD	Power	1.8 V Power Supply for TMDS Outputs.
46	TXGND	Ground	TXAVDD Ground.
47	TXC-	HDMI output	Differential Clock Output. Differential clock output at the TMDS clock rate; supports TMDS logic level.
48	TXC+	HDMI output	Differential Clock Output. Differential clock output at the TMDS clock rate; supports TMDS logic level.
49	TXGND	Ground	TXAVDD Ground.
50	TX0-	HDMI output	Differential Output Channel 0 Complement. Differential output of the red data at 10x the pixel clock rate; supports TMDS logic level.
51	TX0+	HDMI output	Differential Output Channel 0 True. Differential output of the red data at 10x the pixel clock rate; supports TMDS logic level.
52	TXGND	Ground	TXAVDD Ground.
53	TX1-	HDMI output	Differential Output Channel 1 Complement. Differential output of the red data at 10x the pixel clock rate; supports TMDS logic level.
54	TX1+	HDMI output	Differential Output Channel 1 True. Differential output of the red data at 10x the pixel clock rate; supports TMDS logic level.
55	TXAVDD	Power	1.8 V Power Supply for TMDS Outputs.

Pin No.	Mnemonic	Type	Description
13	RXC_2-	HDMI input	Digital Input Channel 2 Complement of Port C in the HDMI Interface.
14	RXC_2+	HDMI input	Digital Input Channel 2 True of Port C in the HDMI Interface.
15	HP_CTRLD	Digital output	Hot Plug Detect for Port D.
16	5V_DETD	Digital input	5 V Detect Pin for Port D in the HDMI Interface.
17	DGND	Ground	DVDD Ground.
18	DVDD	Power	Digital Supply Voltage (1.8 V).
19	DDCC_SDA	Digital I/O	HDCP Slave Serial Data Port D. DDCC_SDA is a 3.3 V input/output that is 5 V tolerant.
20	DDCC_SCL	Digital input	HDCP Slave Serial Clock Port D. DDCC_SCL is a 3.3 V input that is 5 V tolerant.
21	CVDD	Power	Receiver Comparator Supply Voltage (1.8 V).
22	CGND	Ground	TVDD and CVDD Ground.
23	RXD_C-	HDMI input	Digital Input Clock Complement of Port D in the HDMI Interface.
24	RXD_C+	HDMI input	Digital Input Clock True of Port D in the HDMI Interface.
25	TVDD	Power	Receiver Terminator Supply Voltage (3.3 V).
26	RXD_0-	HDMI input	Digital Input Channel 0 Complement of Port D in the HDMI Interface.
27	RXD_0+	HDMI input	Digital Input Channel 0 True of Port D in the HDMI Interface.
28	CGND	Ground	TVDD and CVDD Ground.
29	RXD_1-	HDMI input	Digital Input Channel 1 Complement of Port D in the HDMI Interface.
30	RXD_1+	HDMI input	Digital Input Channel 1 True of Port D in the HDMI Interface.
31	TVDD	Power	Receiver Terminator Supply Voltage (3.3 V).
32	RXD_2-	HDMI input	Digital Input Channel 2 Complement of Port D in the HDMI Interface.
33	RXD_2+	HDMI input	Digital Input Channel 2 True of Port D in the HDMI Interface.
34	CVDD	Power	Receiver Comparator Supply Voltage (1.8 V).
35	CGND	Ground	TVDD and CVDD Ground.
36	TXPVDD	Power	1.8 V Power Supply for Digital and I/O Power Supply. This pin supplies power to the digital logic and I/Os. It should be filtered and as quiet as possible.
37	TXPLVDD	Power	1.8 V Power Supply.
38	TXGND	Ground	TXPVDD Ground.
39	TXPGND	Ground	TXPLVDD Ground.
40	EXT_SWING	Analog input	This pin sets the internal reference currents. Place an 887 $\Omega$ resistor (1% tolerance) between this pin and ground.
41	HPD_ARC-	Analog input	Hot Plug Detect Signal. This pin indicates to the interface whether the receiver is connected. It supports 1.8 V to 5 V CMOS logic levels.
42	ARC+	Analog input	Audio Return Channel Input (5 V Tolerant).
43	TXDCC_SDA	Digital I/O	Serial Port Data I/O to Receiver. This pin serves as the master to the DDC bus. It supports a 5 V CMOS logic level.
44	TXDCC_SCL	Digital output	Serial Port Data Clock to Receiver. This pin serves as the master clock for the DDC bus. It supports a 5 V CMOS logic level.
45	TXAVDD	Power	1.8 V Power Supply for TMDS Outputs.
46	TXGND	Ground	TXAVDD Ground.
47	TXC-	HDMI output	Differential Clock Output. Differential clock output at the TMDS clock rate; supports TMDS logic level.
48	TXC+	HDMI output	Differential Clock Output. Differential clock output at the TMDS clock rate; supports TMDS logic level.
49	TXGND	Ground	TXAVDD Ground.
50	TX0-	HDMI output	Differential Output Channel 0 Complement. Differential output of the red data at 10x the pixel clock rate; supports TMDS logic level.
51	TX0+	HDMI output	Differential Output Channel 0 True. Differential output of the red data at 10x the pixel clock rate; supports TMDS logic level.
52	TXGND	Ground	TXAVDD Ground.
53	TX1-	HDMI output	Differential Output Channel 1 Complement. Differential output of the red data at 10x the pixel clock rate; supports TMDS logic level.
54	TX1+	HDMI output	Differential Output Channel 1 True. Differential output of the red data at 10x the pixel clock rate; supports TMDS logic level.
55	TXAVDD	Power	1.8 V Power Supply for TMDS Outputs.

Pin No.	Mnemonic	Type	Description
99	PGND	Ground	PVDD Ground.
100	PVDD	Power	PLL Supply Voltage (1.8 V).
101	XTAL	Miscellaneous analog	Input pin for 28.63636 MHz crystal or an external 1.8 V 28.63636 MHz clock oscillator source to clock the ADV7623.
102	XTAL1	Miscellaneous analog	Crystal Output Pin. This pin should be left floating if a clock oscillator is used.
103	PVDD	Power	PLL Supply Voltage (1.8 V).
104	PGND	Ground	PVDD Ground.
105	HP_CTRLA	Digital output	Hot Plug Detect for Port A.
106	5V_DETA	Digital input	5 V Detect Pin for Port A in the HDMI Interface.
107	RTERM	Miscellaneous analog	This pin sets the internal termination resistance. A 500 $\Omega$ resistor between this pin and ground should be used.
108	DDCA_SDA	Digital I/O	HDCP Slave Serial Data Port A. DDCA_SDA is a 3.3 V input/output that is 5 V tolerant.
109	DDCA_SCL	Digital input	HDCP Slave Serial Clock Port A. DDCA_SCL is a 3.3 V input that is 5 V tolerant.
110	CVDD	Power	Receiver Comparator Supply Voltage (1.8 V).
111	CGND	Ground	TVDD and CVDD Ground.
112	RXA_C-	HDMI input	Digital Input Clock Complement of Port A in the HDMI Interface.
113	RXA_C+	HDMI input	Digital Input Clock True of Port A in the HDMI Interface.
114	TVDD	Power	Receiver Terminator Supply Voltage (3.3 V).
115	RXA_0-	HDMI input	Digital Input Channel 0 Complement of Port A in the HDMI Interface.
116	RXA_0+	HDMI input	Digital Input Channel 0 True of Port A in the HDMI Interface.
117	CGND	Ground	TVDD and CVDD Ground.
118	RXA_1-	HDMI input	Digital Input Channel 1 Complement of Port A in the HDMI Interface.
119	RXA_1+	HDMI input	Digital Input Channel 1 True of Port A in the HDMI Interface.
120	TVDD	Power	Receiver Terminator Supply Voltage (3.3 V).
121	RXA_2-	HDMI input	Digital Input Channel 2 Complement of Port A in the HDMI Interface.
122	RXA_2+	HDMI input	Digital Input Channel 2 True of Port A in the HDMI Interface.
123	HP_CTRLB	Digital output	Hot Plug Detect for Port B.
124	5V_DETB	Digital input	5 V Detect Pin for Port B in the HDMI Interface.
125	DGND	Ground	DVDD Ground.
126	DVDD	Power	Digital Supply Voltage (1.8 V).
127	DDCB_SDA	Digital I/O	HDCP Slave Serial Data Port B. DDCB_SDA is a 3.3 V input/output that is 5 V tolerant.
128	DDCB_SCL	Digital input	HDCP Slave Serial Clock Port B. DDCB_SCL is a 3.3 V input that is 5 V tolerant.
129	CVDD	Power	Receiver Comparator Supply Voltage (1.8 V).
130	CGND	Ground	TVDD and CVDD Ground.
131	RXB_C-	HDMI input	Digital Input Clock Complement of Port B in the HDMI Interface.
132	RXB_C+	HDMI input	Digital Input Clock True of Port B in the HDMI Interface.
133	TVDD	Power	Receiver Terminator Supply Voltage (3.3 V).
134	RXB_0-	HDMI input	Digital Input Channel 0 Complement of Port B in the HDMI Interface.
135	RXB_0+	HDMI input	Digital Input Channel 0 True of Port B in the HDMI Interface.
136	CGND	Ground	TVDD and CVDD Ground.
137	RXB_1-	HDMI input	Digital Input Channel 1 Complement of Port B in the HDMI Interface.
138	RXB_1+	HDMI input	Digital Input Channel 1 True of Port B in the HDMI Interface.
139	TVDD	Power	Receiver Terminator Supply Voltage (3.3 V).
140	RXB_2-	HDMI input	Digital Input Channel 2 Complement of Port B in the HDMI Interface.
141	RXB_2+	HDMI input	Digital Input Channel 2 True of Port B in the HDMI Interface.
142	HP_CTRLC	Digital output	Hot Plug Detect for Port C.
143	5V_DETC	Digital input	5 V Detect Pin for Port C in the HDMI Interface.
144	DDCC_SDA	Digital I/O	HDCP Slave Serial Data Port C. DDCC_SDA is a 3.3 V input/output that is 5 V tolerant.

ADV7623 Block diagram

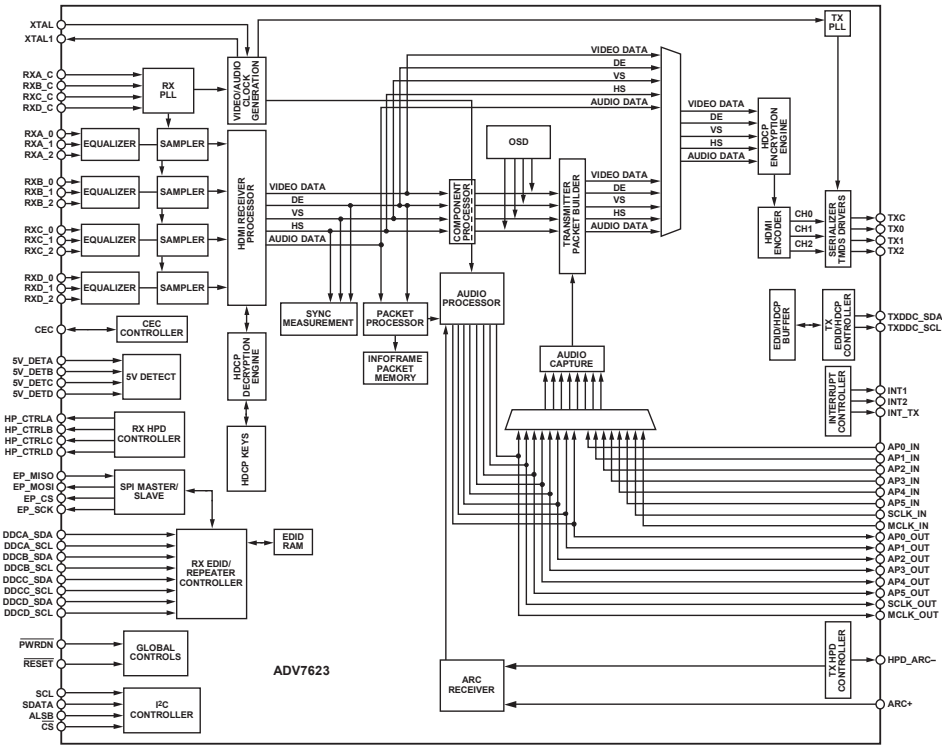

## DIGITAL\_OSD : IC732

MX25L3206EM2I-12G (except : E2)  
 MX25L6406EM2I-12G (ONLY E2)

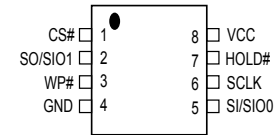

### PIN DESCRIPTION

SYMBOL	DESCRIPTION
CS#	Chip Select
SI/SIO0	Serial Data Input (for 1 x I/O)/ Serial Data Input & Output (for Dual Output mode)
SO/SIO1	Serial Data Output (for 1 x I/O)/ Serial Data Output (for Dual Output mode)
SCLK	Clock Input
WP#	Write protection
HOLD#	Hold, to pause the device without deselecting the device
VCC	+ 3.3V Power Supply
GND	Ground

## SN74CBT3251PWR (DIGITAL\_OSD : IC733)

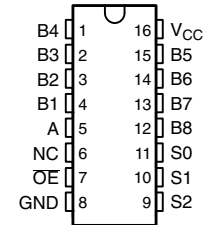

Block diagram

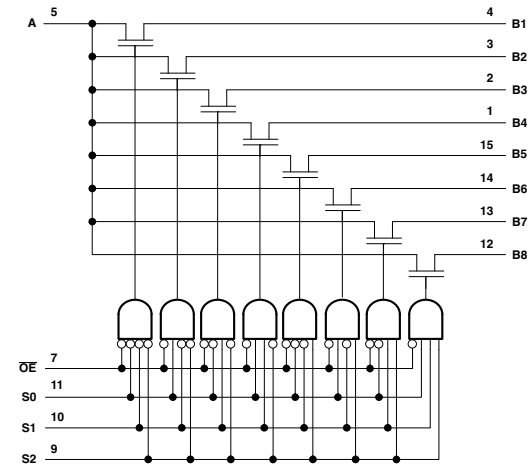

# TPS563200 (DIGITAL\_DIGITAL SUPPLY : IC741, IC742, IC743, IC744)

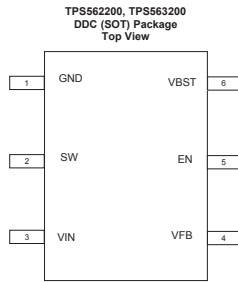

## Terminal Functions

PIN		DESCRIPTION
NAME	NUMBER	
GND	1	Ground pin Source terminal of low-side power NFET as well as the ground terminal for controller circuit. Connect sensitive VFB to this GND at a single point.
SW	2	Switch node connection between high-side NFET and low-side NFET.
VIN	3	Input voltage supply pin. The drain terminal of high-side power NFET.
VFB	4	Converter feedback input. Connect to output voltage with feedback resistor divider.
EN	5	Enable input control. Active high and must be pulled up to enable the device.
VBST	6	Supply input for the high-side NFET gate drive circuit. Connect a 0.1 $\mu$ F capacitor between VBST and SW pins.

## Block diagram

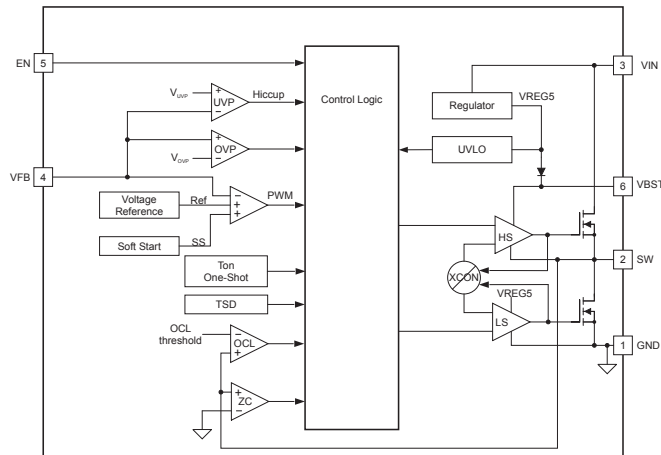

# R5F5631FDDFB(DIGITAL\_MCU : IC751)

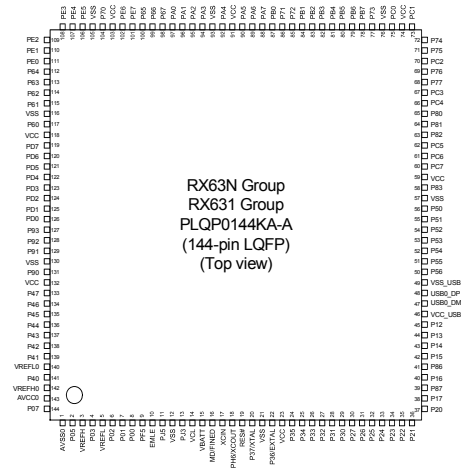

## R5F56108VNFP Terminal Functions

Pin	Pin Name	Symbol	I/O	Pu/Pd	STBY	STOP	CEC STBY	Function
1	AVSS0	AVSS	-		-	-	-	Ground pin
2	P05/IRQ13	POWER_KEY	I	M3VPu	I	I	I	Detect Power switch (Release from Wait Mode, Set to interrupt)
3	VREFH	VREFH	-		-	-	-	Reference power supply pin
4	P03/IRQ11	RED_LED	O		L/H	L	H	POWER/STANDBY LED control pin
5	VREFL	VREL	-		-	-	-	Ground pin
6	P02/SCK6/IRQ10/AN020	SB_RL	O		L	L	L	Speaker relay control pin
7	P01/RXD6/IRQ9/AN019	RXD_MI2320	I	M3VPu	I	I	I	External data input port (for AMX/FW update via 232C) :Connector is FFC
8	P00/TXD6/IRQ8/AN018	TXD_MO232I	O		L	L	L	External data output port (for AMX/FW update via 232C) :Connector is FFC
9	PF5/IRQ4	WHITE_LED(X1400(NA)/GREEN_LED(X1400(AP/CH)/S730)	O		L	L	L	POWER LED control pin
10	EMLE	EMLE	I	Pd	-	-	-	E20 Emulator control pin (On chip Emulator is used, this pin should be High. Not used, it should be Low)
11	PJ5	VSEL_A	I	SW3VPu	I	I	I	Master volume (Rotary encoder) signal input pin
12	VSS	VSS	-		-	-	-	Ground pin
13	PJ3	VSEL_B	I	SW3VPu	I	I	I	Master volume (Rotary encoder) signal input pin
14	VCL	VCL	I		-	-	-	Smoothing capacitor connection pin
15	VBATT	VBATT	-		-	-	-	Power supply pin
16	MD/FINED	MD	I	M3VPu	I	I	I	Pins for setting the operating mode (select the Boot Mode or User Boot Mode, Single Chip Mode)
17	XCIN	XCIN	I	Pd	-	-	-	NC (Pull down)
18	XCOUT	XCOUT	I		-	-	-	NC (open)
19	RES#	RESET	I		-	-	-	Reset signal input pin
20	XTAL/P37	XTAL	I		-	-	-	Pins for a crystal resonator (Xin=10MHz $\times$ 10)
21	VSS	VSS	-		-	-	-	Ground pin
22	EXTAL/P36	EXTAL	I		-	-	-	Pins for a crystal resonator (Xin=10MHz $\times$ 10)
23	VCC	VCC	-		-	-	-	Power supply pin.
24	P35(IN)/NMI	DSP_FLAG0	I	DA3VPu	L	L	L	DSP (CS49844A) interrupt signal input pin

Caution in servicing

Electrical

Mechanical

Repair Information

Updating

Pin	Pin Name	Symbol	I/O	Pu/Pd	STBY	STOP	CEC STBY	Function
25	TRST#/P34/SCK6/SCK0//IRQ4	TRST#/NC(NORMRAL)	I/I	Pd	I/I	I/I	I/I	E20 Emulator control pin/When normal operating mode,set to input.
26	P33/TIOCD0/RXD6/RXD0/IRQ3-DS	RC_IN	I	Pd	I	I	I	Remote input
27	P32/TXD6/TXD0/IRQ2-DS	BDOWN	I	M3VPu	I	I	I	Detect power down
28	TMS/P31/IRQ1-DS	TMS/NC(NORMRAL)	I/I	M3VPu	-/I	-/I	I	E20 Emulator control pin/When normal operating mode,set to input.
29	TDI/P30/RXD1//IRQ0-DS	TDI/RXD_MITSUBISHI	I/O/I	M3VPu	-/-/I	-/-/I	I	E20 Emulator control pin/Mitsubishi writer control pin/When normal operating mode,set to input.
30	TCK/FINEC/P27/SCK1/	TCK/NC(NORMRAL)	I/I/I	M3VPu	-/-/I	-/-/I	I	E20 Emulator control pin//When normal operating mode,set to input.
31	TDO/P26/TXD1	TDO/TXD_MITSUBISHI	O/O/I	M3VPu	-/-/I	-/-/I	I	E20 Emulator control pin/Mitsubishi writer control pin/When normal operating mode,set to input.
32	P25/RXD3	TU_RST	O		L	L	L	TUNER control
33	P24/SCK3	MVOL_MUTE	O		L	L	L	Volume control pin (NJU72343)
34	P23/TXD3	E_RTS_MOEI	O	Pd (BCM58305 Internal Pd)	L	L	L	Ethernet(LEGO) control pin
35	P22/SCK0	E_CTS_MIEO	I	Pd (onboard + BCM58305 Internal Pd)	I	I	I	Ethernet(LEGO) control pin
36	P21/RXD0/IRQ9	E_RXD_MIEO	I	Pd (onboard + BCM58305 Internal Pd)	I	L	I	Ethernet(LEGO) control pin
37	P20/TXD0/IRQ8	E_TXD_MOEI	O	Pd (BCM58305 Internal Pd)	L	L	L	Ethernet(LEGO) control pin
38	P17/SCK1/TXD3/IRQ7	NET_FACT_RST	O(ODR)	Pu (BCM58305 Internal Pu)	Z	Z	Z	Ethernet(LEGO) control pin
39	P87	7623_ROM_HOLD	O		L	L	L	Flash ROM for GUI control pin
40	P16/TXD1/RXD3/IRQ6	NET5V_POWER	O		L	L	L	Ethernet power supply (Net5V) control pin/
41	P86	PRE_Z2_MUTE(X1400(NA)/NC(X1400(AP/CH)/S730)	O		L	L	L	Mute for zone preout control pin
42	P15/RXD1/SCK3/IRQ5	VEXP_STB	O		L	L	L	Expander (MC74HC4094) control pin
43	P14/IRQ4	VEXP_OE	O		L	L	L	Expander (MC74HC4094) control pin
44	P13/TXD2/IRQ3	VEXP_CLK	O		L	L	L	Expander (MC74HC4094) control pin
45	P12/RXD2/IRQ2	VEXP_DATA	O		L	L	L	Expander (MC74HC4094) control pin
46	VCC_USB	VCC_USB	-		-	-	-	Power supply pin
47	USB0_DM	USB0_DM	-		-	-	-	NC(open)
48	USB0_DP	USB0_DP	-		-	-	-	NC(open)
49	VSS_USB	VSS_USB	-		-	-	-	Ground pin
50	P56	TU_SEN	O		L	L	L	TUNER control pin
51	P55/IRQ10	TU_SDIO	I_O		L	L	L	TUNER control
52	P54	TU_SCLK	O		L	L	L	TUNER control
53	BCLK/P53	DSP_BSY	I	DA3VPu	I	I	I	DSP BUSY signal input
54	P52/RXD2	ADV7623_SPI_MI	I		L	L	L	HDMI transceiver w/ GUI(ADV7623) control pin (for GUI)
55	P51/SCK2	ADV7623_SPI_CLK	O		L	L	L	HDMI transceiver w/ GUI(ADV7623) control pin (for GUI)
56	P50/TXD2	ADV7623_SPI_MO	O		L	L	L	HDMI transceiver w/ GUI(ADV7623) control pin (for GUI)
57	VSS	VSS	-		-	-	-	Ground pin

Pin	Pin Name	Symbol	I/O	Pu/Pd	STBY	STOP	CEC STBY	Function
58	P83	ADV7623_RST	O	Pd	L	L	L	HDMI transceiver w/ GUI(ADV7623) reset control pin
59	VCC	VCC	-		-	-	-	Power supply pin.
60	PC7/TXD8/IRQ14	UB	I	Pd	-	-	-	Pins for setting the boot mode(select the Boot Mode or User Boot Mode)
61	PC6/RXD8/IRQ13	HSCL_(400k)	O	CEC3VPu	L	L	L	HDMI transceiver w/ GUI(ADV7623) control pin (for HDMI)
62	PC5/SCK8	HSDA_(400k)	I_O	CEC3VPu	L	L	L	HDMI transceiver w/ GUI(ADV7623) control pin (for HDMI)
63	P82/TXD10	DSP_MOSI	O	DA3VPu	L	L	L	DSP(CS49844A) control pin
64	P81/RXD10	DSP_MISO	I	DA3VPu	L	L	L	DSP(CS49844A) control pin
65	P80/SCK10	DSP_CLK	O	DA3VPu	L	L	L	DSP(CS49844A) control pin
66	PC4/SCK5	DSP_CS	O	DA3VPu	L	L	L	DSP(CS49844A) control pin
67	PC3/TXD5	NC	O		L	L	L	NC
68	P77/TXD11	DSP_RST	O	Pd	L	L	L	DSP(CS49844A) reset control pin
69	P76/RXD11	SEL_DATA	O		L	L	L	Audio selector control pin for NJU72750
70	PC2/RXD5	DA_POWER	O		L	L	L	Digital audio power supply (DA3.3V,DA1.2V) control pin
71	P75/SCK11	CEC_POWER2	O		L	L	H	CEC standby power control (for CEC Standby Mode 3)
72	P74	ADV7623_SPI_CS	O		L	L	L	HDMI transceiver w/ GUI(ADV7623) control pin (for GUI)
73	PC1/SCK5/IRQ12	DAC_PLD_ERR	I	Pd	L	L	L	Detect DAC/PLD error (from Audio PLD and DAC)
74	VCC	VCC	-		-	-	-	Power supply pin.
75	PC0/IRQ14	H/P_RL	O		L	L	L	Headphone relay control pin
76	VSS	VSS	-		-	-	-	Ground pin
77	P73	FRONT_RL	O		L	L	L	Speaker relay control pin
78	PB7/TXD9	PSDA	I/O	CEC3VPu	O/L	L	L	HDMI I2C (MN864788/787) control pin
79	PB6/RXD9	PSCL	I/O	CEC3VPu	O/L	L	L	HDMI I2C (MN864788/787) control pin
80	PB5	SEL_CLK	O		L	L	L	Audio selector control pin for NJU72750
81	PB4	APLD_CS	O/O		L	L	L	Audio PLD (5M570ZF256C5N) control pin
82	PB3/SCK4/SCK6	APLD_DATA/DAC_DATA	O/O		L	L	L	Audio PLD (5M570ZF256C5N) control pin/DAC (AK4458VN) control pin
83	PB2	APLD_CLK/DAC_CLK	O/O		L	L	L	Audio PLD (5M570ZF256C5N) control pin/DAC (AK4458VN) control pin
84	PB1/TXD4/TXD6/IRQ4-DS	DAC_MS	O		L	L	L	DAC (AK4458VN) control pin
85	P72	DAC_RST	O		L	L	L	DAC (AK4458VN) control pin
86	P71	PRE_MUTE	O		L	L	L	MUTE for preout control pin
87	PB0/RXD4/RXD6/IRQ12	DA_POWER2	O		L	L	L	Digital audio power supply (D1.0V) control pin
88	PA7	ISEL_A	I	SW3VPu	I	I	I	Input selector (Rotary encoder) signal input pin
89	PA6	ISEL_B	I	SW3VPu	I	I	I	Input selector (Rotary encoder) signal input pin
90	PA5	C/S_RL	O		L	L	L	Speaker relay control pin
91	VCC	VCC	-		-	-	-	Power supply pin.
92	PA4/TXD5/IRQ5-DS	ZVOL_DATA(X1400(NA)/NC(X1400(AP/CH)/S730)	O		L	L	L	ZONE volume(BD3812) control pin
93	VSS	VSS	-		-	-	-	Ground pin
94	PA3/RXD5/IRQ6-DS	MVOL_DATA	O		L	L	L	Volume control pin (NJU72343)
95	PA2/RXD5	MVOL_CLK	O		L	L	L	Volume control pin (NJU72343)
96	PA1/IRQ11	ZVOL_CLK(X1400(NA)/NC(X1400(AP/CH)/S730)	O		L	L	L	ZONE volume(BD3812) control pin
97	PA0	H5V_DET	I	Pd	I	I	I	HDMI IN 5V detect signal pin
98	P67/IRQ15	FL_CE	O		L	L	L	FL display control pin
99	P66	FL_DATA	O		L	L	L	FL display control pin
100	P65	FL_CLK	O		L	L	L	FL display control pin

Pin	Pin Name	Symbol	I/O	Pu/Pd	STBY	STOP	CEC STBY	Function
101	PE7/IRQ7/AN5	KEY3	I	M3VPu	I	I	I	Key control signal input pin (When standby mode, set to interrupt)
102	PE6/IRQ6/AN4	KEY2	I	M3VPu	I	I	I	Key control signal input pin (When standby mode, set to interrupt)
103	VCC	VCC	-		-	-	-	Power supply pin.
104	P70	Hi_B_RL	O		L	L	L	HIGH-B relay control pin
105	VSS	VSS	-		-	-	-	Ground pin
106	PE5/IRQ5/AN3	KEY1	I	M3VPu	I	I	I	Key control signal input pin (When standby mode, set to interrupt)
107	PE4/AN2	DC_DET/ASO	I	SW3VPu	I	I	I	Protection detect signal input pin (for DC and ASO) (A/D converter)
108	PE3/AN1	AMPSIGDET	I	Pd	I	L	I	Signal level monitor pin (AD converter)
109	PE2/RXD12/IRQ7-DS/AN0	CURRENT_DET	I	Pd	I	L	I	Current level monitor pin (A/D converter)
110	PE1/TXD12	GUL_WRITE	O		L	L	L	GUI flash rom writing control
111	PE0/SCK12	NET3.3V_POWER	O		L	L	L	Ethernet power supply control (Net3.3V)
112	P64	D5V_POWER	O		L	L	H	Digital 5V power supply control pin (3.3V and 1.8V generate from 5V)
113	P63	CEC_POWER	O		L	L	-	CEC standby power supply control (CEC5V, CEC3.3V, CEC1.8V)
114	P62	DV_POWER1	O		L	L	-	Digital video power supply (DV5V, DV3.3V) control pin
115	P61	DIR_DOUT	I	DA3VPu	I	I	I	DIR (PCM9211) control pin
116	VSS	VSS	-		-	-	-	Ground pin
117	P60	DIR_DIN	O		L	L	L	DIR (PCM9211) control pin
118	VCC	VCC	-		-	-	-	Power supply pin.
119	PD7/IRQ7/AN7	H/P_DET/MIC_DET	I	SW3VPu	I	I	I	Headphone insert detect pin/Microphone insert detect pin (A/D converter)
120	PD6/IRQ6/AN6	MODE	I		I	I	I	Region setting pin
121	PD5/IRQ5/AN013	MN864787_RST	O	Pd	L	L	L	HDMI Rx (MN864787) reset control pin
122	PD4/IRQ4/AN012	DIR_RST	O	Pd	L	L	L	DIR (PCM9211) control pin
123	PD3/IRQ3/AN011	MN864788_HINT	I	CEC3VPu	I	I	I	HDMI Tx (MN864788) interrupt signal input pin
124	PD2/IRQ2/AN010	MN864787_HINT	I	CEC3VPu	I	I	I	HDMI Rx (MN864787) interrupt signal det
125	PD1/IRQ1/AN009	TU_GPO2_INT	I		L	L	L	TUNER control pin
126	PDO/TIOCA7/IRQ0/AN008	CEC_IN	I	SW3VPu	I	I	I	CEC-D control pin
127	P93/AN017	THERMAL_A	I	SW3VPu	I	L	I	Protection detect signal input pin
128	P92/RXD7/AN016	THERMAL_B	I	SW3VPu	I	L	I	Protection detect signal input pin
129	P91/SCK7/AN015	DSP_ROM_WRITE	O		L	L	L	DSP ROM writing control (When writing, set to High)
130	VSS	VSS	-		-	-	-	Ground pin
131	P90/TXD7/AN014	MN864788_RST	O	SW3VPu	L	L	L	HDMI Tx (MN864788) reset control pin
132	VCC	VCC	-		-	-	-	Power supply pin.
133	P47/IRQ15-DS/AN007	FL_RST	O		L	L	L	FL display control pin
134	P46/IRQ14-DS/AN006	DIR_CE	O		L	L	L	DIR (PCM9211) control pin
135	P45/IRQ13-DS/AN005	DIR_CLK	O		L	L	L	DIR (PCM9211) control pin
136	P44/IRQ12-DS/AN004	AIOS4_STBY_STATUS	I	Pd	I	I	I	Not used (This port use to detect for LEGO standby status in the future (Low : normal, High : Deep Standby))
137	P43/IRQ11-DS/AN003	AIOS4_WAKEUP	O		L	L	L	same as NET5V_POWER, NET3.3V_POWER (This port use to control for LEGO standby mode in the future (Low : Deep Standby, High : normal))
138	P42/IRQ10-DS/AN002	CPU_POWER	O		L	L	L	CPU power supply control pin
139	P41/IRQ9-DS/AN001	MAIN_POWER	O		L	L	L	Power supply control pin
140	VREFL0	VREFL0	-		-	-	-	Ground pin

Pin	Pin Name	Symbol	I/O	Pu/Pd	STBY	STOP	CEC STBY	Function
141	P40/IRQ8-DS/AN000	MN864788_HAINT	I	CEC3VPu	I	I	I	HDMI Tx (MN864788) interrupt signal input pin (for Audio)
142	VREFH0	VREFH0	-		-	-	-	Power supply pin
143	AVCC0	AVCC0	-		-	-	-	Power supply pin
144	P07/IRQ15	CEC_OUT	O		L	L	-	CEC-D control pin

Caution in servicing

Electrical

Mechanical

Repair Information

Updating

**MC74HC4094ADR2G (DIGITAL\_MCU : IC752, IC753)**

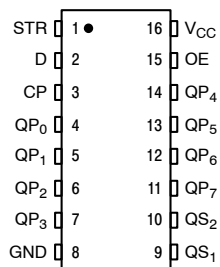

Logic Diagram

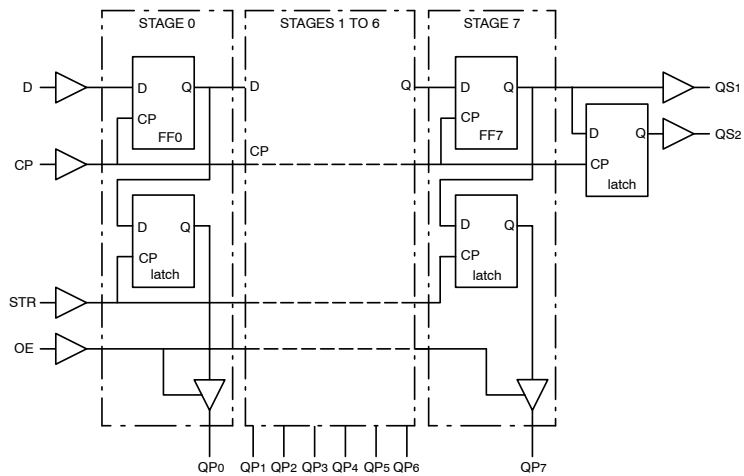

**SN74LVC244APWR (DIGITAL\_OSD : IC734)  
(DIGITAL\_PLD : IC772)  
(DIGITAL\_DSP : IC783)  
(DIGITAL\_LEGO : IC812)**

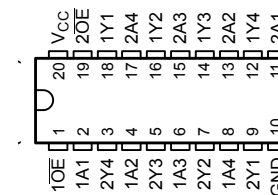

Block diagram

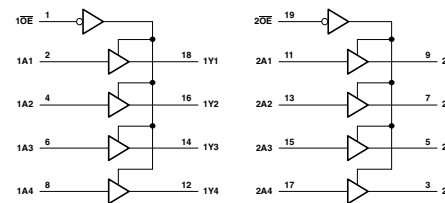

Caution in servicing

Electrical

Mechanical

Repair Information

Updating

# PCM9211PTR (DIGITAL\_DIR : IC761)

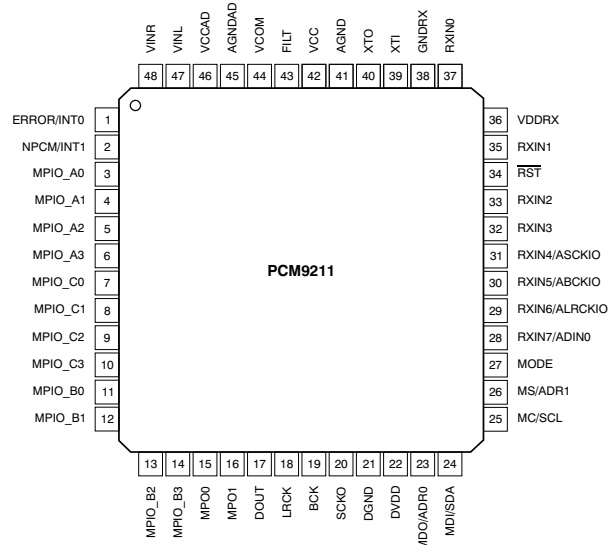

## PIN Functions

PIN				DESCRIPTION
NO.	NAME	I/O	5-V TOLERANT	
1	ERROR/INT0	O	No	DIR Error detection output / Interrupt0 output
2	NPCM/INT1	O	No	DIR Non-PCM detection output / Interrupt1 output
3	MPIO_A0	I/O	Yes	Multipurpose I/O, Group A(1)
4	MPIO_A1	I/O	Yes	Multipurpose I/O, Group A(1)
5	MPIO_A2	I/O	Yes	Multipurpose I/O, Group A(1)
6	MPIO_A3	I/O	Yes	Multipurpose I/O, Group A(1)
7	MPIO_C0	I/O	Yes	Multipurpose I/O, Group C(1)
8	MPIO_C1	I/O	Yes	Multipurpose I/O, Group C(1)
9	MPIO_C2	I/O	Yes	Multipurpose I/O, Group C(1)
10	MPIO_C3	I/O	Yes	Multipurpose I/O, Group C(1)
11	MPIO_B0	I/O	Yes	Multipurpose I/O, Group B(1)
12	MPIO_B1	I/O	Yes	Multipurpose I/O, Group B(1)
13	MPIO_B2	I/O	Yes	Multipurpose I/O, Group B(1)
14	MPIO_B3	I/O	Yes	Multipurpose I/O, Group B(1)
15	MPO0	O	No	Multipurpose output 0
16	MPO1	O	No	Multipurpose output 1
17	DOUT	O	No	Main output port, serial digital audio data output
18	LRCK	O	No	Main output port, LR clock output
19	BCK	O	No	Main output port, Bit clock output
20	SCKO	O	No	Main output port, System clock output
21	DGND	-	-	Ground, for digital

PIN				DESCRIPTION
NO.	NAME	I/O	5-V TOLERANT	
22	DVDD	-	-	Power supply, 3.3 V (typ.), for digital
23	MDO/ADR0	I/O	Yes	Software control I/F, SPI data output / I2C slave address setting0(2)
24	MDI/SDA	I/O	Yes	Software control I/F, SPI data input / I2C data input/output(2) (3)
25	MC/SCL	I	Yes	Software control I/F, SPI clock input / I2C clock input(2)
26	MS/ADR1	I	Yes	Software control I/F, SPI chip select / I2C slave address setting1(2)
27	MODE	I	No	Control mode setting. (see the Serial Control Mode section, Control Mode Pin Setting)
28	RXIN7/ADIN0	I	Yes	Biphase signal, input 7 / AUXIN0, serial audio data input(2)
29	RXIN6/ALRCKIO	I	Yes	Biphase signal, input 6 / AUXIN0, LR clock input(2)
30	RXIN5/ABCKIO	I	Yes	Biphase signal, input 5 / AUXIN0, bit clock input(2)
31	RXIN4/ASCKIO	I	Yes	Biphase signal, input 4 / AUXIN0, system clock input(2)
32	RXIN3	I	Yes	Biphase signal, input 3(2)
33	RXIN2	I	Yes	Biphase signal, input 2(2)
34	RST	I	Yes	Reset Input, active low(2) (4)
35	RXIN1	I	Yes	Biphase signal, input 1, built-in coaxial amplifier
36	VDDRX	-	-	Power supply, 3.3 V (typ.), for RXIN0 and RXIN1.
37	RXIN0	I	Yes	Biphase signal, input 0, built-in coaxial amplifier
38	GNDRX	-	-	Ground, for RXIN
39	XTI	I	No	Oscillation circuit input for crystal resonator or external XTI clock source input(5)
40	XTO	O	No	Oscillation circuit output for crystal resonator
41	AGND	-	-	Ground, for PLL analog
42	VCC	-	-	Power supply, 3.3 V (typ.), for PLL analog
43	FILT	O	No	External PLL loop filter connection terminal; must connect recommended filter
44	VCOM	O	No	ADC common voltage output; must connect external decoupling capacitor
45	AGNDAD	-	-	Ground, for ADC analog
46	VCCAD	-	-	Power supply, 5.0 V (typ.), for ADC analog
47	VINL	I	No	ADC analog voltage input, left channel
48	VINR	I	No	ADC analog voltage input, right channel

- (1) Schmitt trigger input
- (2) Schmitt trigger input
- (3) Open-drain configuration in I2C mode
- (4) Onboard pull-down resistor (50 k  $\Omega$ , typical)
- (5) CMOS Schmitt trigger input



# MX25L6406EM2I-12G (DIGITAL\_DSP : IC782)

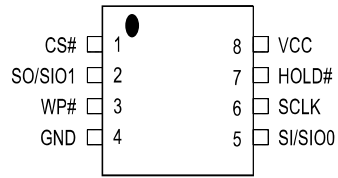

Block diagram

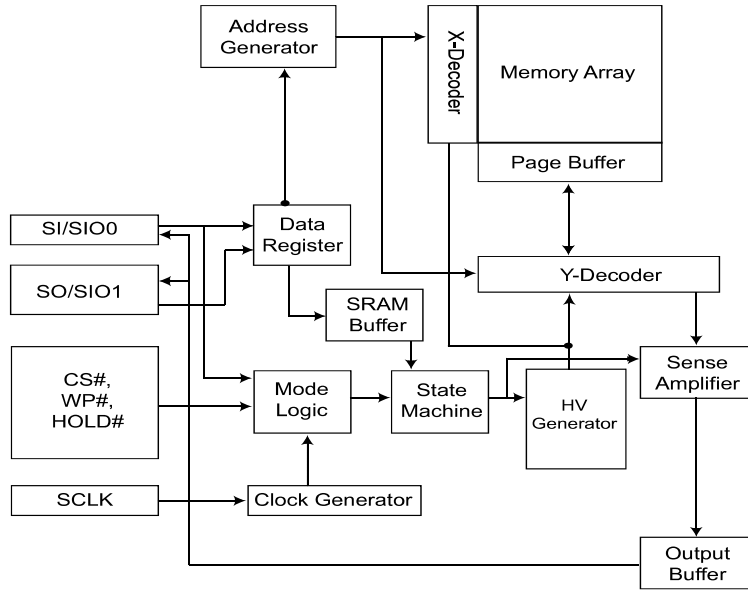

# M12L64164A-5TG2Y (DIGITAL\_DSP : IC784)

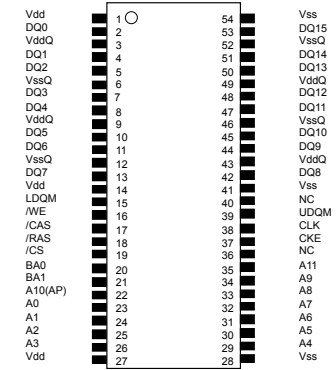

- CLK : Master Clock
- CKE : Clock Enable
- /CS : Chip Select
- /RAS : Row Address Strobe
- /CAS : Column Address Strobe
- /WE : Write Enable
- DQ0-15 : Data I/O
- U,LDQM : Output Disable / Write Mask
- A0-11 : Address Input
- BA0,1 : Bank Address
- Vdd : Power Supply
- VddQ : Power Supply for Output
- Vss : Ground
- VssQ : Ground for Output

Block diagram

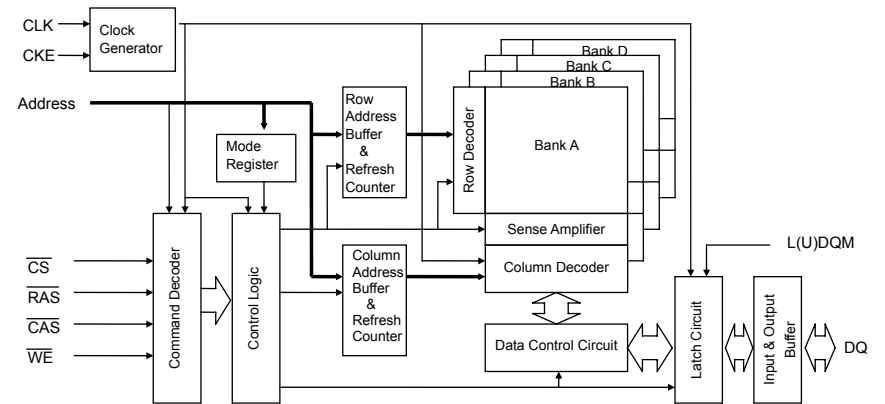

# AK4458VN (DIGITAL\_MAIN DAC : IC791)

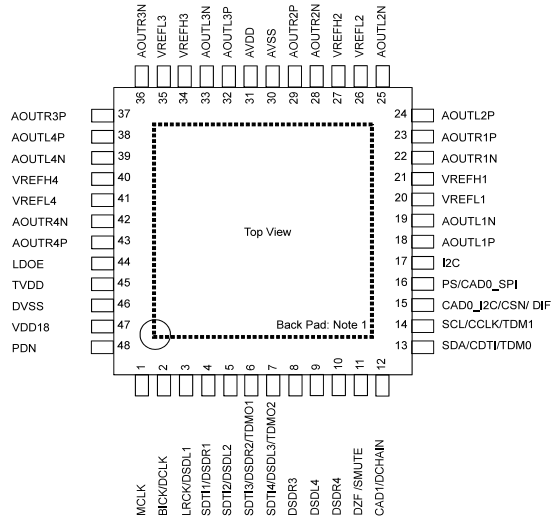

## Pin Function

No.	Pin Name	I/O	Function	PD State
1	MCLK	I	External Master Clock Input Pin	Hi-Z
2	BICK	I	Audio Serial Data Clock Pin in PCM mode	Hi-z
	DCLK	I	DSD Clock Pin in DSD mode	
3	LRCK	I	Input Channel Clock Pin in PCM mode	Hi-Z
	DSDL1	I	Audio Serial Data Input in DSD mode	
4	SDTI1	I	Audio Serial Data Input in PCM mode	Hi-Z
	DSDR1	I	Audio Serial Data Input in DSD mode	
5	SDTI2	I	Audio Serial Data Input in PCM mode	Hi-Z
	DSDL2	I	Audio Serial Data Input in DSD mode	
6	SDTI3	I	Audio Serial Data Input in PCM mode	100k Ω Pull down
	DSDR2	I	Audio Serial Data Input in DSD mode	
	TDMO1	O	Audio Serial Data Output in Daisy Chain mode	
7	SDTI4	I	Audio Serial Data Input in PCM mode	100k Ω Pull down
	DSDL3	I	Audio Serial Data Input in DSD mode	
	TDMO2	O	Audio Serial Data Output in Daisy Chain mode	
8	DSDR3	I	Audio Serial Data Input in DSD mode	Hi-Z
9	DSDL4	I	Audio Serial Data Input in DSD mode	Hi-Z
10	DSDR4	I	Audio Serial Data Input in DSD mode	Hi-Z
11	DZF	O	Zero Input Detect in I2C Bus or 3-wire serial control mode	100k Ω Pull down
	SMUTE	I	Soft Mute Pin in Parallel control mode. When this pin is changed to "H", soft mute cycle is initiated. When it is returning to "L", the output mute is released.	
12	CAD1	I	Chip Address 0 Pin in I C Bus or 3-wire serial control mode	Hi-Z
	DCHAIN	I	Daisy Chain Mode select pin in Parallel control mode.	
13	SDA	I/O	Control Data Pin in I2C Bus serial control mode	Hi-Z
	CDTI	I	Control Data Input Pin in 3-wire serial control mode	
14	TDM0	I	TDM Mode select pin in Parallel control mode.	Hi-Z
	SCL	I	Control Data Clock Pin in I2C Bus serial control mode	
	CCLK	I	Control Data Clock Pin in 3-wire serial control mode	
	TDM1	I	TDM Mode select pin in Parallel control mode.	

No.	Pin Name	I/O	Function	PD State
15	CAD0_I2C	I	Chip Address 0 Pin in I2C Bus serial control mode	Hi-Z
	CSN	I	Chip Select Pin in 3-wire serial control mode	
	DIF	I	Audio Data Format Select in Parallel control mode. "L": 32-bit MSB, "H": 32-bit I2S	
16	PS	I	(I2C pin = "H") Control Mode Select Pin "L": I2C Bus serial control mode, "H": Parallel control mode.	Hi-Z
	CAD0_SPI	I	(I2C pin = "L") Chip Address 0 Pin in 3-wire serial control mode	
17	I2C	I	Control Mode Select Pin "L": 3-wire serial control mode "H": I2C Bus serial control mode or Parallel control mode.	Hi-Z
18	AOU1L1P	O	Lch Positive Analog Output 1 Pin	Hi-Z
19	AOU1L1N	O	Lch Negative Analog Output 1 Pin	Hi-Z
20	VREFL1	I	Negative Voltage Reference Input Pin, AVSS	Hi-Z
21	VREFH1	I	Positive Voltage Reference Input Pin, AVDD	Hi-Z
22	AOU1R1N	O	Rch Negative Analog Output 1 Pin	Hi-Z
23	AOU1R1P	O	Rch Positive Analog Output 1 Pin	Hi-Z
24	AOU2L2P	O	Lch Positive Analog Output 2 Pin	Hi-Z
25	AOU2L2N	O	Lch Negative Analog Output 2 Pin	Hi-Z
26	VREFL2	I	Negative Voltage Reference Input Pin, AVSS	Hi-Z
27	VREFH2	I	Positive Voltage Reference Input Pin, AVDD	Hi-Z
28	AOU2R2N	O	Rch Negative Analog Output 2 Pin	Hi-Z
29	AOU2R2P	O	Rch Positive Analog Output 2 Pin	Hi-Z
30	AVSS	-	Analog Ground Pin	-
31	AVDD	-	Analog Power Supply Pin, 3.0V-5.5V	-
32	AOU3L3P	O	Lch Positive Analog Output 3 Pin	Hi-Z
33	AOU3L3N	O	Lch Negative Analog Output 3 Pin	Hi-Z
34	VREFH3	I	Positive Voltage Reference Input Pin, AVDD	Hi-Z
35	VREFL3	I	Negative Voltage Reference Input Pin, AVSS	Hi-Z
36	AOU3R3N	O	Rch Negative Analog Output 3 Pin	Hi-Z
37	AOU3R3P	O	Rch Positive Analog Output 3 Pin	Hi-Z
38	AOU4L4P	O	Lch Positive Analog Output 4 Pin	Hi-Z
39	AOU4L4N	O	Lch Negative Analog Output 4 Pin	Hi-Z
40	VREFH4	I	Positive Voltage Reference Input Pin, AVDD	Hi-Z
41	VREFL4	I	Negative Voltage Reference Input Pin, AVSS	Hi-Z
42	AOU4R4N	O	Rch Negative Analog Output 4 Pin	Hi-Z
43	AOU4R4P	O	Rch Positive Analog Output 4 Pin	Hi-Z
44	LDOE	I	Internal LDO Enable Pin. "L": Disable, "H": Enable	Hi-Z
45	TVDD	-	Digital Power Supply Pin, 3.0V-3.6V	-
46	DVSS	-	Digital Ground Pin	-
47	VDD18	O	LDO Output Pin (LDOE pin = "H") This pin should be connected to DVSS with 1.0μF.	(Note 4)
		I	1.8V Power Input Pin (LDOE pin = "L")	
48	PDN	I	Power-Down & Reset Pin When this pin is "L", the AK4458 is powered-down and the control registers are reset to default state.	Hi-Z

Note 2. All input pins except internal pull-up/down pins should not be left floating.

Note 3. PCM mode and DSD mode are controlled by registers. Daisy Chain mode is controlled by both registers and pins.

Note 4. This pin outputs DVSS when the LDOE pin = "H" and Hi-z when the LDOE pin = "L".

# FUNCTIONAL BLOCK DIAGRAM

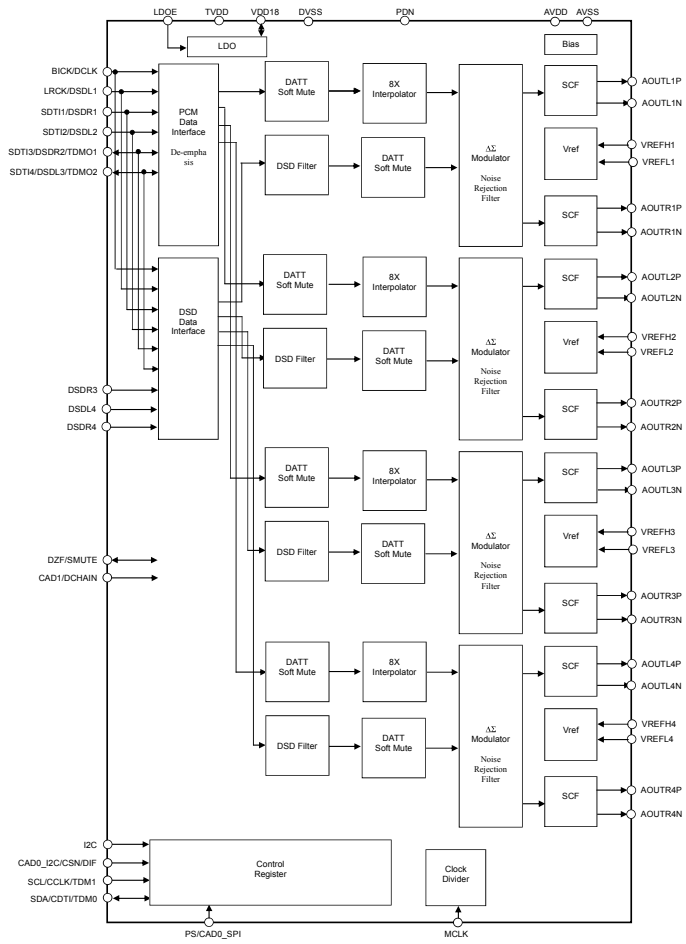

# BD82065FVJ-E2 (DIGITAL\_NETWORK : IC814)

Block diagram

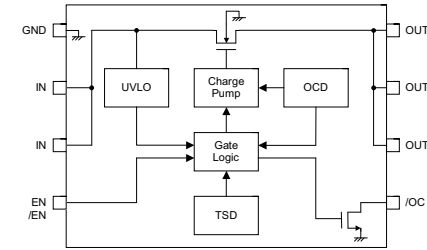
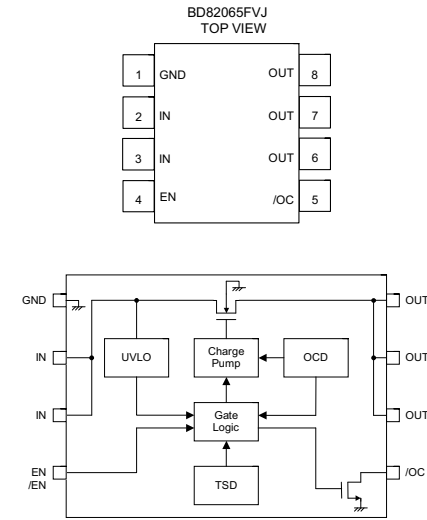

Caution in servicing

Electrical

Mechanical

Repair Information

Updating

# PCM5100PWR (DIGITAL\_NETWORK : IC765)

PCM510X (top view)

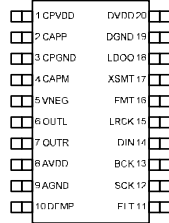
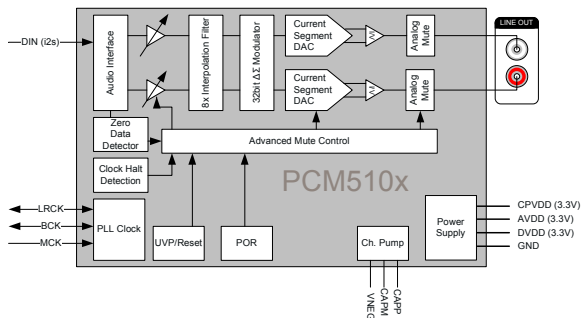

Table 2. TERMINAL FUNCTIONS, PCM510x

TERMINAL NAME	NO.	I/O	DESCRIPTION
CPVDD	1	-	Charge pump power supply, 3.3V
CAPP	2	O	Charge pump flying capacitor terminal for positive rail
CPGND	3	-	Charge pump ground
CAPM	4	O	Charge pump flying capacitor terminal for negative rail
VNEG	5	O	Negative charge pump rail terminal for decoupling, -3.3V
OUTL	6	O	Analog output from DAC left channel
OUTR	7	O	Analog output from DAC right channel
AVDD	8	-	Analog power supply, 3.3V
AGND	9	-	Analog ground
DEMP	10	I	De-emphasis control for 44.1kHz sampling rate <sup>(1)</sup> : Off (Low) / On (High)
FLT	11	I	Filter select : Normal latency (Low) / Low latency (High)
SCK	12	I	System clock input
BCK	13	I	Audio data bit clock input
DIN	14	I	Audio data input
LRCK	15	I	Audio data word clock input
FMT	16	I	Audio format selection : I <sup>2</sup> S (Low) / Left justified (High)
XSMT	17	I	Soft mute control : Soft mute (Low) / soft un-mute (High)
LDOO	18	-	Internal logic supply rail terminal for decoupling
DGND	19	-	Digital ground
DVDD	20	-	Digital power supply, 3.3V

(1) Failsafe LVCMOS Schmitt trigger input

## Block diagram



# AD8195 (F-HDMI : IC811)

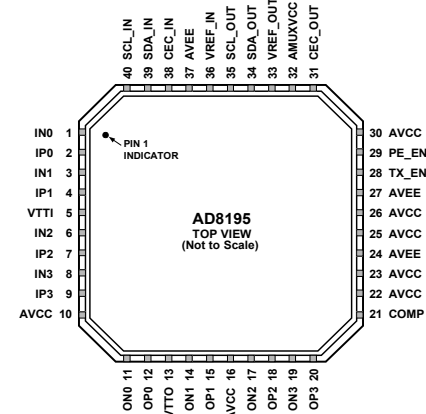

NOTES  
 1. THE AD8195 LFCSP HAS AN EXPOSED PAD ON THE UNDERSIDE OF THE PACKAGE THAT AIDS IN HEAT DISSIPATION. THE PAD MUST BE ELECTRICALLY CONNECTED TO THE AVEE SUPPLY PLANE IN ORDER TO MEET THERMAL SPECIFICATIONS.

## AD8195 Terminal Functions

Pin No.	Mnemonic	Type <sup>1</sup>	Description
1	IN0	HS I	High Speed Input Complement.
2	IP0	HS I	High Speed Input.
3	IN1	HS I	High Speed Input Complement.
4	IP1	HS I	High Speed Input.
5	VTT1	Power	Input Termination Supply. Nominally connected to AVCC.
6	IN2	HS I	High Speed Input Complement.
7	IP2	HS I	High Speed Input.
8	IN3	HS I	High Speed Input Complement.
9	IP3	HS I	High Speed Input.
10, 16, 22, 23, 25, 26, 30	AVCC	Power	Positive Analog Supply, 3.3 V nominal.
11	ON0	HS O	High Speed Output Complement.
12	OP0	HS O	High Speed Output.
13	VTT0	Power	Output Termination Supply. Nominally connected to AVCC.
14	ON1	HS O	High Speed Output Complement.
15	OP1	HS O	High Speed Output.
17	ON2	HS O	High Speed Output Complement.
18	OP2	HS O	High Speed Output.
19	ON3	HS O	High Speed Output Complement.
20	OP3	HS O	High Speed Output.
21	COMP	Control	Power-On Compensation Pin. Bypass to ground through a 10 μF capacitor.
24, 27, 37, Exposed Pad	AVEE	Power	Negative Analog Supply, 0 V nominal.
28	TX_EN	Control	High Speed Output Enable Parallel Interface.
29	PE_EN	Control	High Speed Preemphasis Enable Parallel Interface.
31	CEC_OUT	LS I/O	CEC Output Side.
32	AMUXVCC	Power	Positive Auxiliary Buffer Supply, 5 V nominal.
33	VREF_OUT	Reference	DDC Output Side Pull-Up Reference Voltage.
34	SDA_OUT	LS I/O	DDC Output Side Data Line Input/Output.
35	SCL_OUT	LS I/O	DDC Output Side Clock Line Input/Output.
36	VREF_IN	Reference	DDC Input Side Pull-Up Reference Voltage.
38	CEC_IN	LS I/O	CEC Input Side.
39	SDA_IN	LS I/O	DDC Input Side Data Line.
40	SCL_IN	LS I/O	DDC Input Side Clock Line.

<sup>1</sup> HS = high speed, LS = low speed, I = input, and O = output.

### NJU72343 (DIGITAL\_ANALOG : IC822)

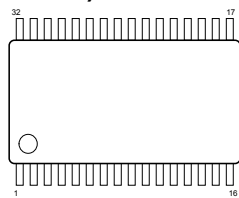

No.	Symbol	Function	No.	Symbol	Function
1	AREF	Analog reference potential	17	DATA	IC control data input
2	ADR	Address selection	18	CLOCK	IC control clock input
3	InA2	Ach input2	19	VDDOUT	Digital power supply output
4	InB2	Bch input2	20	AREF	Analog reference potential
5	InA1	Ach input1	21	OutH	Hch output
6	InB1	Bch input1	22	OutG	Gch output
7	InC	Cch input	23	OutF	Fch output
8	InD	Dch input	24	OutE	Ech output
9	InE	Ech input	25	OutD	Dch output
10	InF	Fch input	26	OutC	Cch output
11	InG1	Gch input1	27	OutB	Bch output
12	InH1	Hch input1	28	OutA	Ach output
13	InG2	Cch input2	29	AREF	Analog reference potential
14	InH2	Dch input2	30	V-	Power supply(-)
15	MUTE	External mute control	31	AREF	Analog reference potential
16	REF	Digital reference potential	32	V+	Power supply(+)

### NJU72750A (DIGITAL\_ANALOG : IC821)

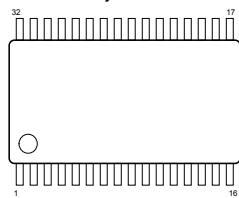

No.	Symbol	Function	No.	Symbol	Function
1	V+	Power supply(+)	17	DATA	IC control data input
2	InA1	Ach input1	18	CLOCK	IC control clock input
3	InB1	Bch input1	19	NC	-
4	InA2	Ach input2	20	NC	-
5	InB2	Bch input2	21	OutB3	Bch output3
6	InA3	Ach input3	22	OutA3	Ach output3
7	InB3	Bch input3	23	REF_B	Bch reference potential
8	InA4	Ach input4	24	OutB2	Bch output2
9	InB4	Bch input4	25	OutA2	Ach output2
10	InA5	Ach input5	26	REF_A	Ach reference potential
11	InB5	Bch input5	27	OutB1	Bch output1
12	InA6	Ach input6	28	OutA1	Ach output1
13	InB6	Bch input6	29	NC	-
14	InA7	Ach input7	30	ADR0	Address selection pin 0
15	InB7	Bch input7	31	ADR1	Address selection pin 1
16	REF	BIAS reference potential	32	V-	Power supply(-)

### BD3812F (DIGITAL\_ANALOG : IC911 X1400 E3 only)

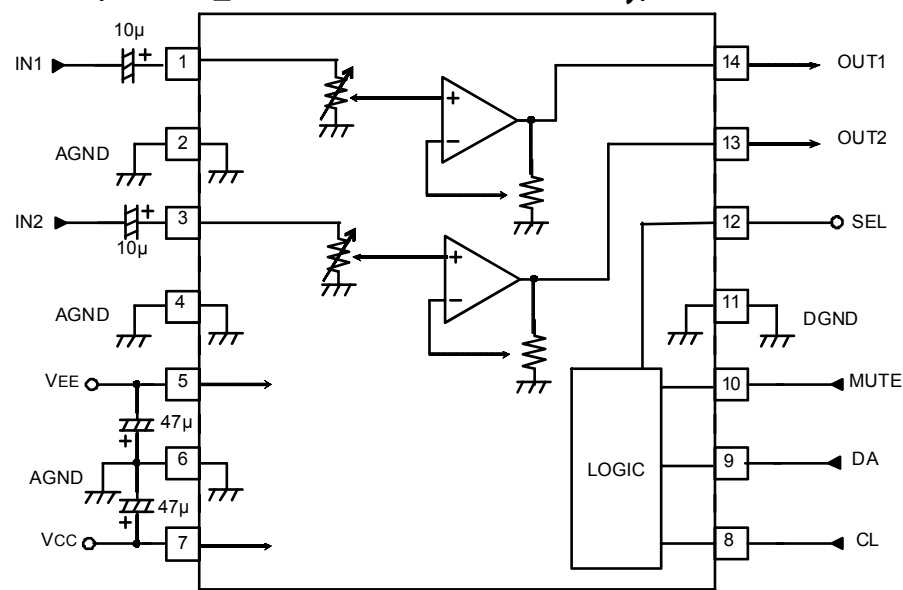

### NJM2595MTE1 (DIGITAL\_ANALOG : IC881)

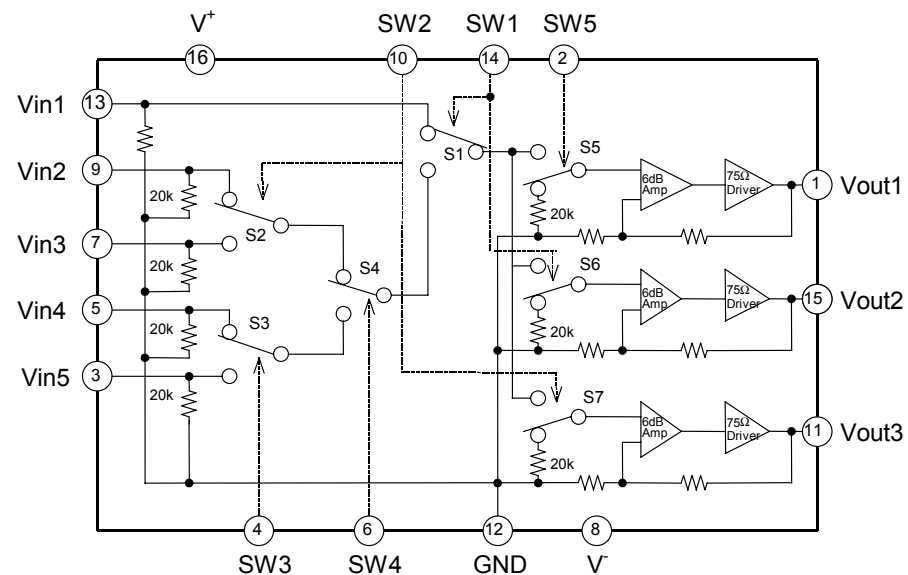

## TOP268VG (SMPS : IC601)

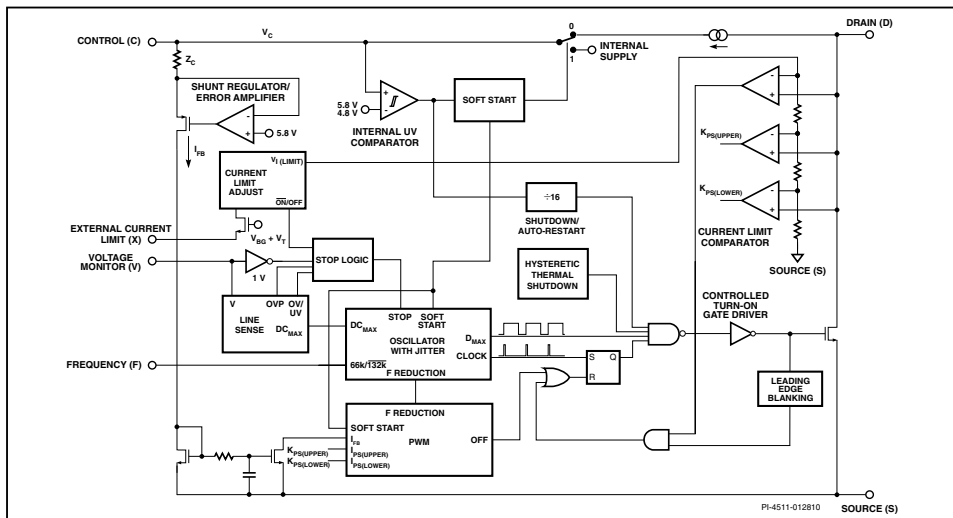

Figure 3. Functional Block Diagram.

### Pin Functional Description

**DRAIN (D) Pin:**  
High-voltage power MOSFET DRAIN pin. The internal start-up bias current is drawn from this pin through a switched high-voltage current limit sense point for drain current.

**CONTROL (C) Pin:**  
Error amplifier and feedback current input pin for duty cycle control. Internal shunt regulator connection to provide internal bias current during normal operation. It is also used as the connection point for the supply bypass and auto-restart/compensation capacitor.

**EXTERNAL CURRENT LIMIT (X) Pin:**  
Input pin for external current limit adjustment remote-ON/OFF and device reset. A connection to SOURCE pin disables all functions on this pin. This pin should not be left floating.

**VOLTAGE MONITOR (V) Pin:**  
Input for OV, UV, line feed-forward with  $D_{C\_MAX}$  reduction, output overvoltage protection (OVP), remote-ON/OFF. A connection to the SOURCE pin disables all functions on this pin. This pin should not be left floating.

**FREQUENCY (F) Pin :**  
Input pin for selecting switching frequency 132 kHz if connected to SOURCE pin and 66 kHz if connected to CONTROL pin. This pin should not be left floating.

**SOURCE (S) Pin:**  
Output MOSFET source connection for high-voltage power return. Primary-side control circuit common and reference point.

**NO CONNECTION (NC) Pin:**  
Internally not connected, floating potential pin.

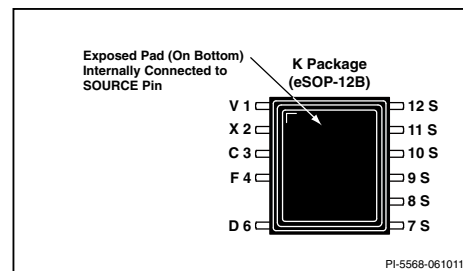
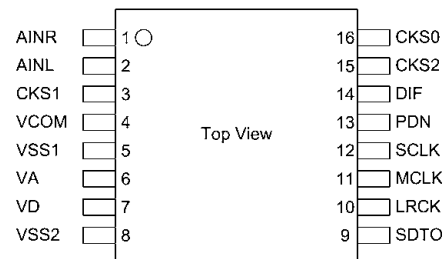

Figure 4. Pin Configuration (Top View).

## AK5358BET(DIGITAL\_DIR : IC764)



### AK5358BET Pin Function

No.	Pin Name	I/O	Function
1	AINR	I	Rch Analog Input Pin
2	AINL	I	Lch Analog Input Pin
3	CKS1	I	Mode Select 1 Pin
4	VCOM	O	Common Voltage Output Pin, VA/2 Bias voltage of ADC input.
5	VSS1	-	Ground Pin
6	VA	-	Analog Power Supply Pin, 4.5 ~ 5.5V
7	VD	-	Digital Power Supply Pin, 2.7 ~ 5.5V
8	VSS2	-	Ground Pin
9	SDTO	O	Audio Serial Data Output Pin "L" Output at Power-down mode.
10	LRCK	I/O	Output Channel Clock Pin "L" Output in Master Mode at Power-down mode.
11	MCLK	I	Master Clock Input Pin
12	SCLK	I/O	Audio Serial Data Clock Pin "L" Output in Master Mode at Power-down mode.
13	PDN	I	Power Down Mode & Reset Pin "H": Power up, "L": Power down & Reset
14	DIF	I	Audio Interface Format Pin "H": 24bit I <sup>2</sup> S Compatible, "L": 24bit MSB justified
15	CKS2	I	Mode Select 2 Pin
16	CKS0	I	Mode Select 0 Pin

## 2. FL DISPLAY

### FLD (018BT021GINK) (FRONT : FL4400)

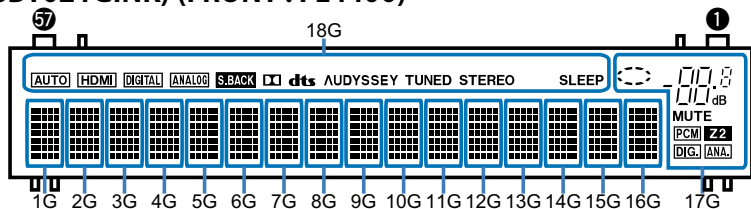

#### PIN CONNECTION

CONNECTION	PIN NO.
F2	57
NP	56
NP	55
NP	54
NP	53
LGND	52
PGND	51

CONNECTION	PIN NO.
VDD	50
OSC	49
RESET	48
CS	47
CP	46
DA	45
TSA	44
TSB	43
NX	42
NX	41
NX	40
NX	39
NX	38
NX	37
NX	36
NX	35
NX	34
NX	33
NX	32
NX	31
NX	30
NX	29
NX	28
NX	27
NX	26
NX	25
NX	24
NX	23
NX	22
NX	21
NX	20
NX	19
NX	18
NX	17
NX	16
NX	15
NX	14
NX	13
NX	12
NX	11
NX	10
NX	9
18G	8
17G	7
Q17G	6
Q18G	5
NP	4
NP	3
NP	2
F1	1

#### NOTE

- 1) F1, F2 ----Filament
- 2) NP -----No pin
- 3) DL -----Datum Line
- 4) NX -----No extend pin
- 5) LGND ----Logic GND pin
- 6) PGND ----Power GND pin
- 7) VH -----High Voltage Supply pin
- 8) VDD -----Logic Voltage Supply pin
- 9) CP ----Shift Register Clock
- 10) DA ----Serial Data Input
- 11) TSA, B --Test pin
- 12) CS -----Chip Select Input pin
- 13) RESET --Reset Input
- 14) OSC ----Pin for self-oscillation
- 15) Solder composition is Sn-3Ag-0.5Cu.
- 16) 17G, 18G ---Grid
- 17) Q17G, Q18G ---Driver Output Port.
- 18) Field of vision is a minimum of 21.8° from the lower side.

#### ANODE CONNECTION

	1G	2G	3G	4G	5G	6G	7G	8G	9G	10G	11G	12G	13G	14G	15G	16G	17G(AD3)	18G(AD4)
D0	1-1	1-1	1-1	1-1	1-1	1-1	1-1	1-1	1-1	1-1	1-1	1-1	1-1	1-1	1-1	1-1	S9	-
D1	2-1	2-1	2-1	2-1	2-1	2-1	2-1	2-1	2-1	2-1	2-1	2-1	2-1	2-1	2-1	2-1	3d	-
D2	3-1	3-1	3-1	3-1	3-1	3-1	3-1	3-1	3-1	3-1	3-1	3-1	3-1	3-1	3-1	3-1	2d	-
D3	4-1	4-1	4-1	4-1	4-1	4-1	4-1	4-1	4-1	4-1	4-1	4-1	4-1	4-1	4-1	4-1	3e	-
D4	5-1	5-1	5-1	5-1	5-1	5-1	5-1	5-1	5-1	5-1	5-1	5-1	5-1	5-1	5-1	5-1	2e	-
D5	1-2	1-2	1-2	1-2	1-2	1-2	1-2	1-2	1-2	1-2	1-2	1-2	1-2	1-2	1-2	1-2	3c	-
D6	2-2	2-2	2-2	2-2	2-2	2-2	2-2	2-2	2-2	2-2	2-2	2-2	2-2	2-2	2-2	2-2	2c	-
D7	3-2	3-2	3-2	3-2	3-2	3-2	3-2	3-2	3-2	3-2	3-2	3-2	3-2	3-2	3-2	3-2	3g	-
D8	4-2	4-2	4-2	4-2	4-2	4-2	4-2	4-2	4-2	4-2	4-2	4-2	4-2	4-2	4-2	4-2	2g	-
D9	5-2	5-2	5-2	5-2	5-2	5-2	5-2	5-2	5-2	5-2	5-2	5-2	5-2	5-2	5-2	5-2	3f	-
D10	1-3	1-3	1-3	1-3	1-3	1-3	1-3	1-3	1-3	1-3	1-3	1-3	1-3	1-3	1-3	1-3	2f	-
D11	2-3	2-3	2-3	2-3	2-3	2-3	2-3	2-3	2-3	2-3	2-3	2-3	2-3	2-3	2-3	2-3	3b	-
D12	3-3	3-3	3-3	3-3	3-3	3-3	3-3	3-3	3-3	3-3	3-3	3-3	3-3	3-3	3-3	3-3	2b	-
D13	4-3	4-3	4-3	4-3	4-3	4-3	4-3	4-3	4-3	4-3	4-3	4-3	4-3	4-3	4-3	4-3	3a	-
D14	5-3	5-3	5-3	5-3	5-3	5-3	5-3	5-3	5-3	5-3	5-3	5-3	5-3	5-3	5-3	5-3	2a	-
D15	1-4	1-4	1-4	1-4	1-4	1-4	1-4	1-4	1-4	1-4	1-4	1-4	1-4	1-4	1-4	1-4	Dp	-
D16	2-4	2-4	2-4	2-4	2-4	2-4	2-4	2-4	2-4	2-4	2-4	2-4	2-4	2-4	2-4	2-4	dB	-
D17	3-4	3-4	3-4	3-4	3-4	3-4	3-4	3-4	3-4	3-4	3-4	3-4	3-4	3-4	3-4	3-4	1d	-
D18	4-4	4-4	4-4	4-4	4-4	4-4	4-4	4-4	4-4	4-4	4-4	4-4	4-4	4-4	4-4	4-4	1e	-
D19	5-4	5-4	5-4	5-4	5-4	5-4	5-4	5-4	5-4	5-4	5-4	5-4	5-4	5-4	5-4	5-4	1c	-
D20	1-5	1-5	1-5	1-5	1-5	1-5	1-5	1-5	1-5	1-5	1-5	1-5	1-5	1-5	1-5	1-5	1g	-
D21	2-5	2-5	2-5	2-5	2-5	2-5	2-5	2-5	2-5	2-5	2-5	2-5	2-5	2-5	2-5	2-5	1f	-
D22	3-5	3-5	3-5	3-5	3-5	3-5	3-5	3-5	3-5	3-5	3-5	3-5	3-5	3-5	3-5	3-5	1b	-
D23	4-5	4-5	4-5	4-5	4-5	4-5	4-5	4-5	4-5	4-5	4-5	4-5	4-5	4-5	4-5	4-5	1a	AUTO
D24	5-5	5-5	5-5	5-5	5-5	5-5	5-5	5-5	5-5	5-5	5-5	5-5	5-5	5-5	5-5	5-5	S1	HDMI
D25	1-6	1-6	1-6	1-6	1-6	1-6	1-6	1-6	1-6	1-6	1-6	1-6	1-6	1-6	1-6	1-6	S2	DIGITAL
D26	2-6	2-6	2-6	2-6	2-6	2-6	2-6	2-6	2-6	2-6	2-6	2-6	2-6	2-6	2-6	2-6	S3	ANALOG
D27	3-6	3-6	3-6	3-6	3-6	3-6	3-6	3-6	3-6	3-6	3-6	3-6	3-6	3-6	3-6	3-6	S4	S.BACK
D28	4-6	4-6	4-6	4-6	4-6	4-6	4-6	4-6	4-6	4-6	4-6	4-6	4-6	4-6	4-6	4-6	S5	DL
D29	5-6	5-6	5-6	5-6	5-6	5-6	5-6	5-6	5-6	5-6	5-6	5-6	5-6	5-6	5-6	5-6	S6	dts
D30	1-7	1-7	1-7	1-7	1-7	1-7	1-7	1-7	1-7	1-7	1-7	1-7	1-7	1-7	1-7	1-7	S7	AUDYSSEY
D31	2-7	2-7	2-7	2-7	2-7	2-7	2-7	2-7	2-7	2-7	2-7	2-7	2-7	2-7	2-7	2-7	S8	TUNED
D32	3-7	3-7	3-7	3-7	3-7	3-7	3-7	3-7	3-7	3-7	3-7	3-7	3-7	3-7	3-7	3-7	MUTE	STEREO
D33	4-7	4-7	4-7	4-7	4-7	4-7	4-7	4-7	4-7	4-7	4-7	4-7	4-7	4-7	4-7	4-7	PCM	RDS
D34	5-7	5-7	5-7	5-7	5-7	5-7	5-7	5-7	5-7	5-7	5-7	5-7	5-7	5-7	5-7	5-7	Z2	SLEEP
AD1	-	-	-	-	-	-	-	-	-	-	-	-	-	-	-	-	DIG.	-
AD2	-	-	-	-	-	-	-	-	-	-	-	-	-	-	-	-	ANA.	-

Caution in servicing

Electrical

Mechanical

Repair Information

Updating

## DISASSEMBLY

### Flowchart

1. FRONT PANEL ASSY
2. DIGITAL PCB
3. RADIATOR ASSY
4. SMPS PCB
5. REGULATOR PCB
6. POWER TRANS

## EXPLODED VIEW

## PACKING VIEW

## Flowchart

- Remove each part following the flow below.
- Reassemble the removed parts in the reverse order.
- Read "[SAFETY PRECAUTIONS](#)" before reassembling the removed parts.
- If wire bundles are removed or moved during adjustment or part replacement, reshape the wires after completing the work. Failure to shape the wires correctly may cause problems such as noise.
- See "[EXPLODED VIEW](#)"

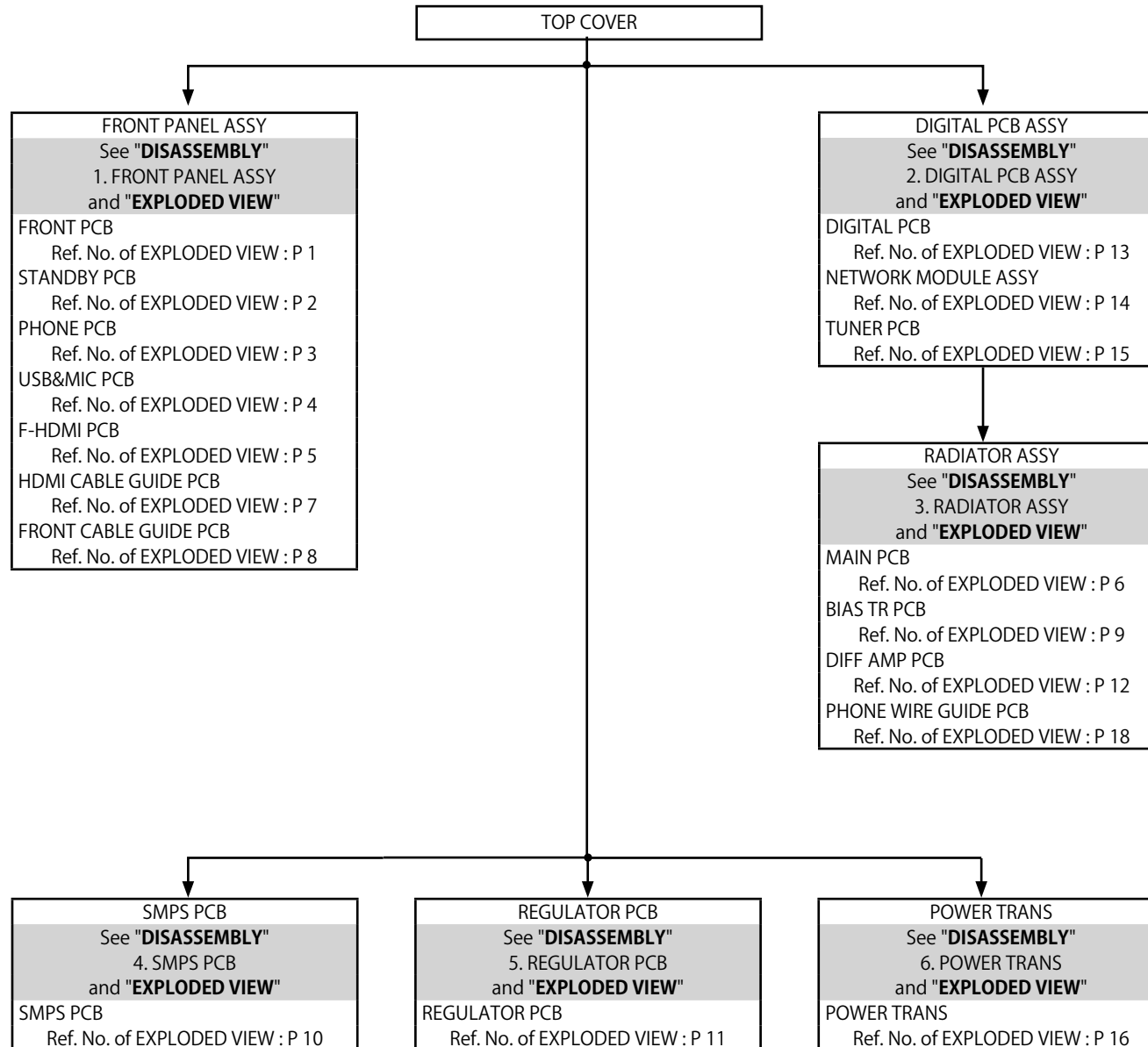

## Explanatory Photos for DISASSEMBLY

- For the shooting direction of each photos used in this manual, see the photo below.
- **A, B, C and D** in the photo below indicate the shooting directions of photos.
- The photographs with no shooting direction indicated were taken from the top of the unit.
- Photos of AVR-S730H E3 are used in this manual.

### The viewpoint of each photograph

(Shooting direction : X) [View from the top]

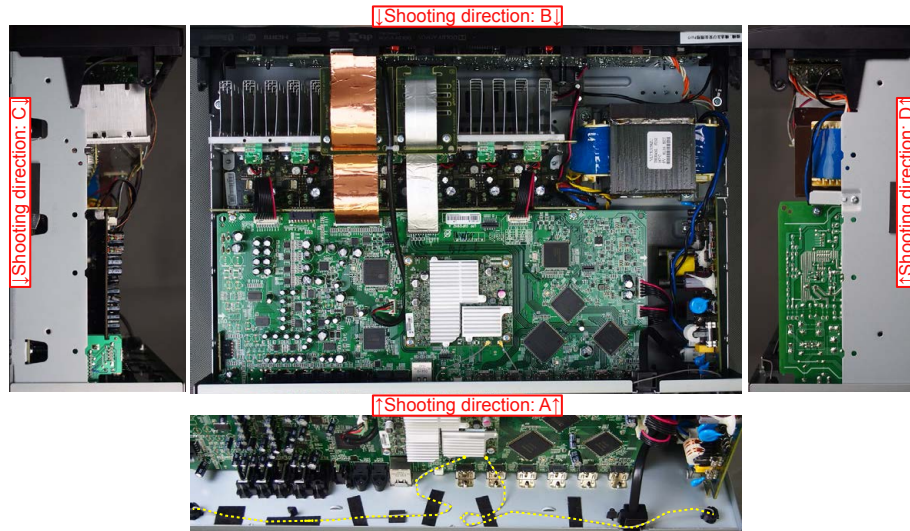

## 1. FRONT PANEL ASSY

Proceeding : **TOP COVER** → **FRONT PANEL ASSY**

- (1) Remove the screws.



- (2) Remove the screws. Remove the connector. Remove the FFC.

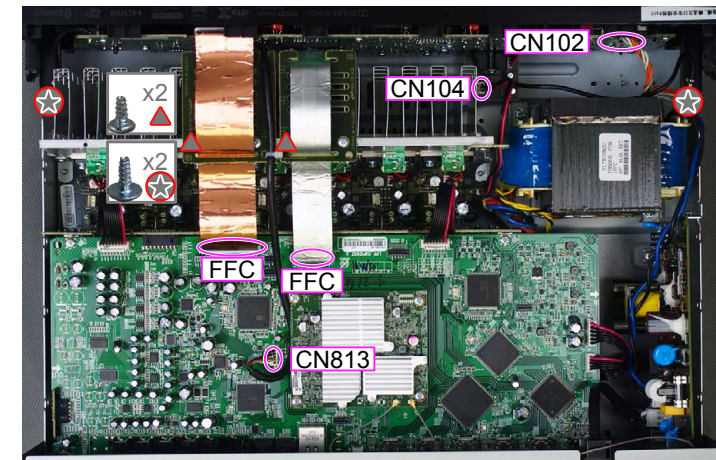

## 2. DIGITAL PCB

Proceeding : **TOP COVER** → **DIGITAL PCB**

(1) Remove the screws.



(2) Remove the screws. Remove the FFC. Remove the connector.

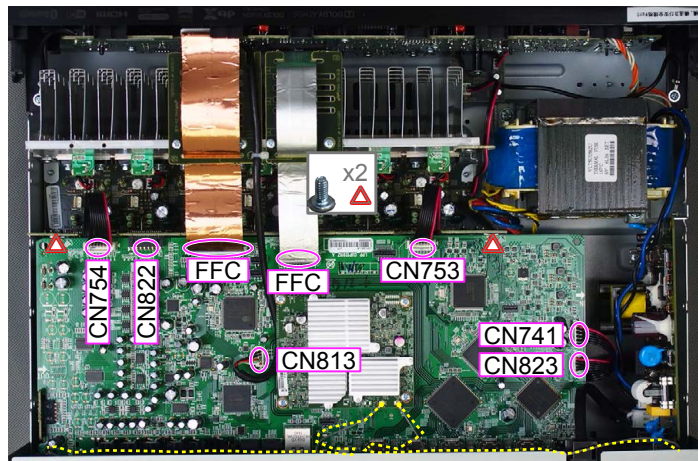

## 3. RADIATOR ASSY

Proceeding : **TOP COVER** → **DIGITAL PCB** → **RADIATOR ASSY**

(1) Remove the screws.



(2) Remove the screws. Remove the connector.

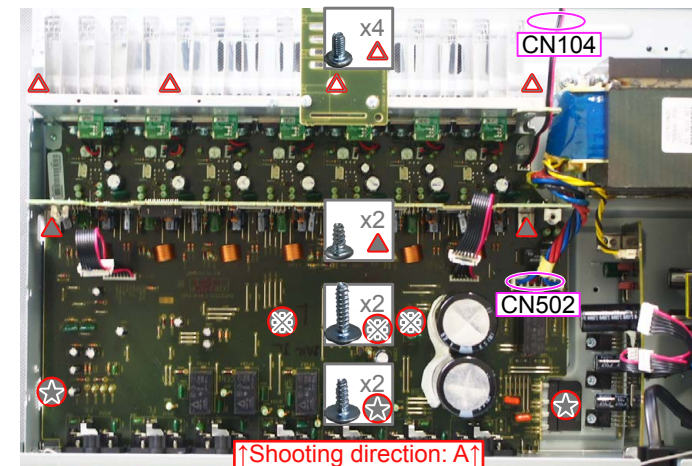

## 4. SMPS PCB

Proceeding : **TOP COVER** → **SMPS PCB**

See "[EXPLODED VIEW](#)" for instructions on removing the SMPS PCB.

## 5. REGULATOR PCB

Proceeding : **TOP COVER** → **REGULATOR PCB**

See "[EXPLODED VIEW](#)" for instructions on removing the REGULATOR PCB.

## 6. POWER TRANS

Proceeding : **TOP COVER** → **POWER TRANS**

See "[EXPLODED VIEW](#)" for instructions on removing the transformer (TRANS).

# EXPLODED VIEW

Parts List : <http://dmedia.dmglobal.com/Document/DocumentDetails/23150>

## AVRS730H/X1400H EXPLODED VIEW

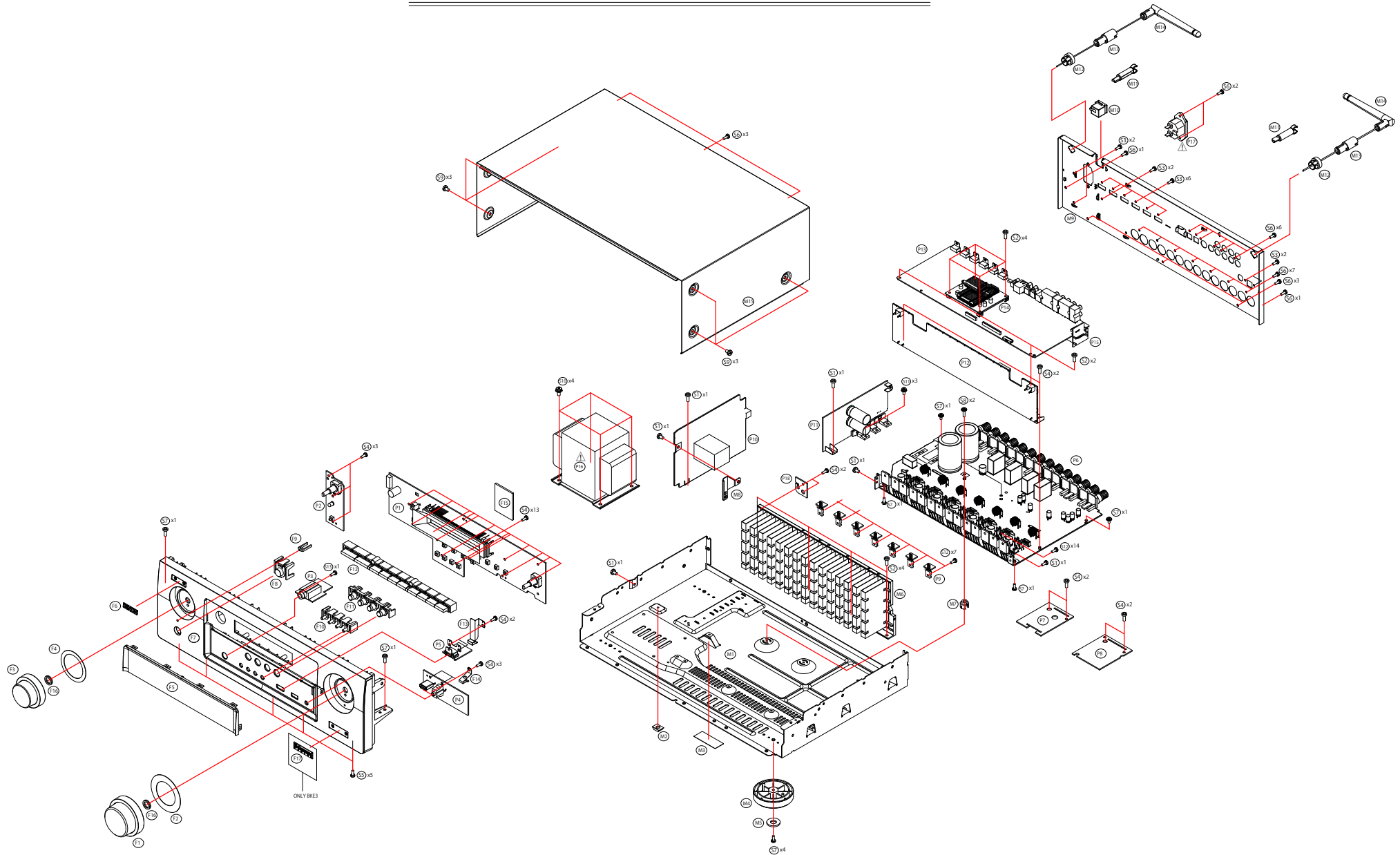

**WARNING:**  
Parts marked with this symbol  $\triangle$  have critical characteristics.  
Use ONLY replacement parts recommended by the manufacturer.

Caution in servicing  
Electrical  
Mechanical  
Repair Information  
Updating

# PACKING VIEW

Parts List : <http://dmedia.dmglobal.com/Document/DocumentDetails/23150>

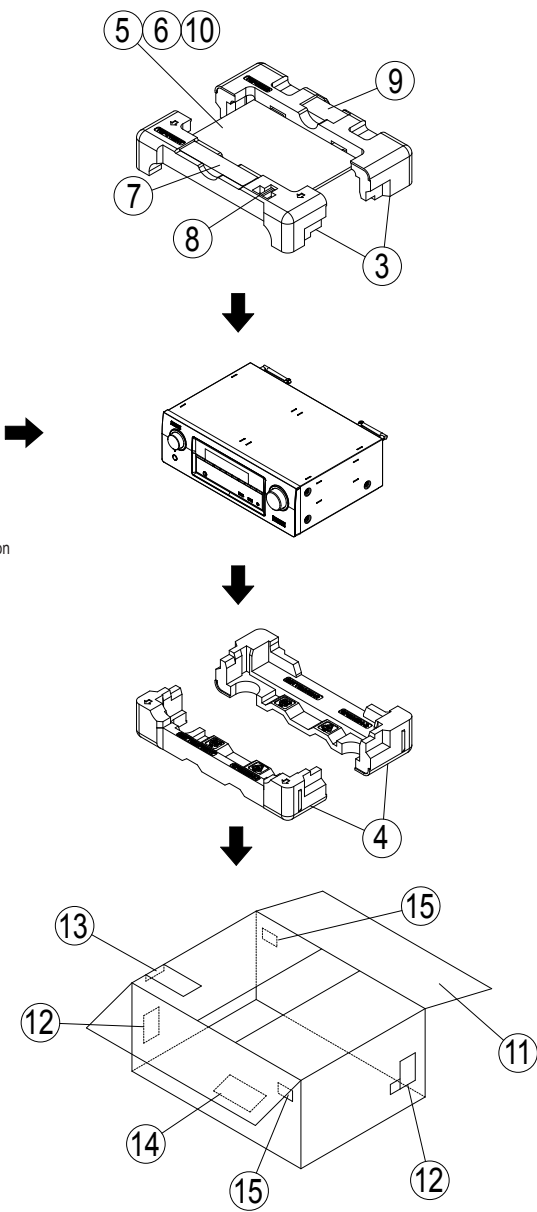
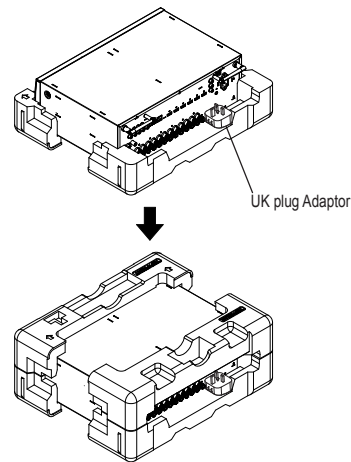
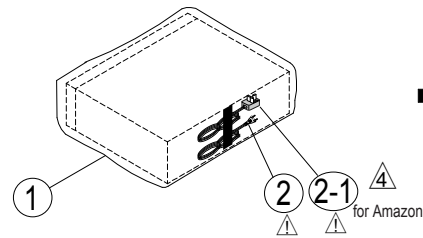
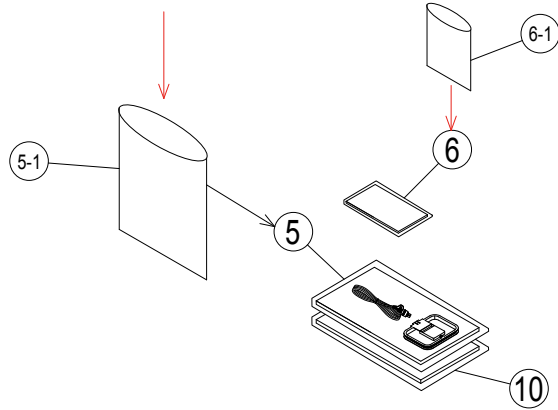
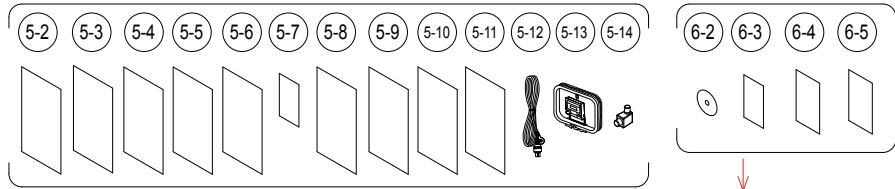

Caution in servicing  
Electrical  
Mechanical  
Repair Information  
Updating

# REPAIR INFORMATION

## TROUBLE SHOOTING

1. POWER
2. Analog video
3. HDMI/DVI
4. AUDIO
5. Network / Bluetooth / USB
6. SMPS

## HDMI "Rx/Tx" Failure Detection

1. Prior checking
2. Preparations for checking HDMI Switcher reception/transmission register
3. Starting detecting the point of failure
4. Device implementation location

## CLOCK FLOW & WAVE FORM IN DIGITAL BLOCK

## SPECIAL MODE

Special mode setting button **AVR-X1400H**

Special mode setting button **AVR-S730H**

1. Version Display Mode
2. PANEL / REMOTE LOCK Selection Mode
- 3-1. Selecting the Mode for Service-related
- 3-2. Protection History Display Mode
- 3-3. Operation Info Mode
- 3-4. TUNER STEP mode (E2 / E3 only)
- 3-5. Remote ID Setup Mode
4. Protection Pass Mode
5. Network Initialization Mode
6. Clearing the Operation Info

## DIAGNOSTIC MODE

Service Path Check Mode

DIAGNOSTIC PATH DIAGRAM

## JIG FOR SERVICING

## ADJUSTMENT

# TROUBLE SHOOTING

## 1. POWER

### 1.1. The unit does not power on

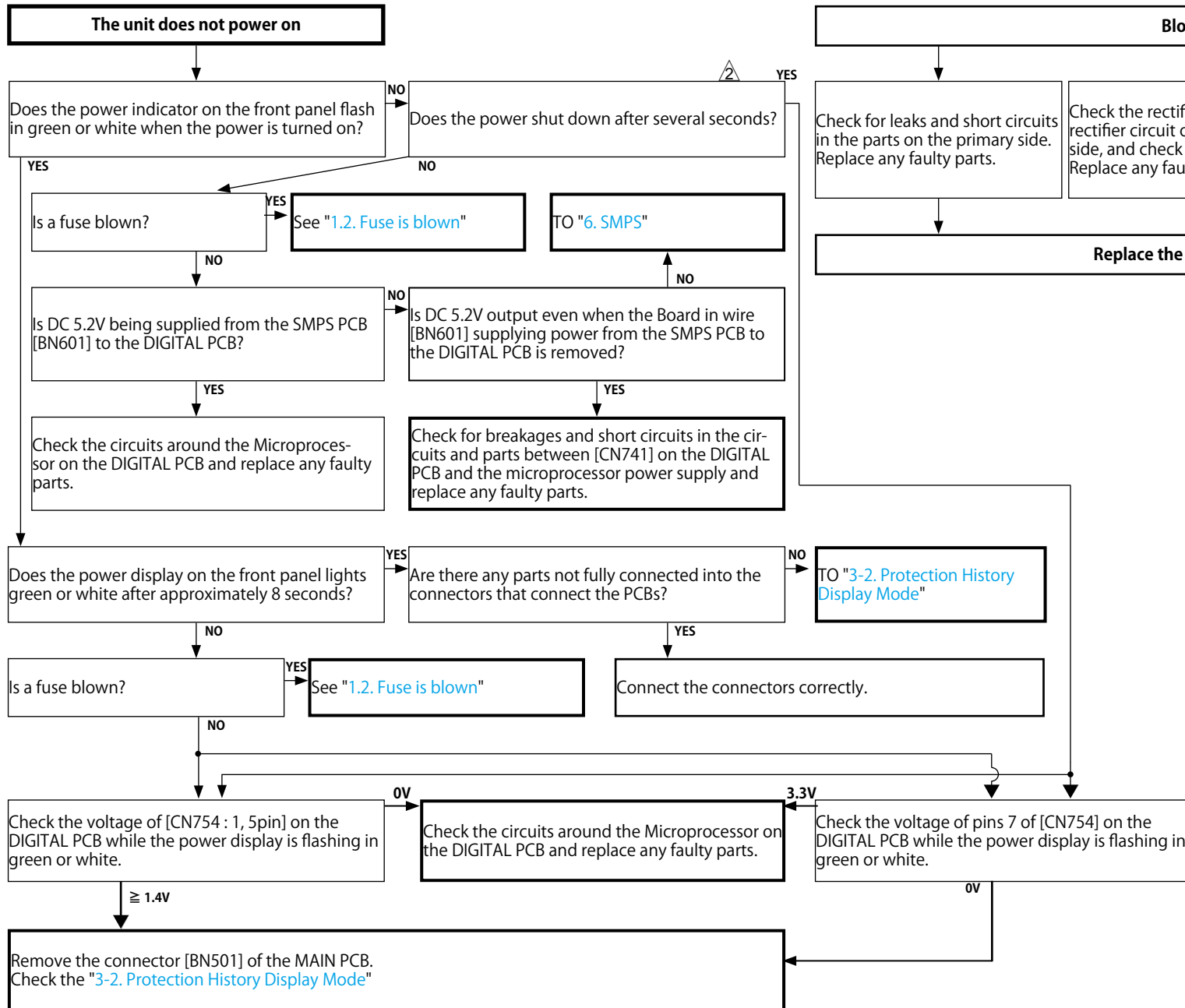

### 1.2. Fuse is blown

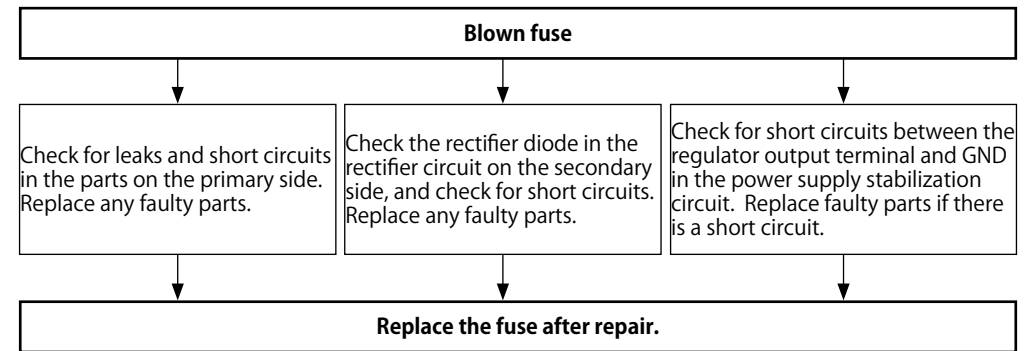

Caution in servicing

Electrical

Mechanical

Repair Information

Updating

## 2. Analog video

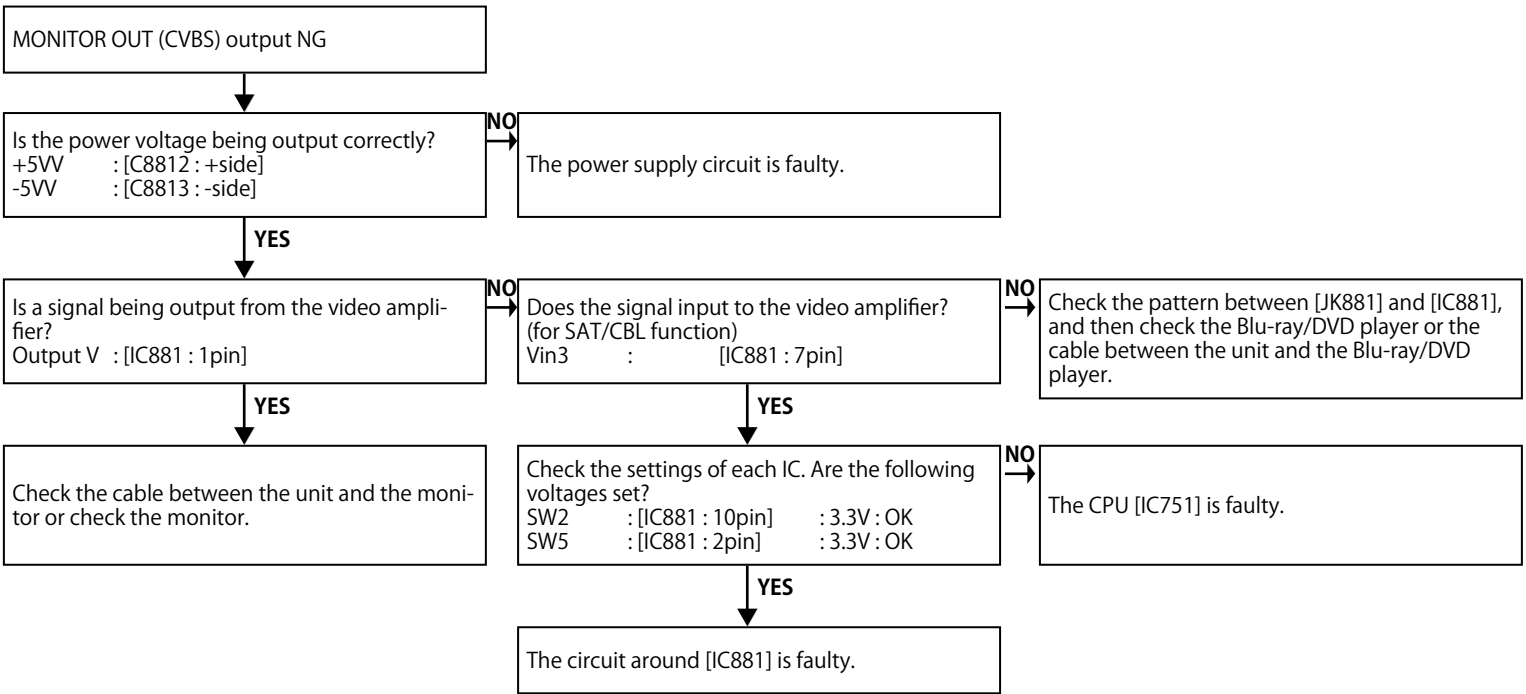

### VIDEO test point

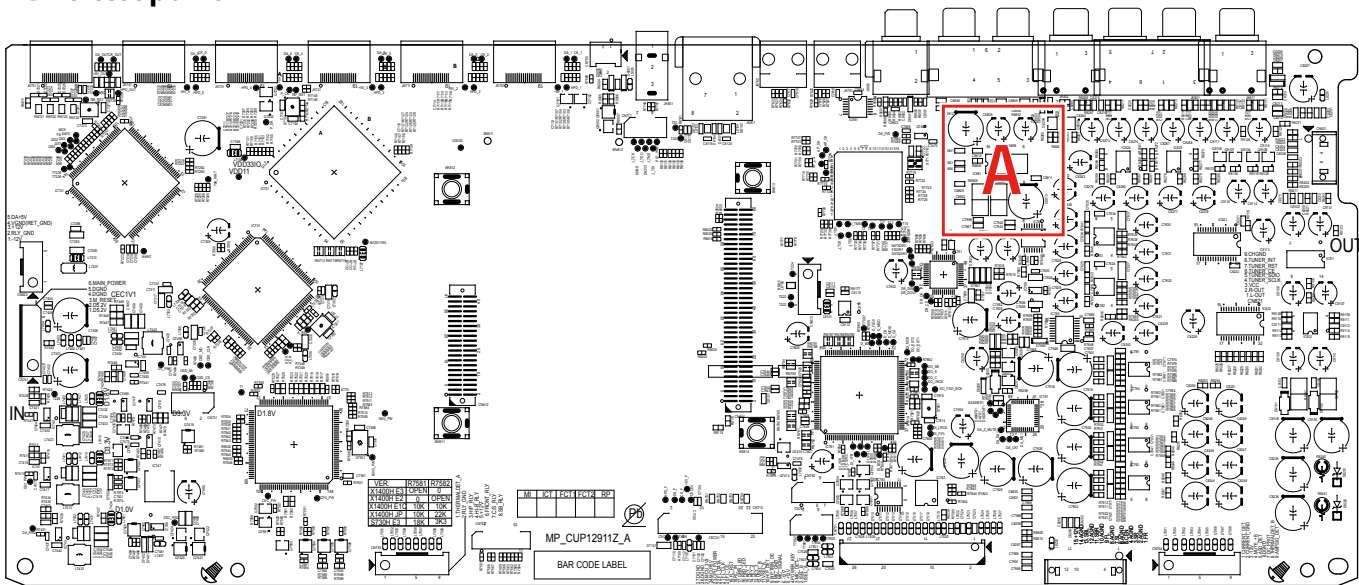

DIGITAL (A SIDE)

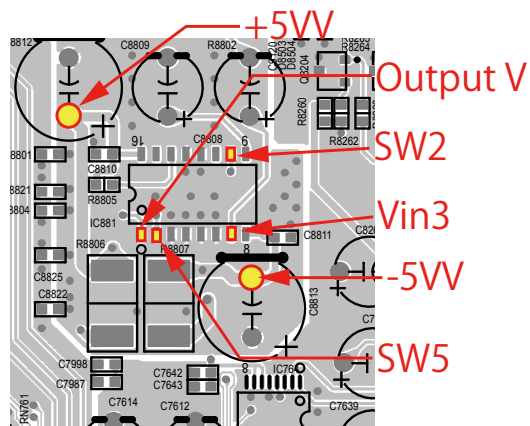

### 3. HDMI/DVI

#### 3.1. No picture or sound is output (HDMI to HDMI)

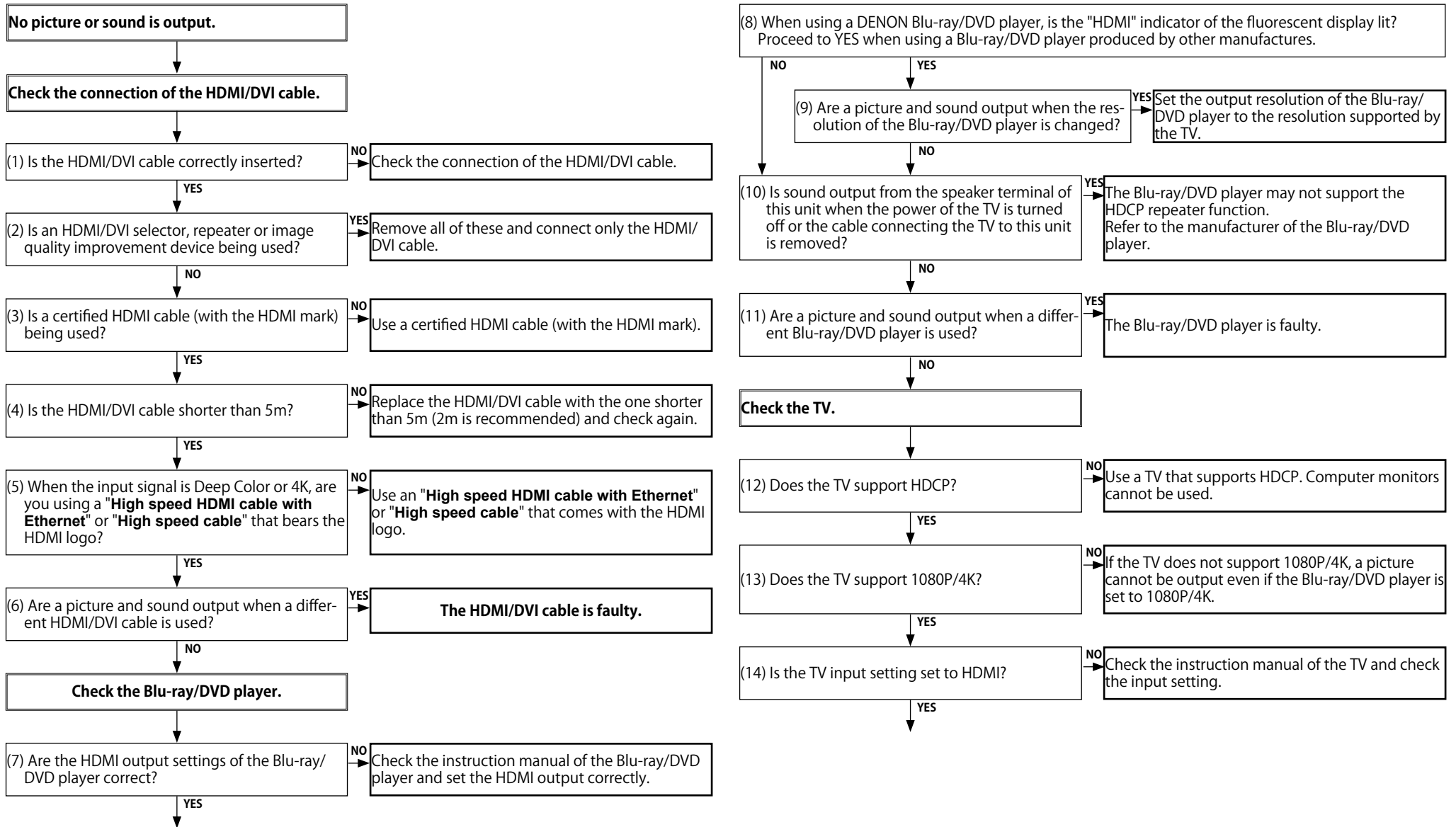

Go to next page.

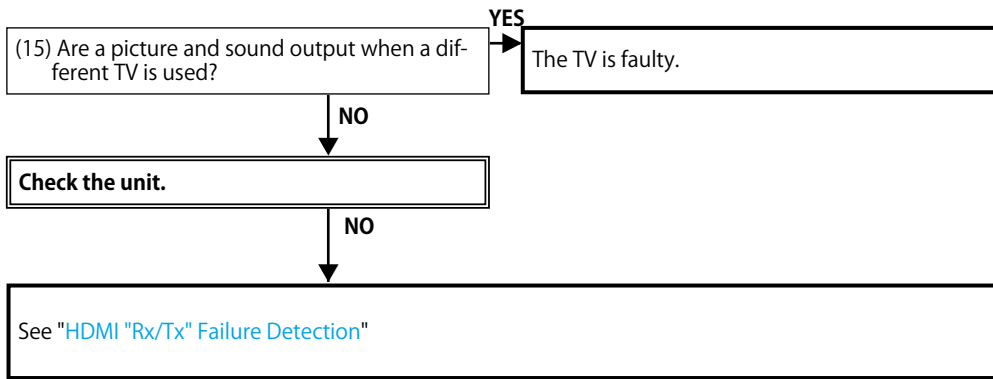

## 4. AUDIO

### 4.1. AUDIO CHECK

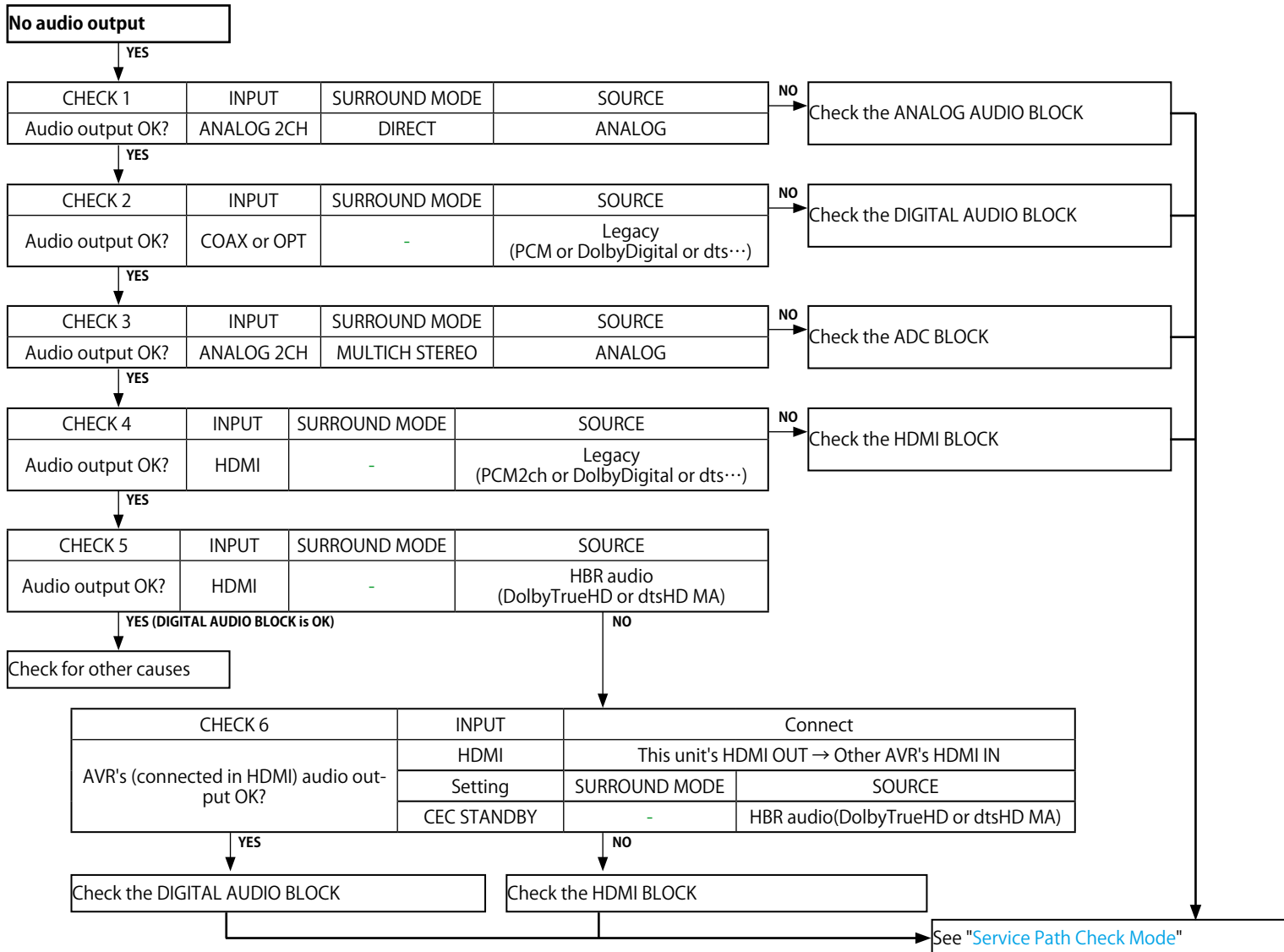

## 4.2. Power AMP (AMP PCB)

When using the protection pass mode, do not connect speakers to the speaker terminals.

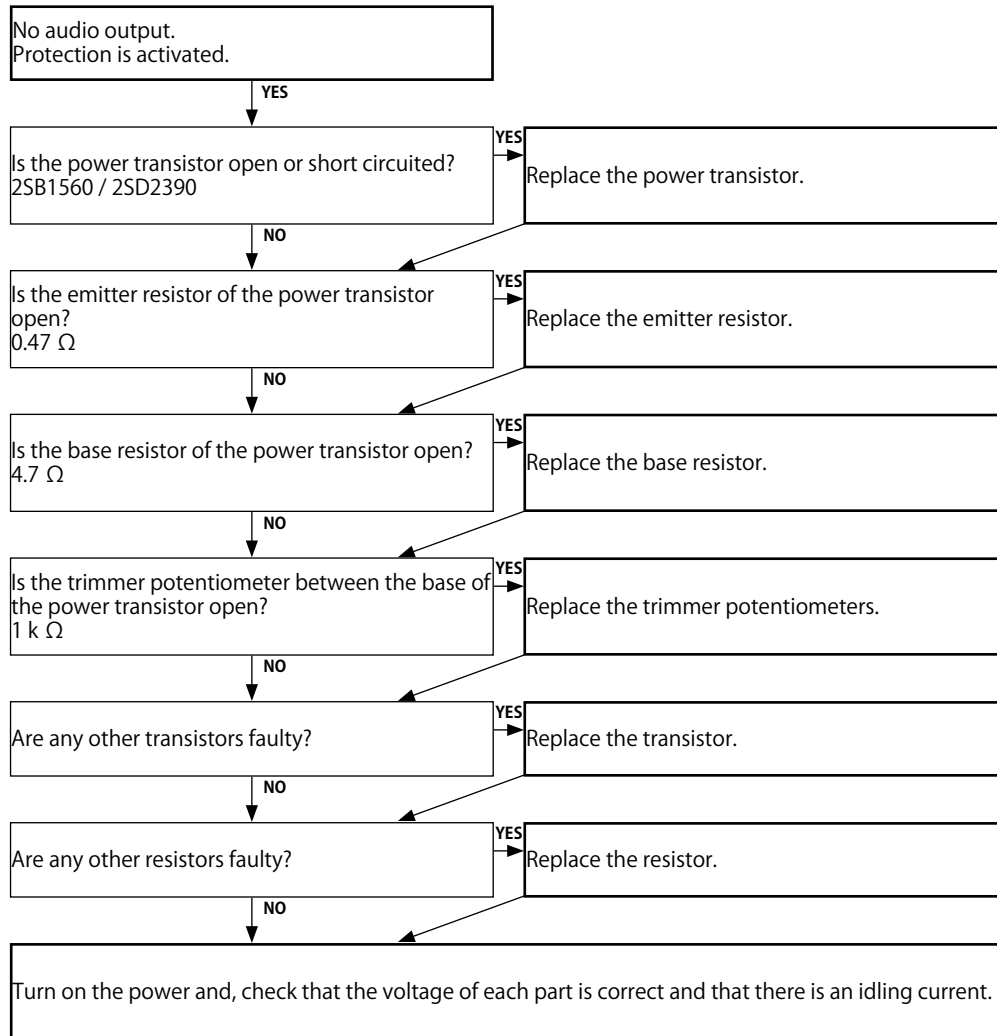

## 4.3. Analog audio

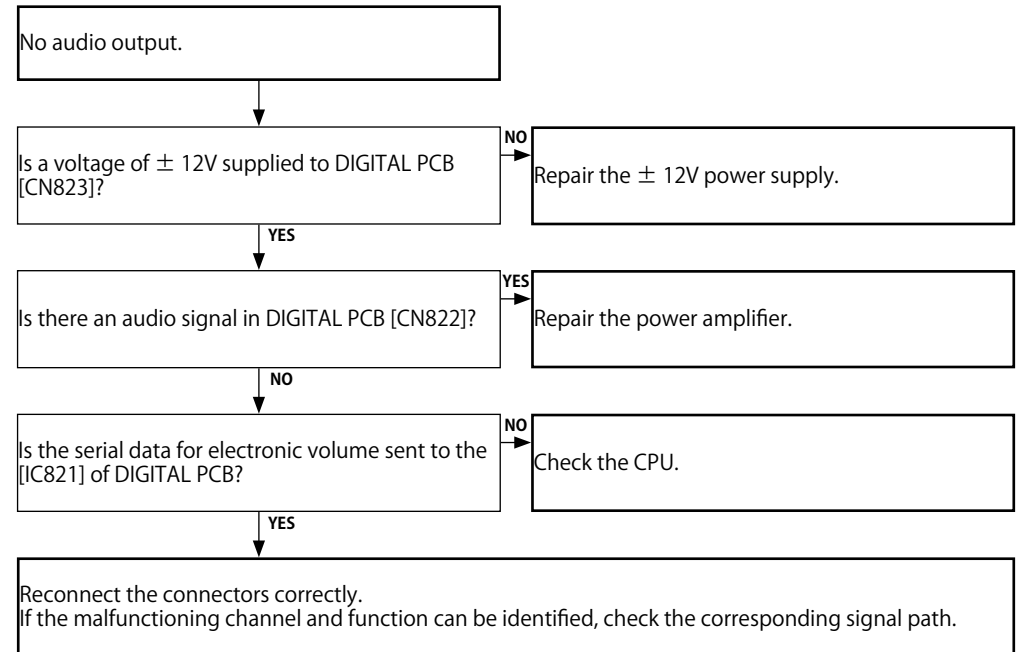

## 5. Network / Bluetooth / USB

### 5.1. Cannot connect to the network

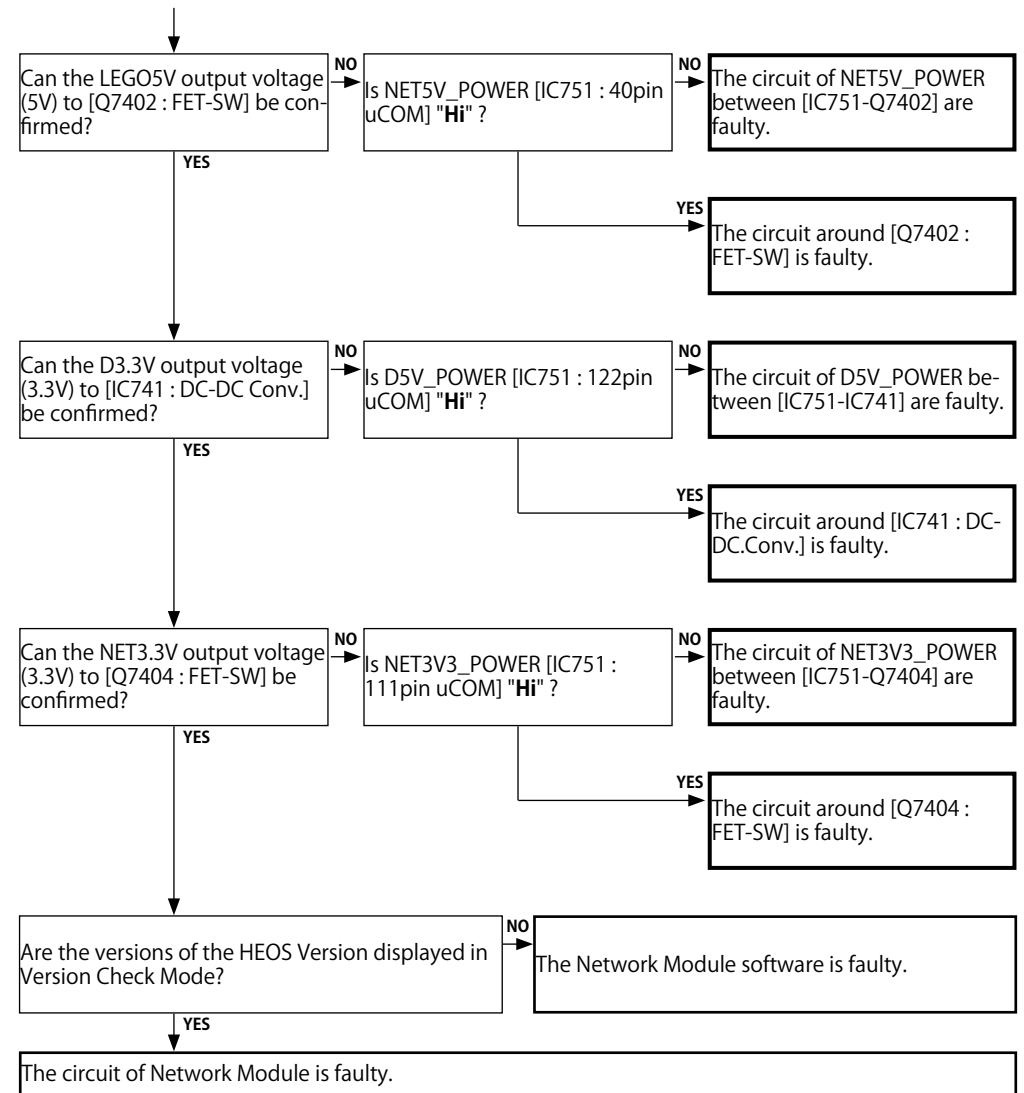
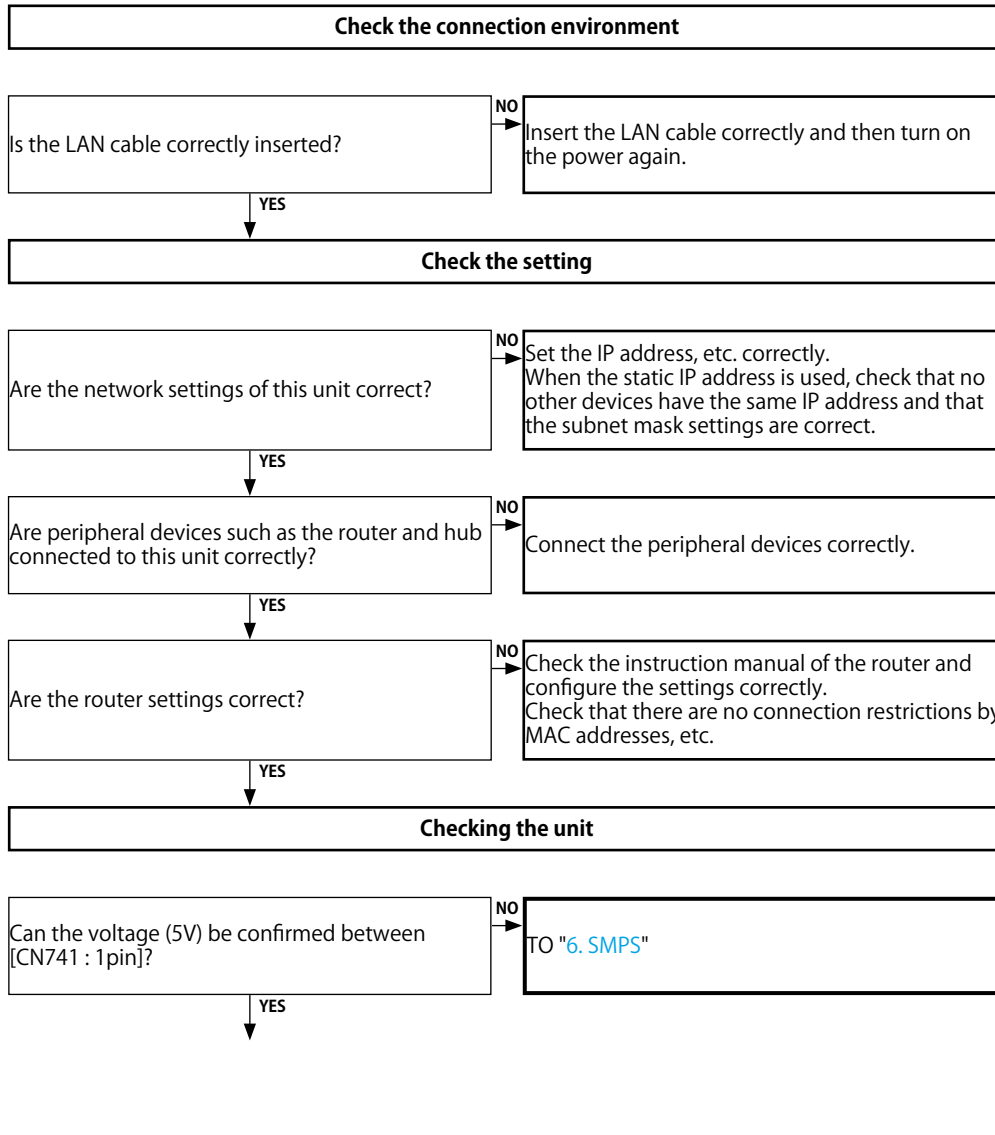

## 5.2. Cannot establish a Bluetooth connection

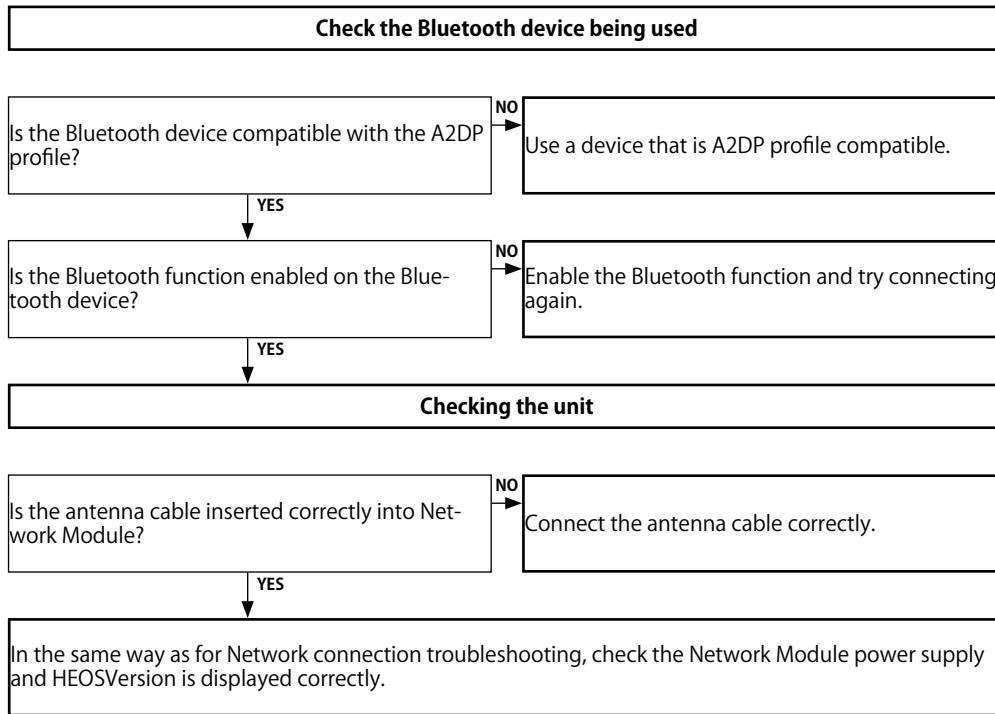

## 5.3. Cannot recognize the connected USB device

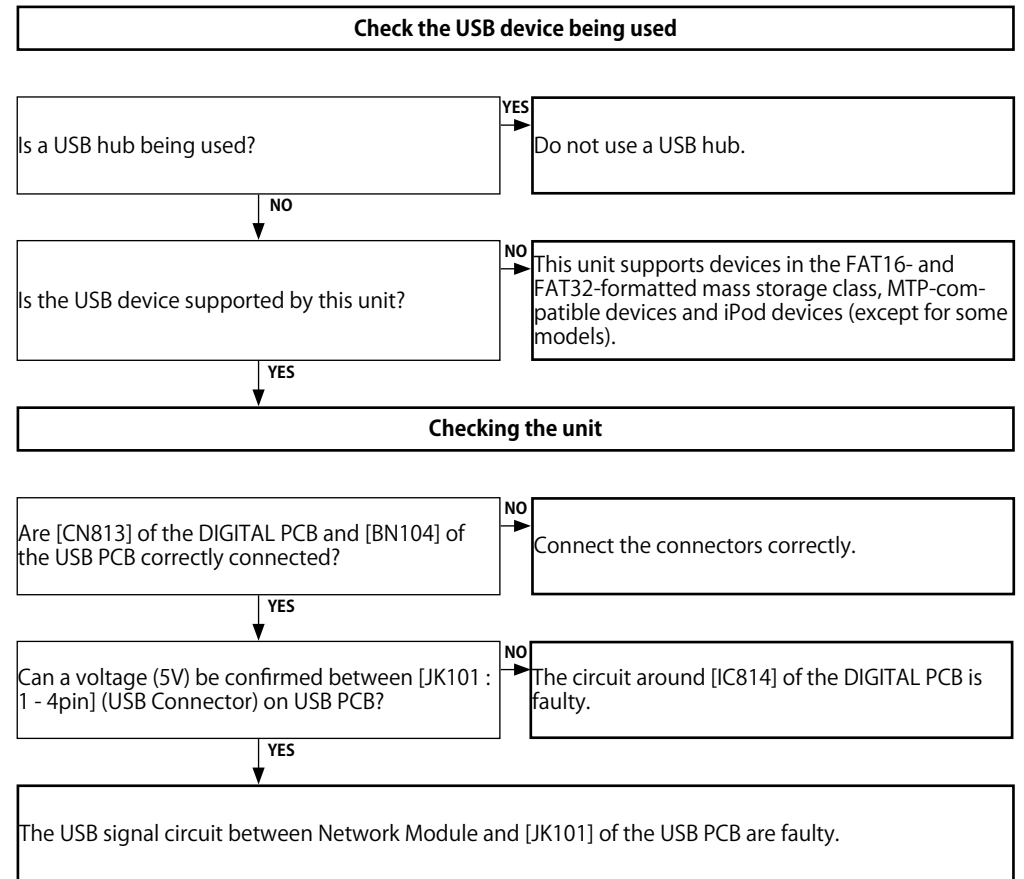

## DIGITAL test point

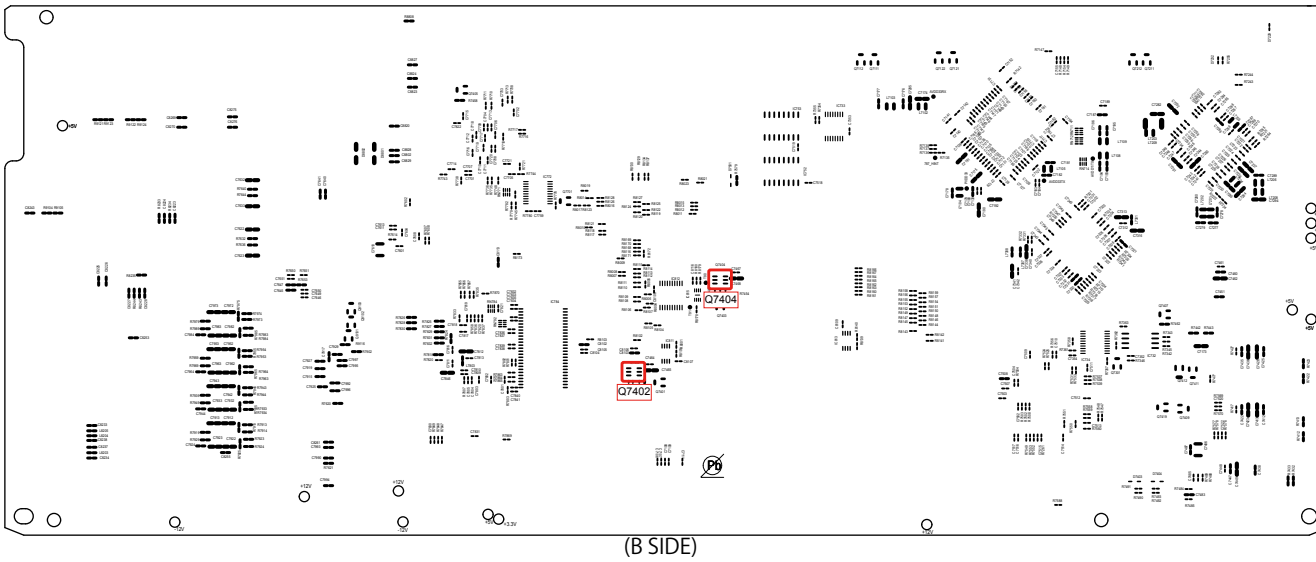
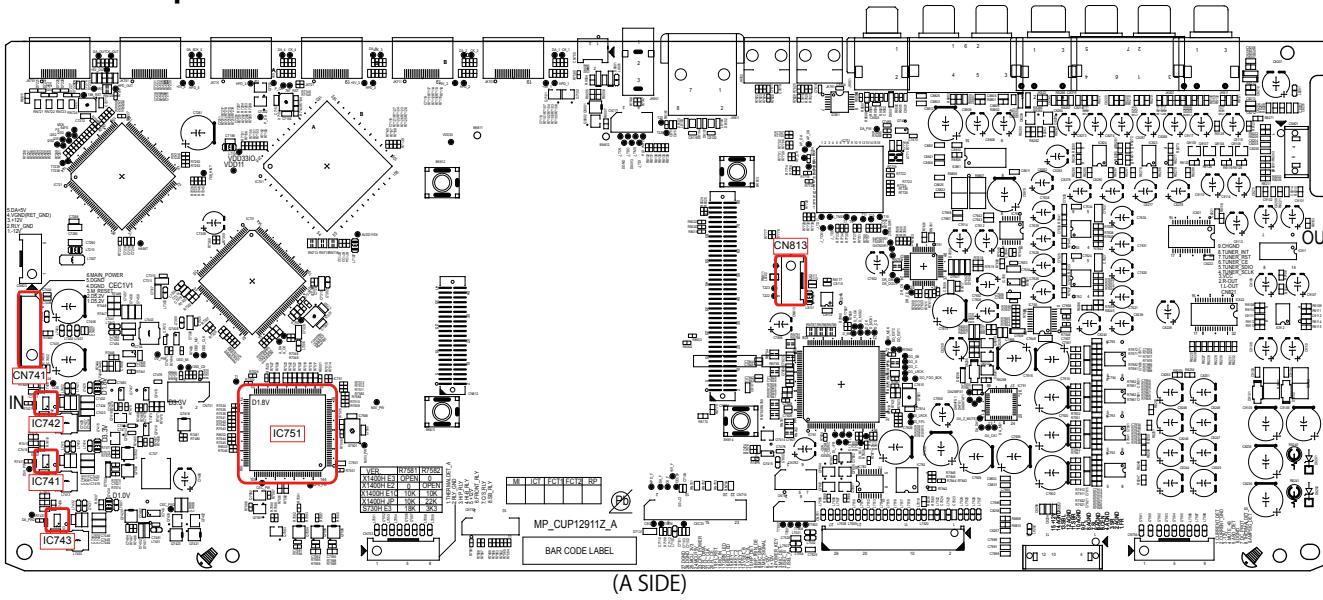

## USB test point

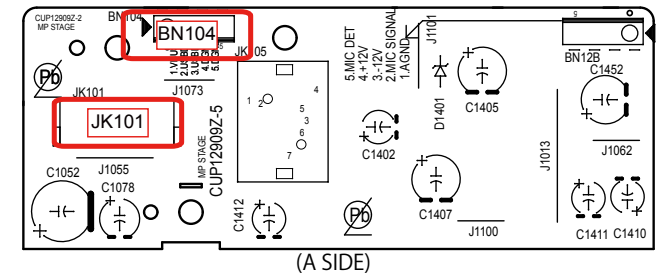

# 6. SMPS

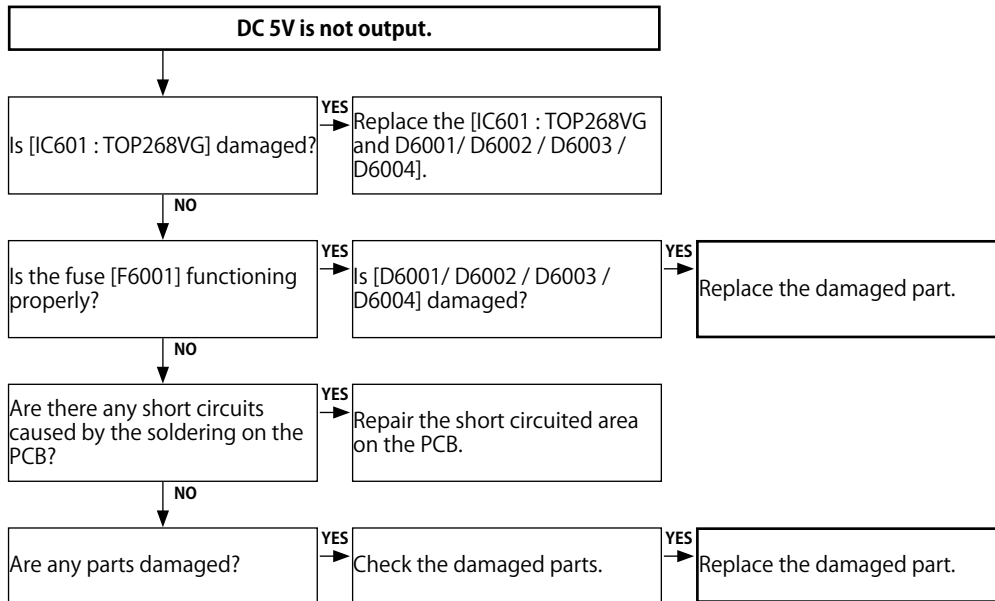

## Operation waveform for each part

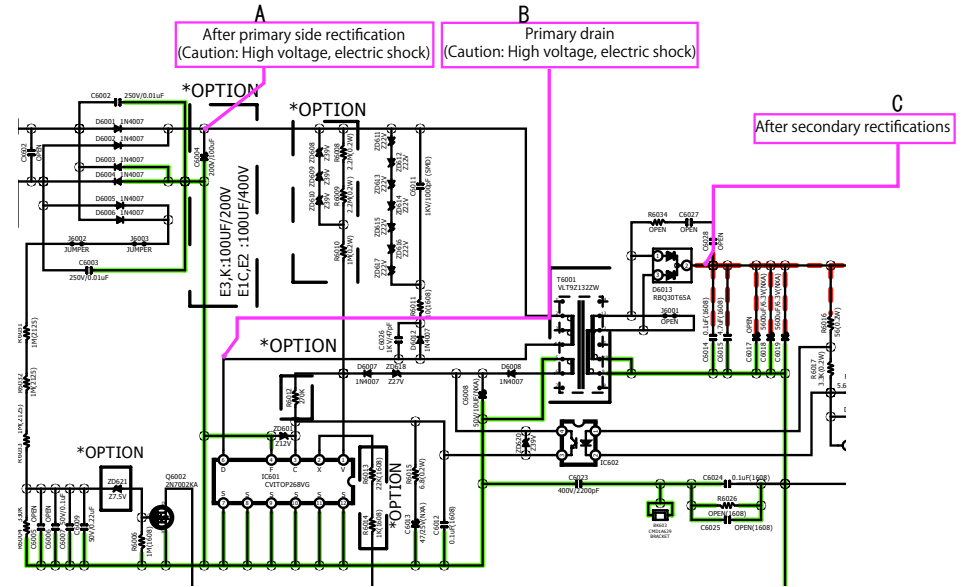

SMPS unit (Unloaded)

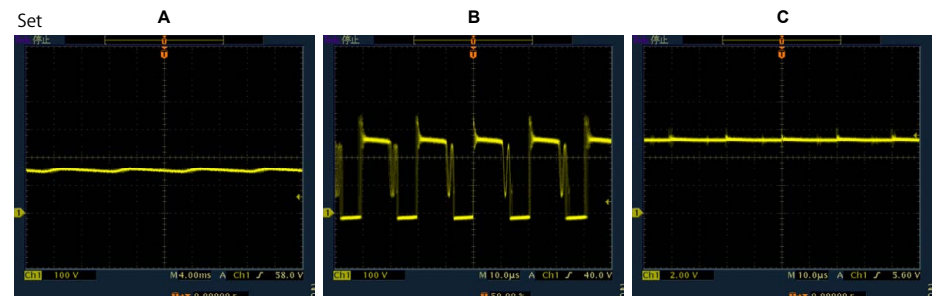
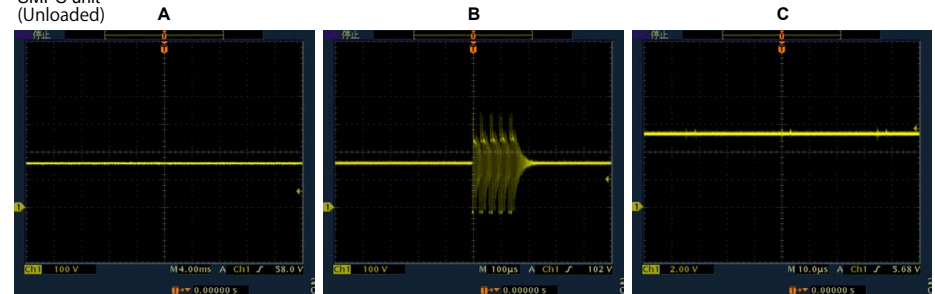

Caution in servicing

Electrical

Mechanical

Repair Information

Updating

# HDMI "Rx/Tx" Failure Detection

## 1. Prior checking

Check item(0) : Checking the HDMI connector  
Checking the condition of the HDMI pin (rear/front).

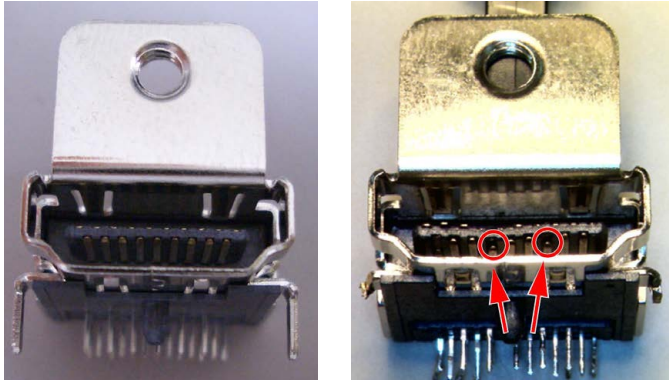

OK

NG

Check for deformed pins.

None of the pins are deformed.

There are deformed pins.

Replace the HDMI connector.

Check by following the flow chart for "3. Starting detecting the point of failure".

NOTE :

After checking troubleshooting "3. HDMI/DVI", check "3. Starting detecting the point of failure".

## 2. Preparations for checking HDMI Switcher reception/transmission register

### 2-1. Necessary devices

- 1) Check the product settings.
- 2-a) Player with an HDMI terminal
- 2-b) TV with an HDMI terminal (\* NOTE : Do not use a computer monitor.)
- 3) Windows PC
- 4) Serial communication software "termite.exe"  
(Download the software from [http://www.compuphase.com/software\\_termite.htm](http://www.compuphase.com/software_termite.htm) and install it.)
- 5) HDMI cable
- 6) RS-232C Straight cable
- 7) 8U-2120100S WRITING KIT
- 8) oscilloscope

### 2-2. Device Connection Method

Connect the TV and the AVR to the player using an HDMI cable and connect the AVR to the PC through an RS-232C cable as shown in Figure 1.

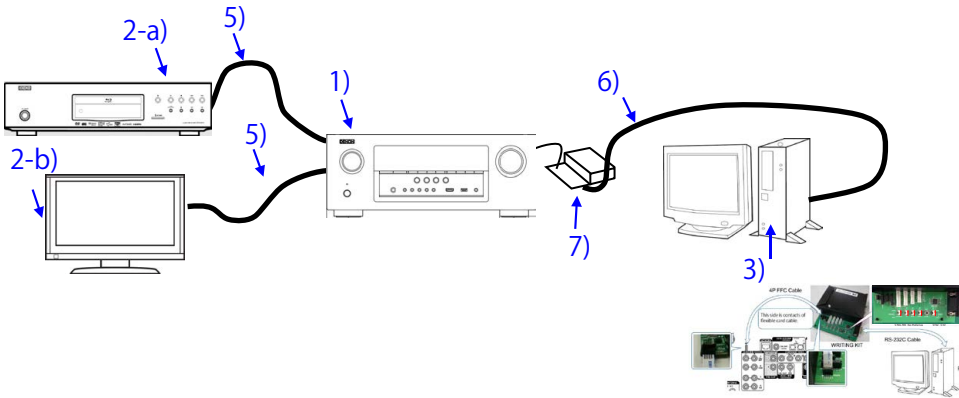

Figure 1 Device Connection Method (AVR-X1400H/S730H)

### 2-3. Device configuration method

PC settings : Execute the serial communication program, Termite.exe.

After executing Termite.exe, click [Settings].

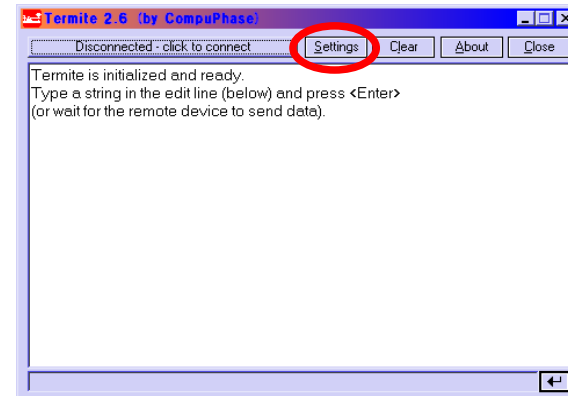

Figure 2 Screen After Executing Termite.exe

The serial port setup screen will be displayed. Configure the settings as shown in Figure 3 and click the "OK" button.

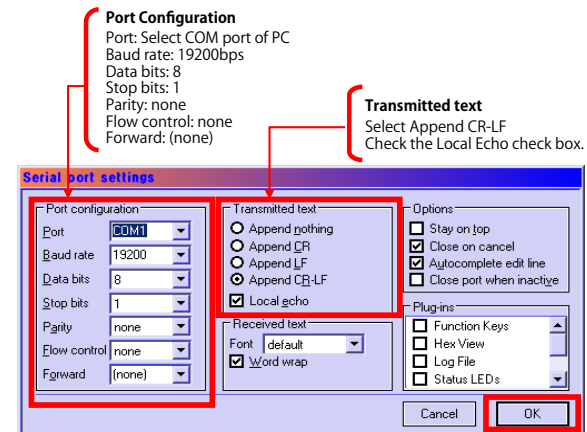

Figure 3 Serial Port Setup Screen

Click the [click to connect] button to start communication.  
 After a connection is established successfully, the display of the button name will change as shown in Figure 4.

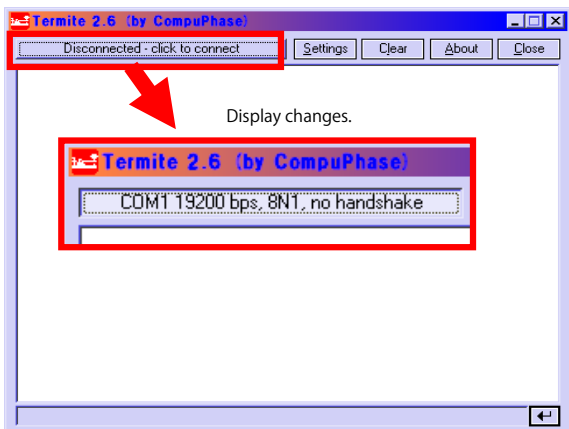

Figure 4 Change of the Display of the Communication Start Button Name

TV settings : Switch to the HDMI input in the AVR connection.  
 Player settings : Turn the unit power on and configure it to play disks.  
 AVR settings : While the power is On, hold down buttons "**PRESET UP**" and "**ZONE2 SOURCE**" for at least 3 seconds.  
 (Continue to press and hold the buttons until all segments of the FLD volume illuminate.)  
 ※ When the power is turned on after initialization, "**Setup Assistant**" will be displayed.  
 After exiting "**Setup Assistant**" execute the above.

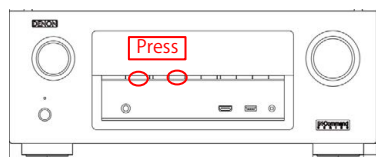

Figure 6-1. AVR settings (AVR-X1400H)

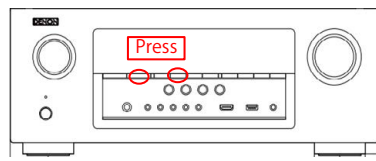

Figure 6-2. AVR settings (AVR-S730H)

for Volume 7 segment  
 All the indicator Lights



Figure 6 FLD Display When Set

When the settings are correct, the following message will be displayed in the window of Termite.

```
[00]Start Sub CPU Log Mode
****
(**** is a version of Sub CPU.)
```

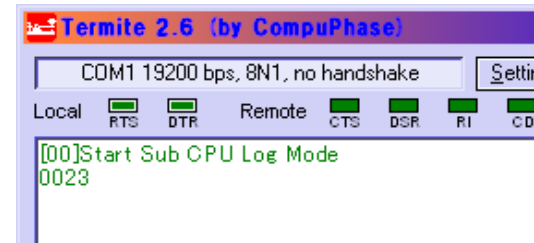

Figure 7 Display of Termite When AVR is Set

The setup is now complete.

Method for sending commands

Enter the command in the transmission command entry section, click the [Send] button and send the command.

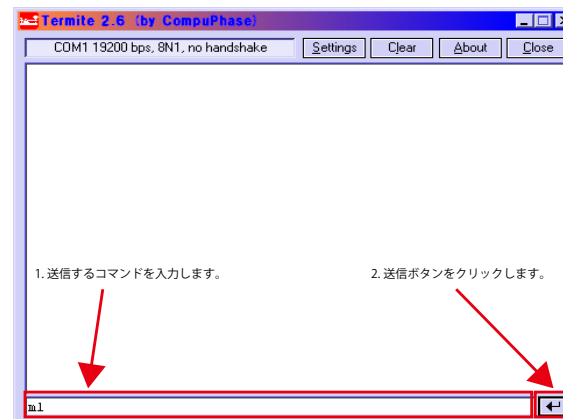

Figure 8 Method for Sending Termite Commands

### 3. Starting detecting the point of failure

#### Check item(1).

Check the power supply status and communication status with the CPU of each device.  
Start in HDMI Diagnostics mode and follow the procedures below.

#### (1) Start in HDMI Diagnostics mode

While the power is on, hold down buttons "TUNER PRESET CH -" and "ZONE2 SOURCE" for at least 3 seconds.

HDMI DIAGNOSTICS

↓ "HDMI DIAGNOSTICS" is displayed.

When the mode has switched, start Hardware check.

Hardwarecheck...

↓

#### (2-1) Display when an Error Code is displayed.

Err: H1-XX

↓↑ Alternating display.

Contact support

Check the Error Code table items.

#### Error Code table

Error Code	Check item No.	Description
H1-01	<a href="#">Check item (5)</a>	Communication Error with HDMI RX/Tx [IC721 : MN864788]
H1-02	<a href="#">Check item (10)</a>	Communication Error with HDMI SW [IC701 : MN864787]
H1-07	<a href="#">Check item (12)</a>	Communication Error with OSD [IC731 : ADV7623]
H1-08	<a href="#">Check item (19)</a>	Communication Error with DSP [IC781 : CS49844A]
H1-12	<a href="#">Check item (24)</a>	Communication Error with DIR [IC761 : PCM9211]
H1-15	<a href="#">Check item (17)</a>	Communication Error with OSD ROM [IC733 : MX25L3206EMI/MX25L6406EMI]

#### (2-2) Display when an Error is not detected.

1 Auto Test

Cancel the mode, and proceed to [check item \(2\)](#).

Canceling the selected mode

Press the power button to exit off the power.

**Check item(2).** : Check operation of the HDMI input terminal.



When the HDMI input terminal of this device is connected to the player correctly, is sound heard from the speaker?

※ When checking, turn the AV amplifier on and off after checking the connection terminal with the player. (To set the same conditions during verification of operation)

Check that sound is heard from the input terminal of the HDMI 4/5.  
Use any of Dolby TrueHD/DTSHD MA/PCM 8ch for the playback audio format.

**NO**  
Is the "DIG" indicator illuminated on the FLD?  
When the "DIG" indicator is illuminated, the digital audio block is faulty.  
If the "DIG" indicator is not illuminated, go to **check item (29)**.  
(HDMI の Rx/Tx [MN864788] failure detection procedure)

Check that sound is heard from the input terminal of the HDMI 1 - 3.

**NO**  
Go to **check item (36)**  
(HDMI SW[MN864787] failure detection procedure)

Check that sound is heard from the input terminal of the FRONT AUX.

**NO**  
Go to **check item (44)**  
(Front HDMI Buffer IC [AD8195] failure detection procedure)

**Check item(3).** : Check operation of the HDMI output terminal.

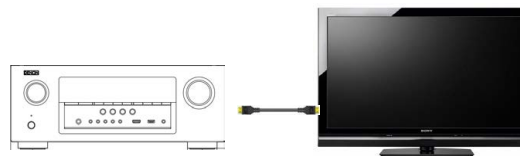

When the "SETUP" button on a remote control is pressed, is "MENU" displayed on TV which is connected to the HDMI output terminal on the AVR?

**NO**  
Go to **check item (52)**  
(OSD[ADV7623] failure detection procedure)

**Check item(4).** : Check operation of the HDMI output terminal.

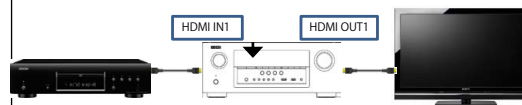

When the player is connected to the HDMI input terminals in order, are the images on the player displayed on the TV in both cases?

**NO**  
Go to **check item (61)**  
(Between HDMI Tx[MN864788]& OSD[ADV7623] failure detection procedure)

**YES**  
There is no problem with Rx, Tx, and GUI of HDMI as well as IC of SW.

### 3-1. Error Code H1-01 failure detection procedure

Checking device. (HDMI Rx/Tx)

Check the power supply voltage. (HDMI Rx/Tx)

**Check item(5).** Check the power supply voltage. :  
Does the power supply voltage of the HDMI Rx/Tx [IC721] indicate the correct voltage (1.1V, 3.3V)?  
The test points are as follows.

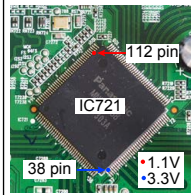

YES

NO

**Check item(6).** Check the power supply voltage. :  
Check the power components [IC741, IC744, Q7417] and the pattern on the substrate.  
If there is no problem, remove the HDMI Rx/Tx [IC721] from the substrate and measure the voltage at the test point of **check item (5)**.  
Is the voltage correct (1.1 V or 3.3 V)?

YES

NO

Replace with a new device.

The power supply circuit is faulty.  
Replace the PCB.

Recheck from **check item (1)**.  
If it does not work, replace the PCB.

Checking the reset waveform. (HDMI Rx/Tx)

**Check item(7).** Checking the reset waveform :  
Check the waveform.  
When the power is turned on, is the TP[788\_RST] waveform correct (as shown in the figure)?

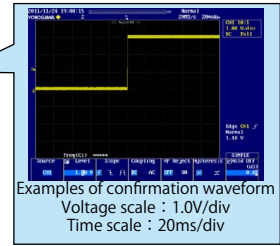
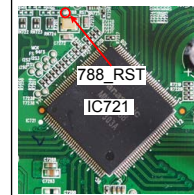

NO

Check the reset circuit between CPU [IC751] and HDMI Rx/Tx [IC721].  
If there is no problem, the HDMI Rx/Tx [IC721] is faulty.  
Replace with a new device.  
Recheck from **check item (1)**.  
If it does not work, replace the PCB.

YES

Go to next page.

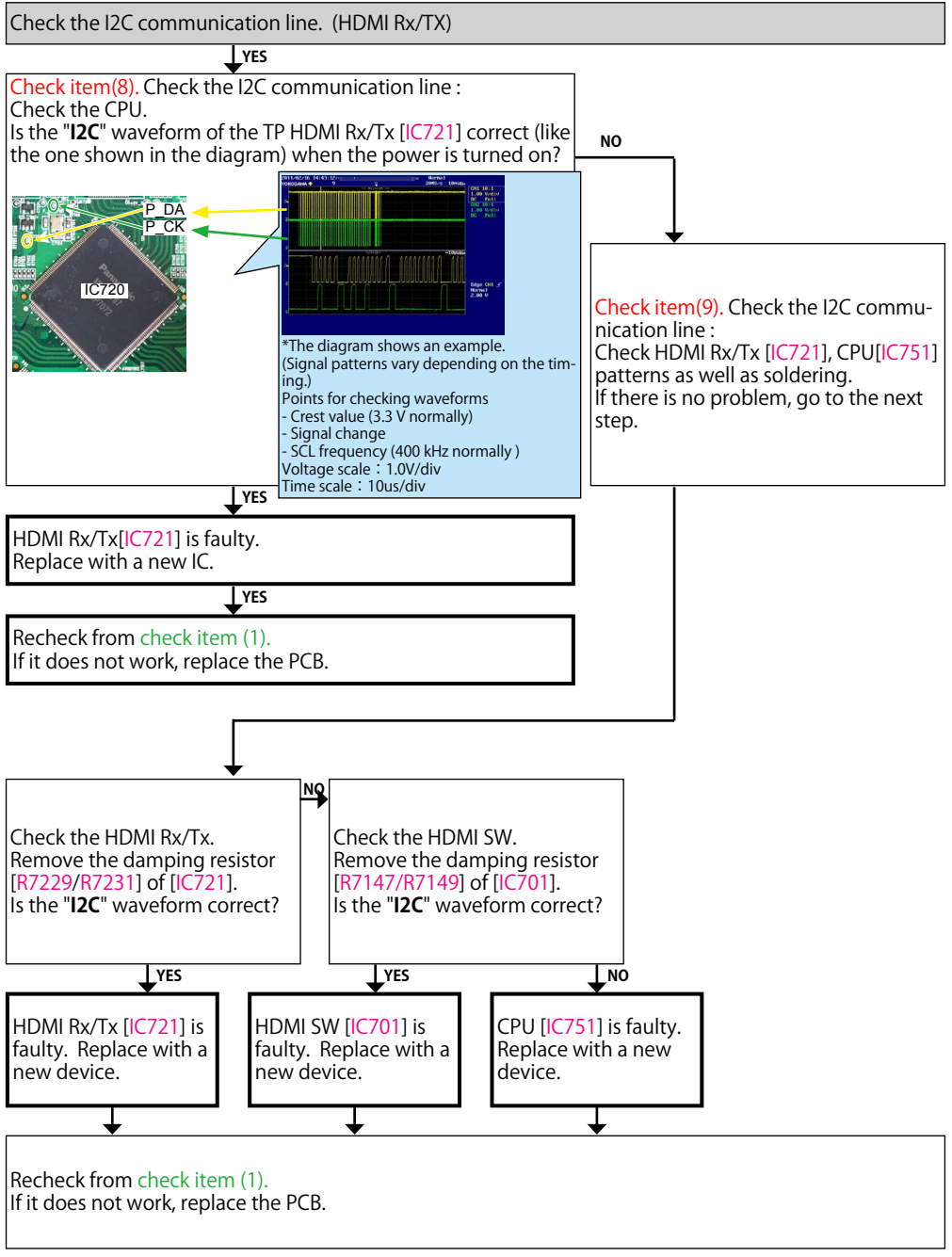

## 3-2. Error Code H1-02 failure detection procedure

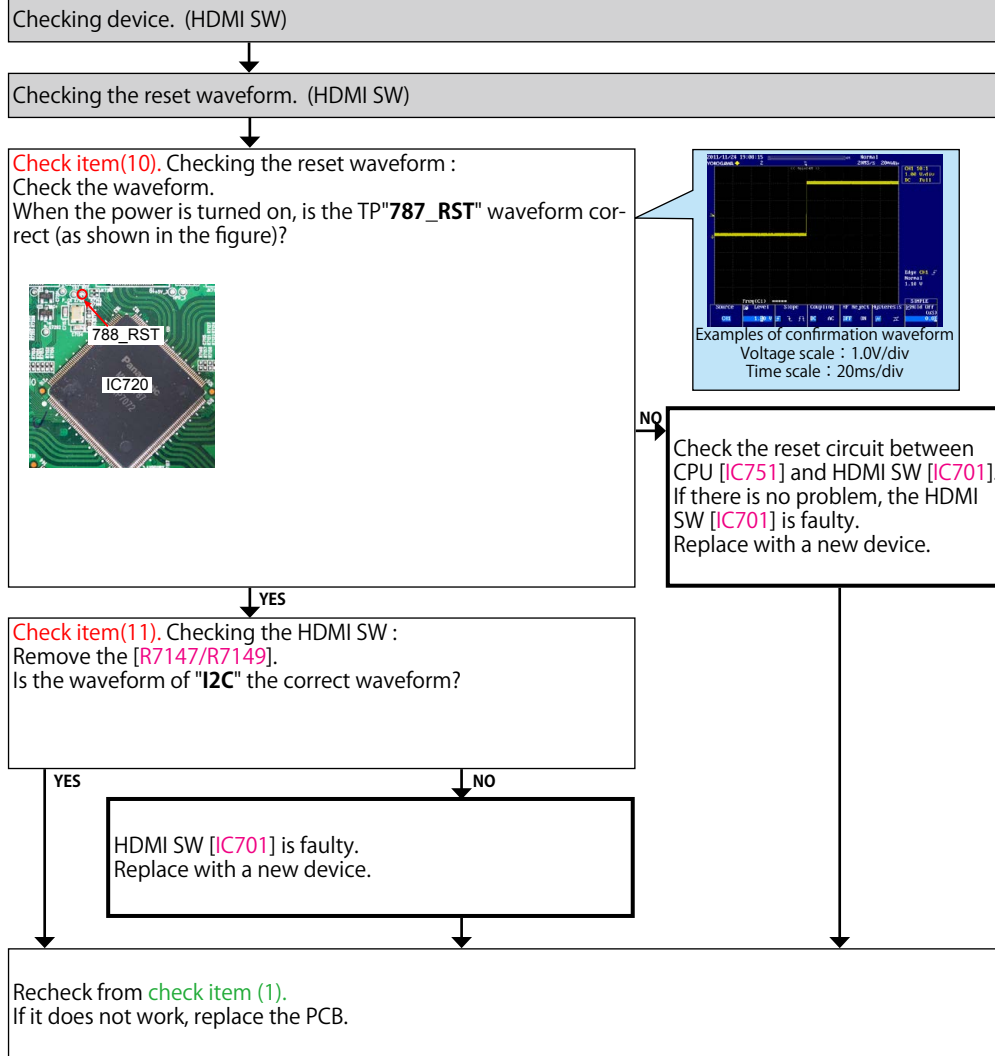

### 3-3. Error Code H1-07 failure detection procedure

Checking device. (OSD)

Check the power supply voltage.

**Check item(12).** Check the power supply voltage.  
 Does the power supply voltage of the OSD [IC731] indicate the appropriate voltage (1.8V, 3.3V)?  
 The test points are as follows.

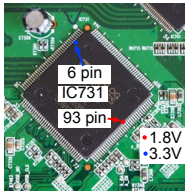

**Check item(13).** Check the power supply voltage.  
 Check the power supply components [IC742, Q7408, IC741, Q7410] on the substrate and peripheral pattern.  
 If there is no problem, remove the OSD [IC731] from the substrate and measure the voltage at the test point of **check item (12)**.  
 Is the voltage correct (1.8 V or 3.3 V)?

YES

YES

NO

The power supply circuit is faulty.  
 Replace the PCB.

HDMI OSD [IC731] is faulty.  
 Replace with a new device.

Recheck from **check item (1)**.  
 If it does not work, replace the PCB.

Checking the reset waveform.

**Check item(14).** Checking the reset :  
 Check the CPU.  
 When the power is turned on, is the TP "A\_RST" waveform correct (as shown in the figure)?

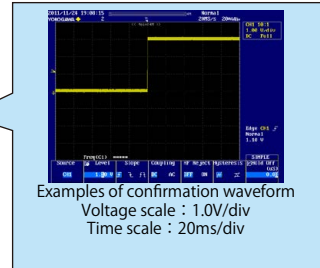
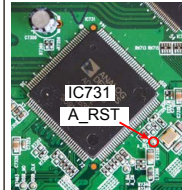

YES

NO

Check the reset circuit between CPU [IC751] and HDMI OSD [IC731].  
 If there is no problem, the HDMI OSD [IC731] is faulty.  
 Replace with a new device.

Recheck from **check item (1)**.  
 If it does not work, replace the PCB.

Go to next page.

Check the I2C communication line.

↓ YES

**Check item(15).** Check the I2C communication line :  
Check the CPU.  
Is the "I2C" waveform of the HDMI OSD [IC731] correct (like the one shown in the diagram) when the power is turned on?

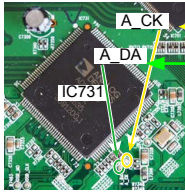

\*The diagram shows an example.  
(Signal patterns vary depending on the timing.)  
Points for checking waveforms  
- Crest value (3.3 V normally)  
- Signal change  
- SCL frequency (400 kHz normally )  
Voltage scale : 1.0V/div  
Time scale : 10us/div

↓ YES      ↓ NO

**Check item(16).** Check the I2C communication line :  
Check HDMI OSD [IC731], CPU[IC751] patterns as well as soldering.  
If there is no problem, go to the next step.

Check the HDMI Rx.  
Remove the damping resistor [R7323/R7324] of [IC731].  
Is the "I2C" waveform correct?

NO → CPU [IC751] is faulty. Replace with a new device.

↓ YES  
OSD[IC731] is faulty.  
Replace with a new device.

Recheck from **check item (1)**.  
If it does not work, replace the PCB.

### 3-4. Error Code H1-15 failure detection procedure

Checking device. [IC732 : MX25L3206EMI(E3, E1C, K)/MX25L6406EMI(E2)]

**Check item(17).**  
Write to the OSD ROM.  
Recheck from **check item (1)**  
Does Error Code H1-15 continue?

NO

YES

**Check item(18).**  
Replace [IC732] with a new device.  
Recheck from **check item (1)**  
Does Error Code H1-15 continue?

NO

YES

Go to **check item (12)**

Recheck from **check item (2).**

### 3-5. Error Code H1-08 failure detection procedure

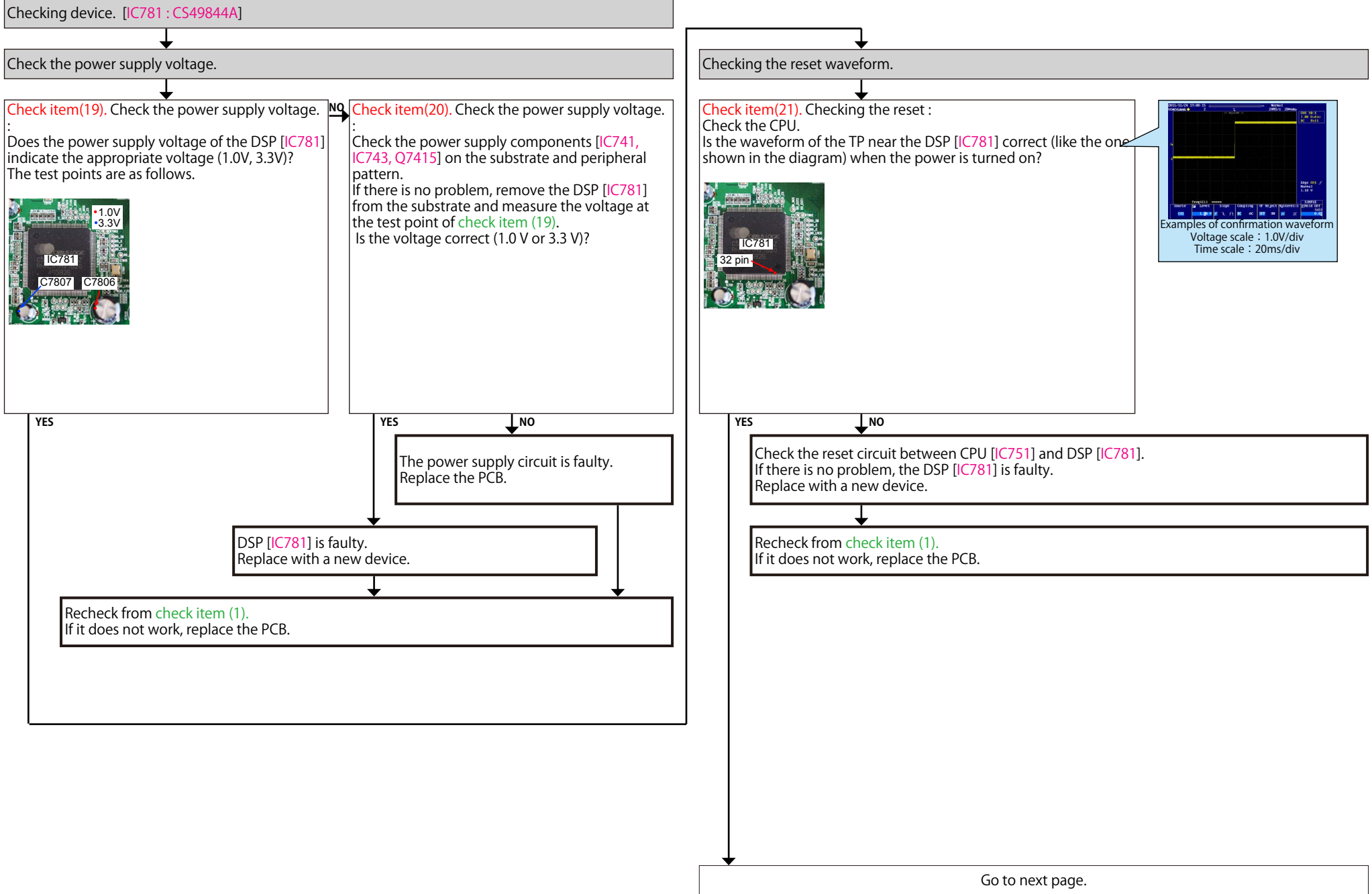

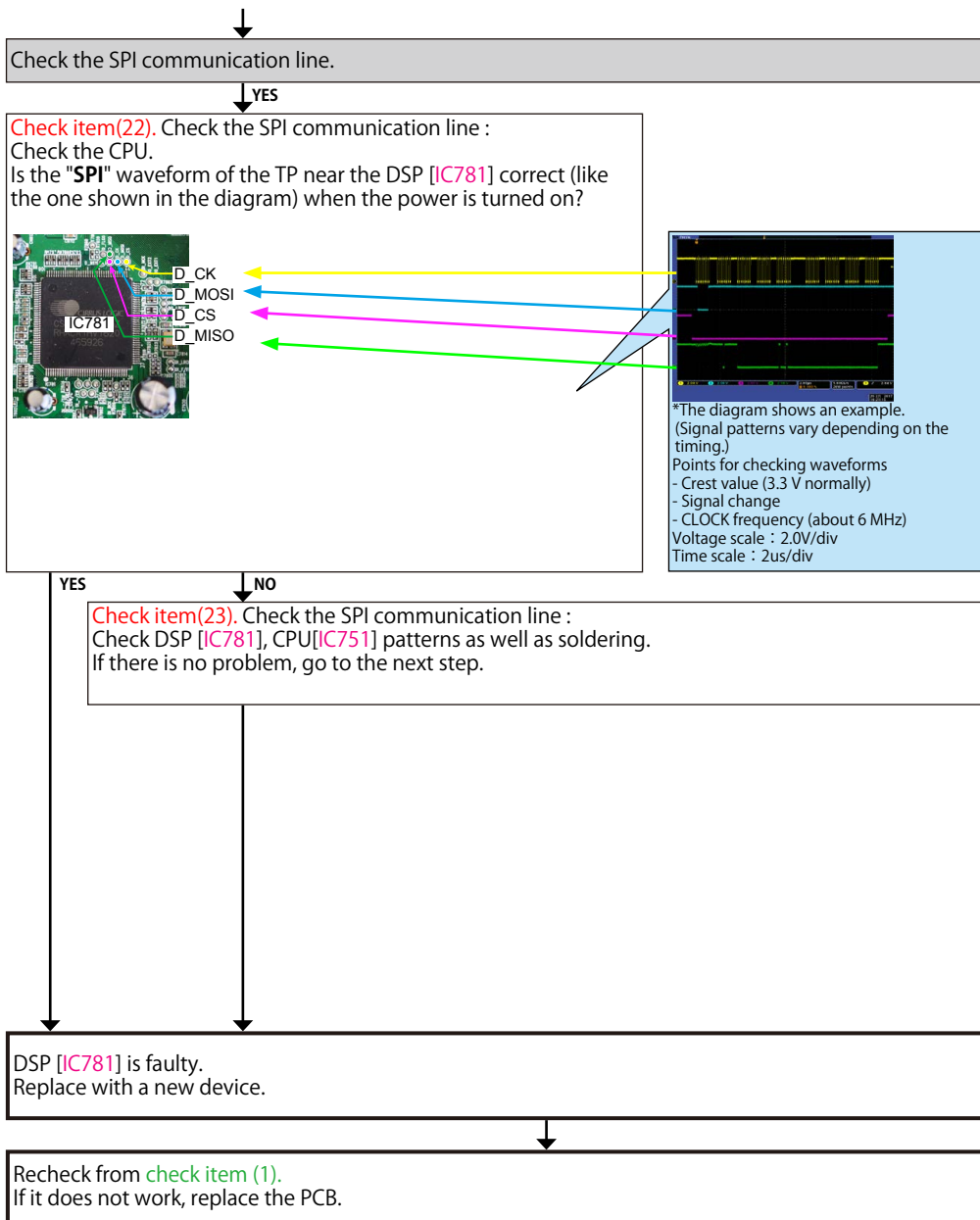

### 3-6. Error Code H1-12 failure detection procedure

Checking device. [IC761 : PCM9211]

Check the power supply voltage.

**Check item(24).** Check the power supply voltage.  
: Does the power supply voltage of the DIR [IC761] indicate the appropriate voltage (3.3V)? The test points are as follows.

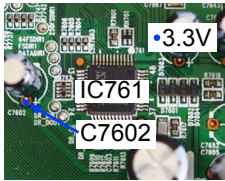

**Check item(25).** Check the power supply voltage.  
: Check the power supply components [IC741, Q7415] on the substrate and peripheral pattern. If there is no problem, remove the DIR [IC761] from the substrate and measure the voltage at the test point of **check item (24)**. Is the power supply voltage correct (3.3 V)?

YES

YES

NO

The power supply circuit is faulty.  
Replace the PCB.

DIR [IC761] is faulty.  
Replace with a new device.

Recheck from **check item (1)**.  
If it does not work, replace the PCB.

Checking the reset waveform.

**Check item(26).** Checking the reset :  
Check the CPU.  
When the power is turned on, is the DIR [IC761 : 34pin] waveform correct (as shown in the figure)?

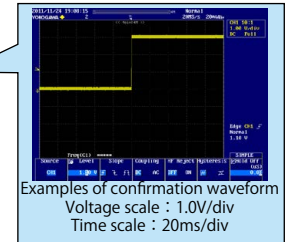
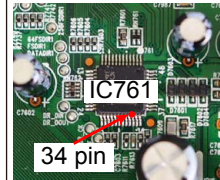

YES

NO

Check the reset circuit between CPU [IC751] and DIR [IC761].  
If there is no problem, the DIR [IC761] is faulty.  
Replace with a new device.

Recheck from **check item (1)**.  
If it does not work, replace the PCB.

Go to next page.

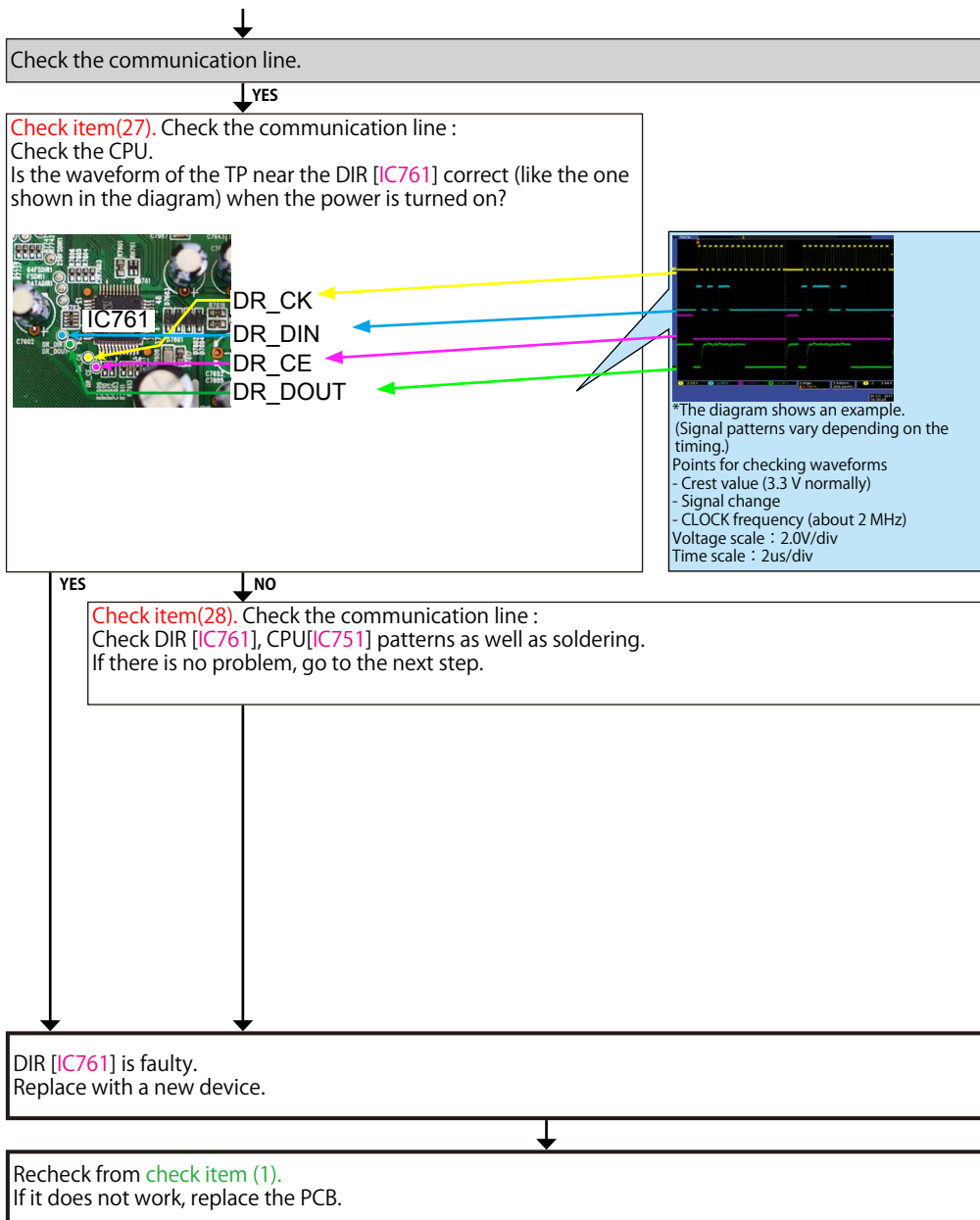

### 3-7. HDMI Rx/Tx [MN864788] failure detection procedure

Checking operation between the HDMI (Rx/Tx) device and the player



※ In order to check, connect the player to the HDMI terminal and configure the player as AVR source. Check the sound output while turning on the player.

Checking the +5V/DDC status register (HDMI Rx/Tx)

**Check item(29).** Checking the 5V status register :  
Send the following command from Termit.exe.

Send the command "i 0006 00FF 0001".

Move to the branch destination according to the value returned.

Example

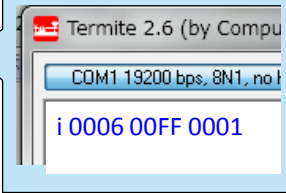

HDMI in 4/5 "00"  
(Detection of 5V is not OK.)

Go to **check item (31)**

HDMI In4 "22 or 20" HDMI In5 "11 or 10"  
(Detection of 5V is OK)

**Check item(30).** Checking the +5V/DDC status register :  
Send the following command from Termit.exe.

Case of HDMI IN4

Send the command "i 0003 0054 0001".

Case of HDMI IN5

Send the command "i 0003 0024 0001".

Move to the branch destination according to the value returned.

Example

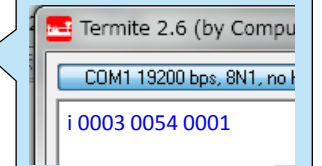

"00 or 04"  
(Detection of DDC is not OK.)

Go to **check item (32)**

"22"  
(Detection of DDC is OK)

Go to **check item (33)**

When the results of check item (29) are "00"  
(Detection of 5V is not OK)

Check the +5V voltage. (HDMI Rx/Tx)

Check item(31). Check the +5V voltage.  
Does "+5V" at the following test point indicate 5 V? [JK731/JK741]

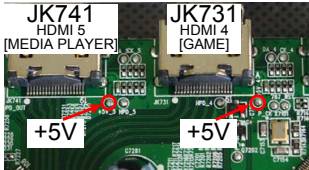

YES

HDMI Rx/Tx[IC721] is faulty.  
Replace with a new device.

NO

Check for a short circuit in the 5 V line and the 5 V Switch IC [IC733].  
If there is no problem, the HDMI Rx/Tx [IC721] or the 5 V Switch IC [IC733] is faulty  
Replace with a new device.

Recheck from check item (2).  
If it does not work, replace the PCB.

When the results of check item (30) are "00 or 04"  
(Detection of DDC is not OK.)

Check the DDC line. (HDMI Rx/Tx)

Check item(32). Check the DDC line :  
Are waveforms of "DDCSCK" and "DDCSDA" observed at the test point near the HDMI input terminal?

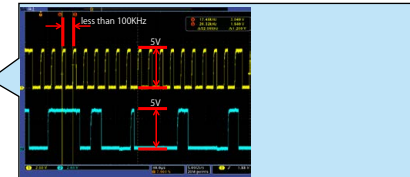
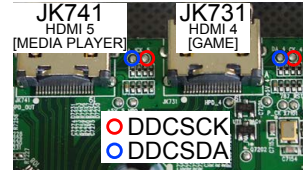

This diagram shows an example of the DDC communication waveform.  
-The high level voltage is 5V.  
-The frequency of the DDC CLK is 100 KHz or less.  
Check at each test point.  
Voltage scale : 2.0V/div  
Time scale : 40us/div

YES

HDMI Rx/Tx[IC721] is faulty.  
Replace with a new device.

NO

Check for a short circuit in the DDC line.  
If there is no problem, the HDMI Rx/Tx [IC721] is faulty.  
Replace with a new device.

Recheck from check item (2).  
If it does not work, replace the PCB.

When the results of check item (30) are "22"  
(Detection of DDC is OK.)

Checking the TMDS status register

**Check item(33).** Checking register of the TMDS CLK detection status register:  
Send the following command from Termite.exe.  
HDMI Rx/Tx  
Send the command "i 0006 00FF 0001".  
When the following value is returned, go to Yes.  
HDMI In4 "22" HDMI In5 "11"  
When the following value is returned, go to No.  
HDMI In4 "20" HDMI In5 "10"

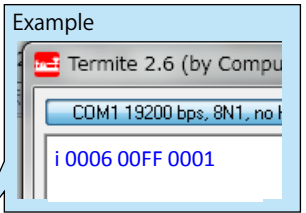

YES

**Check item(35).** Checking the audio signal output:  
Check the audio signal waveform at the following test point.  
Is the waveform like the sample?



129/131/132/133/134/135/136pin

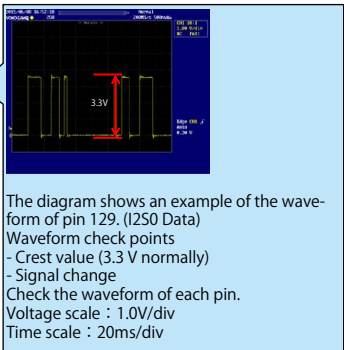

YES

The digital audio block is faulty.  
Check the digital audio device.  
Check "AUDIO" in troubleshooting.  
If it does not work, replace the PCB.

NO

HDMI Rx/Tx[IC721] is faulty.  
Replace with a new device.

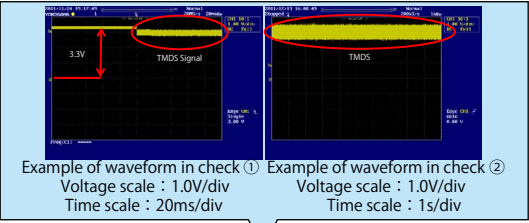

**Check item (34).** Checking the TMDS input waveform. :  
Check the TMDS waveform at the following test point.  
Is the waveform like the sample?

HDMI In4  
80/81/83/84/86/87/89/90pin  
HDMI In5  
93/94/96/97/99/100/102/103pin

YES

HDMI Rx/Tx[IC721] is faulty.  
Replace with a new device.

NO

Check for a short circuit in the pattern of the TMDS line of the HDMI Rx/Tx [IC721] from the HDMI input terminal.  
If there is no problem, the HDMI Rx/Tx [IC721] is faulty. Replace with a new device.

Recheck from **check item (2)**.  
If it does not work, replace the PCB.

### 3-8. HDMI SW [MN864787] failure detection procedure

Checking operation between the HDMI (HDMI SW) device and the player



※ In order to check, connect the player to the HDMI terminal and configure the player as AVR source. Check the sound output while turning on the player.

Checking the +5V/DDC status register (HDMI SW)

**Check item(36).** Checking the 5V status register :  
Send the following command from Termite.exe.

Send the command "i 002E 00FF 0001".

Move to the branch destination according to the value returned.

Example

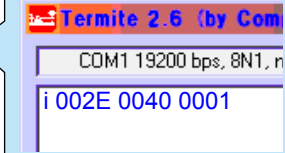

HDMI In1/In2/In3 "00"  
(Detection of 5V is not OK.)

Go to **check item (38)**

HDMI In1 "44 or 40" HDMI In2 "22 or 20" HDMI In3 "11 or 10"  
(Detection of 5V is OK)

**Check item(37).** Checking the DDC status register :  
Send the following command from Termite.exe.

Case of HDMI IN1  
Send the command "i 002B 0084 0001".

Case of HDMI IN2  
Send the command "i 002B 0054 0001".

Case of HDMI IN3  
Send the command "i 002B 0054 0001".

Move to the branch destination according to the value returned.

Example

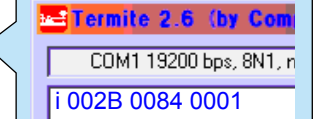

"00 or 04"  
(Detection of DDC is not OK.)

Go to **check item (39)**

"22"  
(Detection of DDC is OK)

Go to **check item (40)**

When the results of check item (36) are "00"  
(Detection of 5V is not OK)

Check the +5V voltage. (HDMI SW)

Check item(38). Check the +5V voltage :  
Does "+5V" at the following test point indicate 5 V? [JK701/JK711/JK721]

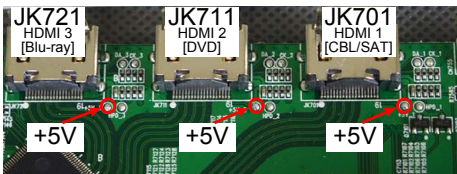

YES

HDMI SW [IC701] is faulty.  
Replace with a new device.

NO

Check for a short circuit in the 5 V line and the 5 V Switch IC [IC733].  
If there is no problem, the HDMI SW [IC701] is faulty.  
Replace with a new device.

Recheck from check item (2).  
If it does not work, replace the PCB.

When the results of check item (37) are "00 or 04"  
(Detection of DDC is not OK.)

Check the DDC line. (HDMI SW)

Check item(39). Check the DDC Line/HPD line :  
Are waveforms of "DDCSCK" and "DDCSDA" observed at the test point near the HDMI input terminal [JK701/JK711/JK721]?

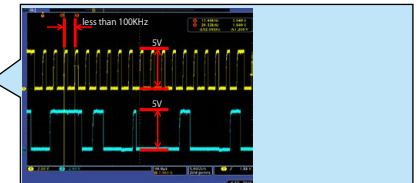
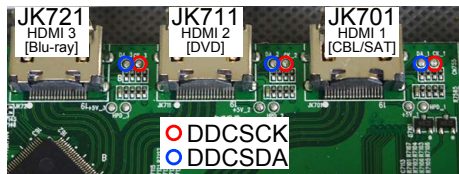

This diagram shows an example of the DDC communication waveform.  
-The high level voltage is 5V.  
-The frequency of the DDC CLK is 100 KHz or less.  
Check at each test point.  
Voltage scale : 2.0V/div  
Time scale : 40us/div

YES

HDMI SW [IC701] is faulty.  
Replace with a new device.

NO

Check for a short circuit in the DDC line.  
If there is no problem, the HDMI SW [IC701] is faulty.  
Replace with a new device.

Recheck from check item (2).  
If it does not work, replace the PCB.

Caution in servicing

Electrical

Mechanical

Repair Information

Updating

When the results of check item (37) are "22"  
(Detection of DDC is OK.)

Checking the TMDS status register (HDMI SW)

**Check item(40).** Checking register of the TMDS CLK detection status register :  
Send the following command from Termite.exe.  
HDMI Rx/Tx  
Send the command "i 002E 00FF 0001".  
When the following value is returned, go to Yes.  
HDMI In1 "44" HDMI In2 "22" HDMI In3 "11"  
When the following value is returned, go to No.  
HDMI In1 "00" HDMI In2 "00" HDMI In3 "00"

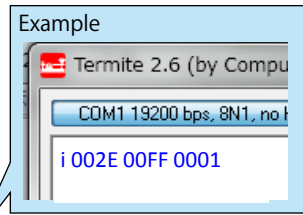

NO

Checking the TMDS status register (HDMI SW -> HDMI Rx/Tx)

**Check item(42).** Checking register of the TMDS CLK detection status register :  
Send the following command from Termite.exe.  
Send the command "i 0006 00FF 0001".  
When the following value is returned, go to Yes.  
"CC or 44"  
When the following value is returned, go to No.  
"other"

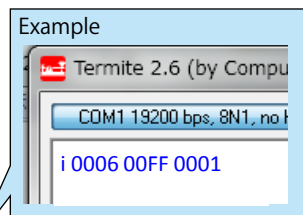

**Check item (43).** Checking the TMDS input waveform. :  
Check the TMDS waveform at the following test point.  
Is the waveform like the sample?

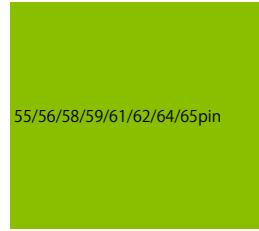
  
Example of waveform in check 2: TMDS, Voltage scale: 1.0V/div, Time scale: 1s/div" data-bbox="375 685 485 825"/>

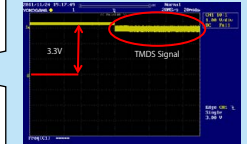
HDMI Rx/Tx[IC721] is faulty.  
Replace with a new device.

HDMI SW [IC701] is faulty.  
Replace with a new device.

  
Example of waveform in check ① Voltage scale : 1.0V/div Time scale : 20ms/div  
Example of waveform in check ② Voltage scale : 1.0V/div Time scale : 1s/div

**Check item (41).** Checking the TMDS input waveform. :  
Check the TMDS waveform at the following test point.  
Is the waveform like the sample?

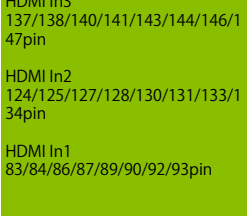
HDMI SW [IC701] is faulty.  
Replace with a new device.

Check for a short circuit in the pattern of the TMDS line of the HDMI SW [IC701] from the HDMI input terminal.  
If there is no problem, the HDMI SW [IC701] is faulty.  
Replace with a new device.

Recheck from check item (2).  
If it does not work, replace the PCB.

### 3-9. Front HDMI Buffer IC [AD8195] failure detection procedure

Checking operation between the HDMI (Front HDMI Buffer) and the player



※ In order to check, connect the player to the HDMI terminal and configure the player as AVR source. Check the sound output while turning on the player.

Check the power supply voltage. (HDMI Buffer)

**Check item(44).** Check the power supply voltage. : Does the power supply voltage of the Front HDMI FFC base [CN710] indicate the correct voltage (5V)? The test points are as follows.

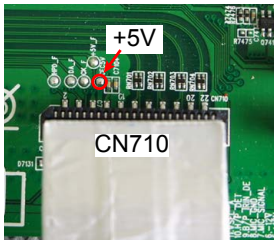

**YES** **Check item(45).** Check the power supply voltage. : Check the FETSW and peripheral pattern. If there is no problem, remove the Front HDMI FFC from the substrate and measure the voltage at the test point of **check item (44)**. Is the power supply voltage correct (5 V)?

**YES**  
Front HDMI Buffer [C811] is faulty. Replace with a new device.

**NO**  
Replace the FET SW[Q7413] and recheck from **check item (40)**. If it does not work, replace the PCB.

Recheck from **check item (2)**. If it does not work, replace the PCB.

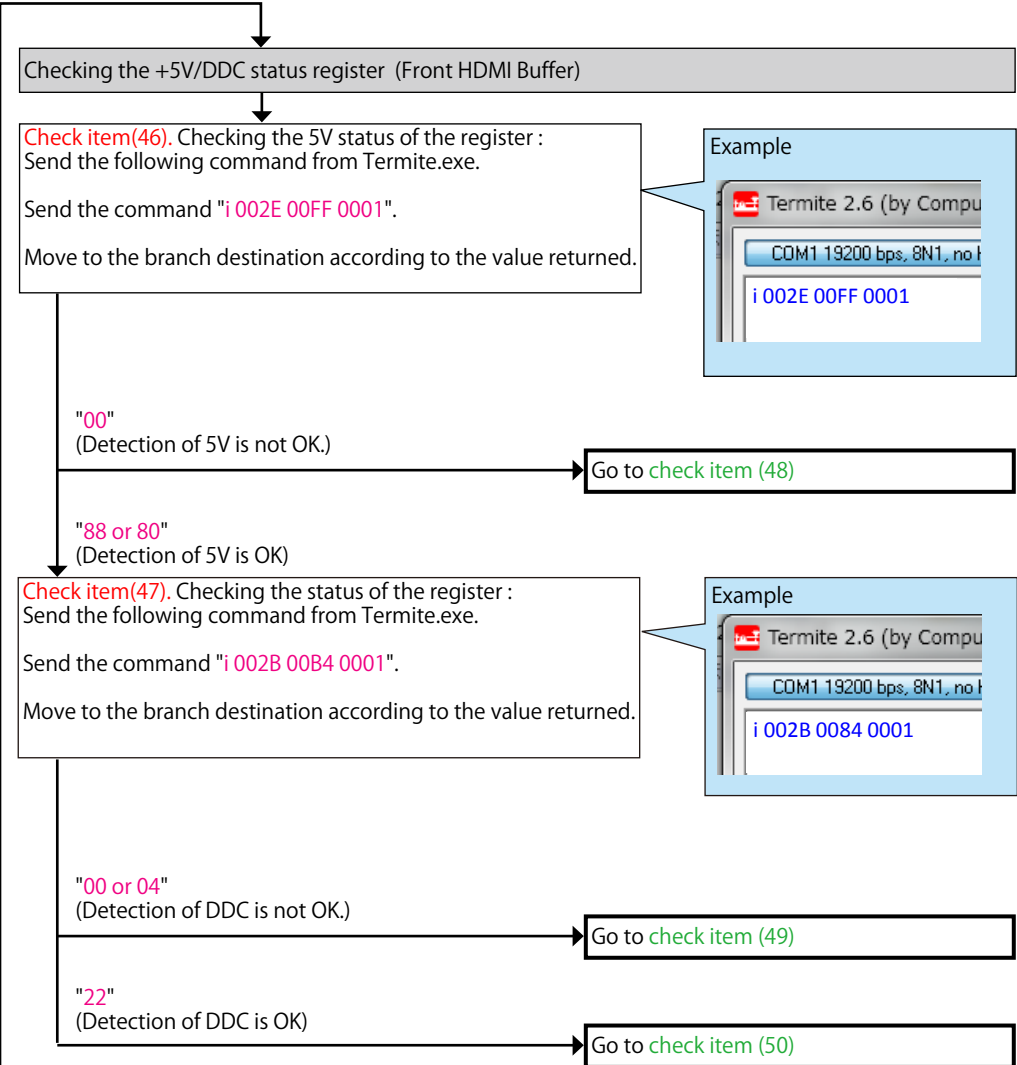

When the results of check item (46) are "00"  
(Detection of 5V is not OK.)

Check the +5V voltage. (Front HDMI Buffer)

Check item(48). Check the +5V voltage.  
Does "+5 V" at the following test point indicate 5 V?  
The test points are as follows. (HDMI SW[IC701]

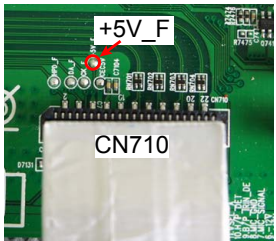

NO  
Check for a short circuit in the 5 V line, the Front HDMI FFC, and the 5V Switch [IC733].  
If there is no problem, the HDMI SW1[IC701] or 5VSwitch[IC733] is faulty.  
Replace with a new device.

YES  
HDMI SW [IC701] is faulty.  
Replace with a new device.

Recheck from check item (2).  
If it does not work, replace the PCB.

When the results of check item (47) are "00 or 04"  
(If the DDC are not OK)

Check the DDC Line. (Front HDMI Buffer)

Check item(49). Check the DDC line :  
Does "DDCCL" and "DDCDA" signal of the HDMI SW [IC701] indicate 5 V?  
The test points are as follows.

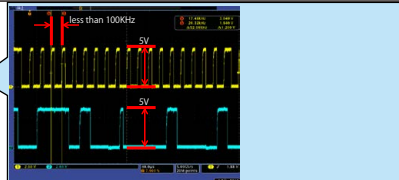
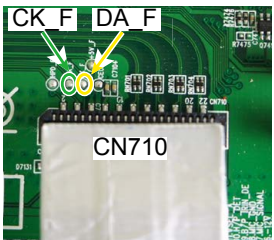

This diagram shows an example of the DDC communication waveform.  
-The high level voltage is 5V.  
-The frequency of the DDC CLK is 100 KHz or less.  
Check at each test point.  
Voltage scale : 2.0V/div  
Time scale : 40us/div

NO  
Check for a short circuit in the DDC line and check the Front HDMI FFC.  
If there is no problem, the Front HDMI Buffer [IC811] is faulty.  
Replace with a new device.

YES  
HDMI SW [IC701] is faulty.  
Replace with a new device.

Recheck from check item (2).  
If it does not work, replace the PCB.

Caution in servicing

Electrical

Mechanical

Repair Information

Updating

When the results of check item (47) are "22"  
(Detection of DDC is OK)

Checking the TMDS status register

**Check item(50).** Check the TMDS CLK detection status of the register.  
Send the following command from Termit.exe.  
Send the command "i 002E 00FF 0001".  
When the following value is returned, go to Yes.  
"88"  
When the following value is returned, go to No.  
"80"

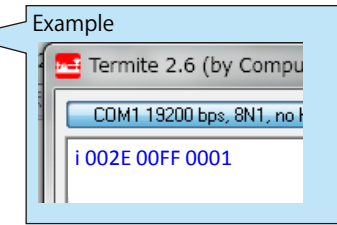

YES

NO

HDMI SW [IC701] is faulty.  
Replace with a new device.

HDMI SW [IC701] is faulty.  
Replace with a new device.

Check for a short circuit in the TMDS line and the Front HDMI FFC.  
If there is no problem, the Front HDMI Buffer [IC811] is faulty.  
Replace with a new device.

Recheck from **check item (2)**.  
If it does not work, replace the PCB.

**Check item (51).** Checking the TMDS input waveform. :  
Check the TMDS waveform at the following test point.  
Is the waveform like the sample?

HDMI SW[IC701]

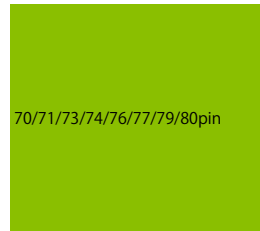
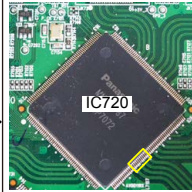

YES

NO

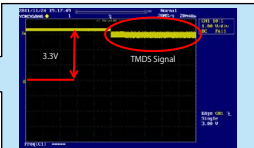

Example of waveform in check ①  
Voltage scale : 1.0V/div  
Time scale : 20ms/div

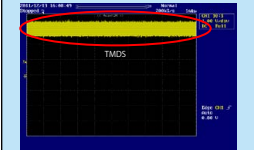

Example of waveform in check ②  
Voltage scale : 1.0V/div  
Time scale : 1s/div

### 3-10. OSD [ADV7623] failure detection procedure

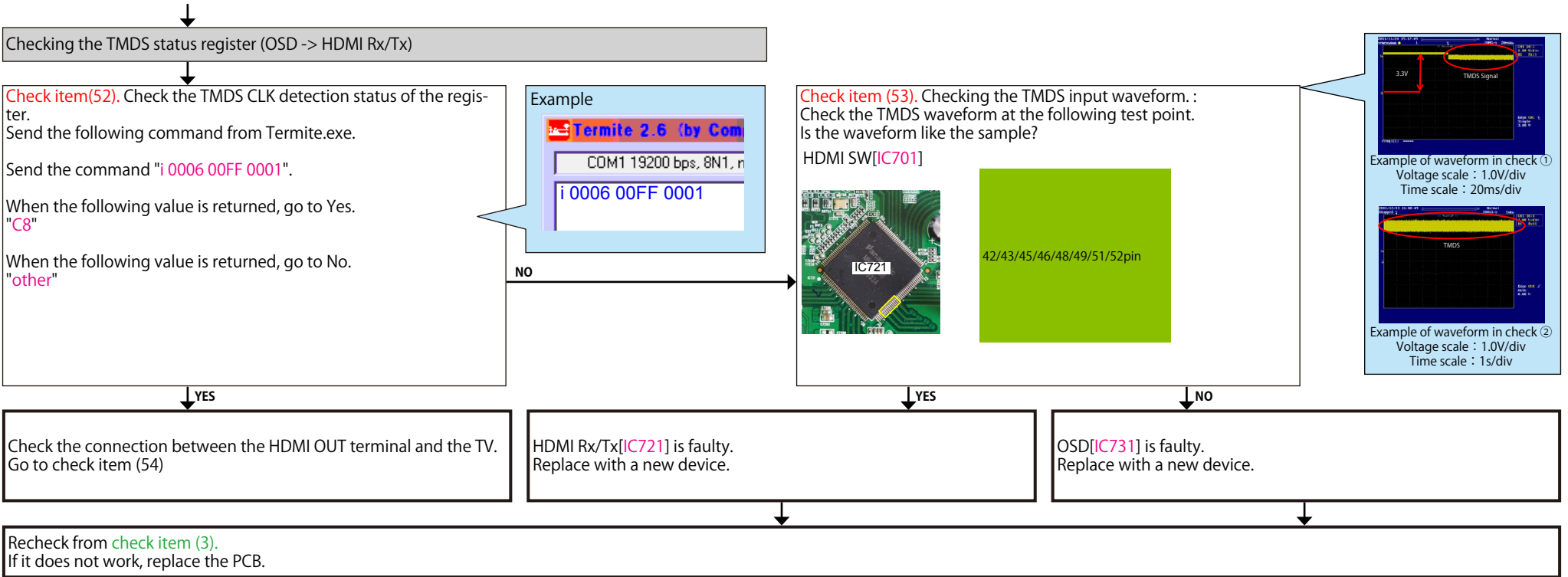

Check the connection between the HDMI OUT terminal and the TV.  
Connect the HDMI OUT terminal and the TV, and then turn on the TV and check the following items.

Checking the HPD/RXSENSE status register. (HDMI TX -> Monitor)

**Check item(54).** Check the HPD and RXSENSE register value of the HDMI TX device. :  
Send the following command from Termite.exe.  
Send the command "i 0000 0040 0001".  
Move to the branch destination according to the value returned.

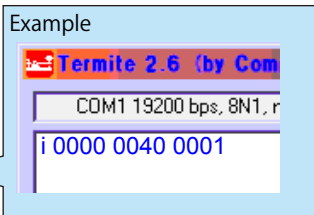

"30"  
(Detection of HPD is OK / Detection of RXSENSE is OK)

Go to **check item (55)**

"10"  
(Detection of HPD is OK / Detection of RXSENSE is not OK)

Go to **check item (58)**

"20"  
(Detection of HPD is not OK / Detection of RXSENSE is OK)

Go to **check item (59)**

"00"  
(Detection of HPD is not OK / Detection of RXSENSE is not OK)

Go to **check item (60)**

When the results of check item (54) are "30"  
 Detection of HPD is OK / Detection of RXSENSE is OK

Checking the EDID register. (Monitor)

**Check item(55).** Check the Monitor EDID :  
 ① Unplug the AC cord. Plug the AC cord into a power outlet.  
 ② Send the transmission command "m\_1" from Termite.exe.  
 Are the first eight bytes of the returned value "00FFFFFFFFF00"?

**Example**

The first eight bytes are normally "00FFFFFFFFF00".  
 \*If the AVR and the TV are not connected via HDMI, the correct register value cannot be verified.

YES

NO

**Check item(56).** Checking the TMDS :  
 Check the TMDS waveform at the following test point.

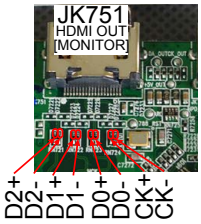

**Check item(57).** Check communication with the monitor :  
 Are waveforms of "DDCSCK" and "DDCSDA" observed at the test point near the HDMI output terminal [JK751]?

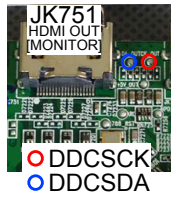

This diagram shows an example of the DDC communication waveform.  
 -The high level voltage is 5V.  
 -The frequency of the DDC CLK is 100 KHz or less.  
 Check at each test point.  
 Voltage scale : 2.0V/div  
 Time scale : 40us/div

YES NO

YES NO

Check for a short circuit in the TMDS line.  
 If there is no problem, the HDMI Rx/Tx (IC721) is faulty.  
 Replace with a new device.

HDMI Rx/Tx [IC721] is faulty.  
 Replace with a new device.

HDMI Rx/Tx [IC721] is faulty.  
 Replace with a new device.

HDMI Rx/Tx [IC721] is faulty.  
 Replace with a new device.

Recheck from check item (3).  
 If it does not work, replace the PCB.

When the results of check item (54) are "10"  
(Detection of HPD is OK / Detection of RXSENSE is not OK)

Check the RXSENSE. (Monitor)

Check item(58). Checking the RXSENSE. :  
Does the test point of RXSENSE close to the HDMI output terminal  
[JK751] indicate the 3.3 V?

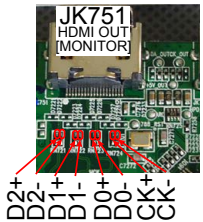

YES NO

Check for a short circuit in the TMDS line.  
If there is no problem, the HDMI Rx/Tx (IC721) is faulty.  
Replace with a new device.

HDMI Rx/Tx [IC721] is faulty.  
Replace with a new device.

Recheck from check item (3).  
If it does not work, replace the PCB.

When the results of check item (54) are "20"  
(Detection of HPD is not OK / Detection of RXSENSE is OK)

Check the HPD. (Monitor)

Check item(59). Checking the HPD. :  
Does the voltage of HPD test point close to the HDMI output terminal  
[JK751] indicate "Hi" (3-5 V)?

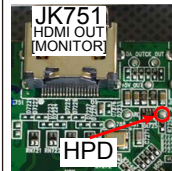

YES NO

Check for a short circuit in the HPD line.  
If there is no problem, the HDMI Rx/Tx (IC721) is faulty.  
Replace with a new device.

HDMI Rx/Tx [IC721] is faulty.  
Replace with a new device.

Recheck from check item (3).  
If it does not work, replace the PCB.

When the results of check item (54) are "00"  
(Detection of HPD is not OK / Detection of RXSENSE is not OK)

Check the RXSENSE/HPD. (Monitor)

Check item(60). Checking the HPD and RXSENSE. :  
Does the test point of RXSENSE close to the HDMI output terminal [JK751] indicate the 3.3 V?  
Does the voltage of HPD test point close to the HDMI output terminal [JK751] indicate "Hi" (3-5 V)?

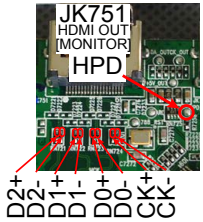

YES NO

Check for a short circuit in the TMDS/ HPD line.  
If there is no problem, the HDMI Rx/Tx (IC721) is faulty.  
Replace with a new device.

HDMI Rx/Tx [IC721] is faulty.  
Replace with a new device.

Recheck from check item (3).  
If it does not work, replace the PCB.

### 3-11. HDMI Rx/Tx [MN864788] & OSD[ADV7623] failure detection procedure

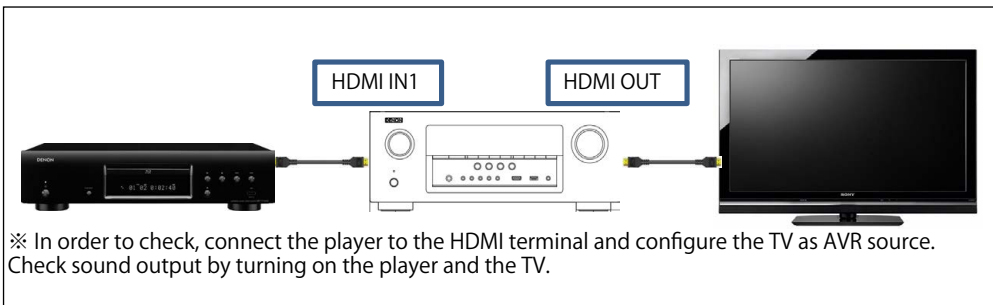

Checking the TMDS status register (Rx/Tx -> OSD)

**Check item(61).** Check the TMDS CLK detection status of the register.  
 Send the following command from Termit.exe.  
 Send the command "i 00B2 006A 0001".  
 When the following value is returned, go to Yes.  
 "11"  
 When the following value is returned, go to No.  
 "00"

Example

**Check item (62).** Checking the TMDS input waveform. :  
 Check the TMDS waveform at the following test point.  
 Is the waveform like the sample?

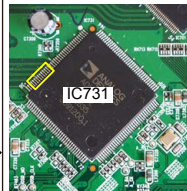

23/24/26/27/29/30/32/33 pin

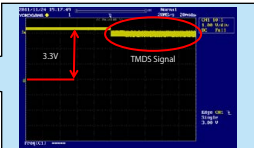

Example of waveform in check ①  
 Voltage scale : 1.0V/div  
 Time scale : 20ms/div

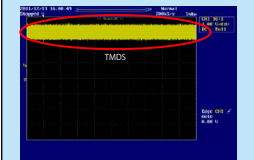

Example of waveform in check ②  
 Voltage scale : 1.0V/div  
 Time scale : 1s/div

HDMI Rx/Tx [IC721] is faulty.  
 Replace with a new device.

OSD[IC731] is faulty.  
 Replace with a new device.

Recheck from check item (4).  
 If it does not work, replace the PCB.

Caution in servicing

Electrical

Mechanical

Repair Information

Updating

## 4. Device implementation location

DIGITAL (A SIDE)

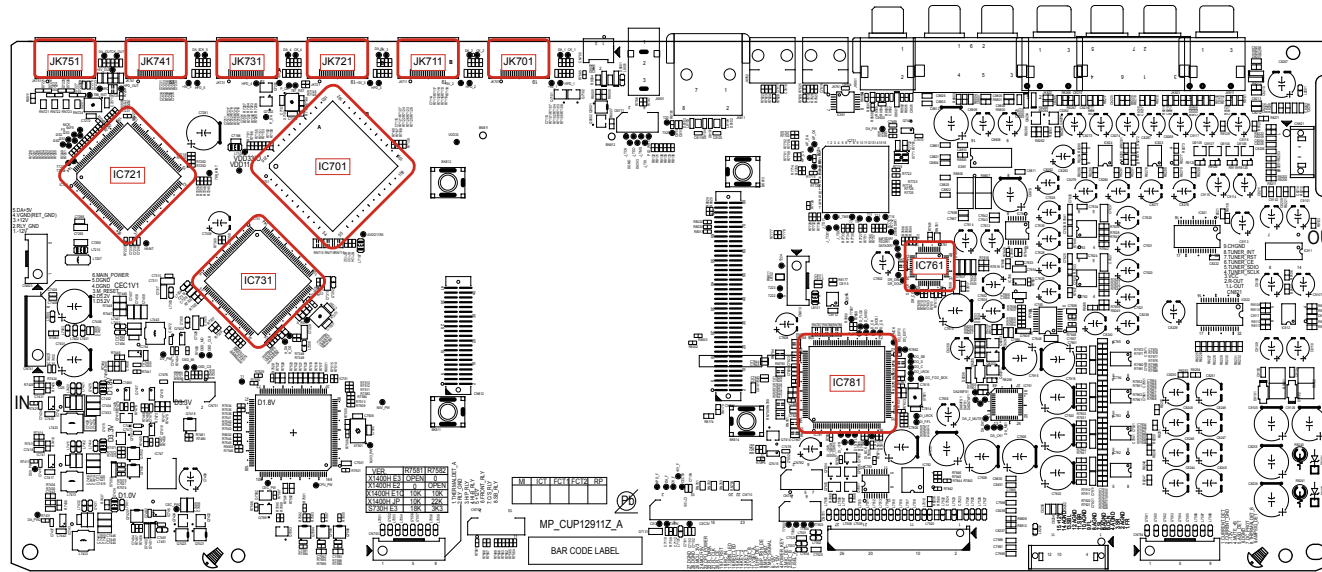

DIGITAL (B SIDE)

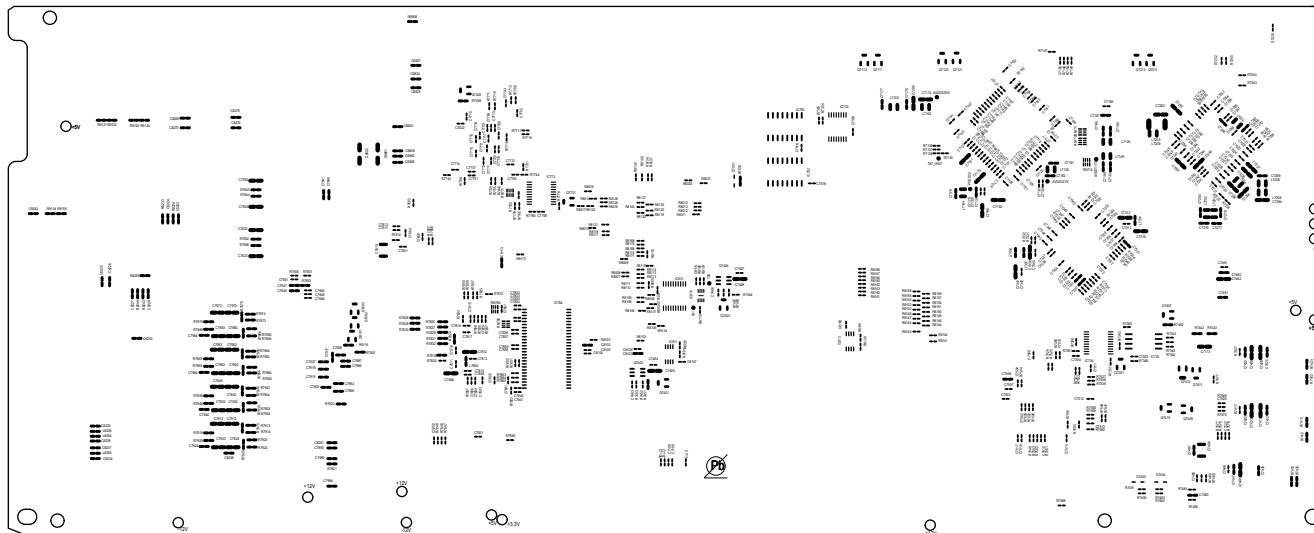

F-HDMI (A SIDE)

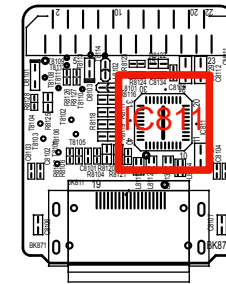

Caution in servicing

Electrical

Mechanical

Repair Information

Updating

# CLOCK FLOW & WAVE FORM IN DIGITAL BLOCK

## WAVE FORM

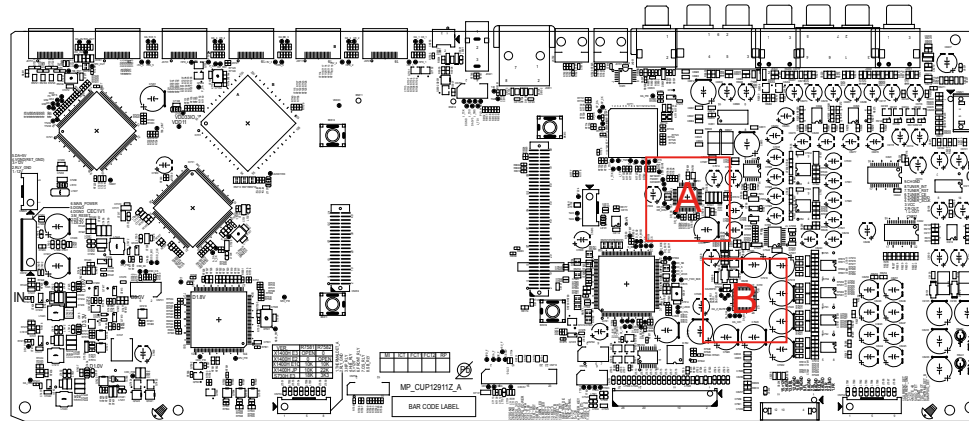
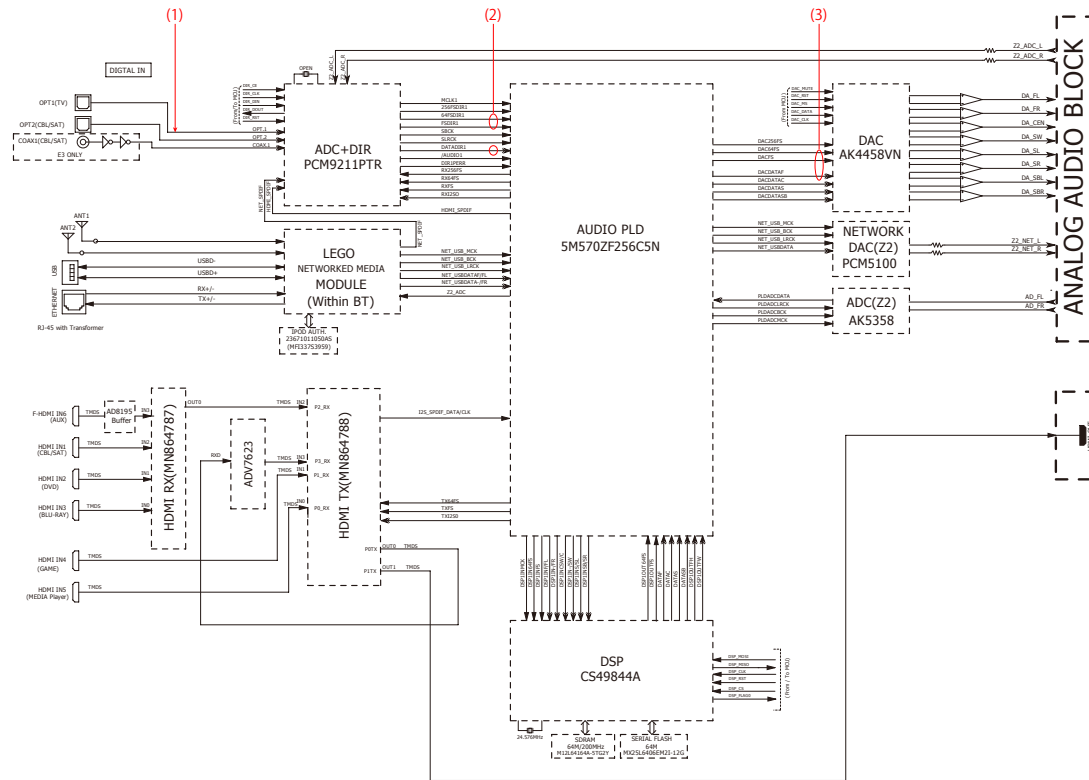
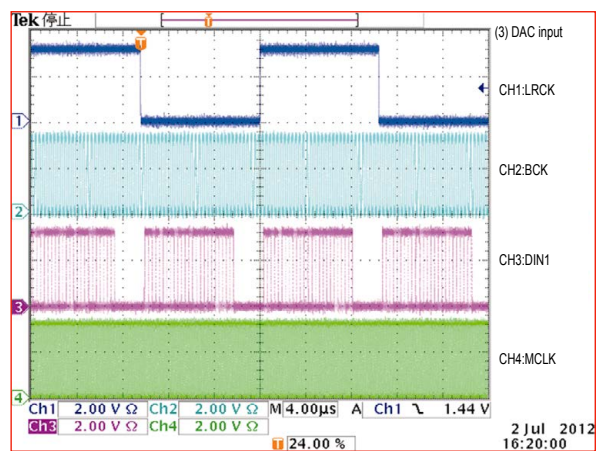
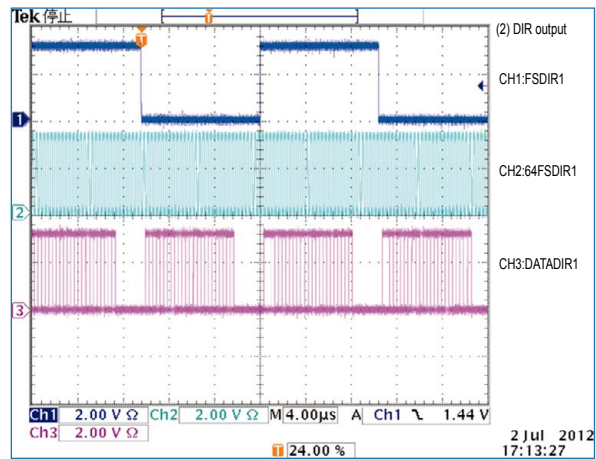
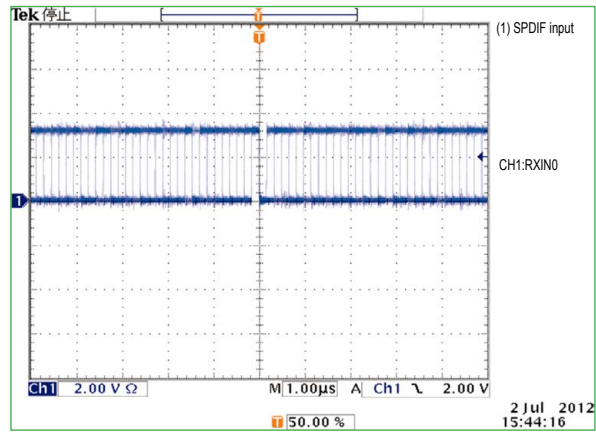

### Detail A

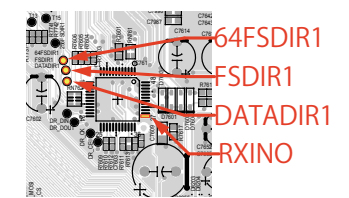

### Detail B

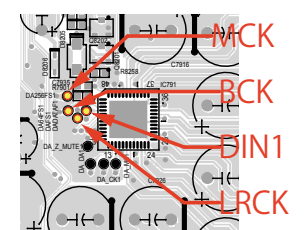

Caution in servicing

Electrical

Mechanical

Repair Information

Updating

# SPECIAL MODE

## Special mode setting button **AVR-X1400H**

※ No. 1 - 4, 6 - 8: While holding down buttons "A", "B" and "C" simultaneously, press the power button to turn on the power.

※ No. 5, 9: While the power is on, hold down buttons "A" and "B" for at least 3 seconds.

No.	Mode	Button A	Button B	Button C	Descriptions
1	Version Display (u-COM / DSP Error Display)	DIMMER	STATUS	-	Displays the version of firmware such as the main firmware or DSP. Errors that have occurred are displayed. (See <a href="#">1. Version Display Mode</a> )
2	PANEL / REMOTE LOCK Selection Mode	TUNER PRESET CH +	ZONE2 SOURCE	-	Start this unit in the PANEL/REMOTE LOCK selection mode so that PANEL LOCK and Remote Lock can be switched between On and Off. (See <a href="#">2. PANEL / REMOTE LOCK Selection Mode</a> ) ·PANEL LOCK Mode (with Volume) Disables reception from all keys and encoders on the front panel except the power button (including the volume). ·PANEL LOCK Mode (without Volume) Disables reception from all keys and encoders on the front panel except the power button and volume encoder. ·PANEL LOCK mode is turned off Releases the PANEL LOCK.
3	Selecting the Mode for Service-related	ZONE2 SOURCE	DIMMER	STATUS	This is a display for turning on each service-related mode. Service-related modes: No. 3-1 - No. 3-5 (See <a href="#">3-1. Selecting the Mode for Service-related</a> )
3-1	Check the Video/Audio path Mode	↑	↑	↑	This is a special mode for service confirmation used during repair work to simplify the confirmation work for the Audio channel / video channel. (See <a href="#">Service Path Check Mode</a> )
3-2	Protection history display mode	↑	↑	↑	Displays the protection occurrence history. (See <a href="#">3-2. Protection History Display Mode</a> )
3-3	Operation Info Mode	↑	↑	↑	Displays the accumulated operating time of the unit, the number of times the power was switched on, and the number of occurrences of each protection. (See <a href="#">3-3. Operation Info Mode</a> )
3-4	TUNER STEP Mode (E3 and E2 model only)	↑	↑	↑	Enables reception STEP of the ANALOG TUNER to be changed. (See <a href="#">3-4. TUNER STEP mode (E2 / E3 only)</a> )
3-5	Remote ID Setup Mode	↑	↑	↑	If there are multiple DENON AV receivers in the same area, this mode prevents other AV receivers from being operated concurrently with this device. (See <a href="#">3-5. Remote ID Setup Mode</a> )
4	Protection Pass Mode	TUNER PRESET CH +	ZONE2 SOURCE	STATUS	Enables the power to be turned on when protection detection is disabled. (See <a href="#">4. Protection Pass Mode</a> )
5	Network Initialization Mode	TUNER PRESET CH +	ZONE2 ON/OFF	-	Network module backup data is initialized. (See <a href="#">5. Network Initialization Mode</a> )
6	User Initialization Mode	TUNER PRESET CH -	TUNER PRESET CH +	-	Initialize the backup data for the MCU and network module. (Settings for the Installer Setup are not initialized.)
7	Factory Initialization Mode	ZONE2 SOURCE	DIMMER	-	Initialize the backup data only for MCU. (Settings for the Installer Setup are initialized) (Network function settings are not initialized.) (See <a href="#">Initializing This Unit AVR-X1400H</a> )
8	Clearing the Operation Info	ZONE2 SOURCE	STATUS	-	Clear the accumulated operating time of the unit, the number of times the power was switched on, and the number of occurrences of each protection. (See <a href="#">6. Clearing the Operation Info</a> )
9	HDMI Diagnostics モード	ZONE2 SOURCE	TUNER PRESET CH -	-	This mode is used to identify and solve the cause when there is a connectivity issue with this unit and an HDMI device. For details on the operating methods and diagnosis procedures, see the HDMI Diagnostics and Troubleshooting guide issued on SDI.

**NOTE:** When the volume indicator displays " -000 ", the unit has entered a special mode for developers. In this case, the RS-232C communication is not available. To release this special mode, press and hold the "ZONE2 SOURCE" and "TUNER PRESET CH +" buttons for 3 seconds or more while the power is ON. When the volume indicator returns to the normal display, the RS-232C communication is available.

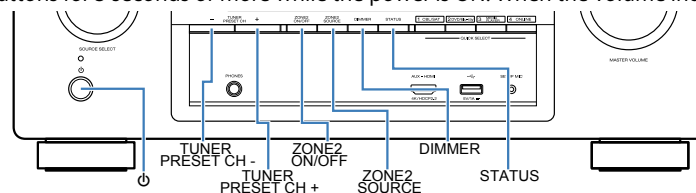

## Special mode setting button AVR-S730H

※ No. 1 - 4, 6 - 8: While holding down buttons "A", "B" and "C" simultaneously, press the power button to turn on the power.

※ No. 5, 9: While the power is on, hold down buttons "A" and "B" for at least 3 seconds.

No.	Mode	Button A	Button B	Button C	Descriptions
1	Version Display (u-COM / DSP Error Display)	DIMMER	STATUS	-	Displays the version of firmware such as the main firmware or DSP. Errors that have occurred are displayed. (See <a href="#">1. Version Display Mode</a> )
2	PANEL / REMOTE LOCK Selection Mode	ZONE2 SOURCE	TUNER PRESET CH +	-	Start this unit in the PANEL/REMOTE LOCK selection mode so that PANEL LOCK and Remote Lock can be switched between On and Off. (See <a href="#">2. PANEL / REMOTE LOCK Selection Mode</a> ) ·PANEL LOCK Mode (with Volume) Disables reception from all keys and encoders on the front panel except the power button (including the volume). ·PANEL LOCK Mode (without Volume) Disables reception from all keys and encoders on the front panel except the power button and volume encoder. ·PANEL LOCK mode is turned off Releases the PANEL LOCK.
3	Selecting the Mode for Service-related	TUNER PRESET CH +	TUNE -	TUNE +	This is a display for turning on each service-related mode. Service-related modes: No. 3-1 - No. 3-5 (See <a href="#">3-1. Selecting the Mode for Service-related</a> )
3-1	Check the Video/Audio path Mode	↑	↑	↑	This is a special mode for service confirmation used during repair work to simplify the confirmation work for the Audio channel / video channel. (See <a href="#">Service Path Check Mode</a> )
3-2	Protection history display mode	↑	↑	↑	Displays the protection occurrence history. (See <a href="#">3-2. Protection History Display Mode</a> )
3-3	Operation Info Mode	↑	↑	↑	Displays the accumulated operating time of the unit, the number of times the power was switched on, and the number of occurrences of each protection. (See <a href="#">3-3. Operation Info Mode</a> )
3-4	TUNER STEP Mode (E3 and E2 model only)	↑	↑	↑	Enables reception STEP of the ANALOG TUNER to be changed. (See <a href="#">3-4. TUNER STEP mode (E2 / E3 only)</a> )
3-5	Remote ID Setup Mode	↑	↑	↑	If there are multiple DENON AV receivers in the same area, this mode prevents other AV receivers from being operated concurrently with this device. (See <a href="#">3-5. Remote ID Setup Mode</a> )
4	Protection Pass Mode	ZONE2 SOURCE	TUNER PRESET CH +	TUNE +	Enables the power to be turned on when protection detection is disabled. (See <a href="#">4. Protection Pass Mode</a> )
5	Network Initialization Mode	ZONE2 SOURCE	ZONE2 ON/OFF	-	Network module backup data is initialized. (See <a href="#">5. Network Initialization Mode</a> )
6	User Initialization Mode	TUNER PRESET CH -	TUNER PRESET CH +	-	Initialize the backup data for the MCU and network module. (Settings for the Installer Setup are not initialized.)
7	Factory Initialization Mode	TUNER PRESET CH +	TUNE -	-	Initialize the backup data only for MCU. (Settings for the Installer Setup are initialized) (Network function settings are not initialized.) (See <a href="#">Initializing This Unit AVR-S730H</a> )
8	Clearing the Operation Info	TUNER PRESET CH +	TUNE +	-	Clear the accumulated operating time of the unit, the number of times the power was switched on, and the number of occurrences of each protection. (See <a href="#">6. Clearing the Operation Info</a> )
9	HDMI Diagnostics Mode	ZONE2 SOURCE	TUNER PRESET CH -	-	This mode is used to identify and solve the cause when there is a connectivity issue with this unit and an HDMI device. For details on the operating methods and diagnosis procedures, see the HDMI Diagnostics and Troubleshooting guide issued on SDI.



**NOTE:** When the volume indicator displays " -000 ", the unit has entered a special mode for developers. In this case, the RS-232C communication is not available.

To release this special mode, press and hold the "ZONE2 SOURCE" and "TUNER PRESET CH +" buttons for 3 seconds or more while the power is ON. When the volume indicator returns to the normal display, the RS-232C communication is available.

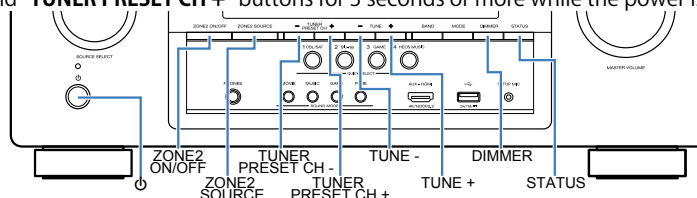

# 1. Version Display Mode

## 1.1. Actions

Version information is displayed when the device is started in this mode.

## 1.2. Starting up

While holding down buttons "DIMMER" and "STATUS" simultaneously, press the power button to turn on the power.

then press the "STATUS" button to display the information in section 1.3 on the display.

※ The version list is also displayed on GUI while the version is displayed on the display.

## 1.3. Display Order

Error information(See "1.4. Error display") → ① Model destination information → ② Serial Number → ③ Firmware Package → ④ Main  $\mu$ -com → ⑤ Main 1st Boot Loader → ⑥ DSP → ⑦ Audio PLD → ⑧ GUI SFLASH → ⑨ HIMG → ⑩ HEOS Version → ⑪ HEOS Build → ⑫ HEOS Module → ⑬ HEOS Configuration → ⑭ HEOS Locale → ⑮ Ether Mac Address → ⑯ Wi-Fi Mac Address → ⑰ BT Mac Address → ⑱ Audyssey App Interface Version

① Model destination information :

```
AVR-S730H E3 *
AVR-X1400H \ \ *
  \ : Region (E3, E2, E1C, JP)
```

② Serial Number :

```
SN*****
```

③ Firmware Package :

```
Package :****
```

④ Main  $\mu$ -com :

```
M*****
```

⑤ Main 1st Boot Loader :

```
Main FBL :**.*
```

⑥ DSP ROM :

```
DSP :**.*
```

⑦ Audio PLD :

```
Audio PLD:***.*
```

⑧ GUI SFLASH :

```
GUI :@#$\****
```

@ : Model code, # : Brand code (DENON=1),  
 \ : Region code (E3=1, E2=2, E1C=5, JP=4,  
 ALL=0), \* : version

⑨ HIMG :

```
HIMG :*****
```

⑩ HEOS Version :

```
HEOS Version
↓"Press "STATUS" button.
*.*.*.*
```

⑪ HEOS Build :

```
HEOS Build
↓"Press "STATUS" button.
*****
```

⑫ HEOS Module :

```
HEOS Module
↓"Press "STATUS" button.
***
```

⑬ HEOS Config :

```
HEOS Config
↓"Press "STATUS" button.
Production
```

⑭ HEOS Locale :

```
HEOS Locale
↓"Press "STATUS" button.
*****
```

⑮ Ether MAC Address :

```
*Ether MAC
↓"Press "STATUS" button.
*****-*****
```

⑯ Wi-Fi MAC Address :

```
*Wi-Fi MAC
↓"Press "STATUS" button.
*****-*****
```

⑰ Bluetooth MAC Address :

```
*BT MAC Address
↓"Press "STATUS" button.
*****-*****
```

⑱ Audyssey App Interface Ver :

```
Audy IFVer:***.*
```

## 1.4. Error display

See the table below for descriptions of the displayed errors and countermeasures for these.

If multiple errors occur, only one item is displayed.

The priority order is ②, ③, ④, ①.

Condition	States	Display	TROUBLE SHOOTING
① Firm Check NG	<p>The model name, brand name and region information written in the firmware are compared to the region settings in the PCB. This error is displayed if the information does not match.</p> <p>"▲" is displayed as the first character if the firmware is not correct (see the illustrations on the right).</p>	<div style="border: 1px solid black; padding: 2px; text-align: center;">FIRM ERROR</div> <div style="border: 1px solid black; padding: 2px; text-align: center;">▲M! *****</div> <div style="border: 1px solid black; padding: 2px; text-align: center;">▲Main FBL : **: **</div> <div style="border: 1px solid black; padding: 2px; text-align: center;">▲DSP : **: **</div> <div style="border: 1px solid black; padding: 2px; text-align: center;">▲Audio PLD: **: **</div> <div style="border: 1px solid black; padding: 2px; text-align: center;">▲GUI : *****</div>	<ul style="list-style-type: none"> <li>•Check the resistor for setting the region (R7581 / 7582, DIGITAL PCB).</li> <li>•Write the firmware for the correct region.</li> </ul>
② DIR NG	This error is displayed if there is no response from the DIR.	<div style="border: 1px solid black; padding: 2px; text-align: center;">DIR ERROR 01</div>	<ul style="list-style-type: none"> <li>•Check the DIR (IC761, DIGITAL PCB) and surrounding circuits.</li> </ul>
③ DSP NG	The DSP FLAG0 port does not enter "Hi" status while booting a DSP code even after resetting DSP.	<div style="border: 1px solid black; padding: 2px; text-align: center;">DSP ERROR 01</div>	<ul style="list-style-type: none"> <li>•Check the DSP (IC781, DIGITAL PCB) and surrounding circuits.</li> </ul>
	The DSP FLAG0 port does not enter "Hi" status before issuing a DSP command.	<div style="border: 1px solid black; padding: 2px; text-align: center;">DSP ERROR 02</div>	
	Setting WRITE to "Lo" does not set ACK to "Hi" during DSP data reading.	<div style="border: 1px solid black; padding: 2px; text-align: center;">DSP ERROR 03</div>	
	Setting REQ to "Lo" does not set ACK to "Lo" during DSP data reading.	<div style="border: 1px solid black; padding: 2px; text-align: center;">DSP ERROR 04</div>	
	Setting WRITE to "Hi" does not set ACK to "Hi" during DSP data writing.	<div style="border: 1px solid black; padding: 2px; text-align: center;">DSP ERROR 05</div>	
Setting REQ to "Lo" does not set ACK to "Lo" during DSP data writing.	<div style="border: 1px solid black; padding: 2px; text-align: center;">DSP ERROR 06</div>		
④ EEPROM NG	An error occurred in a checksum of the EEPROM(*** is a block address number).	<div style="border: 1px solid black; padding: 2px; text-align: center;">BACKUP ERROR</div>	

## 1.5. Version Display in the Setup Menu

Follow the steps below to display the firmware information.

- (1) Press the "SETUP" button on the remote control.
- (2) Select "General - Information - Firmware".

The version information is displayed as a 16-digit number as shown in the screenshot below.

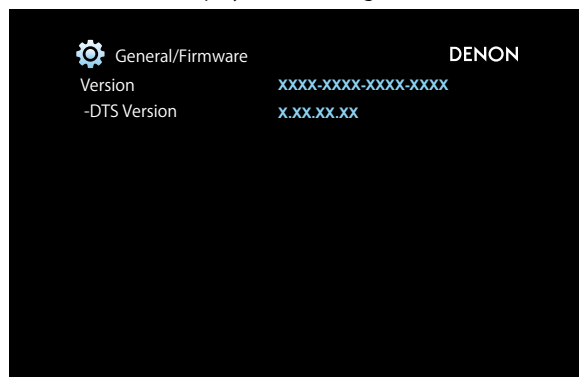

GUI Image

This 16-digit number comprises a part of the version number of each device and module. Numerics and version numbers correspond as shown below.

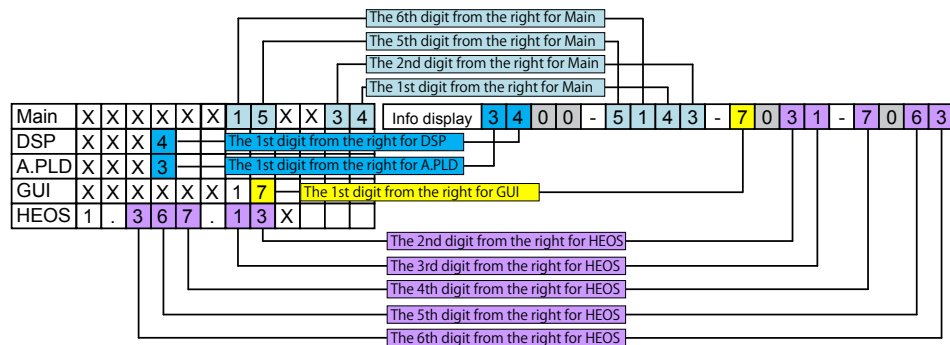

※ The firmware version numbers and this 16-digit version information are written in the Service Information.

※ Replace as follows for the 5th to 7th digits of HEOS version.

- X.XXX.X → X.XXX.00X
- X.XXX.XX → X.XXX.0XX
- X.XXX.XXX → X.XXX.XXX

## 2. PANEL / REMOTE LOCK Selection Mode

### 2.1. Actions

Switch the PANEL LOCK and REMOTE LOCK modes between on and off.

### 2.2. Starting up

While holding down buttons "TUNER PRESET CH+" and "ZONE2 SOURCE" simultaneously, press the power button to turn on the power.

Select the desired mode using the "TUNER PRESET CH+/-" button, then press the "STATUS" button to confirm.

### 2.3. Displaying and Selecting Each Mode

The information shown on the display switches each time the "TUNER PRESET CH+" button is pressed.

Press the "STATUS" button to set the currently displayed mode and restart the device.

The setting with "\*" is selected for each mode.

①

FP/VOL LOCK\*On

The buttons on the unit and the master volume knob does not function.



②

FP LOCK On

The buttons on the unit does not function.



③

FP LOCK Off

The PANEL LOCK mode is turned off.



④

RC LOCK On

The device cannot be operated by the remote control.



⑤

RC LOCK \*Off

The REMOTE LOCK mode is turned off.

## 3-1. Selecting the Mode for Service-related

### 3-1.1. Actions

Select diagnostic mode (service path check mode), protection history display mode, 232C standby clear mode, Operation Info mode, TUNER STEP mode or Remote ID Setup Mode.

### 3-1.2. Starting up

#### AVR-X1400H

- While holding down buttons "ZONE2 SOURCE", "DIMMER" and "STATUS" simultaneously, press the power button to turn on the power.

#### AVR-S730H

- While holding down buttons "TUNER PRESET CH+", "TUNE -" and "TUNE +" simultaneously, press the power button to turn on the power.

Select the desired mode using the "TUNER PRESET CH+/-" button, then press the "STATUS" button to confirm.

### 3-1.3. Displaying and Selecting Each Mode

The information shown on the display switches each time the "TUNER PRESET CH+" button is pressed.

Press the "STATUS" button to set the currently displayed mode and restart the device.

①

1. SERVICE CHECK

Service Path Check Mode : See "DIAGNOSTIC MODE"

The Video and Audio paths can be checked.

This function is convenient for confirming problem paths in the product and checking the paths after repairing.



②

2. PROTECTION

The protection history can be checked.



③

4. OP INFO

Operation Info for the unit can be checked.



④ E3 and E2 model only

5. TUNER FRQ SET

Enables reception STEP of the ANALOG TUNER to be changed.



⑤

6. REMOTE ID

This function is for operating only the desired AV receiver.

### 3-1.4. Canceling the selected mode

Press the power button to turn off the power.

## 3-2. Protection History Display Mode

### 3-2.1. Actions

This mode enables the unit to record and display the event when the THERMAL, ASO or DC protection is activated.

If protections have been activated multiple times, the latest protection operation is recorded.

### 3-2.2. Starting up

#### AVR-X1400H

- While holding down buttons "ZONE2 SOURCE", "DIMMER" and "STATUS" simultaneously, press the power button to turn on the power.

#### AVR-S730H

- While holding down buttons "TUNER PRESET CH+", "TUNE -" and "TUNE +" simultaneously, press the power button to turn on the power.

Select the "2. PROTECTION" using the "TUNER PRESET CH+/-" button, then press the "STATUS" button then to confirm.

### 3-2.3. Protection information and displays

- Press the "STATUS" button in Protection History Display Mode.
- The protection history can be checked.

- (a) If no protections has occurred.

NO PROTECT

- (b) ASO (if the last protection is ASO)

PRT:ASO

**Cause** A short circuit occurred between the speaker terminals, or speakers with an impedance outside the rating were connected.

**Note** : Short circuits in speaker terminals or speakers can be identified.

If the power is turned on in the abnormal state, protection is activated after around 6 seconds and the power is turned off.

- (c) DC (if the last protection is DC)

PRT:DC

**Cause** : DC output of the power amplifier is abnormal.

If the power is turned on in the abnormal state, protection is activated after around 6 seconds and the power is turned off.

- (d) THERMAL (if the last protection is THERMAL(A) or THERMAL(B))

PRT:THERMAL A

PRT:THERMAL B

**Cause** : Abnormal heat sink temperature.

If the power is turned on under abnormal conditions, the protection function works immediately and the power is turned off.

- (e) Case of CURRENT (when the last protection incident is CURRENT protection)

:CURRENT

**Cause** : An over current flowed in power amp.

If the power is turned on in the abnormal state, protection is activated after around 90 seconds and the power is turned off.

**Caution** : These protections may also be activated due to other factors such as disconnection of connectors or operations around the microcomputer.

After viewing the above protection history, press the "STATUS" button to return to the normal display.

### 3-2.4. Clearing the Protection History

There are two ways to clear the protection history.

- (a) Activate Protection History Display Mode. Press the "**STATUS**" button to display the protection history. Press and hold the "**DIMMER**" button for 3 seconds.

PRT:DC

Press and hold the "**DIMMER**" button for 3 seconds.



PRT: CLEAR

The above message is displayed and the protection history is cleared.



NO PROTECT

- (b) Initialize this unit. (See "[CAUTION IN SERVICING.](#)")

※ Use the method in **3-2.4. (a)** if you do not want to erase your settings from this unit.

### Warning Displays by POWER LED

If the power is turned Off while a protection is being detected, the POWER LED flashes in red to warn you depending on the protection status as follows.

- (a) ASO/DC protection: Flashes at 0.5-second intervals (0.25 seconds lit, 0.25 seconds unlit)
- (b) THERMAL (A/B) protection: Flashes at 2-second intervals (1 seconds lit, 1 seconds unlit)
- (c) CURRENT protection: Flashes at 4-second intervals (2 seconds lit, 2 seconds unlit)

## 3-3. Operation Info Mode

### 3-3.1. Actions

This mode enables the unit to display the accumulated operating time, power On count and each protection count.

### 3-3.2. Starting up

#### AVR-X1400H

- While holding down buttons "ZONE2 SOURCE", "DIMMER" and "STATUS" simultaneously, press the power button to turn on the power.

#### AVR-S730H

- While holding down buttons "TUNER PRESET CH+", "TUNE -" and "TUNE +" simultaneously, press the power button to turn on the power.

Select the "4. OP INFO" using the "TUNER PRESET CH+/-" button, then press the "STATUS" button to confirm.

### 3-3.3. Operations

Press the "STATUS" button after starting up this device in Operation Info mode. The following information is displayed in the following order.

- (a) Accumulated operating time

OP Time \_\_\_\_\_H  
↓ "STATUS"      ↑ Time display

- (b) Power On count

P.On Time\_\_\_\_\_H  
↓ "STATUS"      ↑ Count display

- (c) DC / ASO Protection count

DC: \_\_\_/ASO: \_\_\_  
↓ "STATUS"

- (d) Thermal Protection (A/B) count

THM A: \_\_\_/B: \_\_\_  
↓ "STATUS"

- (f) Current Protection count

Current: \_\_\_  
↓ "STATUS"

(Returns to normal display)

## 3-4. TUNER STEP mode (E2 / E3 only)

### 3-4.1. Actions

This is a special mode for enabling reception STEP of the ANALOG TUNER to be changed.

### 3-4.2. Starting up

#### AVR-X1400H

- While holding down buttons "ZONE2 SOURCE", "DIMMER" and "STATUS" simultaneously, press the power button to turn on the power.

#### AVR-S730H

- While holding down buttons "TUNER PRESET CH+", "TUNE -" and "TUNE +" simultaneously, press the power button to turn on the power.

Select the "5. TUNER FRQ SET" using the "TUNER PRESET CH+/-" button, then press the "STATUS" button to confirm.

### 3-4.3. Displays

Start up this unit in TUNER STEP mode, select the desired option using the "TUNER PRESET CH+/-" button, then enter using the "STATUS" button.

The following information is displayed in the following order.

- (a) AM9 kHz / FM50 kHz is selected

< AM9/FM50 >  
"TUNER PRESET CH+" ↓      ↑ "TUNER PRESET CH-"

- (b) AM10 kHz / FM200 kHz is selected

< AM10/FM200 >  
↓ "STATUS"

- (c) Press the power button to turn off the power.

- (d) Press the power button to turn on the power.

## 3-5. Remote ID Setup Mode

### 3-5.1. Actions

This function allows only the desired AV receiver to be operated if multiple DENON AV receivers are used in the same room.

### 3-5.2. Starting up

#### AVR-X1400H

- While holding down buttons "ZONE2 SOURCE", "DIMMER" and "STATUS" simultaneously, press the power button to turn on the power.

#### AVR-S730H

- While holding down buttons "TUNER PRESET CH+", "TUNE -" and "TUNE +" simultaneously, press the power button to turn on the power.

Select the "6. REMOTE ID" using the "TUNER PRESET CH+/-" button, then press the "STATUS" button then to confirm.

### 3-5.3. Operations

- (a) When Remote ID Setup mode is activated, the following message is displayed.

REMOTE ID ?

- (b) Press the desired "QUICK SELECT 1 - 4" button.

Button	Display
QUICK SELECT 1	REMOTE ID 1
QUICK SELECT 2	REMOTE ID 2
QUICK SELECT 3	REMOTE ID 3
QUICK SELECT 4	REMOTE ID 4

- (c) Press the power button to turn off the power.

- (d) Press the power button to turn on the power.

※ Only "QUICK SELECT 1 - 4" and the POWER button on the unit can be used in Remote ID Setup Mode.

※ The remote ID of the remote control supplied with this unit cannot be changed.

#### NOTE :

If the ID of the unit and remote control do not match, "AVAMP\*" appears on the display of the unit when the remote control is used

(\* : own remote control ID).

## 4. Protection Pass Mode

### 4.1. Actions

- This mode allows the power to be turned on without activating protections.
- This mode functions in the same way as normal power-on, except that protections are not activated.
- When using the protection pass mode, do not connect speakers to the speaker terminals.

### 4.2. Operations

#### AVR-X1400H

- While holding down buttons "**TUNER PRESET CH +**", "**ZONE2 SOURCE**" and "**STATUS**" simultaneously, press the power button to turn on the power.

#### AVR-S730H

- While holding down buttons "**ZONE2 SOURCE**", "**TUNER PRESET CH +**" and "**TUNE +**" simultaneously, press the power button to turn on the power.

The device returns to the normal display message after the following is displayed.



Protection Pass

This is displayed for 5 seconds before returning to the normal display.

## 5. Network Initialization Mode

### 5.1. Actions

The following items are initialized.

- (1) Network setup
- (2) Friendly Name
- (3) Auto Update setting
- (4) Allow Update setting
- (5) Time Zone setting
- (6) Queue list
- (7) Internet Radio recently played station
- (8) Quick Select playback station
- (9) AirPlay Password
- (10) Bluetooth Pairing History

### 5.2. Operations

#### AVR-X1400H

- When the power is on and the input source is HEOS Music, press and hold the "**TUNERPRESET CH +**" and "**ZONE2ON/OFF**" buttons for more than 3 seconds.

#### AVR-S730H

- When the power is on and the input source is HEOS Music, press and hold the "**ZONE2 SOURCE**" and "**ZONE2ON/OFF**" buttons for more than 3 seconds.

Initializing Display



L1 Network Reset...

Complete Display

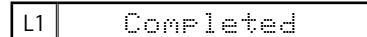

L1 Completed

This is displayed for 5 seconds before returning to the normal display.

## 6. Clearing the Operation Info

### 6.1. Actions

- Displays the accumulated operating time of the unit, the number of times the power was switched on, and the number of occurrences of each protection.

### 6.2. Operations

Remove all input/output terminals and the AC plug.

Connect the AC plug again and place the product in standby mode.

#### AVR-X1400H

- While holding down buttons "**ZONE2 SOURCE**" and "**STATUS**" simultaneously, press the power button to turn on the power.

#### AVR-S730H

- While holding down buttons "**TUNER PRESET CH +**" and "**TUNE +**" simultaneously, press the power button to turn on the power.

PRODUCT MODE

- ③ When "**PRODUCT MODE**" appears on the display, release the button and press the "**ZONE2 ON/OFF**" button to place the product in standby mode.

## Service Path Check Mode

### 1.1. Actions

This function is convenient for confirming problem paths in the product and checking the paths after repairing.  
The Video and Audio paths can be checked.  
The backup data is not rewritten.

### 1.2. Starting up

#### AVR-X1400H

· While holding down buttons "ZONE2 SOURCE", "DIMMER" and "STATUS" simultaneously, press the power button to turn on the power.

#### AVR-S730H

· While holding down buttons "TUNER PRESET CH+", "TUNE -" and "TUNE +" simultaneously, press the power button to turn on the power.

Select the "1. SERVICE CHECK" using the "TUNER PRESET CH+/-" button, then press the "STATUS" button then to confirm.  
The "TUNED", "STEREO" and "RDS" segments are lit in this mode.

### 1.3. Canceling diagnostic mode

Press the power button to turn off the power.

### 1.4. Selecting items to check

Press the ① button to switch between video items and audio items.  
Press the ② or ③ button to select the previous or next item.

Actions	The unit			Remote control unit		
	①	②	③	①	②	③
	Audio ⇄ Video	PREVIOUS	NEXT	Audio ⇄ Video	PREVIOUS	NEXT
Button	DIMMER	QUICK SELECT 1	QUICK SELECT 2	SLEEP	CURSOR ◀	CURSOR ▶

### 1.5. Audio system confirmation items

See the block diagram fig.XXth.

Paths to be confirmed		Display	Settings	What to confirm
1	Analog	fig.01 A01:ANALOG PASS	Input Source : CBL/SAT Input Mode : Analog (fixed) Sound mode : DIRECT Amp assign : Surround Back MAIN ZONE : On ZONE2 : Off	• Analog input ⇒ Speaker output (Front L/R) (※ The input source can be switched to any source except CBL/SAT.)
2	DIGITAL (MAIN)	fig.02a fig.02b A02: DIGITAL	Input Source : CBL/SAT Input Mode : DIGITAL (fixed) Sound mode : MULTI CH STEREO Amp assign : Surround Back Speaker Config ALL Speaker = Small / SW = Yes(2ch) MAIN ZONE : On ZONE2 : Off	• Digital input ⇒ Speaker output (Front L/R, Center, Surround L/R, Surround Back L/R) • Digital input ⇒ Pre OUT output (Subwoofer) (※ The input source can be switched to any source except CBL/SAT.)
3	DIGITAL (ZONE2)	fig.03a fig.03b A03: DIGITAL-Z2	Input Source : HEOS Music Input Mode : Auto Sound mode : STEREO Amp assign : ZONE2 MAIN ZONE : On ZONE2 : On	• Digital(PCM) input ⇒ Speaker output (Surround Back (ZONE2) L/R) • Digital(PCM) input ⇒ Pre OUT output (ZONE2 L/R) (X1400E3 Only)

Paths to be confirmed		Display	Settings	What to confirm
4	HDMI	fig.04a fig.04b	A05:HDMI Input Source : CBL/SAT Input Mode : HDMI (fixed) Sound mode : STEREO Amp assign : Surround Back MAIN ZONE : On ZONE2 : Off	• HDMI input ⇒ Speaker output (Front L/R) (※ The input source can be switched to any source except CBL/SAT.)
5	Analog AD (MAIN ZONE)	fig.05a fig.05b	A06:AD Input Source : CBL/SAT Input Mode : Analog (fixed) Sound mode : MULTI CH STEREO Vol 60(-20dB) Amp assign : Surround Back Speaker Config ALL Speaker = Small/SW = Yes(2ch) MAIN ZONE : On ZONE2 : Off	• Analog input ⇒ Speaker output (Front L/R, Center, Surround L/R, Surround Back L/R) • Analog input ⇒ Pre OUT output SW(20Hz) (※ The input source can be switched to any source except CBL/SAT.) (※ Volume 60 is the value when Absolute settings are used. The value is -20 when Relative settings are used)
6	Analog Amp Assign (Amp Assign : ZONE2)	fig.06	A07:ASSIGN-Z2 Input Source : CBL/SAT Input Mode : Auto Sound mode : STEREO Z2 Source : Source Vol 60(-20dB) Amp assign : ZONE2 MAIN ZONE : On ZONE2 : On	• Analog input ⇒ Speaker output (Surround Back (ZONE2) L/R) • Analog input ⇒ Pre OUT output (ZONE2 L/R) (※ The input source can be switched to any source except CBL/SAT.) (※ Volume 60 is the value when Absolute settings are used. The value is -20 when Relative settings are used)

## 1.6. Confirmation items for the video system

See the block diagram fig.XXth.

Paths to be confirmed		Display	Settings	What to confirm
1	Analog Video pass	fig.07	U01:VIDEO PASS Input Source : CBL/SAT MAIN ZONE : On	• CVBS input ⇒ CVBS output (※ The input source can be switched to any source except CBL/SAT.)
2	HDMI pass	fig.08	U03:HDMI PASS Input Source : CBL/SAT MAIN ZONE : On ZONE2 : Off	• HDMI input (MAIN function) ⇒ HDMI output (MAIN) (※ The input source can be switched to any source except CBL/SAT.)
3	HDMI CEC	fig.09	U04:HDMI CEC Input Source : CBL/SAT HDMI Control : On MAIN ZONE : On ZONE2 : Off	• When the power supply of a TV is put in the standby mode, make sure that the power supply of this unit is also put in the standby mode. (※ The input source can be switched to any source except CBL/SAT.) • The ARC path can also be checked (check this using the TV input source).
4	HDMI Audio (Audio : AVR)	fig.04a fig.04b	U05:H.AUDIO-AVR Input Source : CBL/SAT HDMI Control : Off HDMI Audio : AVR (if checking the audio output from AVR)	• HDMI input (PCM , DolbyDigital , DTS) ⇒ Speaker output. • HDMI input(HD audio) ⇒ Speaker output. (※ The input source can be switched to any source except CBL/SAT.)
5	HDMI Audio (Audio : TV)	fig.10	U06:H.AUDIO-TV HDMI Audio : TV (if checking the audio output from TV)	• HDMI input (PCM , DolbyDigital , DTS) ⇒ HDMI output (audio output from connected TV) (※ The input source can be switched to any source except CBL/SAT.)
6	GUI	fig.11	U07:GUI MENU ON Input Source : CBL/SAT Setup Menu : On MAIN ZONE : On ZONE2 : Off	• GUI display ⇒ HDMI output. (※ The input source can be switched to any source except CBL/SAT.)

fig.01

# AVRS730H/X1400H ANALOG AUDIO BLOCK

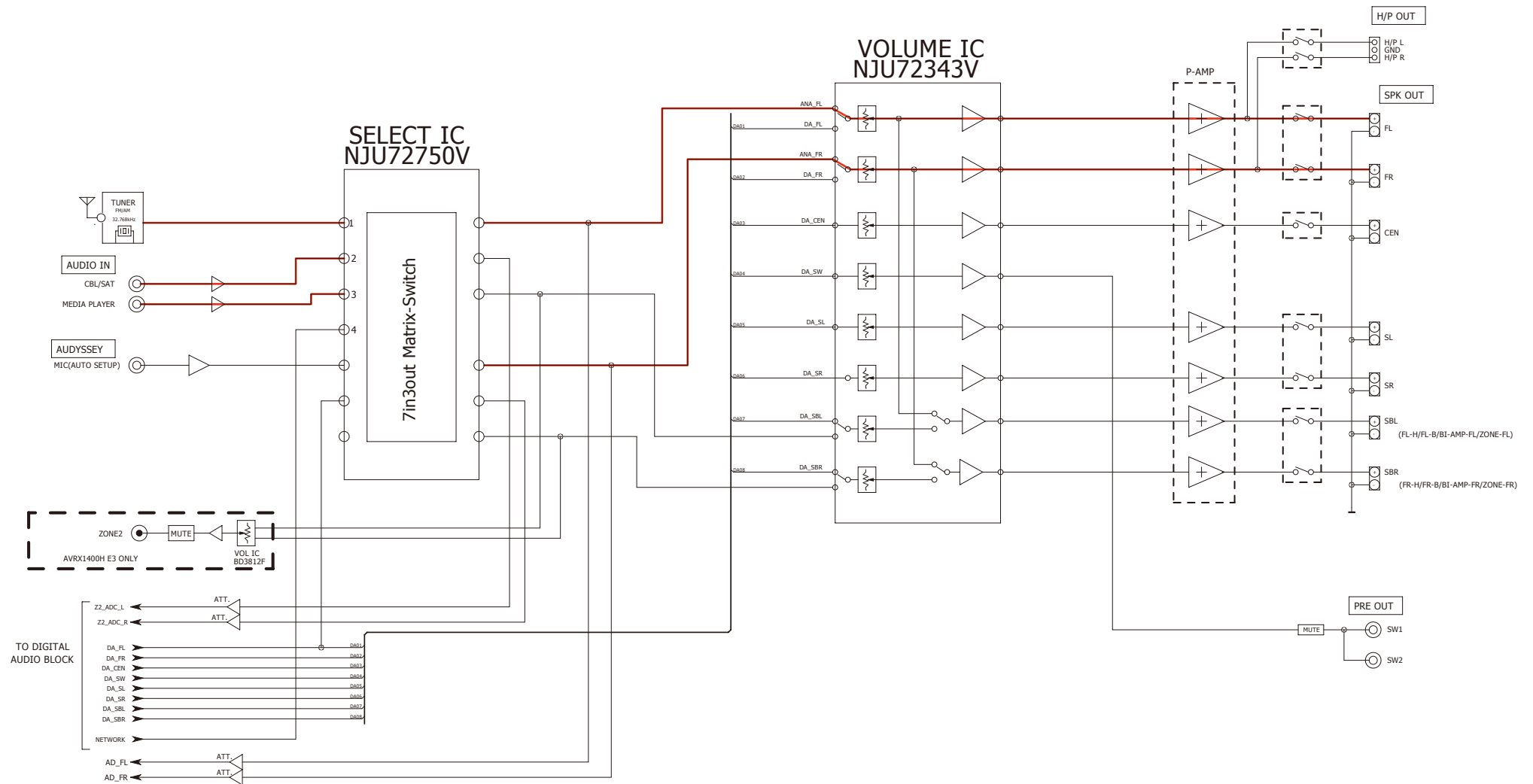

Caution in servicing

Electrical

Mechanical

Repair Information

Updating

fig.02a

# AVRS730H/X1400H DIGITAL AUDIO BLOCK

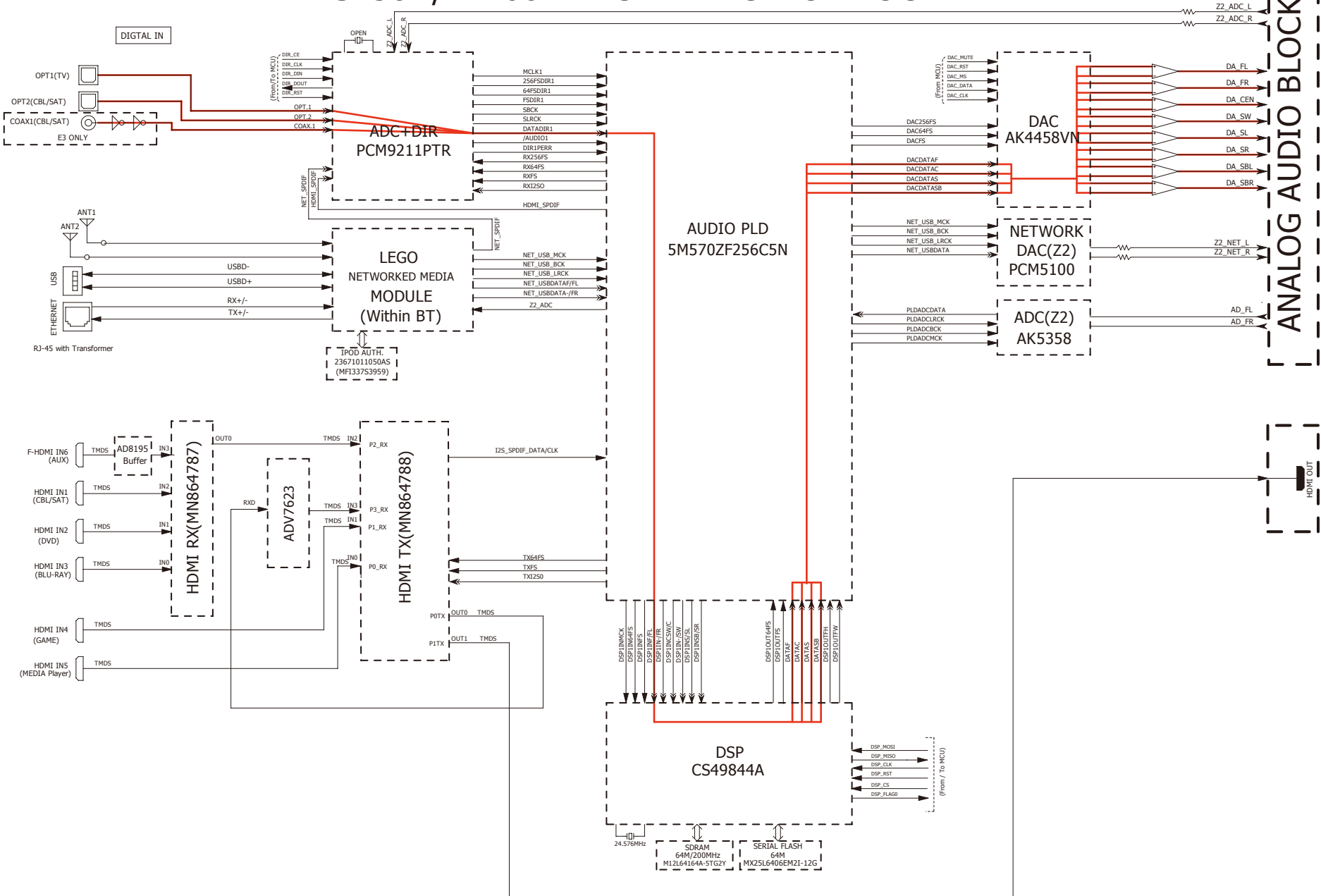

fig.02b

# AVRS730H/X1400H ANALOG AUDIO BLOCK

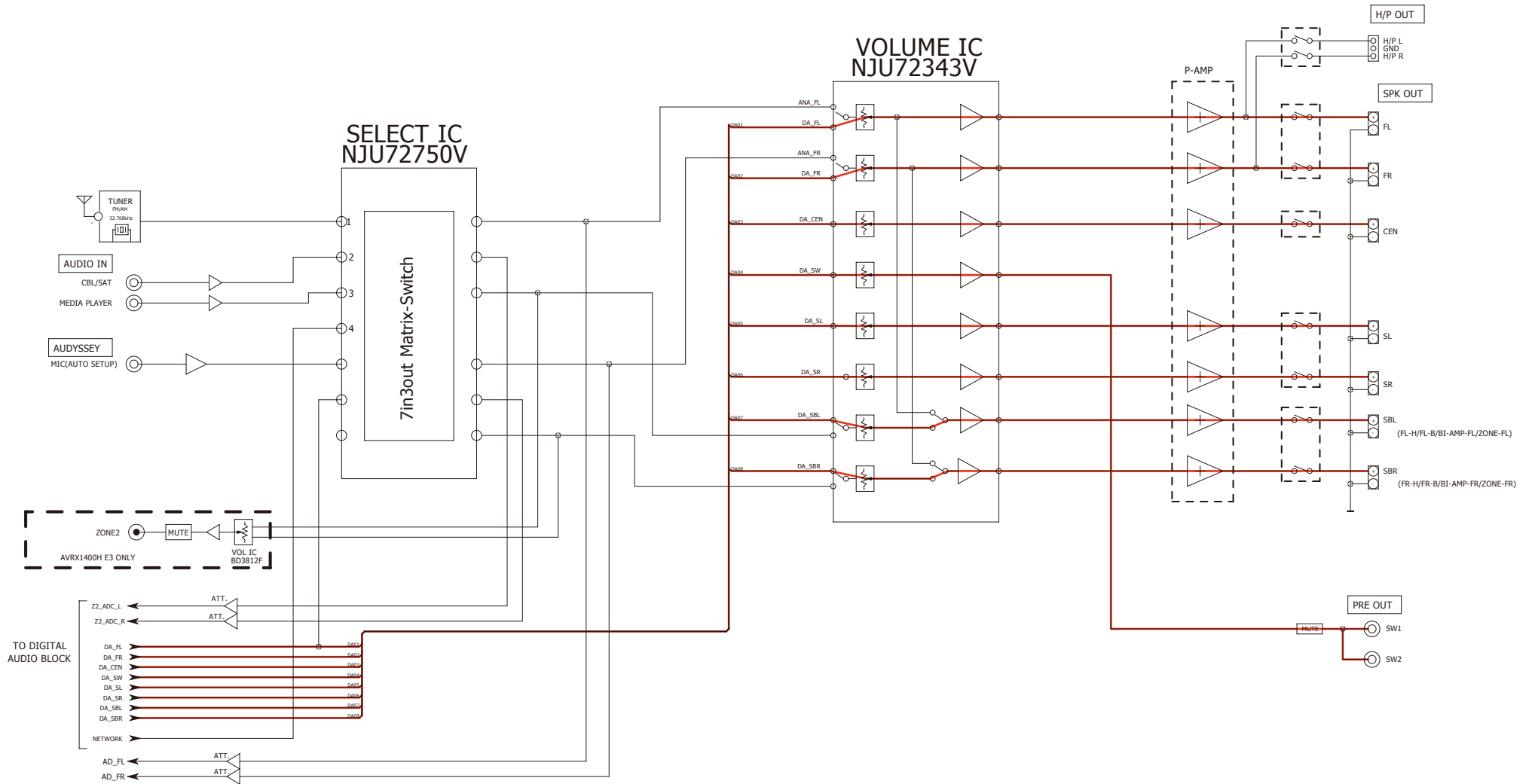
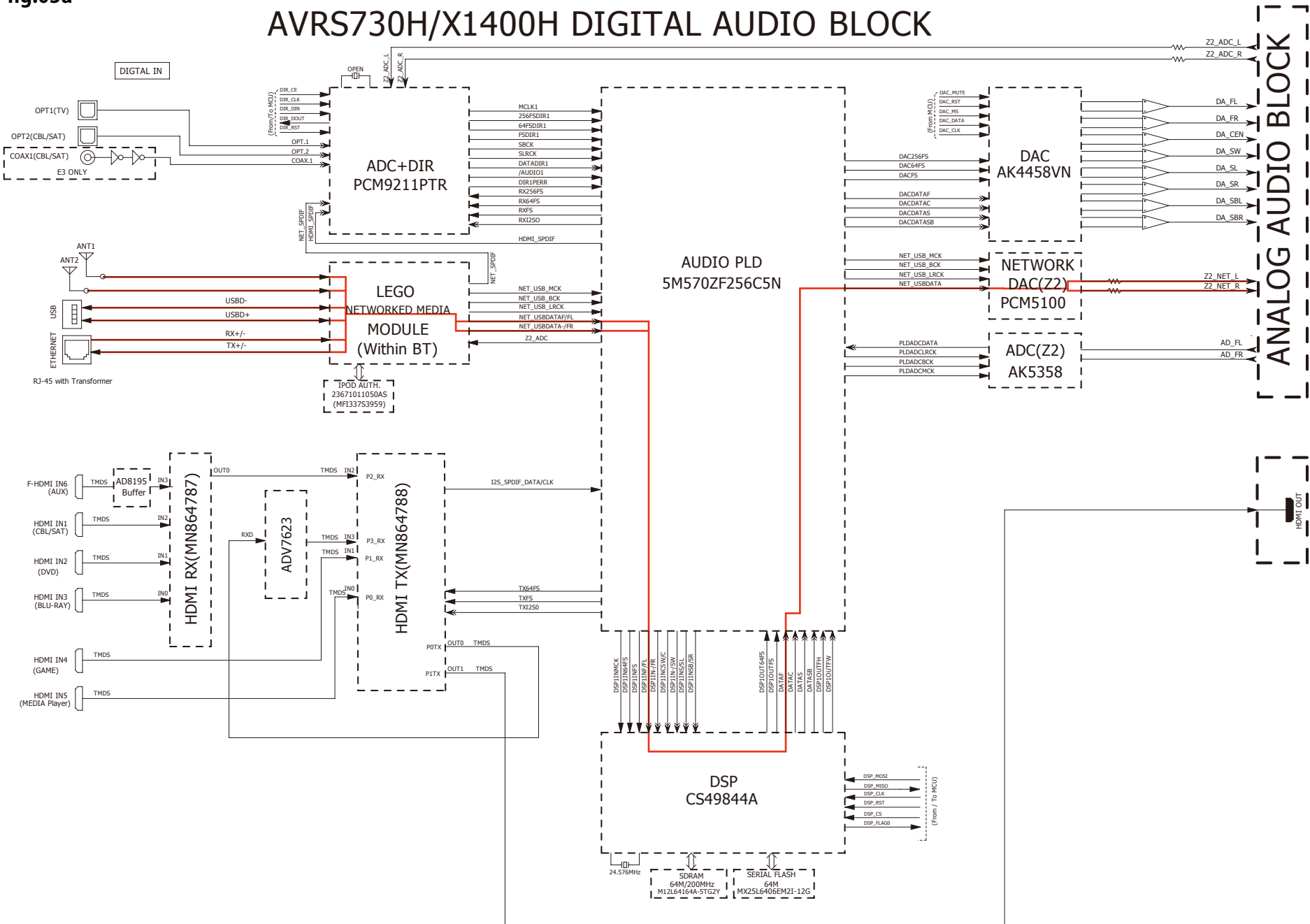

fig.03a

# AVRS730H/X1400H DIGITAL AUDIO BLOCK



Caution in servicing

Electrical

Mechanical

Repair Information

Updating

fig.03b

# AVRS730H/X1400H ANALOG AUDIO BLOCK

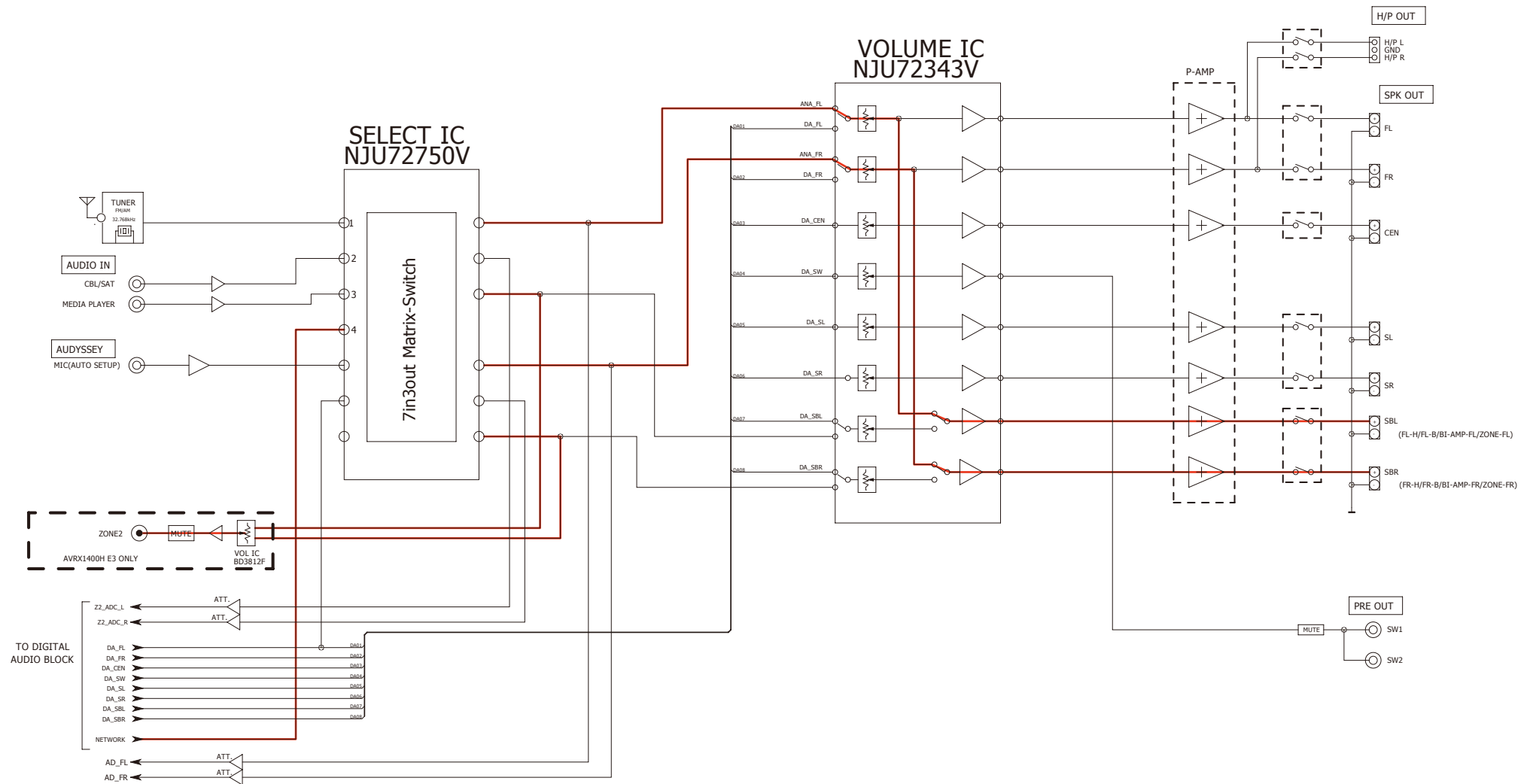

fig.04a

# AVRS730H/X1400H DIGITAL AUDIO BLOCK

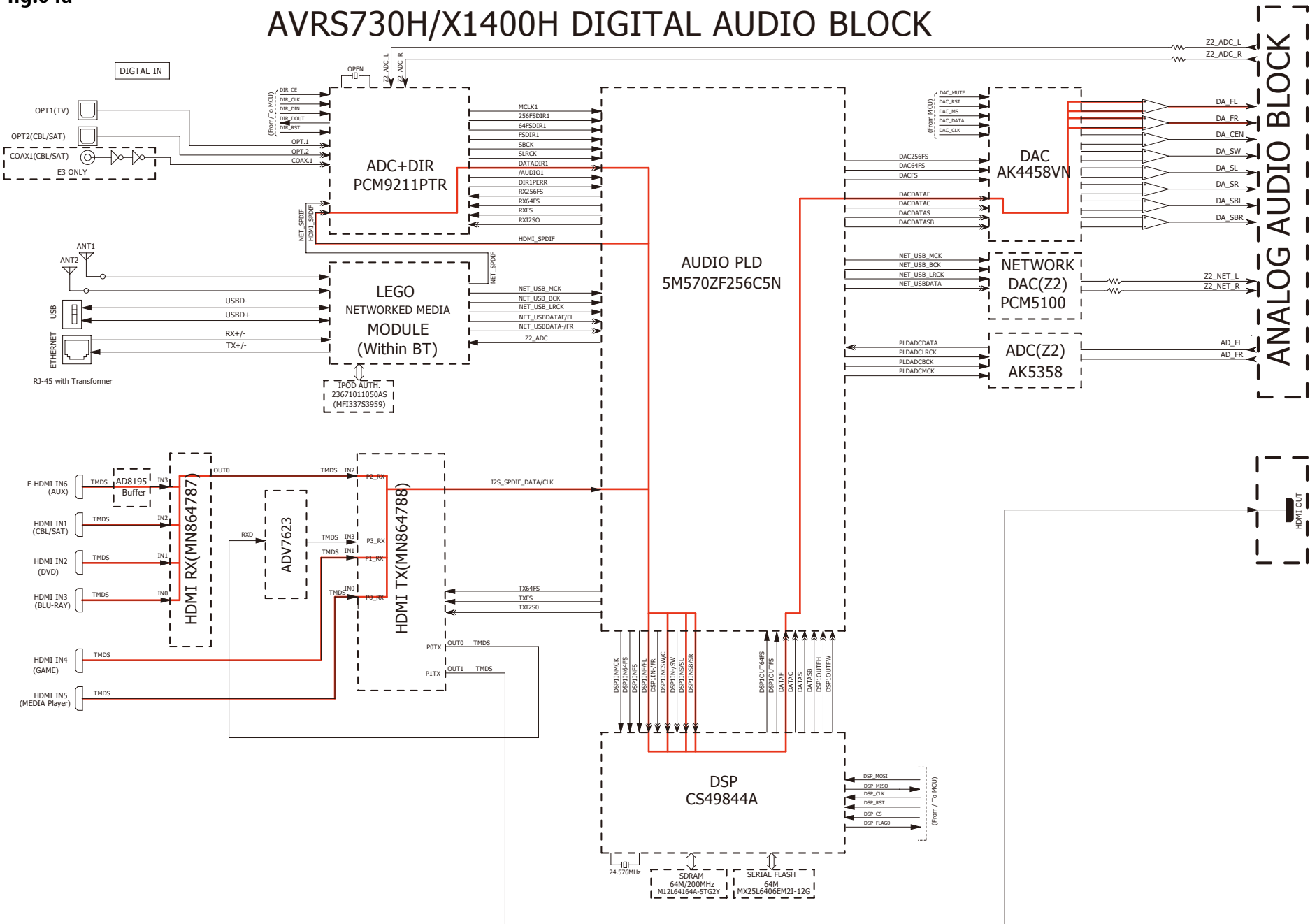

fig.04b

# AVRS730H/X1400H ANALOG AUDIO BLOCK

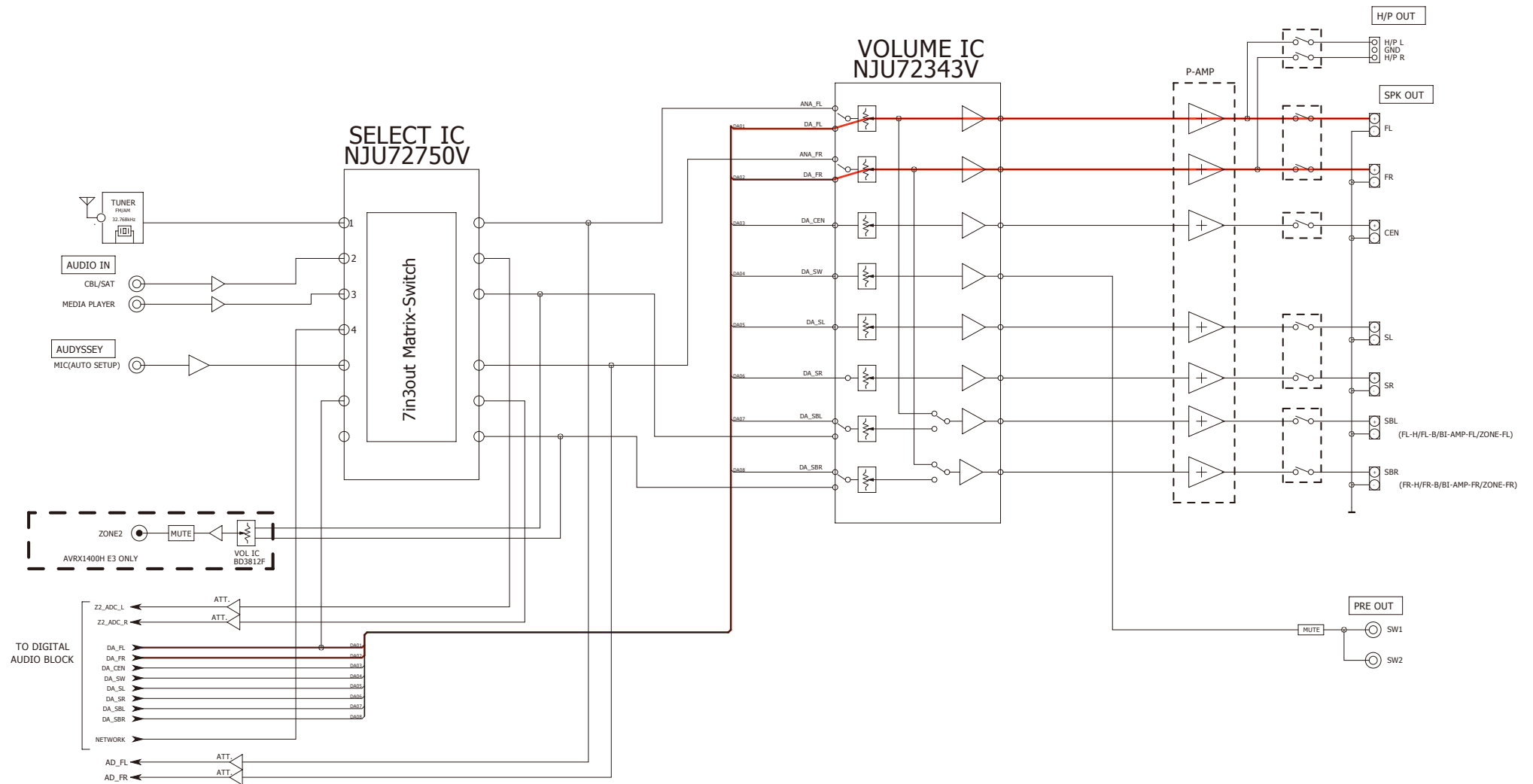

fig.05a

# AVRS730H/X1400H DIGITAL AUDIO BLOCK

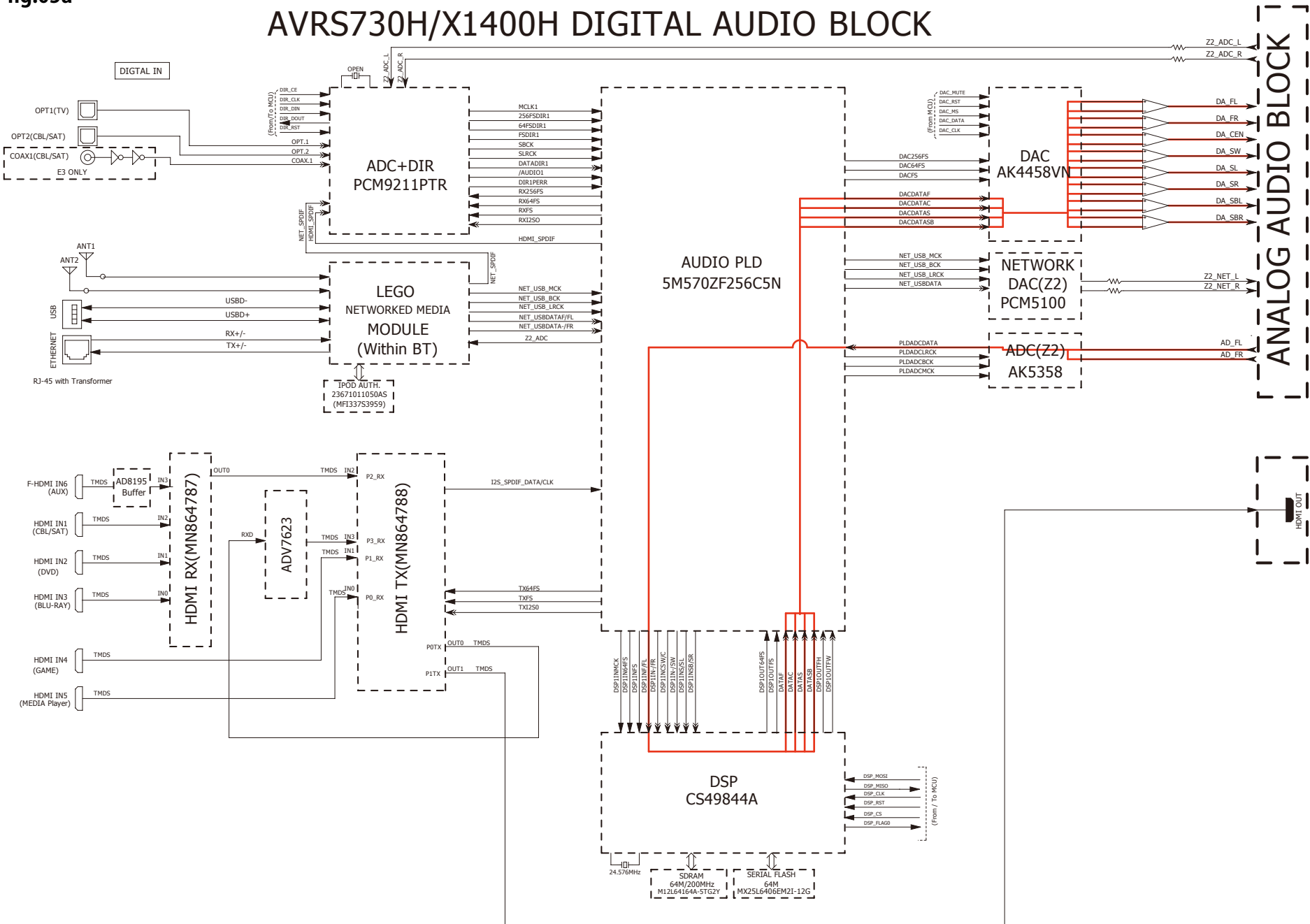

fig.05b

# AVRS730H/X1400H ANALOG AUDIO BLOCK

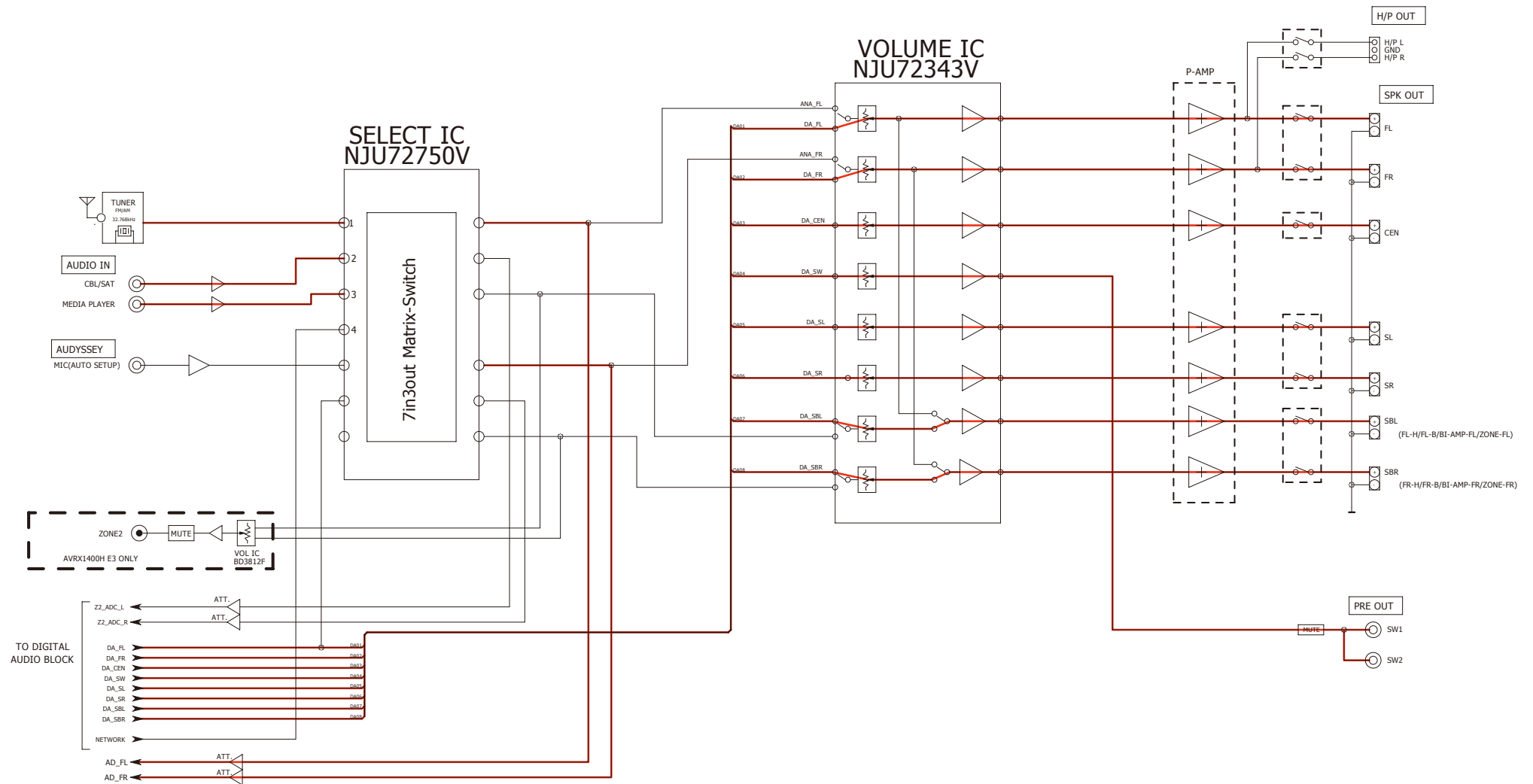
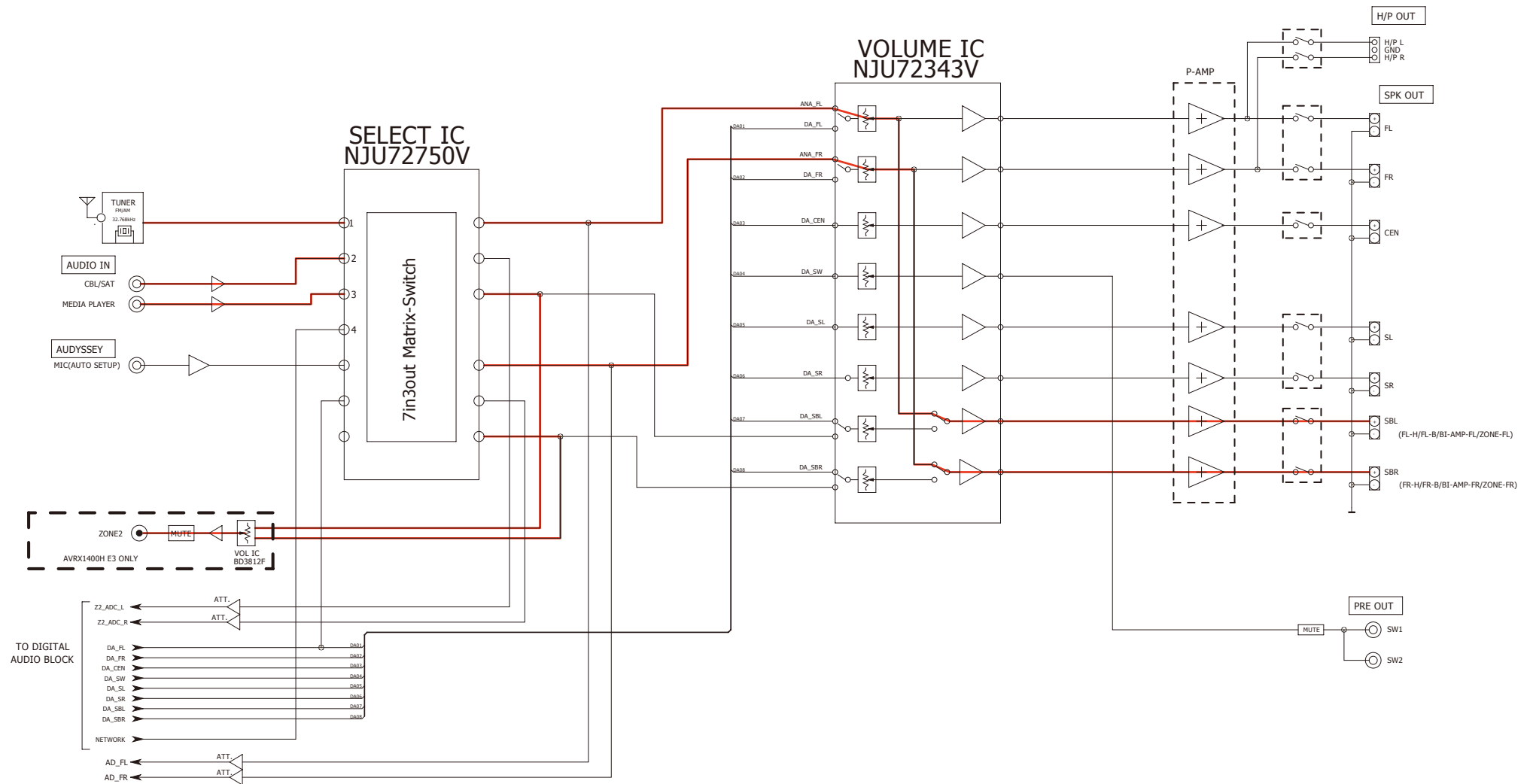

fig.06

# AVRS730H/X1400H ANALOG AUDIO BLOCK



Caution in servicing

Electrical

Mechanical

Repair Information

Updating

fig.07

# AVRS730H/X1400H VIDEO BLOCK

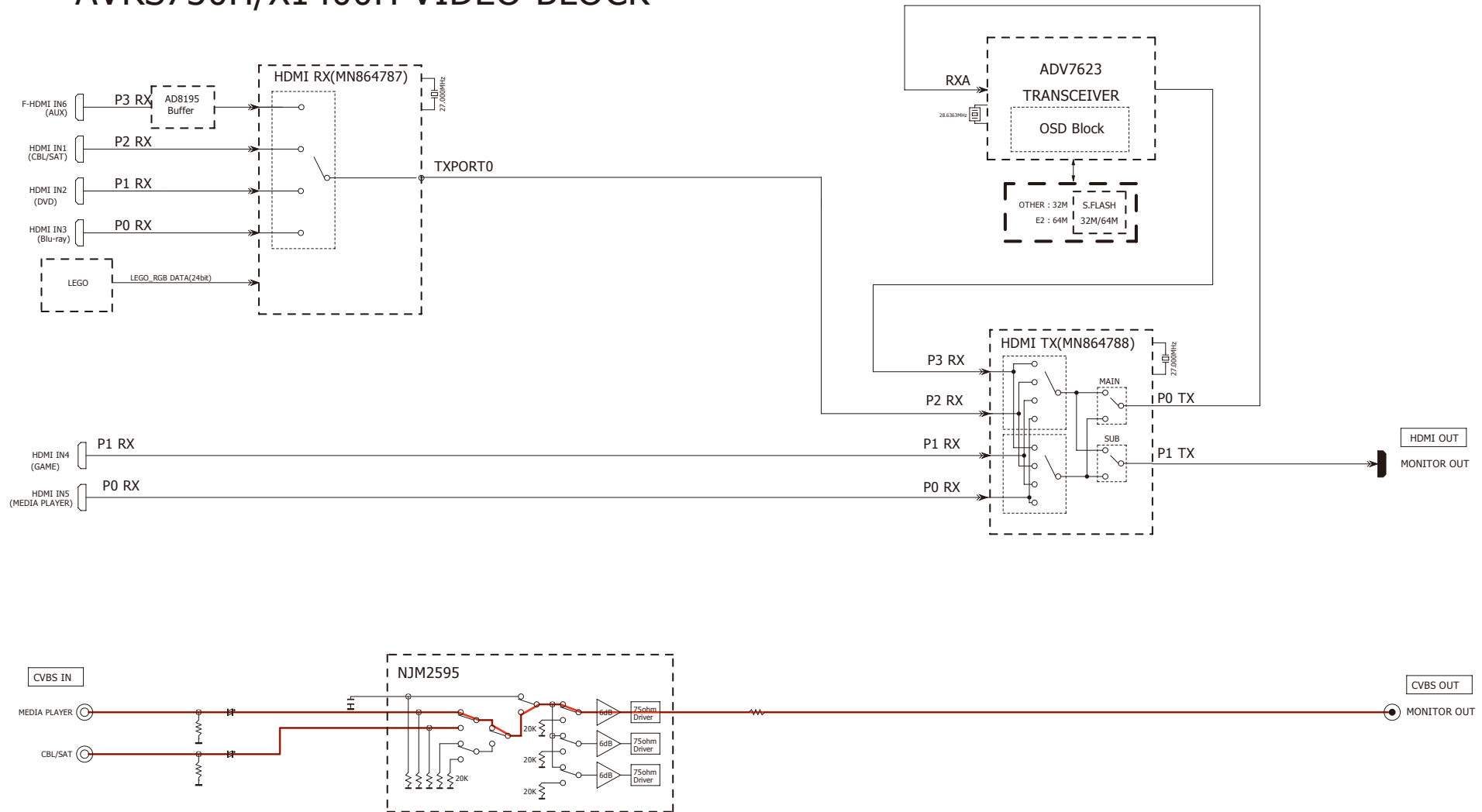

fig.08

# AVRS730H/X1400H VIDEO BLOCK

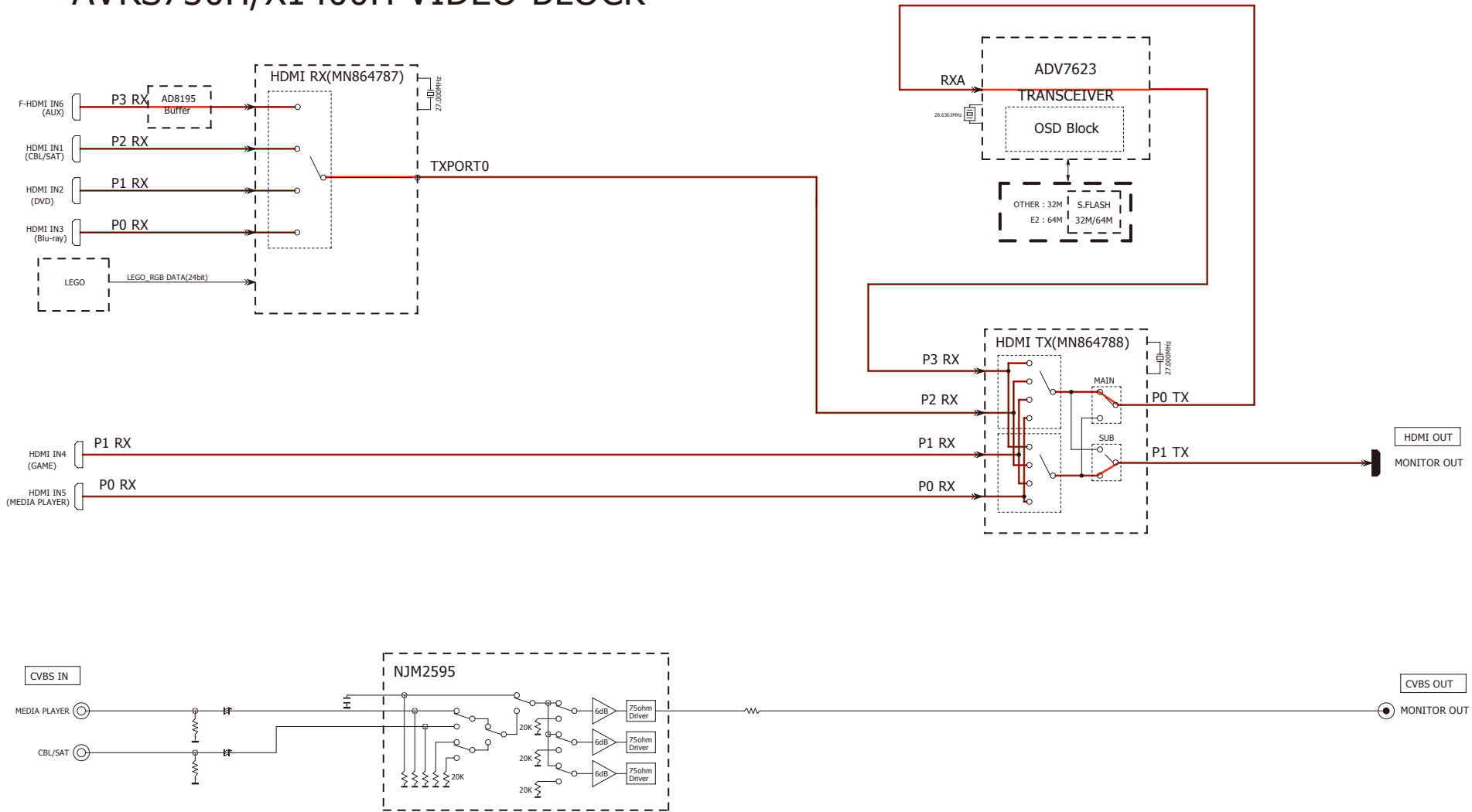

fig.09

# AVRS730H/X1400H VIDEO BLOCK

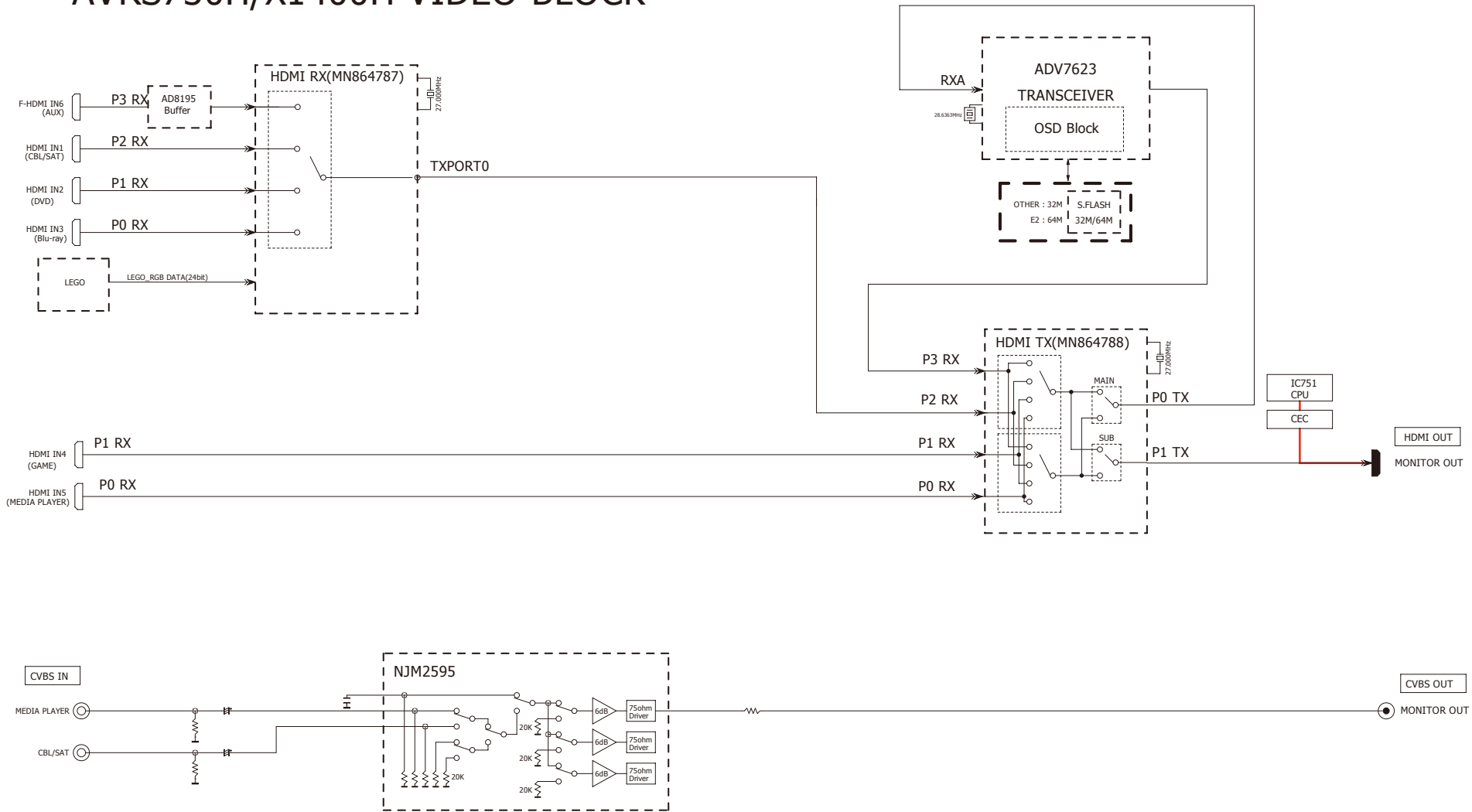
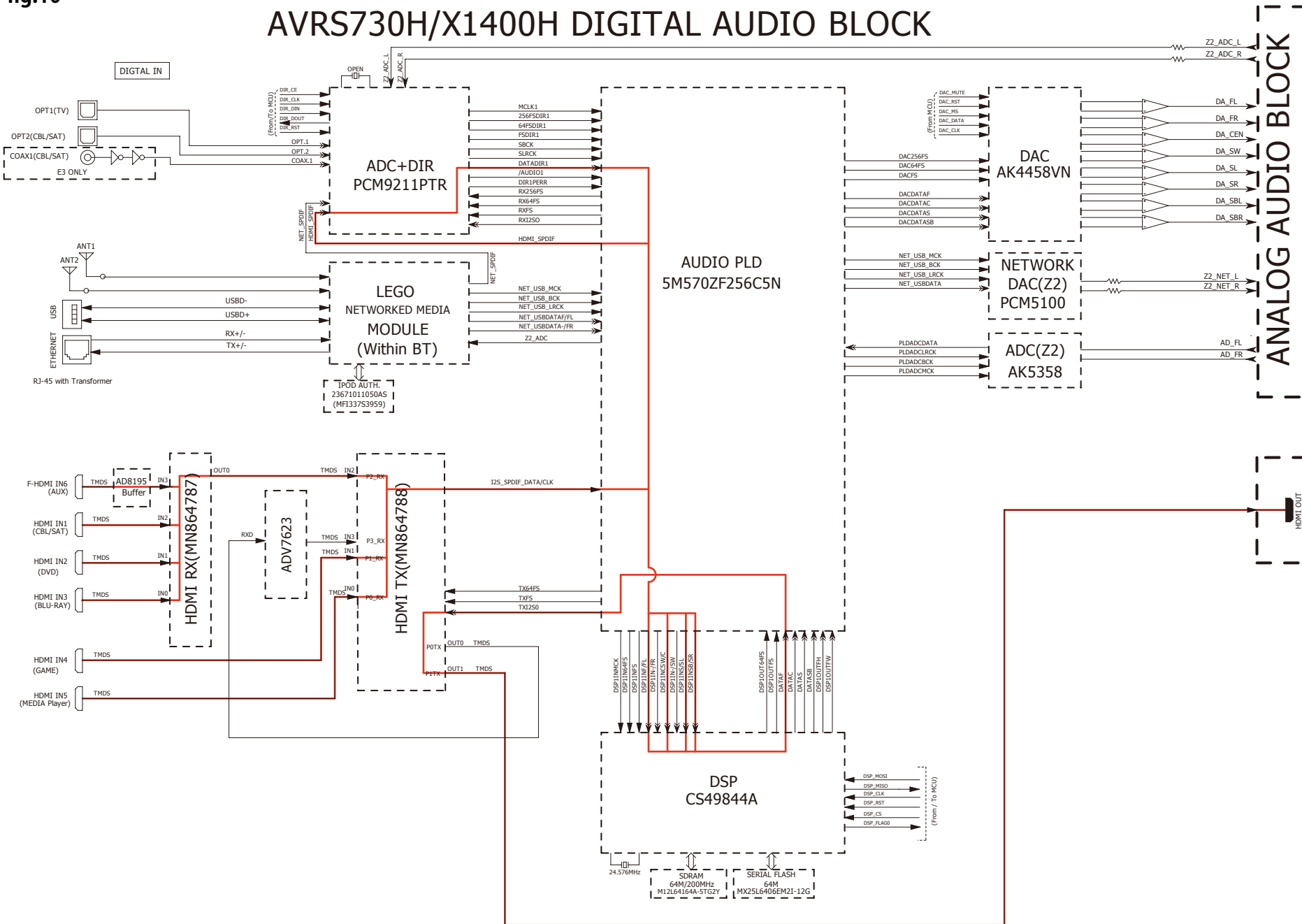

fig.10

# AVRS730H/X1400H DIGITAL AUDIO BLOCK



Caution in servicing

Electrical

Mechanical

Repair Information

Updating

fig.11

# AVRS730H/X1400H VIDEO BLOCK

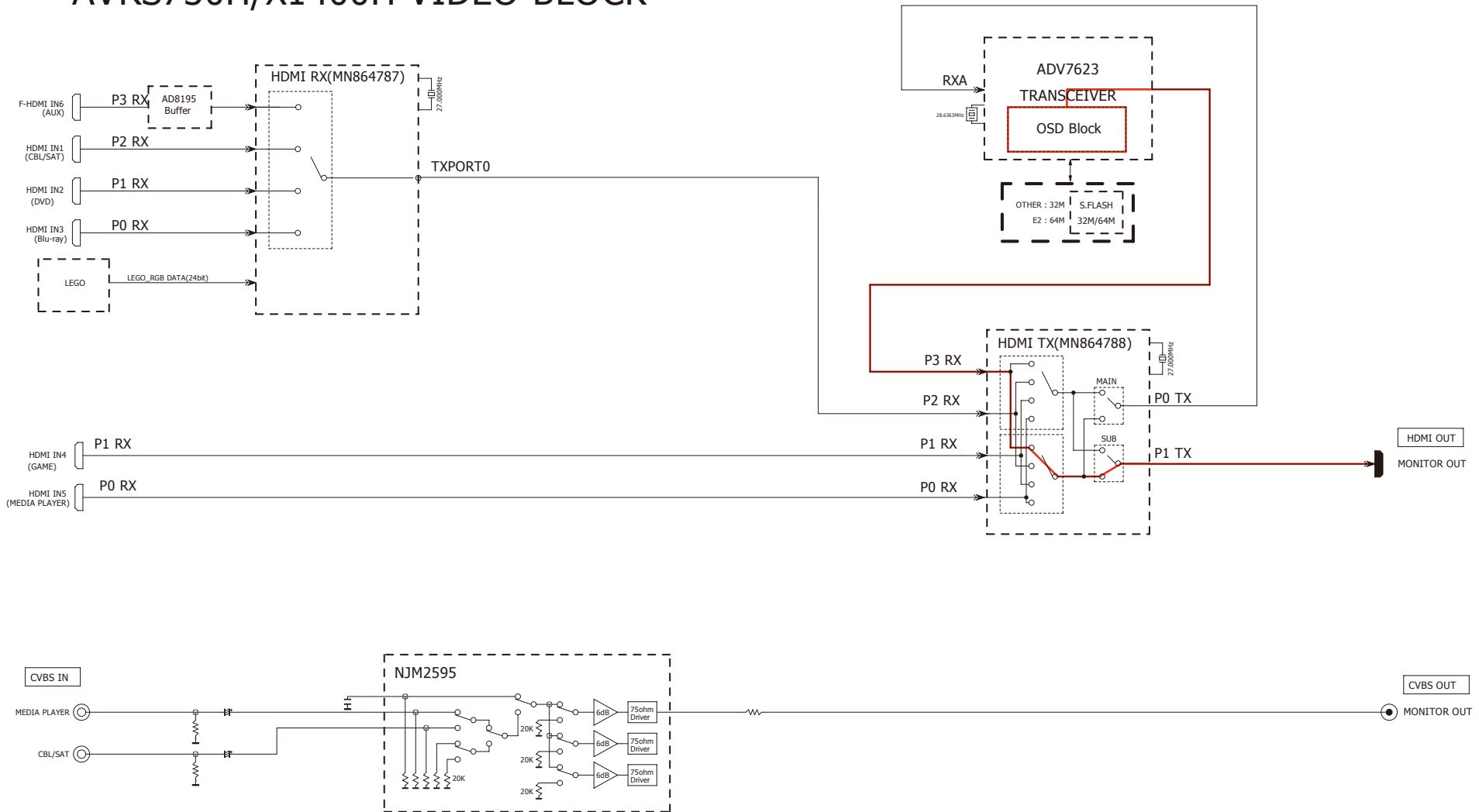

# JIG FOR SERVICING

Use the following jigs (extension cable kit) when repairing the PCBs.  
Order with your dealer for the jigs your dealer if necessary.

**CAUTION : Incorrect connections may cause malfunction.**

Connection of Jig for DIGITAL PCB

---Items to Be Prepared---

- 8U-110084S : EXTENSION UNIT KIT : 1Set
- Insulation sheet (Not supplied) : 1 sheet
- Ground lead (Not supplied) : 2 pc

-Proceeding-

(1) Remove the screws.



(2) Remove the connector PCB.

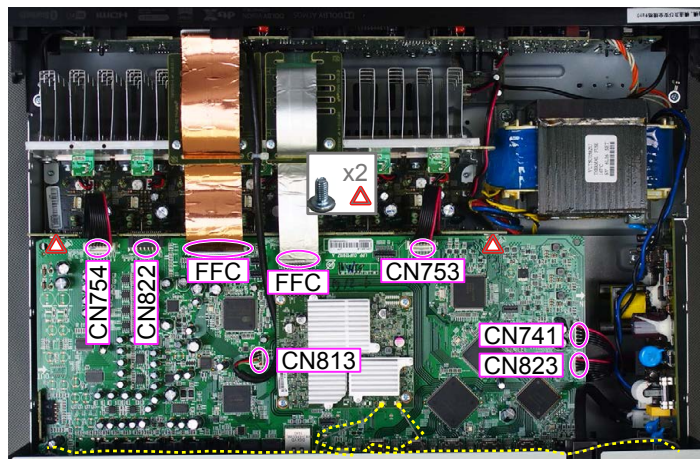

- (3) Remove the DIGITAL PCB from the chassis and turn it over.  
Place an insulation sheet larger than the PCB underneath the DIGITAL PCB.  
※ Connect the earth of the PCB to the chassis using an earth wire, etc.

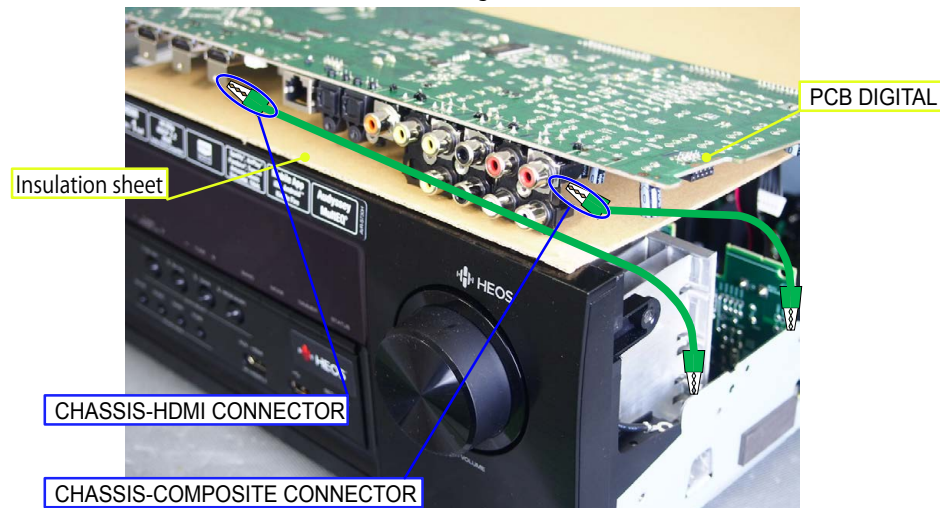

(4) Connect the expansion cables.



Board-to-Board Connections

No.	Pin	Ref. No.	PCB		Ref. No.	PCB
①	15pin	CN201	DIFF-AMP	↔	CN822	DIGITAL

# ADJUSTMENT

## Adjusting Idling Current

### 1. Preparation

- (1) Prepare a DC voltmeter.
- (2) Place the unit under normal usage conditions, away from highly ventilated areas such as next to an air conditioning machine or electric fan.  
The set requires an ambient temperature of 15°C to 30°C and standard humidity.
- (3) Settings of This Unit
  - POWER (Power source switch)      STANDBY
  - SPEAKER (Speaker terminal)      No load(Do not connect equipment such as speakers or dummy resistors.)

### 2. Adjustment Procedure

- (1) Remove the top cover and turn **VR510**( ALL Channel) of the MAIN PCB counterclockwise(⊖) as far as possible.
- (2) Connect the DC Voltmeter to the test points.

FRONT-Lch	: CN510	: VR510
FRONT-Rch	: CN550	: VR550
CENTER ch	: CN530	: VR530
SURROUND-Lch	: CN520	: VR520
SURROUND-Rch	: CN540	: VR540
SURROUND-BACK Lch	: CN560	: VR560
SURROUND-BACK Rch	: CN570	: VR570
- (3) Connect the power cord to an outlet. Next, press the power button to turn on the power.
- (4) Set this unit as follows.

MASTER VOLUME	: "----" (⊖ min.)	: turn counterclockwise to the lowest position.
SPEAKER (Speaker terminal)	: No load	

(Do not connect equipment such as speakers or dummy resistors.)

MODE	: MCH STEREO
FUNCTION	: DVD
- (5) Turn **VR510** clockwise (⊕) and adjust the voltage of the test point to "**2.0mV ± 0.5mV DC**" within 2 minutes.
- (6) Check whether the voltage is within the range "**2.0mV +2mV/-1mV DC**" 10 minutes after adjustment.
- (7) Adjust the variable resistance of each channel using the same method.

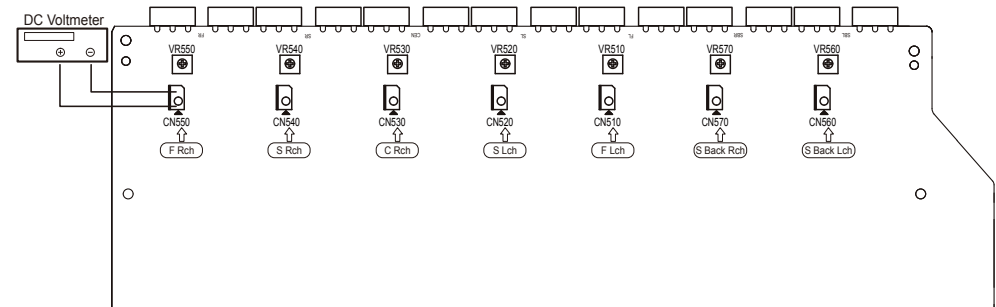
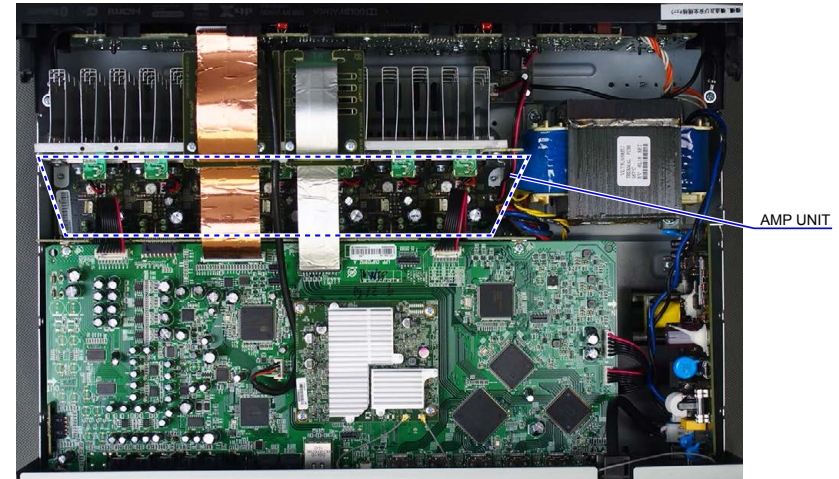

Caution in servicing

Electrical

Mechanical

Repair Information

Updating

## PROCEDURE AFTER REPLACING THE PCB.

## PROCEDURE AFTER REPLACING THE U-COM, ETC.

## FIRMWARE UPDATE PROCEDURE

1. Items necessary for update
2. Update preparation with a USB flash drive
3. Update method when the DIGITAL PCB or network module is replaced (Using a USB flash drive)
4. Update Method for Service Region Settings
5. Normal Firmware Update Method from USB Flash Drive
6. Normal Firmware Update Method from OTA
7. About the error codes

## PROCEDURE AFTER REPLACING THE PCB.

The procedure after replacing the printed circuit boards is as follows.

(1) Change the resistor for setting the region.

Model Area	DIGITAL PCB	
	R7581	R7582
North America (E3)	OPEN	0
Europe (E2)	0	OPEN
China (E1C)	10k	10k
Japan (JP)	10k	22k
AVR-S730H	18k	3.3k

See the PCB below.

(2) Be sure to replace the software with the latest version.

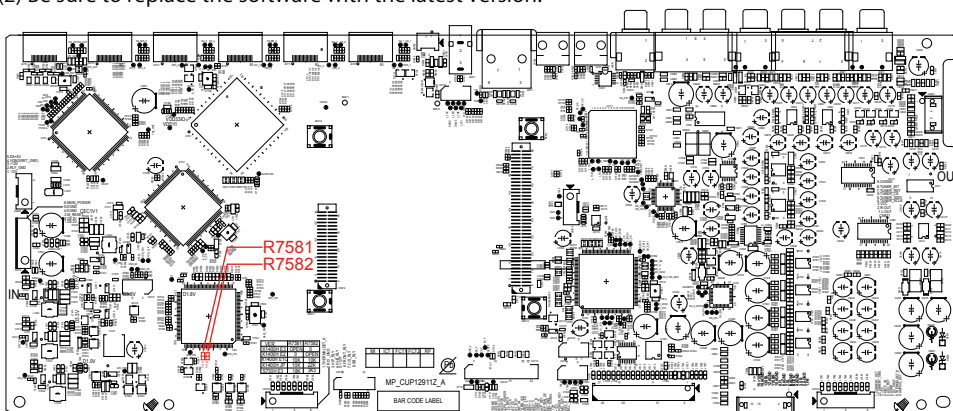

## PROCEDURE AFTER REPLACING THE U-COM, ETC.

The procedure after replacing the u-COM (microprocessor), flash ROM, etc. is as follows.

Implement the update method when the DIGITAL PCB or network module is replaced.

PCB Name	Ref. No.	Description	Procedure after Replacement	Remark
DIGITAL	IC751	R5F5631FDDFB	B	SOFTWARE : Main
DIGITAL	IC782	MX25L6406EM2I-12G	B	SOFTWARE : DSP ROM
DIGITAL	IC732	MX25L3206EM2I-12G MX25L6406EM2I-12G (E2 only)	B	SOFTWARE : GUI ROM
DIGITAL	IC771	5M570ZF256C5N	B	SOFTWARE : AUDIO PLD
MODULE	P14	NETWORK MODULE	D	SOFTWARE : Network

Procedure after Replacement

**A :** The software has been written. The software is not written at the time of replacement.

**B :** The software has been written. The software may need to be rewritten by version updates. Check the version.

**C :** The software has not been written. The software needs to be written after replacement.

See "[FIRMWARE UPDATE PROCEDURE](#)" for information on writing the software.

**D :** "The software has been written. Be sure to replace the software with the latest version.

See "[3. Update method when the DIGITAL PCB or network module is replaced \(Using a USB flash drive\)](#)" for information on writing the software.

# FIRMWARE UPDATE PROCEDURE

## 1. Items necessary for update

Items necessary for update are as follows.

Update Type	Needed Part for Update	Requirement	Offered / not Offered		
			Standard Service Equipment Not offered by D&M	Purchase from D&M Article code	Download from SDI
Via USB	USB flash drive (USB 2.0 : Min 1GB) • We recommend a USB memory device that has an LED installed.	Formatting FAT16 or FAT 32	X	-	"Table 1" or "Table 2"
Via OTA	Internet Connection by Broadband Circuit	-	X	-	-
	Modem	-	X	-	-
	Router	-	X	-	-
	Ethernet cable (CAT-5 or greater is recommended)	-	X	-	-

**Table 1**

Update download file when the DIGITAL PCB or network module is replaced

Model Name	Model Area	Download from SDI
AVR-X1400H	ALL	avr_40.prod.update.factory.xxxx.zip

**Table 2**

Update download file when the firmware is updated (Two files, "HW component" and "LEGO component")

Model Name	Model Area	Download from SDI	
		For HW component	For LEGO component
AVR-X1400HE3	North America (E3)	Product ID : 000100970100	DPMS_AVR-X1400HE3_LEGO_xxxx.zip
AVR-X1400HE2	Europe (E2)	Product ID : 000100970200	DPMS_AVR-X1400HE2_LEGO_xxxx.zip
AVR-X1400HJP	Japan (JP)	Product ID : 000100970400	DPMS_AVR-X1400HJP_LEGO_xxxx.zip
AVR-X1400HE1C	China (E1C)	Product ID : 000100970500	DPMS_AVR-X1400HE1C_LEGO_xxxx.zip
AVR-S730HE3	North America (E3)	Product ID : 000100970700	DPMS_AVR-S730HE3_LEGO_xxxx.zip

heos\_40.prod\_x.xxx.xx.zip

## 2. Update preparation with a USB flash drive

You can update the firmware by downloading the latest version with USB flash drive.

### 2.1. Connecting to the USB flash drive

(1) Preparation

- Windows PC
- USB flash drive format : Prepare a USB flash drive formatted in FAT16 or FAT32.  
※We recommend a USB flash drive that has an LED installed.

NOTE :

- Use a memory that supports USB2.0.
- Do not run the USB flash drive through a hub.
- Do not connect a computer to the USB port of this unit using a USB cable.
- Do not use an extension cable when connecting the USB flash drive.
- Save the update file on a blank USB flash drive for use.
- If a USB flash drive cannot be updated, replace it with a different USB flash drive and perform the update again.

### 2.2. Unzipping the Downloaded File

Unzip the downloaded file on your computer.

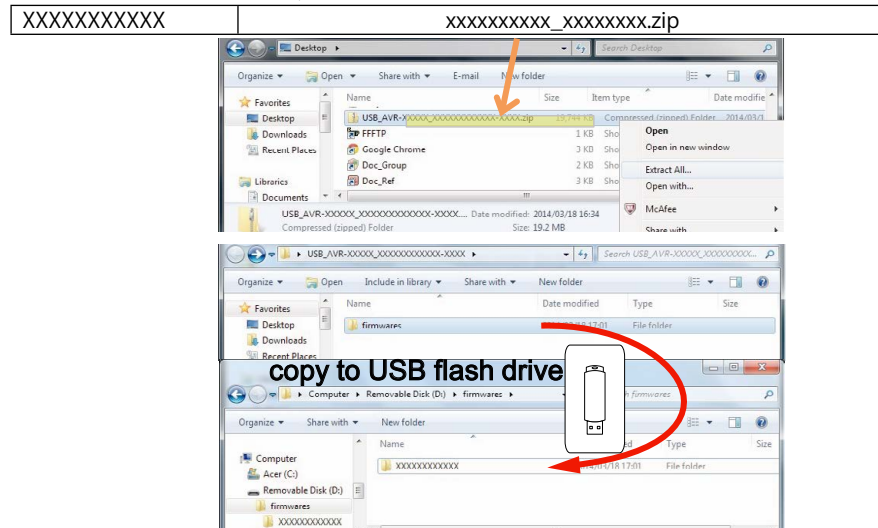

There are folders or files after unzipping.

Copy these folders or files onto the USB flash drive.

The folders or files must be placed in the root directory of the USB flash drive.

### 3. Update method when the DIGITAL PCB or network module is replaced (Using a USB flash drive)

#### 3.1. File structure on USB flash drive

DIGITAL PCB or network module is replaced onto the USB flash drive in the following structure.

After unzipping the files, store them in the root of the same USB flash drive.

Model Area	Download from SDI
ALL	avr_40.prod.update.factory.xxxx.zip

USB flash drive root

- + avr\_40.prod.update.factory
- + xxxxxxx.ota-download
- + heos\_40.prod.update.factory

xxxxxx : Model name  
zz : Region

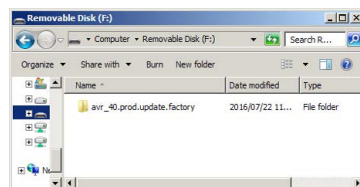

#### 3.2. Start the update.

NOTE :

- Remove the LAN cable from this unit when updating. (Do not connect to a wired or wireless network.)
- The GUI menu setting details and image quality adjustment setting details are initialized when Firmware Factory Restore is performed. Therefore, take a note of the setting details beforehand and reconfigure the settings after update.

- (1) Press the power button to turn on the power.
- (2) Wait for this unit to start up.
- (3) Set the input source to HEOS Music. Check that the display is as shown below.

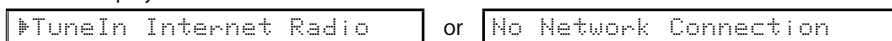

Content of the display is scrolled.

- (4) Insert the USB flash drive into the USB port.

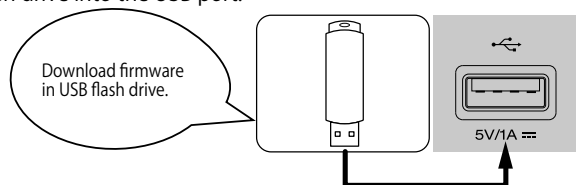

- (5) USB Update starts automatically. The Standby LED lights red.

Display during USB update

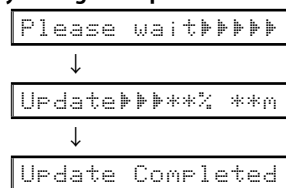

It takes a maximum of approximately 25 minutes for update to complete.

- (6) The unit restarts when update is complete.
  - ※When update is complete, the folder name on the USB flash drive changes to "avr\_40.prod.update.factory.done". To use the files again, delete the ".done" part.

- (7) Execute Firmware Factory Restore.

**AVR-X1400H**

- ⚠ While holding down buttons "TUNER PRESET CH-" and "DIMMER" simultaneously, press the power button to turn on the power.

**AVR-S730H**

- While holding down buttons "BAND" and "MODE" simultaneously, press the power button to turn on the power.

Display during Firmware Factory Restore

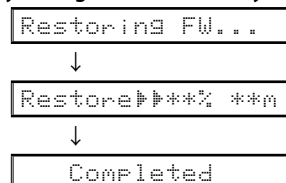

It takes approximately 15 minutes for Firmware Factory Restore to complete.

- (8) Execute Service Region Settings. See "4. Update Method for Service Region Settings"
- (9) Check that the version is the specified version. See "1. Version Display Mode"
- (10) If necessary, use OTA or the USB flash drive to update the firmware to the newest version.
  - ※We recommend using the firmware update method using OTA. See "5. Normal Firmware Update Method from USB Flash Drive" or "6. Normal Firmware Update Method from OTA"

#### ---Cautions on Firmware Update---

- Do not remove the USB flash drive until updating is completed.
- Do not turn off the power until updating is completed.
- It takes a maximum of approximately 25 minutes for update to complete. Once an update is started, normal operations cannot be performed until it is completed.

## 4. Update Method for Service Region Settings

Copy the Service Region Settings from the USB flash drive to this unit.

### 4.1. Creating a Service Region Settings file

(1) Click [Start button] - [Accessories] - [notepad] on the PC to launch the notepad.

(2) Enter "TEXT".

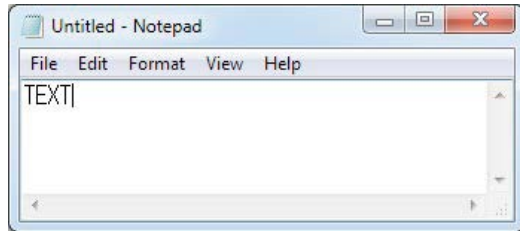

(3) Click "File", and then click "Save As...".

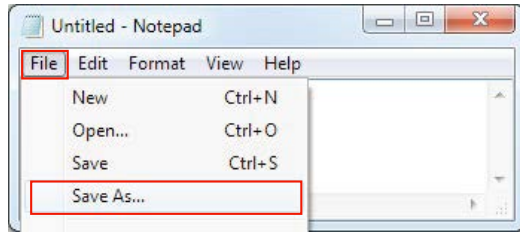

(4) Enter the file name and click the Save button.

NOTE : Enter the file name in double quotation marks. (The file extension is not required.)

Service Region	File name
North America	"denon-config-locale-set-1"
Europe	"denon-config-locale-set-2"
Japan	"denon-config-locale-set-3"
Australia	"denon-config-locale-set-4"
Korea	"denon-config-locale-set-5"
China	"denon-config-locale-set-6"
Israel	"denon-config-locale-set-7"

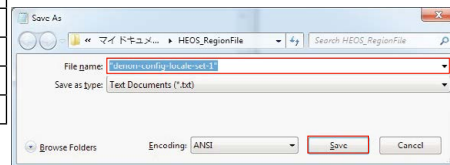

(5) Copy the files created on the USB flash drive.

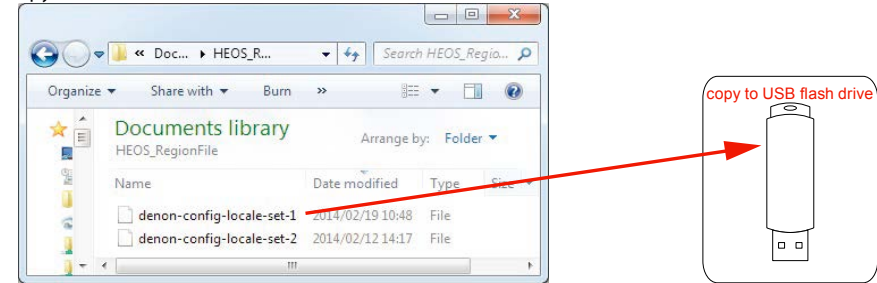

### 4.2. Starting Service Region Settings

NOTE :

- Remove the LAN cable from this unit when updating. (Do not connect to a wired or wireless network.)
- We recommend a USB memory device that has an LED installed.

(1) Press the power button to turn on the power.

(2) Wait for this unit to start up.

(3) Set the input source to HEOS Music.

Check that the display is as shown below.

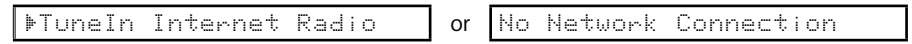

Content of the display is scrolled.

(4) Insert the USB flash drive into the USB port.

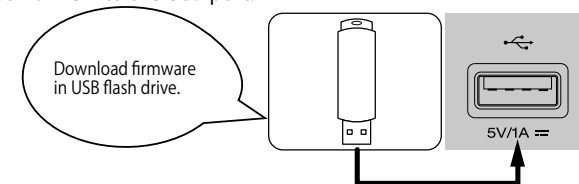

(5) Wait for at least 10 seconds before removing the USB flash drive.

(If the USB flash drive has an LED, this LED will be flashing. Remove the USB flash drive when the LED

stops flashing.)

## 5. Normal Firmware Update Method from USB Flash Drive

### 5.1. File structure on USB flash drive

Copy the normal update files onto the USB flash drive in the following structure.

After unzipping the HW component USB update files for the target model and LEGO USB update files, store them in the root of the same USB flash drive.

Model Area	Download from SDI	
	For HW component	For LEGO component
North America (E3)	DPMS_AVR-X1400HE3_LEGO_XXXX.zip Product ID : 000100970100	heos_40.prod_x.xxx.xx.zip
Europe (E2)	DPMS_AVR-X1400HE2_LEGO_XXXX.zip Product ID : 000100970200	
Japan (JP)	DPMS_AVR-X1400HJP_LEGO_XXXX.zip Product ID : 000100970400	
China (E1C)	DPMS_AVR-X1400HE1C_LEGO_XXXX.zip Product ID : 000100970500	
North America (E3)	DPMS_AVR-S730HE3_LEGO_XXXX.zip Product ID : 000100970700	

USB flash drive root

- + AVR-X1400Hxx\_XXXX.update.auto
- + heos\_40.prod.update.x-xxx-xx

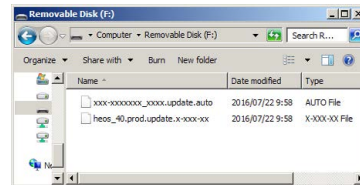

### 5.2. Start normal update

NOTE :

- Remove the LAN cable from this unit when updating.  
(Do not connect to a wired or wireless network.)

(1) Press the power button to turn on the power.

(2) Wait for this unit to start up.

(3) Set the input source to HEOS Music.

Check that the display is as shown below.

TuneIn Internet Radio or No Network Connection

Content of the display is scrolled.

(4) Insert the USB flash drive into the USB port.

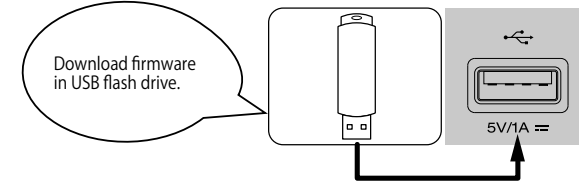

(5) USB Update starts automatically.

The Standby LED lights red.

**Display during USB update**

Please wait▶▶▶▶▶▶



Update▶▶▶▶▶▶% \*\*m



Update Completed

It takes a maximum of approximately 25 minutes for update to complete.

(6) The unit restarts when update is complete.

(7) After updating the firmware, check the version.

See "1. Version Display Mode"

#### ---Cautions on Firmware Update---

- Do not remove the USB flash drive until updating is completed.
  - Do not turn off the power until updating is completed.
  - It takes a maximum of approximately 25 minutes for update to complete.
- Once an update is started, normal operations cannot be performed until it is completed. The GUI menu settings and image adjustment settings of this unit may be initialized. Note down the settings before updating, and set them again after updating.

## 6. Normal Firmware Update Method from OTA

Download the latest firmware from our website and update the firmware.

### 6.1. Network Connection

#### (1) System Requirements

- Internet Connection by Broadband Circuit
- Modem
- Router
- Ethernet cable (CAT-5 or greater is recommended)

#### (2) Setting

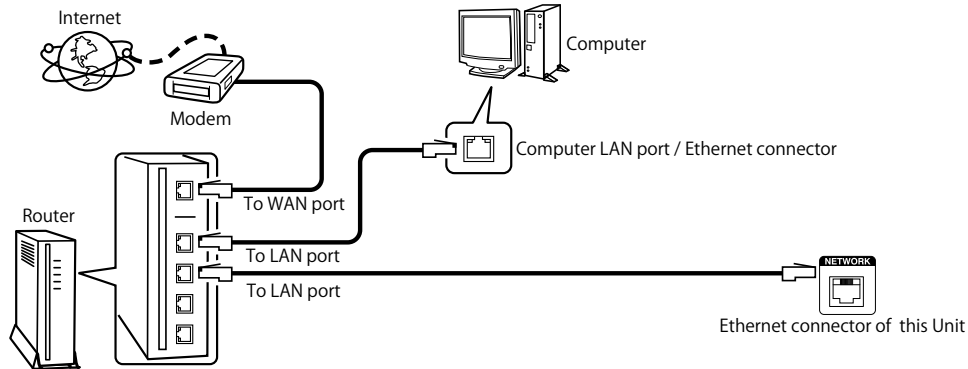

### 6.2. Check and update the firmware

Check if there is a firmware update available. It is also possible to check approximately how long the update will take.

(1) Press the "SETUP" button on the remote control to display the GUI menu.

(2) Press the cursor button to select "General" → "Firmware" → "Update" → "Check for Update".

(3) Check update

- If the firmware version is anything other than the latest version, select "Update Now" to update the firmware.
- "No update required. Latest version installed." is displayed when the firmware version is up to date.

(4) OTA Update starts automatically.  
The Standby LED lights red.

#### Display during OTA update

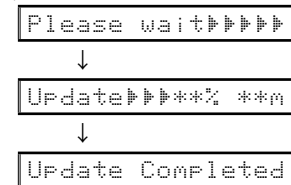

It takes a maximum of approximately 25 minutes for update to complete.

(5) The unit restarts when update is complete.

(6) After updating the firmware, check the version.  
See "1. Version Display Mode"

#### ---Cautions on Firmware Update---

- For the update procedure, a proper broadband Internet connection environment and settings are required.
  - Do not turn off the power until updating is completed.
  - It takes a maximum of approximately 25 minutes for update to complete.
- Once an update is started, normal operations cannot be performed until it is completed. The GUI menu settings and image adjustment settings of this unit may be initialized. Note down the settings before updating, and set them again after updating.

## 7. About the error codes

See the table below for details on error codes and solutions when updating the firmware. Error codes are displayed in 4 digits, **YYXX**(YY : DeviceID, XX : Error Code).

Update▶▶▶▶\*\*% \*\*n



Update Error**YYXX** Update Error**YYXX** (YY : DeviceID, XX : Error Code)

↓ ↑ The display is alternately displayed.

Please check you

**Content of the display is scrolled.**

### Remedies

Error Code (YYXX) (DeviceID/Error Code)	Remedies
000A	"Connection failed. Please check your network, then try again."
0009	"Update failed. Please check your network, then try again."
0009	"Upgrade failed. Please check your network, then try again."
YY00 YY01 YY02 YY03 YY04 YY07	"Please check your network, unplug and reconnect the power cord, and try again."
YY00 YY01 YY02 YY03 YY04 YY07	"Please unplug and reconnect the power cord, and try again."
0005	"Incompatible update file found on the USB device. Please check the file."
0006	"Update file is corrupted. Please check the file."
000B	"Please contact customer service in your area." ※ Check the power supply and communication lines of each device.

### Device ID table

Device ID (YY)	Device Name
00	General
01	Main CPU
0E	Main FBL (No used)
11	DSP1 or DSP
12	DSP2 ※ Except : AVR-S730H/S930H/X1400H/X2400H/X3400H
13	DSP3 ※ Except : AVR-S730H/S930H/X1400H/X2400H/X3400H
19	DSP4 ※ Except : AVR-S730H/S930H/X1400H/X2400H/X3400H
15	Audio PLD
22	Video PLD ※ Except : AVR-S730H/S930H/X1400H/X2400H
2A	GUI
33	LEGO

### Error Code table

Type code (XX)	Description
00	Logical error
01	Error during erasing
02	Error during writing
03	Error during verifying
04	No access for the component
05	Package mismatched. Product ID, package version un-matched of the package manifest
06	Unpack dis-available of component package file
07	Time out
08	Latest firmware has already installed.
09	Error during download
0A	Error connection
0E	Hardware Error

### ---Checking the Firmware Version After the Update---

After updating the firmware, check the version.

See "1. Version Display Mode"

**DENON**<sup>®</sup>  
[www.denon.com](http://www.denon.com)